

DVD Home Theatre System

Operating Instructions

Owner's Record

The model and serial numbers are located on the rear of the unit. Record the serial number in the space provided below. Refer to them whenever you call upon your Sony dealer regarding this product.

Model No. _____ Serial No. _____

***HT-9900M
HT-6900DP
HT-5950DP***

WARNING

To prevent fire or shock hazard, do not expose the unit to rain or moisture.

To prevent fire, do not cover the ventilation of the apparatus with newspapers, table-cloths, curtains, etc. And don't place lighted candles on the apparatus.

To prevent fire or shock hazard, do not place objects filled with liquids, such as vases, on the apparatus.

Do not install the appliance in a confined space, such as a bookcase or built-in cabinet.



Don't throw away batteries with general house waste; dispose of them correctly as chemical waste.

For customers in the United States



This symbol is intended to alert the user to the presence of uninsulated "dangerous voltage" within the product's enclosure that may be of sufficient magnitude to constitute a risk of electric shock to persons.



This symbol is intended to alert the user to the presence of important operating and maintenance (servicing) instructions in the literature accompanying the appliance.

WARNING

This equipment has been tested and found to comply with the limits for a Class B digital device, pursuant to Part 15 of the FCC Rules. These limits are designed to provide reasonable protection against harmful interference in a residential installation. This equipment generates, uses, and can radiate radio frequency energy and, if not installed and used in accordance with the instructions, may cause harmful interference to radio communications. However, there is no guarantee that interference will not occur in a particular installation. If this equipment does cause harmful interference to radio or television reception, which can be determined by turning the equipment off and on, the user is encouraged to try to correct the interference by one or more of the following measures:

- Reorient or relocate the receiving antenna.
- Increase the separation between the equipment and receiver.
- Connect the equipment into an outlet on a circuit different from that to which the receiver is connected.
- Consult the dealer or an experienced radio/TV technician for help.

CAUTION

You are cautioned that any changes or modification not expressly approved in this manual could void your authority to operate this equipment.

Note to CATV system installer:

This reminder is provided to call CATV system installer's attention to Article 820-40 of the NEC that provides guidelines for proper grounding and, in particular, specifies that the cable ground shall be connected to the grounding system of the building, as close to the point of cable entry as practical.

For customers in Canada

CAUTION

TO PREVENT ELECTRIC SHOCK, MATCH WIDE BLADE OF PLUG TO WIDE SLOT, FULLY INSERT.



ENERGY STAR[®] is a U.S. registered mark. As an ENERGY STAR[®] partner, Sony Corporation has determined that this product meets the ENERGY STAR[®] guidelines for energy efficiency.

About This Manual

- The instructions in this manual are for model HT-9900M, HT-6900DP and HT-5950DP. Check your receiver's model number by looking at the lower right corner of the front panel. In this manual, HT-9900M is used for illustration purposes unless stated otherwise. Any difference in operation is clearly indicated in the text, for example, "HT-9900M only"
- The instructions in this manual describe the controls on the receiver. You can also use the controls on the supplied remote if they have the same or similar names as those on the receiver. For details on the use of your remote, see pages 43–51. For details on the use of your DVD player, refer to the separate operating instructions supplied with the DVD player.

The HT-9900M consists of:

- Receiver STR-K9900P
- Speaker system
 - Front speaker (left) SS-MSP69L
 - Front speaker (right) SS-MSP69R
 - Center speaker SS-CNP69
 - Surround speaker (left) SS-MSP69SL
 - Surround speaker (right) SS-MSP69SR
 - Surround back speaker SS-MSP69SB
 - Sub woofer SA-WMSP69
- DVD player DVP-CX985V

The HT-6900DP consists of:

- Receiver STR-K9900P
- Speaker system
 - Front speaker (left) SS-MSP69L
 - Front speaker (right) SS-MSP69R
 - Center speaker SS-CNP69
 - Surround speaker (left) SS-MSP69SL
 - Surround speaker (right) SS-MSP69SR
 - Surround back speaker SS-MSP69SB
 - Sub woofer SA-WMSP69
- DVD player DVP-NC60P

The HT-5950DP consists of:

- Receiver STR-K5900P
- Speaker system
 - Front speaker (left) SS-MSP67L
 - Front speaker (right) SS-MSP67R
 - Center speaker SS-CNP67
 - Surround speaker (left) SS-MSP67SL
 - Surround speaker (right) SS-MSP67SR
 - Surround back speaker SS-MSP67SB
 - Sub woofer SA-WMSP87
- DVD player DVP-NC60P

About area codes

The area code of the receiver you purchased is shown on the lower portion of the rear panel (see the illustration below).

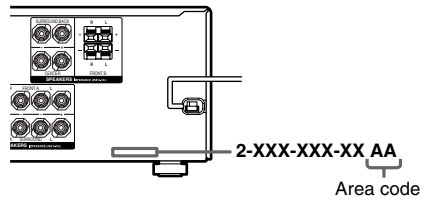

Any differences in operation, according to the area code, are clearly indicated in the text, for example, "Models of area code AA only".

This receiver incorporates Dolby* Digital and Pro Logic Surround and the DTS** Digital Surround System.

* Manufactured under license from Dolby Laboratories.

"Dolby", "Pro Logic" and the double-D symbol are trademarks of Dolby Laboratories.

** "DTS", "DTS-ES", "Neo:6" and "DTS 96/24" are trademarks of Digital Theater Systems, Inc.

Note for the supplied remote

For RM-AAP001

The AUX, MULTI CH* and 12 buttons on the remote are not available for receiver operation.

* HT-5950DP only.

Table of Contents

Getting Started

1: Check how to hookup your components	5
1a: Connecting components with digital audio output jacks	7
1b: Connecting components with multi channel output jacks.....	10
1c: Connecting components with only analog audio jacks	12
2: Connecting the antennas	14
3: Connecting speakers	15
4: Connecting the AC power cord	17
5: Setting up the speakers	19
6: Setting up the sub woofer	21
7: Adjusting the speaker levels and balance	22
— TEST TONE	

Amplifier Operation

Selecting the component	23
Listening to multi channel sound	24
— MULTI CH IN	
Listening to FM/AM radio	24
Presetting radio stations	25
Changing the display	26
About the indications in the display	27

Enjoying Surround Sound

Using only the front speakers and sub woofer	29
— 2CH STEREO	
Enjoying higher fidelity sound.....	29
— AUTO FORMAT DIRECT	
Selecting a sound field	31
Selecting the surround back decoding mode	33
— SURR BACK DECODING	

Advanced Adjustments and Settings

Assigning the component video input.....	35
— COMPONENT VIDEO INPUT ASSIGN	
Switching the audio input mode for digital components	35
— INPUT MODE	
Customizing sound fields	36
Adjusting the tone.....	37
Advanced settings.....	38

Other Operations

Naming preset stations and inputs	40
Using the Sleep Timer	40
Selecting the speaker system	41
Recording	41

Operations Using the Remote RM-AAP001

Before you use your remote.....	43
Remote button description.....	43
Selecting the command mode of the remote.....	47
Programming the remote	48

Additional Information

Precautions	52
Troubleshooting.....	53
Specifications	55
List of button locations and reference pages.....	59
Index	back cover

1: Check how to hookup your components

Steps 1a through 1c beginning on page 7 describe how to hook up your components to this receiver. Before you begin, refer to “Connectable components” below for the pages which describe how to connect each component.

After hooking up all your components, proceed to “2: Connecting the antennas” (page 14).

Connectable components

Component to be connected	Page
DVD player	
With digital audio output ^{a)}	7–8
With multi channel audio output ^{b)}	10–11
With analog audio output only ^{c)}	7–8
TV monitor	
With component video input ^{d)}	8 or 11
With composite video input only	13
Satellite tuner	
With digital audio output ^{a)}	7–8
With analog audio output only ^{c)}	7–8
Super Audio CD/CD player	
With digital audio output ^{a)}	9
With multi channel audio output ^{b)}	10
With analog audio output only ^{c)}	12
MD/Tape deck	
With analog audio output only ^{c)}	12
Multi channel decoder	10
VCR, camcorder, video game, etc.	13

a) Model with a DIGITAL OPTICAL OUTPUT or DIGITAL COAXIAL OUTPUT jack, etc.

b) (HT-9900M and HT-6900DP only) Model with a MULTI CH OUTPUT jacks, etc. This connection is used to output the audio decoded by the component’s internal multi channel decoder through this receiver.

c) Model equipped only with AUDIO OUT L/R jacks, etc.

d) Model with component video (Y, P_B/C_B/B-Y, P_R/C_R/R-Y) input jacks.

Required cords

The hookup diagrams on the subsequent pages assume the use of the following optional connection cords (**A** to **G**) (not supplied unless indicated).

A Audio cord

White (L)
Red (R)



B Audio/video cord

Yellow (video)
White (L/audio)
Red (R/audio)



C Video cord

Yellow



D Optical digital cord



E Coaxial digital cord (supplied)

Orange



F Monaural audio cord

Black



Tip

Audio cord **A** can be torn into two monaural audio cords **F**.

G Component video cord

Green
Blue
Red



Notes

- Turn off the power to all components before making any connections.
- Be sure to make connections firmly to avoid hum and noise.
- When connecting an audio/video cord, be sure to match the color-coded pins to the appropriate jacks on the components: yellow (video) to yellow; white (left, audio) to white; and red (right, audio) to red.
- When connecting optical digital cords, insert the cord plugs straight in until they click into place.
- Do not bend or tie optical digital cords.

1a: Connecting components with digital audio output jacks

Hooking up a DVD player, TV monitor or satellite tuner

For details on the required cords (A–G), see page 6.

1 Connect the audio jacks.

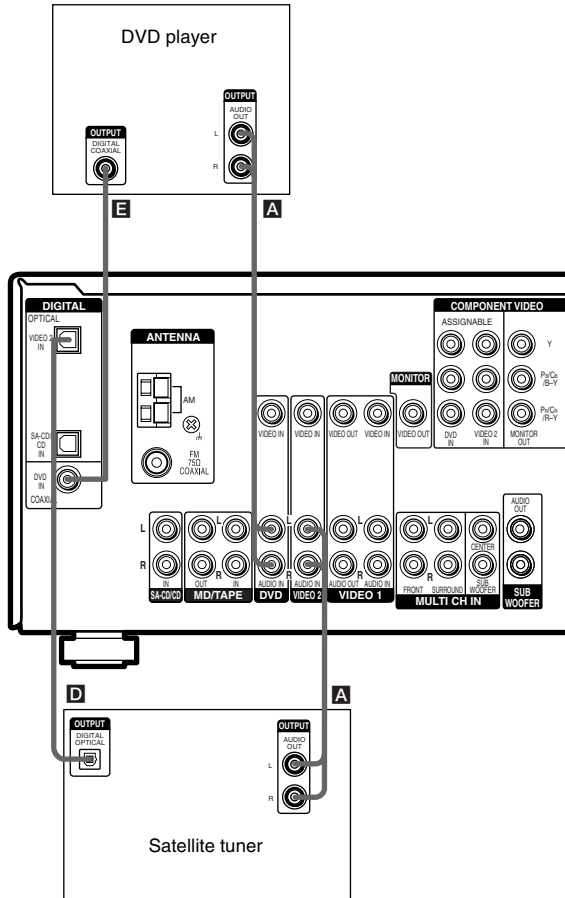

Note

You can also listen to the sound of your TV by connecting your TV's audio output jacks to the VIDEO 2 AUDIO IN jacks on the receiver. In this case, do not connect the TV's video output jack to the VIDEO 2 VIDEO IN jack on the receiver.

continued

2 Connect the video jacks.

The following illustration shows how to connect a TV or satellite tuner and a DVD player with COMPONENT VIDEO (Y, P_B/C_B/B-Y, P_R/C_R/R-Y) output jacks. Connecting a TV with component video input jacks allows you to enjoy higher quality video.

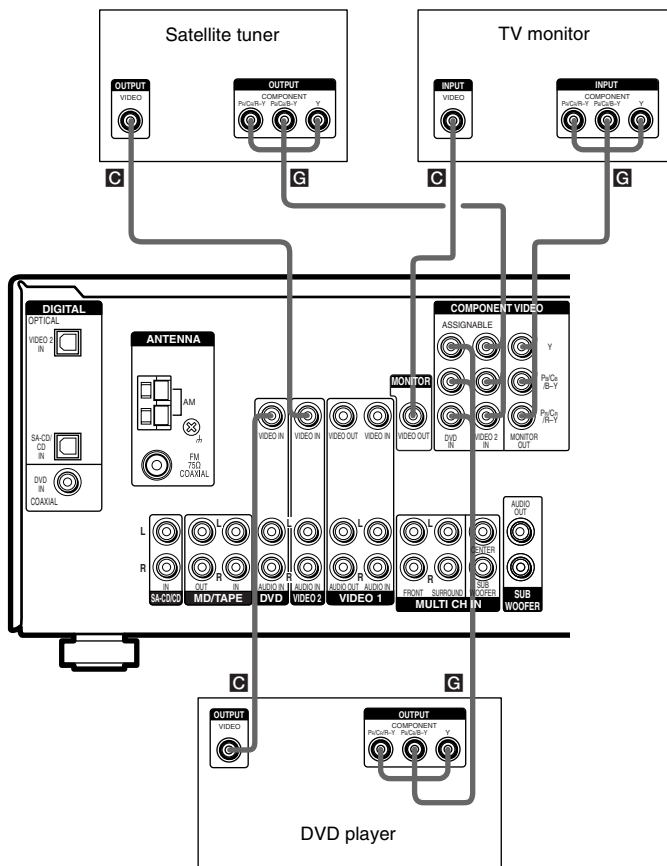

Note

On this receiver, the standard video signals cannot be converted to component video signals (or vice versa).

Hooking up a Super Audio CD/CD player

For details on the required cords (**A**–**G**), see page 6.

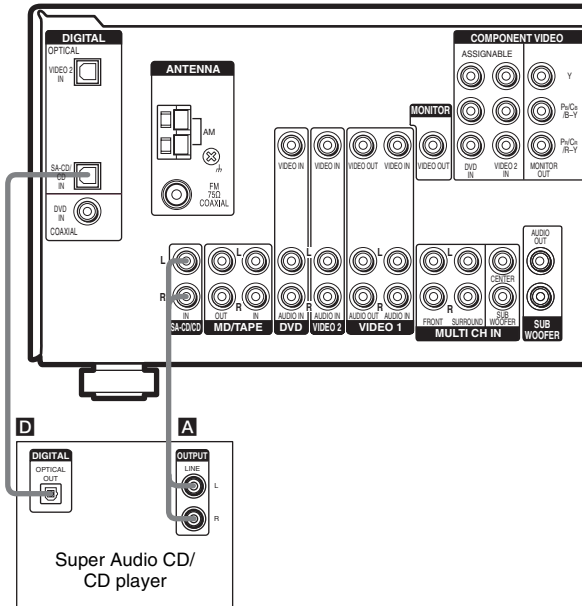

Tip

All the digital audio jacks are compatible with 32 kHz, 44.1 kHz, 48 kHz and 96 kHz sampling frequencies.

Note

No sound is output when you play a Super Audio CD on the Super Audio CD player connected to the SA-CD/CD OPTICAL IN jack on this receiver. Connect the player to the analog input jacks (SA-CD/CD IN jacks). Refer to the operating instructions supplied with the Super Audio CD player.

1b: Connecting components with multi channel output jacks

1 Connect the audio jacks.

(HT-9900M and HT-6900DP only)

If your DVD or Super Audio CD player is equipped with multi channel output jacks, you can connect it to this receiver's MULTI CH IN jacks to enjoy the multi channel sound. Alternatively, the multi channel input jacks can be used to connect an external multi channel decoder.

For details on the required cords (A–G), see page 6.

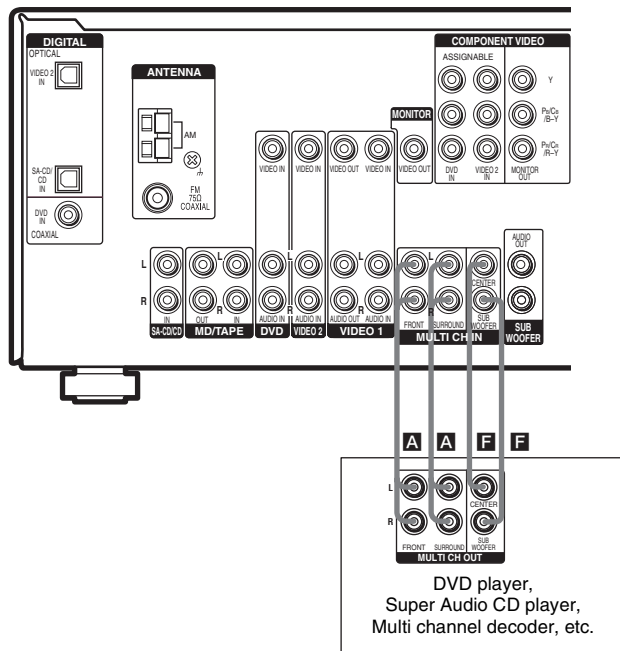

Tip

This connection also allows you to enjoy software with multi channel audio recorded in formats other than the Dolby Digital and DTS.

Note

When you make connections to the MULTI CH IN jacks, you will need to adjust the level of the speakers and sub woofer using the controls on the connected component.

2 Connect the video jacks.

The following illustration shows how to connect a DVD player with COMPONENT VIDEO (Y, P_B/C_B/B-Y, P_R/C_R/R-Y) output jacks. Connecting a TV with component video input jacks allows you to enjoy higher quality video.

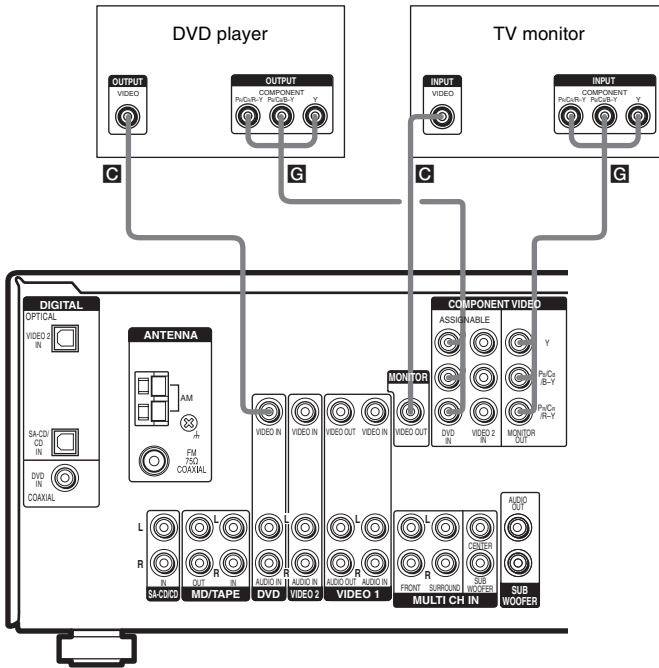

Note

On this receiver, the standard video signals cannot be converted to component video signals (or vice versa).

1c: Connecting components with only analog audio jacks

Hooking up audio components

For details on the required cords (**A-G**), see page 6.

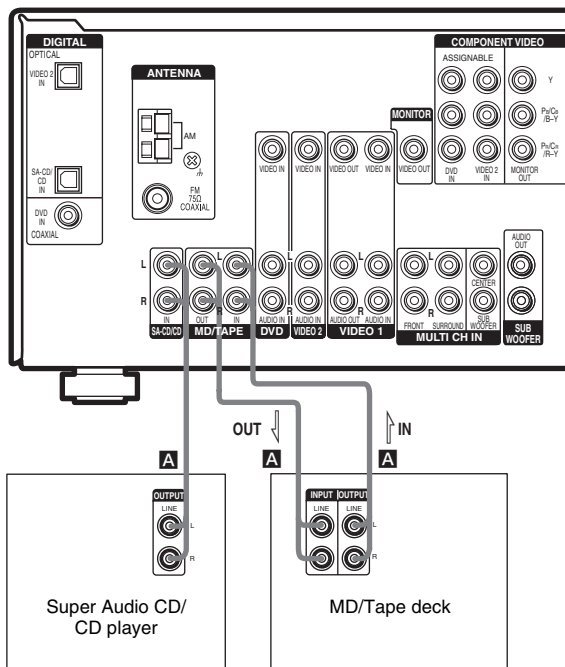

Hooking up video components

If you connect your TV to the MONITOR VIDEO OUT jack, you can watch the video from the selected input (page 23). For details on the required cords (**A**–**G**), see page 6.

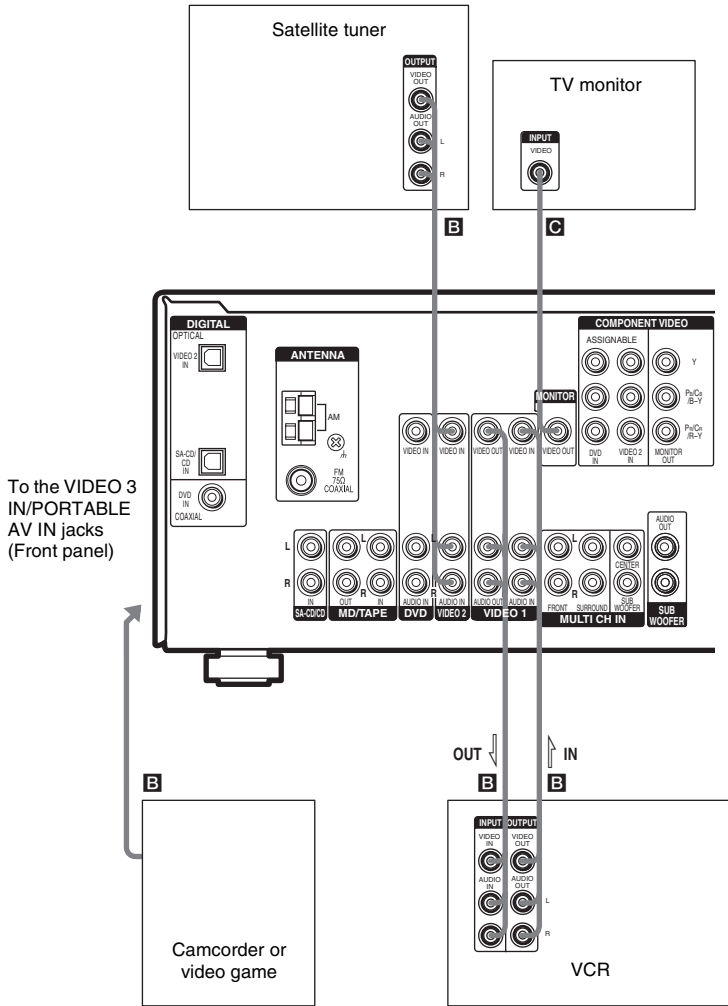

2: Connecting the antennas

Connect the supplied AM loop antenna and FM wire antenna.

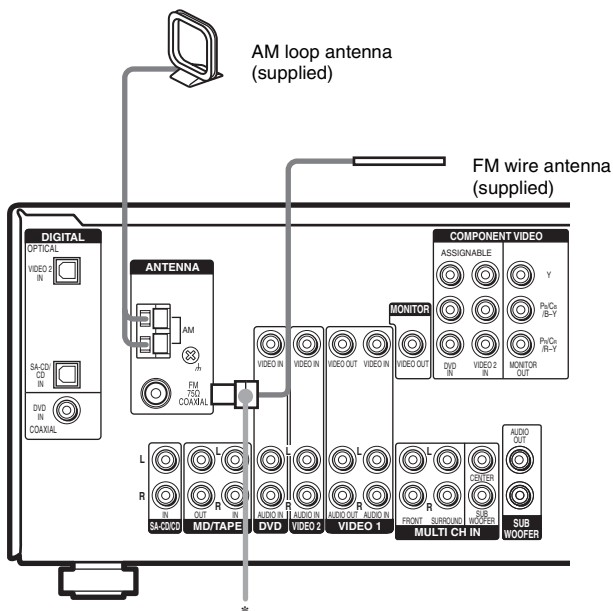

* The shape of the connector varies depending on the area code.

Notes

- To prevent noise pickup, keep the AM loop antenna away from the receiver and other components.
- Be sure to fully extend the FM wire antenna.
- After connecting the FM wire antenna, keep it as horizontal as possible.

3: Connecting speakers

Connect your speakers to the receiver. This receiver allows you to use a 6.1 channel speaker system. To fully enjoy theater-like multi channel surround sound requires five speakers (two front speakers, a center speaker, and two surround speakers) and a sub woofer (5.1 channel).

You can enjoy high fidelity reproduction of DVD software recorded in the Surround EX format if you connect one additional surround back speaker (6.1 channel) (see “Selecting the surround back decoding mode” on page 33).

Example of 6.1 channel speaker system configuration

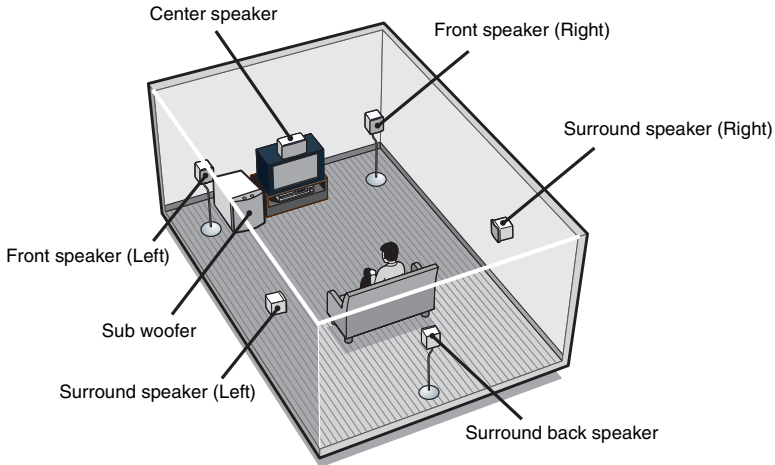

Tips

- When you connect 6.1 channel speaker system, place the surround back speaker behind the listening position.
- Since the sub woofer does not emit highly directional signals, you can place it wherever you want.
- For greater flexibility in the positioning of the speakers, use the optional WS-FV10D (HT-5950DP only) or WS-FV11 floor stand (available only in certain countries).
- You can also install the front, surround and surround back speakers on the wall (see page 17).

Note

Connect the long speaker connecting cords to the surround and surround back speaker terminals and the short speaker connecting cords to the front and center speaker terminals.

Attaching foot pads

To prevent speaker vibration or movement, attach the supplied foot pads to the speaker as shown in the illustration below.

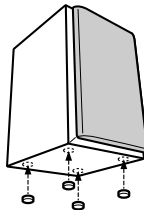

Note

Be sure to attach the supplied foot pads to the sub woofer as well.

continued

Required cords

A Speaker cords (supplied)



B Monaural audio cord (supplied)

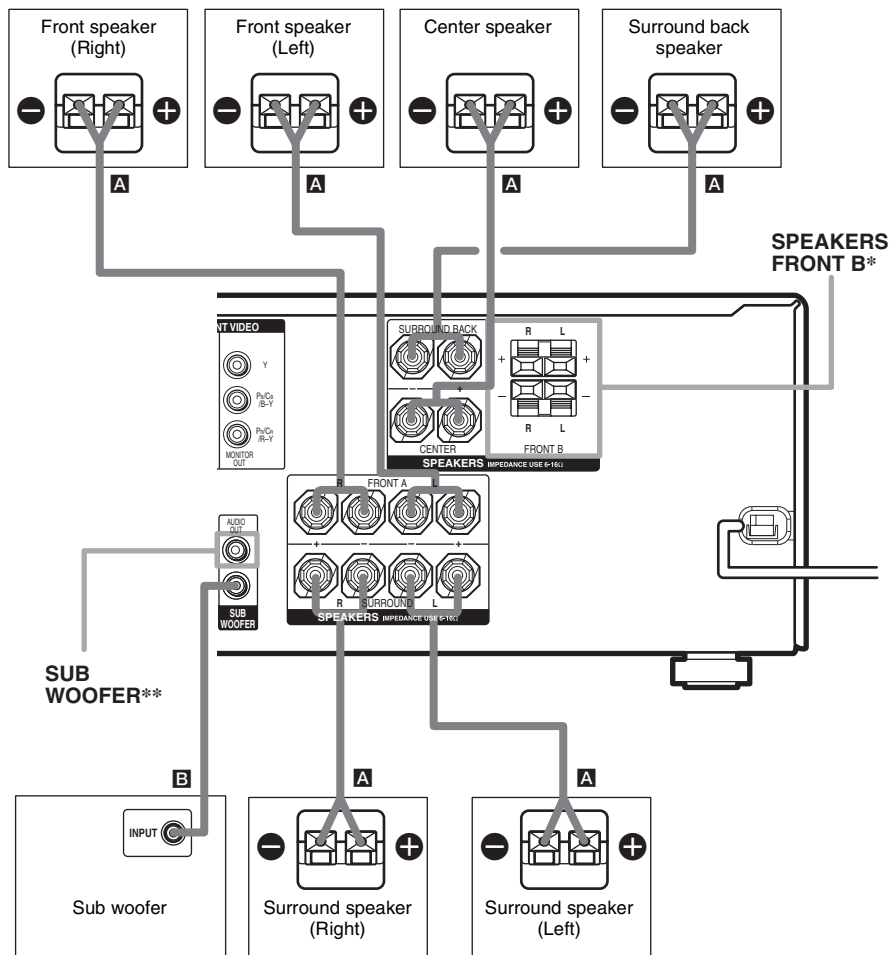

* (HT-9900M and HT-6900DP only) If you have an additional front speaker system, connect them to the SPEAKERS FRONT B terminals. You can select the front speakers you want to use with the SPEAKERS (OFF/A/B/A+B) button. For details, see “Selecting the speaker system” (page 41).

** (HT-9900M and HT-6900DP only) If you have an additional sub woofer, you can connect it to the other SUB WOOFER terminal.

Installing the speakers on the wall

You can install your front, surround and surround back speakers on the wall.

- 1 Prepare screws (not supplied) that are suitable for the metal hook on the back of each speaker. See the illustrations below.**

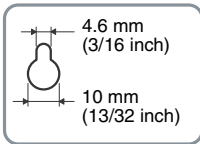
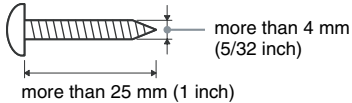

Metal hook on the back of the speaker

- 2 Fasten the screws to the wall. The screws should protrude 5 to 7 mm (7/32 to 9/32 inch).**

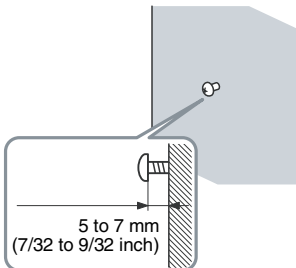

- 3 Hang the speakers on the screws.**

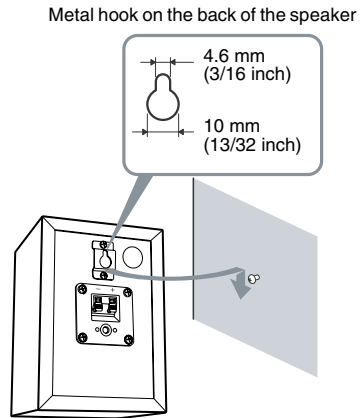

Notes

- Use screws that are suitable for the wall material and strength. As a plaster board wall is especially fragile, attach the screws securely to a beam and fasten them to the wall. Install the speakers on a vertical and flat wall where reinforcement is applied.
- Contact a screw shop or installer regarding the wall material or screws to be used.
- Sony is not responsible for accident or damage caused by improper installation, insufficient wall strength or improper screw installation, natural calamity, etc.

4: Connecting the AC power cord

Connect the AC power cord to a wall outlet.

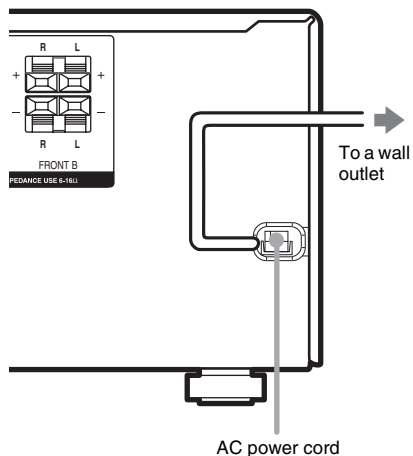

Performing initial setup operations

Before using the receiver for the first time, initialize the receiver by performing the following procedure.

This procedure can also be used to return settings you have made to their factory defaults. Use the buttons on the receiver for the operation.

1 Press I/⏻ to turn off the receiver.

2 Hold down I/⏻ for 5 seconds.

“PUSH” and “ENTER” appears in the display alternately.

3 Press ENTER.

“CLEARING” appears in the display for a while, then “CLEARED” appears.

The following are reset to their factory settings.

- All settings in the SPEAKER SET UP, LEVEL, TONE and CUSTOMIZE menus.
- The sound field memorized for each input and preset station.
- All sound field parameters.
- All preset stations.
- All index names for inputs and preset stations.
- MASTER VOLUME -/+ is set to “VOL MIN”.

5: Setting up the speakers

You can use the **SPEAKER SET UP** menu to set the distance and location of the speakers connected to this receiver.

- 1 Press **I/⏻** to turn on the receiver.
- 2 Press **MAIN MENU** repeatedly to select “<SET UP>”.
- 3 Press **<** or **>** repeatedly to select the parameter you want to adjust.

For details, see “**SPEAKER SET UP** menu parameters” below.

Note

Some speaker setup items may appear dimmed in the display. This means that they have been adjusted automatically due to other speaker settings or may not be adjustable.

- 4 Press **+** or **-** repeatedly to select the setting you want.
The setting is entered automatically.
- 5 Repeat steps 3 and 4 until you have set all of the items that follow.

SPEAKER SET UP menu parameters

The initial settings are underlined>.

■ DIST. XX ft. (Front speaker distance)

Initial setting: 10 ft.

Lets you set the distance from your listening position to the front speakers (**A**). You can adjust from 3 to 23 feet in 1 foot steps.

If both front speakers are not placed an equal distance from your listening position, set the distance to the closest speaker.

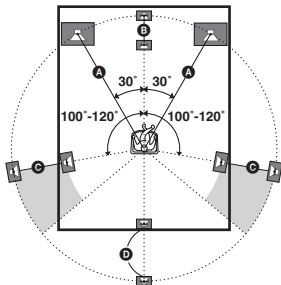

■ DIST. XX ft. (Center speaker distance)

Initial setting: 10 ft.

Lets you set the distance from your listening position to the center speaker. Center speaker distance should be set from a distance equal to the front speaker distance (**A**) to a distance 5 feet closer to your listening position (**B**).

■ DIST. XX ft. (Surround speaker distance)

Initial setting: 10 ft.

Lets you set the distance from your listening position to the surround speakers. Surround speaker distance should be set from a distance equal to the front speaker distance (**A**) to a distance 15 feet closer to your listening position (**C**).

If both surround speakers are not placed an equal distance from your listening position, set the distance to the closest speaker.

■ DIST. XX ft. (Surround back speaker distance)

Initial setting: 10 ft.

Lets you set the distance from your listening position to the surround back speaker. Surround back speaker distance should be set from a distance equal to the front speaker distance (**A**) to a distance 15 feet closer to your listening position (**D**).

Tip

The receiver lets you to input the speaker position in terms of distance. However, it is not possible to set the center speaker further than the front speakers. Also, the center speaker cannot be set more than 5 feet closer than the front speakers.

Likewise, the surround speakers cannot be set further away from the listening position than the front speakers. And they can be no more than 15 feet closer. This is because incorrect speaker placement is not conducive to the enjoyment of surround sound.

Please note that, setting the speaker distance closer than the actual location of the speakers will cause a delay in the output of the sound from that speaker. In other words, the speaker will sound like it is further away.

For example, setting the center speaker distance 3–6 feet closer than the actual speaker position will create a fairly realistic sensation of being “inside” the screen. If you cannot obtain a satisfactory surround effect because the surround speakers are too close, setting the surround speaker distance closer (shorter) than the actual distance will create a larger sound stage.

Adjusting these parameter while listening to the sound often results in much better surround sound. Give it a try!

continued

■ **SW** XXXXXXX
(Sub woofer phase polarity)
(HT-9900M and HT-6900DP only)

Lets you set the sub woofer phase polarity.

• **NORMAL**

Normally, select "NORMAL".

• **REVERSE**

Depending on the type of front speakers, the position of the sub woofer, and the cut-off frequency of the sub woofer, setting the phase polarity to "REVERSE" may produce better bass. Besides bass reproduction, the richness and tightness of the overall sound may also be affected. While listening from the main listening position, select the setting that best suits your environment.

■ **SL** **SR** XXXX/XX
(Surround speaker position)

Lets you specify the location of your surround speakers for proper implementation of the surround effects in the Cinema Studio EX modes (page 31).

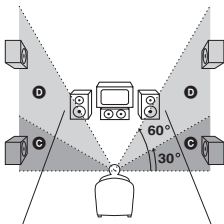
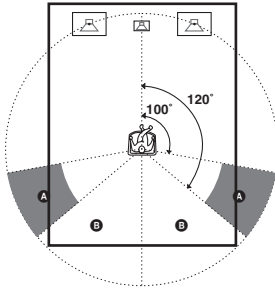

• **SIDE/LO**

Select if the location of your surround speakers corresponds to section **A** and **C**.

• **SIDE/HI**

Select if the location of your surround speakers corresponds to section **A** and **D**.

• **BEHD/LO**

Select if the location of your surround speakers corresponds to section **B** and **C**.

• **BEHD/HI**

Select if the location of your surround speakers corresponds to section **B** and **D**.

Tip

Surround speaker position is designed specifically for implementation of the Cinema Studio EX modes.

For other sound fields, speaker position is not so critical. Those sound fields were designed under the premise that the surround speakers would be located behind the listening position, but presentation remains fairly consistent even with the surround speakers positioned at a rather wide angle. However, if the speakers are pointing toward the listener from the immediate left and right of the listening position, the surround effects becomes unclear unless set to "SIDE/LO" or "SIDE/HI".

Nevertheless, each listening environment has many variables, such as wall reflections, and you may obtain better results using "BEHD/HI" if your speakers are located high above the listening position, even if they are to the immediate left and right.

Therefore, although it may result in a setting contrary to the above explanation, we recommend that you playback multi channel surround encoded software and select the setting that provides a good sense of spaciousness and that best succeeds in forming a cohesive space between the surround sound from the surround speakers and the sound of the front speakers. If you are not sure which sounds best, select "BEHD/LO" or "BEHD/HI" and then use the speaker distance parameter and speaker level adjustments to obtain proper balance.

6: Setting up the sub woofer

Listening to the sub woofer

HT-9900M and HT-6900DP only

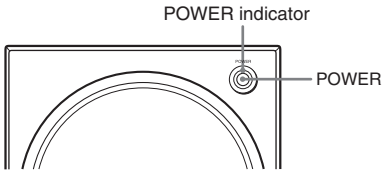

HT-5950DP only

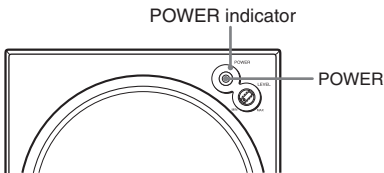

Before playing the program source, set the volume to minimum on the receiver.

- 1** Turn on the receiver.
- 2** Press input buttons (e.g., DVD) to select the program source (e.g., DVD player).
- 3** Press **POWER** on the sub woofer.
The **POWER** indicator on the sub woofer lights up.
- 4** Play the program source.

Adjusting the level

Slight adjustments to the system can enhance your sound enjoyment.

HT-9900M and HT-6900DP only

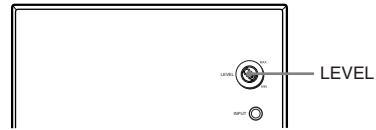

HT-5950DP only

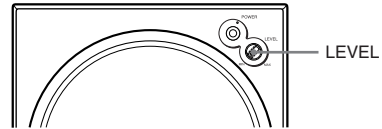

Turn **LEVEL** to adjust the volume.

Set the volume level to best suit your preference according to the program source.

Note

Do not set the volume of the sub woofer to maximum. Extraneous noise may be heard.

7: Adjusting the speaker levels and balance

— TEST TONE

Adjust the speaker levels and balance while listening to the test tone from your listening position. Use the remote for the operation.

Tip

The receiver employs a test tone with a frequency centered at 800 Hz.

1 Press I/⏻ to turn on the receiver.

2 Press TEST TONE.

“T. TONE” appears in the display and the test tone is output from each speaker in sequence.

Front (left) → Center → Front (right) → Surround (right) → Surround back → Surround (left) → Sub woofer

3 Adjust the speaker levels and balance using the LEVEL menu so that the level of the test tone sounds the same from each speaker.

For details on the LEVEL menu settings, see page 36.

Tips

- To adjust the level of all speakers at the same time, press MASTER VOL +/- on the remote or turn MASTER VOLUME -/+ on the receiver.
- The adjusted value are shown in the display during adjustment.

4 Press TEST TONE again after adjustment.

The test tone turns off.

Notes

- (HT-9900M and HT-6900DP only) The test tone cannot be used when MULTI CH IN function is used.
- Although these adjustments can also be made via the front panel using the LEVEL menu (when the test tone is output, the receiver switches to the LEVEL menu automatically), we recommend you follow the procedure described above and adjust the speaker levels from your listening position using the remote.

Amplifier Operation

Selecting the component

1 Press input buttons to select the input.

To select the	Press
VCR	VIDEO 1
Satellite tuner	VIDEO 2
Camcorder or video game	VIDEO 3
DVD player	DVD
MD or tape deck	MD/TAPE
Super Audio CD or CD player	SA-CD/CD
Built-in tuner (FM)	FM
Built-in tuner (AM)	AM

The selected input appears in the display.

2 Turn on the component and start playback.

Note

If you select any video components, set the TV's video input to match the component you selected.

3 Turn MASTER VOLUME $-/+$ to adjust the volume.

Note

To avoid damaging your speakers, make sure that you turn down the volume before you turn off the receiver.

To mute the sound

Press MUTE on the remote.

The muting function will be canceled when you do the following.

- Press MUTE on the remote again.
- Turn the power off.
- Increase the volume.

To use the headphones

Connect the headphones to the PHONES jack.

- When the headphones are connected, speaker output is automatically canceled and the following indications in the display turn off.

Model	Indications
HT-9900M and HT-6900DP	SP A and SP B
HT-5950DP	SP

- When the headphones are connected, you can select only the following sound fields (page 32).
 - HP 2CH (HEADPHONE 2CH)
 - HP MULTI (HEADPHONE MULTI) (HT-9900M and HT-6900DP only)
 - HP THEA (HEADPHONE THEATER)

Listening to multi channel sound

— MULTI CH IN

(HT-9900M and HT-6900DP only)

You can select the audio directly from the components connected to the MULTI CH IN jacks. This enables you to enjoy high quality analog inputs such as DVD or Super Audio CD. When MULTI CH IN is selected, the tone and sound field cannot be used.

Press MULTI CH IN.

Press again to cancel the MULTI CH IN function.

Note

To optimize the sound balance of this system, we recommend that you set the speaker configuration of your DVD or Super Audio CD player as follows:

Speaker type	Settings
FRONT	SMALL
CENTER	SMALL
SURROUND/REAR	SMALL
SUB WOOFER	YES

When MULTI CHANNEL DECODING indicator lights up

The MULTI CHANNEL DECODING indicator lights up when the receiver is decoding multi channel sources.

However, this indicator does not light up if you select 2CH STEREO mode.

Listening to FM/AM radio

You can listen to FM and AM broadcasts through the built-in tuner. Before operation, make sure you have connected the FM and AM antennas to the receiver (see page 14).

Tip

The tuning scale differs depending on the area code as shown in the following table. For details on area codes, see page 3.

Area code	FM	AM
U, CA	100 kHz	10 kHz*

* The AM tuning scale can be changed (see page 56).

Automatic tuning

If you do not know the frequency of the station you want, you can let the receiver scan all available stations in your area.

1 Press FM or AM to select the FM or AM band.

The last received station is tuned in.

2 Press TUNING + or TUNING –.

Press TUNING + to scan from low to high; press TUNING – to scan from high to low.

The receiver stops scanning whenever a station is received.

Tip

If “STEREO” flashes in the display and the FM stereo reception is poor, press FM MODE to change to monaural (MONO). You will not be able to enjoy the stereo effect, but the sound will be less distorted. To return to stereo mode, press FM MODE again.

Direct tuning

You can enter the frequency of the station you want directly. Use the remote for the operation.

- 1 **Press TUNER repeatedly to select the FM or AM band.**

The last received station is tuned in.

Tip

You can also use FM or AM on the receiver.

- 2 **Press D.TUNING.**
- 3 **Press the numeric buttons to enter the frequency.**

Example 1: FM 102.50 MHz

Press 1 → 0 → 2 → 5 → 0

Example 2: AM 1,350 kHz

Press 1 → 3 → 5 → 0

(You do not have to enter the last “0” when the tuning scale is set to 10 kHz.)

If you have tuned in an AM station, adjust the direction of the AM loop antenna for optimum reception.

If you cannot tune in a station and the entered numbers flash

Make sure you have entered the right frequency. If not, repeat steps 2 and 3. If the entered numbers still flash, the frequency is not used in your area.

Presetting radio stations

You can preset up to 30 FM or AM stations. Then you can easily tune in the stations you often listen to.

Presetting radio stations

- 1 **Press FM or AM to select the FM or AM band.**

The last received station is tuned in.

- 2 **Tune in the station that you want to preset using Automatic Tuning (page 24) or Direct Tuning (page 25).**

- 3 **Press MEMORY.**

“MEMORY” appears in the display for a few seconds. Do steps 4 to 5 before the display goes out.

- 4 **Press PRESET TUNING + or PRESET TUNING – repeatedly to select a preset station number.**

Each time you press the button, you can select the preset station number as follows:

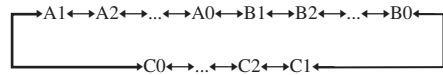

If “MEMORY” goes out before you select the preset station number, start again from step 3.

Tip

You can also use the remote to select a preset station number. Press SHIFT repeatedly to select a memory page (A, B or C) and then press the numeric buttons to select a preset number.

- 5 **Press MEMORY again.**

The station is stored to the selected preset number.

If “MEMORY” goes out before you press MEMORY, start again from step 3.

- 6 **Repeat steps 2 to 5 to preset another station.**

continued

Tuning to preset stations

- 1 Press **FM** or **AM** to select the FM or AM band.

The last received station is tuned in.

- 2 Press **PRESET TUNING +** or **PRESET TUNING -** repeatedly to select the preset station you want.

Each time you press the button, you can select the preset station as follows:

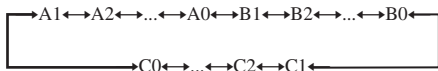

Using the remote

- 1 Press **TUNER** repeatedly to select the FM or AM band.
- 2 Press **PRESET/CH/D.SKIP +/-** repeatedly to select the preset station you want.

To select the preset station directly

Press the numeric buttons on the remote.

The preset station of the selected number in the current memory page is tuned in. Press **SHIFT** repeatedly on the remote to change the memory page.

Changing the display

Changing the information in the display

You can check the sound field etc. by changing the information in the display.

Press **DISPLAY** repeatedly.

Each time you press **DISPLAY**, the display will change cyclically as follows.

Index name of the input* → Selected input → Sound field currently applied

When the tuner is selected

Preset station name* → Frequency → Sound field currently applied

* Index name appears only when you have assigned one to the input or preset station (page 40). Index name does not appear when only blank spaces have been entered, or it is the same as the input name.

Adjusting the brightness of the display

Press **DIMMER** repeatedly.

The brightness of the display will change in 3 steps.

About the indications in the display

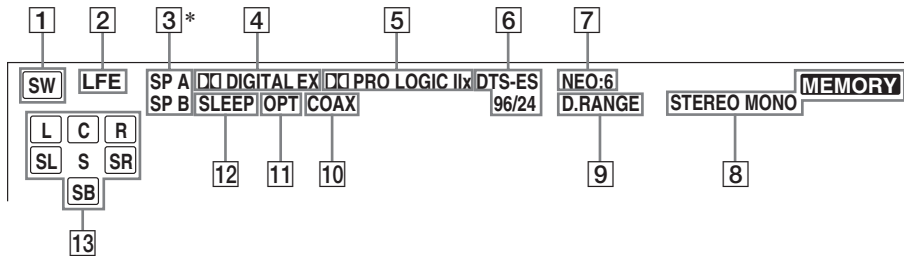

- 1 SW:** Lights up when the audio signal is output from the SUB WOOFER jack.
- 2 LFE:** Lights up when the disc being played back contains the LFE (Low Frequency Effect) channel and the LFE channel signal is actually being reproduced.
- 3 SP A/SP B*:** Lights up in accordance with the speaker system being used (A or B). Turns off when speaker output is turned off or when headphones are connected.

* For HT-5950DP, "SP" lights up in the display.

- 4 DIGITAL EX:** " DIGITAL" lights up when the receiver is decoding signals recorded in the Dolby Digital format. " DIGITAL EX" lights up when the receiver is decoding signals recorded in the Dolby Digital EX format.

Note

When playing a Dolby Digital format disc, be sure that you have made digital connections and that INPUT MODE is not set to "ANALOG" (page 35).

- 5 PRO LOGIC IIx:** " PRO LOGIC" lights up when the receiver applies Pro Logic processing to 2 channel signals in order to output the center and surround channel signals. " PRO LOGIC II" lights up when the Pro Logic II Movie/Music/Game decoder is activated. " PRO LOGIC IIx" lights up when the Pro Logic IIx Movie/Music/Game decoder is activated.

Note

Dolby Pro Logic IIx decoding does not function for DTS signals or for signals with a sampling frequency of more than 48 kHz.

- 6 DTS-ES 96/24:** "DTS" lights up when DTS signals are input. "DTS-ES" lights up when DTS-ES signals are input. "DTS 96/24" lights up when the receiver is decoding DTS 96 kHz/24 bit signals.

Note

When playing a DTS format disc, be sure that you have made digital connections and that INPUT MODE is not set to "ANALOG" (page 35).

- 7 NEO:6:** Lights up when DTS Neo:6 Cinema/Music mode decoding is activated.
- 8 Tuner indicators:** Lights up when using the receiver to tune in radio stations, etc. See pages 24–26 for tuner operations.
- 9 D.RANGE:** Lights up when dynamic range compression is activated (page 36).
- 10 COAX:** Lights up when the source signal is a digital signal being input through the COAXIAL terminal or when INPUT MODE is set to "COAX IN" (page 35).
- 11 OPT:** Lights up when the source signal is a digital signal being input through the OPTICAL terminal or when INPUT MODE is set to "OPT IN" (page 35).
- 12 SLEEP:** Lights up when sleep timer is activated.

continued

13 Playback channel indicators: The letters (L, C, R, etc.) indicate the channels being played back. The boxes around the letters vary to show how the receiver downmixes the source sound.

L (Front Left), R (Front Right), C (Center (monaural)), SL (Surround Left), SR (Surround Right), S (Surround (monaural or the surround components obtained by Pro Logic processing)), SB (Surround Back (the surround back components obtained by 6.1 channel decoding))

Example:

Recording format (Front /Surround): 3/2

Sound Field: A.F.D. AUTO



Enjoying Surround Sound

Using only the front speakers and sub woofer

— 2CH STEREO

In this mode, the receiver outputs the sound from the front left/right speakers and sub woofer.

When multi channel surround formats are input, the signals are downmixed to 2 channel with bass frequencies being output from the sub woofer.

When standard 2 channel stereo sources are input, the receiver's bass redirection circuitry will be activated. The front channel bass frequencies will be output from the sub woofer.

Press 2CH.

"2CH ST." appears in the display and the receiver switches to the 2CH STEREO mode.

Enjoying higher fidelity sound

— AUTO FORMAT DIRECT

The Auto Format Direct (A.F.D.) mode allows you to select the decoding mode you want for your audio sound.

A.F.D. mode (Display)	Decoding mode
A.F.D. AUTO (A.F.D. AUTO)	As encoded
PRO LOGIC (DOLBY PL)	Dolby Pro Logic
PRO LOGIC II MOVIE (PLII MV)	Dolby Pro Logic II
PRO LOGIC II MUSIC (PLII MS)	
PRO LOGIC II GAME (PLII GM)	
PRO LOGIC IIx MOVIE (PLIIX MV)	Dolby Pro Logic IIx
PRO LOGIC IIx MUSIC (PLIIX MS)	
PRO LOGIC IIx GAME (PLIIX GM)	
Neo:6 Cinema (NEO6 CIN)	DTS Neo:6
Neo:6 Music (NEO6 MUS)	
MULTI STEREO (MULTI ST.)	

Decoding the input audio signal automatically

In this mode, the receiver automatically detects the type of audio signal being input (Dolby Digital, DTS, standard 2 channel stereo, etc.) and performs the proper decoding if necessary. This mode presents the sound as it was recorded/encoded, without adding any surround effects. However, if there are no low frequency signals (Dolby Digital LFE, etc.) it will generate a low frequency signal for output to the sub woofer.

Press A.F.D. repeatedly to select “A.F.D. AUTO”.

The receiver automatically detects the type of audio signal being input and performs the proper decoding if necessary.

Tip

In most cases, “A.F.D. AUTO” provides the most appropriate decoding. You may want to use SURR BACK DECODING (page 33) to match the input stream to the mode you prefer.

Enjoying stereo sound in multi channel (2 channel decoding mode)

This mode lets you specify the type of decoding for 2 channel audio sources. This receiver can reproduce 2 channel sound in 5 channels through Dolby Pro Logic II; 6 channels through Dolby Pro Logic IIX; 6 channels through DTS Neo:6 or 4 channels through Dolby Pro Logic. However, DTS 2CH sources are not decoded by DTS Neo:6; they are output in 2 channels.

Press A.F.D. repeatedly to select the 2 channel decoding mode.

The selected type of decoding appears in the display.

■ DOLBY PL (PRO LOGIC)

Performs Dolby Pro Logic decoding. The source recorded in 2 channel is decoded into 4.1 channels.

■ PLII MV (PRO LOGIC II MOVIE)

Performs Dolby Pro Logic II Movie mode decoding. This setting is ideal for movies encoded in Dolby Surround. In addition, this mode can reproduce sound in 5.1 channel when watching videos of overdubbed or old movies.

■ PLII MS (PRO LOGIC II MUSIC)

Performs Dolby Pro Logic II Music mode decoding. This setting is ideal for normal stereo sources such as CDs.

■ PLII GM (PRO LOGIC II GAME)

Performs Dolby Pro Logic II Game mode decoding. This setting is ideal for video game softwares.

■ PLIIX MV (PRO LOGIC IIX MOVIE)

Performs Dolby Pro Logic IIX Movie mode decoding. This setting expands Dolby Pro Logic II Movie or Dolby Digital 5.1 to discrete 6.1 movie channels.

■ PLIIX MS (PRO LOGIC IIX MUSIC)

Performs Dolby Pro Logic IIX Music mode decoding. This setting shares hard “back” effects across all surround speakers.

■ PLIIX GM (PRO LOGIC IIX GAME)

Performs Dolby Pro Logic IIX Game mode decoding. This setting delivers full-impact special effect signals panned to the surround speakers.

Note

Dolby Pro Logic IIX decoding does not function for DTS format signals or for signals with a sampling frequency of more than 48 kHz.

■ NEO6 CIN (Neo:6 Cinema)

Performs DTS Neo:6 Cinema mode decoding.

■ NEO6 MUS (Neo:6 Music)

Performs DTS Neo:6 Music mode decoding. This setting is ideal for normal stereo sources such as CDs.

■ MULTI ST. (MULTI STEREO)

Outputs the 2 channel left/right signals from all speakers.

Selecting a sound field

You can take advantage of surround sound simply by selecting one of the receiver's pre-programmed sound fields. They bring the exciting and powerful sound of movie theaters and concert halls into your home.

Selecting a sound field for movies

Press **MOVIE** repeatedly to select the sound field you want.

The selected sound field appears in the display.

Sound field	Display
CINEMA STUDIO EX A DCS	C.ST.EX A
CINEMA STUDIO EX B DCS	C.ST.EX B
CINEMA STUDIO EX C DCS	C.ST.EX C

About DCS (Digital Cinema Sound)

Sound fields with **DCS** marks use DCS technology.

DCS is the concept name of the surround technology for home theater developed by Sony. DCS uses the DSP (Digital Signal Processor) technology to reproduce the sound characteristics of an actual cinema cutting studio in Hollywood.

When played at home, DCS will create a powerful theater effect that mimics the artistic combination of sound and action as envisioned by the movie director.

■ C.ST.EX A (CINEMA STUDIO EX A) **DCS**

Reproduces the sound characteristics of the Sony Pictures Entertainment "Cary Grant Theater" cinema production studio. This is a standard mode, great for watching most any type of movies.

■ C.ST.EX B (CINEMA STUDIO EX B) **DCS**

Reproduces the sound characteristics of the Sony Pictures Entertainment "Kim Novak Theater" cinema production studio. This mode is ideal for watching science-fiction or action movies with lots of sound effects.

■ C.ST.EX C (CINEMA STUDIO EX C) **DCS**

Reproduces the sound characteristics of the Sony Pictures Entertainment scoring stage. This mode is ideal for watching musicals or films where orchestra music is featured in the soundtrack.

About CINEMA STUDIO EX modes

CINEMA STUDIO EX modes are suitable for watching motion picture DVDs (etc.), with multi channel surround effects. You can reproduce the sound characteristics of Sony Pictures Entertainment's dubbing studio in your home.

The CINEMA STUDIO EX modes consist of the following three elements.

- Virtual Multi Dimension
Creates 5 sets of virtual speakers from a single pair of actual surround speakers.
- Screen Depth Matching
Creates the sensation that the sound is coming from inside the screen like in theaters.
- Cinema Studio Reverberation
Reproduces the type of reverberation found in theaters.

The CINEMA STUDIO EX modes integrate these three elements simultaneously.

Notes

- The effects provided by the virtual speakers may cause increased noise in the playback signal.
- When listening with sound fields that employ the virtual speakers, you will not be able to hear any sound coming directly from the surround speakers.

Selecting a sound field for music

Press **MUSIC** repeatedly to select the sound field you want.

The selected sound field appears in the display.

Sound field	Display
HALL	HALL
JAZZ CLUB	JAZZ
LIVE CONCERT	CONCERT

■ HALL

Reproduces the acoustics of a classical concert hall.

■ JAZZ (JAZZ CLUB)

Reproduces the acoustics of a jazz club.

■ CONCERT (LIVE CONCERT)

Reproduces the acoustics of a 300-seat live house.

When the headphones are connected

You can select only from the following sound fields.

■ HP 2CH (HEADPHONE 2CH)

Outputs the sound in 2 channel (stereo). Standard 2 channel stereo sources completely bypass the sound field processing and multi channel surround formats are downmixed to 2 channels.

■ HP MULTI (HEADPHONE MULTI) (HT-9900M and HT-6900DP only)

Outputs the front analog signal from MULTI CH IN jacks.

■ HP THEA (HEADPHONE THEATER) **DCS**

Allows you to experience a theater-like environment while listening through a pair of headphones.



Note

If you connect a pair of headphones while a sound field is operating, the system will automatically switch to HEADPHONE 2CH if using a sound field selected with the 2CH or A.F.D. button, or to HEADPHONE THEATER if using a sound field selected with the MOVIE or MUSIC button.

To turn off the surround effect

Press 2CH to select "2CH ST." or press A.F.D. repeatedly to select "A.F.D. AUTO".

Tips

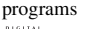
- The receiver lets you apply the last selected sound field to an input whenever it is selected (Sound Field Link). For example, if you select HALL for the SA-CD/CD input, then change to a different input and then return to SA-CD/CD, HALL will automatically be applied again.
- You can identify the encoding format of DVD software, etc. by looking at the logo on the package.
 -  : Dolby Digital discs
 -  : Dolby Surround encoded programs
 -  : DTS Digital Surround encoded programs

Note

Sound fields do not function for the signals with a sampling frequency of more than 48 kHz.

Selecting the surround back decoding mode

— *SURR BACK DECODING*

This function lets you select the decoding mode for the surround back signals of the multi channel input stream.

By decoding the surround back signal of DVD software (etc.) recorded in Dolby Digital EX, DTS-ES Matrix, DTS-ES Discrete 6.1, etc. format, you can enjoy the surround sound intended by the filmmakers.

Press SURR BACK DECODING repeatedly to select the surround back decoding mode.

“SB XXXX” appears in the display.

For details, see “How to select the surround back decoding mode” on page 34.

Tip

You can select the surround back decoding mode using “SB XXXX” in the CUSTOMIZE menu (page 38).

Note

You can select the surround back decoding mode only when you use a sound field selected with the A.F.D. button except for the Dolby Pro Logic IIx mode.

How to select the surround back decoding mode

You can select the surround back decoding mode you want according to the input stream.

When you select “SB AUTO”

When the input stream contains the 6.1 channel decode flag^{a)}, the appropriate decoder is applied to decode the surround back signal.

Input stream	Output channel	Applied surround back decoder
Dolby Digital 5.1	5.1	—
Dolby Digital EX ^{b)}	6.1	Matrix decoder conforms to Dolby Digital EX
DTS 5.1	5.1	—
DTS-ES Matrix 6.1 ^{c)}	6.1	DTS Matrix decoder
DTS-ES Discrete 6.1 ^{d)}	6.1	DTS Discrete decoder

When you select “SB ON”

Dolby Digital EX is applied to decode the surround back signal regardless of the 6.1 channel decode flag^{a)} in the input stream. This decoder conforms to Dolby Digital EX and functions the same as the decoders^{e)} used in movie theaters.

Input stream	Output channel	Applied surround back decoder
Dolby Digital 5.1	6.1	Matrix decoder conforms to Dolby Digital EX
Dolby Digital EX ^{b)}	6.1	Matrix decoder conforms to Dolby Digital EX
DTS 5.1	6.1	Matrix decoder conforms to Dolby Digital EX
DTS-ES Matrix 6.1 ^{c)}	6.1	Matrix decoder conforms to Dolby Digital EX
DTS-ES Discrete 6.1 ^{d)}	6.1	Matrix decoder conforms to Dolby Digital EX

When you select “SB OFF”

Surround back decoding is not performed.

- a) 6.1 channel decode flag is the information recorded in software like DVDs.
- b) Dolby Digital DVD that includes a Surround EX flag. The Dolby Corporation web page can help you distinguish Surround EX films.
- c) Software encoded with a flag to denote it has both Surround EX and 5.1 channel signals.
- d) Software encoded with both 5.1 channel signals and an extension stream designed for returning those signals to 6.1 discrete channels. Discrete 6.1 channel signals are DVD specific signals not used in movie theaters.
- e) This decoder can be used for all 6.1 formats (Dolby Digital EX, DTS-ES Matrix 6.1, DTS-ES Discrete 6.1).

Note

There may be no sound from the surround back speaker in Dolby Digital EX mode. Some discs have no Dolby Digital EX flag even though the packages have Dolby Digital EX logos. In this case, select “SB ON”.

Assigning the component video input

— COMPONENT VIDEO INPUT ASSIGN

You can assign a component video input for another visual input.

- 1** Press MAIN MENU repeatedly to select “<CUSTOM>”.
- 2** Press < or > repeatedly to select “COMP. V. A.”.
- 3** Press ENTER.
- 4** Press < or > repeatedly to select the component video input you want to assign.
- 5** Press + or – repeatedly to select the input you want to assign the component video input jacks selected in step 4.

The input you can assign varies for each component video input. For details, see “Selectable component video inputs for each input”.

- 6** Press ENTER.

Selectable component video inputs for each input

The initial settings are underlined.

VIDEO 2

VIDEO 1, VIDEO 2, VIDEO 3

DVD

VIDEO 1, VIDEO 3, DVD

Note

You cannot assign a visual input to more than one component video input.

Switching the audio input mode for digital components

— INPUT MODE

You can switch the audio input mode for components which have digital audio input jacks.

- 1** Press input buttons to select the input.
- 2** Press INPUT MODE repeatedly to select the audio input mode.

The selected audio input mode appears in the display.

Audio input modes

- **AUTO IN**
Gives priority to digital signals when there are both digital and analog connections. If there are no digital signals, analog is selected.
- **COAX IN**
Specifies the digital audio signals input to the DIGITAL COAXIAL input jack.
- **OPT IN**
Specifies the digital audio signals input to the DIGITAL OPTICAL input jacks.
- **ANALOG**
Specifies the analog audio signals input to the AUDIO IN (L/R) jacks.

Notes

- When signals with a sampling frequency of more than 48 kHz is input, the tone and sound field cannot be used.
- Some audio input modes may be dimmed depending on the input. This means that the selected input is unavailable.

Customizing sound fields

By adjusting the LEVEL menu, you can customize the sound fields to suit your particular listening situation.

Note on the displayed items

The setup items you can adjust in each menu vary depending on the sound field. Certain setup parameters may be dimmed in the display. This means that the selected parameter is either unavailable or fixed and unchangeable.

Adjusting the LEVEL menu

You can adjust the balance and level of each speaker. These settings are applied to all sound fields except for effect level parameter. The effect level parameter settings are stored individually for each sound field.

- 1 Start playing a source encoded with multi channel surround effects (DVD, etc.).**
- 2 Press MAIN MENU repeatedly to select “<LEVEL>”.**
- 3 Press < or > repeatedly to select the parameter you want to adjust.**
For details, see “LEVEL menu parameters” below.
- 4 While monitoring the sound, press + or – repeatedly to select the setting you want.**
The setting is entered automatically.
- 5 Repeat steps 3 and 4 to adjust the other parameters.**

LEVEL menu parameters

The initial setting is underlined>.

BAL. L/R XX (Front speaker balance)

Initial setting: BALANCE (0)

Lets you adjust the balance between front left and right speakers. You can adjust in the range of BAL. L (+1 to +8), BALANCE (0), BAL. R (+1 to +8) in 17 steps.

■ **CTR XXX dB** (Center speaker level)

■ **SUR.L. XXX dB** (Surround speaker (left) level)

■ **SUR.R. XXX dB** (Surround speaker (right) level)

■ **SB XXX dB** (Surround back speaker level)

■ **S.W. XXX dB** (Sub woofer level)

Initial setting: 0 dB

You can adjust from -10 dB to +10 dB in 1 dB steps.

■ **COMP. XXX** (Dynamic range compressor)

Lets you compress the dynamic range of the sound track. This may be useful when you want to watch movies at low volumes late at night.

- OFF
The dynamic range is not compressed.
- STD
The dynamic range is compressed as intended by the recording engineer.
- MAX
The dynamic range is compressed dramatically.

Tip

Dynamic range compressor lets you compress the dynamic range of the soundtrack based on the dynamic range information included in the Dolby Digital signal. “STD” is the standard setting, but it only enacts light compression. Therefore, we recommend using the “MAX” setting. This greatly compresses the dynamic range and lets you view movies late at night at low volumes. Unlike analog limiters, the levels are predetermined and provide a very natural compression.

Note

Dynamic range compression is possible with Dolby Digital sources only.

■ **EFCT. XXX (Effect level)**

Initial setting: STD

Lets you adjust the “presence” of the surround effect in 3 levels – MIN (minimum effect), STD (standard effect) and MAX (maximum effect).

Note

This parameter is valid only when you use a sound field selected with the MOVIE or MUSIC buttons.

Resetting sound fields to the initial settings

Use the buttons on the receiver for the operation.

- 1** Press I/⏻ to turn off the power.
- 2** While holding down 2CH, press I/⏻.
“SF. CLR.” appears in the display and all sound fields are reset to the initial setting.

Adjusting the tone

You can adjust the tonal quality (bass, treble level) of the front speakers using the TONE menu.

- 1** Start playing a source encoded with multi channel surround effects (DVD, etc.).
- 2** Press MAIN MENU repeatedly to select “<TONE>”.
- 3** Press < or > repeatedly to select the parameter you want to adjust.
For details, see “TONE menu parameters” below.
- 4** While monitoring the sound, press + or – repeatedly to select the setting you want.
The setting is entered automatically.
- 5** Repeat steps 3 and 4 to adjust the other items.

Note

You cannot adjust the tone when the receiver is decoding signals with a sampling frequency of more than 48 kHz, or when DTS 96/24, DTS-ES Matrix or DTS Neo:6 decoding is applied.

TONE menu parameters

- BASS XX dB
(Front speaker bass level)
- TREB. XX dB
(Front speaker treble level)

Initial setting: 0 dB

You can adjust from –6 dB to +6 dB in 1 dB steps.

Advanced settings

Using the CUSTOMIZE menu to adjust the receiver

You can adjust various receiver settings using the CUSTOMIZE menu.

- 1 Press MAIN MENU repeatedly to select “<CUSTOM>”.**
- 2 Press < or > repeatedly to select the parameter you want to adjust.**
For details, see “CUSTOMIZE menu parameters” below.
- 3 Press + or – repeatedly to select the setting you want.**
The setting is entered automatically.
- 4 Repeat steps 2 and 3 to adjust the other items.**

CUSTOMIZE menu parameters

The initial settings are underlined.

■ 96 XXXX (DTS 96/24 decoding mode)

- AUTO

When a DTS 96/24 signal is input, it is played back at 96 kHz sampling frequencies.

- OFF

Even when a DTS 96/24 signal is input, it is played back at 48 kHz sampling frequencies.

Notes

- This parameter is valid only in the A.F.D. mode (page 29). In other sound fields, this parameter is always set to “96 OFF”.
- DTS 96/24 decoding is only valid in the A.F.D. mode (page 29). When the system is set to other sound fields, standard 48 kHz decoding is used.

■ SB XXXX (Surround back decoding mode)

You can also press SURR BACK DECODING to set the surround back decoding mode (page 33).

For details on each decoding mode, see page 34.

- OFF
- AUTO
- ON

Note

You can select the surround back decoding mode only when you use a sound field selected with the A.F.D. button except for the Dolby Pro Logic IIx mode.

■ A.V.SYNC. X (Time alignment)

- Y (Yes) (Delay time: 68 ms)

The audio output is delayed so that the time gap between the audio output and visual display is minimized.

- N (No) (Delay time: 0 ms)

The audio output is not delayed.

Notes

- This parameter is useful when you use a large LCD or plasma monitor or a projection TV.
- This parameter is valid only when you use a sound field selected with the 2CH or A.F.D. buttons.
- The parameter is not valid when PCM 96 kHz, DTS 96/24 or DTS 2048 signals are input or when the receiver is performing DTS-ES Matrix 6.1 decoding.

■ DEC. XXXX (Digital audio input decoding priority)

Lets you specify the input mode for the digital signal input to the DIGITAL IN jacks.

The initial setting is “DEC. AUTO” for VIDEO 2 and “DEC. PCM” for DVD and SA-CD/CD.

- AUTO

Automatically switches the input mode between DTS, Dolby Digital, or PCM.

- PCM

PCM signals are given priority (to prevent the interruption when playback starts). Even when other signals are input, the sound is output. However, this receiver cannot decode DTS-CD when set to “DEC. PCM”.

Note

When set to “DEC. AUTO” and the sound from the digital audio jacks (for CD, etc.) is interrupted when playback starts, set to “DEC. PCM”.

■ DUAL XXX (Digital broadcast language selection)

Lets you select the language you want to listen to during digital broadcast. This feature only functions for Dolby Digital sources.

- M/S (Main/Sub)
Sound of the main language will be output through the front left speaker and sound of the sub language will be output through the front right speaker simultaneously.
- M (Main)
Sound of the main language will be output.
- S (Sub)
Sound of the sub language will be output.
- M+S (Main + Sub)
Mixed sound of both the main and sub languages will be output.

■ COMP. V. A. (Component video input assignment)

Lets you assign the component video input to another visual input. For details, see "Assigning the component video input" on page 35.

■ NAME IN (Naming preset stations and inputs)

Lets you set the name of preset stations and inputs selected with input buttons. For details, see "Naming preset stations and inputs" on page 40.

Naming preset stations and inputs

You can enter a name of up to 8 characters for preset stations and inputs selected with input buttons, and display it in the receiver's display. Use the buttons on the receiver for the operation.

1 To index a preset station

Press **FM** or **AM** to select the **FM** or **AM** band, then tune in the preset station you want to create an index name for (page 26).

To index an input

Press the input button to select the input you want to create an index name for.

2 Press **MAIN MENU** repeatedly to select "<CUSTOM>".

3 Press **<** or **>** repeatedly to select "NAME IN".

4 Press **ENTER**.

The cursor flashes and you can select a character.

5 Use **<** or **>** and **+** or **-** to create an index name.

Press **+** or **-** repeatedly to select a character, then press **>** to move the cursor to the next position.

Tips

- You can select the character type as follows by pressing **+** or **-** repeatedly.
Alphabet (upper case) → Numbers → Symbols
- To enter a blank space, press **+** or **-** repeatedly until a blank space appears in the display.
- If you made a mistake, press **<** or **>** repeatedly until the character you want to change flashes, then press **+** or **-** repeatedly to select the correct character.

6 Press **ENTER** to store the index name.

Using the Sleep Timer

You can set the receiver to turn off automatically at a specified time.

Using the remote

1 Press **ALT** to light up the button.

2 Press **SLEEP** repeatedly while the power is on.

(HT-5950DP only)

Press **SLEEP** repeatedly while the power is on.

Each time you press **SLEEP**, the display changes cyclically as follows:

2-00-00 → 1-30-00 → 1-00-00 →
0-30-00 → OFF

While using Sleep Timer, "SLEEP" lights up in the display.

Tip

To check the remaining time before the receiver turns off, press **SLEEP** on the receiver (HT-5950DP only) or use the remote by pressing **ALT** to light up the button, then press **SLEEP**. The remaining time appears in the display. If you press **SLEEP** again, the sleep timer will be canceled.

Selecting the speaker system

You can select the front speaker system you want to use by pressing the following button. The selected speaker system appears in the display.

Model	Button	Indications
HT-9900M and HT-6900DP	SPEAKERS (OFF/A/B/A+B)	SP A SP B
HT-5950DP	SPEAKERS (ON/OFF)	SP

To turn off the speaker output, press the button repeatedly until the indications in the display turn off.

The speaker system

(HT-5950DP only)

- SP
The speakers connected to the SPEAKERS FRONT terminals.

(HT-9900M and HT-6900DP only)

- SP A
The speakers connected to the SPEAKERS FRONT A terminals.
- SP B
The speakers connected to the SPEAKERS FRONT B terminals.
- SP A and SP B
The speakers connected to both the SPEAKERS FRONT A and B terminals (parallel connection).

Recording

Before you begin, make sure you have connected all components properly.

Recording on an audio tape or MiniDisc

You can record on a cassette tape or MiniDisc using the receiver. See the operating instructions of your cassette deck or MD deck if you need help.

- 1 Select the component to be recorded.**
- 2 Prepare the component for playing.**
For example, insert a CD into the CD player.
- 3 Insert a blank tape or MD into the recording deck and adjust the recording level, if necessary.**
- 4 Start recording on the recording deck, then start playback on the playback component.**

Notes

- Sound adjustments do not affect the signal output from the MD/TAPE OUT jacks.
- The analog audio signals of the current input is output from the MD/TAPE OUT jacks.
- (HT-9900M and HT-6900DP only) The signals input to the MULTI CH IN jacks are not output from the MD/TAPE OUT jacks even when MULTI CH IN is being used. The analog audio signals of the current or previously used input are output.

Recording on a video tape

You can record from a VCR, a TV or a DVD player using the receiver. You can also add audio from a variety of audio sources when editing a video tape. See the operating instructions of your VCR or DVD player if you need help.

- 1 Select the program source to be recorded.**
- 2 Prepare the component for playing.**
For example, insert a video tape you want to record into VCR.
- 3 Insert a blank video tape into the VCR (VIDEO 1) for recording.**
- 4 Start recording on the recording VCR, then start playing the video tape or DVD you want to record.**

Tip

You can record the sound from any audio source onto a video tape while copying from a video tape or DVD. Locate the point where you want to start recording from another audio source, select the program source, then start playback. The audio from that source will be recorded onto the audio track of the video tape instead of the audio from the original medium. To resume audio recording from the original medium, select the video source again.

Notes

- You cannot record a digital audio signal using a component connected to the analog VIDEO 1 AUDIO OUT jacks.
- Make sure to make both digital and analog connections to the VIDEO 2 and DVD inputs. Analog recording is not possible if you make only digital connections.
- The analog audio signals of the current input are output from the VIDEO 1 AUDIO OUT jacks.
- (HT-9900M and HT-6900DP only) The signals input to the MULTI CH IN jacks are not output from VIDEO 1 AUDIO OUT jacks even when MULTI CH IN is being used. The analog audio signals of the current or previously used input are output.

Operations Using the Remote RM-AAP001

You can use the remote RM-AAP001 to operate the components in your system.

Before you use your remote

Inserting batteries into the remote

Insert R6 (size-AA) batteries with the + and - properly oriented in the battery compartment. When using the remote, point it at the remote sensor  on the receiver.

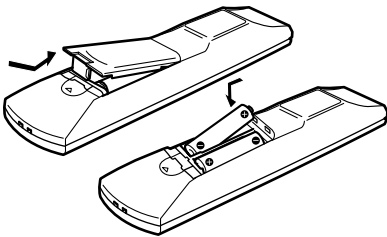

Tip

Under normal conditions, the batteries should last for about 6 months. When the remote no longer operates the receiver, replace all batteries with new ones.

Notes

- Do not leave the remote in an extremely hot or humid place.
- Do not use a new battery with an old one.
- Do not expose the remote sensor to direct sunlight or lighting apparatuses. Doing so may cause a malfunction.
- If you don't use the remote for an extended period of time, remove the batteries to avoid possible damage from battery leakage and corrosion.

Remote button description

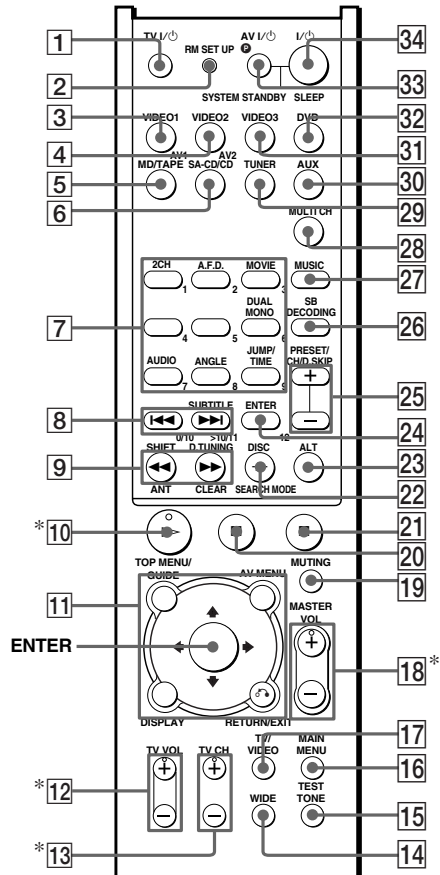

* The , TV VOL +, TV CH + and MASTER VOL + buttons have a tactile dot. Use the tactile dot as a reference when operating the receiver and other audio/video components.

The tables below show the settings of each button.

Remote Button	Operations	Function
A.F.D. 7	Receiver	Selects the decoding mode for audio sound.
ALT 23	Remote	When ALT button lights up, it changes the remote key function to activate those buttons with orange printing.
ANGLE 7	DVD player/ Blu-ray disc recorder	Selects viewing angle or changes the angles.
ANT 9	VCR/ Satellite tuner	Selects output signal from the antenna terminal: TV signal or VCR program.
AUDIO 7	TV/VCR/ DVD player/ Satellite tuner/ Blu-ray disc recorder/ Hard disc recorder/PSX	Changes the sound to Multiplex, Bilingual or Multi channel TV Sound.
AUX 30	Receiver	To listen to an audio equipment.
AV MENU 11	VCR/ Satellite tuner/ DVD player/ Blu-ray disc recorder/ Hard disc recorder/PSX	Displays menu.
AV1 3 and AV2 4	Remote	Selects the command mode of the remote.
AV I/⏻ 33	TV/VCR/ CD player/ VCD player/ LD player/ DVD player/ MD deck/ DAT deck/ Blu-ray disc recorder/ Hard disc recorder/PSX/ Satellite tuner	Turns the audio and video components on or off.

Remote Button	Operations	Function
CLEAR 9	CD player/ DVD player/ Blu-ray disc recorder/PSX/ Satellite tuner	Clears a mistake when you press the incorrect numeric buttons or returns to continuous playback etc.
DISC 22	CD player/ VCD player	Selects a disc directly (multi-disc changer only).
DISPLAY 11	TV/VCR/ VCD player/ LD player/ DVD player/ Receiver/ CD player/ MD deck/ Blu-ray disc recorder/ Hard disc recorder/PSX/ Satellite tuner	Selects information displayed on the TV screen.
D.TUNING 9	Receiver	Enters direct tuning mode.
DUAL MONO 7	Receiver	Selects the language you want during digital broadcast.
DVD 32	Receiver	To watch DVD.
ENTER 24	TV/VCR/ Satellite tuner/ LD player/ MD deck/ DAT deck/ Tape deck/ Blu-ray disc recorder/ Hard disc recorder/PSX	After selecting a channel, disc or track using the numeric buttons, press to enter the value.
ENTER 11	Receiver/ VCR/ Satellite tuner/ DVD player	Enters the selection.
JUMP/TIME 7	Satellite tuner/ TV/ Blu-ray disc recorder	Toggles between the previous and the current channels.
	CD player/ MD deck/ VCD player/ DVD player	Shows the time or displays the playing time of disc, etc.
MAIN MENU 16	Receiver	Selects the menu of the receiver.





Remote Button	Operations	Function
MASTER VOL +/- 18	Receiver	Adjusts the master volume of the receiver.
MD/TAPE 5	Receiver	To listen to Minidisc or audio tape.
MOVIE 7	Receiver	Selects the pre-programmed sound fields for movie.
MULTI CH 28	Receiver	Selects MULTI CH IN source.
MUSIC 27	Receiver	Selects the pre-programmed sound fields for music.
MUTING 19	Receiver	Mutes the sound from the receiver.
PRESET/ CH/	Receiver	Selects preset stations.
D.SKIP +/- 25	TV/VCR/ Satellite tuner/ Blu-ray disc recorder/ Hard disc recorder	Selects preset channels.
	CD player/ VCD player/ DVD player/ MD deck/ LD player	Skips discs (multi-disc changer only).
RETURN/ EXIT 11	VCD player/ LD player/ DVD player	Returns to the previous menu.
	Satellite tuner	Exits the menu.
RM SET UP 2	Remote	To set up the remote.
SA-CD/CD 6	Receiver	To listen to Super Audio CD or compact disc.
SB DECODING 26	Receiver	Selects the surround back decoding modes.
SEARCH MODE 22	DVD player	Selects searching mode. Press to select the unit for search (track, index, etc.)
SHIFT 9	Receiver	Selects a memory page for presetting radio stations or tuning to preset stations.

Remote Button	Operations	Function
SLEEP 34	Receiver	Activates the sleep function and the duration which the receiver turns off automatically.
SUBTITLE 8	DVD player	Changes the subtitles.
SYSTEM STANDBY (Press AV I/⏻ 33 and I/⏻ 34 at the same time)	Receiver/ TV/VCR/ Satellite tuner/ CD player/ VCD player/ LD player/ DVD player/ MD deck/ DAT deck	Turns off the receiver and other Sony audio/ video components.
TEST TONE 15	Receiver	Outputs test tone.
TOP MENU/ GUIDE 11	DVD player/ Satellite tuner/ Blu-ray disc recorder/ Hard disc recorder/PSX	Displays DVD title. Displays guide menu.
TUNER 29	Receiver	To listen to radio programs.
TV CH +/- 13	TV	Selects preset TV channels.
TV/VIDEO 17	TV	Selects input signal: TV input or video input.
TV VOL +/- 12	TV	Adjusts the volume of the TV.
TV I/⏻ 1	TV	Turns the TV on or off.
VIDEO1 3	Receiver	To watch VCR. (VTR mode 3)
VIDEO2 4	Receiver	To watch VCR. (VTR mode 1)
VIDEO3 31	Receiver	To watch VCR. (VTR mode 2)
WIDE 14	TV	Selects the wide picture mode.

continued

Remote Button	Operations	Function
1-9 7 and 0/10 8	Receiver	Use with SHIFT to preset radio station or tuning to preset stations and with D.TUNING for direct tuning.
	CD player/ VCD player/ LD player/ DVD player/ MD deck/ DAT deck/ Tape deck	Selects track numbers. 0/10 selects track 10.
	TV/VCR/ Satellite tuner/ Blu-ray disc recorder/ Hard disc recorder/PSX	Selects channel numbers.
2CH 7	Receiver	Selects 2CH STEREO mode.
>10/11 8	CD player/ VCD player/ LD player/ MD deck/ Tape deck/ TV/VCR/ Blu-ray disc recorder/ Hard disc recorder/PSX/ Satellite tuner	Selects track numbers over 10.
-/-- 22	TV/ Blu-ray disc recorder/ Hard disc recorder/PSX/ Satellite tuner	Selects the channel entry mode, either one or two digit.
I/⏻ 34	Receiver	Turns the receiver on or off.
⏮/⏭ 8	VCR/ CD player/ VCD player/ LD player/ DVD player/ MD deck/ DAT deck/ Tape deck/ Blu-ray disc recorder/ Hard disc recorder/PSX	Skips tracks.

Remote Button	Operations	Function
⏮/⏭ 9	CD player/ VCD player/ DVD player/ LD player/ MD deck/ Blu-ray disc recorder/ Hard disc recorder/PSX	Searches tracks in the forward or backward direction.
▶ 10	VCR/ CD player/ VCD player/ LD player/ DVD player/ MD deck/ DAT deck/ Tape deck/ Blu-ray disc recorder/ Hard disc recorder/PSX	Starts playback.
⏸ 20	VCR/ CD player/ VCD player/ LD player/ DVD player/ MD deck/ DAT deck/ Tape deck/ Blu-ray disc recorder/ Hard disc recorder/PSX	Pauses playback or recording. (Also starts recording with components in recording standby.)
■ 21	VCR/ CD player/ VCD player/ LD player/ DVD player/ MD deck/ DAT deck/ Tape deck/ Blu-ray disc recorder/ Hard disc recorder/PSX	Stops playback.

Remote Button	Operations	Function
 11	VCD player/ LD player/ DVD player/ Blu-ray disc recorder/ Hard disc recorder/PSX/ Satellite tuner	Returns to the previous menu or exits the menu.
 11	Receiver	Selects a menu item.
 11	Receiver	Adjusts or changes the setting.
 11	VCR/ DVD player/ Blu-ray disc recorder/ Hard disc recorder/PSX/ Satellite tuner	Selects a menu item.

Notes

- The AUX, MULTI CH* and 12 buttons on the remote are not available for receiver operation.
- Some functions explained in this section may not work depending on the model.
- The above explanation is intended to serve as an example only. Therefore, depending on the component the above operation may not be possible or may operate differently than described.
- When you press input buttons (VIDEO1, VIDEO2, VIDEO3 or DVD), the input mode of the TV might not switch to the corresponding input mode that you want. In this case, press TV/VIDEO button to switch the input mode of the TV.
- To activate the buttons with orange printing, press ALT first before pressing the buttons.

* HT-5950DP only

Selecting the command mode of the remote

Set the remote command mode using the RM SET UP button and the remote command mode buttons.

Selecting the command mode

You can switch the command mode (AV1 and AV2) of the remote. If the command mode of the receiver and the remote is different, you cannot use the remote to operate the receiver. To change the command mode of the receiver, see page 54.

Press AV1 (or AV2) while holding down RM SET UP.



The indicator flashes once (twice for AV2) , then the command mode switches.

To check the command mode of the remote

Press RM SET UP. You can check the remote by the indicator.

Mode	Indicator flashes
AV1	once
AV2	twice

To reset the remote to factory settings

Press ,  and MASTER VOL – at the same time.

The indicator flashes 3 times, then goes off.

Programming the remote

You can program the remote to control non-Sony components by changing the code. Once the control signals have been memorized, you can use those components as part of your system.

Furthermore, you can also program the remote for Sony components that the remote is unable to control. Note that the remote can only control components that accept infrared wireless control signals.

1 Press AV I/⏻ while holding down RM SET UP.

The indicator lights up.

2 Press the input button (including TV I/⏻) for the component you want to control.

For example, if you are going to control a CD player, press SA-CD/CD.

3 Press the numeric buttons to enter the numeric code (or one of the codes if more than one code exists) corresponding to the component and the maker of the component you want to control.

See the tables on pages 49–51 for information on the numeric code(s) corresponding to the component and the maker of the component (the first digit and the last two digits of the numeric code correspond to the category and the maker's code respectively).

4 Press ENTER.

Once the numeric code has been verified, the indicator slowly flashes twice and the remote automatically exits the programming mode.

5 Repeat steps 1 to 4 to control other components.

To cancel programming

Press RM SET UP during any step. The remote automatically exits the programming mode.

To activate the input after programming

Press the programmed button to activate the input you want.

If programming is unsuccessful, check the following:

- If the indicator does not light up in step 1, the batteries are weak. Replace both batteries.
- If the indicator flashes 4 times in quick succession while entering the numeric code, an error has occurred. Start again from step 1.

Notes

- The indicator turns off while a valid button is pressed.
- In step 2, if several input buttons are pressed, only the last pressed button is valid.
- In step 2, if you press TV I/⏻, only TV VOL +/-, TV CH +/-, TV/VIDEO and WIDE buttons are reprogrammed.
- In step 3, if an input button is pressed, the new input is selected and the programming procedure returns to the beginning of step 3.
- For the numeric codes, only the first three numbers entered are valid.

To clear the memory of the remote

To clear all programmed and learned signals, do the following to reset the remote to factory settings.

Press I/⏻, AV I/⏻ and MASTER VOL – at the same time.

The indicator flashes 3 times, then goes off.

The numeric codes corresponding to the component and the maker of the component

Use the numeric codes in the tables below to control non-Sony components and also Sony components that the remote is normally unable to control. Since the remote signal that a component accepts differs depending on the model and year of the component, more than one numeric code may be assigned to a component. If you fail to program your remote using one of the codes, try using other codes.

Notes

- The numeric codes are based on the latest information available for each brand. There is a chance, however, that your component will not respond to some or all of the codes.
- All of the input buttons on this remote may not be available when used with your particular component.

To control a CD player

Maker	Code(s)
SONY	101, 102, 103
DENON	104, 123
JVC	105, 106, 107
KENWOOD	108, 109, 110
MAGNAVOX	111, 116
MARANTZ	116
ONKYO	112, 113, 114
PANASONIC	115
PHILIPS	116
PIONEER	117
TECHNICS	115, 118, 119
YAMAHA	120, 121, 122

To control a DAT deck

Maker	Code(s)
SONY	203
PIONEER	219

To control an MD deck

Maker	Code(s)
SONY	301
DENON	302
JVC	303
KENWOOD	304

To control a tape deck

Maker	Code(s)
SONY	201, 202
DENON	204, 205
KENWOOD	206, 207, 208, 209
NAKAMICHI	210
PANASONIC	216
PHILIPS	211, 212
PIONEER	213, 214
TECHNICS	215, 216
YAMAHA	217, 218

To control an LD player

Maker	Code(s)
SONY	601, 602, 603
PIONEER	606

To control a video CD player

Maker	Code(s)
SONY	605

continued

To control a VCR

Maker	Code(s)
SONY	701, 702, 703, 704, 705, 706
AIWA*	710, 750, 757, 758
AKAI	707, 708, 709, 759
BLAUPUNKT	740
EMERSON	711, 712, 713, 714, 715, 716, 750
FISHER	717, 718, 719, 720
GENERAL ELECTRIC	721, 722, 730
GOLDSTAR	723, 753
GRUNDIG	724
HITACHI	722, 725, 729, 741
ITT/NOKIA	717
JVC	726, 727, 728, 736
MAGNAVOX	730, 731, 738
MITSUBISHI/MGA	732, 733, 734, 735
NEC	736
PANASONIC	729, 730, 737, 738, 739, 740
PHILIPS	729, 730, 731
PIONEER	729
RCA/PROSCAN	722, 729, 730, 731, 741, 747
SAMSUNG	742, 743, 744, 745
SANYO	717, 720, 746
SHARP	748, 749
TELEFUNKEN	751, 752
TOSHIBA	747, 755, 756
ZENITH	754

* If an AIWA VCR does not work even though you enter the code for AIWA, enter the code for Sony instead.

To control a DVD player

Maker	Code(s)
SONY	401, 402, 403
PANASONIC	406, 408
PHILIPS	407
PIONEER	409
TOSHIBA	404
DENON	405

To control a TV

Maker	Code(s)
SONY	501, 502
DAEWOO	504, 505, 506, 507, 515, 544
FISHER	508
GOLDSTAR	503, 511, 512, 515, 534, 544
GRUNDIG	517, 534
HITACHI	513, 514, 515, 544
ITT/NOKIA	521, 522
JVC	516
MAGNAVOX	503, 518, 544
MITSUBISHI/MGA	503, 519, 544
NEC	503, 520, 544
PANASONIC	509, 524
PHILIPS	515, 518
PIONEER	509, 525, 526, 540
RCA/PROSCAN	510, 527, 528, 529, 544
SAMSUNG	503, 515, 531, 532, 533, 534, 544
SANYO	508, 545, 546, 547
SHARP	535
TELEFUNKEN	523, 536, 537, 538
THOMSON	530, 537, 539
TOSHIBA	535, 540, 541
ZENITH	542, 543

To control a satellite tuner or cable box

Maker	Code(s)
SONY	801, 802, 803, 804
JERROLD/G.I.	806, 807, 808, 809, 810, 811, 812, 813, 814
PANASONIC	818
RCA	805, 819
S. ATLANTA	815, 816, 817

To control a tuner

Maker	Code(s)
SONY	002, 003, 004, 005

To control a hard disc recorder

Maker	Code(s)
SONY	307, 308, 309

To control a Blu-ray disc recorder

Maker	Code(s)
SONY	310, 311, 312

To control a PSX

Maker	Code(s)
SONY	313, 314, 315

Additional Information

Precautions

On safety

Should any solid object or liquid fall into the cabinet, unplug the receiver and have it checked by qualified personnel before operating it any further.

On power sources

- Before operating the receiver, check that the operating voltage is identical with your local power supply. The operating voltage is indicated on the nameplate at the rear of the receiver.
- The receiver is not disconnected from the AC power source (mains) as long as it is connected to the wall outlet, even if the receiver itself has been turned off.
- If you are not going to use the receiver for a long time, be sure to disconnect the receiver from the wall outlet. To disconnect the AC power cord, grasp the plug itself; never pull the cord.
- One blade of the plug is wider than the other for the purpose of safety and will fit into the wall outlet only one way. If you are unable to insert the plug fully into the outlet, contact your dealer.
- AC power cord must be changed only at the qualified service shop.

On heat buildup

Although the receiver heats up during operation, this is not a malfunction. If you continuously use this receiver at a large volume, the cabinet temperature of the top, side and bottom rises considerably. To avoid burning yourself, do not touch the cabinet.

On placement

- Place the receiver in a location with adequate ventilation to prevent heat buildup and prolong the life of the receiver.
- Do not place the receiver near heat sources, or in a place subject to direct sunlight, excessive dust or mechanical shock.
- Do not place anything on top of the cabinet that might block the ventilation holes and cause malfunctions.
- Use caution when placing the receiver on surfaces that have been specially treated (with wax, oil, polish, etc.) as staining or discoloration of the surface may result.

On operation

Before connecting other components, be sure to turn off and unplug the receiver.

If you encounter color irregularity on a nearby TV screen

The front and center speakers and the sub woofer are magnetically shielded to allow it to be installed near a TV set. However, color irregularities may still be observed on certain types of TV sets. As the surround speakers and surround back speaker are not magnetically shielded, we recommend that you place them slightly further away from a TV set (page 15).

If color irregularity is observed...

Turn off the TV set once, then turn it on again after 15 to 30 minutes.

If color irregularity is observed again...

Place the speaker further away from the TV set.

If howling occurs

Reposition the speakers or turn down the volume on the receiver.

On cleaning

Clean the cabinet, panel and controls with a soft cloth slightly moistened with a mild detergent solution. Do not use any type of abrasive pad, scouring powder or solvent such as alcohol or benzine.

If you have any question or problem concerning your receiver, please consult your nearest Sony dealer.

Troubleshooting

If you experience any of the following difficulties while using the receiver, use this troubleshooting guide to help you remedy the problem.

There is no sound or only a very low-level sound no matter which component is selected.

- Check that the speakers and components are connected correctly and securely.
- Check that both the receiver and all components are turned on.
- Check that you have selected the correct component on the receiver.
- Check that MASTER VOLUME -/+ is not set at "VOL MIN".
- Check that the SPEAKERS (OFF/A/B/A+B)* or SPEAKERS (ON/OFF)** is not set to off (page 41).
- Check that the headphones are not connected.
- Press MUTING on the remote to cancel the muting function.

There is no sound from a specific component.

- Check that the component is connected correctly to the audio input jacks for that component.
- Check that the cord(s) used for the connection is (are) fully inserted into the jacks on both the receiver and the component.
- Check that you have selected the correct component on the receiver.

There is no sound from one of the front speakers.

- Connect a pair of headphones to the PHONES jack to verify that sound is output from the headphones. If only one channel is output from the headphones, the component may not be connected to the receiver correctly. Check that all the cords are fully inserted into the jacks on both the receiver and the component. If both channels are output from the headphones, the front speaker may not be connected to the receiver correctly. Check the connection of the front speaker which is not outputting any sound.

There is no sound from analog 2 channel sources.

- Check that the INPUT MODE is not set to "COAX IN" or "OPT IN" (page 35).
- Check that you have not selected MULTI CH IN function.*

There is no sound from digital sources (from COAXIAL or OPTICAL input jack).

- Check that the INPUT MODE is not set to "ANALOG" (page 35). Check that the INPUT MODE is not set to "COAX IN" for the sources from OPTICAL input jack, or set to "OPT IN" for the sources from COAXIAL input jack.
- Check that you have not selected MULTI CH IN function.*

The left and right sounds are unbalanced or reversed.

- Check that the speakers and components are connected correctly and securely.
- Adjust balance parameters in the LEVEL menu.

There is severe hum or noise.

- Check that the speakers and components are connected securely.
- Check that the connecting cords are away from a transformer or motor, and at least 3 meters (10 feet) away from a TV set or fluorescent light.
- Move your audio components away from the TV.
- The plugs and jacks are dirty. Wipe them with a cloth slightly moistened with alcohol.

There is no sound from the surround back speakers.

- Some discs have no Dolby Digital EX flag even though the packages have Dolby Digital EX logos. In this case, select "SB ON" (page 38).

There is no sound or only a very low-level sound is heard from the center/surround/surround back speakers.

- Select the CINEMA STUDIO EX mode (page 31).
- Adjust the speaker level (page 22).

There is no sound from the sub woofer.

- Check that the sub woofer is connected correctly and securely.

The surround effect cannot be obtained.

- Make sure the sound field function is on (press MOVIE or MUSIC).
- Sound fields do not function for the signals with a sampling frequency of more than 48 kHz.

* HT-9900M and HT-6900DP only.

** HT-5950DP only.

Dolby Digital or DTS multi channel sound is not reproduced.

- Check that the playing DVD, etc. is recorded in Dolby Digital or DTS format.
- When connecting the DVD player, etc. to the digital input jacks of this receiver, check the audio setting (settings for the audio output) of the connected component.

Recording cannot be done.

- Check that the components are connected correctly.
- Select the source component with input buttons.

The FM reception is poor.

- Use a 75-ohm coaxial cable (not supplied) to connect the receiver to an outdoor FM antenna as shown below. If you connect the receiver to an outdoor antenna, ground it against lightning. To prevent a gas explosion, do not connect the ground wire to a gas pipe.

Outdoor FM antenna

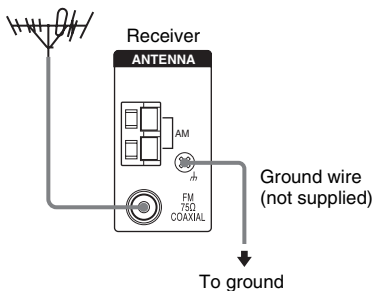

Radio stations cannot be tuned in.



- Check that the antennas are connected securely. Adjust the antennas and connect an external antenna if necessary.
- The signal strength of the stations is too weak (when tuning in with automatic tuning). Use direct tuning.
- Make sure you set the tuning interval correctly (when tuning in AM stations with direct tuning).
- No stations have been preset or the preset stations have been cleared (when tuning by scanning preset stations). Preset the stations (page 25).
- Press DISPLAY repeatedly so that the frequency appears in the display.

There is no picture or an unclear picture appears on the TV screen or monitor.

- Select the appropriate input on the receiver.
- Set your TV to the appropriate input mode.
- Move your audio components away from the TV.

Remote control

The remote does not function.

- The AUX, MULTI CH** and 12 buttons on the remote are not available for receiver operation.
- Point the remote at the remote sensor  on the receiver.
- Remove any obstacles in the path between the remote and the receiver.
- Replace all the batteries in the remote with new ones, if they are weak.
- Check if the command modes of the receiver and the remote is the same. If the command mode of the receiver and the remote is different, you cannot operate the receiver with the remote. To switch the command mode of the receiver, press I/⏻ to turn off the power. Then, press I/⏻ while pressing ENTER. Each time you press I/⏻, the command mode switches between "C.MODE.AV2" and "C.MODE.AV1". (The initial setting is "C.MODE.AV2".)
- Make sure you select the correct input on the remote.
- To activate the buttons with orange printing, press ALT first before pressing the buttons.
- Before you use the  button for receiver operation, press MAIN MENU. To operate other components, press TOP MENU/GUIDE or AV MENU after pressing the input button.

** HT-5950DP only.

Error messages

If there is a malfunction, the display shows a message. You can check the condition of the receiver by the message. Refer to the following table to solve the problem.

DEC. ERROR

Appears when the signal which the receiver cannot decode (ex. DTS-CD) is input when "DEC. XXXX" in the CUSTOMIZE menu is set to "DEC. PCM". Set to "DEC. AUTO".

PROTECT

Irregular current is output from the speakers. The receiver will automatically turn off after a few seconds. Check the speaker connection and turn on the power again. If this problem persists, consult your nearest Sony dealer.

If you are unable to remedy the problem using the troubleshooting guide

Clearing the receiver's memory may remedy the problem (page 18). However, note that all memorized settings will be reset to their factory settings and you will have to readjust all settings on the receiver.

If the problem persist

Consult your nearest Sony dealer.

Reference sections for clearing the receiver's memory

To clear	See
All memorized settings	page 18
Customized sound fields	page 37

Specifications

AUDIO POWER SPECIFICATIONS

POWER OUTPUT AND TOTAL HARMONIC DISTORTION:

(Model of area code U only)

With 6 ohm loads, both channels driven, from 120 – 20,000 Hz; rated 90 watts (STR-K9900P)/ 70 watts (STR-K5900P) per channel minimum RMS power, with no more than 0.7% total harmonic distortion from 250 milliwatts to rated output.

Amplifier section

Power Output¹⁾

Model of area code U

(6 ohms 1 kHz, THD 10%)

STR-K9900P:	FRONT ²⁾ : 140 W/ch CENTER ²⁾ : 140 W SURR ²⁾ : 140 W/ch SURR BACK ²⁾ : 140 W
STR-K5900P:	FRONT ²⁾ : 110 W/ch CENTER ²⁾ : 110 W SURR ²⁾ : 110 W/ch SURR BACK ²⁾ : 110 W

Model of area code CA

(6 ohms 1 kHz, THD 0.7%)

STR-K5900P:	FRONT ²⁾ : 70 W/ch CENTER ²⁾ : 70 W SURR ²⁾ : 70 W/ch SURR BACK ²⁾ : 70 W
-------------	--

(6 ohms 1 kHz, THD 10%)

STR-K5900P:	FRONT ²⁾ : 110 W/ch CENTER ²⁾ : 110 W SURR ²⁾ : 110 W/ch SURR BACK ²⁾ : 110 W
-------------	--

1) Measured under the following conditions:

Area code	Power requirements
U, CA	120 V AC, 60 Hz

2) Depending on the sound field settings and the source, there may be no sound output.

continued

Inputs (Analog)

MULTI CH IN*, SA-CD/CD, MD/TAPE, DVD, VIDEO 1, 2, 3	Sensitivity: 800 mV Impedance: 50 k ohms
---	---

* HT-9900M and HT-6900DP only.

Inputs (Digital)

DVD (Coaxial)	Sensitivity: – Impedance: 75 ohms
VIDEO 2, SA-CD/CD (Optical)	Sensitivity: – Impedance: –

Outputs (Analog)

MD/TAPE (OUT), VIDEO 1 (AUDIO OUT)	Voltage: 800 mV Impedance: 10 k ohms
SUB WOOFER	Voltage: 2 V Impedance: 1 k ohm

Reproduction frequency range:
28 – 20,000 Hz

Tone

Gain levels	±6 dB, 1 dB step
-------------	------------------

FM tuner section

Tuning range	87.5 - 108.0 MHz
Antenna	FM wire antenna
Antenna terminals	75 ohms, unbalanced
Intermediate frequency	10.7 MHz

AM tuner section

Tuning range	
Model of area code U, CA	
With 10-kHz tuning scale:	530 – 1,710 kHz ³⁾
With 9-kHz tuning scale:	531 – 1,710 kHz ³⁾
Antenna	Loop antenna
Intermediate frequency	450 kHz

- 3) You can change the AM tuning scale to 9 kHz or 10 kHz. After tuning in any AM station, turn off the receiver. While holding down PRESET TUNING + or TUNING +, press I/⏏. All preset stations will be erased when you change the tuning scale. To reset the scale to 10 kHz (or 9 kHz), repeat the procedure.

Video section

Inputs/Outputs	
Video:	1 Vp-p, 75 ohms
COMPONENT VIDEO:	Y: 1 Vp-p, 75 ohms Pb/Cb/B-Y: 0.7 Vp-p, 75 ohms Pr/Cr/R-Y: 0.7 Vp-p, 75 ohms 80 MHz HD Pass Through

General

Power requirements

Area code	Power requirements
U, CA	120 V AC, 60 Hz

Power consumption

Area code	Power consumption
U (STR-K9900P)	190 W
U (STR-K5900P)	140 W
CA	200 VA

Power consumption (during standby mode)
0.2 W

Dimensions (w/h/d) (Approx.)

430 × 157.5 × 310 mm
(16 7/8 × 6 2/8 × 12 2/8
inches) including
projecting parts and
controls

Mass (Approx.)
8.0 kg (17 lb 11 oz)

Speaker section

HT-9900M and HT-6900DP only

Front speakers (SS-MSP69L/SS-MSP69R)

Center speaker (SS-CNP69)

**Surround speakers (SS-MSP69SL/
SS-MSP69SR)**

Surround back speaker (SS-MSP69SB)

Front speakers	2-way, magnetically shielded
Center speaker	Full range, magnetically shielded
Surround/surround back speakers	Full range
Speaker units	
Front speakers	80 mm cone type, 25 mm balance dome
Center speaker	57 mm cone type × 2
Surround/surround back speakers	80 mm cone type
Enclosure type	Bass reflex
Rated Impedance	6 ohms

Dimension (w/h/d) (Approx.)	
Front speakers	130 × 220 × 120 mm (5 1/8 × 8 5/8 × 4 6/8 inches)
Center speaker	245 × 108 × 120 mm (9 5/8 × 4 2/8 × 4 6/8 inches)
Surround/surround back speakers	115 × 168 × 120 mm (4 4/8 × 6 5/8 × 4 6/8 inches)
Mass (Approx.)	
Front speakers	1.7 kg (3 lb 12 oz)
Center speaker	1.6 kg (3 lb 9 oz)
Surround/surround back speakers	1.1 kg (2 lb 7 oz)

HT-5950DP only

**Front speakers (SS-MSP67L/
SS-MSP67R)**

Center speaker (SS-CNP67)

**Surround speakers (SS-MSP67SL/
SS-MSP67SR)**

Surround back speaker (SS-MSP67SB)

Front/center speakers Full range, magnetically shielded

Surround/surround back speakers Full range

Speaker units 70 mm cone type

Enclosure type Closed type

Rated Impedance 6 ohms

Dimension (w/h/d) (Approx.)

Front/surround/surround back speakers
91 × 96 × 102 mm
(3 1/2 × 3 3/4 × 4 inches)

Center speaker
155 × 96 × 102 mm
(6 1/8 × 3 3/4 × 4 inches)

Mass (Approx.)

Front speakers 0.65 kg (1 lb 8 oz)

Center speaker 0.75 kg (1 lb 12 oz)

Surround/surround back speakers
0.6 kg (1 lb 6 oz)

**HT-9900M and HT-6900DP only
(SA-WMSP69)**

HT-5950DP only (SA-WMSP87)

AUDIO POWER SPECIFICATIONS

POWER OUTPUT AND TOTAL HARMONIC DISTORTION:

With 6 ohm loads, from 28 – 200 Hz; rated 120 watts (SA-WMSP69)/120 watts (SA-WMSP87), minimum RMS power, with no more than 0.8% total harmonic distortion from 250 milliwatts to rated output.

Speaker system	Active subwoofer, magnetically shielded
Speaker unit	
SA-WMSP69	250 mm cone type
SA-WMSP87	200 mm cone type
Enclosure type	Acoustically loaded bass reflex
RMS output:	
SA-WMSP69	160 W (5 ohms, 100 Hz, THD 10%)
SA-WMSP87	155 W (5 ohms, 100 Hz, THD 10%)
Input	LINE IN (input pin jacks)
Power requirements	
Area code	Power requirements
U, CA	120 V AC, 60 Hz

Power consumption

SA-WMSP69 120 W

SA-WMSP87 95 W

Dimensions (w/h/d) (Approx.)

SA-WMSP69
337 × 410 × 366 mm
(13 1/4 × 16 1/8 × 14 1/2 inches) including front panel

SA-WMSP87
270 × 325 × 398 mm
(10 5/8 × 12 3/4 × 15 5/8 inches) including front panel

Mass (Approx.)

SA-WMSP69 13.0 kg (28 lb 11 oz)

SA-WMSP87 9.0 kg (19 lb 14 oz)

Supplied accessories

FM wire antenna (1)

AM loop antenna (1)

Speaker connecting cord, long (3)

Speaker connecting cord, short (3)

Monaural connecting cord (1)

Coaxial digital cord (1)

Foot pads (speakers) (24)

Foot pads (subwoofer) (4)

Remote commander RM-AAP001 (1)

R6 (size-AA) batteries (2)

Front speakers (2)

- HT-9900M/HT-6900DP (SS-MSP69L/
SS-MSP69R)

- HT-5950DP (SS-MSP67L/SS-MSP67R)

Center speaker (1)

- HT-9900M/HT-6900DP (SS-CNP69)

- HT-5950DP (SS-CNP67)

Surround speakers (2)

- HT-9900M/HT-6900DP (SS-MSP69SL/
SS-MSP69SR)

- HT-5950DP (SS-MSP67SL/SS-MSP67SR)

Surround back speaker (1)

- HT-9900M/HT-6900DP (SS-MSP69SB)

- HT-5950DP (SS-MSP67SB)

Sub woofer (1)

- HT-9900M/HT-6900DP (SA-WMSP69)

- HT-5950DP (SA-WMSP87)

For details on the area code of the component you are using, see page 3.
--

Design and specifications are subject to change without notice.

Index

A

Adjusting

- CUSTOMIZE parameters 38
- LEVEL parameters 36
- speaker levels and balance 22
- SPEAKER SET UP parameters 19
- TONE parameters 37

Automatic tuning 24

C

Changing

- display 26

Clearing receiver's memory 18

CUSTOMIZE menu 38

D

Digital Cinema Sound 31

Direct tuning 25

Dual Mono 39

Dubbing. *See* Recording

E

Editing. *See* Recording

I

Indexing. *See* Naming

L

Labeling. *See* Naming

LEVEL menu 36

N

Naming 40

P

Preset stations

- how to 25
- how to tune 26

R

Recording

- on a video tape 42
- on an audio tape or MD 41

S

Selecting

- component 23
- sound field 31–33
- speaker system 41

Sleep Timer 40

Sound field

- customizing 36
- pre-programmed 31–32
- resetting 37
- selecting 31–32

SPEAKER SET UP menu 19

Speakers

- adjusting speaker levels and balance 22
- connection 15
- placement 15

Sub woofer phase polarity 20

Supplied accessories 58

T

Test tone 22

TONE menu 37

Tuning

- automatically 24
- directly 25
- to preset stations 25

Free Manuals Download Website

<http://myh66.com>

<http://usermanuals.us>

<http://www.somanuals.com>

<http://www.4manuals.cc>

<http://www.manual-lib.com>

<http://www.404manual.com>

<http://www.luxmanual.com>

<http://aubethermostatmanual.com>

Golf course search by state

<http://golfingnear.com>

Email search by domain

<http://emailbydomain.com>

Auto manuals search

<http://auto.somanuals.com>

TV manuals search

<http://tv.somanuals.com>