

Micro HI-FI Component System

Operating Instructions

Owner's Record

The model and serial numbers are located on the rear of the unit. Record these numbers in the space provided below. Refer to them whenever you call upon your Sony dealer regarding this product.

Model No. _____ Serial No. _____



ATRAC



CMT-U1BT

© 2006 Sony Corporation

WARNING

To reduce the risk of fire or electric shock, do not expose this apparatus to rain or moisture.

CAUTION

The use of optical instruments with this product will increase eye hazard.

Notice for the customers in the U.S.A

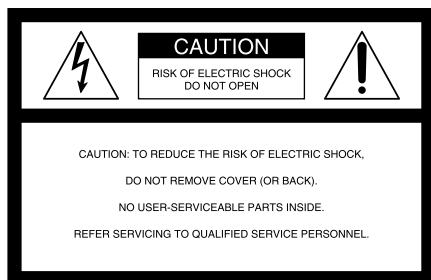

This symbol is intended to alert the user to the presence of uninsulated “dangerous voltage” within the product’s enclosure that may be of sufficient magnitude to constitute a risk of electric shock to persons.



This symbol is intended to alert the user to the presence of important operating and maintenance (servicing) instructions in the literature accompanying the appliance.

WARNING

This equipment has been tested and found to comply with the limits for a Class B digital device, pursuant to Part 15 of the FCC Rules. These limits are designed to provide reasonable protection against harmful interference in a residential installation. This equipment generates, uses, and can radiate radio frequency energy and, if not installed and used in accordance with the instructions, may cause harmful interference to radio communications. However, there is no guarantee that interference will not occur in a particular installation. If this equipment does cause harmful interference to radio or television reception, which can be determined by turning the equipment off and on, the user is encouraged to try to correct the interference by one or more of the following measures:

- Reorient or relocate the receiving antenna.
- Increase the separation between the equipment and receiver.
- Connect the equipment into an outlet on a circuit different from that to which the receiver is connected.
- Consult the dealer or an experienced radio/TV technician for help.

This device complies with Part 15 of the FCC Rules. Operation is subject to the following two conditions:

(1) this device may not cause harmful interference, and (2) this device must accept any interference received, including interference that may cause undesired operation.

You are cautioned that any changes or modifications not expressly approved in this manual could void your authority to operate this equipment.

This equipment must not be co-located or operated in conjunction with any other antenna or transmitter.

This equipment complies with FCC radiation exposure limits set forth for uncontrolled equipment and meets the FCC radio frequency (RF) Exposure Guidelines in Supplement C to OET65.

This equipment has a very low RF energy level that is deemed to comply with FCC radio frequency (RF) Exposure Guidelines in Supplement C to OET65 without maximum permissive exposure evaluation (MPE). But it is desirable that it should be installed and operated with at least 20cm and more between the radiator and person’s body (excluding extremities: hands, wrists, feet and legs).

Note to CATV system installer:

This reminder is provided to call the CATV system installer's attention to Article 820-40 of the NEC that provides guidelines for proper grounding and, in particular, specifies that the cable ground shall be connected to the grounding system of the building, as close to the point of cable entry as practical.

Notice for the customers in Canada

Operation is subject to the following two conditions: (1) this device may not cause interference, and (2) this device must accept any interference, including interference that may cause undesired operation of this device.

This equipment complies with IC radiation exposure limits set forth for uncontrolled equipment and meets the RSS-102 of the IC radio frequency (RF) Exposure rules.

This equipment has a very low RF energy level that is deemed to comply with RSS-102 without maximum permissive exposure evaluation (MPE). But it is desirable that it should be installed and operated with at least 20cm and more between the radiator and person's body (excluding extremities: hands, wrists, feet and legs).

U.S.A., Canadian and Australian models only

ENERGY STAR® is a U.S. registered mark. As an ENERGY STAR® partner, Sony Corporation has determined that this product meets the ENERGY STAR® guidelines for energy efficiency.

Note on DualDiscs

A DualDisc is a two sided disc product which mates DVD recorded material on one side with digital audio material on the other side. However, since the audio material side does not conform to the Compact Disc (CD) standard, playback on this product is not guaranteed.

Music discs encoded with copyright protection technologies

This product is designed to playback discs that conform to the Compact Disc (CD) standard. Recently, various music discs encoded with copyright protection technologies are marketed by some record companies. Please be aware that among those discs, there are some that do not conform to the CD standard and may not be playable by this product.

- The Bluetooth word mark and logos are owned by the Bluetooth SIG, Inc. and any use of such marks by Sony Corporation is under license. Other trademarks and trade names are those of their respective owners.
- "WALKMAN" and "WALKMAN" logo are registered trademarks of Sony Corporation.
- MICROVAULT is a trademark of Sony Corporation.
- ATRAC, ATRAC3, ATRAC3plus and their logos are trademarks of Sony Corporation.
- SonicStage and SonicStage logo are trademarks or registered trademarks of Sony Corporation.
- MPEG Layer-3 audio coding technology and patents licensed from Fraunhofer IIS and Thomson.

Table of Contents

Guide to parts and controls 5
Information on the display 7

Getting Started

Hooking up the system securely 8
Setting the clock 10

Basic Operations

Playing a CD/ATRAC/MP3 disc 11
Listening to the radio 13
Listening to music of a BLUETOOTH mobile phone or BLUETOOTH device 14
Listening to music of an USB device 17
Using optional audio components 18
Adjusting the sound 19
Changing the display 19

Other Operations

Creating your own program
(Program Play) 21
Presetting radio stations 22
Using the Timers 23

Others

Troubleshooting 24
Messages 27
Precautions 28
Specifications 30
BLUETOOTH wireless technology 31
Playable USB devices and BLUETOOTH devices 33

Guide to parts and controls

Unit (HCD-U1BT/Compact Disc Receiver)

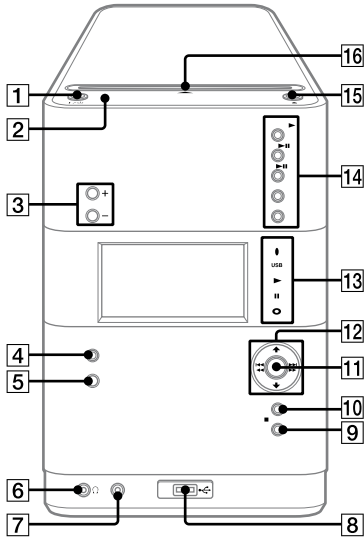

- 1** I/⏻ (power) button (page 10, 20, 23, 27)
Press to turn on the system.
- 2** STANDBY indicator (page 19, 24)
Lights up when the system is turned off.
- 3** VOLUME +/- button (page 11, 13, 16, 17, 18)
Press to adjust the volume.
- 4** Sound buttons (page 19)
Unit: DSGX button
Remote: EQ button
Press to select the sound.

- 5** Remote sensor (page 24)

- 6** 🎧 (headphones) jack
Connect the headphones.

- 7** AUDIO IN jack (page 18)
Connect to an optional audio component.

- 8** 🔄 (USB) port (page 17, 33)
Connect to an optional USB device (Digital music player or USB storage media).

- 9** Unit: ■ CANCEL (stop/cancel) button (page 11, 13, 15, 16, 17)
Remote: ■ (stop) button (page 11, 13, 15, 16, 17)
Press to stop playback.
Press to cancel search.

- 10** SEARCH button (page 11, 17, 20)
Press to enter or exit search mode. Press when the system is turned off to enter text mode.

Remote (RM-SCU35)

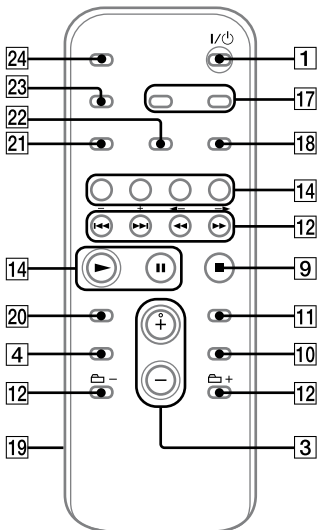

Continued

- 11** ENTER button (page 10, 20, 21, 22, 23)

Press to enter the settings.

- 12**  (go back/go forward) button (page 11, 17, 21)

Press to select a track or file.

Unit: TUNE +/- (tuning) button (page 13)

Remote: +/- (tuning) button (page 13)

Press to tune in the desired station.

Unit:  (folder and file search) button (page 11, 17)

Press to select a folder and file.

Remote:  +/- (select folder) button (page 11, 17, 21)

Press to select a folder.

 (rewind/fast forward) button (page 11, 17)

Press to find a point in a track or file.

- 13** Indicators

BLUETOOTH indicator

Lights up when you select the BLUETOOTH function.

USB indicator

Lights up when an optional USB device (Digital music player or USB storage media) is connected.

 (play) indicator

Lights up when a track or file is being played back.

 (pause) indicator

Lights up when a track or file is paused.

 (disc presence) indicator



Lights up when a disc is loaded.

- 14** Playback buttons and function buttons

BLUETOOTH  (play) button (page 16)

Press to select the BLUETOOTH function.

Press to start playback of the music on the BLUETOOTH device (BLUETOOTH mobile phone, etc.).



Unit: USB   (play/pause) button (page 17)

Press to select the USB function.

Press to start or pause playback of an optional USB device (Digital music player or USB storage media).

Remote: USB button (page 17)

Press to select the USB function.

Unit: CD   (play/pause) button (page 11)

Press to select the CD function.

Press to start or pause playback of a disc.

Remote: CD button (page 11)

Press to select the CD function.

Remote:  (play) button,  (pause) button

Press to start or pause playback.

TUNER/BAND button (page 13)

Press to select the TUNER function. Press to select FM or AM reception mode.

AUDIO IN button (page 18)

Press to select the AUDIO IN function.

FUNCTION button

Press to select the function.

- 15**  (eject) button (page 11)

Press to eject a disc.

- 16** Disc slot

- 17** CLOCK/TIMER SELECT button (page 23)
CLOCK/TIMER SET button (page 10, 23)
Press to set the clock and the timers.

- 18** REPEAT/FM MODE button (page 11, 13, 17)
Press to listen to a disc, a single track or file repeatedly. Press to select the FM reception mode (monaural or stereo).

- 19** Battery compartment lid (page 10)

- 20** CLEAR button (page 15, 21)
Press to delete a pre-programmed track or file. Press to erase the pairing registration information of the BLUETOOTH device.

- 21** TUNER MEMORY button (page 22)
Press to preset the radio station.

- 22** PLAY MODE/TUNING MODE button (page 12, 13, 18, 21, 22)
Press to select the play mode of a CD, "ATRAC" disc, MP3 disc or an optional USB device (Digital music player or USB storage media).
Press to select the tuning mode.

- 23** DISPLAY button (page 16, 19)
Press to change the information on the display.

- 24** SLEEP button (page 23)
Press to set the Sleep Timer.

Information on the display

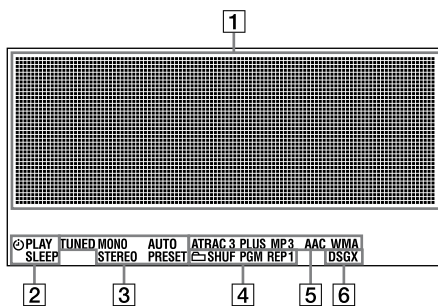

- 1** Text information
- 2** Timer (page 23)
- 3** Tuner reception mode (page 13)
Tuner reception (page 13)
- 4** Play mode (page 12, 18)
- 5** Audio format
- 6** DSGX (page 19)

Hooking up the system securely

Antennas

Find a location and an orientation that provide good reception, and then set up the antenna.

Keep the antennas away from the speaker cords, the power cord and the USB cable to avoid picking up noise.

Speakers

Left speaker ←

Right speaker ←

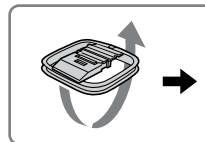
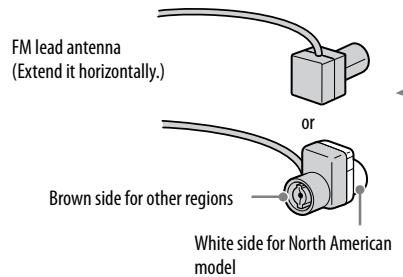

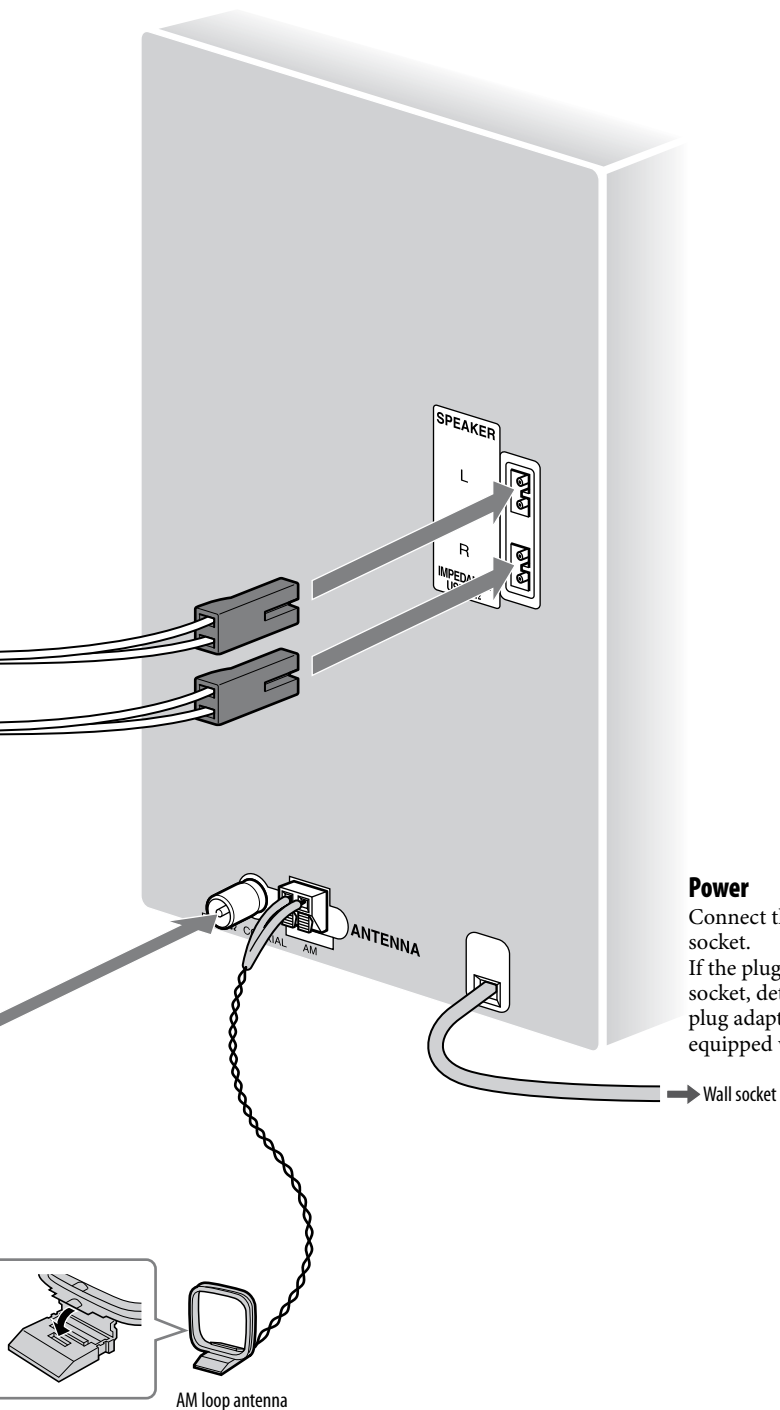

Continued →

To use the remote

Slide and remove the battery compartment lid **[19]**, and insert the two supplied R6 (size AA) batteries, **+** side first, matching the polarities shown below.

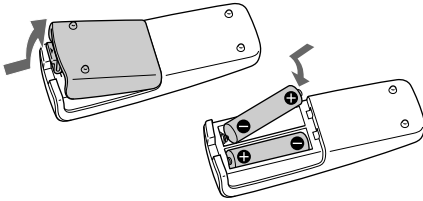

Notes

- With normal use, the batteries should last for about six months.
- Do not mix an old battery with a new one or mix different types of batteries.
- If you do not use the remote for a long period of time, remove the batteries to avoid damage from battery leakage and corrosion.

Setting the clock

- 1** Press I/⏻ (power) **[1]** to turn on the system.
- 2** Press CLOCK/TIMER SET **[17]**.
If the current mode appears on the display, press ◀◀/▶▶ **[12]** repeatedly to select “CLOCK SET?” and then press ENTER **[11]**.
- 3** Press ◀◀/▶▶ **[12]** repeatedly to set the hour, and then press ENTER **[11]**.
- 4** Use the same procedure to set the minutes.

When you turn off the system after setting the clock, the clock display appears instead of the demonstration display. The clock settings are lost when you disconnect the power cord or if a power failure occurs.

Basic Operations

Playing a CD/ATRAC/MP3 disc

- 1 Select the CD function.
Press CD [14].
- 2 Insert a disc in the disc slot [16] with the label side facing forward.

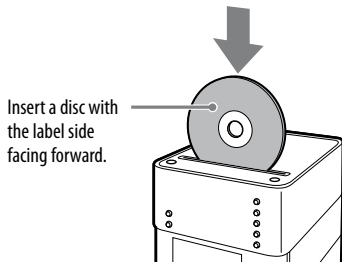

Notes



- When you turn on the system, the disc is not pulled into the disc slot until "No Disc" appears in the display. Do not attempt to push in the disc until "No Disc" appears.
- Do not insert a disc with non-standard shapes (e. g., heart, square, star). The disc may fall into the system and cause irreparable damage.
- When pressing ▲ [15] on the unit and then reinserting the disc that appears in the disc slot, do not simply push in the disc. Remove the disc from the disc slot and then reinsert it.
- Do not turn off the system with a disc halfway inserted in the disc slot. Doing so may cause the disc to fall.
- Do not use a disc with tape, seals or paste on it as this may cause malfunction.
- When you eject a disc, handle the disc by its edge. Do not touch the surface.
- Do not push a disc into the disc slot when the system is off. Doing so may cause the system to malfunction.
- Do not insert an 8 cm disc with an adaptor. Doing so may cause the system to malfunction.

- 3 Start playback.
Press ► (or CD ►|| on the unit) [14].
- 4 Adjust the volume.
Press VOLUME +/- [3].

Other operation

To	Press
Pause playback	(or CD ► on the unit) [14]. To resume play, press the button again.
Stop playback	■ [9].
Select a folder on an "ATRAC" disc or MP3 disc	📁 +/- (or ↑/↓ on the unit) [12].
Select a track or file	◀◀▶▶ [12].
Select a folder and file on an "ATRAC" disc or MP3 disc using the buttons on the unit	SEARCH [10]. Press ↑/↓ [12] to select the desired folder, then press ENTER [11]. Press ↑/↓ [12] to select the desired file, then press ENTER [11].
Find a point in a track or file	Hold down ◀◀▶▶ [12] during playback, and release the button at the desired point.
Select Repeat Play	REPEAT [18] repeatedly until "REP" or "REP1" appears.
Eject a disc	▲ [15] on the unit.

To change the play mode

Press PLAY MODE  repeatedly while the player is stopped. You can select normal play ("*") for all "ATRAC" files and MP3 files in the folder on the disc), shuffle play ("SHUF" or " SHUF*"), or program play ("PGM").

* When playing a CD-DA disc,  (SHUF) Play performs the same operation as SHUF Play.

To create an "ATRAC"/MP3 disc

You can create an "ATRAC" disc and MP3 disc with the SonicStage software. SonicStage can be downloaded free of charge from the following sites and installed on your computer.

For customers in the U.S.A.:

<<http://www.sony.com/shelfsupport>>

For customers in Canada:

<<http://www.sony.ca/ElectronicsSupport/>>

Please see the instructions at the sites or SonicStage Help of the software for how to install and how to create an "ATRAC"/MP3 disc.

Notes on Repeat Play

- All tracks or files on a disc are played repeatedly up to five times.
- "REP1" indicates that a single track or file is repeated until you stop it.

Notes on playing "ATRAC"/MP3 discs

- Do not save other types of files or unnecessary folders on a disc that has "ATRAC" and MP3 files.
- Folders that have no "ATRAC" and MP3 files are skipped.
- "ATRAC" and MP3 files are played back in the order that they are recorded onto the disc.
- The system can only play MP3 files that have a file extension of ".MP3".
- If there are files on the disc that have the ".MP3" file extension, but that are not MP3 files, the unit may produce noise or may malfunction.
- The maximum number of:
 - "ATRAC" folders is 255.
 - "ATRAC" files is 999.
 - MP3 folders is 255 (including the root folder).
 - MP3 files is 511.
 - MP3 files and folders that can be contained on a single disc is 512.
 - folder levels (the tree structure of files) is 8.
- Compatibility with all MP3 encoding/writing software, recording device, and recording media cannot be guaranteed. Incompatible MP3 discs may produce noise or interrupted audio or may not play at all.
- If "ATRAC" files and MP3 files are recorded on the same disc, this system plays the "ATRAC" files first.

Notes on playing multisession discs

- If the disc begins with a CD-DA (or "ATRAC"/MP3) session, it is recognized as a CD-DA (or "ATRAC"/MP3) disc, and other sessions are not played back.
- A disc with a mixed CD format is recognized as a CD-DA (audio) disc.

Listening to the radio

- 1 Select "FM" or "AM."
Press TUNER/BAND [14] repeatedly.
- 2 Select the tuning mode.
Press TUNING MODE [22] repeatedly until "AUTO" appears.
- 3 Tune in the desired station.
Press +/- (or TUNE +/- on the unit) [12]. Scanning stops automatically when a station is tuned in, and then "TUNED" and "STEREO" (for stereo programs) appear.

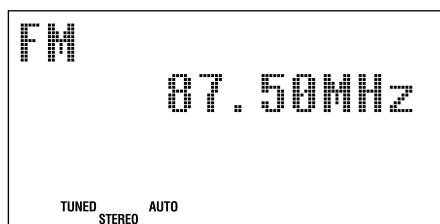

- 4 Adjust the volume.
Press VOLUME +/- [3].

To stop automatic scanning

Press ■ [9].

To tune in a station with a weak signal

If "TUNED" does not appear and the scanning does not stop, press TUNING MODE [22] repeatedly until "AUTO" and "PRESET" disappear, and then press +/- (or TUNE +/- on the unit) [12] repeatedly to tune in the desired station.

To reduce static noise on a weak FM stereo station

Press FM MODE [18] repeatedly until "MONO" appears to turn off stereo reception.

Listening to music of a BLUETOOTH mobile phone or BLUETOOTH device

This is a Micro HI-FI Component System incorporating BLUETOOTH wireless technology for enabling you to listen to music from your BLUETOOTH mobile phone or BLUETOOTH device over a wireless connection.

This system supports the A2DP and AVRCP profiles. For details on BLUETOOTH wireless technology, see “BLUETOOTH wireless technology” (page 31).

Check the websites below for the latest information about compatible devices.

For customers in the U.S.A.:

<<http://www.sony.com/shelfsupport>>

For customers in Canada:

<<http://www.sony.ca/ElectronicsSupport/>>

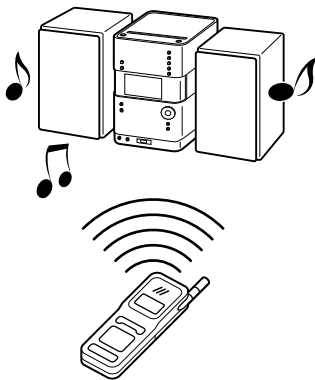

Follow the procedure below to listen to music from BLUETOOTH devices with this system.

Pairing this system with a BLUETOOTH device



Connecting to registered devices



Playing music of a BLUETOOTH device

For details about the operations of the BLUETOOTH device, also refer to the operation manual supplied with your BLUETOOTH device.

Pairing this system with a BLUETOOTH device

Pairing is an operation where BLUETOOTH devices register with each other beforehand. Use the procedure below to pair the system with your BLUETOOTH device. Once a pairing operation is performed, it does not need to be performed again. If pairing is already completed, proceed to “Playing music of a BLUETOOTH device” (page 16).

- 1 Place the BLUETOOTH device to be connected to this system within 1 meter of the system.
- 2 Select the BLUETOOTH function. Press BLUETOOTH ► **14** on the unit.
- 3 Operate the BLUETOOTH device and perform the pairing operation.

For details about the operations of the BLUETOOTH device, refer to the operation manual supplied with your BLUETOOTH device.

When searching for this system with the BLUETOOTH device, a list of the devices found may appear in the BLUETOOTH device display depending on the type of BLUETOOTH device.

This system appears as “CMT-U1BT”

When establishing the connection with this system, select the audio profile (A2DP, AVRCP) at the BLUETOOTH device. If the BLUETOOTH device does not support the AVRCP profile, you cannot perform playback or other operations with the system (page 16).

4 Enter the passcode.

Passcode entry may be required depending on the type of BLUETOOTH device.

For details about the operations of the BLUETOOTH device, refer to the operation manual supplied with your BLUETOOTH device.

Enter the passcode at the system as follows:

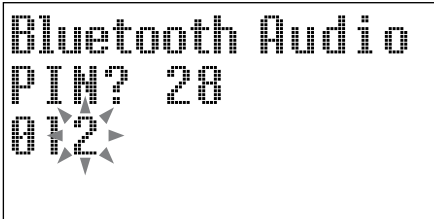

“PIN?” and a countdown appear.

Press **↑/↓** [12] and **←/→** [12] to enter the same passcode that was entered at the BLUETOOTH device, and then press **ENTER** [11].

Once pairing is completed and the connection is established, the system display changes as follows:

“Connect” → Name of the BLUETOOTH device

To cancel passcode entry partway

Press **■** [9].

Notes

- “Passcode” may be called “Passkey,” “PIN code,” “PIN number” or “Password,” etc. depending on the device.
- This system only supports numerical passcodes up to 13 digits.
- The pairing standby status of the system is cancelled after about 30 seconds. If pairing is not successful, redo the procedure from step 1.
- While connected to a BLUETOOTH device, this system cannot be detected and a connection cannot be established from another BLUETOOTH device.

To erase all the pairing registration information

- 1 Press **BLUETOOTH** **▶** [14] on the unit.
When the system is connected with a BLUETOOTH device (when the BLUETOOTH device name appears in the system display), turn off the system or change the function to cancel the connection.
- 2 Press **CLEAR** [20].
“Delete?” appears.
- 3 Press **ENTER** [11].
“Complete!” appears and all the pairing information is erased.

Note

In order to connect with a BLUETOOTH device after performing this operation, you must enter the passcode again.

Playing music of a BLUETOOTH device

You can operate a BLUETOOTH device by connecting the system and a BLUETOOTH device using AVRCP. If the system is not connected with a BLUETOOTH device using AVRCP, "Not in Use" appears when you operate the system.

1 Select the BLUETOOTH function.
Press BLUETOOTH ► [14] on the unit.

2 Establish the connection from the BLUETOOTH device.

For details about the operations of the BLUETOOTH device, refer to the operation manual supplied with your BLUETOOTH device.

Once the connection is established, the system display changes as follows:
"Connect" → Name of the BLUETOOTH device

3 Start playback.
Press ► (or BLUETOOTH ► on the unit) [14].
Depending on the BLUETOOTH device, you may need to start up the AV software of the BLUETOOTH device beforehand.

4 Adjust the volume.
Press VOLUME +/- [3].

To check the address of a connected BLUETOOTH device

Press DISPLAY [23] while the BLUETOOTH device name appears in the system display. The BLUETOOTH device address appears for 8 seconds.

To cancel the connection with a BLUETOOTH device

Change the system's function or turn off the system. When using the system next time, reestablish the connection with the BLUETOOTH device.

Other operation

To	Press
Pause playback	⏸ [14].
Stop playback	■ [9].
Select a file	◀◀/▶▶ [12].
Find a point in a file	Hold down ◀◀/▶▶ [12].



Note

These operations may not be available for certain BLUETOOTH devices. In addition, the actual operations may differ according to the connected BLUETOOTH device.

Note on connections with BLUETOOTH devices



If you cannot connect with a paired BLUETOOTH device, perform the pairing operation between the system and the BLUETOOTH device again.

Listening to music of an USB device

You can connect an optional USB device (Digital music player or USB storage media) to the  (USB) port  on the unit and listen to music stored in the USB device. See “Playable USB devices and BLUETOOTH devices” (page 33) for a list of USB devices that can be connected to this system.

The audio formats that can be played back by this system are as follows: ATRAC/MP3¹⁾/WMA¹⁾/AAC¹⁾²⁾

¹⁾ Files with copyright protection (Digital Rights Management) cannot be played by this system.
²⁾ AAC files transferred to a digital music player using SonicStage CP cannot be played by this system.

- 1 Select the USB function.
Press USB .
- 2 Connect an optional USB device (Digital music player or USB storage media) to the  (USB) port  as shown below.

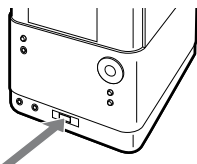





USB device (Digital music player or USB storage media)

When USB cable connection is necessary, connect the USB cable supplied with the USB device to be connected. See the operation manual supplied with the USB device to be connected for details on the operation method.























When the USB device is connected, the display changes as follows:
 “Detect” → “Connecting” → “ATRAC AD” or “STORAGE DRIVE”

Note

It may take about 10 seconds before “Detect” appears depending on the type of USB device connected.

- 3 Start playback.
Press  (or USB  on the unit) .
- 4 Adjust the volume.
Press VOLUME +/- .

Other operation

To	Press
Pause playback	 (or USB  on the unit)  . To resume play, press the button again.
Stop playback	  .
Select a folder	 +/- (or  on the unit)  .
Select a file	   .
Select a folder and file using the buttons on the unit*	SEARCH  . Press   to select the desired folder, then press ENTER  . Press   to select the desired file, then press ENTER  .
Find a point in a file	Hold down   during playback, and release the button at the desired point.
Select Repeat Play	REPEAT  repeatedly until “REP” or “REPI” appears.
Remove the USB device	Hold down   until “Device Stop” appears, then remove the USB device.

* Artist searches and group searches are possible for some USB device types.

To change the play mode

Press PLAY MODE [22] repeatedly while the USB device is stopped. You can select normal play (“▶”) for all files in the folder on the digital music player), shuffle play (“SHUF” or “◻ SHUF”), or program play (“PGM”).

Notes on the USB device

- With some connected USB devices, after an operation is performed, there may be a delay before it is performed by this system.
- This system does not necessarily support all the functions provided in a connected USB device.
- The playback order for the system may differ from the playback order of the connected USB device.
- Always press ■ [9] and make sure that “Device Stop” appears before removing the USB device. Removing the USB device while “Device Stop” is not displayed may corrupt the data on it or damage the USB device itself.
- Do not save other types of files or unnecessary folders on an USB device that has audio files.
- Folders that have no audio files are skipped.
- Files are played back in the order that they are transferred to the USB device.
- The maximum numbers of folders and files that can be contained on a single USB device are as follows:
 - Digital music player: 65,535 groups (maximum 999 tracks per group)/65,535 tracks
 - USB storage media: 512 folders (including the root folder, maximum 999 files per folder, maximum 255 folders per folder)/65,535 filesThe maximum number of files and folders may vary depending on the file and folder structure.
- The audio formats that you can listen to with this system are as follows:
 - MP3: file extension “.mp3”
 - Windows Media file: file extension “.wma”
 - AAC: file extension “.m4a”Note that even when file names have the above file extensions, if the actual file differs, the system may produce noise or may malfunction.
- Compatibility with all encoding/writing softwares, recording devices, and recording media cannot be guaranteed. Incompatible USB device may produce noise or interrupted audio or may not play at all.

Using optional audio components

- 1 Connect additional audio component to the AUDIO IN jack [7] on the unit using an audio analog cord (not supplied).
- 2 Turn down the volume.
Press VOLUME – [3].
- 3 Select the AUDIO IN function.
Press AUDIO IN [14] on the unit.
- 4 Start playing the connected component.
- 5 Adjust the volume.
Press VOLUME +/- [3].

Adjusting the sound

To add a sound effect

To	Press
Generate a more dynamic sound (Dynamic Sound Generator X-tra)	DSGX [4] on the unit.
Set the sound effect	EQ [4] repeatedly to select "BASS" or "TREBLE," and then press +/- [12] repeatedly to adjust the level.

Changing the display

To	Press
Change information on the display ¹⁾²⁾	DISPLAY [23] repeatedly when the system is turned on.
Change Display mode (See below.)	DISPLAY [23] repeatedly when the system is turned off.

¹⁾ For example, you can view CD/"ATRAC"/MP3 disc information or the USB device information, such as the track or file number or folder name during normal play, or the total playing time while the player is stopped.

²⁾ When the system and a BLUETOOTH device are connected using the BLUETOOTH function, you can view the BLUETOOTH device address.

The system offers the following display modes.

Display mode	When the system is off ¹⁾ ,
Demonstration	The demonstration indicator is displayed.
Clock	The clock is displayed.
Power Saving Mode ²⁾	The display is turned off to conserve power. The timer and clock continue to operate.

¹⁾ The STANDBY indicator [2] on the unit lights up when the system is off.

²⁾ When the system is in Power Saving Mode, the following functions are unavailable:

- setting the clock.
- changing the AM tuning interval.
- changing the CD power manage function.
- resetting the system to factory settings.
- selecting the text mode.

Continued 

To select the text mode

You can select from a variety of languages for displaying the text information on a disc or an USB device. Use buttons on the unit for the operation.

- 1 Press I/⏻ [1] to turn off the system.
- 2 Press SEARCH [10].
The language list appears. The languages you can select vary depending on the country or region specification.
- 3 Press ↑/↓ [12] to select the language, and then press ENTER [11].

Notes on the display information

- Characters that cannot be displayed appear as “_”.
- The information on the disc or USB device may not be displayed correctly in the selected text mode.
- The following are not displayed:
 - total playing time for a CD-DA disc depending on the play mode.
 - total playing time for an “ATRAC”/MP3 disc.
- The following are not displayed correctly:
 - elapsed playing time of an “ATRAC” file or MP3 file encoded using a VBR (variable bit rate).
 - folder and file names that do not follow either the ISO9660 Level 1, Level 2 or Joliet in the expansion format.
- The following are displayed:
 - ID3 tag information for “ATRAC” files and MP3 files when ID3 version 1 and version 2 tags are used.
 - up to 62 characters of ID3 tag information.

Other Operations

Creating your own program

(Program Play)

Use buttons on the remote to create your own program.

1 Select the desired function.

CD

Press CD [14] to select the CD function.

USB

Press USB [14] to select the USB function.

2 Press PLAY MODE [22] repeatedly until “PGM” appears while the system is stopped.

3 Press I◀◀/▶▶ [12] repeatedly until the desired track or file number appears.

When programming files, press [Folder] +/- [12] repeatedly to select the desired folder, and then select the desired file.

Example: When programming tracks on a CD

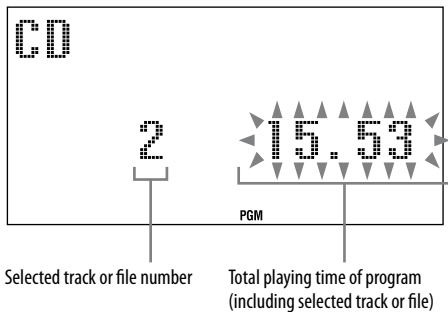

4 Press ENTER [11] to add the track or file to the program.

CD

“-.-” appears when the total program time exceeds 100 minutes for a CD, or when you select a CD track whose number is 21 or over, or when you select an “ATRAC” file or MP3 file.

USB

The total program time cannot be displayed, so “-.-” appears.

5 Repeat steps 3 through 4 to program additional tracks or files, up to a total of 25 tracks or files.

6 To play your program of tracks or files, press ▶ [14].

The program remains available until you remove the disc or USB device. When using an USB device, the program disappears when the system is turned off. To play the same program again, press ▶ [14].

To cancel Program Play

Press PLAY MODE [22] repeatedly until “PGM” disappears while the system is stopped.

To delete the last track or file of the program

Press CLEAR [20] while the system is stopped.

Presetting radio stations

You can preset your favorite radio stations and tune them in instantly by selecting the corresponding preset number. Use buttons on the remote to preset stations.

- 1 Tune in the desired station (see "Listening to the radio" (page 13)).
- 2 Press TUNER MEMORY **[21]**.

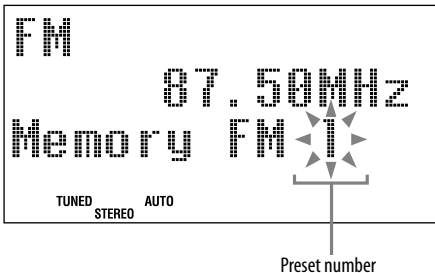

- 3 Press +/- **[12]** repeatedly to select your desired preset number.
If another station is already assigned to the selected preset number, the station is replaced by the new stations.
- 4 Press ENTER **[11]**.
- 5 Repeat steps 1 through 4 to store other stations.
You can preset up to 20 FM and 10 AM stations. The preset stations are retained for about half a day even if you disconnect the power cord or if a power failure occurs.

- 6 To call up a preset radio station, press TUNING MODE **[22]** repeatedly until "PRESET" appears, and then press +/- **[12]** repeatedly to select the desired preset number.

Using the Timers

The system offers two timer functions. If you use the Play Timer with the Sleep Timer, the Sleep Timer has priority.

Sleep Timer:

You can fall asleep to music. This function works even if the clock is not set. Press SLEEP [24] repeatedly. If you select "AUTO," the system automatically turns off after the current disc stops or in 100 minutes.

Play Timer:

You can wake up to CD, tuner or optional USB device at a preset time.

Use buttons on the remote to control the Play Timer. Make sure you have set the clock.

- 1 Prepare the sound source.
Prepare the sound source, and then press VOLUME +/- [3] to adjust the volume. To start from a specific CD track, "ATRAC" file or MP3 file of a disc, create your own program (page 21).
- 2 Press CLOCK/TIMER SET [17].
- 3 Press I◀◀/▶▶I [12] repeatedly to select "PLAY SET?," and then press ENTER [11].
"ON" appears, and the hour indication flashes.
- 4 Set the time to start playing.
Press I◀◀/▶▶I [12] repeatedly to set the hour, and then press ENTER [11].
The minute indication flashes. Use the procedure above to set the minutes.

- 5 Use the same procedure as in step 4 to set the time to stop playing.

- 6 Select the sound source.
Press I◀◀/▶▶I [12] repeatedly until the desired sound source appears, and then press ENTER [11]. The display shows the timer settings.

- 7 Press I/⏻ [1] to turn off the system.
The system turns on 15 seconds before the preset time. If the system is on at the preset time, the Play Timer will not play.

To activate or check the timer again

Press CLOCK/TIMER SELECT [17], press I◀◀/▶▶I [12] repeatedly until "PLAY SELECT?" appears, and then press ENTER [11].

To cancel the timer

Repeat the same procedure as above until "TIMER OFF" appears, and then press ENTER [11].

To change the setting

Start over from step 1.

Note

You cannot perform Program Play of the files on an USB device using the Play Timer.

Tip

The Play Timer setting remains as long as the setting is not canceled manually.

Troubleshooting

- 1 Make sure the power cord and speaker cords are correctly and firmly connected.
- 2 Find your problem in the checklist below, and take the indicated corrective action. If the issue persists, contact your nearest Sony dealer.

If the STANDBY indicator flashes

Immediately unplug the power cord, and check the following item.

- If your system has a voltage selector, is the voltage selector set to the correct voltage?
 - Are you using only the supplied speakers?
 - Is anything blocking the ventilation holes on the top or back of the system?
- After the STANDBY indicator [2] stops flashing, reconnect the power cord, and turn on the system. If the issue persists, contact your nearest Sony dealer.

General

The display starts flashing as soon as you plug in the power cord even though you have not turned on the system.

- Press DISPLAY [23] while the system is off. The demonstration disappears.

Sound comes from one channel, or the left and right volumes are unbalanced.

- Place the speakers as symmetrically as possible.
- Connect only the supplied speakers.

Severe hum or noise.

- Move the system away from sources of noise.
- Connect the system to a different wall socket.
- Install a noise filter (available separately) to the power cord.

The remote does not function.

- Remove any obstacles between the remote and the remote sensor [5] on the unit, and position the unit away from fluorescent lights.
- Point the remote at the system's sensor.
- Move the remote closer to the system.

CD/"ATrac"/MP3 player

The sound skips, or the disc will not play.

- Wipe the disc clean, and replace it.
- Move the system to a location away from vibration (for example, on top of a stable stand).
- Move the speakers away from the system, or place them on separate stands. At high volume, speaker vibration may cause the sound to skip.

Play does not start from the first track.

- Press PLAY MODE [22] repeatedly until both "PGM" and "SHUF" disappear to return to normal play.

Starting playback takes more time than usual.

- The following discs take a longer time to start playback.
 - a disc recorded with a complicated tree structure.
 - a disc recorded in multisession mode.
 - a disc that has not been finalized (a disc to which data can be added).
 - a disc that has many folders.

BLUETOOTH device

Pairing cannot be done.

- Move the BLUETOOTH device closer to the system.

Connection is not possible.

- The BLUETOOTH device you attempted to connect does not support the A2DP and AVRCP profiles, and cannot be connected with the system.
- Enable the BLUETOOTH function of the BLUETOOTH device.
- The pairing registration information has been erased. Perform the pairing operation again.
- While connected to a BLUETOOTH device, this system cannot be detected and a connection cannot be established from another BLUETOOTH device.

The sound skips or fluctuates, or the connection is lost.

- The system and the BLUETOOTH device are too far apart.
- If there are obstacles between the system and your BLUETOOTH device remove or avoid the obstacles.
- If there is equipment that generates electromagnetic radiation, such as a wireless LAN, other BLUETOOTH device, or a microwave oven nearby, move them away.

The sound of your BLUETOOTH device cannot be heard.

- Turn up the volume on your BLUETOOTH device first, and then adjust the volume using VOLUME +/- [3] on the unit.

Severe hum or noise



- If there are obstacles between the system and your BLUETOOTH device remove or avoid the obstacles.
- If there is equipment that generates electromagnetic radiation, such as a wireless LAN, other BLUETOOTH device, or a microwave oven nearby, move them away.
- Turn down the volume of the connected BLUETOOTH device.

USB device

Are you using a supported USB device?

- If you connect an unsupported USB device, the following problems may occur. See “Playable USB devices and BLUETOOTH devices” (page 33) for the supported device types.
 - The USB device is not recognized.
 - File or folder names are not displayed on this system.
 - Playback is not possible.
 - The sound skips.
 - There is noise.

“Over Current” appears.

- A problem has been detected with the level of electrical current from the  (USB) port [8]. Turn off the system and remove the USB device from the  (USB) port [8]. Make sure there is no problem with the USB device. If this display pattern persists, contact your nearest Sony dealer.

There is no sound.

- The USB device is not connected correctly. Turn off the system, then reconnect the USB device and check if the USB indicator [13] lights up.

The sound is distorted.

- The bit rate used when encoding the files was low. Send files encoded with higher bit rates to the USB device.

There is noise or the sound skips.

- Turn off the system, then reconnect the USB device.
- The music data itself contains noise. Noise may have been introduced when creating music data due to the conditions of the computer. Create the music data again.
- When using the USB storage media, copy the files to your computer, format the USB storage media in FAT16 or FAT32 format, and copy the files to the USB storage media again.*

The USB device cannot be connected into the (USB) port .

- The USB device is being connected backwards. Connect the USB device in the correct orientation.

The USB storage media which has been used on another device does not work.

- It may be recorded in an unsupported format. If so, first take the precaution of backing up important files on the USB storage media by copying them to your computer hard disk. Next, format the USB storage media with a FAT16 or FAT32 file system and transfer the backed-up audio files onto the USB storage media again.*



“Connecting” is displayed for a long time.

- It may take a while to finish reading the USB device if there are many folders or files on it. Thus, we recommend following these guidelines.
 - Total folders on USB device: 100 or less
 - Total files per folder: 100 or less

Erroneous display

- Send the music data to the USB device again, as the data stored in the USB device may have been corrupted.

Play does not start.

- Turn off the system, then reconnect the USB device.
- Connect the USB device that this system can play.
- Press  (or USB  on the unit)  to start play.

Play does not start from the first track.

- Set the play mode to Normal Play mode.

Files cannot be played back.

- USB storage media formatted with file systems other than FAT16 or FAT32 are unsupported.*
- If you use partitioned USB storage media, only files on the first valid partition can be played.
- Files that are encrypted or protected by passwords, etc. cannot be played back.

* This system supports FAT16 and FAT32, but some USB storage media may not support all of these FAT. For details, see the operation manual of each USB storage media or contact the manufacturer.

Tuner



Severe hum or noise, or stations cannot be received. (“TUNED” or “STEREO” flashes on the display.)

- Connect the antenna properly.
- Find a location and an orientation that provide good reception, and then set up the antenna again.
- Keep the antennas away from the speaker cords, the power cord and the USB cable to avoid picking up noise.
- Connect a commercially available external antenna.
- Consult your nearest Sony dealer if the supplied AM antenna has come off the plastic stand.
- Turn off nearby electrical equipment.

To change the AM tuning interval

The AM tuning interval is factory-preset to 9 kHz (or 10 kHz, for some areas). You cannot change the AM tuning interval in Power Saving Mode.

Use buttons on the unit to change the AM tuning interval.

- 1** Tune in any AM station, and then turn off the system.
- 2** While holding down TUNER/BAND , press  . All the AM preset stations are erased. To reset the interval to the factory preset, repeat the procedure.

To improve tuner reception

Turn off CD player power by using the CD power management function. By default, CD power is turned on. You cannot change the setting in Power Saving Mode.

Use buttons on the unit to turn off CD player power.

- 1 Press FUNCTION [14] repeatedly to select the CD function, and then turn off the system.
- 2 After "STANDBY" stops flashing, press I/⏻ [1] while holding down ■ [9]. "CD POWER OFF" appears. With CD player power turned off, disc access time is increased. To turn on CD player power, repeat the procedure until "CD POWER ON" appears.

To reset the system to factory settings

If the system still does not operate properly, reset the system to factory settings. You cannot reset the system to factory settings in Power Saving Mode. Use buttons on the unit to reset the system to its factory default settings.

- 1 Disconnect and reconnect the power cord, and then turn on the system.
- 2 Press DSGX [4] and I/⏻ [1] at the same time.
All user-configured settings, such as preset radio stations, timer, and the clock, are deleted.

Messages

CD/ATRAC/MP3 player, Tuner

Complete!: The preset operation ended normally.

LOCKED: The system does not eject the disc. Contact your nearest Sony dealer.

No Disc: There is no disc in the system, or you have loaded a disc that cannot be played.

No Step: All of the programmed tracks or files have been erased.

Not in Use: You pressed an invalid button.

OFF TIME NG!: The Play Timer start and end times are set to the same time.

Over: You have reached the end of the disc while pressing ►► [12] during playback or pause.

Push SELECT!: You tried to set the clock or timer during timer operation.

Push STOP!: You pressed PLAY MODE [22] during playback.

Reading: The system is reading information of the disc. Some buttons are not available.

SET CLOCK!: You tried to select the timer when the clock is not set.

SET TIMER!: You tried to select the timer when the Play Timer is not set.

Step Full!: You tried to program more than 26 tracks or files (steps).

BLUETOOTH device

Connect: BLUETOOTH communication was established.

Disconnect: Communication with a BLUETOOTH device was cut off for some reason, or BLUETOOTH communication was ended by the BLUETOOTH device.

Not in Use: The system is not connected with a BLUETOOTH device using AVRCP.

PIN?: The system is asking for the passcode. For details, see "Listening to music of a BLUETOOTH mobile phone or BLUETOOTH device" (page 14).

USB device

ATRAC AD: An ATRAC Audio Device is connected.

Connecting: The system is recognizing the USB device.

Detect: An USB device is connected.

Device Error: The USB device could not be recognized or an unknown device is connected.

Device Stop: The USB device has been stopped.

No Device: No USB device is connected.

No Info: The system cannot display the track information (folder name, file name, etc).

No Step: All of the programmed tracks or files have been erased.

Not Supported: An unsupported USB device is connected.

No Track: No playable file is loaded in the system.

Not in Use: You have made an invalid or currently prohibited operation.

Please Wait: The system is readying for usage of an USB device.

Removed: The USB device has been removed.

Step Full!: You tried to program more than 26 tracks or files (steps).

STORAGE DRIVE: USB storage media is connected.

Precautions

Discs that this system CAN play

- Audio CD
- CD-R/CD-RW (audio data "ATRAC" files/MP3 files)

Discs that this system CANNOT play

- CD-ROM
- CD-R/CD-RW other than those recorded in music CD format, "ATRAC" format or MP3 format conforming to ISO9660 Level 1/Level 2, Joliet or multisession
- CD-R/CD-RW recorded in multisession that have not ended by "closing the session"
- CD-R/CD-RW of poor recording quality, CD-R/CD-RW that have scratches or are dirty, or CD-R/CD-RW recorded with an incompatible recording device
- CD-R/CD-RW which is finalized incorrectly
- Discs containing files other than MPEG 1 Audio Layer-3 (MP3) files
- Discs of non-standard shape (for example, heart, square, star)
- Discs that have adhesive tape, paper, or sticker attached to them
- Rental or used discs with attached seals where the glue extends beyond the seal
- Discs that have labels printed using ink that feels tacky when touched

Notes on discs

- Before playing, wipe the disc with a cleaning cloth from the center out to the edge.
- Do not clean discs with solvents, such as benzine thinner, or commercially available cleaners or anti-static spray intended for vinyl LPs.
- Do not expose discs to direct sunlight or heat sources such as hot air ducts, nor leave it in a car parked in direct sunlight.

On safety

- Completely disconnect the power cord (mains lead) from the wall socket (mains) if it is not going to be used for an extended period of time. When unplugging the unit, always grip the plug. Never pull the cord itself.
- Should any solid object or liquid get into the system, unplug the system, and have it checked by qualified personnel before operating it again.
- The AC power cord can be changed only by a qualified service facility.

On placement

- Do not place the system in an inclined position or in locations that are extremely hot, cold, dusty, dirty, or humid or lacking adequate ventilation, or subject to vibration, direct sunlight or a bright light.
- Be careful when placing the unit or speakers on surfaces that have been specially treated (for example, with wax, oil, polish) as staining or discoloration of the surface may result.
- If the system is brought directly from a cold to a warm location or is placed in a very damp room, moisture may condense on the lens inside the CD player, and cause the system to malfunction. In this situation, remove the disc, and leave the system turned on for about an hour until the moisture evaporates.

On heat buildup

- Heat buildup on the unit during operation is normal and is not cause for alarm.
- Do not touch the cabinet if it has been used continuously at a high volume because the cabinet may have become hot.
- Do not obstruct the ventilation holes.

On the speaker system

This speaker system is not magnetically shielded, and the picture on nearby TV sets may become magnetically distorted. In this situation, turn off the TV, wait 15 to 30 minutes, and turn it back on. If there is no improvement, move the speakers far away from the TV.

Cleaning the cabinet

Clean this system with a soft cloth slightly moistened with a mild detergent solution. Do not use any type of abrasive pad, scouring powder, or solvent, such as thinner, benzine, or alcohol.

Specifications

Main unit (HCD-U1BT/Compact Disc Receiver)

AUDIO POWER SPECIFICATIONS
POWER OUTPUT AND TOTAL HARMONIC
DISTORTION:
(The United States model only)
With 6 ohm loads, both channels driven, from
120 – 10,000 Hz; rated 25 watts per channel
minimum RMS power, with no more than 10%
total harmonic distortion from 250 milliwatts to
rated output.

Amplifier section

DIN power output (rated): 20 + 20 watts
(6 ohms at 1 kHz, DIN)
Continuous RMS power output (reference):
25 + 25 watts (6 ohms at 1 kHz, 10% THD)

Inputs:

AUDIO IN (stereo mini jack):
voltage 620 mV, impedance 47 kilohms
⚡ (USB) port: Type A, maximum current
500 mA

Outputs:

🎧 (PHONES (stereo mini jack)): accepts
headphones of 8 ohms or more
SPEAKER: accepts impedance of 6 ohms

BLUETOOTH section

Communication system:
BLUETOOTH Standard version 2.0
Output:
BLUETOOTH Standard Power Class 2
Maximum communication range:
Line of sight approx. 10 m¹⁾
Frequency band:
2.4 GHz band (2.4000 GHz – 2.4835 GHz)
Modulation method:
FHSS
Compatible BLUETOOTH profiles²⁾:
A2DP (Advanced Audio Distribution
Profile)
AVRCP (Audio Video Remote Control
Profile)
Audio format:
SBC (Sub Band Codec)

¹⁾ The actual range will vary depending on factors such as obstacles between devices, magnetic fields around a microwave oven, static electricity, reception sensitivity, antenna's performance, operating system, software application, etc.

²⁾ BLUETOOTH standard profiles indicate the purpose of BLUETOOTH communication between devices.

USB section

Supported bit rate
MP3 (MPEG 1 Audio Layer-3):
32 – 320 kbps, VBR
ATRAC: 48 – 352 kbps (ATRAC3 plus),
66/105/132 kbps (ATRAC3)
WMA: 48 – 192 kbps, VBR
AAC: 48 – 320 kbps

Sampling frequencies

MP3 (MPEG 1 Audio Layer-3):
32/44.1/48 kHz
ATRAC: 44.1 kHz
WMA: 44.1 kHz
AAC: 44.1 kHz

CD player section

System: Compact disc and digital audio system
Laser Diode Properties

Emission duration: continuous
Laser Output*: Less than 44.6µW
*This output is the value measurement at a
distance of 200mm from the objective lens
surface on the Optical Pick-up Block with 7mm
aperture.

Frequency response: 20 Hz – 20 kHz

Tuner section

FM stereo, FM/AM superheterodyne tuner

FM tuner section:

Tuning range: 87.5 – 108.0 MHz (100 kHz step)
Antenna: FM lead antenna
Antenna terminals: 75 ohms unbalanced
Intermediate frequency: 10.7 MHz

AM tuner section:

Tuning range:
530 – 1,710 kHz (with 10 kHz tuning interval)
531 – 1,710 kHz (with 9 kHz tuning interval)
Antenna: AM loop antenna, external antenna
terminal
Intermediate frequency: 450 kHz

Speaker (SS-CU1BT)

Speaker system: 2-way, 2-unit, bass-reflex type
Speaker units: Woofer 10 cm, Aluminum cone type, Tweeter 2 cm, soft dome type
Nominal impedance: 6 ohms
Dimensions (w/h/d): Approx. 150 × 241 × 225 mm
Mass: Approx. 2.3 kg net per speaker

General

Power requirements: 120 V AC, 60 Hz

Power consumption: 35 watts

Dimensions (w/h/d) (excl. speakers): Approx. 160 × 241 × 218 mm

Mass (excl. speakers) 3.2 kg

Supplied accessories: Remote Commander (RM-SCU35) (1), R6 (Size AA) batteries (2), AM loop antenna (1), FM lead antenna (1)

U.S. and foreign patents licensed from Dolby Laboratories.

Design and specifications are subject to change without notice.



- Standby power consumption: 0.5 W
- Halogenated flame retardants are not used in the certain printed wiring boards.
- Halogenated flame retardants are not used in cabinets.
(Except for the United States model)

BLUETOOTH wireless technology

BLUETOOTH wireless technology is a short-range wireless technology linking digital devices, such as personal computers and digital still cameras. Using the BLUETOOTH wireless technology, you can operate the units involved within a range of about 10 meters.

The BLUETOOTH wireless technology is commonly used between two devices, but a single device can be connected to multiple devices.

You do not need wires to get connected as you do with a USB connection, and you do not need to place the devices face to face as you do with wireless infrared technology. You can use the technology with one BLUETOOTH device in your bag or pocket.

BLUETOOTH wireless technology is a global standard supported by thousands of companies. These companies produce products that meet the global standard.

Supported BLUETOOTH version and profiles

Profile refers to a standard set of capabilities for various BLUETOOTH product capabilities. This system supports the following BLUETOOTH version and profiles.

Supported BLUETOOTH version:

BLUETOOTH Standard version 2.0

Supported BLUETOOTH profiles:

A2DP (Advanced Audio Distribution Profile)

AVRCP (Audio Video Remote Control Profile)

Effective communication range

BLUETOOTH devices should be used within approximately 10 meters (unobstructed distance) of each other. The effective communication range may become shorter under the following conditions.

- When a person, metal object, wall or other obstruction is between the devices with a BLUETOOTH connection
- Locations where a wireless LAN is installed
- Around microwave ovens that are in use
- Locations where other electromagnetic waves occur

Effects of other devices

BLUETOOTH devices and wireless LAN (IEEE 802.11b/g) use the same frequency band (2.4 GHz). When using your BLUETOOTH device near a device with wireless LAN capability, electromagnetic interference may occur. This could result in lower data transfer rates, noise, or inability to connect. If this happens, try the following remedies:

- Try connecting this system and BLUETOOTH mobile phone or BLUETOOTH device when you are at least 10 meters away from the wireless LAN equipment.
- Turn off the power to the wireless LAN equipment when using your BLUETOOTH device within 10 meters.

Effects on other devices

The radio waves broadcast by this system may interfere with the operation of some medical devices. Since this interference may result in malfunction, always turn off the power on this system, BLUETOOTH mobile phone and BLUETOOTH device in the following locations:

- In hospitals, on trains, in airplanes, at gas stations, and any place where flammable gasses may be present
- Near automatic doors or fire alarms

Notes

- This system supports security functions that comply with the BLUETOOTH specification as a means of ensuring security during communication using BLUETOOTH technology. However, this security may be insufficient depending on the setting contents and other factors, so always be careful when performing communication using BLUETOOTH technology.
- Sony cannot be held liable in any way for damages or other loss resulting from information leaks during communication using BLUETOOTH technology.
- BLUETOOTH communication is not necessarily guaranteed with all BLUETOOTH devices that have the same profile as this system.
- BLUETOOTH devices connected with this system must comply with the BLUETOOTH specification prescribed by the BLUETOOTH SIG, Inc., and must be certified to comply. However, even when a device complies with the BLUETOOTH specification, there may be cases where the characteristics or specifications of the BLUETOOTH device make it impossible to connect, or may result in different control methods, display or operation.
- Noise may occur or the audio may cut off depending on the BLUETOOTH device connected with this system, the communications environment, or surrounding conditions.

Playable USB devices and BLUETOOTH devices

USB devices

You can play back the following Sony USB devices on this system. Other USB devices cannot be played back on this system.

Verified Sony digital music player (as of April 2006)

Product name	Model name
Walkman®	NW-E103 / E105 / E107
	NW-E205 / E207
	NW-E303 / E305 / E307
	NW-E403 / E405 / E407
	NW-E503 / E505 / E507
	NW-A605 / A607 / A608
	NW-E002 / E002F / E003 / E003F / E005 / E005F
	NW-HD5
	NW-A1000 / A1200 / A3000

Note

AAC files transferred to a digital music player using SonicStage CP cannot be played by this system.

Verified Sony USB storage media (as of April 2006)

Product name	Model name
MICROVAULT	USM32D / 64D / 128D / 256D / 512D / 1GD
	USM64D/V / 128D/V / 256D/V / 512D/V / 1GD/V
	USM128E / 256E / 512E / 1GE / 2GE
	USM128E/V / 256E/V / 512E/V / 1GE/V / 2GE/V
	USM512EX / 1GEX / 2GEX
	USM128J / 256J / 512J / 1GJ / 2GJ / 4GJ
	USM512JX / 1GJX / 2GJX / 4GJX
	USD2G / 4G / 5G / 8G

Check the websites below for the latest information about compatible devices.

For customers in the U.S.A.:

<<http://www.sony.com/shelfsupport>>

For customers in Canada:

<<http://www.sony.ca/ElectronicsSupport/>>

Notes

- Do not use USB devices other than these USB devices. Operation of models not listed here is not guaranteed.
- Operation may not always be ensured even when using these USB devices.
- Some of these USB devices may not be available for purchase in certain areas.

BLUETOOTH devices

You can check the websites below for the BLUETOOTH compatible devices.

For customers in the U.S.A.:

<<http://www.sony.com/shelfsupport>>

For customers in Canada:

<<http://www.sony.ca/ElectronicsSupport/>>



Printed on 100% recycled
paper using VOC (Volatile Organic
Compound)-free vegetable oil
based ink

Printed in China

<http://www.sony.net/>

Download from [Www.Somanuals.com](http://www.Somanuals.com). All Manuals Search And Download.

Free Manuals Download Website

<http://myh66.com>

<http://usermanuals.us>

<http://www.somanuals.com>

<http://www.4manuals.cc>

<http://www.manual-lib.com>

<http://www.404manual.com>

<http://www.luxmanual.com>

<http://aubethermostatmanual.com>

Golf course search by state

<http://golfingnear.com>

Email search by domain

<http://emailbydomain.com>

Auto manuals search

<http://auto.somanuals.com>

TV manuals search

<http://tv.somanuals.com>