

# ***DVD Home Theatre System***

---

Operating Instructions

**HDMI™**  
HIGH-DEFINITION MULTIMEDIA INTERFACE

**DVD**  
VIDEO™

COMPACT  
**disc**  
DIGITAL VIDEO

COMPACT  
**disc**  
DIGITAL AUDIO  
TEXT

**MP3**

***DAV-DZ230/DZ231***

## WARNING

To reduce the risk of fire or electric shock, do not expose this apparatus to rain or moisture.

**Caution – The use of optical instruments with this product will increase eye hazard.**

Do not install the appliance in a confined space, such as a bookcase or built-in cabinet.

To prevent fire, do not cover the ventilation of the apparatus with news papers, table-cloths, curtains, etc. And don't place lighted candles on the apparatus.

To prevent fire or shock hazard, do not place objects filled with liquids, such as vases, on the apparatus.

Do not expose the battery to excessive heat such as direct sunlight, fire, or the like.



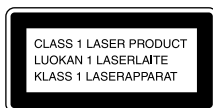

Don't throw away the battery with general house waste, dispose of it correctly as chemical waste.



This appliance is classified as a CLASS 1 LASER product. This marking is located on the rear exterior.

## NOTICE FOR THE CUSTOMERS IN THE UNITED KINGDOM

A moulded plug complying with BS1363 is fitted to this equipment for your safety and convenience.

Should the fuse in the plug supplied need to be replaced, a fuse of the same rating as the supplied one and approved by ASTA or BSI to BS1362, (i.e., marked with mark  or  mark) must be used.

If the plug supplied with this equipment has a detachable fuse cover, be sure to attach the fuse cover after you change the fuse. Never use the plug without the fuse cover.

If you should lose the fuse cover, please contact your nearest Sony service station.



**Disposal of Old Electrical & Electronic Equipment (Applicable in the European Union and other European countries with separate collection systems)**

This symbol on the product or on its packaging indicates that this

product shall not be treated as household waste. Instead it shall be handed over to the applicable collection point for the recycling of electrical and electronic equipment. By ensuring this product is disposed of correctly, you will help prevent potential negative consequences for the environment and human health, which could otherwise be caused by inappropriate waste handling of this product. The recycling of materials will help to conserve natural resources. For more detailed information about recycling of this product, please contact your local Civic Office, your household waste disposal service or the shop where you purchased the product.

## Precautions

### On power sources

- AC power cord (mains lead) must be changed only at the qualified service shop.
- The unit is not disconnected from the AC power source (mains) as long as it is connected to the wall outlet (mains), even if the unit itself has been turned off.
- Install this system so that the AC power cord (mains) can be unplugged from the wall socket immediately in the event of trouble.

## Welcome!

Thank you for purchasing Sony DVD Home Theatre System. Before operating this system, please read this manual thoroughly and retain it for future reference.

# Table of Contents

Welcome! .....	2	Playing in Random Order .....	33
About This Manual .....	5	(Shuffle Play)	
This System Can Play the Following Discs .....	6	Playing Repeatedly .....	34
<b>Getting Started – BASIC –</b>		(Repeat Play)	
<b>Step 1: Connecting the System and TV</b> .....	9	Using the DVD's Menu .....	35
<b>Step 2: Positioning the System</b> ..	13	Changing the Sound .....	35
<b>Step 3: Performing the Quick Setup</b> .....	14	Selecting [ORIGINAL] or [PLAY LIST] on a DVD-R/DVD-RW .....	37
<b>Getting Started – ADVANCED –</b>		Viewing Information About the Disc ...	38
Turning off the Demonstration .....	17	Changing the Angles .....	40
Installing the Speakers on a Wall .....	18	Displaying the Subtitles .....	41
Connecting the TV (Advanced) .....	19	Adjusting the Delay Between the Picture and Sound .....	41
Connecting Other Components .....	21	(A/V SYNC)	
<b>Basic Operations</b>		About MP3 Audio Tracks and JPEG Image Files .....	42
<b>Playing Discs</b> .....	22	Playing DATA CDs or DATA DVDs with MP3 Audio Tracks and JPEG Image Files .....	44
<b>Enjoying the Radio or Other Components</b> .....	23	Playing Audio Tracks and Images as a Slide Show with Sound .....	46
<b>Enjoying TV Sound from All Speakers</b> .....	24	Enjoying DivX® Videos .....	48
<b>Selecting the Movie or Music Mode</b> .....	25	(Except for United Kingdom and North American models)	
<b>Sound Adjustments</b>		Playing VIDEO CDs with PBC Functions (Ver.2.0) .....	50
Enjoying Surround Sound by Using Sound Field .....	26	(PBC Playback)	
<b>Various Functions for Playing Discs</b>		<b>Tuner Functions</b>	
Searching for a Particular Point on a Disc .....	28	Presetting Radio Stations .....	51
(Scan, Slow-motion Play, Freeze Frame)		Listening to the Radio .....	52
Searching for a Title/Chapter/Track/Scene, etc. ....	29	Using the Radio Data System (RDS) ...	53
Searching by Scene .....	30	<b>Other Operations</b>	
(Picture Navigation)		Controlling the TV with the Supplied Remote .....	54
Resuming Playback from the Point Where You Stopped the Disc .....	30	Using the THEATRE SYNC Function .....	54
(Resume Play)		Using the Sound Effect .....	55
Creating Your Own Program .....	31	Using the Sleep Timer .....	56
(Program Play)		Changing the Brightness of the Front Panel Display .....	56
		Using the DIGITAL MEDIA PORT Adapter .....	57
		Deactivating the Buttons on the Unit ... (Child Lock)	58

continued

## **Advanced Settings and Adjustments**

Locking Discs .....	59
(CUSTOM PARENTAL CONTROL, PARENTAL CONTROL)	
Getting Optimal Surround Sound for a Room .....	62
(SPEAKER FORMATION)	
Calibrating the Appropriate Settings Automatically .....	64
(AUTO CALIBRATION)	
Using the Setup Display.....	66
Setting the Display or Sound Track Language .....	68
[LANGUAGE SETUP]	
Settings for the Display.....	68
[SCREEN SETUP]	
Custom Settings .....	70
[CUSTOM SETUP]	
Settings for the Speakers.....	71
[SPEAKER SETUP]	
Returning to the Default Settings.....	74

## **Additional Information**

Precautions .....	75
Notes about the Discs.....	76
Troubleshooting .....	76
Self-diagnosis Function .....	80
(When letters/numbers appear in the display)	
Specifications.....	81
Glossary .....	82
Language Code List .....	85
Index to Parts and Controls.....	86
Guide to the Control Menu Display .....	88
DVD Setup Display List .....	91
System Menu List .....	92
Index .....	93

## About This Manual

- The instructions in this manual describe the controls on the remote. You can also use the controls on the unit if they have the same or similar names as those on the remote.
- The instructions in this manual are for DAV-DZ230 and DAV-DZ231. DAV-DZ230 is the model used for illustration purposes. Any difference in operation is clearly indicated in the text, for example, “DAV-DZ230 only.”
- The Control Menu items may vary depending on the area.
- “DVD” may be used as a general term for DVD VIDEOS, DVD+RWs/DVD+Rs, and DVD-RWs/DVD-Rs.
- Measurements are expressed in feet (ft) for North American models.
- The following symbols are used in this manual.

Symbol	Meaning
<b>DVD-V</b>	Functions available for DVD VIDEOS, DVD-Rs/DVD-RWs in video mode, and DVD+Rs/DVD+RWs
<b>DVD-VR</b>	Functions available for DVD-Rs/DVD-RWs in VR (Video Recording) mode
<b>VIDEO CD</b>	Functions available for VIDEO CDs (including Super VCDs or CD-Rs/CD-RWs in video CD format or Super VCD format)
<b>CD</b>	Functions available for music CDs or CD-Rs/CD-RWs in music CD format
<b>DATA-CD</b>	Functions available for DATA CDs (CD-ROMs/CD-Rs/CD-RWs) containing MP3 <sup>1)</sup> audio tracks, JPEG image files, and DivX <sup>2)3)4)</sup> video files
<b>DATA DVD</b>	Functions available for DATA DVDs (DVD-ROMs/DVD-Rs/DVD-RWs/DVD+Rs/DVD+RWs) containing MP3 <sup>1)</sup> audio tracks, JPEG image files, and DivX <sup>2)3)4)</sup> video files













<sup>1)</sup>MP3 (MPEG1 Audio Layer 3) is a standard format defined by ISO/MPEG which compresses audio data.

<sup>2)</sup>Except for United Kingdom and North American models.

<sup>3)</sup>DivX<sup>®</sup> is a video file compression technology, developed by DivX, Inc.

<sup>4)</sup>DivX, DivX Certified, and associated logos are trademarks of DivX, Inc. and are used under license.

## This System Can Play the Following Discs

Format of discs	Disc logo
DVD VIDEO	
DVD-RW/ DVD-R	 
DVD+RW/ DVD+R	  
VIDEO CD (Ver. 1.1 and 2.0 discs)/ Audio CD	 
CD-RW/CD-R (audio data) (MP3 files) (JPEG files)	   

“DVD-RW,” “DVD+RW,” “DVD+R,”  
“DVD VIDEO,” and the “CD” logos are trademarks.

### Note about CDs/DVDs

The system can play CD-ROMs/CD-Rs/CD-RWs recorded in the following formats:

- audio CD format
- VIDEO CD format
- MP3 audio tracks, JPEG image files, and DivX video files\* of format conforming to ISO 9660 Level 1/Level 2, or its extended format, Joliet

The system can play DVD-ROMs/DVD+RWs/DVD-RWs/DVD+Rs/DVD-Rs recorded in the following formats:

- MP3 audio tracks, JPEG image files, and DivX video files\* of format conforming to UDF (Universal Disk Format)

\* Except for United Kingdom and North American models.

### Example of discs that the system cannot play

The system cannot play the following discs:

- CD-ROMs/CD-Rs/CD-RWs other than those recorded in the formats listed on page 6
- CD-ROMs recorded in PHOTO CD format
- Data part of CD-Extras
- DVD Audios
- Super Audio CD
- DATA DVDs that do not contain MP3 audio tracks, JPEG image files, or DivX video files\*
- \* Except for United Kingdom and North American models.
- DVD-RAMs

Also, the system cannot play the following discs:

- A DVD VIDEO with a different region code (page 7, 84)
- A disc that has a non-standard shape (e.g., card, heart)
- A disc with paper or stickers on it
- A disc that has the adhesive of cellophane tape or a sticker still left on it

### Notes about CD-R/CD-RW/DVD-R/DVD-RW/DVD+R/DVD+RW

In some cases, CD-R/CD-RW/DVD-R/DVD-RW/DVD+R/DVD+RW cannot be played on this system due to the recording quality or physical condition of the disc, or the characteristics of the recording device and authoring software.

The disc will not play if it has not been correctly finalized. For more information, see the operating instructions for the recording device. Note that some playback functions may not work with some DVD+RWs/DVD+Rs, even if they have been correctly finalized. In this case,

view the disc by normal playback. Also some DATA CDs/DATA DVDs created in Packet Write format cannot be played.

### **Music discs encoded with copyright protection technologies**

This product is designed to play back discs that conform to the Compact Disc (CD) standard. Recently, various music discs encoded with copyright protection technologies are marketed by some record companies. Please be aware that among those discs, there are some that do not conform to the CD standard and may not be playable by this product.

### **Note on DualDiscs**

A DualDisc is a two sided disc product which mates DVD recorded material on one side with digital audio material on the other side. However, since the audio material side does not conform to the Compact Disc (CD) standard, playback on this product is not guaranteed.

---

### **About Multi Session CD**

- This system can play Multi Session CDs when an MP3 audio track is contained in the first session. Any subsequent MP3 audio tracks recorded in later sessions can also be played back.
- This system can play Multi Session CDs when a JPEG image file is contained in the first session. Any subsequent JPEG image files recorded in later sessions can also be played back.
- If audio tracks and images in music CD format or video CD format are recorded in the first session, only the first session will be played back.

---

### **Region code**

Your system has a region code printed on the rear of the unit and will only play DVDs labeled with the same region code.

DVD VIDEOS labeled  will also play on this system.

If you try to play any other DVD VIDEO, the message [Playback prohibited by area limitations.] will appear on the TV screen. Depending on the DVD VIDEO, no region code indication may be given even though playing the DVD VIDEO is prohibited by area restrictions.

---

### **Note about playback operations of DVDs and VIDEO CDs**

Some playback operations of DVDs and VIDEO CDs may be intentionally set by software producers. Since this system plays DVDs and VIDEO CDs according to the disc contents the software producers designed, some playback features may not be available. Be sure to read the operating instructions supplied with the DVDs or VIDEO CDs.

---

### **Copyrights**

This product incorporates copyright protection technology that is protected by U.S. patents and other intellectual property rights. Use of this copyright protection technology must be authorized by Macrovision, and is intended for home and other limited viewing uses only unless otherwise authorized by Macrovision. Reverse engineering or disassembly is prohibited.

This system incorporates with Dolby\* Digital and Dolby Pro Logic (II) adaptive matrix surround decoder and the DTS\*\* Digital Surround System.

\* Manufactured under license from Dolby Laboratories.  
“Dolby”, “Pro Logic”, and the double-D symbol are trademarks of Dolby Laboratories.

\*\* Manufactured under license from DTS, Inc.  
“DTS” and “DTS Digital Surround” are registered trademarks of DTS, Inc.

## Getting Started – BASIC –

See Unpacking in Specifications, page 81.

### Inserting batteries into the remote

You can control the system using the supplied remote. Insert two R6 (size AA) batteries by matching the ⊕ and ⊖ ends on the batteries to the markings inside the compartment. To use the remote, point it at the remote sensor  on the unit.

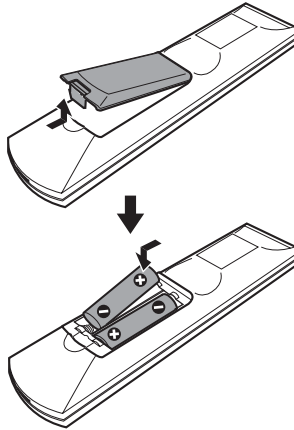

#### Note

- Do not leave the remote in an extremely hot or humid place.
- Do not use a new battery with an old one.
- Do not drop any foreign object into the remote casing, particularly when replacing the batteries.
- Do not expose the remote sensor to direct sunlight or lighting apparatus. Doing so may cause a malfunction.
- If you do not intend to use the remote for an extended period of time, remove the batteries to avoid possible damage from battery leakage and corrosion.

### Attaching the foot pads to the subwoofer

Attach the supplied foot pads to the bottom of the subwoofer to stabilize the subwoofer and prevent it from slipping.

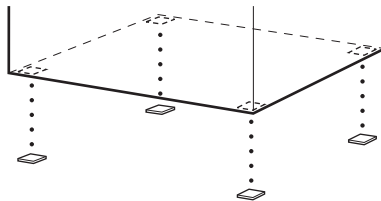



## Step 1: Connecting the System and TV

The following is the basic connection of the unit to the speakers and TV. For other TV connections, see page 19. For other component connection, see page 21.

Refer to the connection diagram below, and read the additional information from ① to ④ on the following pages.

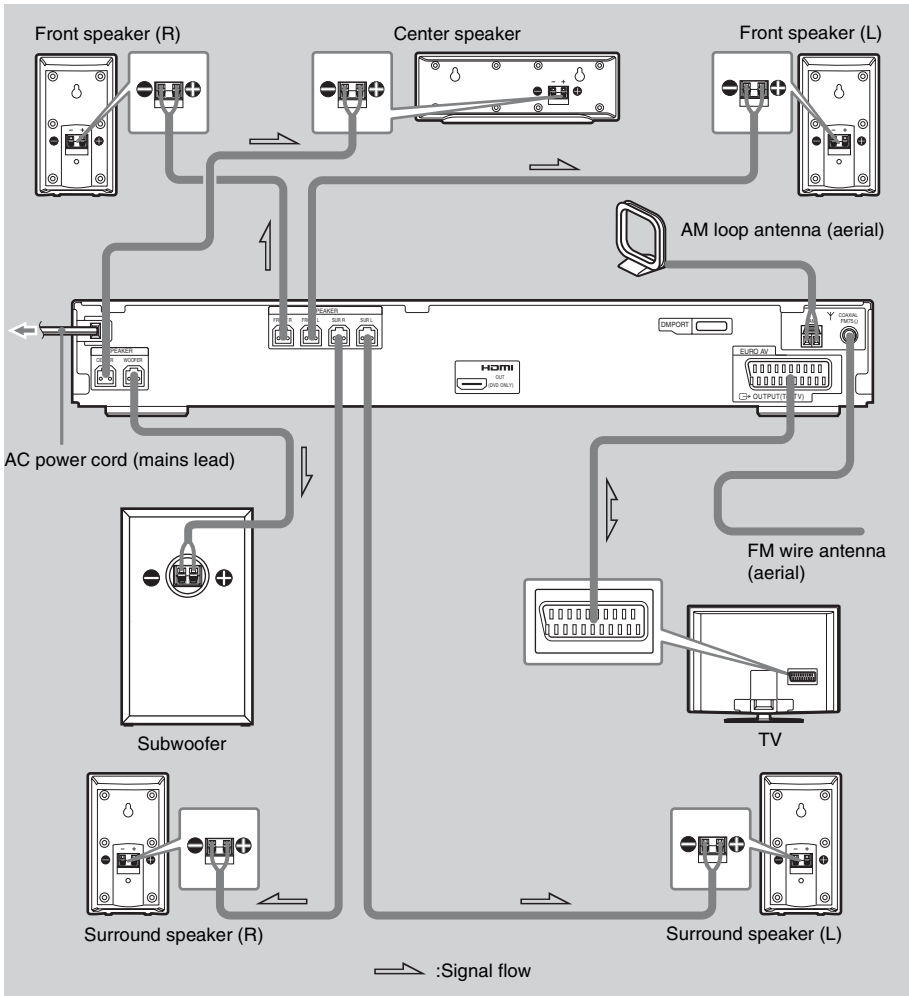

continued

9GB

## ① Connecting the Speakers

### Required cords

The connector and color tube of the speaker cords are the same color as the label of the jacks to be connected.

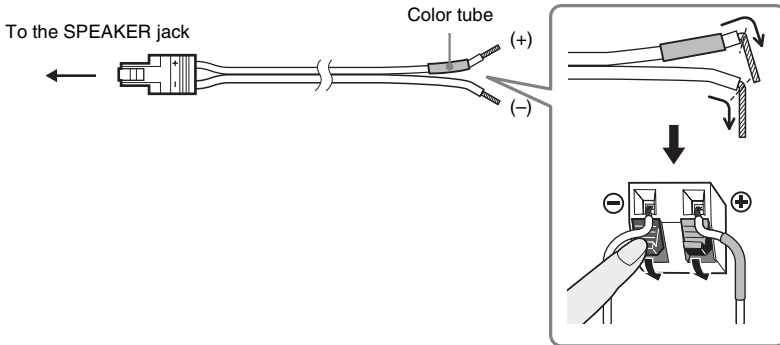

#### Note

- Do not catch the speaker cord insulation in the SPEAKER jack.

### To avoid short-circuiting the speakers

Short-circuiting of the speakers may damage the system. To prevent this, be sure to follow these precautions when connecting the speakers. Make sure the bare wire of each speaker cord does not touch another speaker terminal or the bare wire of another speaker cord, such as shown below.

Stripped speaker cord is touching another speaker terminal.

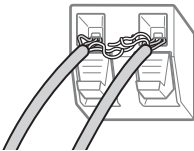

Stripped cords are touching each other due to excessive removal of insulation.

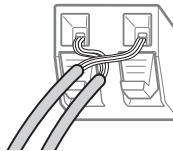

After connecting all the components, speakers, and AC power cord (mains lead), output a test tone to check that all the speakers are connected correctly. For details on outputting a test tone, see page 73. If no sound is heard from a speaker while outputting a test tone, or a test tone is output from a speaker other than the one currently displayed on the Setup Display, the speaker may be short-circuited. If this happens, check the speaker connection again.

#### Note

- Be sure to match the speaker cord to the appropriate terminal on the components: ⊕ to ⊕, and ⊖ to ⊖. If the cords are reversed, the sound will lack bass and may be distorted.

## ② Connecting the TV

### Required cords

#### SCART (EURO AV) cord (not supplied)



Be sure to connect the SCART (EURO AV) cord to the EURO AV  OUTPUT (TO TV) jack on the unit.

When you connect using the SCART (EURO AV) cord, check that the TV conforms to S video or RGB signals. If the TV conforms to S video, change the input mode of the TV to RGB signals. Refer to the operating instructions supplied with the TV to be connected.

#### Tip

- When you want to output the TV sound or stereo sound of a 2 channel source from the 6 speakers, select the “Dolby Pro Logic,” “Dolby Pro Logic II MOVIE,” or “Dolby Pro Logic II MUSIC” sound field (page 26).

## ③ Connecting the Antenna (Aerial)

### To connect the AM loop antenna (aerial)

The shape and the length of the antenna (aerial) is designed to receive AM signals. Do not dismantle or roll up the antenna (aerial).

- 1** Remove only the loop part from the plastic stand.
- 2** Set up the AM loop antenna (aerial).

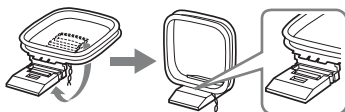

- 3** Connect the cords to the AM antenna (aerial) terminals.

Cord (A) or cord (B) can be connected to either terminal.

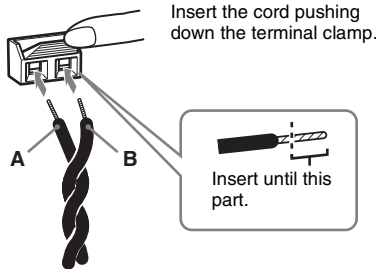
**Note**

- Do not place the AM loop antenna (aerial) near the unit or other AV equipment, as noise may result.

**Tip**

- Adjust the direction of the AM loop antenna (aerial) for best AM broadcast sound.

#### 4 Make sure the AM loop antenna (aerial) is connected firmly by pulling softly.

#### To connect the FM wire antenna (aerial)

Connect the FM wire antenna (aerial) to the COAXIAL FM 75  $\Omega$  jack.

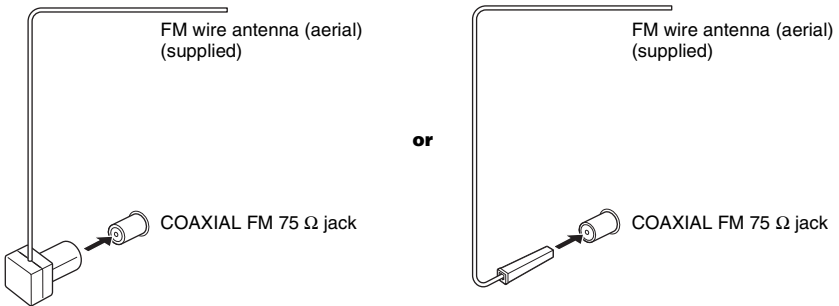
**Note**

- Be sure to fully extend the FM wire antenna (aerial).
- After connecting the FM wire antenna (aerial), keep it as horizontal as possible.

**Tip**

- If you have poor FM reception, use a 75-ohm coaxial cable (not supplied) to connect the unit to an outdoor FM antenna (aerial) as shown below.

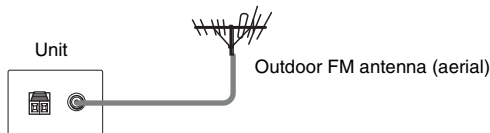

#### ④ Connecting the AC power cord (mains lead)

Before connecting the AC power cord (mains lead) of this unit to a wall outlet (mains), connect the speakers to the unit.

## Step 2: Positioning the System

### Positioning the speakers

For the best possible surround sound, all the speakers other than the subwoofer should be placed at the same distance from the listening position (A).

However, this system allows you to place the center speaker up to 1.6 meters (5 ft) closer (B) and the surround speakers up to 5.0 meters (16 ft) closer (C) to the listening position.

The front speakers can be placed from 1.0 to 7.0 meters (3 to 23 ft) (A) from the listening position.

Place speakers as illustrated below.

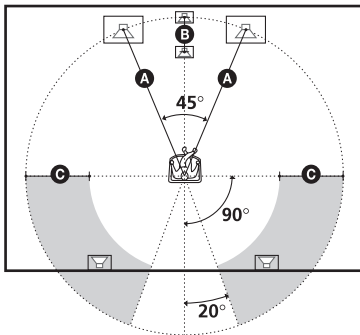

#### Note

- Do not set the speakers in an inclined position.
- Do not place the speakers in locations that are:
  - Extremely hot or cold
  - Dusty or dirty
  - Very humid
  - Subject to vibrations
  - Subject to direct sunlight
- When cleaning, use a soft cloth such as a cleaning cloth for glasses.
- Do not use any type of abrasive pad, scouring powder, or solvent such as alcohol or benzine.

#### Tip

- When you change the positions of the speakers, it is recommended that you change the settings. For details, see “Getting Optimal Surround Sound for a Room” (page 62) and “Calibrating the Appropriate Settings Automatically” (page 64).

## Step 3: Performing the Quick Setup

Follow the steps below to make the minimum number of basic adjustments for using the system.

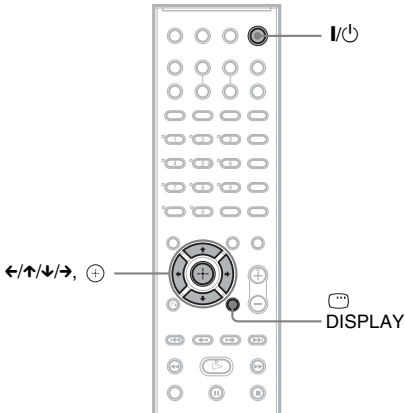

**1** Turn on the TV.

**2** Press I/O.

**Note**

- Disconnect the headphones when you perform the Quick Setup. You cannot operate steps after 11 with the headphones connected.
- Make sure that the function is set to “DVD” (page 22).

**3** Switch the input selector on your TV so that the signal from the system appears on the TV screen.

[Press [ENTER] to run QUICK SETUP.] appears at the bottom of the TV screen. If this message does not appear, recall the Quick Setup display (page 15) and perform again.

**4** Press + without inserting a disc.

The Setup Display for selecting the language used in the on-screen display appears.

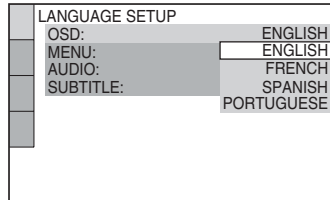

**5** Press ↑/↓ to select a language.

The system displays the menu and subtitles in the selected language.

**6** Press +.

The Setup Display for selecting the aspect ratio of the TV to be connected appears.

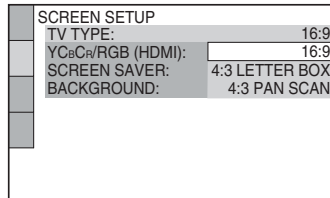

**7** Press ↑/↓ to select the setting that matches your TV type.

■ If you have a wide-screen TV or a 4:3 standard TV with a wide-screen mode [16:9] (page 68)

■ If you have a 4:3 standard TV [4:3 LETTER BOX] or [4:3 PAN SCAN] (page 68)

**8** Press +.

The Setup Display for selecting the speaker formation appears.

**9** Press ←/→ to select the speaker formation image as the speakers are actually positioned.

For details, see “Getting Optimal Surround Sound for a Room” (page 62).

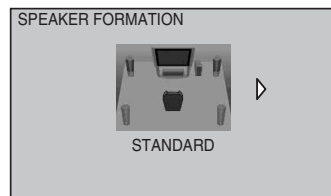

**10** Press  $\oplus$ .

**11** Connect the calibration mic to the **A.CAL MIC** jack on the front panel and press  $\uparrow/\downarrow$  to select [YES].

Set up the calibration mic at the ear level using a tripod, etc. (not supplied). The front of each speaker should face the calibration mic, and there should be no obstruction between the speakers and the calibration mic. Be quiet during the measurement.

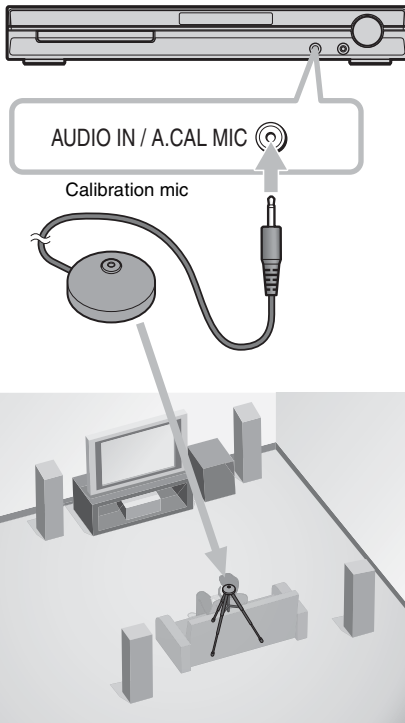

**12** Press  $\oplus$ .

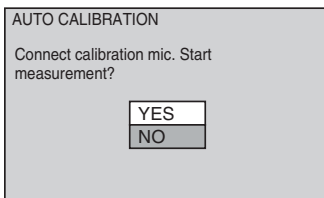

Auto Calibration starts.

**Note**

- Loud test sound is output when [AUTO CALIBRATION] starts. You cannot turn the volume down. Give consideration to children and neighbor.
- Avoid being in the measurement area and making noise during the measurement (which takes about 3 minutes), as it may interfere with measurement.

**13** Unplug the calibration mic and press  $\leftarrow/\rightarrow$  to select [YES].

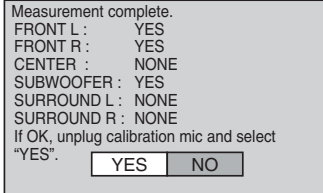

**Note**

- The environment of the room in which the system is installed may affect measurements.
- If measurement fails, follow the message then retry [AUTO CALIBRATION].
- When you select [SECOND ROOM] for [SPEAKER FORMATION], measurement of [SURROUND L] and [SURROUND R] is not displayed.

**14** Press  $\oplus$ .

Quick Setup is finished. All connections and setup operations are complete.

**To quit the Quick Setup**

Press  $\square$  DISPLAY in any Step.

**Tip**

- If you change the position of the speakers, reset the speaker settings. See “Getting Optimal Surround Sound for a Room” (page 62) and “Calibrating the Appropriate Settings Automatically” (page 64).
- If you want to change any of the settings, see “Using the Setup Display” (page 66).

**To recall the Quick Setup display**

**1** Press  $\square$  DISPLAY when the system is in stop mode.

The Control Menu display appears.

**2** Press  $\uparrow/\downarrow$  to select  [SETUP], then press  $\oplus$ .

The options for [SETUP] appear.

*continued*

15<sup>GB</sup>

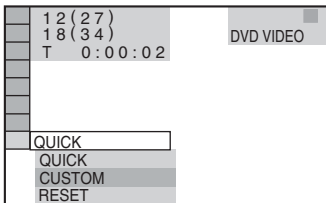

- 3** Press  $\uparrow/\downarrow$  to select [QUICK], then press  $\oplus$ .

The Quick Setup display appears.

### Selecting the output method for video signals

Selects the output method for video signals from the EURO AV  $\hookrightarrow$  OUTPUT (TO TV) jack on the rear panel of the unit.

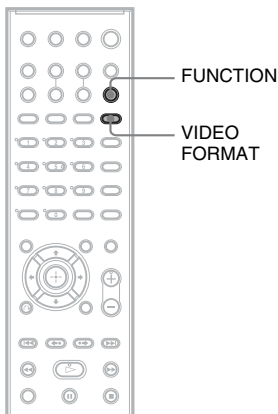

- 1** Press **FUNCTION** repeatedly to select “DVD.”

- 2** Press **VIDEO FORMAT**.

Each time you press VIDEO FORMAT, the display changes as follows:

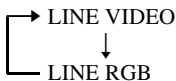

- “LINE VIDEO”: outputs video signals.
- “LINE RGB”: outputs RGB signals.

#### Note

- If your TV does not accept RGB signals, no picture appears on the TV screen even if you select “LINE RGB.” Refer to the operating instructions supplied with your TV.



## Turning off the Demonstration

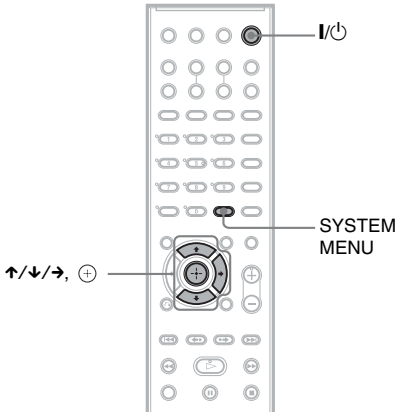

After connecting the AC power cord (mains lead), the demonstration appears in the front panel display. When you press I/⏻ on the remote, the demonstration turns off.

### Note

- When you press I/⏻ on the unit, the demonstration does not turn off.
- When you set the demonstration mode in the system menu to on, the demonstration does not turn off even though you press I/⏻ on the remote. To turn off the demonstration, set the demonstration mode to off, then press I/⏻ on the remote. When the demonstration mode is set to off, the system saves power in standby mode.
- If the system is at its factory default settings (ex. after performing “COLD RESET” (page 74)), you can turn off the demonstration simply by pressing I/⏻ on the remote. Otherwise, to stop the demonstration, you need to set “DEMO” to “DEMO OFF.”

## Setting the demonstration mode to on/off

- 1 Press SYSTEM MENU.**
- 2 Press ↑/↓ repeatedly until “DEMO” appears in the front panel display, then press ⊕ or →.**
- 3 Press ↑/↓ to select a setting.**

The default setting is underlined.

  - “DEMO ON”: sets the demonstration mode to on.
  - “DEMO OFF”: sets the demonstration mode to off.
- 4 Press ⊕.**

The setting is made.
- 5 Press SYSTEM MENU.**

The system menu turns off.

# Installing the Speakers on a Wall

You can use the speakers by installing on the wall.

## Installing the speakers on a wall

- 1 Prepare screws (not supplied) that are suitable for the hole on the back of each speaker. See the illustrations below.

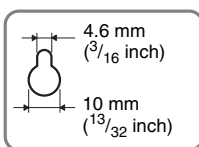
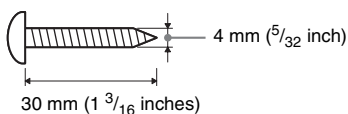

Hole on the back of the speaker

- 2 Fasten the screws to the wall.

**For the center speaker**

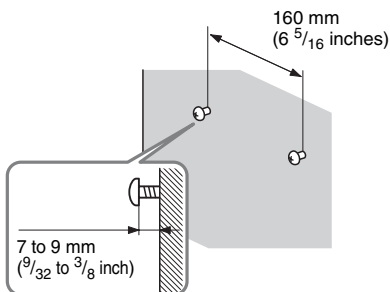

**For the other speakers**

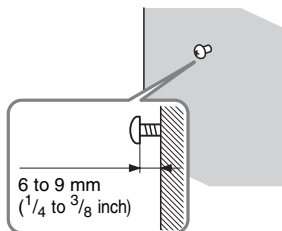

- 3 Hang the speakers on the screws.

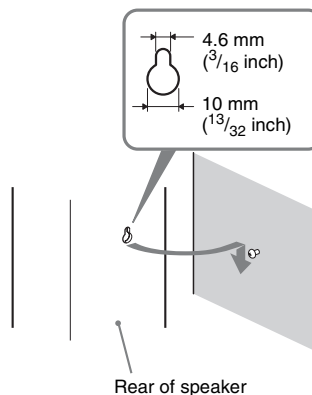

### Note

- Use screws that are suitable for the wall material and strength. As a plaster board wall is especially fragile, attach the screws securely to a beam and fasten them to the wall. Install the speakers on a vertical and flat wall where reinforcement is applied.
- Contact a screw shop or installer regarding the wall material or screws to be used.
- Sony is not responsible for accident or damage caused by improper installation, insufficient wall strength or improper screw installation, natural calamity, etc.

## Connecting the TV (Advanced)

Sends the played back DVD image to the connected TV.

Check the jacks of your TV, and choose connection method **A** or **B**. Picture quality improves in order from **A** (standard) to **B** (HDMI).

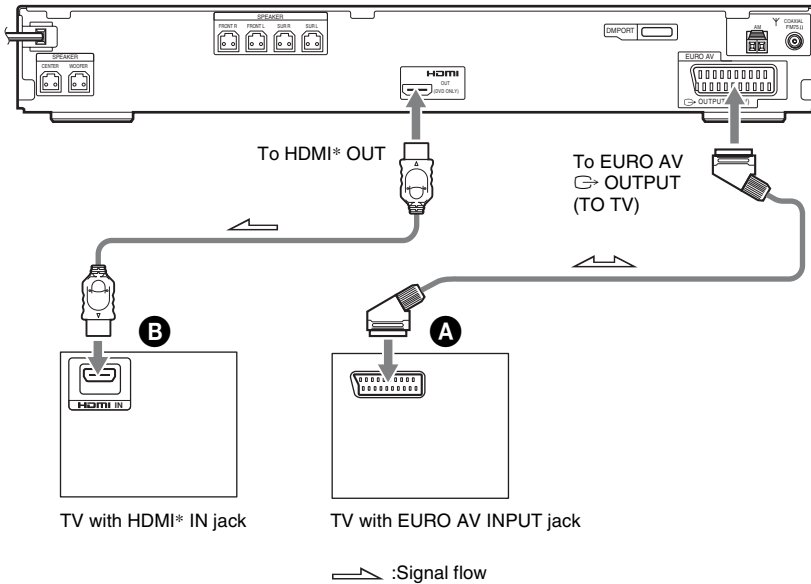

\* HDMI (high-definition multimedia interface)

The system incorporates High-Definition Multimedia Interface (HDMI™) technology.

HDMI, the HDMI logo and High-Definition Multimedia Interface are trademarks or registered trademarks of HDMI Licensing LLC.

### Note

- When you connect the system and TV with the HDMI cord and the SCART (EURO AV) cord simultaneously, the TV may be set to SCART (EURO AV) input automatically. In this case, set to the desired input source on the TV, or use a SCART (EURO AV) cord that has separate audio connectors.

### **A** To connect to a TV with the SCART (EURO AV) cord (not supplied)



Be sure to connect the SCART (EURO AV) cord to the EURO AV  OUTPUT (TO TV) jack on the unit.

When you connect using the SCART (EURO AV) cord, check that the TV conforms to S video or RGB signals. If the TV conforms to S video, change the input mode of the TV to RGB signals. Refer to the operating instructions supplied with the TV to be connected.

## **B To connect to a TV with the HDMI (high-definition multimedia interface)/DVI (digital visual interface) IN jack**

Use a certified HDMI (high-definition multimedia interface) cord (not supplied) to enjoy high quality digital picture and sound through the HDMI OUT (high-definition multimedia interface out) jack.



### **To connect to a TV with DVI (digital visual interface) input**

Use an HDMI (high-definition multimedia interface)-DVI (digital visual interface) converter cord (not supplied) with an HDMI (high-definition multimedia interface)-DVI (digital visual interface) adaptor (not supplied). The DVI (digital visual interface) jack will not accept any audio signals. Furthermore, you cannot connect the HDMI OUT (high-definition multimedia interface out) jack to DVI (digital visual interface) jacks that are not HDCP (high-bandwidth digital content protection) compliant (e.g., DVI (digital visual interface) jacks on the computer displays).

### **To select the type of video signal output from the HDMI OUT (high-definition multimedia interface out) jack**

When you connect the unit and the TV with the HDMI cord, selects the type of video signals output from the HDMI OUT (high-definition multimedia interface out) jack.

For details, refer also to the operating instructions supplied with the TV/projector, etc.

**1 Press FUNCTION repeatedly to select “DVD.”**

**2 Press VIDEO FORMAT.**

The current type of video signals appears in the front panel display.

Each time you press VIDEO FORMAT, the display changes as follows:

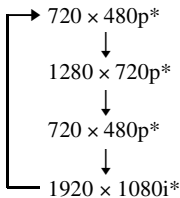

- “720 × 480p\*”: Sends 720 × 480p video signals.\*\*
- “1280 × 720p\*”: Sends 1280 × 720p video signals.
- “1920 × 1080i\*”: Sends 1920 × 1080i video signals.

\*i: interlace, p: progressive

\*\*Depending on the country, [720 × 576p] may appear.

#### **Note**

- When the HDMI indicator on the front panel lights up, images other than [720 × 480p] or [720 × 576p] are stretched vertically.

### **When connecting to a standard 4:3 screen TV**

Depending on the disc, the image may not fit your TV screen.

To change the aspect ratio, see page 68.

## Connecting Other Components

You can enjoy sound using the speakers of this system by connecting the AUDIO OUT jacks of another component.

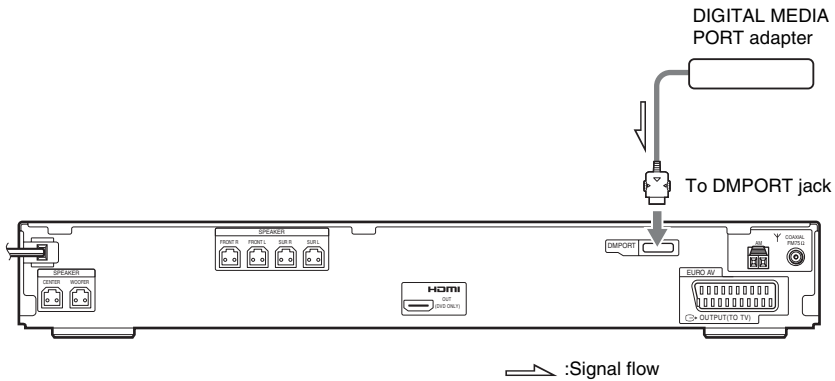

### To connect the DIGITAL MEDIA PORT adapter

Connect a DIGITAL MEDIA PORT adapter (not supplied) to the DMPORT jack. For details of the DIGITAL MEDIA PORT adapter, see “Using the DIGITAL MEDIA PORT Adapter” (page 57).

### To listen to the portable audio source sound through the system

Connect the audio output jacks of the portable audio source to the AUDIO IN jack on the front panel of the unit with the stereo mini-plug cord (not supplied).



#### Tip

• When listening to MP3 format recordings using a portable audio source, you can enhance the sound.

Press FUNCTION to select “AUDIO.” Connect the portable audio source. Press SOUND FIELD repeatedly until “A.F.D. STD” appears in the front panel display.

To cancel, select other than “A.F.D. STD.”

#### Note

• Be sure to make connections securely to avoid hum and noise.

• When you connect another component with a volume control, turn up the volume of the other components to a level where sound is not distorted.

## Basic Operations

### Playing Discs

DVD-V

DVD-VR

VIDEO CD

C D

DATA-CD

DATA DVD

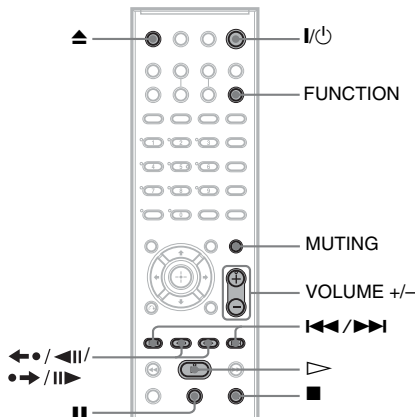
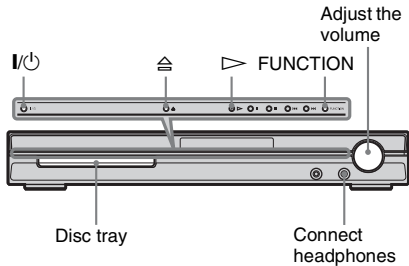

Depending on the DVD VIDEO or VIDEO CD, some operations may be different or restricted. Refer to the operating instructions supplied with your disc.

- 1 Turn on your TV.**
- 2 Switch the input selector on the TV to this system.**
- 3 Press I/⏻.**  
The system turns on.  
Unless the system is set to "DVD," press FUNCTION to select "DVD."
- 4 Press ⏮.**

## 5 Load a disc.

Place one disc on the tray, and then press ⏮.

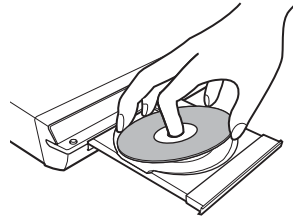

### Note

- When you play an 8 cm disc, place it on the inner circle of the tray. Be careful that the disc is not skewed on the inner circle of the tray.
- Do not forcibly press the disc tray closed with your finger, as this may cause malfunction.
- Do not place more than one disc on the tray.

## 6 Press ⏮.

The system starts playback (continuous play).

Adjust the volume on the unit.

The volume level appears on the TV screen and in the front panel display.

### Note

- Depending on the system status, the volume level may not appear on the TV screen.
- When you set the HDMI CONTROL function to on (page 70), the TV that is connected to the system with the HDMI cord can be synch-operated with the system. For details, see the HDMI CONTROL Guide (supplied separately).

### Tip

- When you connect the system and TV with the HDMI cord, you can operate them simply, using the HDMI CONTROL function. For details, see the HDMI CONTROL Guide (supplied separately).

## To save the power in standby mode

Press I/⏻ while the system turns on. To cancel standby mode, press I/⏻ once.

## Additional operations

To	Press
Stop	■
Pause	
Resume play after pause	or ▷
Go to the next chapter, track, or scene	▶▶ (except for JPEG)
Go back to the preceding chapter, track, or scene	◀◀ (except for JPEG)
Turn off the sound temporarily	MUTING. To cancel, press it again or VOLUME + to adjust the sound volume.
Stop play and remove the disc	▲ on the remote or ≡ on the unit.
Replay the previous scene*	◀• / ◀   (instant replay) during playback.
Briefly fast forward the current scene**	•▶▶ /   ▶▶ (instant advance) during playback.

\* DVD VIDEOS/DVD-RWs/DVD-Rs only. The button can be used except for DivX video files (except for United Kingdom and North American models).

\*\* DVD VIDEOS/DVD-RWs/DVD-Rs/DVD+RWs/DVD+Rs only. The button can be used except for DivX video files (except for United Kingdom and North American models).

### Note

- You may not be able to use the instant replay or instant advance function with some scenes.

## Enjoying the Radio or Other Components

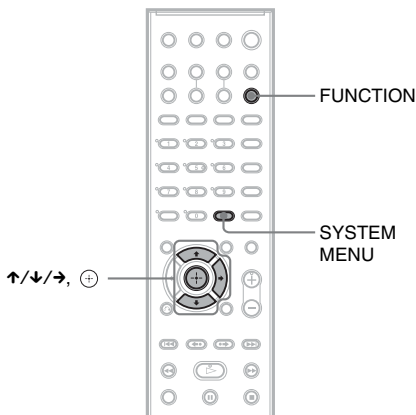

### Selecting the connected component

Press **FUNCTION** repeatedly until the desired function name appears in the front panel display.

Each time you press **FUNCTION**, the mode of the system changes in the following sequence.

DVD → TUNER FM → TUNER AM →  
TV → DMPORT → AUDIO → ...

### Changing the input level of the sound from connected components

Distortion may occur when listening to a TV connected to the EURO AV ⇄ OUTPUT (TO TV) jack on the rear panel or a component connected to the AUDIO IN jack on the front panel. This is not a malfunction and will depend on the component connected.

To prevent this, you can change the input level from the sound of the other components.

- 1 Press **FUNCTION** repeatedly until “TV” or “AUDIO” appears in the front panel display.

continued

23<sup>GB</sup>

- 2** Press **SYSTEM MENU**.
- 3** Press **↑/↓** repeatedly until **“ATTENUATE”** appears in the front panel display, then press **⊕** or **→**.
- 4** Press **↑/↓** to select a setting.
 

The default setting is underlined.

  - **“ATT ON”**: attenuates the input level. The output level is changed.
  - **“ATT OFF”**: normal input level.
- 5** Press **⊕**.
 

The setting is made.
- 6** Press **SYSTEM MENU**.
 

The system menu turns off.

## Enjoying TV Sound from All Speakers

You can enjoy TV sound from all the speakers in this system.

For details, see “Step 1: Connecting the System and TV” (page 9) and “Connecting the TV (Advanced)” (page 19).

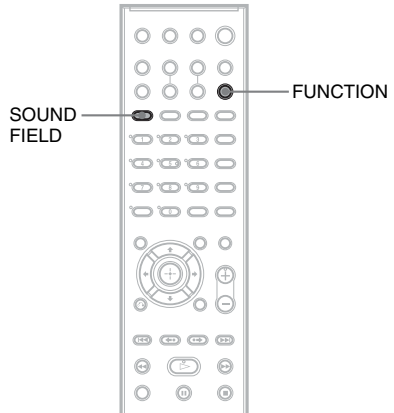

- 1** Press **FUNCTION** repeatedly until **“TV”** appears in the front panel display.
- 2** Press **SOUND FIELD** repeatedly until the sound field you want appears in the front panel display.

When you want to output the TV sound or stereo sound of a 2 channel source from the 6 speakers, select the **“PRO LOGIC,” “PLII MOVIE,”** or **“PLII MUSIC”** sound field.

For details of sound field, see page 26.

### Note

- When you set the [HDMI CONTROL] setting in [CUSTOM SETUP] to [ON] (page 70), the System Audio Control function is activated and no sound may be output from the TV. For details of the System Audio Control function, see the HDMI CONTROL Guide (supplied separately).



## Selecting the Movie or Music Mode

You can choose a suitable sound mode for movies or music.

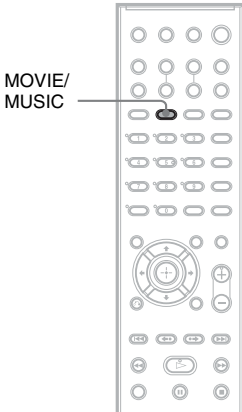

### Press MOVIE/MUSIC during playback.

Press MOVIE/MUSIC repeatedly until the mode you want lights up in the front panel display. The default setting is underlined.

- AUTO: selects the mode automatically to produce the sound effect depending on the disc.
- MOVIE: provides the sound for movies.
- MUSIC: provides the sound for music.

#### Tip

- When the movie or music mode is selected, “MOVIE” or “MUSIC” is displayed in the front panel display. When neither “MOVIE” or “MUSIC” is displayed in the front panel display, “AUTO” is selected.

#### Note

- You cannot operate these setup items when you connect headphones to the unit.

## Sound Adjustments

# Enjoying Surround Sound by Using Sound Field

You can take advantage of surround sound simply by selecting one of the system's pre-programmed sound fields. They bring exciting and powerful sound of movie theaters into your home.

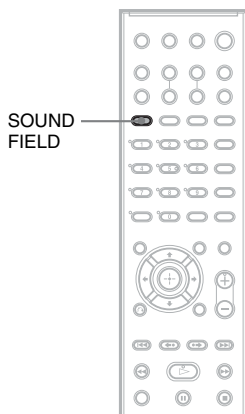

### Press SOUND FIELD.

Press SOUND FIELD repeatedly until the sound field you want appears in the front panel display.

### All sound field

Sound field	Display
AUTO FORMAT DIRECT STANDARD	A.F.D. STD
AUTO FORMAT DIRECT MULTI	A.F.D. MULTI
Dolby Pro Logic	PRO LOGIC
Dolby Pro Logic II MOVIE	PLII MOVIE
Dolby Pro Logic II MUSIC	PLII MUSIC
2 CHANNEL STEREO	2CH STEREO
HEADPHONE	HP 2CH
2 CHANNEL STEREO	
HEADPHONE VIRTUAL	HP VIRTUAL

## Automatic outputting of the original sound

### ■ AUTO FORMAT DIRECT STANDARD

The auto decoding function automatically detects the type of audio signal being input (Dolby Digital, DTS, or standard 2 channel stereo) and performs the proper decoding if necessary. This mode presents the sound as it was recorded/encoded, without adding any effects (e.g. reverberation).

However, if there are no low frequency signals (Dolby Digital LFE, etc.), it will generate a low frequency signal for output to the subwoofer.

## Outputting the sound from multiple speakers

### ■ AUTO FORMAT DIRECT MULTI

This mode lets you enjoy audio playback of all types of discs from multiple speakers.

#### Note

- The sound is not output from multiple speakers depending on the source.

## Outputting 2 channel sources like CDs by 5.1 channel

### ■ Dolby Pro Logic

Dolby Pro Logic produces five output channels from 2 channel sources. This mode performs Pro Logic decoding to the input signal and output to front, center, and surround speakers.

Meanwhile, the surround channel becomes monaural.

### ■ Dolby Pro Logic II MOVIE/MUSIC

Dolby Pro Logic II produces five full-bandwidth output channels from 2 channel sources. This is done using an advanced, high-purity matrix surround decoder that extracts the spatial properties of the original recording without adding any new sounds or tonal colorations.

#### Note

- When the input signal is multi channel source, Dolby Pro Logic and Dolby Pro Logic II MOVIE/MUSIC are canceled and the multi channel source is output directly.

- When the bilingual broadcast sound is input, Dolby Pro Logic and Dolby Pro Logic II MOVIE/MUSIC are not effective.

---

## Using only the front speaker and subwoofer

### ■ 2 CHANNEL STEREO

This mode outputs the sound from the front left and right speakers and subwoofer. Standard 2 channel (stereo) sources completely bypass the sound field processing. Multi channel surround formats are downmixed to two channels.

This allows you to play any source using only the front left and right speakers and subwoofer.

---

## Enjoying the surround sound by headphones

### ■ HEADPHONE 2 CHANNEL STEREO

This mode outputs the sound from headphone L/R. Standard 2 channel (stereo) sources completely bypass the sound field processing. Multi channel surround formats are downmixed to two channels.

### ■ HEADPHONE VIRTUAL

This mode outputs the sound as surround from headphone L/R. This mode is effective only when a multi channel source is played.

### To turn the surround effect off

Press SOUND FIELD repeatedly until “A.F.D. STD” or “2CH STEREO” appears in the front panel display.

## Various Functions for Playing Discs

### Searching for a Particular Point on a Disc

*(Scan, Slow-motion Play, Freeze Frame)*

DVD-V DVD-VR VIDEO CD C D DATA-CD

DATA DVD

You can quickly locate a particular point on a disc by monitoring the picture or playing back slowly.

#### Note

- Depending on the DVD/DivX video\*/VIDEO CD, you may not be able to do some of the operations described.
- \* Except for United Kingdom and North American models.

### Locating a point quickly by playing a disc in fast forward or fast reverse (Scan)

**(Except for JPEG)**

Press **<|/|<<** or **>>|/|>** while playing a disc. When you find the point you want, press **>** to return to normal speed. Each time you press **<|/|<<** or **>>|/|>** during scan, the playback speed changes. With each press the indication changes as shown below. Actual speeds may differ with some discs.

Playback direction

×2▶ → 1▶▶ → 2▶▶▶ → 3▶▶▶



3▶▶▶ (DVD VIDEO/DVD-VR mode/DivX video\*/VIDEO CD only)

×2▶▶ (DVD VIDEO/CD only)

- \* Except for United Kingdom and North American models.

Opposite direction

×2◀ → 1◀◀ → 2◀◀◀ → 3◀◀◀



3◀◀◀ (DVD VIDEO/DVD-VR mode/DivX video\*/VIDEO CD only)

×2◀◀ (DVD VIDEO only)

- \* Except for United Kingdom and North American models.

With each press, playback speed becomes faster.

### Watching frame by frame (Slow-motion Play)

**(DVD VIDEO, DVD-R, DVD-RW, DivX video\*, VIDEO CD only)**

- \* Except for United Kingdom and North American models.

Press **<|/|<<** or **>>|/|>** when the system is in pause mode. To return to normal playback speed, press **>**. Each time you press **<|/|<<** or **>>|/|>** during Slow-motion Play, the playback speed changes. Two speeds are available. With each press the indication changes as follows:

Playback direction

2▶▶ ↔ 1▶▶

Opposite direction (DVD VIDEO only)

2◀◀ ↔ 1◀◀

### Playing one frame at a time (Freeze Frame)

**(DVD VIDEO, DVD-R, DVD-RW, DivX video\*, VIDEO CD only)**

- \* Except for United Kingdom and North American models.

When the system is in the pause mode, press **•→/|/|>** (step) to go to the next frame. Press **<←•/|/|<** (step) to go to the preceding frame (DVD VIDEO/DVD-R/DVD-RW only). To return to normal playback, press **>**.

#### Note



- You cannot search for a still picture on a DVD-R/ DVD-RW in VR mode.
- For DATA CDs/DATA DVDs, this function works only for DivX video files (except for United Kingdom and North American models).

# Searching for a Title/ Chapter/Track/Scene, etc.

DVD-V DVD-VR VIDEO CD CD DATA-CD

DATA DVD

You can search a DVD by title or chapter, and you can search a VIDEO CD/CD/DATA CD/DATA DVD by track, index, or scene. As titles and tracks are assigned unique numbers on the disc, you can select the desired one by entering its number. Or, you can search for a scene using the time code.

- 1 Press  DISPLAY. (When playing a DATA CD/DATA DVD with JPEG image files, press  DISPLAY twice.)**  
The Control Menu display appears.
- 2 Press  to select the search method.**

The display will show different items depending on the disc.

 [TITLE], [TRACK], [SCENE]

 [CHAPTER], [INDEX]

 [TIME/TEXT]

Select [TIME/TEXT] to search for a starting point by inputting the time code.

 [TRACK]

 [ALBUM]

 [FILE]

Example: when you select  [CHAPTER]  
[\*\* (\*\*)] is selected (\*\* refers to a number).  
The number in parentheses indicates the total number of titles, chapters, tracks, indexes, scenes, albums or files.

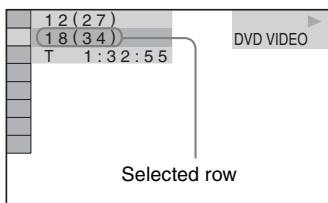

- 3 Press .**

[\*\* (\*\*)] changes to [-- (\*\*)].

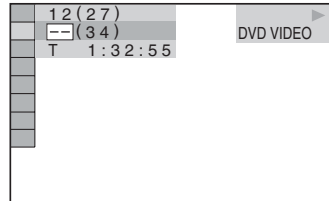

- 4 Press  or the number buttons to select the title, chapter, track, index, scene, etc., number you want to search for.**



### If you make a mistake

Cancel the number by pressing CLEAR, then select another number.

- 5 Press .**

The system starts playback from the selected number.

### To search for a scene using the time code (DVD VIDEO and DVD-VR mode only)

- 1 In Step 2, select  [TIME/TEXT].**  
[T \*\*:\*\*:\*\*] (playing time of the current title) is selected.
- 2 Press .**  
[T \*\*:\*\*:\*\*] changes to [T --:--:--].
- 3 Input the time code using the number buttons, then press .**

For example, to find the scene at 2 hours, 10 minutes, and 20 seconds after the beginning, just enter [2:10:20].

#### Tip

- When the Control Menu display is turned off, you can search for a chapter (DVD VIDEO/DVD-R/DVD-RW), track (VIDEO CD/CD), or file\* (DATA CD/DATA DVD (DivX video)) by pressing the number buttons and .

\* Except for United Kingdom and North American models.

#### Note

- You cannot search for a scene on a DVD+RW using the time code.

## Searching by Scene

### (Picture Navigation)

DVD-V VIDEO CD

You can divide the TV screen into 9 subscreens and find the desired scene quickly.

#### 1 Press PICTURE NAVI during playback.

The following display appears.

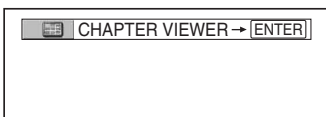

#### 2 Press PICTURE NAVI repeatedly to select an item.

- [TITLE VIEWER] (DVD VIDEO only)
- [CHAPTER VIEWER] (DVD VIDEO only)
- [TRACK VIEWER] (VIDEO CD/Super VCD only)

#### 3 Press $\oplus$ .

The first scene of each title, chapter, or track appears as follows.

1	2	3
4	5	6
7	8	9

#### 4 Press $\leftarrow/\uparrow/\downarrow/\rightarrow$ to select a title, chapter, or track, and press $\oplus$ .

The system starts playback from the selected scene.

### To return to normal play during setting

Press  $\curvearrowright$  RETURN.

#### Note

- Depending on the disc, you may not be able to select some items.

## Resuming Playback from the Point Where You Stopped the Disc

### (Resume Play)

DVD-V DVD-VR VIDEO CD C D DATA-CD  
DATA DVD

When you stop the disc, the system remembers the point where you pressed  $\blacksquare$  and "RESUME" appears in the front panel display. As long as you do not remove the disc, Resume Play will work even if the system enters standby mode by pressing  $I/\odot$ .

#### 1 While playing a disc, press $\blacksquare$ to stop playback.

"RESUME" appears in the front panel display.

If "RESUME" does not appear, Resume Play is not available.

#### 2 Press $\triangleright$ .

The system starts playback from the point where you stopped the disc in Step 1.

#### Note

- Depending on where you stop the disc, the system may not resume playback from exactly the same point.
- The point where you stopped playing may be cleared when:
  - you eject the disc.
  - the system enters standby mode (DATA CD/ DATA DVD only).
  - you change or reset the settings on the Setup Display.
  - you change the parental control level.
  - you change the function by pressing FUNCTION.
  - you disconnect the AC power cord (mains lead).
- For DVD-Rs/DVD-RWs in VR mode, VIDEO CDs, CDs, DATA CDs, and DATA DVDs, the system remembers the resume playback point for the current disc.
- Resume Play does not work during Program Play and Shuffle Play.
- This function may not work properly with some discs.

**Tip**

- To play from the beginning of the disc, press **■** twice, then press **▷**.

**To enjoy a disc that is played before by resume playback (Multi-disc Resume) (DVD VIDEO, VIDEO CD only)**

This system stores the point where you stopped the disc for up to 40 discs and resumes playback the next time you insert the same disc. If you store a resume playback point for the 41st disc, the resume playback point for the first disc is deleted.

To activate this function, set [MULTI-DISC RESUME] in [CUSTOM SETUP] to [ON]. For details, see “[MULTI-DISC RESUME] (DVD VIDEO/VIDEO CD only)” (page 70).

**Tip**

- To play from the beginning of the disc, press **■** twice, then press **▷**.

**Note**

- If [MULTI-DISC RESUME] in [CUSTOM SETUP] is set to [OFF] (page 70), the resume point is cleared when you change the function by pressing FUNCTION.

# Creating Your Own Program

*(Program Play)*

**VIDEO CD** **CD**

You can play the contents of a disc in the order you want by arranging the order of the tracks on the disc to create your own program. You can program up to 99 tracks.

**1 Press **⏏** DISPLAY.**

The Control Menu display appears.

**2 Press **↑/↓** to select **[PROGRAM]**, then press **⊕**.**

The options for [PROGRAM] appear.

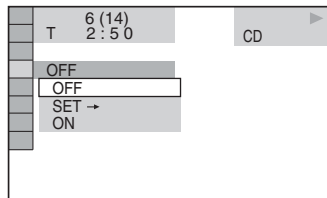

**3 Press **↑/↓** to select **[SET →]**, then press **⊕**.**

[TRACK] is displayed when you play a VIDEO CD or CD.

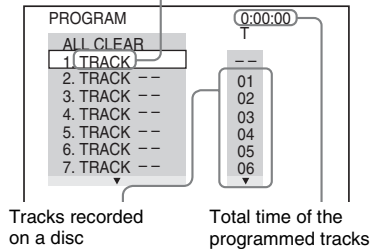

continued

#### 4 Press →.

The cursor moves to the track row [T] (in this case, [01]).

PROGRAM	0:00:00
ALL CLEAR	T
1. TRACK --	--
2. TRACK --	01
3. TRACK --	02
4. TRACK --	03
5. TRACK --	04
6. TRACK --	05
7. TRACK --	06

#### 5 Select the track you want to program.

For example, select track [02].

Press ↑/↓ to select [02] under [T], then press ⊕.

Selected track

PROGRAM	0:15:30
ALL CLEAR	T
1. TRACK (02)	--
2. TRACK --	01
3. TRACK --	02
4. TRACK --	03
5. TRACK --	04
6. TRACK --	05
7. TRACK --	06

Total time of the programmed tracks

#### 6 To program other tracks, repeat steps 4 to 5.

The programmed tracks are displayed in the selected order.

#### 7 Press ▷ to start Program Play.

Program Play starts.

When the program ends, you can restart the same program again by pressing ▷.

#### To return to normal play

In Step 3, press CLEAR or select [OFF]. To play the same program again, select [ON] in Step 3 and press ⊕.

#### To turn off the Control Menu display

Press ☐ DISPLAY repeatedly until the Control Menu display is turned off.

#### To change or cancel a program

1 Follow steps 1 to 3 of “Creating Your Own Program.”

2 Select the program number of the track you want to change or cancel using ↑/↓.

If you want to delete the track from the program, press CLEAR.

3 Follow Step 5 for new programming.

To cancel a program, select [--] under [T], then press ⊕.

#### To cancel all of the tracks in the programmed order

1 Follow steps 1 to 3 of “Creating Your Own Program.”

2 Press ↑ and select [ALL CLEAR].

3 Press ⊕.



# Playing in Random Order

## (Shuffle Play)

VIDEO CD   C D   DATA-CD   DATA DVD

You can have the system “shuffle” tracks. Subsequent “shuffling” may produce a different playing order.

### Note

- Same song may be played repeatedly during MP3 playback.

### 1 Press DISPLAY during playback.

The Control Menu display appears.

### 2 Press to select [SHUFFLE], then press .

The options for [SHUFFLE] appear.

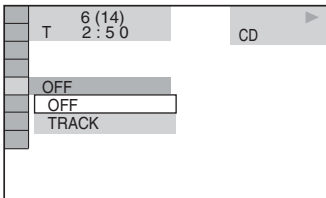

### 3 Press to select the item to be shuffled.

#### ■ When playing a VIDEO CD or CD

- [TRACK]: shuffles tracks on the disc.

#### ■ When Program Play is activated

- [ON]: shuffles tracks selected in Program Play.

#### ■ When playing a DATA CD (except for DivX\*) or DATA DVD (except for DivX\*)

- [ON (MP3)]: shuffles MP3 audio tracks in the album on the current disc. When no album is selected, the first album will play in random order.

\* Except for United Kingdom and North American models.

### Note

- A track already played is also selected in random order.

### 4 Press .

Shuffle Play starts.

## To return to normal play

In Step 3, press CLEAR or select [OFF].

## To turn off the Control Menu display

Press  DISPLAY repeatedly until the Control Menu display is turned off.

### Note

- You cannot use this function with VIDEO CDs and Super VCDs with PBC playback.

# Playing Repeatedly

## (Repeat Play)

DVD-V

DVD-VR

VIDEO CD

CD

DATA-CD

DATA DVD

You can play all the titles, tracks or albums on a disc or a single title, chapter, track, or album repeatedly.

You can use a combination of Shuffle or Program Play modes.

### 1 Press **DISPLAY** during playback.

The Control Menu display appears.

### 2 Press to select [REPEAT], then press .

The options for [REPEAT] appear.

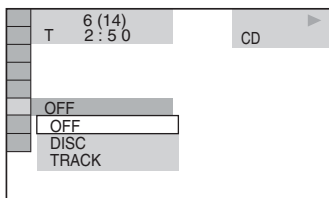

### 3 Press to select the item to be repeated.

The default setting is underlined.

#### ■ When playing a DVD VIDEO or DVD-VR

- [OFF]: does not play repeatedly.
- [DISC]: repeats all of the titles on the disc.
- [TITLE]: repeats the current title on a disc.
- [CHAPTER]: repeats the current chapter.

#### ■ When playing a VIDEO CD or CD

- [OFF]: does not play repeatedly.
- [DISC]: repeats all of the tracks on the disc.
- [TRACK]: repeats the current track.

#### ■ When playing a DATA CD or DATA DVD

- [OFF]: does not play repeatedly.
- [DISC]: repeats all of the albums on the disc.
- [ALBUM]: repeats the current album.
- [TRACK] (MP3 audio tracks only): repeats the current track.
- [FILE] (DivX video files only): repeats the current file.\*

\* Except for United Kingdom and North American models.

### 4 Press .

The item is selected.

### To return to normal play

In Step 3, press CLEAR or select [OFF].

### To turn off the Control Menu display

Press  DISPLAY repeatedly until the Control Menu display is turned off.

#### Note

- You cannot use this function with VIDEO CDs and Super VCDs with PBC playback.
- When playing a DATA CD/DATA DVD which contains MP3 audio track and JPEG image files, and their playing time is not the same, the audio sound will not match the image.
- When [MODE (MP3, JPEG)] is set to [IMAGE (JPEG)] (page 46), you cannot select [TRACK].

## Using the DVD's Menu

### DVD-V

A DVD is divided into a lot of sections, which make up a picture or music feature. These sections are called "titles." When you play a DVD which contains several titles, you can select the title you want using DVD TOP MENU.

When you play DVDs that allow you to select items such as the language for the subtitles and the language for the sound, select these items using DVD MENU.

### 1 Press DVD TOP MENU or DVD MENU.

The disc's menu appears on the TV screen. The contents of the menu vary from disc to disc.

### 2 Press ←/↑/↓/→ or the number buttons to select the item you want to play or change.

### 3 Press ⊕.

## Changing the Sound

### DVD-V

### DVD-VR

### VIDEO CD

### CD

### DATA-CD

### DATA DVD

When playing a DVD VIDEO or DATA CD/ DATA DVD (DivX video files\*) recorded in multiple audio formats (PCM, Dolby Digital, MPEG audio, or DTS), you can change the audio format. If the DVD VIDEO is recorded with multilingual tracks, you can also change the language.

With VIDEO CDs, CDs, DATA CDs, or DATA DVDs, you can select the sound from the right or left channel and listen to the sound of the selected channel through both the right and left speakers.

\* Except for United Kingdom and North American models.

### 1 Press AUDIO during playback.

The following display appears.

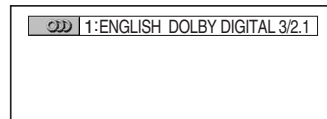

### 2 Press AUDIO repeatedly to select the desired audio signal.

#### ■ When playing a DVD VIDEO

Depending on the DVD VIDEO, the choice of language varies.

When four digits are displayed, they indicate a language code. Refer to "Language Code List" (page 85) to see which language the code represents. When the same language is displayed two or more times, the DVD VIDEO is recorded in multiple audio formats.

#### ■ When playing a DVD-VR

The types of sound tracks recorded on a disc are displayed. The default setting is underlined.

Example:

- [1: MAIN] (main sound)
- [1: SUB] (sub sound)
- [1: MAIN+SUB] (main and sub sound)

- [2: MAIN]
- [2: SUB]
- [2: MAIN+SUB]

**Note**

• [2: MAIN], [2: SUB], and [2: MAIN+SUB] do not appear when one audio stream is recorded on the disc.

**■ When playing a VIDEO CD, CD, DATA CD (MP3 audio), or DATA DVD (MP3 audio)**

The default setting is underlined.

- [STEREO]: the standard stereo sound
- [1/L]: the sound of the left channel (monaural)
- [2/R]: the sound of the right channel (monaural)

**■ When playing a DATA CD (DivX video) or DATA DVD (DivX video) (except for United Kingdom and North American models)**

The choice of DATA CD or DATA DVD audio signal formats differ, depending on the DivX video file contained on the disc. The format is shown in the display.

**■ When playing a Super VCD**

The default setting is underlined.

- [1:STEREO]: the stereo sound of the audio track 1
- [1:1/L]: the sound of the left channel of the audio track 1 (monaural)
- [1:2/R]: the sound of the right channel of the audio track 1 (monaural)
- [2:STEREO]: the stereo sound of the audio track 2
- [2:1/L]: the sound of the left channel of the audio track 2 (monaural)
- [2:2/R]: the sound of the right channel of the audio track 2 (monaural)

**Note**

• While playing a Super VCD on which the audio track 2 is not recorded, no sound will come out when you select [2:STEREO], [2:1/L], or [2:2/R].

## Checking the audio signal format

### (DVD, DivX video\* only)

\* Except for United Kingdom and North American models.

If you press AUDIO repeatedly during playback, the format of the current audio signal (PCM, Dolby Digital, DTS, etc.) appears as shown below.

**■ When playing a DVD**

**Example:**

Dolby Digital 5.1 ch

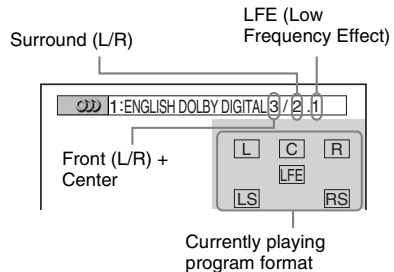

**Example:**

Dolby Digital 3 ch

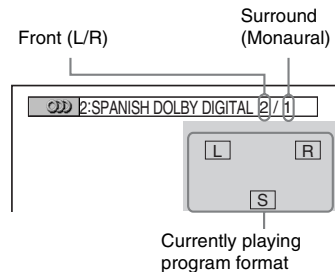

■ When playing a DATA CD (DivX video) or DATA DVD (DivX video) (except for United Kingdom and North American models)

**Example:**

MP3 audio

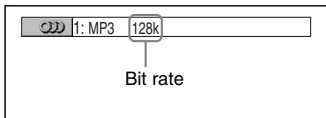

**About audio signals**

Audio signals recorded in a disc contain the sound elements (channels) shown below. Each channel is output from a separate speaker.

- Front (L)
- Front (R)
- Center
- Surround (L)
- Surround (R)
- Surround (Monaural): This signal can be either the Dolby Surround Sound processed signals or the Dolby Digital sound's monaural Surround audio signals.
- LFE (Low Frequency Effect) signal

## Selecting [ORIGINAL] or [PLAY LIST] on a DVD-R/DVD-RW

**DVD-VR**

Some DVD-Rs/DVD-RWs in VR (Video Recording) mode have two types of titles for playback: originally recorded titles ([ORIGINAL]) and titles that can be created on recordable DVD players for editing ([PLAY LIST]). You can select the type of title to be played.

**1** Press **DISPLAY** when the system is in stop mode.

The Control Menu display appears.

**2** Press **↑/↓** to select **[ORIGINAL/PLAY LIST]**, then press **+**.

The options for [ORIGINAL/PLAY LIST] appear.

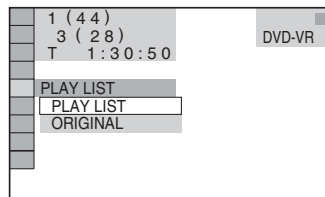

**3** Press **↑/↓** to select a setting.

The default setting is underlined.

- [PLAY LIST]: plays the titles created from [ORIGINAL] for editing.
- [ORIGINAL]: plays the titles originally recorded.

**4** Press **+**.

## Viewing Information About the Disc

DVD-V

DVD-VR

VIDEO CD

CD

DATA-CD

DATA DVD

### Viewing the playing time and remaining time in the front panel display

You can check disc information, such as the remaining time, total number of titles in a DVD, tracks in a VIDEO CD, CD, MP3, or file name of a DivX video\* using the front panel display (page 87).

\* Except for United Kingdom and North American models.

#### Press DISPLAY.

Each time you press DISPLAY while playing the disc, the display changes ① → ② → ... → ① → ...

Some displayed items may disappear after a few seconds.

#### When playing a DVD VIDEO or DVD-R/DVD-RW

- ① Playing time and number of the current title
- ② Remaining time of the current title
- ③ Playing time and number of the current chapter
- ④ Remaining time of the current chapter
- ⑤ Disc name
- ⑥ Title and chapter

#### When playing a DATA CD (DivX video) or DATA DVD (DivX video) (Except for United Kingdom and North American models)

- ① Playing time of the current file
- ② Current file name
- ③ Current album and file number

#### When playing a VIDEO CD (without PBC functions) or CD

- ① Playing time of the current track
- ② Remaining time of the current track
- ③ Playing time of the disc

- ④ Remaining time of the disc
  - ⑤ Disc name
  - ⑥ Track and index\*
- \* VIDEO CD only.

#### When playing a DATA CD (MP3 audio) or DATA DVD (MP3 audio)

- ① Playing time and current track number
- ② Track (file) name

#### Tip

- When playing VIDEO CDs with PBC functions, the playing time is displayed.

#### Note

- The system can only display the first level of the DVD/CD text, such as the disc name or title.
- If an MP3 file name cannot be displayed, “\*” will appear in the front panel display instead.
- The disc name or track name may not be displayed depending on the text.
- Playing time of MP3 audio tracks and DivX video files\* may not be displayed correctly.

\* Except for United Kingdom and North American models.

### Checking the playing time and remaining time

You can check the playing time and remaining time of the current title, chapter, or track, and the total playing time or remaining time of the disc. You can also check the DVD text and MP3 folder name/file name recorded in the disc.

#### 1 Press DISPLAY during playback.

The following display appears.

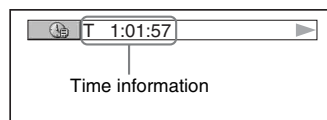

#### 2 Press DISPLAY repeatedly to change the time information.

The display and the kinds of time that you can check depend on the disc you are playing.

#### ■ When playing a DVD VIDEO or DVD-RW

- T \*\*:\*\*:\*\*

Playing time of the current title

- T\_\*\*.\*:\*\* Remaining time of the current title
- C \*\*.\*:\*\* Playing time of the current chapter
- C\_\*\*.\*:\*\* Remaining time of the current chapter

■ **When playing a VIDEO CD (with PBC functions)**

- \*\*.\*:\*\* Playing time of the current scene

■ **When playing a VIDEO CD (without PBC functions) or CD**

- T \*\*.\*:\*\* Playing time of the current track
- T\_\*\*.\*:\*\* Remaining time of the current track
- D \*\*.\*:\*\* Playing time of the current disc
- D\_\*\*.\*:\*\* Remaining time of the current disc

■ **When playing a DATA CD (MP3 audio) or DATA DVD (MP3 audio)**

- T \*\*.\*:\*\* Playing time of the current track

■ **When playing a DATA CD (DivX video) or DATA DVD (DivX video) (Except for United Kingdom and North American models)**

- \*\*.\*:\*\* Playing time of the current file

**Note**

- Characters/marks may not be displayed for some languages.
- Depending on the type of disc being played, the system can only display a limited number of characters. Also, depending on the disc, not all text characters will be displayed.

## Checking the play information of the disc

### To check DVD/CD text

Press DISPLAY repeatedly in Step 2 to display text recorded in the DVD/CD. The DVD/CD text appears only when text is recorded in the disc. You cannot change the text. If the disc does not contain text, "NO TEXT" appears.

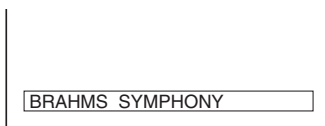

### To check DATA CD/DATA DVD (MP3 audio/DivX video\*) text

By pressing DISPLAY while playing MP3 audio tracks on a DATA CD/DATA DVD or DivX video files\* on a DATA CD/DATA DVD, you can display the name of the album/track/file, and the audio bit rate (the amount of data per second of the current audio) on your TV screen.

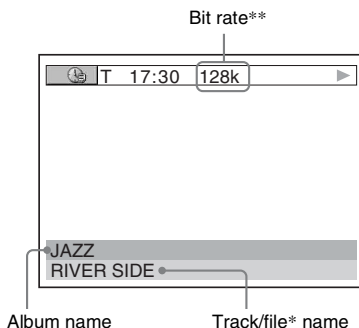

- \* Except for United Kingdom and North American models.
- \*\* Appears when:
  - playing an MP3 audio track on DATA CDs/DATA DVDs.
  - playing a DivX video file that contains MP3 audio signals on DATA CDs/DATA DVDs (except for United Kingdom and North American models).

## Checking the date information

### (JPEG only)

You can check the date information during playback when the Exif\* tag is recorded in the JPEG image data.

Press **DISPLAY** twice during playback.

The Control Menu display appears.

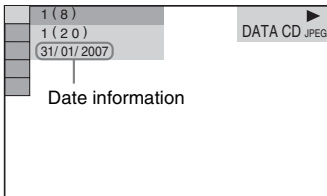

\* “Exchangeable Image File Format” is a digital camera image format defined by the Japan Electronics and Information Technology Industries Association (JEITA).

#### Tip

- Date information is [DD/MM/YYYY].  
DD: Day  
MM: Month  
YYYY: Year

## Changing the Angles

### DVD-V

If various angles (multi-angles) for a scene are recorded on a DVD VIDEO, you can change the viewing angle.

Press **ANGLE** during playback.

Each time you press ANGLE, the angle changes.

#### Note

- Depending on the DVD VIDEO, you may not be able to change the angle even if multi-angles are recorded on the DVD VIDEO.



## Displaying the Subtitles

**DVD-V** **DVD-VR** **DATA-CD** \* **DATA DVD** \*

\* Except for United Kingdom and North American models.

If subtitles are recorded on a disc, you can turn the subtitles on or off while playing. If multilingual subtitles are recorded on the disc, you can change the subtitle language while playing, or turn the subtitles on or off whenever you want.

### Press **SUBTITLE** during playback.

Each time you press **SUBTITLE**, the subtitle language changes.

#### Note

- Depending on the DVD VIDEO, you may not be able to change the subtitles even if multilingual subtitles are recorded on it. You also may not be able to turn them off.
- You can change the subtitles if the DivX video file has an “.AVI” or “.DIVX” extension and contains subtitle information within the same file (except for United Kingdom and North American models).

## Adjusting the Delay Between the Picture and Sound

### (A/V SYNC)

**DVD-V** **DVD-VR** **VIDEO CD** **DATA-CD** \* **DATA DVD** \*

\* Except for United Kingdom and North American models.

When the sound does not match the pictures on the TV screen, you can adjust the delay between the picture and sound.

### 1 Press **DISPLAY**.

The Control Menu display appears.

### 2 Press **↑/↓** to select **[A/V SYNC]**, then press **+**.

The options for **[A/V SYNC]** appear.

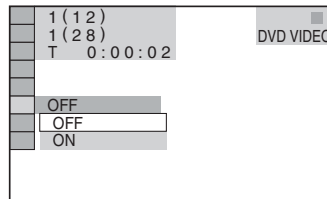

### 3 Press **↑/↓** to select a setting.

The default setting is underlined.

- [OFF]: does not adjust.
- [ON]: adjusts the difference between picture and sound.

### 4 Press **+**.

#### Note

- Depending on the input stream, this function may not be effective.

# About MP3 Audio Tracks and JPEG Image Files

DATA-CD DATA DVD

## What is MP3/JPEG?

MP3 is audio compression technology that satisfies the ISO/MPEG regulations. JPEG is image compression technology.

## Discs that the system can play

You can play back DATA CDs (CD-ROMs/CD-Rs/CD-RWs) or DATA DVDs (DVD-Rs/DVD-RWs/DVD+Rs/DVD+RWs/DVD-ROMs) recorded in MP3 (MPEG1 Audio Layer 3) or JPEG format. However, the DATA CDs must be recorded according to ISO 9660 Level 1, Level 2 or Joliet format and DATA DVDs of Universal Disk Format (UDF) for the system to recognize the tracks (or files). You can also play discs recorded in Multi Session.

See the operating instructions supplied with the CD-R/CD-RW or DVD-R/DVD-RW drives and the recording software (not supplied) for details on the recording format.

## About the Multi-Session disc

If MP3 audio tracks or JPEG image files are recorded in the first session, the system will also play MP3 audio tracks or JPEG image files in other sessions. If audio tracks and images in audio CD format or video CD format are recorded in the first session, only the first session will be played back.

### Note

- The system may not be able to play some DATA CDs/DATA DVDs created in the Packet Write format.

## MP3 audio track or JPEG image file that the system can play

You can play the MP3 audio tracks or JPEG image files:

- which have the extension “.MP3” (MP3 audio track) or “.JPG”/“.JPEG” (JPEG image file)
  - which conform to the DCF\* image file format
- \* “Design rule for Camera File system”: Image standards for digital cameras regulated by Japan Electronics and Information Technology Industries Association (JEITA).

### Note

- The system will play any data with the extension “.MP3,” “.JPG,” or “.JPEG” even if they are not in MP3 or JPEG format. Playing this data may generate a loud noise which could damage your speaker system.
- The system does not conform to audio in MP3PRO format.

## Playback order of MP3 audio tracks or JPEG image files

The playback order of MP3 audio tracks or JPEG image files recorded on a DATA CD or DATA DVD is as follows:

### ■ Structure of disc contents

Tree 1    Tree 2    Tree 3    Tree 4    Tree 5

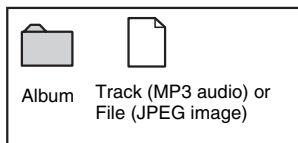
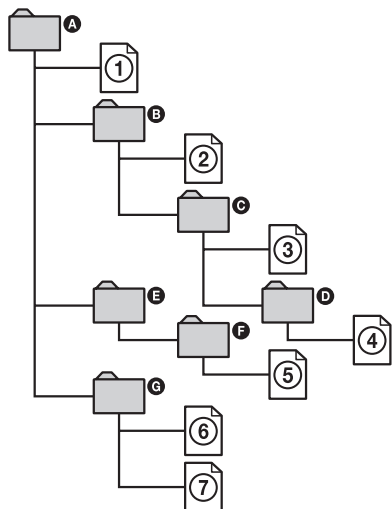

When you insert a DATA CD or DATA DVD and press , the numbered tracks (or files) are played sequentially, from ① through ⑦. Any sub-albums/tracks (or files) contained within a currently selected album take priority over the next album in the same tree. (Example: **C** contains **D** so ④ is played before ⑤.)

When you press DVD MENU and the list of album names appears (page 44), the album names are arranged in the following order: **A** → **B** → **C** → **D** → **F** → **G**. Albums that do not contain tracks (or files) (such as album **E**) do not appear in the list.

#### Tip

- If you add numbers (01, 02, 03, etc.) to the front of the track (or file) names when you store the tracks (or files) in a disc, the tracks (or files) will be played in that order.
- A disc with many trees takes longer to start playback.

#### Note

- Playback order may differ from the illustration depending on the software you use to create the DATA CD or DATA DVD, or if there are more than 200 albums and 300 files in each album.
- The system can recognize up to 200 albums, and will not play any albums beyond the 200th.
- The system may take longer time to playback, when progressing to the following album or jump to other album.
- Some type of JPEG files cannot be played.

# Playing DATA CDs or DATA DVDs with MP3 Audio Tracks and JPEG Image Files

DATA-CD DATA DVD

## Selecting an MP3 audio track or album

### 1 Load a DATA CD or DATA DVD.

The albums recorded on the DATA CD or DATA DVD appear. When an album is being played, its title is shaded.



### 2 Press $\uparrow/\downarrow$ to select an album.

#### ■ When selecting an album

Press  $\triangleright$  to start playing the selected album.

#### ■ When selecting a track

Press  $\oplus$ .

The list of tracks contained in the album appears.

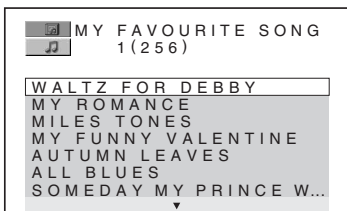

Press  $\uparrow/\downarrow$  to select a track and press  $\oplus$ . The selected track starts playing. You can turn the track list off by pressing DVD MENU. Pressing DVD MENU again will display the album list.

## To stop playback

Press  $\blacksquare$ .

## To play the next or previous MP3 audio track

Press  $\lll/\ggg$ . Note that you can select the next album by continuing to press  $\ggg$  after the last track on the current album, but that you cannot return to the previous album by pressing  $\lll$ . To return to the previous album, select the album from the album list.

## To return to the previous display

Press  $\curvearrowright$  RETURN.

## To turn off the display

Press DVD MENU.

## Selecting a JPEG image file or album

### 1 Load a DATA CD or DATA DVD.

The albums recorded on the DATA CD or DATA DVD appear. When an album is being played, its title is shaded.



### 2 Press $\uparrow/\downarrow$ to select an album.

#### ■ When selecting an album

Press  $\triangleright$  to start playing the selected album.

#### ■ When selecting an image

Press PICTURE NAVI.

Images of files in the album appear in 16 subscreens.

1	2	3	4
5	6	7	8
9	10	11	12
13	14	15	16

Press **←/↑/↓/→** to select the image you want to view and press **⊕**.

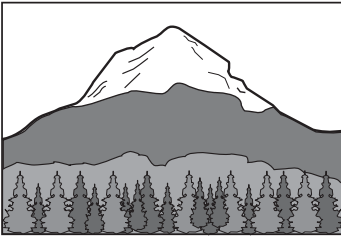

### To play the next or previous JPEG image file

Press **←/→** when the Control Menu display is not displayed. Note that you can select the next album by continuing to press **→** after the last image on the current album, but that you cannot return to the previous album by pressing **←**. To return to the previous album, select the album from the album list.

### To rotate a JPEG image

When a JPEG image file is displayed on the TV screen, you can rotate the image by 90 degrees. Press **↑/↓** while viewing an image. Each time you press **↑**, the image rotates counterclockwise by 90 degrees.

Example of when you press **↑** once:

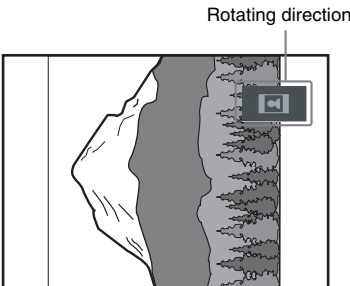

Press **CLEAR** to return to normal view.

### To stop playback

Press **■**.

**Tip**

- A scroll box is displayed at the right side of the TV screen. To display the additional image files, select the bottom image and press **↓**. To return to the previous image, select the top image and press **↑**.

# Playing Audio Tracks and Images as a Slide Show with Sound

**DATA-CD DATA DVD**

You can play a slide show with sound by first placing both MP3 and JPEG files in the same album on a DATA CD or DATA DVD. When you play back the DATA CD or DATA DVD, select [AUTO] mode as explained below.

- 1 Load a DATA CD or DATA DVD.**
- 2 Press  DISPLAY when the system is in stop mode.**

The Control Menu display appears.

- 3 Press  $\uparrow/\downarrow$  to select  [MODE (MP3, JPEG)], then press  $\oplus$ .**

The options for [MODE (MP3, JPEG)] appear.

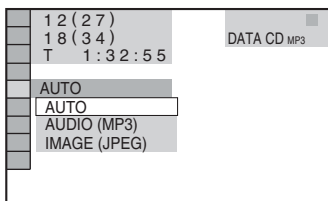

- 4 Press  $\uparrow/\downarrow$  to select a setting.**

The default setting is underlined.

- [AUTO]: plays both the JPEG image files and MP3 audio tracks in the same album as a slide show.
- [AUDIO (MP3)]: plays only MP3 audio tracks continuously.
- [IMAGE (JPEG)]: plays only JPEG image files as a slide show.

- 5 Press  $\oplus$ .**

- 6 Press DVD MENU.**

The list of albums recorded on the DATA CD or DATA DVD appears.

- 7 Press  $\uparrow/\downarrow$  to select the album you want and press  $\triangleright$ .**

The system starts playing the selected album.

You can turn the album list on and off by pressing DVD MENU repeatedly.

## Tip

- When you select [AUTO], the system can recognize up to 300 MP3 tracks and 300 JPEG files in a single album. When you select [AUDIO (MP3)] or [IMAGE (JPEG)], the system can recognize up to 600 MP3 or 600 JPEG files in a single album. A maximum of 200 albums can be recognized regardless of the selected mode.

## Note

- If you set [MODE (MP3, JPEG)] to [IMAGE (JPEG)] on a disc that contains MP3 tracks only or [AUDIO (MP3)] on a disc that contains JPEG files only, you may not be able to change the [MODE (MP3, JPEG)] setting.
- PICTURE NAVI does not work when [AUDIO (MP3)] is selected.
- If you play large MP3 track data and JPEG image data at the same time, the sound may skip. It is recommended that you set the MP3 bit rate to 128 kbps or lower when creating the file. If the sound still skips, then reduce the size of the JPEG file.

## Specifying the slide show duration (JPEG only)

When you play JPEG image files using slide show, you can specify the duration for slides to appear on the TV screen.

- 1 Press  DISPLAY twice.**

The Control Menu display appears.

- 2 Press  $\uparrow/\downarrow$  to select  [INTERVAL], then press  $\oplus$ .**

The options for [INTERVAL] appear.

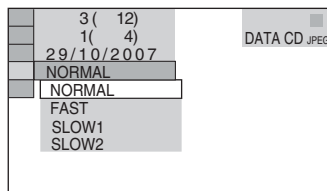

### 3 Press $\uparrow/\downarrow$ to select a setting.

The default setting is underlined.

- [NORMAL]: sets the duration to about 6 to 9 seconds.
- [FAST]: sets the duration shorter than [NORMAL].
- [SLOW1]: sets the duration longer than [NORMAL].
- [SLOW2]: sets the duration longer than [SLOW1].

### 4 Press $\oplus$ .

**Note**

- Some JPEG files may take longer to display than others, which may make the duration seems longer than the option you selected. Especially progressive JPEG files or JPEG files of 3,000,000 pixels or more.

## Selecting an effect for image files in the slide show

### (JPEG only)

When you play a JPEG image file, you can select the effect to be used when viewing the slide show.

### 1 Press $\text{DISP}$ DISPLAY twice.

The Control Menu display appears.

### 2 Press $\uparrow/\downarrow$ to select $\text{EFFECT}$ [EFFECT], then press $\oplus$ .

The options for [EFFECT] appear.

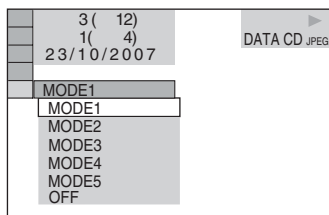

### 3 Press $\uparrow/\downarrow$ to select a setting.

The default setting is underlined.

- [MODE1]: The image sweeps in from top to bottom.
- [MODE2]: The image stretches out from left to right of the TV screen.
- [MODE3]: The image stretches out from the center of the TV screen.

- [MODE4]: The images randomly cycle through the effects.
- [MODE5]: The next image slides over the previous image.
- [OFF]: turns off this function.

### 4 Press $\oplus$ .

# Enjoying DivX<sup>®</sup> Videos

**DATA-CD** **DATA DVD**

*(Except for United Kingdom and North American models)*

## About DivX Video Files

DivX<sup>®</sup> is a video file compression technology, developed by DivX, Inc. This product is an official DivX<sup>®</sup> Certified product.

You can play DATA CDs and DATA DVDs that contain DivX<sup>®</sup> video files.

## DATA CDs and DATA DVDs that the system can play

Playback of DATA CDs (CD-ROMs/CD-Rs/CD-RWs) and DATA DVDs (DVD-ROMs/DVD-Rs/DVD-RWs/DVD+Rs/DVD+RWs) on this system is subject to certain conditions:

- With DATA CDs/DATA DVDs that contain DivX video files in addition to MP3 audio tracks or JPEG image files, the system plays only the DivX video files.

However, this system only plays DATA CDs whose logical format is ISO 9660 Level 1/Level 2 or Joliet, and DATA DVDs of Universal Disk Format (UDF).

Refer to the operating instructions supplied with the disc drives and the recording software (not supplied) for details on the recording format.

## About playback order of data on DATA CDs or DATA DVDs

See “Playback order of MP3 audio tracks or JPEG image files” (page 43). Note that the playback order may not be applicable, depending on the software used for creating the DivX video file, or if there are more than 200 albums and 600 DivX video files in each album.

**Note**

- The system may not be able to play some DATA CDs/DATA DVDs created in the Packet Write format.

## DivX video files that the system can play

The system can play data that is recorded in DivX format, and which has the extension “.AVI,” or “.DIVX.” The system will not play files with the extension “.AVI” or “.DIVX” if they do not contain a DivX video.

**Tip**

- For details about playable MP3 audio tracks or JPEG image files on DATA CDs or DATA DVDs, see “Discs that the system can play” (page 42).

**Note**

- The system may not play a DivX video file when the file has been combined from two or more DivX video files.
- The system cannot play a DivX video file of size more than 720 (width) x 576 (height) or 2GB.
- Depending on the DivX video file, sound may skip or not match the pictures on the TV screen.
- The system cannot play some DivX video files that are longer than 3 hours.
- Depending on the DivX video file, the picture may pause or be unclear. In which case, it is recommended that you create the file at a lower bit rate. If the sound is still noisy, MP3 is the recommended audio format. Note, however, this system does not conform to WMA (Windows Media Audio) format.
- Because of the compression technology used for DivX video files, it may take some time after you press  $\blacktriangleright$  for the picture to appear.

## Selecting an album

### 1 Press DVD MENU.

A list of albums on the disc appears. Only albums that contain DivX video files are listed.

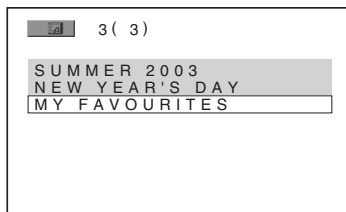

### 2 Press $\uparrow/\downarrow$ to select the album you want to play.



**3** Press  $\triangleright$ .

The system starts playing the selected album.

To select DivX video files, see “Selecting a DivX video file” (page 49).

**To go to the next or previous page**

Press  $\leftarrow/\rightarrow$ .

**To turn off the display**

Press DVD MENU repeatedly.

**To stop playback**

Press  $\blacksquare$ .

**Selecting a DivX video file****1** After Step 2 of “Selecting an album,” press  $\oplus$ .

The list of files in the album appears.

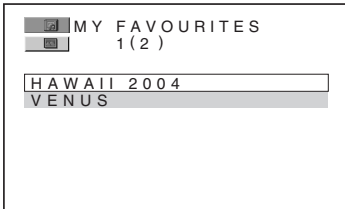
**2** Press  $\uparrow/\downarrow$  to select a file and press  $\oplus$ .

The selected file starts playing.

**To go to the next or previous page**

Press  $\leftarrow/\rightarrow$ .

**To return to the previous display**

Press  $\curvearrowright$  RETURN.

**To stop playback**

Press  $\blacksquare$ .

**To play the next or previous DivX video file without turning on the above file list**

You can select the next or previous DivX video file in the same album by pressing  $\lll/\ggg$ .

You can also select the first file of the next album by pressing  $\ggg$  during playback of the last file of the current album. Note that you cannot return to the previous album by pressing  $\lll$ . To return to the previous album, select it from the album list.

**Tip**

- If the number of viewing times is preset, you can play the DivX video files as many times as the preset number. The following occurrences are counted:
  - when the system is turned off.
  - when another file is played.
  - when the disc tray is opened.

# Playing VIDEO CDs with PBC Functions (Ver.2.0)

## *(PBC Playback)*

### **VIDEO CD**

With PBC (Playback Control) functions, you can enjoy simple interactive operations, search functions, and other such operations.

PBC playback allows you to play VIDEO CDs interactively by following the menu on the TV screen.

### **1 Start playing a VIDEO CD with PBC functions.**

The menu for your selection appears.

### **2 Select the item number you want by the number buttons.**

### **3 Press .**

### **4 Follow the instructions in the menu for interactive operations.**

Refer to the operating instructions supplied with the disc, as the operating procedure may differ depending on the VIDEO CD.







## **To go back to the menu**

Press  RETURN.

### **Note**

- Depending on the VIDEO CD, [Press ENTER] in Step 3 may appear as [Press SELECT] in the operating instructions supplied with the disc. In this case, press .

### **Tip**

- To play without using PBC, press   or the number buttons while the system is in stop mode to select a track, then press  or . The system starts continuous play. You cannot play still pictures such as a menu. To return to PBC playback, press  twice, then press .

# Presetting Radio Stations

You can preset 20 FM stations, and 10 AM stations. Before tuning, make sure to turn down the volume to minimum.

**1** Press **FUNCTION** repeatedly until “**TUNER FM**” or “**TUNER AM**” appears in the front panel display.

**2** Press and hold **TUNING +** or **-** until the auto scanning starts.

Scanning stops when the system tunes in a station. “**TUNED**” and “**ST**” (for stereo program) appear in the front panel display.

**3** Press **SYSTEM MENU**.

**4** Press **↑/↓** repeatedly until “**MEMORY**” appears in the front panel display.

**5** Press **⊕** or **→**.

A preset number appears in the front panel display.



**6** Press **↑/↓** to select the preset number you want.



### Tip

- You can select the preset number directly by pressing the number buttons.

**7** Press **⊕**.

The station is stored.

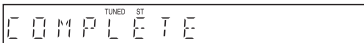

**8** Repeat Steps 1 to 7 to store other stations.

**9** Press **SYSTEM MENU**.

The system menu turns off.

## To change the preset number

Restart from Step 1.

## Listening to the Radio

Preset radio stations in the system's memory first (see "Presetting Radio Stations" (page 51)).

- 1 Press **FUNCTION** repeatedly until **"TUNER FM" or "TUNER AM"** appears in the front panel display.

The last received station is tuned in.

- 2 Press **PRESET +** or **-** repeatedly to select the preset station.

Each time you press the button, the system tunes in one preset station.

### Tip

- You can select the preset station number directly by pressing the number buttons.

- 3 Adjust the volume by pressing **VOLUME +/-**.

### To turn off the radio

Press **I/O**.

### To listen to non-preset radio stations

Use manual or automatic tuning in Step 2.

For manual tuning, press **TUNING +** or **-** repeatedly.

For automatic tuning, press and hold **TUNING +** or **-**. The automatic tuning stops automatically when the system receives the radio station. To stop the automatic tuning manually, press **TUNING +** or **-**.

### To listen to radio stations when you know the frequencies

Use direct tuning in Step 2.

- 1 Press **D.TUNING**.
- 2 Press the number buttons to select the frequencies.
- 3 Press **(+)**.

### Tip

- To improve reception, reorient the supplied antennas (aerials).

### If an FM program is noisy

If an FM program is noisy, you can select monaural reception. There will be no stereo effect, but reception will improve.

- 1 Press **SYSTEM MENU**.
- 2 Press **↑/↓** repeatedly until **"FM MODE"** appears in the front panel display.

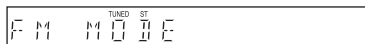

- 3 Press **(+)** or **→**.
- 4 Press **↑/↓** to select **"MONO."**  
The default setting is underlined.
  - **"STEREO"**: stereo reception.
  - **"MONO"**: monaural reception.

- 5 Press **(+)**.  
The setting is made.

- 6 Press **SYSTEM MENU**.  
The system menu turns off.

---

### Naming preset stations

You can enter a name for preset stations. These names (for example, "XYZ") appear in the front panel display when a station is selected.

Note that no more than one name can be entered for each preset station.

### Note

- You cannot enter a name for preset stations of the Radio Data System (RDS) (page 53).

- 1 Press **FUNCTION** repeatedly until **"TUNER FM" or "TUNER AM"** appears in the front panel display.  
The last received station is tuned in.
- 2 Press **PRESET +** or **-** repeatedly to select the preset station you want to create an index name for.
- 3 Press **SYSTEM MENU**.
- 4 Press **↑/↓** repeatedly until **"NAME IN"** appears in the front panel display.



- 5 Press **(+)** or **→**.

## 6 Create a name by using the cursor buttons.

Press  $\uparrow/\downarrow$  to select a character, then press  $\rightarrow$  to move the cursor to the next position.

Letters, numbers, and other symbols can be input for a radio station.

### If you make a mistake

Press  $\leftarrow/\rightarrow$  repeatedly until the character to be changed flashes, then press  $\uparrow/\downarrow$  to select the desired character.

To erase the character, press  $\leftarrow/\rightarrow$  repeatedly until the character to be erased flashes, then press CLEAR.

## 7 Press $\oplus$ .

“COMPLETE” appears in the front panel display, and the station name is stored.

## 8 Press SYSTEM MENU.

The system menu turns off.

### Tip

- You can check the frequency by pressing DISPLAY repeatedly (page 53).

## Viewing the station name or frequency in the front panel display

When the system is set to “TUNER FM” or “TUNER AM,” you can check the frequency using the front panel display.

### Press DISPLAY.

Each time you press DISPLAY, the display changes as shown.

- ① Station name\*
- ② Frequency\*\*

\* This is displayed if you have entered a name for a preset station.

\*\* Returns to the original display when several seconds has elapsed.

## Using the Radio Data System (RDS)

### What is the Radio Data System?

The Radio Data System (RDS) is a broadcasting service that allows radio stations to send additional information along with the regular program signal. This tuner offers convenient RDS features, such as station name display. RDS is available only for FM stations.\*

#### Note

- RDS may not work properly if the station you are tuned to is not transmitting the RDS signal properly, or if the signal strength is weak.
- \* Not all FM stations provide RDS service, nor do they provide the same type of services. If you are not familiar with the RDS system, check with your local radio stations for details on RDS services in your area.

### Receiving RDS broadcasts

Simply select a station from the FM band.

When you tune in a station that provides RDS services, the station name\* appears in the front panel display.

\* If an RDS broadcast is not received, the station name may not appear in the front panel display.

## Other Operations

### Controlling the TV with the Supplied Remote

You can control your TV (Sony only) with the supplied remote.

### Controlling TVs with the remote

You can control the TV by using following buttons.

By pressing	You can
TV I/⏻	Turn the TV on or off.
TV INPUT	Switch the TV's input source between the TV and other input sources.
TV VOL +/-	Adjust the TV volume.
TV CH +/-	Select the TV channel.
Number buttons*, ENTER*	Select the TV channel.
DVD MENU*	Display the menu of the TV.
←/↑/↓/→*, ⊕ *	Select the item on the menu.
RETURN*	Return to the previous channel or layer on the menu of the TV.

\* Use these buttons while pressing the TV button.

-/- is for selecting a channel number greater than 10. (For example, for channel 25, press -/-, then 2 and 5.)

#### Note

- Depending on the TV, you may not be able to control your TV or to use some of the buttons above.

## Using the THEATRE SYNC Function

THEATRE SYNC allows you to turn on your Sony TV and this system, changes the system mode to "DVD," and then switches the TV's input source you set with one button push.

### Preparing for the THEATRE SYNC function

Register the TV's input source connected to this system.

**Press and hold TV INPUT while entering the code for the TV's input source connected to this unit (see the table) using the number buttons.**

The TV's input source is selected.

Set your TV's input to the input you used to connect the unit. For details, see the operating instructions of your TV.

By pressing	Number	TV's input source
TV INPUT	0	No input source (Default)
	1	VIDEO1
	2	VIDEO2
	3	VIDEO3
	4	VIDEO4
	5	VIDEO5
	6	VIDEO6
	7	VIDEO7
	8	VIDEO8
	9*	COMPONENT 1
	CLEAR*	COMPONENT 2
	SYSTEM MENU*	COMPONENT 3
	PICTURE NAVI*	COMPONENT 4

\* Except for North American models.

## Operating the THEATRE SYNC function

Point the remote to the direction of TV and this unit, then press THEATRE SYNC once.

If this function does not work, change the transmit time. The transmit time varies depending on the TV.

### To change the transmit time

Press and hold TV CH + while entering the code for transmit time (see the table) using the number buttons.

The transmit time from the remote is selected.

By pressing	Number	Transmit time
TV CH +	1	0.5 (Default)
	2	1
	3	1.5
	4	2
	5	3
	6	4
	7	5
	8	6

#### Note

- This function is only for Sony TVs. (This function may not work on some Sony TVs.)
- If distance between TV and this unit is too far, this function may not work. Install the unit near the TV.
- Keep the remote pointed in the direction of the TV and this unit while entering the code.

## Using the Sound Effect

### Reinforcing bass frequencies

You can reinforce bass frequencies.

Press DYNAMIC BASS.

Bass frequencies are effectively reinforced.

### To turn off the sound effect

Press DYNAMIC BASS again.

## Using the Sleep Timer

You can set the system to turn off at a preset time, so you can fall asleep listening to music. You can preset the time in 1 or 10-minute increments.

- 1 Press SYSTEM MENU.**
- 2 Press  $\uparrow/\downarrow$  repeatedly until "SLEEP" appears in the front panel display, then press  $\oplus$  or  $\rightarrow$ .**
- 3 Press  $\uparrow/\downarrow$  to select a setting.**  
The minutes display (the remaining time) changes as follows:

SLEEP 90M  $\leftrightarrow$  SLEEP 80M  $\leftrightarrow$  SLEEP 70M  
 $\updownarrow$   $\updownarrow$   
SLEEP OFF  $\leftrightarrow$  SLEEP 10M ..... SLEEP 60M

### Tip

- You can select the remaining time by pressing the number buttons. In this case, you can preset the time in 1-minute increments.

- 4 Press  $\oplus$ .**  
The setting is made and "SLEEP" lights up in the front panel display.
- 5 Press SYSTEM MENU.**  
The system menu turns off.

### To change the remaining time

Restart from Step 1.

### To cancel the Sleep Timer function

Select "SLEEP OFF" in Step 3.

## Changing the Brightness of the Front Panel Display

The brightness of the front panel display can be set to either of 2 levels.

- 1 Press SYSTEM MENU.**
- 2 Press  $\uparrow/\downarrow$  repeatedly until "DIMMER" appears in the front panel display, then press  $\oplus$  or  $\rightarrow$ .**
- 3 Press  $\uparrow/\downarrow$  to select the brightness of the front panel display.**  
The default setting is underlined.
  - "DIMMER OFF": Bright.
  - "DIMMER ON": The front panel display becomes dark.
- 4 Press  $\oplus$ .**  
The setting is made.
- 5 Press SYSTEM MENU.**  
The system menu turns off.



## Using the DIGITAL MEDIA PORT Adapter

The DIGITAL MEDIA PORT (DMPORT) adapter is for enjoying sound from a portable audio source or computer. By connecting a DIGITAL MEDIA PORT adapter, you can enjoy sound from the connected component on the system.

Available DIGITAL MEDIA PORT adapters vary in each area.

For details on connecting the DIGITAL MEDIA PORT adapter, see “Connecting Other Components” (page 21).

### Note

- Do not connect an adaptor other than the DIGITAL MEDIA PORT adapter.
- Do not connect or disconnect the DIGITAL MEDIA PORT adapter to/from the unit while the system is turned on.
- Depending on the type of DIGITAL MEDIA PORT adapter (not supplied), the images are also output. In this case, the system outputs the EURO AV OUTPUT signal only regardless of the type of video signal.

### Note

- Depending on the type of DIGITAL MEDIA PORT adapter (not supplied), you may be able to operate a connected component using either the buttons on the remote or the unit. The following illustration shows an example of buttons that can be used in this case.

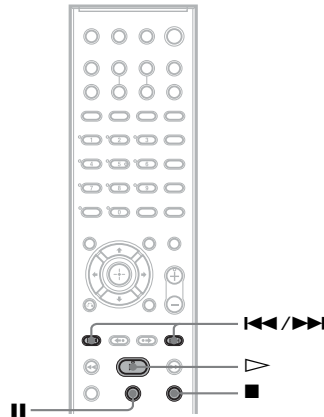

## Playing the connected component on the system

**1** Press **FUNCTION** repeatedly until “DMPORT” appears in the front panel display.

**2** Start playback of the connected component.

The sound and images from the connected component are played on the system or connected TV.

For operation details, see the operating instructions of the DIGITAL MEDIA PORT adapter (not supplied).

### Tip

- When listening to MP3 or other compressed music using a portable audio source, you can enhance the sound. Press **SOUND FIELD** repeatedly until “A.F.D. STD” appears in the front panel display. To cancel, select other than “A.F.D. STD.”

# Deactivating the Buttons on the Unit

## *(Child Lock)*

You can deactivate the buttons on the unit (except for **I/⏻**) for preventing misoperation, such as child mischief (child lock function). When the child lock function is activated, the buttons on the unit are locked and “**🔒**” lights up in the front panel display. (You can operate the system by using the remote.)

### **Note**

- When you operate the buttons on the unit while the child lock function is on, “CHILD LOCK” appears in the front panel display.

- 1 Press SYSTEM MENU.**
- 2 Press **↑/↓** repeatedly until “CHILD LOCK” appears in the front panel display, then press **⊕** or **→**.**
- 3 Press **↑/↓** to select a setting.**  
The default setting is underlined.
  - “OFF”: Child lock function off.
  - “ON”: Child lock function on.
- 4 Press **⊕**.**  
The setting is made.
- 5 Press SYSTEM MENU.**  
The system menu turns off.

### **Tip**

- You can activate the child lock function by pressing **■** for more than 5 seconds (“**🔒**” lights up in the front panel display).  
To cancel, press **■** for more than 5 seconds so that “**🔒**” disappears from the front panel display.

## Advanced Settings and Adjustments

### Locking Discs

#### (CUSTOM PARENTAL CONTROL, PARENTAL CONTROL)

DVD-V VIDEO CD C D

You can set two kinds of playback restrictions for the desired disc.

- Custom Parental Control

You can set playback restrictions so that the system will not play inappropriate discs.

- Parental Control

Playback of some DVD VIDEOS can be limited according to a predetermined level such as the age of the users. Scenes may be blocked or replaced with different scenes.

The same password is used for both Custom Parental Control and Parental Control.

### Preventing playback of specific discs [CUSTOM PARENTAL CONTROL]

You can set the same Custom Parental Control password for up to 40 discs. When you set the 41st-disc, the first disc is canceled.

#### 1 Insert the disc you want to lock.

If the disc is playing, press ■ to stop playback.

#### 2 Press DISPLAY while the system is in stop mode.

The Control Menu display appears.

#### 3 Press to select [PARENTAL CONTROL], then press

.

The options for [PARENTAL CONTROL] appear.

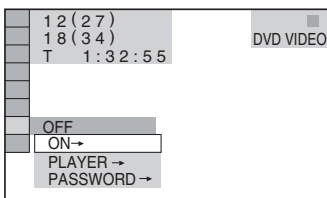

#### 4 Press to select [ON →], then press .

##### ■ If you have not entered a password

The display for registering a new password appears.

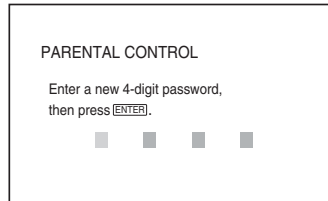

Enter a 4-digit password using the number buttons, then press .

The display for confirming the password appears.

##### ■ When you have already registered a password

The display for entering the password appears.

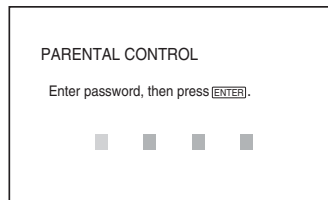

#### 5 Enter or re-enter your 4-digit password using the number buttons, then press .

[Custom parental control is set.] appears and the TV screen returns to the Control Menu display.

### To turn off the Custom Parental Control function

#### 1 Follow steps 1 through 3 of “Preventing playback of specific discs [CUSTOM PARENTAL CONTROL].”

#### 2 Press to select [OFF →], then press .

#### 3 Enter your 4-digit password using the number buttons, then press .

## To play a disc for which Custom Parental Control is set

- 1 Insert the disc for which Custom Parental Control is set.

The [CUSTOM PARENTAL CONTROL] display appears.

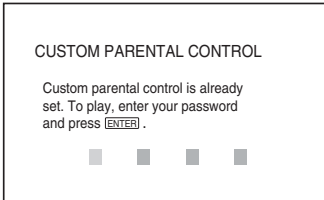

- 2 Enter your 4-digit password using the number buttons, then press  $\oplus$ .  
The system is ready for playback.

### Tip

- If you forget your password, enter the 6-digit number "199703" using the number buttons when the [CUSTOM PARENTAL CONTROL] display asks you for your password, then press  $\odot$ . The display will ask you to enter a new 4-digit password.

---

## Limiting playback for children [PARENTAL CONTROL] (DVD only)

Playback of some DVD VIDEOS can be limited according to a predetermined level such as the age of the users. The [PARENTAL CONTROL] function allows you to set a playback limitation level.

- 1 Press  $\square$  **DISPLAY** while the system is in stop mode.

The Control Menu display appears.

- 2 Press  $\uparrow/\downarrow$  to select  [PARENTAL CONTROL], then press  $\oplus$ .

The options for [PARENTAL CONTROL] appear.

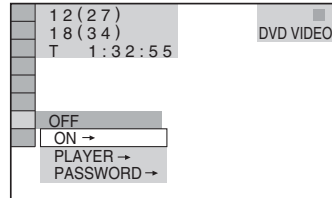

- 3 Press  $\uparrow/\downarrow$  to select [PLAYER  $\rightarrow$ ], then press  $\oplus$ .

■ **If you have not entered a password**  
The display for registering a new password appears.

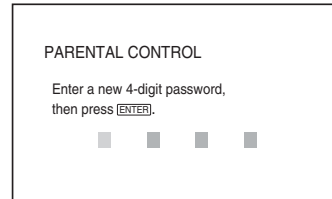

Enter a 4-digit password using the number buttons, then press  $\oplus$ .

The display for confirming the password appears.

■ **When you have already registered a password**

The display for entering the password appears.

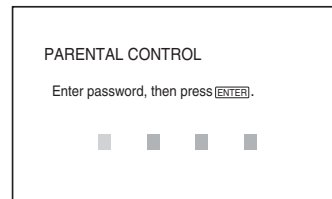

#### 4 Enter or re-enter your 4-digit password using the number buttons, then press $\oplus$ .

The display for setting the playback limitation level appears.

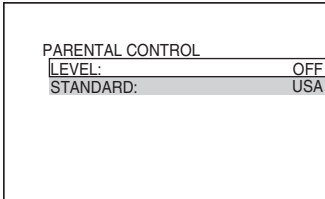

#### 5 Press $\uparrow/\downarrow$ to select [STANDARD], then press $\oplus$ .

The selection items for [STANDARD] are displayed.

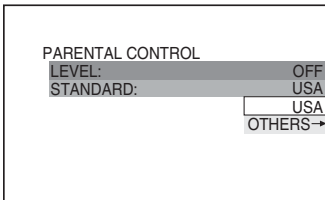

#### 6 Press $\uparrow/\downarrow$ to select a geographic area as the playback limitation level, then press $\oplus$ .

The area is selected.

When you select [OTHERS →], select and enter a standard code in the table of “Parental Control Area Code List” (page 85) using the number buttons.

#### 7 Press $\uparrow/\downarrow$ to select [LEVEL], then press $\oplus$ .

The selection items for [LEVEL] are displayed.

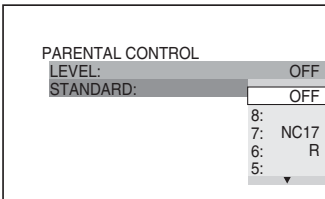

#### 8 Press $\uparrow/\downarrow$ to select the level you want, then press $\oplus$ .

Parental Control setting is complete.

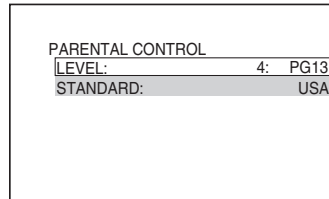

The lower the value, the stricter the limitation.

#### To turn off the Parental Control function

Set [LEVEL] to [OFF] in Step 8.

#### To play a disc for which Parental Control is set

##### 1 Insert the disc and press $\triangleright$ .

The display for entering your password appears.

##### 2 Enter your 4-digit password using the number buttons, then press $\oplus$ .

The system starts playback.

##### Tip

- If you forget your password, remove the disc and repeat steps 1 to 3 of “Preventing playback of specific discs [CUSTOM PARENTAL CONTROL].” When you are asked to enter your password, enter “199703” using the number buttons, then press  $\oplus$ . The display will ask you to enter a new 4-digit password. After you enter a new 4-digit password, replace the disc in the unit and press  $\triangleright$ . When the display for entering your password appears, enter your new password.

##### Note

- When you play discs which do not have the Parental Control function, playback cannot be limited on this system.
- Depending on the disc, you may be asked to change the parental control level while playing the disc. In this case, enter your password, then change the level. If the Resume Play mode is canceled, the level returns to the previous level.

continued

## Changing the password

- 1 Press  DISPLAY while the system is in stop mode.

The Control Menu display appears.

- 2 Press  to select  [PARENTAL CONTROL], then press .

The options for [PARENTAL CONTROL] appear.

- 3 Press  to select [PASSWORD →], then press .



The display for entering the password appears.

- 4 Enter your 4-digit password using the number buttons, then press .

- 5 Enter a new 4-digit password using the number buttons, then press .

- 6 To confirm your password, re-enter it using the number buttons, then press .

### If you make a mistake entering your password

Press  before you press  and input the correct number.

## Getting Optimal Surround Sound for a Room

### (SPEAKER FORMATION)

Depending on the shape of the room, there will be some speakers you cannot install. For the better surround sound, it is recommended that first you decide the position of the speakers.



- 1 Press FUNCTION repeatedly until "DVD" appears in the front panel display.

- 2 Press  DISPLAY when the system is in stop mode.

The Control Menu display appears.

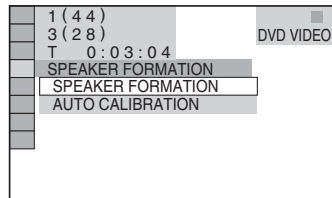
- 3 Press  to select  [SPEAKER FORMATION], then press .



- 4 Press  to select [SPEAKER FORMATION], then press .

The options for [SPEAKER FORMATION] appear.

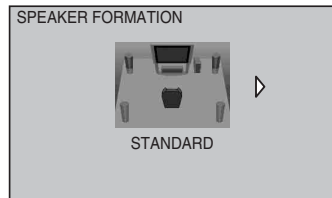

## 5 Press $\leftarrow/\rightarrow$ to select a setting.

- [STANDARD]: when installing all the speakers normally.

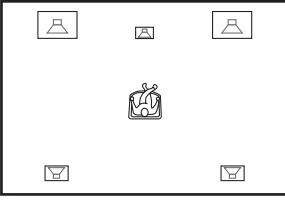

- [NO CENTER]: when installing the front and surround speakers.

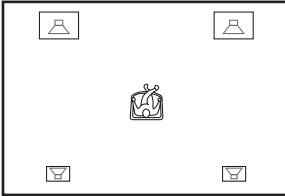

- [NO SURROUND]: when installing the center and front speakers.

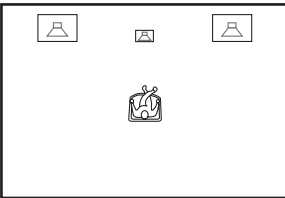

- [FRONT ONLY]: when installing the front speakers.

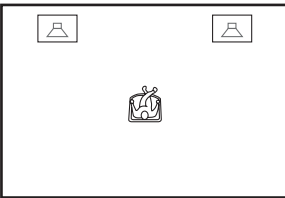

- [ALL FRONT]: when installing all the speakers in front of the listening position.

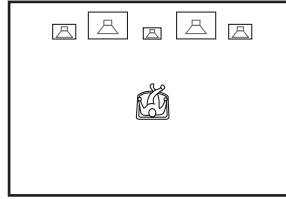

- [ALL FRONT - NO CENTER]: when installing the front and surround speakers in front of the listening position.

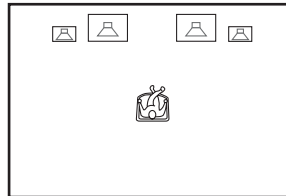

- [SECOND ROOM]: when installing the front speakers in one room and surround speakers in another.

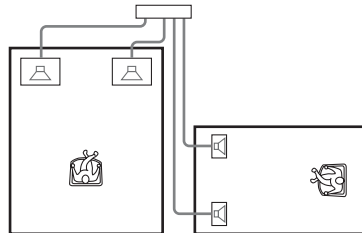

### Note

- Speaker sound in the other room is the same as that of the front and surround speakers.

## 6 Press $\oplus$ .

The setting is made.

## 7 Press $\uparrow/\downarrow$ to select [YES] or [NO], then press $\oplus$ .

- [YES]: continue with [AUTO CALIBRATION], see Step 4 of “Calibrating the Appropriate Settings” (page 64).
- [NO]: exit [SPEAKER FORMATION].

continued

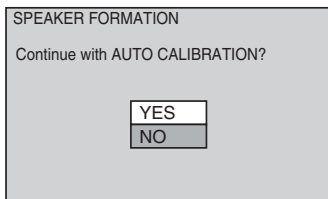

**Note**

- In order to enjoy the surround sound after you change the position of the speakers, it is recommended you set [SPEAKER FORMATION], and then set [AUTO CALIBRATION].
- To set [AUTO CALIBRATION], you need to connect the supplied calibration mic.
- The front panel display indicates the selected [SPEAKER FORMATION]. It does not indicate the speakers which output sound.
- When you change the [CONNECTION] setting in [SPEAKER SETUP], the [SPEAKER FORMATION] setting returns to [STANDARD].





## Calibrating the Appropriate Settings Automatically

### (AUTO CALIBRATION)



D. C. A. C. (Digital Cinema Auto Calibration) can set the appropriate surround sound automatically.

**Note**

- Loud test sound is output when [AUTO CALIBRATION] starts. You cannot turn the volume down. Give consideration to children and neighbor.

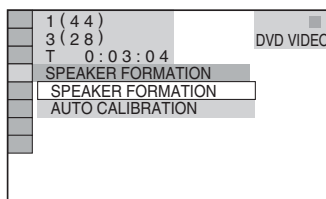
- 1 Press FUNCTION repeatedly until “DVD” appears in the front panel display.**
- 2 Press  DISPLAY when the system is in stop mode.**  
The Control Menu display appears.
- 3 Press  to select  [SPEAKER FORMATION], then press .**



- 4 Press  to select [AUTO CALIBRATION], then press .**

The options for [AUTO CALIBRATION] appear.

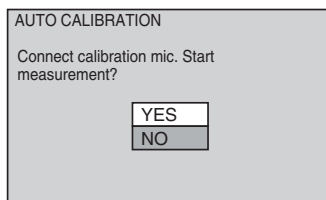

Connect the calibration mic to the A.CAL MIC jack on the front panel, and set it up at the ear level using a tripod, etc. (not supplied). The front of each speaker should



face the calibration mic, and there should be no obstruction between the speakers and the calibration mic. Be quiet during the measurement.

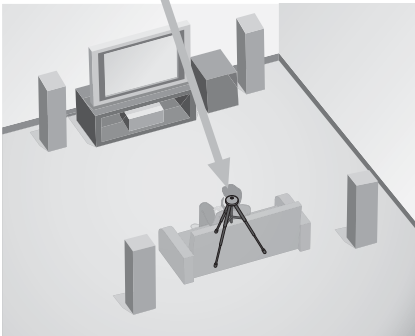
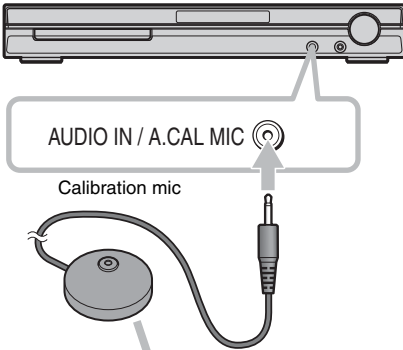

**5** Press  $\uparrow/\downarrow$  to select [YES], then press  $\oplus$ .  
Calibration starts.



**Note**

- Avoid being in the measurement area and making noise during the measurement (about three minutes), to avoid measurement failure. During the measurement, test signals are output from the speakers.

- The environment of the room in which the system is installed may affect measurements.
- If an error message appears, follow the message, then select [YES].  
An error message appears when:
  - the headphones are connected.
  - the calibration mic is not connected.
  - front speakers are not correctly connected.
  - surround speakers are not correctly connected.
  - front and surround speakers are not correctly connected.
  - there is excessive noise around the calibration mic.
  - the calibration mic is overloaded.

**6** Press  $\leftarrow/\rightarrow$  to select [YES] or [NO], then press  $\oplus$ .

**■ The measurement is OK.**

Disconnect the calibration mic, then select [YES]. The result is implemented.

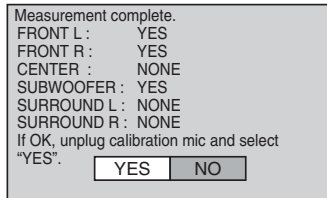

**■ The measurement is not OK.**

Follow the message, then select [YES] to retry.

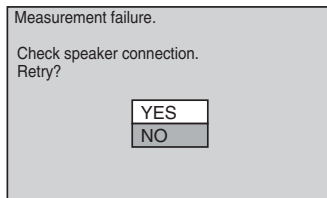

**Tip**

- You can check the distance between the listening position and each speaker. See page 71.

**Note**

- While the Auto Calibration function works:
  - do not turn off the power.
  - do not press any button.
  - do not change the volume.
  - do not change the function.
  - do not change the disc.
  - do not insert or eject a disc.
  - do not connect the headphones.
  - do not disconnect the calibration mic.
- The measurement for [SUBWOOFER] is always [YES] since the system does not perform subwoofer calibration.

## Using the Setup Display

By using the Setup Display, you can make various adjustments to items such as picture and sound.

For an overall list of Setup Display items, see page 91.

Displayed items vary depending on the country model.

**Note**

- Playback settings stored in the disc take priority over the Setup Display settings and not all the functions described may work.

**1** Press **FUNCTION** repeatedly until “DVD” appears in the front panel display.

**2** Press **DISPLAY** when the system is in stop mode.

The Control Menu display appears.

**3** Press **↑/↓** to select **[SETUP]**, then press **+**.

The options for [SETUP] appear.

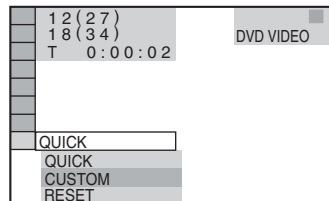

**4** Press **↑/↓** to select [CUSTOM], then press **+**.

The Setup Display appears.

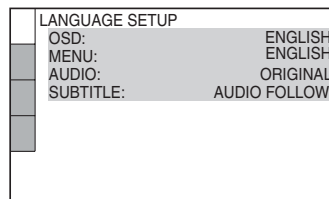

**5** Press  $\uparrow/\downarrow$  to select the setup item from the displayed list: [LANGUAGE SETUP], [SCREEN SETUP], [CUSTOM SETUP], or [SPEAKER SETUP]. Then press  $\oplus$ .

The Setup item is selected.  
Example: [SCREEN SETUP]

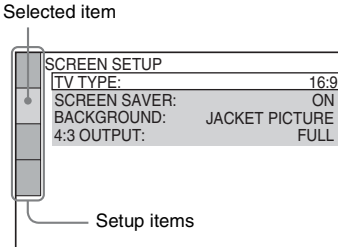

**6** Select an item using  $\uparrow/\downarrow$ , then press  $\oplus$ .

The options for the selected item appear.  
Example: [TV TYPE]

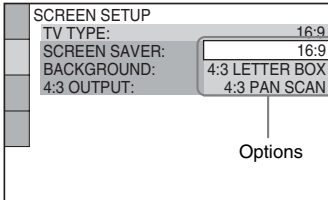

**7** Select a setting using  $\uparrow/\downarrow$ , then press  $\oplus$ .

The setting is selected and setup is complete.

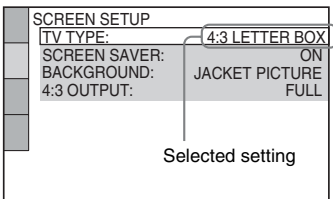

## To reset all of the [SETUP] settings

- 1 Select [RESET] in Step 4 and press  $\oplus$ .
- 2 Select [YES] using  $\uparrow/\downarrow$ .

You can also quit the process and return to the Control Menu display by selecting [NO] here.

- 3 Press  $\oplus$ .

All the settings explained on pages 68 to 73 return to the default settings. Do not press  $\mathbf{I}/\mathbf{O}$  while resetting the system as it takes a few seconds to complete.

### Note

- When you turn the system on after resetting and no disc is in the unit, the guide message appears on the TV screen. To perform the Quick Setup (page 14), press  $\ominus$ , to return to normal screen, press CLEAR.

# Setting the Display or Sound Track Language

## [LANGUAGE SETUP]

[LANGUAGE SETUP] allows you to set various languages for the on-screen display or sound track.

Select [LANGUAGE SETUP] in the Setup Display. For details, see “Using the Setup Display” (page 66).

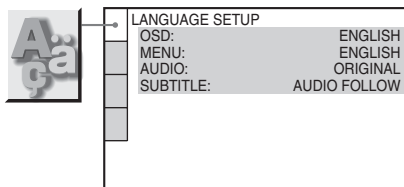

### ■ [OSD] (On-Screen Display)

Switches the display language on the TV screen.

### ■ [MENU] (DVD VIDEO only)

You can select the desired language for the disc's menu.

### ■ [AUDIO] (DVD VIDEO only)

Switches the language of the sound track.

When you select [ORIGINAL], the language given priority in the disc is selected.

### ■ [SUBTITLE] (DVD VIDEO only)

Switches the language of the subtitle recorded on the DVD VIDEO.

When you select [AUDIO FOLLOW], the language for the subtitles changes according to the language you selected for the sound track.

#### Tip

- If you select [OTHERS →] in [MENU], [AUDIO], and [SUBTITLE], select and enter a language code from “Language Code List” (page 85) using the number buttons.

#### Note

- When you select a language in [MENU], [AUDIO], or [SUBTITLE] that is not recorded on the DVD VIDEO, one of the recorded languages will be automatically selected (depending on the disc, the language may not be selected automatically).

# Settings for the Display

## [SCREEN SETUP]

Choose settings according to the TV to be connected.

Select [SCREEN SETUP] in the Setup Display. For details, see “Using the Setup Display” (page 66).

The default settings are underlined.

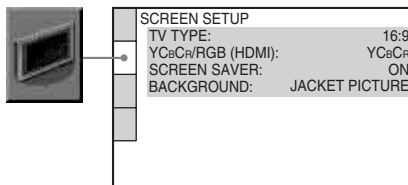

### ■ [TV TYPE]

Selects the aspect ratio of the connected TV (4:3 standard or wide).

---

#### [16:9]

Select this when you connect a wide-screen TV or a TV with a wide mode function.

---

#### [4:3 LETTER BOX]

Select this when you connect a 4:3 screen TV. Displays a wide picture with bands on the upper and lower portions of the TV screen.

---

#### [4:3 PAN SCAN]

Select this when you connect a 4:3 screen TV. Automatically displays the wide picture on the entire screen and cuts off the portions that do not fit.

---

[16:9]



[4:3 LETTER BOX]



[4:3 PAN SCAN]



**Note**

- Depending on the DVD, [4:3 LETTER BOX] may be selected automatically instead of [4:3 PAN SCAN] or vice versa.

■ **[YCbCr/RGB (HDMI)]**

Selects the type of HDMI signal output from HDMI OUT jack.

<b>[YCbCr]</b>	Outputs YCbCr signals.
<b>[RGB]</b>	Outputs RGB signals.

**Note**

- If the playback picture becomes distorted, set [YCbCr] to [RGB].
- If the HDMI OUT jack is connected to equipment with a DVI jack, [RGB] signals will be automatically output even when you select [YCbCr].

■ **[SCREEN SAVER]**

The screen saver image appears when you leave the system in pause or stop mode for 15 minutes, or when you play back a CD, DATA CD (MP3 audio), or DATA DVD (MP3 audio) for more than 15 minutes. The screen saver will help prevent your display device from becoming damaged (ghosting). Press any button (e.g., ) to cancel the screen saver.

<b>[ON]</b>	Turns on the screen saver.
<b>[OFF]</b>	Turns off the screen saver.

■ **[BACKGROUND]**

Selects the background color or picture on the TV screen in stop mode or while playing a CD, DATA CD (MP3 audio), or DATA DVD (MP3 audio).

**[JACKET PICTURE]**

The jacket picture (still picture) appears, but only when the jacket picture is already recorded on the disc (CD-EXTRA, etc.). If the disc does not contain a jacket picture, the [GRAPHICS] picture appears.

**[GRAPHICS]**

A preset picture stored in the system appears.

**[BLUE]**

The background color is blue.

**[BLACK]**

The background color is black.

# Custom Settings

## [CUSTOM SETUP]

Use this to set up playback related and other settings.

Select [CUSTOM SETUP] in the Setup Display. For details, see "Using the Setup Display" (page 66).

The default settings are underlined.

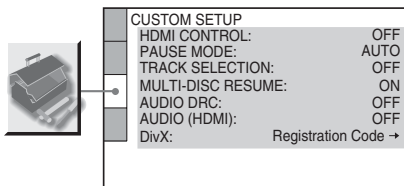

### ■ [HDMI CONTROL]

Switches the HDMI CONTROL function on or off. This function is available when you connect the system and TV with the HDMI cord. For details on this function, see the HDMI CONTROL Guide (supplied separately).

<b>[OFF]</b>	Sets the HDMI CONTROL function to off.
<b>[ON]</b>	Sets the HDMI CONTROL function to on. You can operate mutually between components that are connected with the HDMI cord.

#### Note

- When you set to [ON] without the HDMI connection of the TV, [Please verify the HDMI connection] appears and you can not set to [ON].

### ■ [PAUSE MODE] (DVD VIDEO/DVD-R/ DVD-RW only)

Selects the picture in pause mode.

<b>[AUTO]</b>	The picture, including subjects that move dynamically, is output with no jitter. Normally select this position.
<b>[FRAME]</b>	The picture, including subjects that do not move dynamically, is output in high resolution.

### ■ [TRACK SELECTION] (DVD VIDEO only)

Gives the sound track which contains the highest number of channels priority when you play a DVD VIDEO on which multiple audio formats (PCM, DTS, MPEG audio, or Dolby Digital format) are recorded.

<b>[OFF]</b>	No priority given.
<b>[AUTO]</b>	Priority given.

#### Note

- When you set the item to [AUTO], the language may change. The [TRACK SELECTION] setting has higher priority than the [AUDIO] settings in [LANGUAGE SETUP] (page 68). (Depending on the disc, this function may not work.)
- If PCM, DTS, Dolby Digital sound, and MPEG audio tracks have the same number of channels, the system selects PCM, DTS, Dolby Digital sound, and MPEG audio tracks in this order.

### ■ [MULTI-DISC RESUME] (DVD VIDEO/ VIDEO CD only)

Switches the Multi-disc Resume setting on or off.

<b>[ON]</b>	Stores the resume settings in memory for up to 40 discs.
<b>[OFF]</b>	Does not store the resume settings in memory. Playback restarts at the resume point only for the current disc in the unit.

### ■ [AUDIO DRC] (DVD VIDEO only)

Narrows the dynamic range of the sound track. Useful for watching movies at low volume late at night.

<b>[OFF]</b>	No compression of dynamic range.
<b>[STANDARD]</b>	Reproduces the sound track with the kind of dynamic range that the recording engineer intended.
<b>[MAX]</b>	Compresses dynamic range fully.

## ■ [AUDIO (HDMI)]

Selects the audio output status from the HDMI OUT jack.

[OFF]	The sound is not output from the HDMI OUT jack.
[ON]	Outputs audio signals by converting Dolby Digital, DTS, or 96 kHz/24 bit PCM signals to 48 kHz/ 16 bit PCM.

### Note

- When you connect the unit and TV with the HDMI cord and [ON] is selected, DYNAMIC BASS, MOVIE/MUSIC, and sound field are not applied to the sound that is output from the TV.

## ■ [DivX]

**(Except for United Kingdom and North American models)**

Displays the registration code for this system.

For more information, go to

<http://www.divx.com> on the Internet.

# Settings for the Speakers

## [SPEAKER SETUP]

To obtain the best possible surround sound, set connection of the speakers and their distance from your listening position. Then use the test tone to adjust the level and the balance of the speakers to the same level.

Select [SPEAKER SETUP] in the Setup Display. For details, see “Using the Setup Display” (page 66).

The default settings are underlined.

### Note

- You cannot operate these setup items when you connect headphones to the unit.

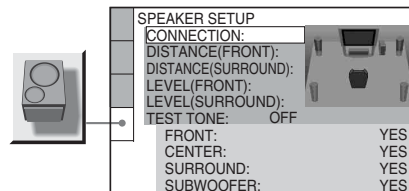

## To return to the default setting when changing a setting

Select the item, then press CLEAR. Note that only the [CONNECTION] setting does not return to the default setting.

## ■ [CONNECTION]

If you do not connect center or surround speakers, set the parameters for [CENTER] and [SURROUND]. Since the front speaker and subwoofer setting is fixed, you cannot change them.

[FRONT]	<u>[YES]</u>
[CENTER]	<u>[YES]</u> : Normally select this. [NONE]: Select this if no center speaker is used.
[SURROUND]	<u>[YES]</u> : Normally select this. [NONE]: Select this if no surround speaker is used.
[SUBWOOFER]	<u>[YES]</u>

**Note**

• When you change the [CONNECTION] setting, the [SPEAKER FORMATION] setting returns to [STANDARD].

**■ [DISTANCE (FRONT)]**

The default distance setting for the speakers in relation to the listening position is shown below. When you set the distance using the Quick Setup (page 14), the settings is automatically displayed.

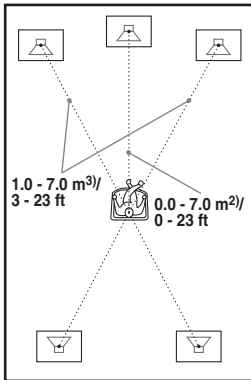

Be sure to change the value in the Setup Display when you move the speakers.

---

**[L/R]**  
**3.0 m/10 ft<sup>1)</sup>** Front speaker distance from the listening position can be set from 1.0 to 7.0 meters<sup>3)</sup> (3 to 23 ft).

---

**[CENTER]**  
**3.0 m/10 ft<sup>1)</sup>**  
(appears when you set [CENTER] to [YES] in the [CONNECTION] setting.) Center speaker distance can be moved up to 1.6 meters (5 ft) closer to the listening position from the front speaker distance.

---

<sup>1)</sup>When you perform the Quick Setup (page 14), the default settings are changed.

<sup>2)</sup>0.0 to 6.9 meters for North American models.

<sup>3)</sup>0.9 to 6.9 meters for North American models.

**■ [DISTANCE (SURROUND)]**

The default distance setting for the speakers in relation to the listening position is shown below. When you set the distance using the Quick Setup (page 14), the settings is automatically displayed.

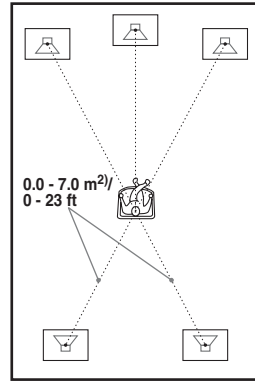

Be sure to change the value in the Setup Display when you move the speakers.

---

**[L/R]**  
**3.0 m/10 ft<sup>1)</sup>**  
(appears when you set [SURROUND] to [YES] in the [CONNECTION] setting.) Surround speakers distance can be moved up to 5.0 meters (16 ft) closer to the listening position from the front speaker distance.

---

<sup>1)</sup>When you perform the Quick Setup (page 14), the default settings are changed.

<sup>2)</sup>0.0 to 6.9 meters for North American models.

**Note**

- If all front and surround speakers are not placed at an equal distance from your listening position, set the distance according to the closest speaker.
- Do not place the surround speakers farther away from your listening position than the front speakers.
- Depending on the input stream, the [DISTANCE] setting may not be effective.

**■ [LEVEL (FRONT)]**

You can vary the level of front speakers as follows. Be sure to set [TEST TONE] to [ON] for easy adjustment.

---

**[L/R]**  
**0.0 dB** Set this between -6.0 dB and 0.0 dB.

---

**[CENTER]**  
**0.0 dB**  
(appears when you set [CENTER] to [YES] in the [CONNECTION] setting.) Set this between -6.0 dB and +6.0 dB.

---



---

**[SUBWOOFER]** Set this between -6.0 dB and +2.0 dB  
**+2.0 dB** +6.0 dB.

---

### ■ [LEVEL (SURROUND)]

You can vary the level of surround speakers as follows. Be sure to set [TEST TONE] to [ON] for easy adjustment.

---

**[L/R]** Set this between -6.0 dB and 0.0 dB  
**0.0 dB** +6.0 dB.  
(appears when you set [SURROUND] to [YES] in the [CONNECTION] setting.)

---

## To adjust the volume of all the speakers at one time

Turn the VOLUME control on the unit, or press VOLUME +/- on the remote.

### ■ [TEST TONE]

The speakers will emit a test tone to adjust [LEVEL (FRONT)] and [LEVEL (SURROUND)].

---

**[OFF]** The test tone is not emitted from the speakers.

---

**[ON]** The test tone is emitted from each speaker in sequence while adjusting level. When you select one of the [SPEAKER SETUP] items, the test tone is emitted from each speaker in sequence.

---

## Adjusting the speaker level by using the test tone

**1** Press  DISPLAY when the system is in stop mode.

The Control Menu display appears.

**2** Press  $\uparrow/\downarrow$  to select  [SETUP], then press  $\oplus$ .

The options for [SETUP] appear.

**3** Press  $\uparrow/\downarrow$  to select [CUSTOM], then press  $\oplus$ .

The Setup Display appears.

**4** Press  $\uparrow/\downarrow$  repeatedly to select [SPEAKER SETUP], then press  $\oplus$  or  $\rightarrow$ .

**5** Press  $\uparrow/\downarrow$  repeatedly to select [TEST TONE], then press  $\oplus$  or  $\rightarrow$ .

**6** Press  $\uparrow/\downarrow$  repeatedly to select [ON], then press  $\oplus$ .

You will hear the test tone from each speaker in sequence.

**7** From your listening position, adjust the value of [LEVEL (FRONT)] or [LEVEL (SURROUND)] using  $\leftarrow/\uparrow/\downarrow/\rightarrow$ .

The test tone is emitted from only the speaker which you are adjusting.

**8** Press  $\oplus$  when you have finished making adjustments.

**9** Press  $\uparrow/\downarrow$  repeatedly to select [TEST TONE], then press  $\oplus$ .

**10** Press  $\uparrow/\downarrow$  repeatedly to select [OFF], then press  $\oplus$ .

#### Note

- The test tone signals are not output from the HDMI OUT jack.

## Returning to the Default Settings

You can return the system parameters, such as preset stations, to the default settings.

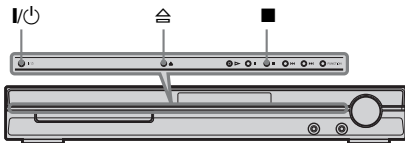

- 1 Press I/⏻ to turn on the system.**
- 2 Press ■, ≡, and I/⏻ on the unit at the same time.**

“COLD RESET” appears in the front panel display and the default settings are returned.

## Additional Information

### Precautions

#### On power sources

- Unplug the unit from the wall outlet if you do not intend to use it for an extended period of time. To disconnect the cord, pull it out by the plug, never by the cord.

#### On placement

- Place the system in a location with adequate ventilation to prevent heat build-up in the system.
- At high volume, over long periods of time, the cabinet becomes hot to the touch. This is not a malfunction. However, touching the cabinet should be avoided. Do not place the unit in a confined space where ventilation is poor as this may cause overheating.
- Do not block the ventilation slots by putting anything on the system. The system is equipped with a high power amplifier. If the ventilation slots are blocked, the unit can overheat and malfunction.
- Do not place the unit on surfaces (rugs, blankets, etc.) or near materials (curtains, draperies) that may block the ventilation slots.
- Do not install the unit near heat sources such as radiators, or air ducts, or in a place subject to direct sunlight, excessive dust, mechanical vibration, or shock.
- Do not install the unit in an inclined position. It is designed to be operated in a horizontal position only.
- Keep the unit and discs away from equipment with strong magnets, such as microwave ovens, or large loudspeakers.
- Do not place heavy objects on the unit.

#### On operation

- If the system is brought directly from a cold to a warm location, or is placed in a very damp room, moisture may condense on the lenses inside the control unit. Should this occur, the system may not operate properly. In this case, remove the disc and leave the system turned on for about half an hour until the moisture evaporates.
- When you move the system, take out any disc. If you don't, the disc may be damaged.
- If anything falls into the cabinet, unplug the unit and have it checked by qualified personnel before operating it any further.

#### On adjusting volume

- Do not turn up the volume while listening to a section with very low level inputs or no audio signals. If you do, the speakers may be damaged when a peak level section is suddenly played.

#### On cleaning

- Clean the cabinet, panel, and controls with a soft cloth slightly moistened with a mild detergent solution. Do not use any type of abrasive pad, scouring powder or solvent such as alcohol or benzene.  
If you have any questions or problems concerning your system, please consult your nearest Sony dealer.

#### On cleaning discs, disc/lens cleaners

- **Do not use cleaning discs or disc/lens cleaners (including wet or spray types). These may cause the apparatus to malfunction.**

#### On your TV's color

- If the speakers should cause the TV screen to have color irregularity, turn off the TV then turn it on after 15 to 30 minutes. If color irregularity should persist, place the speakers further away from the TV set.

#### IMPORTANT NOTICE

Caution: This system is capable of holding a still video image or on-screen display image on your television screen indefinitely. If you leave the still video image or on-screen display image displayed on your TV for an extended period of time you risk permanent damage to your television screen. Projection televisions are especially susceptible to this.

#### On moving the system

Before moving the system, make sure that there is no disc inserted, and remove the AC power cord (mains lead) from the wall outlet (mains).

## Notes about the Discs

### On handling discs

- To keep the disc clean, handle the disc by its edge. Do not touch the surface.
- Do not stick paper or tape on the disc.



- Do not expose the disc to direct sunlight or heat sources such as hot air ducts, or leave it in a car parked in direct sunlight as the temperature may rise considerably inside the car.
- After playing, store the disc in its case.

### On cleaning

- Before playing, clean the disc with a cleaning cloth.  
Wipe the disc from the center out.



- Do not use solvents such as benzine, thinner, commercially available cleaners, or anti-static spray intended for vinyl LPs.

This system can only play back a standard circular disc. Using neither standard nor circular discs (e.g., card, heart, or star shape) may cause a malfunction.

Do not use a disc that has a commercially available accessory attached, such as a label or ring.

## Troubleshooting

If you experience any of the following difficulties while using the system, use this troubleshooting guide to help remedy the problem before requesting repairs. Should any problem persist, consult your nearest Sony dealer.

Note that if service personnel changes some parts during repair, these parts may be retained.

### Power

#### The power is not turned on.

- Check that the AC power cord (mains lead) is connected securely.
- Press **I/⏻** after “STANDBY” disappears from the front panel display.

#### If “PROTECTOR” and “PUSH POWER” appear alternately in the front panel display.

- Press **I/⏻** to turn off the system, and check the following items after “STANDBY” disappears.
- Are the + and – speaker cords short-circuited?
  - Are you using only the specified speakers?
  - Is anything blocking the ventilation holes of the system?

After checking the above items and fixing any problems, turn on the system. If the cause of the problem cannot be found even after checking all the above items, consult your nearest Sony dealer.

### Picture

#### There is no picture.

- The SCART (EURO AV) cord is not connected securely.
- The SCART (EURO AV) cord is damaged.
- The unit is not connected to the correct EURO AV  INPUT jack (page 9).
- The video input on the TV is not set so that you can view pictures from the system.
- Check the output method on your system (page 16).
- Re-connect the connecting cord securely.
- The unit is connected to an input device that is not HDCP (high-bandwidth digital content protection) compliant (“HDMI” on the front panel does not light up). See page 87.
- If the HDMI OUT jack is used for video output, changing the type of video signal output from the HDMI OUT jack by pressing VIDEO FORMAT may solve the problem (page 20).  
Connect the TV and the unit using a video jack

other than the HDMI OUT, and switch the TV's input to the connected video input so that you can see the on-screen displays. Change the type of video signal output from the HDMI OUT jack, and switch the TV's input back to HDMI. If the picture still does not appear, repeat the steps and try other options.

- You have selected "PROGRESSIVE" using the VIDEO FORMAT button on the remote ("PROGRE" lights up in the front panel display) even though your TV cannot accept the progressive signal. In this case, disconnect the HDMI cord from the unit and then select "INTERLACE" so that "PROGRE" turns off.
- If the signal from the LINE OUT (VIDEO) jack is distorted, change the type of video signal output from the HDMI OUT jack by pressing VIDEO FORMAT to [720 × 480p]\* (page 20).

\* Depending on the country, [720 × 576p] may appear.

---

### Picture noise appears.

- The disc is dirty or flawed.

---

### Even though you set the aspect ratio in [TV TYPE] of [SCREEN SETUP], the picture does not fill the TV screen.

- The aspect ratio on the disc is fixed.

---

### Color irregularity occurs on the TV screen.

The subwoofer and the front speakers in this system are magnetically shielded to prevent magnetic leakage. However, some leakage may occur, as a high-strength magnet is employed. If this happens, check the following items:

- If the speakers are used with a CRT-based TV or projector, install the speakers at least 0.3 meters (1.0 ft) from the TV set.
- If the color irregularity persists, turn off the TV set once, then turn it on after 15 to 30 minutes.
- If howling occurs, reposition the speakers farther away from the TV set.
- Make sure that no magnetic object (magnetic latch on a TV stand, health care device, toy, etc.) is placed near the speakers.

---

## Sound

---

### There is no sound.

- The speaker cord is not connected securely.
- Press MUTING on the remote if "MUTING ON" is displayed in the front panel display.
- The system is in pause mode or in Slow-motion Play mode. Press  $\square$  to return to normal play mode.
- Fast forward or fast reverse is performed. Press  $\square$  to return to normal play mode.

- Check the speaker settings (page 71).
- The equipment connected to the HDMI OUT jack does not conform to the audio signal format, in this case set [AUDIO (HDMI)] in [CUSTOM SETUP] to [ON] (page 71).

---

### No sound is output from the HDMI OUT jack.

- Set [AUDIO (HDMI)] in [CUSTOM SETUP] to [ON] (page 71).
- The HDMI OUT jack is connected to a DVI (digital visual interface) device (DVI (digital visual interface) jacks do not accept audio signals).
- Try the following: ① Turn the system off and on again. ② Turn the connected equipment off and on again. ③ Disconnect and then connect the HDMI cord again.

---

### The left and right sounds are unbalanced or reversed.

- Check that the speakers and components are connected correctly and securely.

---

### There is no sound from the subwoofer.

- Check the speaker connections and settings (page 9, 71).
- Set the sound field to "A.F.D. STD" (page 26).

---

### Severe hum or noise is heard.

- Check that the speakers and components are connected securely.
- Check that the connecting cords are away from a transformer or motor, and at least 3 meters (10 ft) away from your TV set or a fluorescent light.
- Move your TV away from the audio components.
- The plugs and jacks are dirty. Wipe them with a cloth slightly moistened with alcohol.
- Clean the disc.

---

### The sound loses stereo effect when you play a VIDEO CD, a CD, or an MP3.

- Set [AUDIO] to [STEREO] by pressing AUDIO (page 35).
- Make sure the unit is connected properly.

---

### The surround effect is difficult to hear when you are playing a Dolby Digital, DTS, or MPEG audio sound track.

- Make sure the sound field function is on (page 26).
- Check the speaker connections and settings (page 9, 71).
- Depending on the DVD, the output signal may not be the entire 5.1 channel. It may be monaural or stereo even if the sound track is recorded in Dolby Digital or MPEG audio format.

---

**The sound comes from the center speaker only.**

- Depending on the disc, the sound may come from the center speaker only.

---

**No sound is heard from the center speaker.**

- Check the speaker connections and settings (page 9, 71).
- Make sure the sound field function is on (page 26).
- Depending on the source, the effect of the center speaker may be less noticeable.
- A 2 channel source is being played.

---

**No sound or only a very low-level sound is heard from the surround speakers.**

- Check the speaker connections and settings (page 9, 71).
- Make sure the sound field function is on (page 26).
- Depending on the source, the effect of the surround speakers may be less noticeable.
- A 2 channel source is being played.

---

**There is no sound from the speakers that are indicated in the front panel display.**

- The front panel display indicates the selected [SPEAKER FORMATION]. It does not indicate the speakers which output sound (page 26, 62).

---

**Operation**

---

**Radio stations cannot be tuned in.**

- Check that the antenna (aerial) is connected securely. Adjust the antenna (aerial) or connect an external antenna (aerial) if necessary.
- The signal strength of the stations is too weak (when tuning in with automatic tuning). Use direct tuning.
- No stations have been preset or the preset stations have been cleared (when tuning by scanning preset stations). Preset the stations (page 51).
- Press DISPLAY so that the frequency appears in the front panel display.

---

**The remote does not function.**

- There are obstacles between the remote and the unit.
- The distance between the remote and the unit is too far.
- The remote is not pointed at the remote sensor on the unit.
- The batteries in the remote are weak.

---

**The disc does not play.**

- There is no disc inserted.
- The disc is upside down.  
Insert the disc with the playback side facing down.
- The disc is skewed on the disc tray.

- The system cannot play CD-ROMs, etc. (page 6).
- The region code on the DVD does not match the system.
- Moisture has condensed inside the unit and may cause damage to the lenses. Remove the disc and leave the unit turned on for about half an hour.

---

**The MP3 audio track cannot be played.**

- The DATA CD is not recorded in the MP3 format that conforms to ISO 9660 Level 1/Level 2, or Joliet.
- The DATA DVD is not recorded in an MP3 format that conforms to UDF (Universal Disk Format).
- The MP3 audio track does not have the extension “.MP3.”
- The data is not formatted in MP3 even though it has the extension “.MP3.”
- The data is not MPEG1 Audio Layer 3 data.
- The system cannot play audio tracks in MP3PRO format.
- The [MODE (MP3, JPEG)] setting has been set to [IMAGE (JPEG)] (page 46).
- If you cannot change the [MODE (MP3, JPEG)] setting, re-load the disc or turn the system off, then on.
- The DATA CD/DATA DVD contains a DivX video file (except for United Kingdom and North American models).

---

**The JPEG image file cannot be played.**

- The DATA CD is not recorded in a JPEG format that conforms to ISO 9660 Level 1/Level 2, or Joliet.
- The DATA DVD is not recorded in a JPEG format that conforms to UDF (Universal Disk Format).
- It has an extension other than “.JPEG” or “.JPG.”
- It is larger than 3,072 (width) × 2,048 (height) in normal mode, or more than 2,000,000 pixels in Progressive JPEG which is mainly used on the Internet WEB site.
- It does not fit the TV screen (those images are reduced).
- The [MODE (MP3, JPEG)] setting has been set to [AUDIO (MP3)] (page 46).
- If you cannot change the [MODE (MP3, JPEG)] setting, re-load the disc or turn the system off, then on.
- The DATA CD/DATA DVD contains a DivX video file (except for United Kingdom and North American models).

---

**The MP3 audio tracks and JPEG image file starts playing simultaneously.**

- [AUTO] has been selected in [MODE (MP3, JPEG)] (page 46).

---

**The DivX video file cannot be played (except for United Kingdom and North American models).**

- The file is not created in DivX format.
- The file has an extension other than “.AVI” or “.DIVX.”
- The DATA CD/DATA DVD is not created in a DivX format that conforms to ISO 9660 Level 1/Level 2 or, Joliet/UDF.
- The DivX video file is larger than 720 (width) × 576 (height).

---

**The titles of album/track/file name are not displayed correctly.**

- The system can only display numbers and letters of the alphabets. Other characters are displayed as [\*].

---

**A disc does not start playing from the beginning.**

- Program Play, Shuffle Play, or Repeat Play has been selected.  
Press CLEAR to cancel these functions before playing a disc.
- Resume Play has been selected.  
During stop, press ■ on the unit or the remote and then start playback (page 30).
- The title, DVD or PBC menu automatically appears on the TV screen.

---

**The system starts playing the disc automatically.**

- The DVD features an auto playback function.

---

**Playback stops automatically.**

- Some discs may contain an auto pause signal.  
While playing such a disc, the system stops playback at the auto pause signal.

---

**You cannot perform some functions such as Stop, Search, Slow-motion Play, or Repeat Play.**

- Depending on the disc, you may not be able to perform some of the operations above. See the operating instructions that came with the disc.

---

**Messages do not appear on the TV screen in the language you want.**

- In the Setup Display, select the desired language for the on-screen display in [OSD] under [LANGUAGE SETUP] (page 68).

---

**The language for the sound track cannot be changed.**

- Multilingual tracks are not recorded on the DVD being played.
- The DVD prohibits changing the language for the sound track.

---

**The subtitle language cannot be changed.**

- Multilingual subtitles are not recorded on the DVD being played.
- The DVD prohibits changing the subtitles.

---

**The subtitle cannot be turned off.**

- The DVD prohibits turning off subtitles.

---

**The angles cannot be changed.**

- Multi-angles are not recorded on the DVD being played (page 40).
- The DVD prohibits changing the angles.

---

**A disc cannot be ejected and “LOCKED” appears in the front panel display.**

- Contact your Sony dealer or local authorized Sony service facility.

---

**[Data error] appears on the TV screen when playing a DATA CD or DATA DVD.**

- The MP3 audio track/JPEG image file/DivX video file\* you want to play is broken.
- The data is not MPEG1 Audio Layer 3 data.
- The JPEG image file format does not conform to DCF.
- The JPEG image file has the extension “.JPG” or “.JPEG,” but is not in JPEG format.
- The file you want to play has the extension “.AVI” or “.DIVX” but is not in DivX format, or is in DivX format but does not conform to a DivX Certified profiles.\*

\* Except for United Kingdom and North American models.

---

**The system does not work normally.**

- Disconnect the AC power cord (mains lead) from the wall outlet (mains), then reconnect after several minutes.

---

**The unit does not work and “CHILD LOCK” appears in the front panel display when you press any button on the unit.**

- Set the child lock function to off (page 58).

---

**The HDMI CONTROL function does not work.**

- When “HDMI” does not light up in the front panel display, check the HDMI connection (page 19).
- Set the [HDMI CONTROL] setting in [CUSTOM SETUP] to [ON] (page 70).
- Make sure that the connected component is compatible with the HDMI CONTROL function.

*continued*

- Check that the AC power cord (mains lead) of the connected component is connected securely.
- Check the connected component's setting for the HDMI CONTROL function. See the operating instructions of the component.
- If you change the HDMI connection, connect and disconnect the AC power cord (mains lead), or have a power failure, set the [HDMI CONTROL] setting in [CUSTOM SETUP] to [OFF], then set the [HDMI CONTROL] setting in [CUSTOM SETUP] to [ON] (page 70).
- For details on the HDMI CONTROL function, see the HDMI CONTROL Guide (supplied separately).

---

**No sound is output from the system and TV while using the System Audio Control function.**

- Set the [AUDIO (HDMI)] setting in [CUSTOM SETUP] to [ON] (page 71).
- Make sure that the connected TV is compatible with the System Audio Control function.
- For details on the System Audio Control function, see the HDMI CONTROL Guide (supplied separately).

## Self-diagnosis Function

### *(When letters/numbers appear in the display)*

When the self-diagnosis function is activated to prevent the system from malfunctioning, a 5-character service number (e.g., C 13 50) with a combination of a letter and 4 digits appears on the TV screen or front panel display. In this case, check the following table.

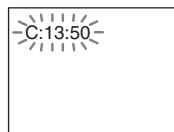

First 3 characters of the service number	Cause and/or corrective action
C 13	The disc is dirty. ➔ Clean the disc with a soft cloth (page 76).
C 31	The disc is not inserted correctly. ➔ Restart the system, then re-insert the disc correctly.
E XX (xx is a number)	To prevent a malfunction, the system has performed the self-diagnosis function. ➔ Contact your nearest Sony dealer or local authorized Sony service facility and give the 5-character service number. Example: E 61 10

### **When displaying the version number on the TV screen**

When you turn on the system, the version number [VER.X.XX] (X is a number) may appear on the TV screen. Although this is not a malfunction and for Sony service use only, normal system operation will not be possible. Turn off the system, and then turn on the system again to operate.





# Specifications

## Amplifier section

Stereo mode (rated)	108 W + 108 W (at 3 ohms, 1 kHz, 1 % THD)
Surround mode (reference)	RMS output power FL/FR/C/SL/SR*: 142 watts (per channel at 3 ohms, 1 kHz, 10 % THD) Subwoofer*: 140 watts (at 3 ohms, 80 Hz, 10 % THD)

\* Depending on the sound field settings and the source, there may be no sound output.

Inputs (Analog)	
TV (AUDIO IN)	Sensitivity: 450/250 mV
AUDIO IN	Sensitivity: 250/125 mV
Outputs (Analog)	
Phones	Accepts low-and high-impedance headphones.

## DVD system

Laser	Semiconductor laser (DVD: $\lambda = 650$ nm) (CD: $\lambda = 790$ nm) Emission duration: continuous
Signal format system	PAL/NTSC

## Tuner section

System	PLL quartz-locked digital synthesizer
FM tuner section	
Tuning range	
North American models:	87.5-108.0 MHz (100 kHz step)
Other models:	87.5-108.0 MHz (50 kHz step)
Antenna (aerial)	FM wire antenna (aerial)
Antenna (aerial) terminals	75 ohms, unbalanced
Intermediate frequency	10.7 MHz
AM tuner section	
Tuning range	
North American, Mexican, and Latin American models:	530 – 1,710 kHz (with the interval set at 10 kHz) 531 – 1,710 kHz (with the interval set at 9 kHz)
European, Russian, and Middle Eastern models:	531 – 1,602 kHz (with the interval set at 9 kHz)
Australian and New Zealand models:	531 – 1,710 kHz (with the interval set at 9 kHz)

Other models:	530 – 1,710 kHz (with the interval set at 10 kHz) 531 – 1,602 kHz (with the interval set at 9 kHz) 530 – 1,610 kHz (with the interval set at 10 kHz)
Antenna (aerial)	AM loop antenna (aerial)
Intermediate frequency	450 kHz

## Video section

Outputs	VIDEO: 1 Vp-p 75 ohms R/G/B: 0.7 Vp-p 75 ohms HDMI OUT: Type A (19 pin)
---------	---

## Speakers

### Front/Surround (SS-TS71)

Speaker system	Bass reflex, magnetically shielded
Speaker unit	65 mm dia, cone type
Rated impedance	3.0 ohms
Dimensions (approx.)	93 × 162 × 75 mm (w/h/d)
Mass (approx.)	0.6 kg

### Center (SS-CT71)

Speaker system	Bass reflex, magnetically shielded
Speaker unit	65 mm dia, cone type
Rated impedance	3.0 ohms
Dimensions (approx.)	261 × 91 × 80 mm (w/h/d)
Mass (approx.)	0.7 kg

### Subwoofer (SS-WS71)

Speaker system	Bass reflex
Speaker unit	160 mm dia, cone type
Rated impedance	3.0 ohms
Dimensions (approx.)	197 × 322 × 345 mm (w/h/d)
Mass (approx.)	5.6 kg

## General

Power requirements	220 – 240 V AC, 50/60 Hz
Power consumption	On: 150 W Standby: 0.3 W (at the Power Saving mode)
Output voltage (DIGITAL MEDIA PORT)	DC 5 V
Output current (DIGITAL MEDIA PORT)	700 mA
Dimensions (approx.)	430 × 63 × 380 mm (w/h/d) incl. projecting parts
Mass (approx.)	4.1 kg

Design and specifications are subject to change without notice.

## Unpacking

- Front speakers (2)
- Center speaker (1)
- Surround speakers (2)
- Subwoofer (1)
- AM loop antenna (aerial) (1)
- FM wire antenna (aerial) (1)
- Speaker cords (6, red/white/green/gray/blue/purple)
- Remote Commander (remote) (1)
- R6 (size AA) batteries (2)
- Calibration mic (1)
- Foot pads (1 set)
- Operating Instructions
- HDMI CONTROL Guide
- Speaker and TV connections (card)



- Standby power consumption 0.3 W (or less).
- Halogenated flame retardants are not used in the printed wiring boards.
- Over 85 % power efficiency of amplifier block is achieved with the full digital amplifier, S-master.

## Glossary

### Album

Section of a music piece or an image on a data CD containing MP3 audio tracks or JPEG files.

### Chapter

Subdivision of a title on a DVD. A title is composed of several chapters.

### Digital Cinema Auto Calibration

Digital Cinema Auto Calibration was developed by Sony to automatically measure and adjust the speaker settings to your listening environment in a short period of time.

### DivX® (except for United Kingdom and North American models)

Digital video technology created by DivX, Inc. Videos encoded with DivX technology are among the highest quality with a relatively small file size.

### Dolby Digital

This movie theater sound format is more advanced than Dolby Surround Pro Logic. In this format, the surround speakers output stereo sound with an expanded frequency range, and a subwoofer channel for deep bass is independently provided. This format is also called "5.1" with the subwoofer channel designed as the 0.1 channel (since it functions only when a deep bass effect is needed). All six channels in this format are recorded separately for superior channel separation. Furthermore, since all the signals are processed digitally, less signal degradation occurs.

### Dolby Pro Logic II

Dolby Pro Logic II creates five full-bandwidth output channels from 2 channel sources. This is done using an advanced, high-purity matrix surround decoder that extracts the spatial properties of the original recording without adding any new sounds or tonal colorations.

### ■ Movie mode

The Movie mode is for use with stereo television shows and all programs encoded in Dolby Surround. The result is enhanced sound field directionality that approaches the quality of discrete 5.1-channel sound.

**■ Music mode**

The Music mode is for use with any stereo music recordings, and provides a wide and deep sound space.

**Dolby Surround Pro Logic**

As one method of decoding Dolby Surround, Dolby Surround Pro Logic produces four channels from 2 channel sound. Compared with the former Dolby Surround system, Dolby Surround Pro Logic reproduces left-to-right panning more naturally and localizes sounds more precisely. To take full advantage of Dolby Surround Pro Logic, you should have one pair of surround speakers and a center speaker. The surround speakers output monaural sound.

**DTS**

Digital audio compression technology developed by DTS, Inc. This technology conforms to 5.1-channel surround. This format comprises of stereo rear channel and there is discrete subwoofer channel in this format. DTS provides the same 5.1 discrete channels of high quality digital audio. The good channel separation is realized due to the all channel data being recorded discretely and processed in digitally.

**DVD**

A disc that contains up to 8 hours of moving pictures even though its diameter is the same as a CD.

The data capacity of a single-layer and single-sided DVD, at 4.7 GB (Giga Byte), is 7 times that of a CD. Furthermore, the data capacity of a dual-layer and single-sided DVD is 8.5 GB, a single-layer and double-sided DVD 9.4 GB, and a dual-layer and double-sided DVD 17 GB.

The picture data uses the MPEG 2 format, one of a worldwide standard of digital compression technology. The picture data is compressed to about 1/40 of its original size. The DVD also uses the variable rate coding technology that processes allocated data according to the status of the picture.

The audio data is recorded in Dolby Digital as well as in PCM, allowing you to enjoy more realistic audio presence.

Furthermore, various advanced functions such as the multi-angle, multilingual, and Parental Control functions are provided with the DVD.

**DVD+RW**

A DVD+RW (plus RW) is a recordable and rewritable disc. DVD+RWs use a recording format that is comparable to the DVD VIDEO format.

**DVD-RW**

A DVD-RW is a recordable and rewritable disc that is the same size as a DVD VIDEO. The DVD-RW has two different modes: VR mode and Video mode. DVD-RWs created in Video mode have the same format as a DVD VIDEO, while discs created in VR (Video Recording) mode allow the contents to be programmed or edited.

**File**

A JPEG image or a DivX video\* recorded on a DATA CD/DATA DVD. ("File" is an exclusive definition for this system.) A single file consists of a single image or movie.

\* Except for United Kingdom and North American models.

**Film based software, Video based software**

DVDs can be classified as Film based or Video based software. Film based DVDs contain the same images (24 frames per second) that are shown at movie theaters. Video based DVDs, such as television dramas or sit-coms, displays images at 30 frames (or 60 fields) per second.

**HDMI (high-definition multimedia interface)**

HDMI is an interface that supports both video and audio on a single digital connection, allowing you to enjoy high quality digital picture and sound. The HDMI specification supports HDCP (High-bandwidth Digital Contents Protection), a copy protection technology that incorporates coding technology for digital video signals.

**MPEG audio**

A coding system to compress digital audio signals. MPEG-1 is used for MP3 (MPEG-1 Audio Layer-3). MPEG-2 is used for one of the audio format of DVD.

**Multi-angle function**

Various angles of a scene, or viewpoints of the video camera are recorded on some DVDs.

*continued*

## **Multilingual function**

Several languages for the sound or subtitles in a picture are recorded on some DVDs.

## **Parental Control**

A function of the DVD to limit playback of the disc by the age of the users according to the limitation level in each country. The limitation varies from disc to disc; when it is activated, playback is completely prohibited, violent scenes are skipped or replaced with other scenes and so on.

## **PCM (Pulse Code Modulation)**

A method for converting analog audio to digital audio. It is used for the Compact Disc (CD) audio format.

## **Playback Control (PBC)**

Signals encoded on VIDEO CDs (Version 2.0) to control playback.

By using menu screens recorded on VIDEO CDs with PBC functions, you can enjoy playing simple interactive programs, programs with search functions, and so on.

## **Region Code**

This system is used to protect copyrights. A region number is allocated on each DVD system or DVD disc according to the sales region. Each region code is shown on the system as well as on the disc packaging. The system can play discs that match its region code. The system can also play discs with the “” mark. Even when the region code is not shown on the DVD, the region limit may still apply.

## **Scene**

On a VIDEO CD with PBC (playback control) functions, the menu screens, moving pictures and still pictures are divided into sections called “scenes.”

## **Title**

The longest section of a picture or music feature on a DVD, movie, etc., in video software, or the entire album in audio software.

## **Track**

Section of a picture or a music piece on a VIDEO CD, CD, or MP3. An album is composed of several tracks (MP3 only).

## **VIDEO CD**

A compact disc that contains moving pictures. The picture data uses the MPEG 1 format, one of a worldwide standard of digital compression technology. The picture data is compressed to about 1/140 of its original size. Consequently, a 12 cm VIDEO CD can contain up to 74 minutes of moving pictures.

VIDEO CDs also contain compact audio data. Sounds outside the range of human hearing are compressed while sounds we can hear are not compressed. VIDEO CDs can hold six times the audio information of conventional audio CDs.

There are two versions of VIDEO CDs.

- Version 1.1: You can play only moving pictures and sounds.
- Version 2.0: You can play high-resolution still pictures and enjoy PBC functions.

This system conforms to both versions.

# Language Code List

The language spellings conform to the ISO 639: 1988 (E/F) standard.

Code Language	Code Language	Code Language	Code Language
1027 Afar	1183 Irish	1347 Maori	1507 Samoan
1028 Abkhazian	1186 Scots Gaelic	1349 Macedonian	1508 Shona
1032 Afrikaans	1194 Galician	1350 Malayalam	1509 Somali
1039 Amharic	1196 Guarani	1352 Mongolian	1511 Albanian
1044 Arabic	1203 Gujarati	1353 Moldavian	1512 Serbian
1045 Assamese	1209 Hausa	1356 Marathi	1513 Siswati
1051 Aymara	1217 Hindi	1357 Malay	1514 Sesotho
1052 Azerbaijani	1226 Croatian	1358 Maltese	1515 Sundanese
1053 Bashkir	1229 Hungarian	1363 Burmese	1516 Swedish
1057 Byelorussian	1233 Armenian	1365 Nauru	1517 Swahili
1059 Bulgarian	1235 Interlingua	1369 Nepali	1521 Tamil
1060 Bihari	1239 Interlingue	1376 Dutch	1525 Telugu
1061 Bislama	1245 Inupiak	1379 Norwegian	1527 Tajik
1066 Bengali;	1248 Indonesian	1393 Occitan	1528 Thai
Bangla	1253 Icelandic	1403 (Afan)Oromo	1529 Tigrinya
1067 Tibetan	1254 Italian	1408 Oriya	1531 Turkmen
1070 Breton	1257 Hebrew	1417 Punjabi	1532 Tagalog
1079 Catalan	1261 Japanese	1428 Polish	1534 Setswana
1093 Corsican	1269 Yiddish	1435 Pashto;	1535 Tonga
1097 Czech	1283 Javanese	Pushto	1538 Turkish
1103 Welsh	1287 Georgian	1436 Portuguese	1539 Tsonga
1105 Danish	1297 Kazakh	1463 Quechua	1540 Tatar
1109 German	1298 Greenlandic	1481 Rhaeto-	1543 Twi
1130 Bhutani	1299 Cambodian	Romance	1557 Ukrainian
1142 Greek	1300 Kannada	1482 Kirundi	1564 Urdu
1144 English	1301 Korean	1483 Romanian	1572 Uzbek
1145 Esperanto	1305 Kashmiri	1489 Russian	1581 Vietnamese
1149 Spanish	1307 Kurdish	1491 Kinyarwanda	1587 Volapük
1150 Estonian	1311 Kirghiz	1495 Sanskrit	1613 Wolof
1151 Basque	1313 Latin	1498 Sindhi	1632 Xhosa
1157 Persian	1326 Lingala	1501 Sangho	1665 Yoruba
1165 Finnish	1327 Laothian	1502 Serbo-	1684 Chinese
1166 Fiji	1332 Lithuanian	Croatian	1697 Zulu
1171 Faroese	1334 Latvian;	1503 Singhalese	
1174 French	Lettish	1505 Slovak	
1181 Frisian	1345 Malagasy	1506 Slovenian	1703 Not specified

## Parental Control Area Code List

Code Area	Code Area	Code Area	Code Area
2044 Argentina	2165 Finland	2362 Mexico	2149 Spain
2047 Australia	2174 France	2376 Netherlands	2499 Sweden
2046 Austria	2109 Germany	2390 New Zealand	2086 Switzerland
2057 Belgium	2248 India	2379 Norway	2528 Thailand
2070 Brazil	2238 Indonesia	2427 Pakistan	2184 United Kingdom
2079 Canada	2254 Italy	2424 Philippines	
2090 Chile	2276 Japan	2436 Portugal	
2092 China	2304 Korea	2489 Russia	
2115 Denmark	2363 Malaysia	2501 Singapore	

# Index to Parts and Controls

For more information, refer to the pages indicated in parentheses.

## Front panel

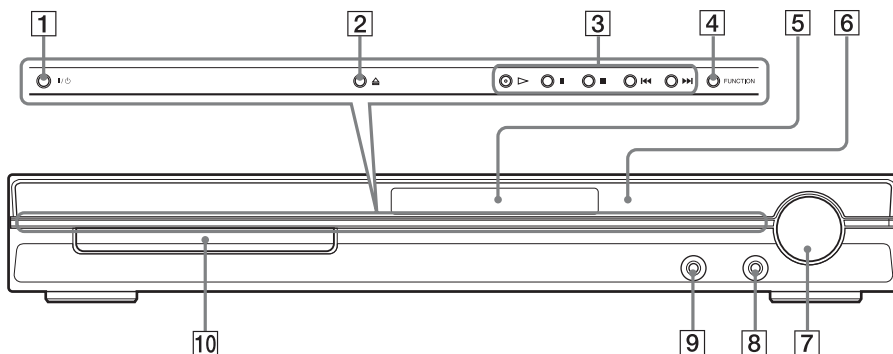

- |                                 |                                    |
|---------------------------------|------------------------------------|
| 1 I/O (on/standby) (22)         | 7 VOLUME control (22)              |
| 2 $\triangle$ (open/close) (22) | 8 PHONES jack (22)                 |
| 3 Disc operation (22)           | 9 AUDIO IN/A.CAL MIC jack (14, 21) |
| 4 FUNCTION (22)                 | 10 Disc tray (22)                  |
| 5 Front panel display (87)      |                                    |
| 6 $\square$ (remote sensor) (8) |                                    |

## Rear panel

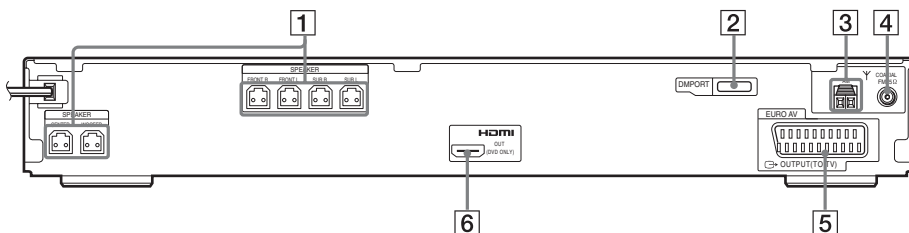

- |   |   |
|---|---|
| 1 SPEAKER jacks (9)                         | 4 COAXIAL FM 75Ω jack (9)                       |
| 2 DMPORT (DIGITAL MEDIA PORT) jack (21, 57) | 5 EURO AV $\rightarrow$ OUTPUT (TO TV) jack (9) |
| 3 AM terminal (9)                           | 6 HDMI OUT jack (19)                            |

## Front panel display

### About the indications in the front panel display

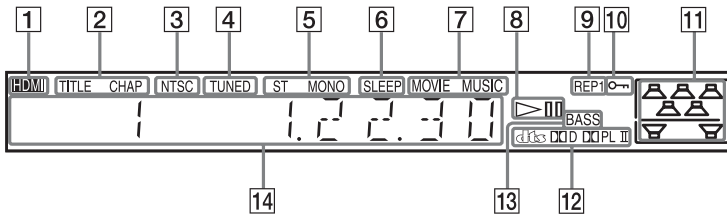

- 1 Lights up when the HDMI OUT jack is correctly connected to HDCP (high-bandwidth digital content protection) compliant device with HDMI or DVI (digital visual interface) input. (19)
- 2 Lights up when the time information of a title or chapter appears in the front panel display. (DVD only) (38)
- 3 Lights up when an NTSC disc is loaded.
- 4 Lights up when a station is received. (Radio only) (51)
- 5 Stereo/Mono effect (Radio only) (52)
- 6 Lights up when the sleep timer is set. (56)
- 7 Lights up when the movie or music mode is selected. (25)
- 8 Playing status (DVD function only)
- 9 Current repeat mode (34)
- 10 Lights up when the child lock function is set to on. (58)
- 11 Indicates the selected [SPEAKER FORMATION]. (62)
- 12 Current surround format (Except for JPEG)
- 13 Lights up when the DYNAMIC BASS is selected. (55)
- 14 Displays system's status such as chapter, title, or track number, time information, radio frequency, playing status, sound field, etc.

## Guide to the Control Menu Display

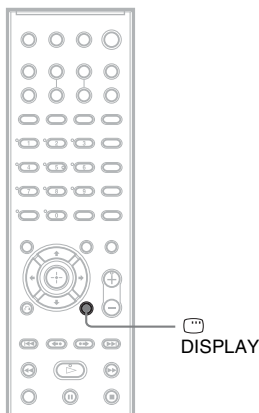

Use the Control Menu display to select a function and to view related information. Press  DISPLAY repeatedly to turn on or change the Control Menu display as follows:

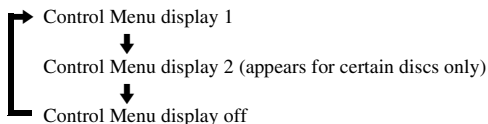

---

### Control Menu display

The Control Menu display 1 and 2 will show different items depending on the disc type. For details about each item, see the pages in parentheses.

Example: Control Menu display 1 when playing a DVD VIDEO.



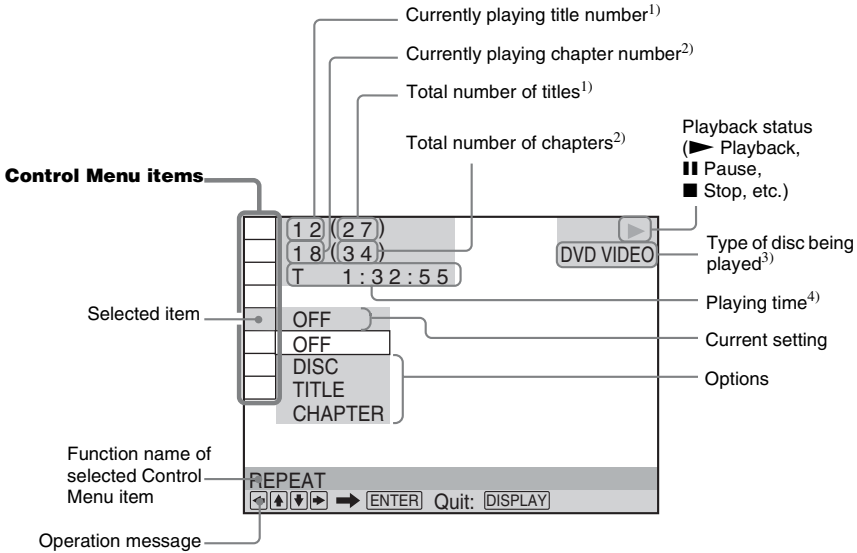

- <sup>1)</sup> Displays the scene number for VIDEO CDs (PBC is on), track number for VIDEO CDs/CDs, album number for DATA CDs/DATA DVDs. DivX video album number for DATA CDs/DATA DVDs (Except for United Kingdom and North American models).
- <sup>2)</sup> Displays the index number for VIDEO CDs, MP3 audio track number, or JPEG image file number for DATA CDs/ DATA DVDs. DivX video file number for DATA CDs/DATA DVDs (Except for United Kingdom and North American models).
- <sup>3)</sup> Displays Super VCD as "SVCD." Displays "MP3" in the Control Menu display 1 or "JPEG" in the Control Menu display 2 for DATA CDs/DATA DVDs.
- <sup>4)</sup> Displays the date for JPEG files.















### To turn off the display

Press DISPLAY.

### List of Control Menu items

Item	Item Name, Function, Relevant Disc Type
	[TITLE] (page 29)/[SCENE] (page 29)/[TRACK] (page 29) Selects the title, scene, or track to be played. <span style="float: right;">DVD-V DVD-VR VIDEO CD</span>
	[CHAPTER] (page 29)/[INDEX] (page 29) Selects the chapter or index to be played. <span style="float: right;">DVD-V DVD-VR VIDEO CD</span>
	[TRACK] (page 29) Selects the track to be played. <span style="float: right;">CD DATA-CD DATA DVD</span>
	[ORIGINAL/PLAY LIST] (page 37) Selects the type of titles (DVD-RW/DVD-R) to be played, the [ORIGINAL] one, or an edited [PLAY LIST]. <span style="float: right;">DVD-VR</span>



continued

	<p><b>[TIME/TEXT] (page 29)</b>  Checks the elapsed time and the remaining playback time.  Input the time code for picture and music searching.  Displays the DVD/CD text or the MP3 track name.</p> <p style="text-align: right;">DVD-V   DVD-VR   VIDEO CD   C D   DATA-CD   DATA DVD</p>
	<p><b>[SPEAKER FORMATION] (pages 62, 64)</b>  Sets the speaker formation./Adjust the level of each speaker automatically.</p> <p style="text-align: right;">DVD-V   DVD-VR   VIDEO CD   C D   DATA-CD   DATA DVD</p>
	<p><b>[PROGRAM] (page 31)</b>  Selects the track to play in the order you want.</p> <p style="text-align: right;">VIDEO CD   C D</p>
	<p><b>[SHUFFLE] (page 33)</b>  Plays the track in random order.</p> <p style="text-align: right;">VIDEO CD   C D   DATA-CD   DATA DVD</p>
	<p><b>[REPEAT] (page 34)</b>  Plays the entire disc (all titles/all tracks/all albums) repeatedly or one title/chapter/track/album repeatedly.</p> <p style="text-align: right;">DVD-V   DVD-VR   VIDEO CD   C D   DATA-CD   DATA DVD</p>
	<p><b>[A/V SYNC] (page 41)</b>  Adjusts the delay between the picture and sound.</p> <p style="text-align: right;">DVD-V   DVD-VR   VIDEO CD   DATA-CD   * DATA DVD *</p>
	<p><b>[PARENTAL CONTROL] (page 59)</b>  Sets to prohibit playback on this system.</p> <p style="text-align: right;">DVD-V   DVD-VR   VIDEO CD   C D   DATA-CD   DATA DVD</p>
	<p><b>[SETUP] (page 66)</b>  [QUICK] Setup (page 14)  Use Quick Setup to choose the desired language of the on-screen display, the aspect ratio of the TV, speaker formation, and choose yes or no to start the Auto Calibration.  [CUSTOM] Setup  In addition to the Quick Setup setting, you can adjust various other settings.  [RESET]  Returns the settings in [SETUP] to the default setting.</p> <p style="text-align: right;">DVD-V   DVD-VR   VIDEO CD   C D   DATA-CD   DATA DVD</p>
	<p><b>[ALBUM] (page 29)</b>  Selects the album to be played.</p> <p style="text-align: right;">DATA-CD   DATA DVD</p>
	<p><b>[FILE] (page 29)</b>  Selects the JPEG image file or DivX video file* to be played.</p> <p style="text-align: right;">DATA-CD   DATA DVD</p>
 **	<p><b>[DATE] (page 40)</b>  Displays the date the picture was taken by a digital camera.</p> <p style="text-align: right;">DATA-CD   DATA DVD</p>
 **	<p><b>[INTERVAL] (page 46)</b>  Specifies the duration for which the slides are displayed on the TV screen.</p> <p style="text-align: right;">DATA-CD   DATA DVD</p>
 **	<p><b>[EFFECT] (page 47)</b>  Selects the effects to be used for changing slides during a slide show.</p> <p style="text-align: right;">DATA-CD   DATA DVD</p>
 **	<p><b>[MODE (MP3, JPEG)] (page 46)</b>  Selects the data type; MP3 audio track (AUDIO), JPEG image file (IMAGE) or both (AUTO) to be played when playing a DATA CD/DATA DVD.</p> <p style="text-align: right;">DATA-CD   DATA DVD</p>

\* Except for United Kingdom and North American models.

\*\* These items are not displayed when playing a DATA CD/DATA DVD with DivX video file (except for United Kingdom and North American models).

**Tip**

- The Control Menu icon indicator lights up in green  →  when you select any item except [OFF] ([PROGRAM], [SHUFFLE], [REPEAT], and [A/V SYNC] only). The [ORIGINAL/PLAY LIST] indicator lights up in green when you select [PLAY LIST] (default setting).

# DVD Setup Display List

You can set the following items with the DVD Setup Display.

The order of the displayed items may be different from the actual display.

## LANGUAGE SETUP

- OSD\*
- MENU\*
- AUDIO\*
- SUBTITLE\*

## CUSTOM SETUP

- HDMI CONTROL — OFF
  - ON
- PAUSE MODE — AUTO
  - FRAME
- TRACK SELECTION — OFF
  - AUTO
- MULTI-DISC RESUME — ON
  - OFF
- AUDIO DRC — OFF
  - STANDARD
  - MAX
- AUDIO (HDMI) — OFF
  - ON
- DivX\*\*

## SCREEN SETUP

- TV TYPE — 16:9
  - 4:3 LETTER BOX
  - 4:3 PAN SCAN
- YC<sub>B</sub>C<sub>R</sub>/RGB (HDMI) — YC<sub>B</sub>C<sub>R</sub>
  - RGB
- SCREEN SAVER — ON
  - OFF
- BACKGROUND — JACKET PICTURE
  - GRAPHICS
  - BLUE
  - BLACK

## SPEAKER SETUP

- CONNECTION — FRONT — YES
  - CENTER — YES
    - NONE
  - SURROUND — YES
    - NONE
  - SUBWOOFER — YES
- DISTANCE (FRONT) — L — 1.0 m – 7.0 m
  - R — 1.0 m – 7.0 m
  - CENTER — 0.0 m – 7.0 m
- DISTANCE (SURROUND) — L — 0.0 m – 7.0 m
  - R — 0.0 m – 7.0 m
- LEVEL (FRONT) — L — -6.0 dB – 0.0 dB
  - R — -6.0 dB – 0.0 dB
  - CENTER — -6.0 dB – +6.0 dB
  - SUBWOOFER — -6.0 dB – +6.0 dB
- LEVEL (SURROUND) — L — -6.0 dB – +6.0 dB
  - R — -6.0 dB – +6.0 dB
- TEST TONE — OFF
  - ON

\* Select the language you want to use from the displayed language list.

\*\* Except for United Kingdom and North American models.

# System Menu List

You can set the following items with SYSTEM MENU on the remote.

## System menu

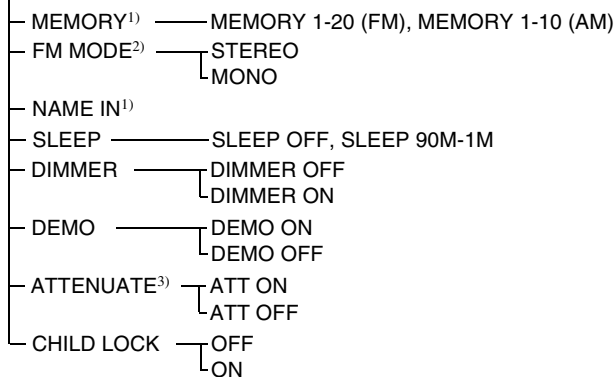

<sup>1)</sup>Appears during "TUNER FM" or "TUNER AM" only.

<sup>2)</sup>Appears during "TUNER FM" only.

<sup>3)</sup>"ATTENUATE" may not appear, depending on the selected function.

# Index

## Numerics

- 16:9 68
- 4:3 LETTER BOX 68
- 4:3 PAN SCAN 68
- 5.1 Channel Surround 36

## A

- A/V SYNC 41
- ALBUM 29
  - Album 82
- ANGLE 40
- ATTENUATE 24
- AUDIO 68
- AUDIO (HDMI) 71
- AUDIO DRC 70
- Auto Calibration 64, 82

## B

- BACKGROUND 69
- Batteries 8

## C

- CHAPTER 29
  - Chapter 82
- Child Lock 58
- COLD RESET 74
- Continuous play 22
- Control Menu Display 88
- Controlling the TV 54
- CUSTOM 66
- CUSTOM PARENTAL CONTROL 59
- CUSTOM SETUP 70

## D

- D. C. A. C. 64, 82
- DATA CD 44, 48
- DATA DVD 44, 48
- DEMO 17
- Demonstration 17
- Digital Cinema Auto Calibration 64, 82
- DIGITAL MEDIA PORT 57
- DIMMER 56
- DISPLAY 53
- DivX® 48, 71, 82
- Dolby Digital 35, 82
- Dolby Pro Logic II 82
- Dolby Surround Pro Logic 83
- DTS 35, 83
- DVD 83

- DVD+RW 83
- DVD's menu 35
- DVD-RW 37, 83
- DVI 20
- DYNAMIC BASS 55

## E

- EFFECT 47

## F

- Fast forward 28
- Fast reverse 28
- FILE 29
- File 83
- Film based software 83
- FM MODE 52
- Freeze Frame 28
- Front panel 86
- Front panel display 38, 87

## H

- Handling discs 76
- HDMI
  - YCBCr/RGB (HDMI) 69
- HDMI (high-definition multimedia interface) 20, 83
- HDMI CONTROL 70

## I

- INDEX 29
- Installing the speakers on a wall 18
- Instant Advance 23
- Instant Replay 23
- INTERVAL 46

## J

- JPEG 42, 44

## L

- Language Code List 85
- LANGUAGE SETUP 68
- LINE RGB 16
- LINE VIDEO 16
- Listening
  - a particular point on a disc 28
  - other components 23
  - TV sound 24

## M

- MENU 68
- MODE (MP3, JPEG) 46
- MOVIE/MUSIC 25
- MP3 42, 44
- MPEG audio 83
- Multi Session CD 7
- Multi-angle function 40, 83
- MULTI-DISC RESUME 70
- Multilingual function 84
- MUTING 23

## N

- Naming preset stations 52

## O

- ORIGINAL 37
- OSD 68
- Other component connection 21

## P

- PARENTAL CONTROL 60
- Parental Control 84
- PAUSE MODE 70
- PBC Playback 50
- PCM (Pulse Code Modulation) 84
- PICTURE NAVI 30, 44
- PLAY LIST 37
- Playback Control (PBC) 84
- Program Play 31

## R

- Radio 52
- Radio Stations 51
- RDS 53
- Rear Panel 86
- Region Code 7, 84
- Remote 8, 54
- Repeat Play 34
- RESET 67
- Resume Play 30

continued

## **S**

- Scan 28
- SCENE 29
- Scene 84
- SCREEN SAVER 69
- SCREEN SETUP 68
- Searching 28
- Selecting 25
- SETUP 66
- Setup Display 66, 91
- Shuffle Play 33
- SLEEP 56
- Slide Show 46
- Slow-motion Play 28
- Sound Field 26
- SPEAKER FORMATION 62
- SPEAKER SETUP 71
  - CONNECTION 71
  - DISTANCE 72
  - LEVEL 72, 73
- SUBTITLE 41, 68
- SYSTEM MENU 17, 24, 52, 56, 58
- System menu list 92

## **T**

- TEST TONE 73
- THEATRE SYNC 54
- TIME/TEXT 29
- TITLE 29
- Title 84
- TRACK 29
- Track 84
- TRACK SELECTION 70
- Troubleshooting 76
- TV connection 19
- TV TYPE 68

## **U**

- Unpacking 82
- Usable discs 6

## **V**

- VIDEO CD 84

# Remote control

## ALPHABETICAL ORDER

### A - O

ANGLE **5** (40)  
 AUDIO **4** (35)  
 CLEAR **34** (29, 54, 67)  
 D.TUNING **24** (52)  
 DISC SKIP\* **35**  
 DISPLAY **2** (38, 53)  
 DVD MENU **26** (35, 48, 54)  
 DVD TOP MENU **14** (35)  
 DYNAMIC BASS **23** (55)  
 ENTER **25** (54)  
 FUNCTION **22** (22, 23, 30, 51, 62)  
 MOVIE/MUSIC **17** (25)  
 MUTING **7** (22)  
 Number buttons\*\* **15** (29, 52, 54, 59)

### P - Z

PICTURE NAVI **6** (30, 54)  
 PRESET +/- **28** **32** (52)  
 SOUND FIELD **16** (26)  
 SUBTITLE **24** (41)  
 SYSTEM MENU **25** (17, 23, 54, 56, 92)  
 THEATRE SYNC **20** (55)  
 TUNING +/- **10** **12** (51)  
 TV **30** (54)  
 TV CH +/- **21** (54)  
 TV INPUT **18** (54)  
 TV VOL +/- **36** (54)  
 VIDEO FORMAT **3** (16)  
 VOLUME +/-\*\* **8** (22, 52, 73)

## BUTTON DESCRIPTIONS

**I/⏻** (on/standby) **1** (14, 17, 22, 30, 52)  
**TV I/⏻** (on/standby) **37** (54)  
**⏪/⏩/⏴/⏵/⊕** **13** (14, 17, 23, 29, 51, 59)  
**⏪/⏩/⏴/⏵** REPLAY/  
 ADVANCE **9** (22)  
**⏪/⏩/⏴/⏵** **32** **28** (22)  
**⏪/⏩/⏴/⏵** **12** **10** (28)  
**⏪/⏩** SLOW **12** **10** (28)  
**▷** (play)\*\* **31** (22, 30, 61)  
**⏪/⏩** STEP **9** (28)  
**■** (stop) **29** (23, 30, 59)  
**⏸** (pause) **11** (23)  
**▲** (open/close) **19** (23)  
**☰** DISPLAY **27** (15, 29, 59, 88)  
**↶** RETURN **33** (30)  
 -/-- **34** (54)

\* The DISC SKIP button is not available for this model.

\*\*The ▷, number 5, and VOLUME + buttons have tactile dots. Use the tactile dots as references when operating the system.

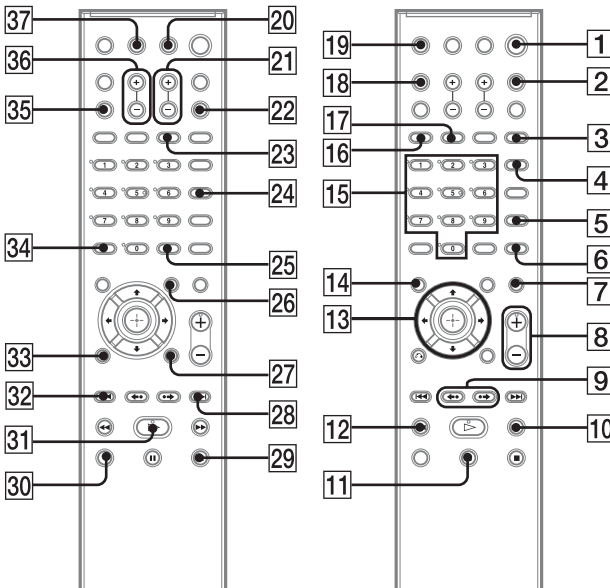



\* 3 0 9 5 0 5 9 1 2 \* (1)



## Free Manuals Download Website

<http://myh66.com>

<http://usermanuals.us>

<http://www.somanuals.com>

<http://www.4manuals.cc>

<http://www.manual-lib.com>

<http://www.404manual.com>

<http://www.luxmanual.com>

<http://aubethermostatmanual.com>

Golf course search by state

<http://golfingnear.com>

Email search by domain

<http://emailbydomain.com>

Auto manuals search

<http://auto.somanuals.com>

TV manuals search

<http://tv.somanuals.com>