

Contents

Welcome.....	9
Using Your VAIO Notebook.....	11
Using the Keyboard.....	12
Combinations and functions with the Windows key	14
Indicators	15
Indicator lights	16
Combinations and functions with the Fn key	16
Using the Touchpad	18
VAIO Action Setup.....	20
Using the Center Jog Dial Control	21
Using the center Jog Dial control	21
Launcher mode	22
Guide mode.....	23
Center Jog Dial back button.....	23
Using the center Jog Dial control with Sony software	24
Using the center Jog Dial control with other software	24
Using the Optical Disc Drive	25
To insert a disc	25
To eject a disc	26
To play a DVD.....	27
To play an audio CD.....	28
Notes on CD and DVD discs	28
To write data to a CD-RW or CD-R disc.....	29

Using PC Cards.....	30
To insert a PC Card.....	30
To remove a PC Card.....	31
Using Memory Stick Media.....	32
Types of Memory Stick media.....	32
Write-protecting Memory Stick media.....	34
Formatting Memory Stick media.....	34
Notes on using Memory Stick media.....	35
Using a Second Battery Pack.....	37
To insert a second battery pack.....	37
To charge the second battery pack.....	38
To remove the second battery pack.....	39
Using the Weight Saver.....	40
To attach the weight saver.....	40
To remove the weight saver.....	41
Using Power Saving Modes.....	42
Normal mode.....	42
Standby mode.....	42
Hibernate mode.....	42
Notes on power saving modes.....	43
Connecting a Phone Line.....	44
Connecting to a Local Area Network.....	45
Setting up your Ethernet connection.....	45
Connecting to a Wireless LAN.....	46
The Wireless LAN Access Point.....	46
Communicating with an Access Point (infrastructure).....	47
Checking your connection status.....	48
Confirming access point information.....	49
Communicating without an Access Point (peer-to-peer).....	49
Turning Off Wireless LAN.....	50
Notes on using Wireless LAN.....	50

Connecting Peripheral Devices53

Connecting an External Floppy Disk Drive	54
To connect an external floppy disk drive.....	54
To insert a floppy disk into the external floppy disk drive	55
To remove a floppy disk from the external floppy disk drive	55
To disconnect an external floppy disk drive when the notebook is on	56
To carry an external floppy disk drive.....	56
Notes on handling floppy disks	56
Connecting a Port Replicator	57
To attach the notebook to the port replicator	57
To remove your notebook from the port replicator	59
Connecting a PS/2 External Mouse or Keyboard.....	61
To connect an external mouse or keyboard	61
Connecting an Audio Device	62
To connect a CD player, active speaker, or an amplifier...	62
Connecting an Audio-Video Device	64
To change the display	67
Connecting a Parallel Port Printer	68
To connect a printer to the notebook	68
Connecting a USB Printer	69
To connect a USB printer to the notebook	69
Connecting an External Display.....	70
To connect a computer display to the notebook	70
To connect a multimedia computer display to the notebook .	71
To connect a projector to the notebook	72
To change the display when connecting an external computer display or projector	73

Connecting a Universal Serial Bus Device	74
To connect a USB device to the notebook	74
Connecting an i.LINK Device	76
To connect a digital video camera recorder	76
Notes on connecting an i.LINK device	77
Connecting with another VAIO computer	78
Connecting External Speakers	79
To connect external speakers	79
Connecting an External Microphone	80
To connect an external microphone	80
Expanding Your Notebook Capabilities	81
Personal Digital Assistant	81
Wireless LAN Access Point	81
Wireless LAN PC Card	82

Customizing Your VAIO Notebook 83

Displaying the Sony Notebook Setup Screen	84
To display the Sony Notebook Setup screen:	84
Sony Notebook Setup tabs	85
Controlling Power Management	86
Viewing the Power Management status icons	86
Power Management profiles	87
Power Management commands	89
Conserving battery power	89
Displaying Battery Information	90
Battery icon descriptions	91
Displaying detailed battery information	91
Selecting the Display Mode	93
Changing the window design of Sony software	95
Using the Multilingual User Interface Language	

Option.....	96
To Change the Language Option	96
To Change Numbers, Currency, Time, and Date Formats	97
<i>Adding Memory</i>	99
Precautions and Procedures.....	100
Typical expansion memory configuration.....	101
Models with 256 MB Memory	101
Removing a memory module	102
Installing a memory module.....	104
Viewing the amount of memory.....	105
<i>About the Software on Your Notebook .</i>	107
Software Overview.....	108
Software Support Information.....	115
Sony Service Center.....	117
<i>Using the Recovery CDs.....</i>	119
Application, Driver, and System Recovery CDs.....	120
Using Your Recovery CDs.....	121
To use the Application Recovery CD(s).....	121
To use the Driver Recovery CD(s)	122
To use the System Recovery CD(s).....	124
<i>Troubleshooting</i>	129
Troubleshooting Your Notebook	130
My notebook does not start.....	130
My notebook starts but a BIOS error appears.....	130
My notebook starts, but the message “Operating system not	

found” appears and Windows does not start.....	131
My notebook stops responding or does not shut down...	132
The power management setting is not responding.....	132
The sound of my notebook’s fan is too loud.....	133
Why does the System Properties dialog box display a slower CPU speed than advertised?.....	133
Troubleshooting the LCD Screen	134
My LCD screen is blank.	134
My LCD screen continues to show the previous screen.	134
The image on my connected external display is not centered or sized properly.....	134
I want to change the video resolution of my display.	134
I cannot switch the LCD display to TV, and vice versa.	134
Troubleshooting the Mouse and Touchpad	135
My mouse does not work.....	135
My touchpad does not work properly.	135
The pointer does not move while using the Touchpad or Mouse.....	136
Troubleshooting Drives, PC Cards, and Peripheral Devices.....	137
I cannot establish a connection between two VAIO® computers when using an i.LINK cable.....	137
My floppy disk drive (optional) cannot write to a floppy disk.	137
My optical disc drive is not playing my CD or DVD properly.....	137
My optical drive tray does not open.....	138
I cannot use Digital Video (DV) devices. The message “DV equipment seems to be disconnected or turned off” appears.	138
My PC Card is not working.	139

Troubleshooting Software	140
My software program stops responding or crashes.	140
When I click an application icon, the message “You must insert the application CD into your optical drive” appears and the software does not start.....	140
What software do I use for CD-R/CD-RW software functions?.....	140
Why is my computer operating improperly after downloading the CD-burning feature of RealJukebox® software?.....	140
I cannot use the DVgate™ software.	140
Troubleshooting the Modem	141
My modem does not work.	141
My modem connection is slow.	141
Troubleshooting Audio	142
My speakers make no sound.	142
My microphone does not work.	143
Troubleshooting the Printer.....	144
I cannot print.	144
Troubleshooting Wireless LAN	145
The computer cannot connect to a Wireless LAN Access Point.	145
I cannot access the Internet.	145
The data transfer speed is slow.	146
The communication speed is interrupted or slowed down when MPEG2 data is transferred.	146
Data transfers are interrupted.....	146

Getting Help	149
Support Options.....	149

Index..... 151

Welcome

Congratulations on your purchase of this Sony VAIO® computer, and welcome to computer the online VAIO® Computer User Guide. This user guide provides detailed information on all aspects of using your new VAIO computer, from keyboard functions to preinstalled software applications.

In the left navigation window, click the topics you want to learn more about, and that information will be displayed in this main window.

 Click here to find the latest updates and supplemental information about your computer.

Click here to view your computer's hardware specifications and software information.

Using Your VAIO Notebook

This section describes the following aspects of your new computer:

- Using the Keyboard
- Using the Touchpad
- Using the Center Jog Dial Control
- Using the Optical Disc Drive
- Using PC Cards
- Using Memory Stick Media
- Using a Second Battery Pack
- Using the Weight Saver
- Using Power Saving Modes
- Connecting a Phone Line
- Connecting to a Local Area Network
- Connecting to a Wireless LAN

Change text in this variable definition to document title.

Using the Keyboard

Your notebook keyboard is very similar to that of a typewriter, but the keyboard has additional keys that perform specific computer-related tasks.

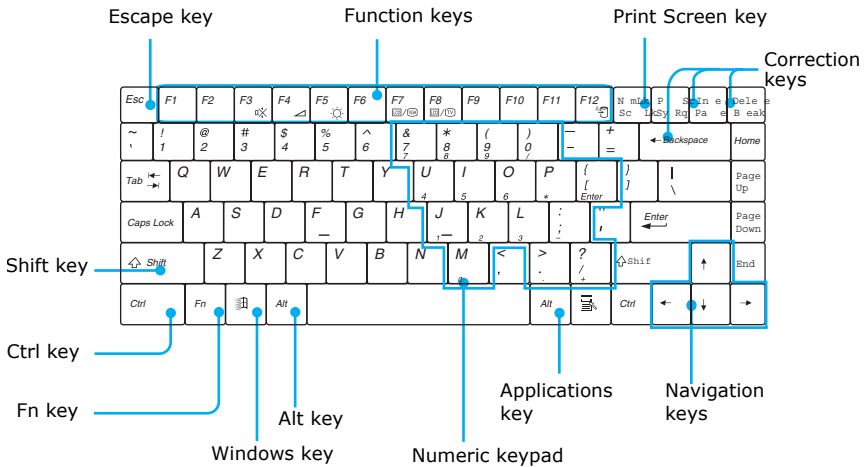

Keyboard



Key











Description

-
- | | |
|-----------------|--|
| Numeric keypad | Contains the keys found on a typical calculator. Use the numeric keypad area to type numbers or to perform mathematical calculations such as addition and subtraction. Note that you must press the Num Lock key to activate the numeric keypad. (When you do so, the Num Lock light will be on.) Press the Num Lock key again to deactivate it. |
| <hr/> | |
| Navigation keys | The Left/Right/Up/Down arrow keys are devoted to move the cursor on the screen, and also function as the Home, End, Page Up, and Page Down keys, respectively. |
| <hr/> | |
| Correction keys | The Insert, Back Space, and Delete keys enable you to make corrections in your documents. |
-





Key	Description
Function keys	The 12 function keys along the top of the keyboard are used to perform designated tasks. For example, in many applications, F1 is the Help key. The task associated with each function key may vary from one application to the next.
Escape key	The Esc (Escape) key is used to cancel commands.
Print Screen key	The Print Screen key takes an electronic snapshot of the screen and places it in the Windows® Clipboard. You can then paste the screen shot into a document and print it.
Operator keys (Shift, Ctrl, Alt keys)	Several keys are always used with at least one other key: Ctrl, Alt, and Shift. When held down with another key, the Ctrl (Control) and Alt (Alternate) keys offer another way to give commands. For example, in many applications, instead of choosing the Save command from a menu, you can hold down Ctrl and press S (referred to as Ctrl+S). The Shift key operates the same way as on a typewriter; it is used to produce capital letters or special symbols such as @ and \$.
Windows key 	The key with the Windows logo displays the Windows Start menu; it is the equivalent of clicking the Start button on the taskbar. See “Combinations and functions with the Windows key” for more information.
Fn key	The Fn key is used in combination with other keys to issue commands. See “Combinations and functions with the Fn key” for more information.
Applications key 	The Applications key displays a shortcut menu of context-sensitive choices. Pressing this key is the equivalent of clicking the right mouse button.

Change text in this variable definition to document title.

Combinations and functions with the Windows key



Combination	Function
 + F1	Displays VAIO® Help and Support Center.
 + Tab	Switches the selected button on the taskbar.
 + D	Displays the desktop.
 + E	Displays Windows Explorer.
 + F	Displays the Search window to find a file or folder. This is the equivalent of selecting Search from the Start menu.
 + Ctrl + F	Displays the Search Results: Computers window where you can locate other computers. This is the equivalent of selecting Search and then Computers from the Start menu.
 + M	Minimizes all displayed windows.
Shift +  + M	Returns all minimized windows to their previous size.
 + R	Displays the Run window. This is the equivalent of selecting Run from the Start menu.
Fn +  + Insert	Displays the Properties window. This is the equivalent of selecting Control Panel and then System from the Start menu.

Indicators

Indicator	Function
Power 	Light is green when the power to the notebook is turned on, flashes amber in Standby mode, and turns off when the notebook is in Hibernate mode or powered off.
Battery 1 1 	Indicates the status of the battery inserted in the battery bay on the right side of the notebook.
Battery 2  2	Indicates the status of the battery inserted in the multipurpose drive bay on the left side of the notebook.
Memory Stick 	Indicates that the Memory Stick® slot is in use.
Hard disk 	This indicator will light when data is being read from or written to the hard disk. Do not enter Standby mode or turn off the notebook when this indicator is on.

Change text in this variable definition to document title.

Indicator lights











Light	On	Off
 Num Lock	The number keys in the numeric keypad are active.	The alphanumeric character keys in the keypad area are active.
 Caps Lock	The letters appear in uppercase as you type. The Shift key lowers the case of typed letters when Caps Lock is on.	Letters appear in lower case as you type (unless you hold down the Shift key).
 Scroll Lock	The screen scrolls differently. (Exactly how it scrolls depends on the specific application. It has no effect in many applications.)	Information moves across the display normally.

Combinations and functions with the Fn key



 If you switch user identities during a computing session, the Fn+F7 and Fn+F8 key functionality (if available on your computer) will be interrupted. To switch to an external display or monitor, see “Selecting the Display Mode” for more information.

Combinations/ Feature

Function

Fn+  (F3) Mute On/Off	Toggles the built-in speaker off and on.
Fn+  (F4) Speaker volume	Adjusts the built-in speaker volume. To increase volume, press Fn+F4, then  or  . To decrease volume, press Fn+F4, then  or  .
Fn+  (F5) Brightness control	Adjusts the brightness of the LCD. To increase light intensity, press Fn+F5 and then  or  . To decrease light intensity, press Fn+F5 and then  or  .



**Combinations/
Feature****Function**

Fn+  / 
(F7)
Switch to the
external
monitor/LCD

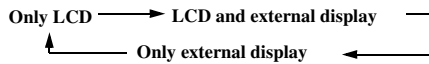
Toggles through the LCD, external display (connected to the Monitor connector) and both LCD and external display.



Connect the cable before you turn on the notebook, otherwise Fn + F7 will not work.

Fn+  only/
 (F8)
Control AV out

Toggles between LCD-only and dual LCD/TV display modes.

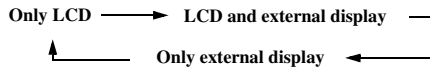

Connect the cable before you turn on the notebook, otherwise Fn + F8 will not work. You cannot use the Fn + F8 function to switch between LCD and TV once a DVD is inserted into the optical drive.

Fn+  (F12)
Hibernate

Provides for the lowest level of power consumption. When you run this command, the state of the system and state of the peripheral devices are written to the hard disk and the system power is turned off. To return the system to its original state, use the power button to turn on power.

Fn+Esc
Standby

Puts the system into Standby mode, a power management state. To return the system to the active state, press any key.

 You can also carry out these functions using the center Jog Dial™ control. Some functions are not available until Windows® launches.

Using the Touchpad

The keyboard contains a cursor-pointing device called a touchpad. You can point to, select, drag, and scroll objects on the screen using the built-in touchpad.

Touchpad

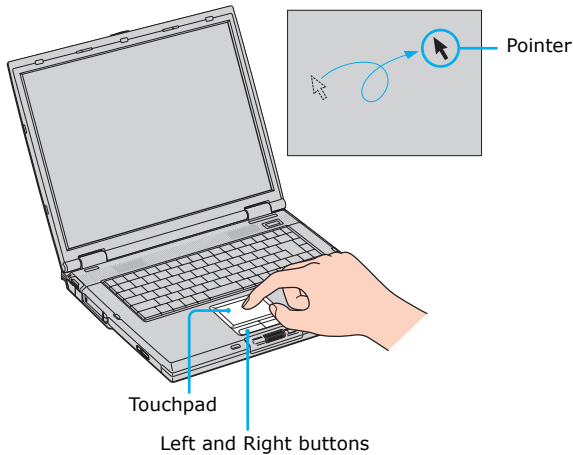

Action	Description
Point	Slide one finger on the touchpad to place the pointer on an item or object.
Click	Press the left button once.
Double-click	Press the left button twice.



Action	Description
Right-click	Press the right button once. In many applications, this action displays a shortcut menu of context-sensitive choices.
Drag	Slide one finger while pressing the left button.
Scroll	Move your finger along the right edge of the touchpad to scroll vertically. Move your finger along the bottom to scroll horizontally. (The scroll function is available only with applications that support a touchpad scroll feature.)

The Mouse Properties dialog box lets you customize your mouse and touchpad features, such as touch sensitivity, motion, and buttons.

To open the Mouse Properties dialog box

- 1 Click Start on the Windows® taskbar, and then Control Panel.
- 2 Click Printers and Other Hardware, and then Mouse. The Mouse Properties dialog box opens.

VAIO Action Setup

VAIO Action Setup manages the settings for your notebook's center Jog Dial™ control, Memory Stick® media, and i.LINK®* interface. An overview of some of the functions controlled by VAIO Action Setup is provided in this section. For more information on changing the settings using VAIO Action Setup, right-click the Jog Dial Utility icon  or  in the taskbar and click Help Topics.

* i.LINK is a trademark of Sony used to designate that a product contains an IEEE 1394 connection. The i.LINK connection may vary, depending on the software applications, operating system, and compatible i.LINK devices. All products with an i.LINK connector may not communicate with each other. Refer to the documentation that came with your compatible i.LINK device for information on operating conditions and proper connection. Before connecting compatible i.LINK PC peripherals to your system, such as a CD-RW or hard disk drive, confirm their operating system compatibility and required operating conditions.

Using the Center Jog Dial Control

Your notebook is equipped with a center Jog Dial control located below the left and right buttons. The center Jog Dial control enables you to open an application, folder, or document from a predefined list by rotating and pressing the center Jog Dial control. In addition, when you press the center Jog Dial control, you can turn on your notebook automatically and start the selected application or document.

Center Jog Dial Control

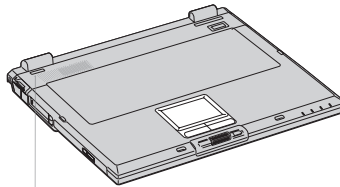

The center Jog Dial control window always appears in the display. It is either in the launcher mode or in the guide mode.

Using the center Jog Dial control

This section explains how to use the center Jog Dial control. For information on how to change the settings of the center Jog Dial control, right-click the Jog Dial Utility icon or in the taskbar and click Help Topics.

Change text in this variable definition to document title.

Launcher mode

The center Jog Dial control window is in launcher mode until a software application is launched or the Jog Dial control window becomes active. When you select an item in the Jog Dial control window and it is displayed between orange bars, you can press the center Jog Dial control to view a submenu of that item.

Using Launcher mode

To use the center Jog Dial control, click the Jog Dial control window or the Jog Dial Utility icon in the taskbar. Alternatively, you can press the Ctrl key and the center Jog Dial control while the Jog Dial control window is active to switch to launcher mode.

Jog Dial Launcher

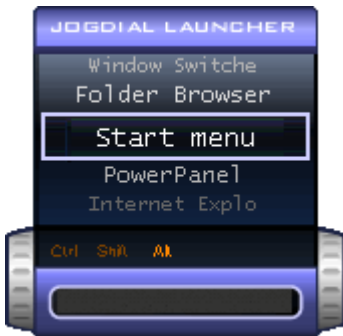

To select a desired item, proceed as follows:

- 1 Rotate the center Jog Dial control to select the item you want, and then press the center Jog Dial control. The Jog Dial Launcher window switches to guide mode and shows the function of the center Jog Dial control.

Jog Dial Guide



- 2 Rotate or press the center Jog Dial control to use the desired function.
- 3 To select another item, repeat steps 1 through 3 above.

Guide mode

The Jog Dial control window is in the guide mode when software is in use and the software window is active. Depending on the software you are using, you can select items from the displayed list using the center Jog Dial control. You can switch between guide mode and launcher mode by pressing the Ctrl key and the center Jog Dial control.

Using Guide mode

The Jog Dial control window displays the function of the center Jog Dial control.

Center Jog Dial back button

The center Jog Dial control includes a back button located to the right of the control. Pressing this button brings you back to the previous screen.

Change text in this variable definition to document title.

Using the center Jog Dial control with Sony software

If Sony software that supports the center Jog Dial control is active, you can use the functions of the center Jog Dial control that are allocated to that software. For more information on functions allocated to software, see the software application's Help.

Using the center Jog Dial control with other software

If the software you are using supports the center Jog Dial control, you can still use the center Jog Dial control to scroll the window or adjust the window size.

Using a Dialog box

When a window such as Screen Properties is active, the Dialog box is displayed in the Jog Dial window. You can select an item in the window by rotating the center Jog Dial control. Pressing the center Jog Dial control is the equivalent of pressing Enter or Select.

Jog Dial Guide Dialog Box





Manual Eject Hole

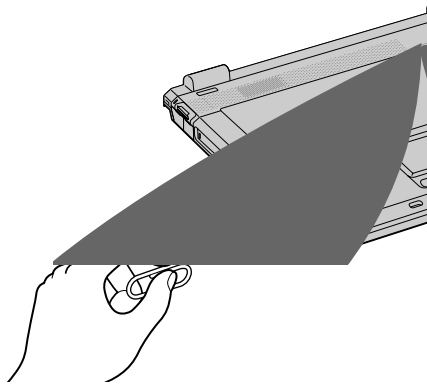

To play a DVD

To play a DVD, you may use the optical disc drive and the preinstalled WinDVD® application. For more information, see the Help menu in the WinDVD application.

 Before you use the optical disc drive to play a DVD, quit any open applications.

Your optical drive can read most DVD-R media. When you are ready to play a DVD, read the suggestions below to maximize your video viewing experience.

- ❑ When playing a DVD on battery power, set the power management profile to DVD. You can also set the power management profile to Automatic Profile Selection if the display is not clear when using other profiles.

 Automatic Profile Selection sets the power management profile to DVD whenever a DVD is inserted. See “Controlling Power Management” for more information.

- ❑ If you connect your notebook to a TV display, you may need to adjust the display resolution. Read the suggestions below to set the display resolution to the proper dimensions. Also see “Selecting the Display Mode” for more information.
- ❑ If the notebook is set to the default display setting, part of the video screen will not appear. To view the entire screen, adjust the display resolution to 640 x 480.



Some discs recorded at 20 or 24 bits may produce noise while playing. If you have audio devices connected, this may cause damage to your hearing and the speakers. Reduce the volume before playing a DVD.

You cannot use the Fn + F8 function to switch between LCD and TV once a DVD is inserted into the optical drive.

Do not switch between LCD and the external display while the DVD is playing. This may cause a malfunction, and you may need to restart the DVD software.

Do not switch the power saving modes while you are playing the DVD.

Change the settings to disable the screen saver and the virus checker.

Do not use memory-resident utility software to speed up disc access. This may cause the notebook to malfunction.

To play an audio CD

To play an audio CD, make sure the audio function is turned on. To do this, complete the following procedure.

 The optical disc drive must be installed before you begin.

- 1 Open the Start menu, point to Control Panel, Performance and Maintenance, and then click System. The System Properties window appears.
- 2 Select the Hardware tab and then click Device Manager in the Device Manager box. A window appears, listing your notebook hardware devices.
- 3 Double-click DVD/CD-ROM drives. From the drop-down list, double-click the drive name. A properties window appears.
- 4 Click the Properties tab.
- 5 Select the “Enable digital CD audio for this CD-ROM device” check box if it is not already selected and then click OK.

Notes on CD and DVD discs

- Do not drop or bend the disc.
- Do not touch the surface of the disc. Fingerprints and dust on the surface of a disc may cause reading errors. Proper care of the disc is essential to maintain its reliability. Do not use solvents such as benzine, thinner, commercially available cleaners or anti-static spray, as they may cause damage to the disc.

- ❑ For normal cleaning, hold the disc by its edge and use a soft cloth to wipe the surface from the center out.
- ❑ If the disc is badly soiled, moisten a soft cloth with water, wring it out well, and use it to wipe the surface of the disc from the center out. Wipe off any remaining moisture with a dry, soft cloth.

To write data to a CD-RW or CD-R disc*

You can use Sony SonicStage and Microsoft® Windows® XP to write data to a CD-R or CD-RW disc. To create a CD-R disc that is readable in a CD-ROM drive, make sure that you finish the writing process before ejecting the disc. For more information, see the instructions included with Windows® XP.



Do not strike or shake the notebook while writing data to a disc.

Always use the AC adapter as the power source for your notebook if you are writing data to a CD-RW or CD-R disc. Using battery power may result in data transfer failure.

Notes on writing data to a CD-RW or CD-R disc

- ❑ For optimal writing speed, deactivate the screen saver and exit anti-virus software before writing data to a disc.
- ❑ For best results, use CD-Rs that are compatible with 8x speed.
- ❑ Your notebook does not support 1x writing speed.
- ❑ Memory-resident disc utilities may cause unstable operation or data loss. Deactivate these utilities before writing data to a disc.
- ❑ If your notebook computer has preinstalled Microsoft® Office applications, such as Excel, Word, and Outlook, turn off the FindFast application.

* For notebook models equipped with a CD-RW/DVD Combo Drive.



Do not force a PC Card into the slot as this may damage the connector pins.

Do not carry your notebook while touching the head of a PC Card (such as a wireless LAN card), as pressure or shock may damage the connector pins.

To remove a PC Card

If your notebook is turned on, follow these instructions. If your notebook is turned off, skip to step number 5.

- 1 Close all applications that use the PC Card; otherwise, data may be lost.
- 2 Double-click the green arrow  icon in the taskbar.
- 3 Select an option in the Hardware devices box, and click Stop. The Stop a Hardware device window opens.
- 4 Click OK to confirm your selection, and then Close.
- 5 Press the PC Card Release button. The Release button pops out.
- 6 Press the PC Card Release button a second time (in some cases). Remove the card.

Notes on using PC Cards



- For some PC Cards, if you alternate between normal power operation and the Standby or Hibernate power management modes while the card is inserted, you may find that a device connected to your system is not recognized. Restart your system to correct the problem.
- Some PC Cards may require that you disable idle devices when using the PC Card. You can use Sony Notebook Setup to disable devices. See “Displaying the Sony Notebook Setup Screen” for more information.
- Be sure to use the most recent software driver provided by the PC Card manufacturer.
- If an exclamation mark (!) appears on the Device Manager tab in the System Properties dialog box, remove the software driver and then reinstall it.
- You may not be able to use some PC Cards or some functions of the PC Card with this notebook. If you have difficulty inserting a card, check that you are orienting the card correctly. See the manual that came with your PC Card for more information on its use.

Using Memory Stick Media

This compact, portable, and versatile recording medium has a data capacity exceeding that of a floppy disk. The medium is specially designed for exchanging and sharing digital data with compatible products. Because it is removable, the media can be used for external data storage.

Types of Memory Stick media

The following two types of Memory Stick media can be used with your notebook:

- MagicGate™*  Memory Stick media (hereafter called MG Memory Stick media), which is provided with copyright protection
- Memory Stick†  media, which does not have the same copyright protection as MagicGate Memory Stick media

Some music files with secure copyright protection may be stored on MG Memory Stick media but not on regular Memory Stick media. You can also use MagicGate media-compatible devices to record and playback music when they are connected to your notebook.

You can store mixed data on the Memory Stick media. For example, you can copy an ordinary file onto a MG Memory Stick media that already contains music files.

What is MagicGate Memory Stick media?

MagicGate Memory Stick media provides copyright protection that consists of authentication and encryption technology. Authentication technology ensures that protected content is only transferred between compliant devices and media. Protected content is recorded and transferred in an encrypted format to prevent unauthorized duplication or playback.

 MG Memory Stick media has the MG mark .

* MagicGate Memory Stick and  are trademarks of Sony Corporation.

† Memory Stick and  are trademarks of Sony Corporation.

To insert Memory Stick media

- 1 Insert the Memory Stick media with the arrow facing up and toward the Memory Stick media slot.

 Inserting the media in the wrong direction may damage the connector pins.

- 2 Carefully slide the Memory Stick media into the slot until it clicks in place.

Inserting Memory Stick Media

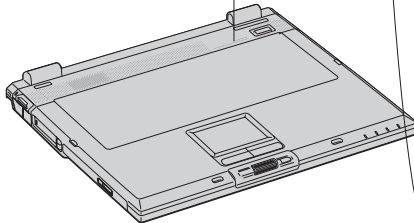

 At the default setting, the Visual Flow application starts automatically when you insert a Memory Stick media. You can change this setting in VAIO Action Setup.

To view the contents of Memory Stick media

- 1 Click Start in the Windows taskbar and then click My Computer
- 2 Double-click Sony Memory Stick under the Devices with Removable Storage box. The Sony Memory Stick window opens.

To remove Memory Stick media

- 1 Make sure the Memory Stick media indicator light on the right of the notebook is off.
- 2 Push the Memory Stick media in toward the notebook.
- 3 When the Memory Stick media ejects, pull it out.

Change text in this variable definition to document title.

 Be careful when removing the Memory Stick media, as it may eject completely from the slot.

Write-protecting Memory Stick media

Memory Stick media is designed with a write-protect tab to protect valuable data from accidental erasure or overwriting. Move the tab to the right or left to set or release write-protection.

Write-protect off Data can be saved on the Memory Stick media.

Write-protect on Data can be read from but not saved on the Memory Stick media.

Using the Write-protect Tab

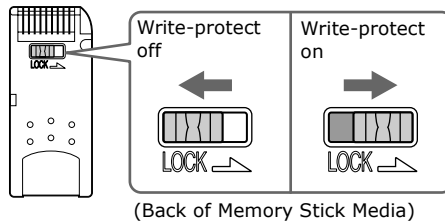

Formatting Memory Stick media

Memory Stick media is formatted for immediate use when you purchase it. If you need to reformat Memory Stick media, follow the procedures below.



Reformatting erases all current data that is stored on Memory Stick media. Before you reformat, confirm that the media does not contain files you want to keep.

- 1 Insert the Memory Stick media into the notebook. See “To insert Memory Stick media” for more information.
- 2 Click Start in the Windows taskbar, and click My Computer.

- 3 Under Devices with Removable Storage, right-click Sony Memory Stick - MG, and select Format. The Format Sony Memory Stick - MG dialog box appears.
- 4 Select the appropriate options, and click Start.

Notes on using Memory Stick media

- When the write-protect tab of the Memory Stick media is set to LOCK, data cannot be recorded or erased.
- Before using Memory Stick media, back up important data.
- Wait a minimum of 10 seconds after the Memory Stick media finishes reading or writing data before removing the media.
- If the media is removed prematurely, a blue screen with an error message appears, prompting you to continue or exit. Reinsert the media into the slot and press Enter to continue. This enables the media to finish reading or writing data.
- You can view video clips that you have recorded with Memory Stick media-compatible video camera recorders.
- The media slot can accommodate one Memory Stick media at a time.
- You may copy images from a digital video camera using Memory Stick media.
- Only MagicGate Memory Stick media can be used with copyright protected data such as music.
- Copyright protected music cannot be checked-out to any Memory Stick media other than MG Memory Stick media.
- Recorded music is limited to private use only. Using recorded music for any other purpose requires permission of the copyright holders.
- Sony is not responsible for music files that cannot be recorded from a CD or downloaded from other sources.
- Formatting Memory Stick media erases all data (including music data) previously saved to it. Before you format Memory Stick media, confirm that the media does not contain files you want to keep.
- Do not use the media in locations that are subject to static electricity or electrical noise.
- Do not touch the media connector with your finger or metallic objects.

Change text in this variable definition to document title.

- ❑ Do not attach labels other than the supplied label to a media.
- ❑ Do not bend, drop, or apply strong shock to the media.
- ❑ Do not disassemble or modify the media.
- ❑ Do not allow the media to get wet.
- ❑ Do not use or store the media in a location that is subject to:
 - ❑ Extremely high temperatures, such as in a car parked in the sun
 - ❑ Direct sunlight
 - ❑ High humidity or places with corrosive substances
- ❑ To prolong the life of the media, use the supplied storage case. See the instructions that came with your media for more information on its use.

ack

attery pack. With two battery packs, notebook with battery power. When you insert first charges first. The battery when the first battery pack is 85 percent charging by observing the battery

bay, remove that device.

pose bay.

2 indicator turns on.

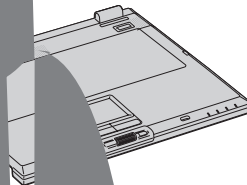

ok size the battery pack. See
fo

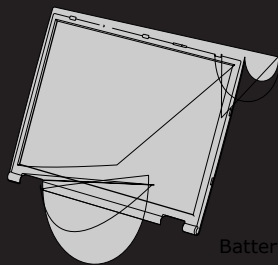

Battery indicators



To remove the second battery pack

If you attach two battery packs, you can remove either of them without shutting down the notebook. When removing one battery pack, make sure that the other battery pack's indicator is on. If the indicator of the battery pack you are removing is on, right-click the battery icon on the taskbar and click the "Switch discharge battery" option.

- 1 To remove the battery pack, first slide the multipurpose bay Release switch in the direction of the arrow to unlock the weight saver.

Multipurpose Bay Release Switch

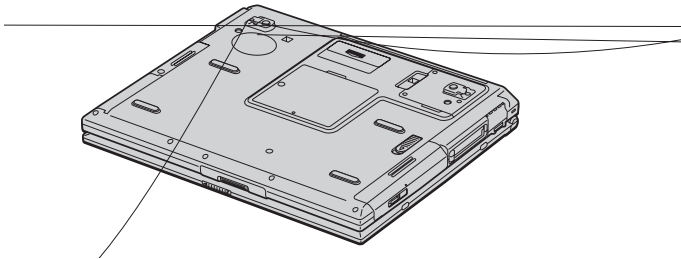

- 2 Remove the weight saver, and then pull out the battery pack.
- 3 Reinsert the weight saver. See "Using the Weight Saver" for more information.

Change text in this variable definition to document title.

Using the Weight Saver

The weight saver protects the multipurpose bay when it is empty, and secures the secondary battery when it is installed in the multipurpose bay.

To attach the weight saver

- 1** If another device, such as a battery pack, is in the multipurpose bay, remove that device. See “To remove the second battery pack” for more information.
- 2** Slide the weight saver in the direction of the arrow until it clicks into place.

Inserting the Weight Saver

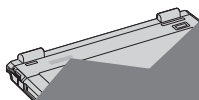

To remove the weight saver

- 1 To remove the weight saver, first slide the multipurpose bay Release switch in the direction of the arrow.

Multipurpose Bay Release Switch

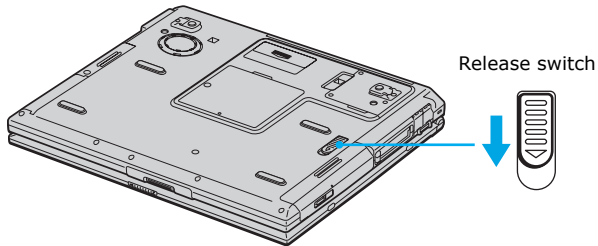

- 2 Remove the weight saver.

Using Power Saving Modes

When you use a battery as the source of power for your notebook, you can take advantage of power management settings to conserve battery life. In addition to the normal operating mode, which allows you to turn off specific devices, your notebook has two distinct power saving modes: Standby and Hibernate. When using battery power, be aware that the notebook automatically enters Hibernate mode when the remaining battery charge drops below 5 percent, regardless of the power management setting you select.

 If the battery level falls below 10 percent, you should either attach the AC adapter to recharge the battery or shut down your notebook and insert a fully charged battery.

Normal mode

Normal mode is the normal state of your notebook when it is in use. The power indicator displays green when your notebook is in this mode. To save power, you can turn off a specific device such as the LCD or the hard disk drive.

Standby mode

In Standby Mode the notebook saves the current state of the system in RAM and switches off power to the CPU. The amber power indicator flashes in this mode.

To activate Standby mode

Press the key combination Fn + Esc.

To return to Normal mode

Press any key to return to Normal mode.

Hibernate mode

In the Hibernate mode, the state of the system is saved on the hard disk drive and power is turned off. The power indicator is off in this mode.

To activate Hibernate mode

- 1 Press the key combination Fn + F12, or press the power button and release it immediately. The “Save to Disk Manager” window appears and the notebook enters Hibernate mode.

 Do not move the notebook until its power indicator turns off.

Pressing the power button and releasing it immediately caused prior notebook systems to enter Standby mode.

- 2 Press the power button to return to normal mode.

Notes on power saving modes

- When returning from Hibernate mode, the system status stored on the hard disk is erased and the notebook starts normally if you press the power button and hold it for more than four (4) seconds.
- Standby uses more power than Hibernate.
- Standby requires less time than Hibernate to return to normal mode.

Connecting a Phone Line

You need to connect a phone line to take advantage of online services and the Internet.

 In order to register your Sony VAIO notebook, register your software online, and use Sony Customer Support, you must connect to a phone line.

- 1 Plug one end of the phone cable into the modem jack on the notebook.

Connecting Phone Cable

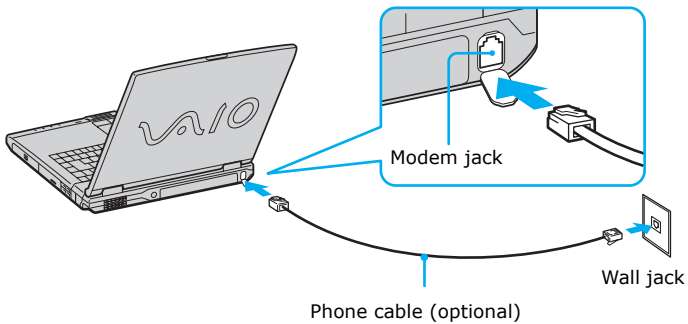

- 2 Plug the other end of the phone cable into the wall jack.

 Your notebook does not work with party lines, cannot be connected to a coin-operated telephone, and may not work with multiple phone lines or a private branch exchange (PBX). Some of these connections may result in excess electrical current and could cause a malfunction in the internal modem.

If you connect a phone line coming through a splitter, the modem or connected device may not work properly.

Connecting to a Local Area Network

You can connect your notebook to 10BASE-T and 100BASE-TX-type Local Area Networks (LANs). For the detailed settings and devices needed to connect to the network, ask your network administrator.

Connecting to LAN

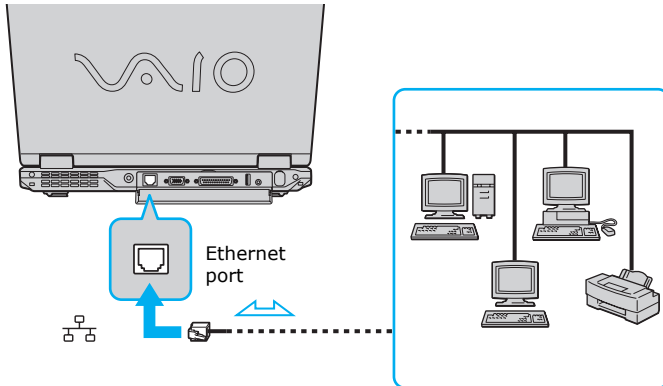

Warning: Only connect 10BASE-T and 100BASE-TX cables to the  Ethernet port. Do not connect any other type of network cable or phone cable. Connecting cables other than those listed above may result in an electric current overload and could cause a malfunction, excessive heat, or fire in the port. To connect the unit to the network, contact your network administrator.

Setting up your Ethernet connection

To connect to the network

- 1 Click Start on the Windows® taskbar, and select My Computer.
- 2 In the Other Places box on the left, click My Network Places.
- 3 In the Network Tasks box, click Add a network place or click Set up a home or small office network, depending on your configuration. Depending on your choice, either the Add Network Place Wizard or Network Setup Wizard window appears.
- 4 Follow the on-screen instructions.

Connecting to a Wireless LAN

Your computer may come with a wireless Local Area Network (LAN) PC Card* that allows for wireless connections. With Sony's Wireless LAN functionality, all compatible digital devices can communicate freely without cable connections. A Wireless LAN is a network in which a mobile user can connect to a LAN through a wireless (radio) connection. You can opt to purchase a Wireless LAN Access Point to set up a LAN.

 See "Using PC Cards" for information on using the Wireless LAN PC Card.

Communicating via Wireless LAN

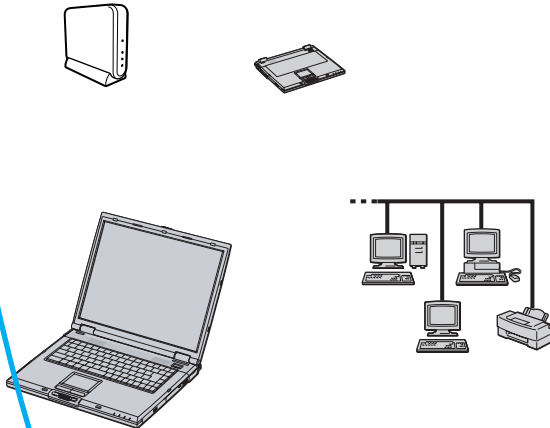

The Wireless LAN Access Point

The Wireless LAN Access Point, which is also called the access point, is designed for building a Wireless LAN environment. If you purchase an access point, you can easily build a wireless LAN environment by plugging the Access point into an AC power outlet and using the provided software with compatible devices. Because a wireless LAN configuration requires no wiring, you can operate multiple computers more freely than ever before.

* Supplied with selected models.

Connecting to a wireless LAN

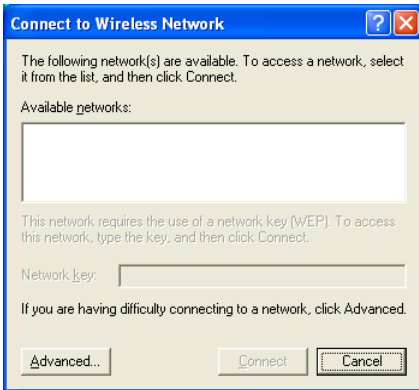

- 5 Select an access point from the Available Networks list box, and enter a network key in the appropriate box.

 The network key is data used to protect signals passing through a wireless LAN that conforms with IEEE802.11b standard. It is also called an “encryption key.” Wireless LAN communication can only occur between an access point and computer that are using the same key information. When you enter the network key and the connection is made, the access point is registered, and you do not have to enter the network key when you connect thereafter.

Checking your connection status

To confirm your connection status with an access point

- 1 Click Start on the Windows taskbar, and then Control Panel.
- 2 Click Network and Internet Connections, and then Network Connections.
- 3 Double-click Wireless Network Connection Enabled. The Wireless Network Connection Status window opens.

Confirming access point information

To check access point information

- 1 Click Start on the Windows taskbar, and then Control Panel.
- 2 Click Network and Internet Connections, and then Network Connections.
- 3 Double-click Wireless Network Connection Enabled. The Wireless Network Connection Status window appears with the General tab open.
- 4 Click Properties. The Wireless Network Connection Properties window opens.
- 5 Select any tab to view access point information.

Communicating without an Access Point (peer-to-peer)

A peer-to-peer network is one in which a local network is created only by the wireless devices themselves, with no other central controller or access point. Each device communicates directly with other devices in the network. You can set up a peer-to-peer network easily at home.

To communicate without an access point:

- 1 Turn on the notebook, and insert the wireless LAN PC Card into the PC Card slot on the left panel of the computer.
- 2 Click Start on the Windows taskbar, and then Control Panel.
- 3 Click Network and Internet Connections, and then Network Connections.
- 4 Right-click the Wireless Network Connection icon and select Properties.
- 5 Select the Wireless Networks tab, and click Add. The Wireless Network Properties dialog box appears.
- 6 Type a six-digit name in the Network name (SSID) box.
- 7 Click the Data encryption (WEP enabled) check box to select it.
- 8 Click the Network Authentication (Shared mode) check box to select it.
- 9 Click the “The key is provided for me automatically” check box to deselect it. Some information boxes become visible.

Change text in this variable definition to document title.

- 10 Type a five-digit name in the Network key box.
- 11 Click OK. Your new Network name appears in the Preferred networks window.
- 12 Click Advanced. The Advanced dialog box opens.
- 13 Select the Computer-to-computer (ad hoc) networks only option.
- 14 Click Close.
- 15 Click OK.

Turning Off Wireless LAN

When you are not using the Wireless LAN network, disconnect the PC Card when the notebook is turned Off. Press the PC Card slot eject button, and hold both sides of the card to pull it out of the slot.



Removing the PC Card when the notebook is turned On can damage the system if done incorrectly.

To remove the wireless LAN PC Card when the notebook is turned on

- 1 Double-click X located near the bottom right of the notebook.
- 2 Select ORiNOCO Wireless LAN PC Card from the list.
- 3 Click Stop.
- 4 Confirm the device when the confirm screen is displayed.
- 5 Click OK.
- 6 When "...is safe to remove" is displayed in the notification area, press the PC Card slot eject button.
- 7 Hold both sides of the card to pull it out of the slot.

Notes on using Wireless LAN

- Sony Wireless LAN devices support the IEEE 802.11b standard. Devices connecting to a Wireless LAN using the IEEE 802.11a standard cannot connect to devices using the IEEE 802.11b standard.

- ❑ Wireless LAN communication occurs on divided frequency bands known as channels. Third-party Wireless LAN Access Point channels may be preset to different channels from Sony devices.
- ❑ If using a Wireless LAN Access Point, refer to connectivity information contained in those instructions.

Change text in this variable definition to document title.

Connecting Peripheral Devices

You can add functionality to your notebook by connecting a variety of peripherals, as discussed in the following sections:

- Connecting an External Floppy Disk Drive
- Connecting a Port Replicator
- Connecting a PS/2 External Mouse or Keyboard
- Connecting an Audio Device
- Connecting an Audio-Video Device
- Connecting a Parallel Port Printer
- Connecting a USB Printer
- Connecting an External Display
- Connecting a Universal Serial Bus Device
- Connecting an i.LINK Device
- Connecting with another VAIO computer
- Connecting External Speakers
- Connecting an External Microphone
- Expanding Your Notebook Capabilities

Connecting an External Floppy Disk Drive

You can connect a Sony USB floppy disk drive (not supplied) to a Ψ USB port on your notebook. Your notebook has three USB ports: one located on the left panel, one located on the right panel, and one located on the rear panel.

To connect an external floppy disk drive

 You do not need to shut down your notebook before connecting or disconnecting a floppy disk drive.

Plug the USB connector into the Ψ USB port. The VAIO logo on the USB floppy disk drive should be facing upward.

Connecting an External Floppy Disk Drive

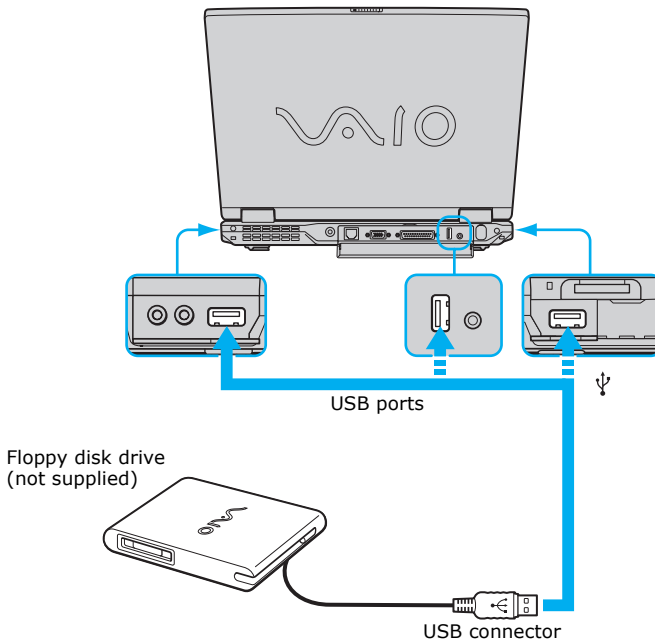

To insert a floppy disk into the external floppy disk drive

- 1 Hold the floppy disk with the label side facing upward.
- 2 Gently push the floppy disk into the drive until it clicks into place.

Inserting a Floppy Disk

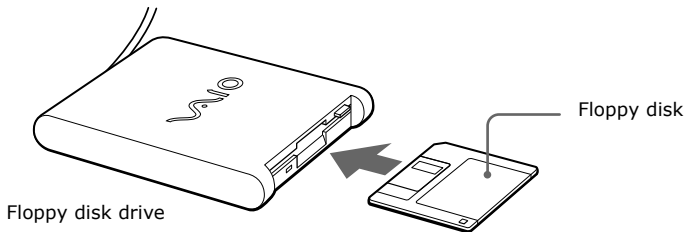

To remove a floppy disk from the external floppy disk drive

- 1 Close all applications that were opened from the disk and wait for the LED indicator to turn off.
- 2 Push the Eject button, and remove the disk.

Removing a Floppy Disk

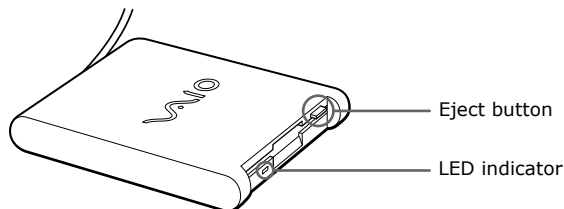

Change text in this variable definition to document title.

To disconnect an external floppy disk drive when the notebook is on

- 1 Double-click  in the taskbar. The “Safely remove ...” dialog box opens.
- 2 Select Y-E Data USB Floppy, and click OK in the “Stop a Hardware device” dialog box. When the message, “Safe to Remove Hardware” appears, click Close.
- 3 Unplug the external floppy disk drive from the notebook.

To carry an external floppy disk drive

Fold the floppy disk drive cable and connector into the side compartment on the floppy disk drive.

Carrying an External Floppy Disk Drive



Notes on handling floppy disks

- Do not open the shutter manually and touch the surface of the floppy disk.
- Keep floppy disks away from magnets.
- Keep floppy disks away from direct sunlight and other heat sources.

Connecting a Port Replicator

Your notebook supports the use of a port replicator (not supplied). Attaching a port replicator enables you to connect additional peripherals to your notebook.

Port Replicator (Rear Panel)

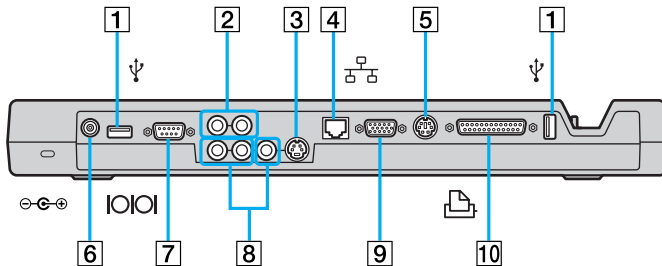

1	USB ports	6	DC In port
2	LINE IN jacks	7	Serial port
3	S Video Out jack	8	LINE OUT jacks and Composite Video Out jack
4	Network port (Ethernet 10BASE-T/100BASE-TX port)	9	VGA (Monitor) port
5	Mouse/Keyboard (PS/2)	10	Printer port

To attach the notebook to the port replicator

First, connect the supplied AC adapter or another Sony adapter (not supplied) to the port replicator to supply power to the notebook once the port replicator is attached.

The port replicator can be powered only by the AC adapter, so the AC adapter must remain connected to the port replicator at all times while it is in use. If the AC adapter is disconnected and/or the AC outlet is unplugged while using the port replicator, the computer may malfunction and data may be lost.

Change text in this variable definition to document title.

- 1 Turn off the notebook and disconnect all peripheral devices.
- 2 Plug the AC adapter connector into the **DC IN** port on the port replicator, and plug the power cord into the AC adapter and an AC outlet.

Connecting AC Adapter to Port Replicator

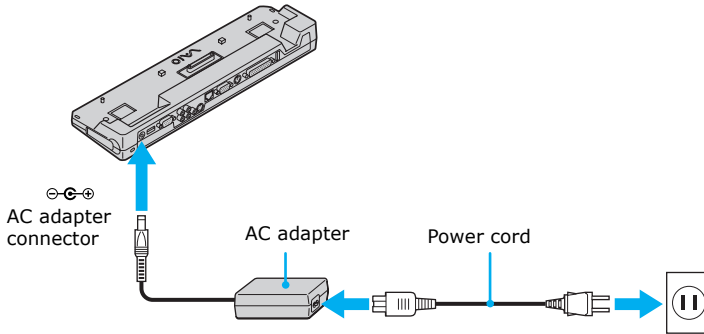

You will know the power is on when the green power indicator located on top of the port replicator switches on.

Power Indicator

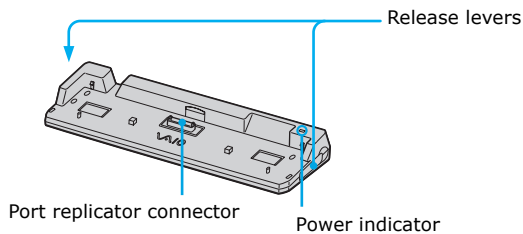

- 3 Close the tilt stands before attaching the notebook to the port replicator.
- 4 Align the connector on the bottom of the notebook with the port replicator connector and push the notebook down until it clicks into place.

Attaching Notebook to Port Replicator

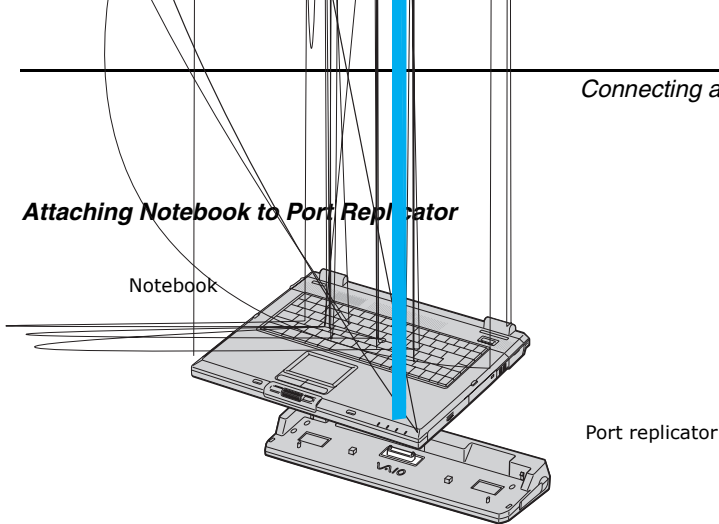

- 5 Turn on the notebook.

 When attaching your notebook to the port replicator, do not attempt to insert or remove the battery pack. Lifting and turning the notebook with an attached port replicator could cause a temporary loss of power.

To remove your notebook from the port replicator

- 1 Double-click  in the taskbar. The “Safely remove ...” dialog box opens.
- 2 Click the dialog box. When the message, “Safe to Remove Hardware” appears, click Close.
- 3 Once all active peripheral devices are disengaged, disconnect the device connectors from the port replicator.
- 4 Pull the release levers on each side of the port replicator to release the notebook from the port replicator.

Releasing Notebook from Port Replicator

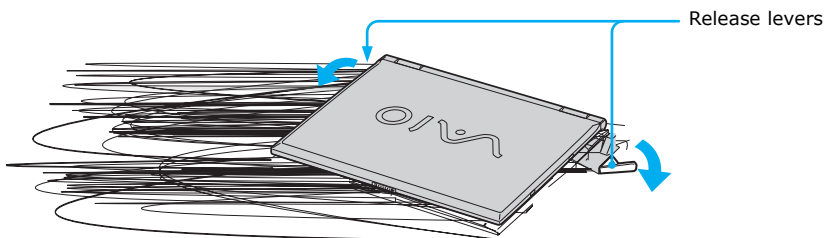

Change text in this variable definition to document title.

- 5 Lift the notebook away from the port replicator.

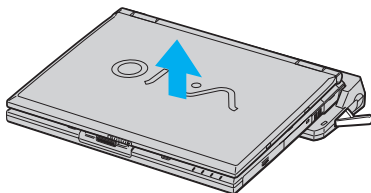

Removing Notebook from Port Replicator



Connecting a PS/2 External Mouse or Keyboard

You can connect either an external PS/2® mouse or PS/2 keyboard to the port replicator (not supplied) using a similar type PS/2 plug or adapter. You may connect only one PS/2 device to the port replicator at a time.

To connect an external mouse or keyboard

- 1 Shut down the notebook before you connect or disconnect the PS/2 external mouse or keyboard connector.
- 2 Connect the optional port replicator to the notebook.
- 3 Locate the Mouse/Keyboard (PS/2) port on the port replicator identified by the  /  symbols.
- 4 Plug the mouse or keyboard connector into this port with the arrow facing upward.

Connecting External Mouse or Keyboard

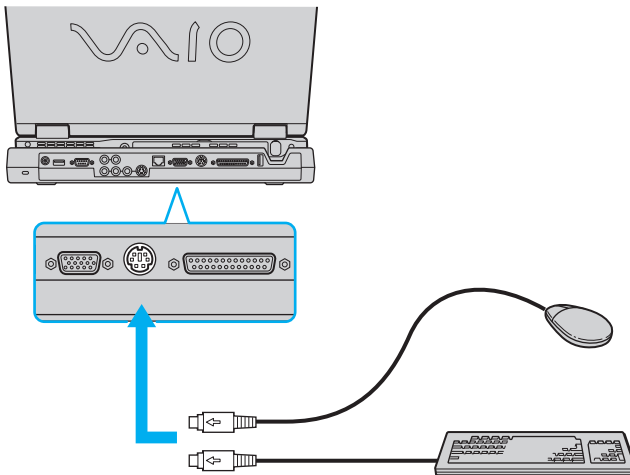

 See the manual that came with your PS/2 mouse or keyboard for more information on its installation and use.

Connecting an Audio Device

You can connect an audio device to the port replicator (not supplied) or the notebook using mini-plug cables shorter than 2 meters with no resistance.

To connect a CD player, active speaker, or an amplifier

If you use the port replicator to connect a CD, MiniDisc, or audio cassette player, you may use the LINE IN jacks. To connect an audio output device to the port replicator, use the LINE OUT jacks. Both sets of jacks consist of one Audio (L) jack and one Audio (R) jack.

Connecting an Audio Device to the Port Replicator

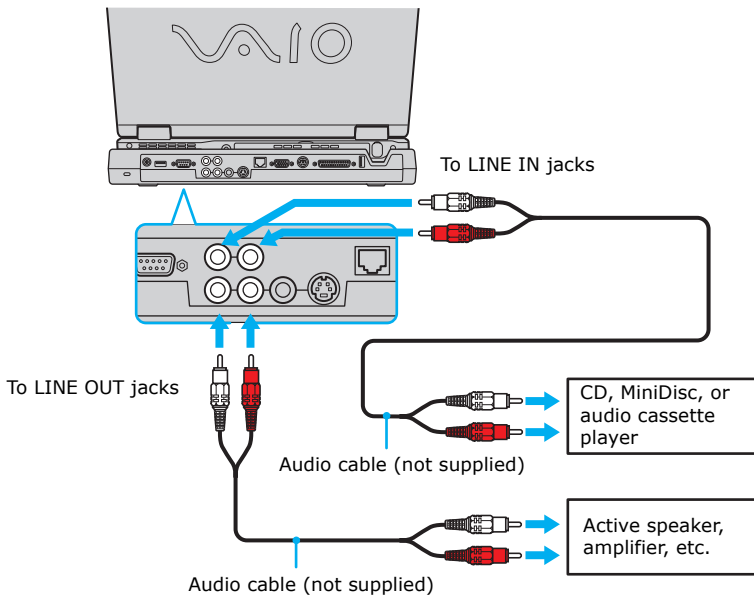

To connect an audio output device to the notebook, use the AV Out jack and an audio cable (not supplied).

Connecting an Audio Device to the Notebook

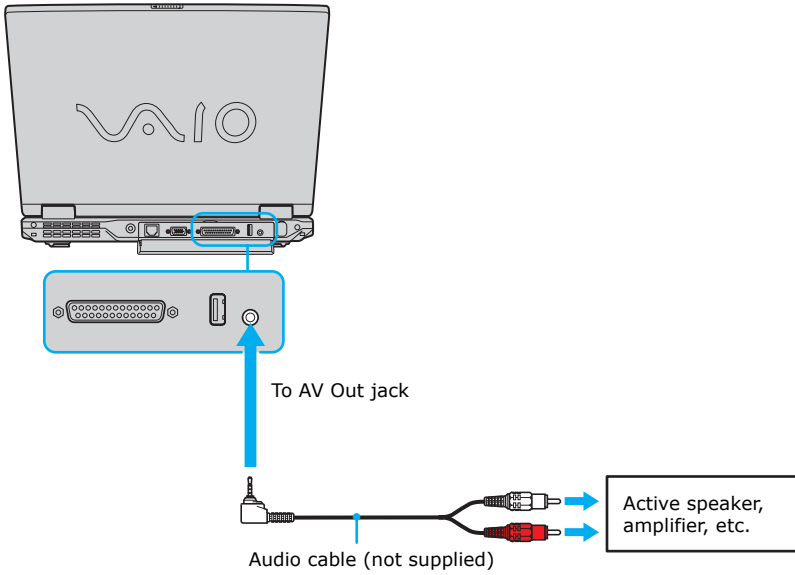

Connecting an Audio-Video Device

You can connect an audio-video (AV) device, such as a TV or a VCR, to the port replicator (not supplied) or the notebook.

To connect an AV device to the port replicator, use either the S Video jack or the LINE OUT jacks and the Composite Video Out jack. The S Video Out jack requires a S Video cable (not supplied), and the LINE OUT jacks and Composite Video Out jack require an audio-video cable (not supplied). If you use the S Video jack, you must connect an audio cable to the Headphone jack located on the right panel.

Connecting a TV to the Port Replicator S Video Jack

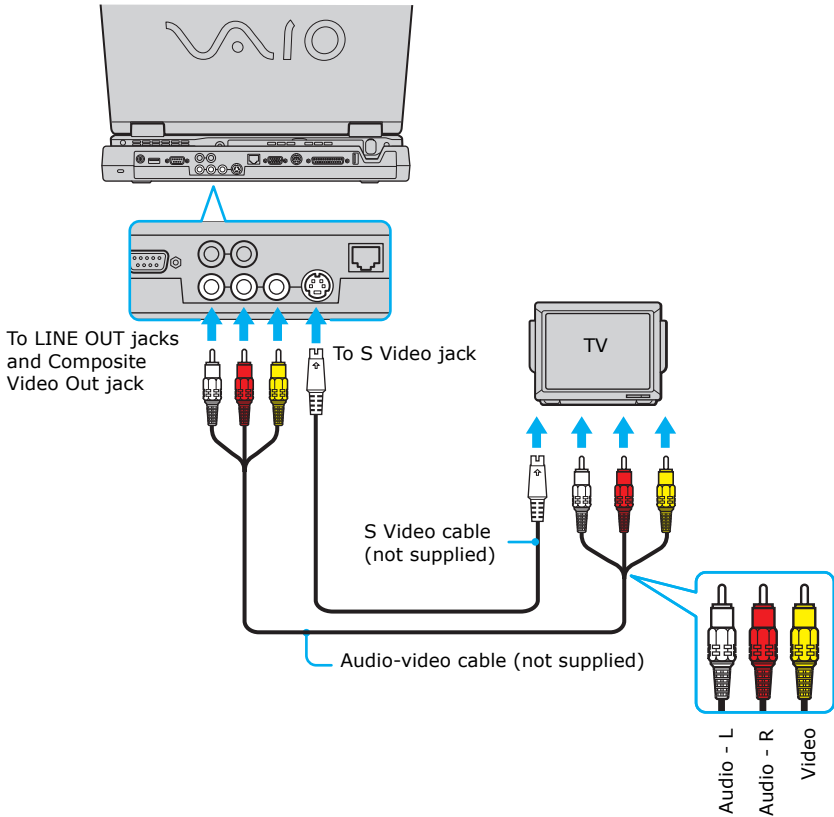

To connect an AV device to the notebook, use the AV Out jack and an audio-video cable (not supplied).

 The S Video Out jack and the AV Out jack are not designed to be used simultaneously. If you connect cables to both jacks, only the S Video jack will function.

Connecting a TV to the Notebook

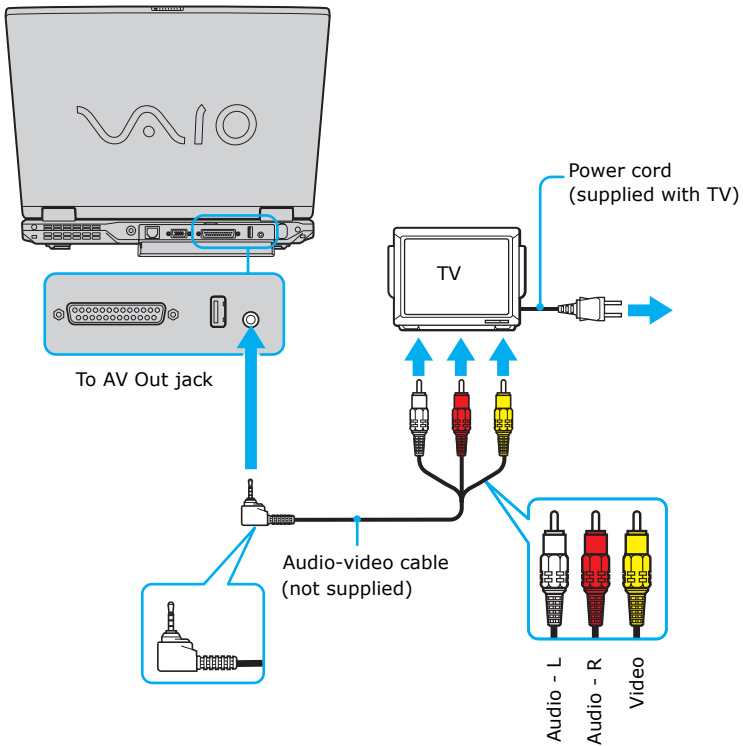

Regardless if you use the port replicator or the notebook to connect an AV device, you will need to switch the TV input channel to external input and set up the TV configuration system. See “Selecting the Display Mode” for more information.

 See the manual that came with your peripheral device for more information on its installation and use.

To change the display

If you insert a DVD in your optical drive to watch on your TV, the Fn+F8 key combination might not activate the function to toggle between your LCD and TV. Follow the procedure below.

- 1 Connect the TV to the notebook.
- 2 Restart the notebook and wait until it finishes rebooting.
- 3 Use the Fn+F8 key combination to toggle between the LCD and TV display. The DVD will play on only one display at a time, so select either LCD or TV as the primary display. See “Selecting the Display Mode” for more information.
- 4 Re-insert your DVD to launch your DVD software.

 A part of the image cannot be displayed on your TV display if the resolution of your notebook is more than 1024 x 768 dots.

Connecting a Parallel Port Printer

You can connect a Windows 2000 operating system-compatible printer to the port replicator (not supplied) or the notebook.

To connect a printer to the notebook

- 1 Locate the  Printer port on the rear panel of the notebook or the port replicator.
- 2 Plug the printer cable (supplied with the printer) connector into this port.

 You may need to change the printer settings before you use the printer. See “Displaying the Sony Notebook Setup Screen” for more information.

Connecting a Parallel Printer to the Notebook

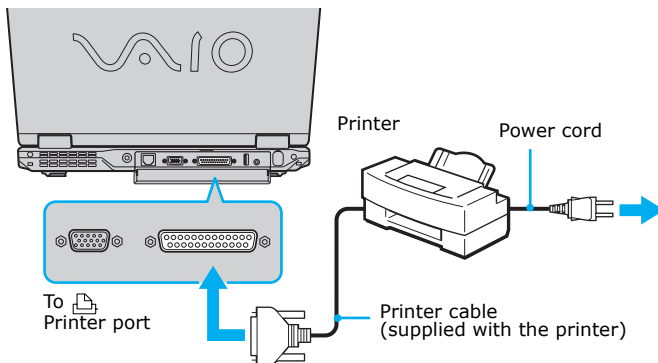

 See the manual that came with your printer for more information on its installation and use.

If your printer stops functioning after resuming from a power saving mode, see “Troubleshooting the Printer” for more information.

Con

00
USB p

printer to
(supplied)

USB pri

USB pri
notebook
USB

connector into the USB port
opposite end of the c

came with yo

Printer to th

that came with your printer for more information

Connecting an External Display

You can connect any one of the following external displays to your notebook or port replicator (not supplied).

- Computer display (monitor)
- Multimedia computer display
- Projector

To connect a computer display to the notebook

- 1 Shut down the computer before you connect the computer display.
- 2 Locate the VGA (Monitor) port on the rear panel of the notebook or port replicator.
- 3 Plug the display cable (not supplied) connector into the VGA (Monitor) port.
- 4 Verify that the power cord is plugged into the computer display and an AC outlet.

Connecting an External Computer Display to the Notebook

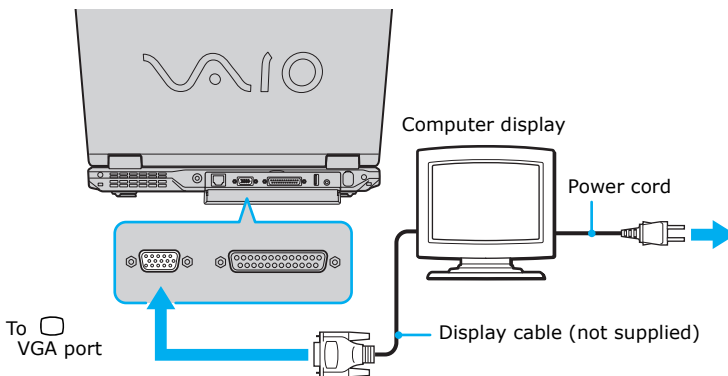

 See the manual that came with your computer display for more information on its installation and use.

To connect a multimedia computer display to the notebook

You can connect a multimedia computer display with built-in speakers and a microphone to the notebook or port replicator.

- 1 Shut down the computer before you connect the multimedia computer display.
- 2 Locate the AV Out jack on the rear panel of the notebook.
- 3 Plug the display cable (not supplied) connector into the AV Out jack, and plug the opposite end of the display cable into the multimedia computer display.
- 4 Verify that the power cord is plugged into the multimedia computer display and an AC outlet.

Connecting a Multimedia Computer Display to the Notebook

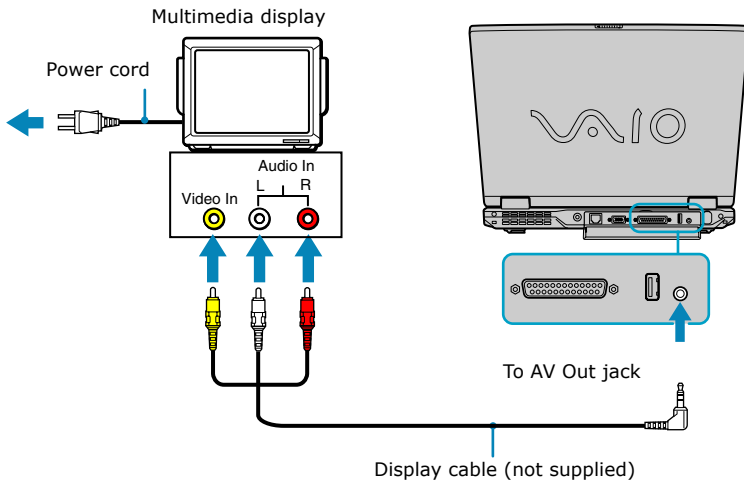

 See the manual that came with your multimedia computer display for more information on its installation and use.

To connect a projector to the notebook

You can also connect a projector, such as the Sony LCD Projector, to the notebook or port replicator.

- 1 Shut down the computer before you connect the projector.
- 2 Locate the VGA (Monitor) port on the rear panel of the notebook and the Headphone jack on the right panel of the notebook.
- 3 Plug the display cable (not supplied) connector into the VGA port, and plug the audio cable (not supplied) connector into the Headphone jack.
- 4 Plug the opposite end of the cables into the appropriate ports on the projector.
- 5 Verify that the power cord is plugged into the projector and an AC outlet.

Connecting a Projector to the Notebook

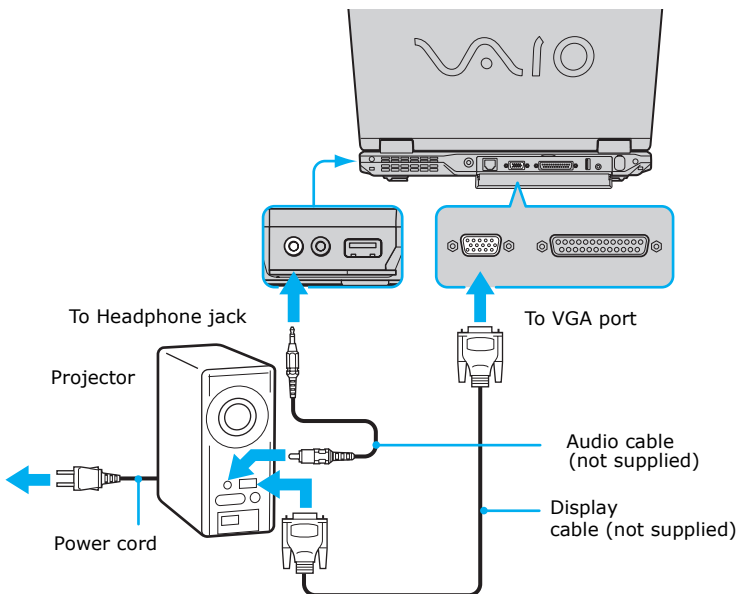

 See the manual that came with your projector for more information on its installation and use.

To change the display when connecting an external computer display or projector

When you connect an external display to the VGA (Monitor) port, you can toggle the output between the Liquid Crystal Display (LCD), the external monitor, or both devices.

Use the Fn+F7 key combination to select the display you want. See “Selecting the Display Mode” for more information.

<i>To</i>	<i>Press</i>	<i>Result</i>
Switch to an external display	Fn+F7	Toggles between the LCD, the external display connected to the Monitor port, or both the LCD and external display.

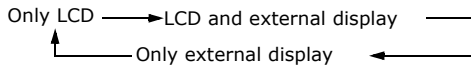

 Connect the external display to the notebook or port replicator before you turn on the unit, otherwise the Fn+F7 key combination will not work.

Connecting a Universal Serial Bus Device

You can connect a Universal Serial Bus (USB) device, such as an external mouse, keyboard, speaker, and microphone, to your notebook or port replicator (not supplied).

To connect a USB device to the notebook

- 1 Locate the  USB port on the rear, left, or right panel.
- 2 Plug the USB cable (not supplied) connector into this port, and plug the opposite end of the cable into the USB device, if it is not already connected.

Connecting USB Device to a USB Port

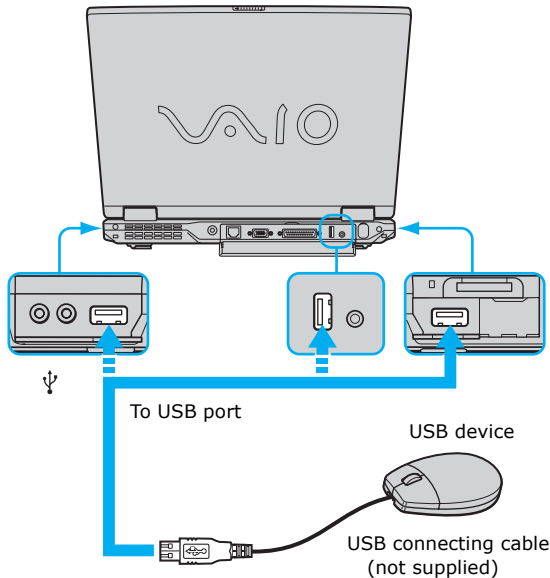

You can use a Sony PCGA-UMS1 series USB mouse (not supplied) with this computer. The USB mouse software driver is preinstalled in the notebook, so you simply plug the USB mouse into the USB port to use it. One USB port supports one USB device.

 See the manual that came with your USB device for more information on its installation and use.

Change text in this variable definition to document title

Connecting an i.LINK Device

You can connect an i.LINK®* enabled digital video camera recorder to the i.LINK® S400  (IEEE 1394) port on the notebook.

To connect a digital video camera recorder

- 1 Plug the i.LINK® cable (not supplied) connector into the i.LINK S400 port on the left panel of the notebook.
- 2 Plug the opposite end of the i.LINK cable into the i.LINK port on the digital video camera recorder.

Connecting Digital Video Camera Recorder to i.LINK

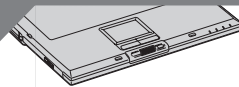

*The i.LINK logo is a registered trademark of Sony used to designate that a product contains an IEEE 1394 connection. The operating conditions for i.LINK connection may vary, depending on the software application, operating system, and other compatible i.LINK devices. All products with an i.LINK connection may not be compatible with each other. Refer to the documentation that came with your compatible i.LINK device for more information on operating conditions and proper connection. Before connecting compatible i.LINK PC peripherals to your system, such as a CD-RW or hard disk drive, confirm their operating system compatibility and required operating conditions.

 In the above illustration, a Sony digital video camera recorder is connected to the notebook. Instructions for connecting a different type of digital video camera recorder may differ.

Notes on connecting an i.LINK device

- ❑ Only the Sony digital video camera port labeled “DV In/Out” or “i.LINK” are i.LINK-compatible.
- ❑ Do not connect more than one digital video camera at a time. The software supplied with your notebook will not recognize multiple cameras.
- ❑ The i.LINK port on the notebook does not supply power to external devices. If the external device requires power from the i.LINK port, you cannot use the device with the notebook.
- ❑ The notebook supports transfer rates up to 400 Mbps; however, the actual transfer rate is the lowest transfer rate of the external device.
- ❑ The i.LINK features available may vary depending on the software applications you use. See the documentation that accompanied your software for more information.

 See the manual that came with your digital video camera recorder for more information on its installation and use.

Connecting with another VAIO computer

The preinstalled Smart Connect software enables you to use an i.LINK®* cable (not supplied) to connect your VAIO notebook to another computer that also has Smart Connect. You can then use one computer to edit, copy or delete files on the other computer. You can also print from a printer attached to either computer.

See Smart Connect online help for more information.

Connecting with an i.LINK Cable

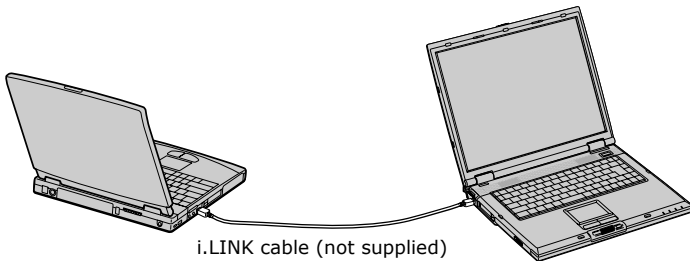

When you connect two VAIO computers, you must assign each computer a unique name. The computers can be identified by this unique name when the two computers are networked together

To connect VAIO computers that do not have the latest Windows® operating system, Smart Connect software may be necessary. Consult the Sony Web site for support options (<http://www.sony.com/pcsupport>).

* i.LINK is a trademark of Sony used to designate that a product contains an IEEE 1394 connection. The i.LINK connection may vary, depending on the software applications, operating system, and compatible i.LINK devices. All products with an i.LINK connector may not communicate with each other. Refer to the documentation that came with your compatible i.LINK device for information on operating conditions and proper connection. Before connecting compatible i.LINK PC peripherals to your system, such as a CD-RW or hard disk drive, confirm their operating system compatibility and required operating conditions.

Connecting External Speakers

You can enhance the sound quality of your notebook by connecting external speakers (not supplied).





Do not place floppy disks on the speakers; the speakers' magnetic field may damage the data on the floppy disks.

To connect external speakers

- 1 Verify that your speakers are designed for notebook use, and turn down the volume of the speakers.
- 2 Locate the  Headphone jack on the right panel of the notebook, and plug the speaker cable (supplied with speakers) connector into this jack.

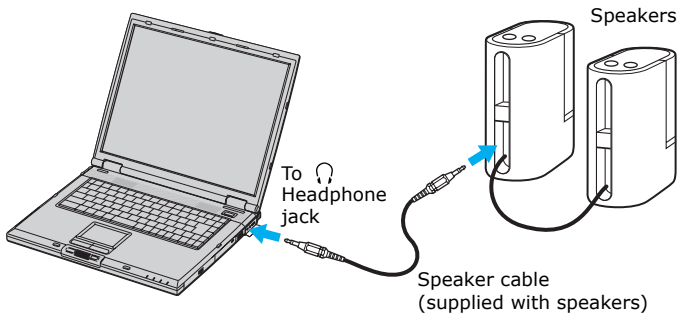
Connecting Speakers to the Headphone Jack



 See the manual that came with your speakers for more information on their installation and use.

Connecting an External Microphone

You can enhance the quality of sound input by using an external microphone (not supplied).

To connect an external microphone

- 1 Verify that your microphone is designed for notebook use and compliant with the plug-in power microphone.
- 2 Locate the  Microphone jack on the right panel of the notebook. A protruding dot above the Microphone jack distinguishes this jack from the Headphone jack.
- 3 Plug the microphone cable (supplied with microphone) connector into the Microphone jack.

Connecting a Microphone to Microphone Jack

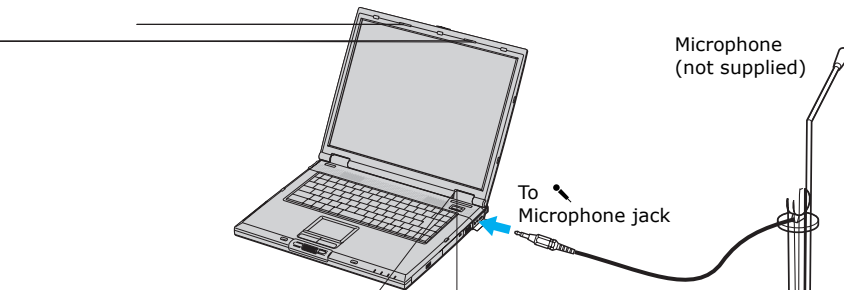

 See the manual that came with your microphone for more information on its installation and use.

Expanding Your Notebook Capabilities

The following peripheral devices can be connected to your notebook to expand the capabilities of your computer and enhance its versatility to meet your various business or personal needs:

- A Personal Digital Assistant (PDA)
- A Wireless LAN Access Point
- A Wireless LAN PC Card

Personal Digital Assistant

A handheld PDA is the quintessential personal planner and entertainment center that fits in your pocket. With a PDA, you can easily perform the following functions:

- Enter your schedule details in the calendar and view them by the day, week, or month, and even set an alarm to remind you of important events.
- Keep your contact names, addresses, phone numbers, and other details in the address book, and find them when you need them.
- Add tasks to the To Do List, prioritize them, and assign them due dates.
- Synchronize your data with the software on your notebook to back up your data.
- Track expenses when you are out of the office, and transfer the data to your notebook.
- Exchange data with your notebook.

Wireless LAN Access Point

The Wireless LAN Access Point is designed for building a wireless Local Area Network (LAN) environment. The Access Point comes with the Wireless LAN PC Card and required software. You can easily build a wireless LAN environment by plugging the Access Point into an AC power outlet, installing the Wireless LAN PC Card in your notebook, and using the provided software. Because a wireless LAN configuration requires no wiring, you can operate multiple computers more freely than ever before.

You can also connect your Access Point to a telephone line, Integrated Services Digital Network (ISDN) router, cable modem, or Digital Subscriber Line (xDSL) modem to share access to the Internet among multiple computers.

Change text in this variable definition to document title.

Wireless LAN PC Card

The Wireless LAN PC Card, which comes with the Wireless LAN Access Point, can be purchased separately and is designed for building a wireless LAN environment. The Wireless LAN PC Card can be used with or without the Access Point. With the Access Point, you can build a wireless LAN between computers that are equipped with the Wireless LAN PC Card and gain access to the Internet. Without the Access Point, you can achieve direct communication (Peer to Peer mode) between computers.

 For more information on Sony Wireless LAN, go to <http://www.sonystyle.com/vaio>.

Customizing Your VAIO Notebook

The following sections briefly describe how to change your notebook's default settings.

- Displaying the Sony Notebook Setup Screen
- Controlling Power Management
- Displaying Battery Information
- Selecting the Display Mode
- Using the Multilingual User Interface Language Option

Change text in this variable definition to document title.

Displaying the Sony Notebook Setup Screen

To display the Sony Notebook Setup screen:

- 1 Click Start on the Windows® taskbar, and then Control Panel.
- 2 Click Performance and Maintenance, and then Sony Notebook Setup.

Sony Notebook Setup Screen

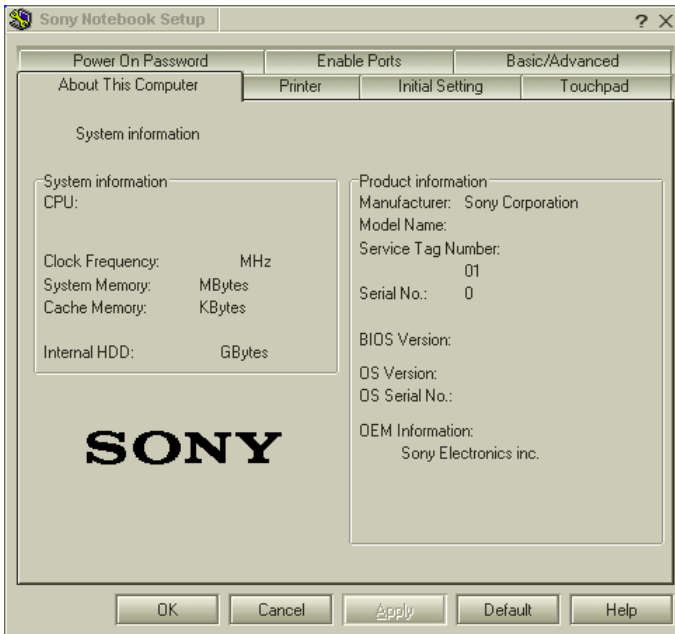

- 3 Select the tab for the item you want to change. See “Sony Notebook Setup tabs” for more information.
- 4 After you finish making your changes, click OK.

Sony Notebook Setup tabs

Tab	Description
About This Computer	Display system information, including memory capacity, serial number, and BIOS version.
Printer	Select printer port mode settings.
Initial Setting	Change the volume of the sounds that play while the operating system is loading. Select the order of drives and devices from which you want to load the operating system. You can specify the hard drive as well as other drives inserted into your computer.
Touchpad	When you connect an optional mouse to your notebook, you can make your touchpad inactive. You can also customize the settings of your mouse using the mouse utility.
Power On Password	Set the password to secure your computer.
Enable Ports	Enable or disable ports. Disabling ports releases resources to the system. To change the serial settings, click Advanced on the Basic/Advanced tab.
Basic/Advanced	Switch between Advanced mode (additional screens with advanced settings) and Basic mode of display.



For more information about each option, click Help on the Sony Notebook Setup screen to display the Help file.

Controlling Power Management

The PowerPanel™ utility allows you to control the power management of your notebook and provides key information about system activity and battery life. The following sections briefly describe how to conserve your computer's battery power. You can also refer to PowerPanel Help for more detailed information. To activate a profile or command, see "Displaying Battery Information" for more information.

Viewing the Power Management status icons

The Power Management status icons are displayed in the taskbar at the lower-right corner of your screen. Move the pointer over the Battery icon to see the tooltip that displays information about the active profile. Double-click the icon for additional information.

To change the Power Management profile

- 1 Right-click the battery icon on the taskbar, and then select Profiles.
- 2 Choose a new profile from the pop-up list. See "Power Management profiles" for a description of available options.



When you use the battery pack to power your notebook, your system selects the Maximum Battery Life power management profile by default. If you select a different power management profile while using battery power, that profile is selected automatically the next time you use the battery pack to power your notebook.

Refer to the PowerPanel Help for information on customizing the Power Management toolbars.

You can change the power management settings, such as the system timer and the brightness of the screen.

To customize Power Management settings





You can customize power management settings, such as the system timer and the brightness of the screen.

- 1 Right-click the CPU: Performance icon on the Windows taskbar.
- 2 Select Edit/Create Profiles from the menu.

- 3 In the left panel, click a profile in which you want to change the settings.
- 4 In the right panel, double-click an item in which you want to change the settings.
- 5 Select an option from the drop-down list.
- 6 Click the File menu, then click Save.
- 7 Click the File menu, then click Exit.

Power Management profiles

The PowerPanel™ utility provides several predefined power management profiles. Each profile consists of a group of power management settings that are designed to meet specific power management goals — ranging from maximum power management to no power management. You can change the settings for any of the predefined profiles (except for the Disable Power Management profile), or you can create your own profile to suit your portable computing needs. The predefined profiles are:

<i>Icon</i>	<i>Description</i>
	<p>Maximum Performance Provides the best system performance while still conserving power.</p>
	<p>Maximum Battery Life Provides power saving features to give you maximum battery life and good performance. It slows the notebook and puts it into Standby mode after a specified time period.</p>
	<p>Disable Power Management Turns off all power management features such as Standby and Hibernate modes. You can not change the settings of this profile.</p>
	<p>AC Power The power management state when AC power is in use. Similar to the Power Management Off setting. Power Management automatically loads the AC profile unless you disable this feature.</p>

Change text in this variable definition to document title.

Icon

Description



Games

Disables the display and the Hard Disk Standby timer.



Presentation

Keeps the display on at all times while it conserves power. This option is ideal for slide show presentations. You can establish settings for LCD (Video) Standby, Hard Disk Standby, and Standby mode to optimize power management for your system.



Camera

Optimizes performance and power requirements for camera usage.



DVD

Optimizes performance and power requirements for DVD usage.



Word Processing

Optimizes power management with longer timeouts on the hard disk and display screen. You can also establish settings for LCD (Video) Standby, Hard Disk Standby, and Standby mode to optimize power management for your system.



Spreadsheet

Optimizes performance and power requirements for spreadsheet applications.



Communications

Extends battery life by initiating a quick display timeout. The Internal modem remains powered. You can also establish settings for LCD (Video) Standby, Hard Disk Standby, and Standby mode to optimize power management for your system.



Automatic Profile Selection

Automatically switches to a profile suitable for active applications.



Do not choose the Automatic Profile Selection when connected to AC power.

Power Management commands

PowerPanel™ also provides power management commands that you can use to activate specific power management functions and to control power for a specific device. You can use these commands to override a profile setting or initiate an immediate action.

Icon	Description
-------------	--------------------



Standby

Puts the system into Standby mode, a power management state that saves the state of the system and peripheral devices in memory (RAM). Power consumption reduces to a minimum, and the system remains on. To return the system to the active state, press any key on your computer. Your notebook is preset to enter Standby mode after 25 minutes.



Hibernate

Provides for the lowest level of power consumption. The system writes the state of the system and peripheral devices to the hard disk and turns off the system power. To return the system to the original state, use the power button to turn on power. The system saves the data in the Save to Disk Partition on the hard drive.

Conserving battery power

When using your notebook with a battery, the LCD display and the hard drive can be set to switch off automatically to conserve battery power.

See “Power Management profiles” for more information.

Displaying Battery Information

You can display information for each of the batteries in your notebook. The following sections briefly describe how to display your notebook's general battery information. Refer to PowerPanel Help for more detailed information.

To activate the Battery Information toolbar

- 1 Right-click the taskbar at the bottom of the screen.
- 2 Select Toolbars from the pop-up menu, and then click Battery Information. The Battery Information toolbar appears on the taskbar.

 If the Battery Information toolbar is hidden behind the taskbar icons, right-click the taskbar and deselect Lock the Taskbar, then click and drag the edge of the Battery Information toolbar to the left.

To view the total charge remaining in the battery, place the pointer over the battery status icon in the taskbar on the lower-right corner of the screen.

Battery Information Toolbar

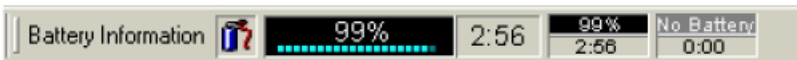

- **Percentage indicator** — Displays the percentage of the remaining charge.
- **Time indicator** — Displays estimated time (hours : minutes) remaining before the battery fully discharges, also known as the time-to-empty.

Battery icon descriptions

Battery icon	Battery status
---------------------	-----------------------



Charging



Fully charged



Discharging



No battery

Displaying detailed battery information

Double-click the battery icon on the taskbar to display the Battery Information window. The Battery tab contains information such as battery charging time and duration of the battery charge.

Change text in this variable definition to document title.

Battery Information Window

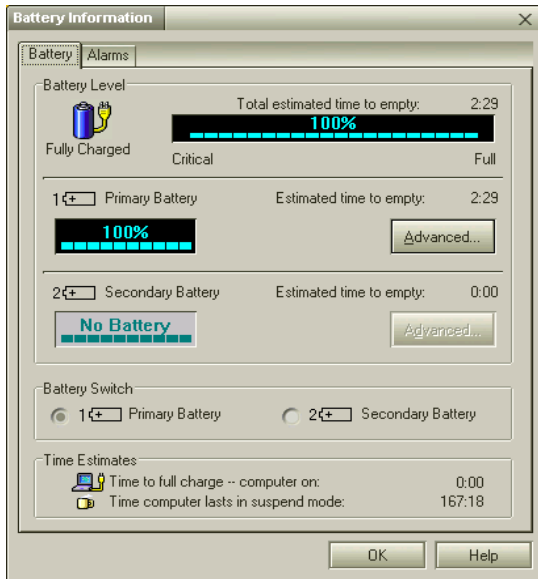

Customizing the Battery Information toolbar and alarm system

You can customize the Battery Information toolbar and modify the alarm settings, to suit your portable computing needs. Refer to PowerPanel™ Help for more information.

Selecting the Display Mode

This notebook uses the ATI video controller. You can select which display is used when the notebook is connected to an external monitor. When you connect an external display, you can switch the display mode between your notebook's LCD display and the external monitor.



- 1** Click Start, point to Control Panel, and click Appearance and Themes.
- 2** Click Display to access the Display Properties window.
- 3** Click the Settings tab, and then click the Advanced button. The “(Multiple Monitors) and Mobility Radeon Properties” dialog box appears.

Change text in this variable definition to document title.

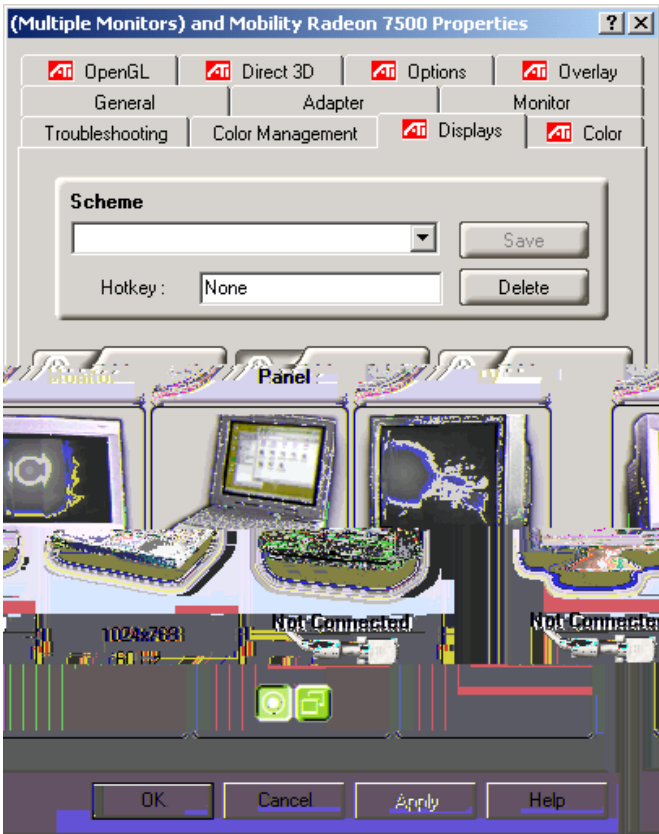
(Multiple Monitors) and Mobility Radeon Properties screen



- 4 Click the Displays tab and select the display settings by clicking the  icon on the panel of your display choice. For more information, click the Help button.

 If you cannot see your movie or DVD on the external display, change the monitor or TV setting by clicking on the Secondary  icon and changing it to Primary .

 You may not be able to display the notebook LCD screen and an external display or projector at the same time, depending on the types of computer displays and projectors you are using.

Turn on the notebook after you connect the external display.

Changing the window design of Sony software

To change the window design

- 1 Click the Start button, and then click Control Panel.
- 2 In the left window pane of Control panel, click “Switch to Classic View.”
- 3 Double-click UI Design Selector.
- 4 Click << or >> and select the desired design.
- 5 Click Apply. The “UI Design Selector” window design changes. The window design for your Sony software will match the “UI Design Selector” window.
- 6 To try another selection, click << or >> and then click OK to close the UI Design Selector.

 This feature is available with UI Design Selector-compatible software only.

Using the Multilingual User Interface Language Option

(Windows® XP Pro only) After you have initially setup your new VAIO computer, you have the ability to change the language displayed in Microsoft® Windows® XP Professional operating system. The multilingual user interface (MUI) language option changes the text controlled by Windows XP Professional operating system. Menus, help files, and icons generated by Windows XP Professional are shown in your selected language. All other software applications are displayed in English as the default language.

 The multilingual user interface language option is not designed to replace a localized version of the Microsoft Windows XP Professional operating system. Under certain conditions, some third-party software applications may not function properly.

To Change the Language Option

- 1 Click Start in the Windows taskbar, then click Control Panel.
- 2 Click “Date, Time, Language and Regional Options”, then click Regional and Language Options. The Regional and Language Options dialog box appears.
- 3 Select the Languages tab.
- 4 From the “Language used in menus and dialogs” drop-down menu, select the desired language:
 - English
 - français
 - Português
 - español
- 5 Click Apply, then click OK.
- 6 The Change Regional dialog box appears. Click OK.
- 7 Click Start in the Windows taskbar, then click Logoff. Restart your computer for the settings to take effect.

 Additional users can also change to their desired language(s) without effecting your existing language settings.

To Change Numbers, Currency, Time, and Date Formats

You can change the system's number, currency, time and date formats to coordinate with your chosen country or language settings. To change these formats, follow the steps below:

- 1** Click Start in the Windows taskbar, then click Control Panel.
- 2** Click "Date, Time, Language and Regional Options", then click Regional and Language Options. The Regional and Language Options dialog box appears.
- 3** From the Regional Options tab, click the "Standards and formats" drop-down menu to view the available country choices. Select the desired country.
- 4** Click Customize to change the number, currency, time, and date settings. Click Apply, then click OK.

Change text in this variable definition to document title.

Adding Memory

In the future you may want to install memory modules to expand the functionality of your notebook. The amount of memory on your notebook will vary depending on the model you purchased. See the Specifications flyer that came with your notebook for the amount of memory preinstalled. Expansion memory modules are available as options. For memory upgrades and information on which memory modules to use, refer to the Specifications flyer. This section describes how to replace memory modules in your computer.

- Precautions and Procedures
- Typical expansion memory configuration
- Removing a memory module
- Installing a memory module
- Viewing the amount of memory

Precautions and Procedures

The procedures described below assume that you are familiar with the general terminology associated with personal notebooks and with common safety practices required for using and modifying electronic equipment. Personal injury or equipment damage may result from failure to take these precautions.



Make sure you observe the proper safety precautions when you install memory modules in your notebook. See the bulleted list below. Be careful when adding memory. Mistakes made when installing or removing a memory module may cause a malfunction.

- ❑ Disconnect your system from its power source and from any telecommunications links, networks, or modems before you open the system or follow any of the procedures described below. Personal injury or equipment damage may result from failure to take these precautions.
- ❑ Electrostatic discharge (ESD) can damage memory modules and other components. Perform the procedures described below only at an ESD workstation. If such a station is not available, do not work in a carpeted area, and do not handle materials that produce or hold static electricity (cellophane wrappers, for example). Ground yourself by maintaining contact with an unpainted metal portion of the chassis while performing the procedure.
- ❑ Do not open the memory module package until you are ready to install the module. The package protects the module from ESD.
- ❑ Use the special bag for preventing ESD or use aluminum foil when you store the memory module.

Typical expansion memory configuration

Models with 256 MB Memory

Total System Memory (MB)	Slot 1 (MB)	Slot 2 (MB)
256	256	
384	256	128
512	256	256

Removing a memory module

- 1 Shut down your notebook and disconnect all peripheral devices, such as your printer.
- 2 Unplug your notebook and remove the battery pack(s).
- 3 After your notebook has cooled, loosen and remove the screw that secures the cover of the memory bay on the bottom of your notebook. Use an appropriate screwdriver.

Removing the memory module cover

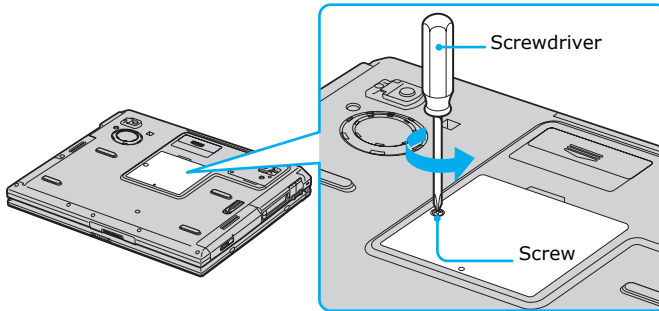

- 4 Touch a metal object (such as the connector panel on the back of your notebook) to discharge any static electricity.
- 5 Remove the memory module.

Removing memory module

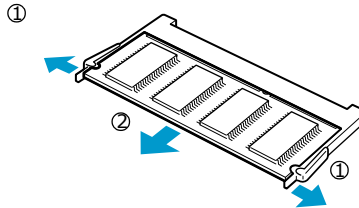

① Pull the tabs in the direction of the arrow
The memory module is released.

② Pull the memory module in
the direction of the arrow.

6 Tighten the screw on the memory bay cover.

 Your notebook comes with a memory module installed in the memory slot. To upgrade your memory, removal of this module may be necessary before installing your upgrade memory module(s).

Installing a memory module

- 1 Follow steps 1 to 4 of “Removing a memory module” on page 102 for removing the preinstalled memory.
- 2 Remove the new memory module from its packaging.
- 3 Install the memory module by sliding it into the memory module slot. Push the module into place until it clicks.

Installing memory module

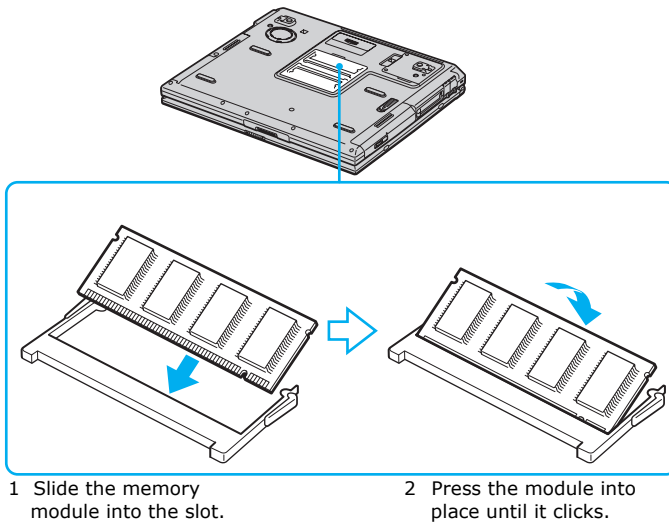

- 4 Tighten the screw on the cover of the memory bay.

Viewing the amount of memory

- 1** Restart the notebook.
- 2** (Windows® XP) Click Start on the Windows® taskbar, select All Programs, and click “Sony Notebook Setup.” The Sony Notebook Setup screen appears. (Windows 2000) Click Start on the Windows® taskbar, select Programs, and then click “Sony Notebook Setup.” The Sony Notebook Setup screen appears.
- 3** Click the “About This Computer” tab to view the amount of system memory. If the additional memory is not shown, remove and reinstall the memory module.

 The amount of memory displayed in the Sony Notebook Setup screen is not always correct. The video adapter uses some system memory, and that amount of memory does not appear as part of the total memory shown in the Sony Notebook Setup screen.

Change text in this variable definition to document title.

About the Software on Your Notebook

Your VAIO® notebook is ready to help you work, play, learn, and communicate as soon as you turn it on. This section provides you with information on the following topics:

- Software Overview
- Software Support Information

Software Overview

Your computer may not be supplied with all of the software listed below, depending on the configuration you purchased. Preinstalled software may not be identical to retail versions, or include supporting documentation.

Adobe® Acrobat® Reader®

Adobe Systems Inc.

Acrobat Reader software allows you to view, navigate, and print electronic documents in Adobe's Portable Document Format (PDF), an open file format that is intended to preserve the fidelity of documents created on all major computer platforms.

Adobe® Photoshop® Elements (On selected models)

Adobe Systems Inc.

Using state-of-the-art image editing tools, you can unleash your artistic ability and create digital images for print, e-mail and posting to the Web. The versatile image capturing options allow you to start working with digital and traditional photos immediately. Explore endless creative possibilities for your personal images with Adobe Photoshop Elements software.

Adobe® Premiere® LE (On selected models)

Adobe Systems Inc.

Adobe Premiere LE software offers interface and editing tools for producing movies for video, multimedia, or the Web. View source clips and edited footage simultaneously on-screen. You can create your own personal video clips that are up to three hours in length, with complete audio-video synchronization.

America Online®

America Online, Inc.

America Online is a popular Internet online service. Stay in touch with family and friends with easy-to-use e-mail. Manage your personal finances, get the latest news and sports scores, and chat with thousands of others who share your interests.

ArcSoft PhotoPrinter® 2000 Pro

ArcSoft, Inc.

ArcSoft PhotoPrinter Pro software is an easy-to-use, yet advanced printing program that lets you quickly lay out multiple images in multiple sizes on a single sheet of paper. ArcSoft PhotoPrinter Pro software offers a wide selection of templates including landscape, portrait, free-style, mixed sizes, custom templates and more. The application includes enhancement tools and special effects for improving photos while giving you the ability to add text to any image. With ArcSoft PhotoPrinter 2000 Pro software you can create business cards, handouts, calendars, mailing labels, and much more.

DigitalPrint

Sony Electronics Inc.

This image management software makes it fun and easy to edit, import, and organize your digital pictures in a photo album for rich digital printing to any standard color laser or ink-jet printer. DigitalPrint can also be used to make custom CD labels for your audio CDs.

Drag'n Drop CD (On selected models)

DigiOn, Inc., and Easy Systems Japan Ltd.

Drag'n Drop CD is designed to be the most simple software to make your own CD. Users can create their own best AudioCD, or data CD that can be read in many PCs. With Drag'n Drop CD you can also create your own backup CD from the original CD that you own.

DVgate™

Sony Electronics Inc.

Connect a digital video camera recorder to the i.LINK® port and capture your own video clips and still images. You can edit clips from your video, add new clips, and combine clips into new movie segments. You can also save your images in a variety of popular file formats.

EarthLink Network Total Access®

EarthLink, Inc.

An Internet Service Provider that supplies access, information, and assistance to its customers, introducing them to the Internet. Member benefits include e-mail, newsgroups, a Personal Start Page, free storage space for your personal Web site, a member magazine, and 24-hour technical support.

EverQuest (On selected models)

Sony Online Entertainment Inc.

This introductory edition of EverQuest, a living, constantly evolving fantasy world, takes users to new heights of online role-playing gaming. Enter an enormous virtual environment—an entire world with its own diverse species, economic systems, alliances, and politics. Make yourself a noble human knight, a vicious dark elf thief, a greedy dwarven merchant, or whatever your heart desires as you meet new friends from around the world and face epic challenges.

Microsoft® Office XP Small Business Edition (On selected models)

Microsoft Corp.

With Microsoft Office XP system you'll find a powerful new technology that will help you get work done more quickly by providing real-time, context-sensitive options for important actions, from formatting to error correction. Task panes consolidate important tasks into a single integrated view, enabling you to conduct searches, launch and format documents, and view the contents of your Clipboard from one location.

Microsoft® Office XP Professional (On selected models)

Microsoft Corp.

Microsoft Office XP software redefines the relationship between people and software by providing a smarter, simpler way of working. New Office XP software features include context-sensitive smart tags, enhanced formatting options, and more, that enable you to continually integrate additional services into Office and access information anytime.

Microsoft® Word (On selected models)

Microsoft Corp.

Microsoft Word makes it easy to create common Web, e-mail, and print documents for use around the world. It embraces HTML as a first-class file format and extends Word's ease-of-use to the Web and e-mail. Word also extends that ease-of-use to international users, making it easy to create multilingual documents.

MovieShaker™

Sony Electronics Inc.

Sony's original MovieShaker software creates personal movies that have transitions, background music, and text. Just import your video clips and "shake" with a click of the mouse. Your personal movies are easy to create and fun to share with family and friends.

OpenMG™ Jukebox

Sony Electronics Inc.

OpenMG Jukebox software enables you to import digital audio files by downloading audio files from Electronic Music Distribution (EMD) services over digital networks, such as the Internet. You can record audio CDs onto your hard drive in a variety of formats.

PC-Cillin® 2000

Trend Micro, Inc.

PC-Cillin software provides portable, easy-to-use, real-time antivirus security at your computer's entry point (beaming, synchronization, Internet access) to defend against potential threats hidden inside files, e-mail, or on the Web.

PicoPlayer™

Sony Electronics Inc.

PicoPlayer software is a video player utility that enables you to use Giga Pocket™ Personal Video Recorder functions on a computer that does not have Giga Pocket Personal Video Recorder installed. You can play Video Capsules created by Giga Pocket Personal Video Recorder, and, if a Giga Pocket Server is available on your home network, watch TV streamed from the Giga Pocket Server and remotely control the Giga Pocket Server's TV programming functions.

PictureGear™

Sony Electronics Inc.

This image management software displays images from your hard drive, a Sony digital still camera, or a Sony Mavica® camera. The images appear in a convenient light-table format, so that you can easily view the contents of an entire folder.

Quicken®

Intuit Inc.

Quicken software is the fastest, easiest way to organize your finances. Quicken software works just like your checkbook, so it's easy to learn and use. You can even pay your bills online. Quicken software manages all of your finances, bank accounts, credit cards, investments, and loans.

QuickTime®

Apple Computer, Inc.

The versatile QuickTime software is used to play hundreds of different kinds of files, including video, audio, and virtual reality (VR) movies. You can play QuickTime files (referred to as “QuickTime movies”) using QuickTime Player or any other application, such as a Web browser or word processor, that supports QuickTime software.

RealJukebox®

RealNetworks, Inc.

RealJukebox software is a popular digital music system that gives you the ability to easily acquire, play and manage digital music files. You can locate and download your favorite music from the Internet and organize your own personal music collection.

 If you are using an external CD-ROM drive connected with a PC Card, be sure to connect your external CD-ROM drive before starting RealJukebox. Additionally, do not remove your CD-ROM drive while using RealJukebox. Either of these actions may cause RealJukebox to shut down improperly.

RealPlayer®

RealNetworks, Inc.

RealPlayer software is a high-quality streaming media player that supports many digital media formats. The user-friendly interface has enhanced navigation capabilities, allowing you to access and enjoy audio and video programming over the Internet. RealPlayer software is your gateway to a superb Internet multimedia experience.

Smart Capture

Sony Electronics Inc.

Smart Capture is a fun new way to send multimedia messages via e-mail. Smart Capture manages the i.LINK® connection between your notebook and a Sony Digital Handycam® Camcorder that supports the i.LINK interface. It allows you to capture compressed video or still images and save them to your hard disk drive or share via e-mail. A smart solution for computer, digital audio/video and network convergence.

Smart Connect (On selected models)

Sony Electronics Inc.

Smart Connect enables you to use an i.LINK® cable to connect your VAIO® computer to another VAIO computer that supports Smart Connect. You can then use one computer to copy, delete, and edit files on the other computer. You can also print from a printer attached to either computer.

SonicStage™

Sony Electronics Inc.

This new jukebox application adds a host of new features to its predecessor, OpenMG™ Jukebox. Continuing to take advantage of Sony's copyright-protected ATRAC3™ format for high-quality digital audio storage, SonicStage software sports a new music visualizer, a sleek new player skin design, audio CD burning capability, and a parametric equalizer for fine-tuning audio playback.

Sony ScreenBlast™ ACID (On selected models)

Sony Pictures Digital Entertainment

With the powerful Sony ScreenBlast ACID software you can create royalty-free music by utilizing its loop-based production tool, including unlimited tracks and enhanced effects.

Sony ScreenBlast™ Sound Forge (On selected models)

Sony Pictures Digital Entertainment

Sony ScreenBlast Sound Forge allows you to record, edit, and process mono or stereo audio files for your multimedia or Internet projects. Whether you want to use a number of professional effects, convert video into streaming media, or synchronize audio to video — this software has everything you need to create rich, immersive multimedia and Internet content.

Sony on Yahoo!

Yahoo! Inc.

Personalize your own web portal with Sony on Yahoo! Get a free webmail account, customized news and local weather reports, comics, instant messaging, and more.

VAIO Support Agent

Sony Electronics Inc.

VAIO Support Agent provides immediate, interactive, online support with information about your preinstalled software and answers to frequently asked questions.

VisualFlow™

Sony Electronics Inc.

VisualFlow software is a state-of-the-art Sony multimedia browser designed specifically for Memory Stick® media. It displays any still picture, movie or sound file stored in a Memory Stick media in a visually pleasing, artistic manner. VisualFlow software not only plays a selected movie or sound file, but also enables playback of files by other applications like PictureGear™ or Memory Stick Slideshow.

WinDVD®

InterVideo, Inc.

WinDVD software is a simple-to-use DVD player including all the features you would expect to find in a standard consumer DVD player, while also offering advanced display and navigation features such as zoom, pan, bookmark, and time search.

Software Support Information

Adobe® Acrobat® Reader®, Photoshop® Elements, Premiere® LE (Adobe Systems Inc.)

Web site	http://www.adobe.com/
e-mail	techdocs@adobe.com
phone	206-675-6126 (fee-based support)
fax	206-628-5737
hours	M-F, 6 AM-5 PM (PST)

America Online® (America Online, Inc.)

Web site	http://www.aol.com/
phone	800-827-6364
hours	7 days a week, 24 hours a day

Arcsoft PhotoPrinter® 2000 Pro (ArcSoft, Inc.)

Web site	http://www.arcsoft.com
e-mail	support@arcsoft.com
phone	510-440-9901
fax	510-440-1270
hours	M-F, 8:30 AM-5:30 PM (PST)

Drag'n Drop CD (DigiOn, Inc., and Easy Systems Japan Ltd.)

Web site	http://www.easy.co.jp/dde/sony/tosupportne.html
----------	---

EarthLink Network Total Access® (EarthLink, Inc.)

Web site	http://support.earthlink.net/
e-mail	support@earthlink.net
phone	800-890-5128 or 800-890-6356
hours	7 days a week, 24 hours a day

Change text in this variable definition to document title.

PC-Cillin® 2000 (Trend Micro, Inc.)

Web site	http://www.antivirus.com/pc-cillin/support/
phone	510-859-0308; 900-820-8324*
hours	M-F, 8 AM-5 PM (PST)

* Support from 510-859-0308 is free of charge, but subject to delays. Support from 900-820-8324 is fee-based, but offers immediate response.

Quicken® (Intuit Inc.)

Web site	http://www.intuit.com/support
phone	900-555-4932; 800-644-3193*
hours	M-F, 5 AM-5 PM (PST)

* Support from 900-555-4932 is fee-based. Support from 800-644-3193 is automated and free of charge.

QuickTime® (Apple Computer, Inc.)

Web site	http://www.apple.com
phone	800-275-2273
hours	M-F, 6 AM-6 PM (PST)

RealJukebox®, RealPlayer® (RealNetworks, Inc.)

Web site	http://service.real.com/rjoptions.html
e-mail	http://service.real.com/help/call.html (online email form)

Sony Applications (Sony Electronics Inc.)

Web site	http://www.sony.com/pcsupport
phone	888-4-SONY-PC (888-476-6972)*
hours	7 days a week, 24 hours a day

* Support from 1-888-4-SONY-PC is free of charge for 90 days after the original date of purchase.

Windows® Operating System, Word (Microsoft Corp.)

Web site <http://www.sony.com/pcsupport>

phone 888-4-SONY-PC (888-476-6972)*

hours 7 days a week, 24 hours a day

* Support from 1-888-4-SONY-PC is free of charge for 90 days after the original date of purchase.

WinDVD® (InterVideo, Inc.)

Web site <http://www.intervideo.com>

phone 510-651-0888

Sony Service Center

For the Sony Service Center nearest you, call 1-888-4-SONY-PC (1-888-476-6972) or find Sony Customer Service on the Web at <http://www.sony.com/pcsupport>.

Change text in this variable definition to document title.

Using the Recovery CDs

This section provides you with details on your Sony Application, Driver, and System Recovery CDs.

- ❑ Application, Driver, and System Recovery CDs
- ❑ Using Your Recovery CDs

Application, Driver, and System Recovery CDs

Your computer comes with the following Application Recovery, Driver Recovery, and System Recovery CDs. You will need an optical disc drive (supplied with selected models) to use these recovery CDs. If your computer does not come with an optical disc drive, use an external optical disc drive.

Application Recovery CD(s)

Sony Electronics Inc.

This CD enables you to reinstall individual applications and device drivers if they become corrupted or are erased.

Driver Recovery CD(s)

Sony Electronics Inc.

This CD enables you to reinstall individual device drivers if they become corrupted or are erased.

System Recovery CD(s)

Sony Electronics Inc.

This CD enables you to restore the operating system and software that shipped with your computer if they become corrupted or are erased. This CD restores your computer to its original factory settings, so user data and applications installed since you started using your computer will be lost.

 For models that come with a docking station, make sure you connect the docking station to the computer before using the recovery CDs.

Using Your Recovery CDs

The following sections describe how to use the Application Recovery and System Recovery utilities.

To use the Application Recovery CD(s)

The Application Recovery CD utility enables you to reinstall individual software applications, device drivers, and to repair software applications if they become corrupted or are erased. Reinstalling an individual software application or device driver may correct a problem you are experiencing with your computer, peripheral hardware, or software. You may not need to reinstall the entire contents of your hard drive. To reinstall all the software titles that shipped with your computer, use the System Recovery CD(s). See “To use the System Recovery CD(s)” for more information.

 You must be in Windows® to run the Application Recovery CD utility.

Reinstalling software applications with the Application Recovery CD(s)

- 1 Turn on your computer. If your computer is already on, close all open applications.
- 2 When the Windows desktop appears, insert Sony Application Recovery CD No. 1 into your computer’s optical disc drive. The Application Recovery utility loads automatically.
- 3 When the Application Recovery menu appears, select the icon for the application you want to restore, and then follow the on-screen instructions to complete the recovery process.

 Your system may include one or more Application Recovery CDs. If you have more than one Application Recovery CD, insert the first CD to run the Application Recovery program. You may be prompted to insert the next CD, depending on the application you wish to restore.

Reinstalling device drivers with the Application Recovery CD(s)

- 1 Turn on your computer. If your computer is already on, close all applications.
- 2 When the Windows desktop appears, insert Application Recovery CD No. 1 into the optical disc drive.

- 3 Click Start in the Windows taskbar and click Control Panel. The Control Panel window appears.
- 4 Click Performance and Maintenance and click System. The System Properties dialog box appears.
- 5 From the Hardware tab, click Device Manager.
- 6 Click to select the unknown device or the device that requires the driver installation. The unknown device(s) is identified by a yellow question mark.
- 7 From the Action menu, click Uninstall. This removes the device driver from your system. Click OK. Repeat for each device driver as necessary.
- 8 Restart your computer. Click Start in the Windows taskbar, select Turn Off Computer, and then click Restart.
- 9 When the desktop appears, Windows automatically reinstalls the device driver(s) from the Application Recovery CD.

 Your system includes one or more Application Recovery CDs. Insert Application Recovery CD No. 1, to start the application or driver recovery process. You are prompted to insert the next CD(s), depending on the software application or driver you wish to restore.

If you have any questions about using the Application Recovery CD(s), visit <http://www.sony.com/pcsupport>, or contact Sony Customer Support at 1-888-4-SONY-PC.

To use the Driver Recovery CD(s)

The Driver Recovery CD utility enables you to reinstall individual drivers if they become corrupted or are erased. You can reinstall an individual driver to correct a problem that you are experiencing with your computer, hardware, or software application. VAIO Support Agent, an application repair utility, uses a vault feature on the Driver Recovery CD(s) to repair software applications.

 If you need to reinstall all of the software applications that shipped with your computer, use the System Recovery CD.

You must be in Windows to run the Driver Recovery CD utility.

Reinstalling specific drivers with the Driver Recovery CD

- 1** Turn on your computer. If your computer is already on, close all applications.
- 2** When the Windows desktop appears, insert the Driver Recovery CD into the optical disc drive.
- 3** Click Start on the Windows taskbar, and click Control Panel. The Control Panel window appears.
- 4** Click Performance and Maintenance, then System. The System Properties dialog box appears.
- 5** From the Hardware tab, click Device Manager.
- 6** Click to highlight the device for which you wish to reinstall the driver.
- 7** From the Actions menu, select Properties. The Properties dialog box for that device appears.

Properties dialog box

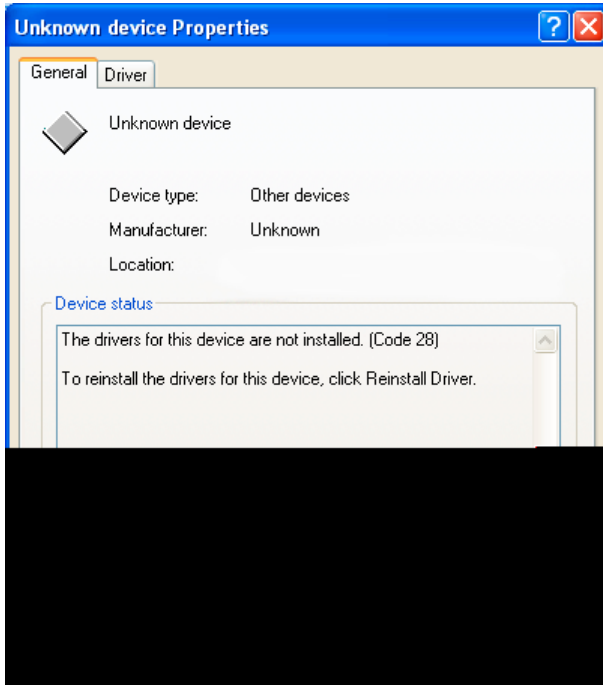

- 8 Click Reinstall Driver. The Hardware Update Wizard appears.
- 9 Click next. The wizard searches for the correct driver on your Driver Recovery CD.
- 10 When the recovery process is complete, click Finish. Some drivers require that you restart the computer to complete installation.

To use the System Recovery CD(s)

The System Recovery CD(s) enables you to format your hard disk drive and restores all original software applications. Your computer is returned to the original factory settings.



The System Recovery process removes all software that you may have installed since you started using your computer. Reinstall any applications that were not included with the computer when you purchased it.

You can use the System Recovery CD(s) to reinstall the operating system and software titles that shipped with your computer if they become corrupted or are erased. You may not need to reinstall the entire contents of your hard drive. If you experience a problem with your computer, reinstalling an individual device driver or software title may correct the problem. Use the Application Recovery CD(s) to reinstall individual applications and to reinstall device drivers. See “To use the Application Recovery CD(s)” for more information.

The System Recovery CD(s) contains a backup copy of all the software originally installed on your hard disk drive. It can be used only to recover the hard disk of the computer you purchased.

System Recovery options

- ❑ **System Drive Recovery** — All data on Drive C is deleted. The factory default settings and software applications are restored on this drive only.
- ❑ **Change Partition Size** — All partitions, custom installations, and changes are removed from the hard disk drive. You can set the partition sizes for both the Drive C and Drive D. The original, preinstalled operating system and software applications are restored.
- ❑ **Recovery to Original Factory Defaults** — All data and partitions are removed from the hard disk drive. All original factory settings, operating system, and preinstalled software is restored.



The System Recovery utility does not back up your system's data. If you wish to retain your system data, perform a backup to an external media.

Using the System Recovery CD(s)

Your system may take a few minutes to load necessary files. A blue screen appears during the downloading process.

- 1 Insert the Sony System Recovery CD in the optical disc drive. The System Recovery utility starts from the optical disc drive. The first CD must be in the drive when you turn on the computer.
- 2 Shut down your computer as described in the “Shutting Down Your Notebook” section of your supplied Quick Start.
- 3 Wait 30 seconds and turn on your computer.
- 4 The VAIO System Recovery Utility dialog box appears. Click Next.
- 5 At the pop-up prompt, select Yes to begin the system recovery process. Follow the on-screen instructions.

If your computer does not start from the Recovery CD

- 1 Press the power button and hold it for more than four seconds to turn off the computer.
- 2 Turn on the computer. When the Sony logo is displayed, press the F2 key. The BIOS setup menu screen appears.
- 3 Press the arrow keys to select the Exit menu.
- 4 Press the arrow keys to select “Get Default Values” and then press the Enter key. The message “Load default values for all SETUP items.” appears.
- 5 Make sure “Yes” is selected, and press the Enter key.
- 6 Press the arrow keys to select “Save and Exit,” and press the Enter key. The message “Save configuration changes and exit now?” appears.
- 7 Make sure “Yes” is selected, and press the Enter key. The computer restarts from the Recovery CD.

 Your system may include one or more System Recovery CDs. If you have more than one System Recovery CD, insert the first CD to run the System Recovery program. You are prompted to insert the second CD once the information from the first CD has been installed.

The recovery process takes from 30 to 60 minutes to complete.

After recovering your system using the System Recovery CD(s), you may be prompted to insert your Application Recovery CD(s) after restarting Windows. Insert the Application Recovery CD to automatically complete recovery of your system.

Troubleshooting

This section describes how to solve common problems you may encounter when using your notebook. Many problems have simple solutions, so try these suggestions before you visit the Sony Computing Support Web site at <http://www.sony.com/pcsupport>.

- ❑ Troubleshooting Your Notebook
- ❑ Troubleshooting the LCD Screen
- ❑ Troubleshooting the Mouse and Touchpad
- ❑ Troubleshooting Drives, PC Cards, and Peripheral Devices
- ❑ Troubleshooting Software
- ❑ Troubleshooting the Modem
- ❑ Troubleshooting Audio
- ❑ Troubleshooting the Printer
- ❑ Troubleshooting Wireless LAN

Troubleshooting Your Notebook

My notebook does not start.

- ❑ Check that the notebook is plugged into a power source and that it is turned on. Check that the power indicator on the front panel of the notebook indicates that the power is on.
- ❑ Check that the battery packs are inserted properly and that they are charged.
- ❑ If you have connected an external, optional floppy disk drive, make sure there is no floppy disk in the floppy disk drive.
- ❑ Confirm that the power cord and all cables are connected firmly, as described in the “Connecting a Power Source” section of the printed Quick Start.
- ❑ If you plugged the notebook into a power strip or Uninterruptible Power Supply (UPS), make sure the power strip or UPS is turned on and working.
- ❑ If you are using an external display, check that it is plugged into a power source and turned on. Check that the brightness and contrast controls are adjusted correctly. See the manual that came with the display for details.
- ❑ Condensation may cause the notebook to malfunction. If this occurs, do not use it for at least one hour.
- ❑ Take the battery pack out of the notebook, unplug the power cord, plug it in again, and then turn on the power.

My notebook starts but a BIOS error appears.

- ❑ When the internal backup battery is low on power, it may not start your system properly. The message, “Press <F1> to resume, <F2> to setup” appears at the bottom of the screen. Follow these steps:
 - 1 Press the F2 key. The BIOS Setup menu appears.
 - 2 Set the date (month/day/year). Press the Enter key.
 - 3 Press ↓ to select System Time, then set the time (hour: minute: second). Press the Enter key.
 - 4 Press → to select Exit, then press ↓ to select Get Default Values. The message “Load default values for all SETUP items” appears.
 - 5 Press the Enter key. The Setup Confirmation window appears.

- 6 Select Yes, and press the Enter key.
- 7 Select Exit (Save Changes), then press the Enter key. The Setup Confirmation window appears.
- 8 Select Yes, then press the Enter key. The notebook restarts.

 If this occurs on a regular basis, contact Sony Computing Support at the Web site <http://www.sony.com/pcsupport>.

My notebook starts, but the message “Operating system not found” appears and Windows does not start.

- If you have connected an external, optional floppy disk drive, make sure there is no floppy disk in the floppy disk drive (non-bootable).
- If a non-bootable floppy disk is in a connected floppy disk drive, follow these steps:
 - 1 Turn off the notebook, and then remove the floppy disk.
 - 2 Restart the notebook and confirm that Windows starts properly.
- If Windows still does not start, follow the steps below to start the BIOS:
 - 1 Turn off the notebook.
 - 2 Remove any peripheral devices connected to the notebook.
 - 3 Turn the notebook on again.
 - 4 Press the F2 key when the Sony logo appears. The BIOS setup menu screen appears.
 - 5 Set the date (month/day/year). Press the Enter key.
 - 6 Press ↓ to select System Time, then set the time (hour: minute: second). Press the Enter key.
 - 7 Press → to select Exit, then press ↓ to select Get Default Values. The message “Load default values for all SETUP items” appears.
 - 8 Press the Enter key. The Setup Confirmation window appears.
 - 9 Select Yes, and press the Enter key.
 - 10 Select Exit (Save Changes), then press the Enter key. The Setup Confirmation window appears.



- 2 Restart the notebook by pressing the Ctrl+Alt+Delete keys simultaneously and then selecting Restart from the drop-down list.

 If this procedure does not work, press and hold the power button for four seconds or longer to shut down the notebook.

The sound of my notebook's fan is too loud.

Use the PowerPanel utility to change the Thermal Control Strategy setting to Quiet. This setting slows down the CPU speed. See PowerPanel Help for more information.

Why does the System Properties dialog box display a slower CPU speed than advertised?

- Your computer uses speed-controlling technology. The System Properties dialog box may display the CPU's current speed rather than the maximum speed.

Troubleshooting the LCD Screen

My LCD screen is blank.

- Check that the notebook is plugged into a power source and that it is turned on.
- Check that the power indicator on the notebook is on.
- Check that the battery pack is inserted properly and that it is charged.
- The notebook may be in LCD (Video) Standby mode. Press any key to activate the screen.
- The display mode may be set to external display mode. Press and hold the Fn key while pressing the F7 key several times.

My LCD screen continues to show the previous screen.

Press the Windows key and the D key twice to refresh the screen.

The image on my connected external display is not centered or sized properly.

Use the controls on your external display to adjust the image. See the manual that came with your display for more information.

I want to change the video resolution of my display.

Follow this procedure to change the video resolution of your display.

- Click Start, point to Control Panel, and then click the Display icon.
The Display Properties dialog box appears.
- Click the Settings tab.
- Move the Screen Area slider to change your video resolution.

I cannot switch the LCD display to TV, and vice versa.

- Make sure that the TV is connected, configured and powered on correctly before starting the notebook. See “Selecting the Display Mode” in the online User Guide for more information.

Troubleshooting the Mouse and Touchpad

My mouse does not work.

- ❑ If you are using an external mouse, check that the mouse is plugged into the mouse connector. See “Connecting a PS/2 External Mouse or Keyboard” for more information.
- ❑ If you are using an optional Sony USB mouse PCGA-UMS1 series, check that the mouse is plugged into the USB port.
- ❑ If you are still experiencing problems, use your supplied Driver Recovery CD to reinstall the mouse drivers. See “To use the Driver Recovery CD(s)” for more information.

My touchpad does not work properly.

- ❑ You may have disabled the touchpad without connecting a mouse to the notebook. To enable the touchpad:
 - 1 Press the Windows key and use the arrow keys to select Programs, and then Sony Notebook Setup.
 - 2 Select the Touchpad tab using the arrow keys.
 - 3 Select Enable Touchpad, and then press the Enter key.
- ❑ You must restart the notebook to make the touchpad work again.
- ❑ If your touchpad is interpreting a single tap as a double-click, you must adjust the button assignments. Follow these steps:
 - 1

The pointer does not move while using the Touchpad or Mouse.

- ❑ The computer should be restarted. Follow these steps:
 - 1 Press the Windows key.
 - 2 Press the “U” key to select Turn Off Computer / Shut Down, and then wait at least four seconds.
 - 3 Press the “R” key to restart your computer.
- ❑ If you cannot turn off your notebook as described in the step above, press the Ctrl+Alt+Delete keys simultaneously, and then select Turn Off Computer / Shut Down on the Windows® dialog box. Wait at least four seconds, and then restart the computer.
- ❑ If you cannot restart your notebook as described in the step above, press and hold the power button for more than four seconds to turn off the notebook.
- ❑ If the pointer does not move while playing a disc, press the Ctrl+Alt+Delete keys simultaneously to stop playback and restart the notebook.
- ❑ If you are still experiencing problems, check that another mouse was not installed.
- ❑ You may need to use your supplied Driver Recovery CD to reinstall the touchpad or mouse drivers. See “To use the Driver Recovery CD(s)” for more information.

Troubleshooting Drives, PC Cards, and Peripheral Devices

I cannot establish a connection between two VAIO® computers when using an i.LINK* cable.

- 1 Disconnect the i.LINK cable from both computers and then reconnect it.
- 2 Wait for the computers to respond. If neither computer responds after a few moments, restart both computers.

 The computers may not recognize an i.LINK connection after returning from a power saving mode (Standby or Hibernate). If this happens, restart the computers to establish a connection.

My floppy disk drive (optional) cannot write to a floppy disk.

- Check that the optional, external floppy disk drive is properly connected to your notebook. See “Connecting an External Floppy Disk Drive” for more information.
- If the floppy disk is write-protected, disable the write-protect feature or use a floppy disk that is not write-protected.

My optical disc drive is not playing my CD or DVD properly.

- Check that the label of the disc is facing up.
- If the disc requires software, check that the software is installed according to the manufacturer’s instructions.
- A dirty or damaged disc may cause the notebook to stop responding while it tries to read the disc. If necessary, restart the notebook, remove the disc, and then check it for dirt or damage.
- If you see video but can not hear audio, check all of the following:

* i.LINK is a Sony trademark used to designate that a product contains an IEEE 1394 connection. The i.LINK connection may vary, depending on the software applications, operating system, and compatible i.LINK devices. All products with an i.LINK connector may not communicate with each other. Refer to the documentation that came with your compatible i.LINK device for information on operating conditions and proper connection. Before connecting compatible i.LINK PC peripherals to your system, such as a CD-RW or hard disk drive, confirm their operating system compatibility and required operating conditions.

- Check that your optical drive does not have the mute setting enabled.
- Check the volume setting in the audio mixer.
- If you are using external speakers, check the volume settings, and then check the connections between your external speakers and the notebook.

1 Click Start, Control Panel, System, and then Device Manager.
Check that the correct drivers are installed properly.

- Do not use adhesive labels to identify the CD. The label may come off while the disc is in use in the optical drive and cause the drive to malfunction.
- If a region code warning appears when you try to use your optical drive, it may be that the DVD you are trying to play is incompatible with the optical drive. Check the region code listing on the DVD packaging.
- Condensation may cause the notebook to malfunction. If this occurs, do not use it for at least one hour.

My optical drive tray does not open.

- Check that the notebook is turned on.
- Press the Eject button on the optical drive.
- If the Eject button does not work, open the tray by inserting a thin, pointed object (such as a paper clip) in the hole to the right of the Eject button.

I cannot use Digital Video (DV) devices. The message “DV equipment seems to be disconnected or turned off” appears.

- Check that the DV device is turned on and that the cables are properly connected.
- If you are using multiple i.LINK®* devices, the combination or order of the devices may be causing the problem. In this case, turn off your notebook and

* i.LINK is a Sony trademark used to designate that a product contains an IEEE 1394 connection. The i.LINK connection may vary, depending on the software applications, operating system, and compatible i.LINK devices. All products with an i.LINK connector may not communicate with each other. Refer to the documentation that came with your compatible i.LINK device for information on operating conditions and proper connection. Before connecting compatible i.LINK PC peripherals to your system, such as a CD-RW or hard disk drive, confirm their operating system compatibility and required operating conditions.

all connected devices. Disconnect the devices that are not in use. Check the connections for each device, and then restart your notebook.

My PC Card is not working.

- ❑ Check that the PC Card is installed properly.
- ❑ Check that the PC Card is compatible with Microsoft® Windows®.
- ❑ Use the Sony Notebook Setup utility to disable devices you are not currently using.
- ❑ If you are using two PC Cards, use the Sony Notebook Setup utility to disable the devices you are not currently using.
- ❑ Check that any necessary drivers were installed properly. See “Using Your Recovery CDs” for more information.

Troubleshooting Software

My software program stops responding or crashes.

Contact the software publisher or designated provider for technical support. Refer to “Application, Driver, and System Recovery CDs” for more information.

When I click an application icon, the message “You must insert the application CD into your optical drive” appears and the software does not start.

- ❑ Some titles require specific files that are located on the application CD. Insert the disc and try starting the program again.
- ❑ Make sure you place the CD in the tray with the label side facing up.

What software do I use for CD-R/CD-RW software functions?

- ❑ Sony recommends using the preinstalled SonicStage software’s Record function to create any CDs on your VAIO® computer, if the specific model you purchased is preconfigured with all necessary components for CD-R and CD-RW capability. Downloading the optional RealJukebox CD-burning component to create any CDs on your computer may interfere with normal system operations.

Why is my computer operating improperly after downloading the CD-burning feature of RealJukebox® software?

Sony does not guarantee the performance of the “Create CD” feature that is provided by the software, RealJukebox2 Basic for Sony. Some CD-ROM drives or drivers may experience problems when using this feature. For more information about this issue, visit the RealNetworks Service and Support Web site at <http://service.real.com>.

I cannot use the DVgate™ software.

- ❑ If your notebook is using the Ultimate Battery Life profile for its power saving mode, you cannot use DVgate or Smart Connect software. Please select another profile. Preferably, connect your notebook to AC power when using these features.

Troubleshooting the Modem

My modem does not work.

- ❑ Check that the phone line is plugged into the line jack. See “Connecting a Phone Line” in the online User Guide for more information.
- ❑ Check that the phone line is working. You can check the line by plugging in an ordinary phone and listening for a dial tone.
- ❑ Check that the phone number the program is dialing is correct.
- ❑ Check that the software you are using is compatible with the notebook’s modem. (All preinstalled Sony programs are compatible.)
- ❑ If you are still experiencing problems, use your supplied Driver Recovery CD to reinstall the modem drivers. See “To use the Driver Recovery CD(s)” for more information.

My modem connection is slow.

Your notebook is equipped with a V.90 compatible modem. Many factors may influence modem connection speed, including telephone line noise or compatibility with telephone equipment (such as fax machines or other modems). If you think your modem is not connecting properly to other PC-based modems, fax machines, or your Internet Service Provider (ISP), check the following:

- ❑ Ask your phone company to check that your phone line is free from any line noise.
- ❑ If your problem is fax-related, check that there are no problems with the fax machine you are calling and that it is compatible with fax modems.
- ❑ If you are having a problem connecting with your Internet Service Provider, check that the ISP is not experiencing technical problems.
- ❑ If you have a second phone line available, try connecting the modem to that line.

Troubleshooting Audio

My speakers make no sound.

- ❑ If the built-in speakers are turned off, press the Fn+F3 keys simultaneously to turn on the speakers. You can also turn on the speakers using the center Jog Dial™ control.
- ❑ If the speaker volume is turned to the minimum, press the Fn+F4 keys simultaneously, and then press **↑** or **→** to increase the volume or you can use the center Jog Dial™ control to adjust the volume.
- ❑ If nothing is displayed when you press the Fn+F3 or Fn+F4 keys simultaneously, then do the following:
 - 1** Click Start on the Windows® taskbar, then Control Panel, and then Sounds, Speech, and Audio Devices.
 - 2** Click Sounds and Audio Devices. The Sounds and Audio Devices Properties dialog box appears.
 - 3** Make sure the Volume tab is open and the Mute check box is not selected.
- ❑ If your notebook is powered by batteries, check that the battery packs are inserted properly and that they are charged.
- ❑ If you are using an application that has its own volume control, check that the volume is turned up.
- ❑ Check the volume controls in the Windows® taskbar.
- ❑ If you connect external speakers, check that the speakers are properly connected and the volume is turned up. If the speakers have a mute button, make sure it is off. If the speakers are powered by batteries, check that the batteries are inserted properly and that they are charged.
- ❑ If you have connected an audio cable to the Headphone jack, disconnect the cable.
- ❑ If you are still experiencing problems, use the supplied Driver Recovery CD to reinstall the drivers. See “To use the Driver Recovery CD(s)” for more information.

My microphone does not work.

If you are using an external microphone, check that the microphone is plugged into the Microphone jack. See “Connecting an External Microphone” for more information.

Troubleshooting the Printer

I cannot print.

- ❑ Make sure the power to the printer is on, and the printer cable is securely connected to both the printer and your notebook.
- ❑ The default setting for the printer port mode is correct for most printers. If you cannot print, try changing the printer port mode.
 - 1 Click Start on the Windows task bar, and then Control Panel.
 - 2 Click Performance and Maintenance, then System. Select the Hardware tab, and click Device Manager.
 - 3 Double-click Ports (COM&LPT), and then ECP Printer Port (LPT1). Select the Port Settings tab, and choose a different LPT Port Number.
- ❑ Your connected printer may not function after the notebook resumes from a power saving mode. If this occurs, follow these steps to reset the printer connection:
 - 1 Click Start and then Control Panel.
 - 2 Click Printers and other Hardware, and then Printers and Faxes.
 - 3 Right-click the icon of the printer that is not functioning, and then select Properties to open the Properties window.
 - 4 Click OK to close the Properties window. The printer should now function properly.

Troubleshooting Wireless LAN

The computer cannot connect to a Wireless LAN Access Point.

- Make sure the Wireless LAN PC card is properly installed in the PC card slot on the left side of the notebook.
- Make sure power to the access point is turned on.
- Make sure the access point is displayed in the Available networks window. Do the following:
 - 1 Click Start, and then Control Panel.
 - 2 Click Network and Internet Connections, and then Network Connections.
 - 3 Double-click the Wireless Network Connection icon. The Wireless Network Connection Status window appears with the General tab open.
 - 4 Click Properties. The Wireless Network Connection Properties window appears.
 - 5 Click the Wireless Networks tab, and make sure the access point is displayed in the Available Networks box.
- The communication distance may drop due to:
 - obstacles between the notebook and the access point
 - signal conditions
 - surrounding environment, such as walls
 - software used
 - operating system used
 - arrangement of the machines

If this occurs, change the location of your notebook or shorten the distance between the notebook and the access point.

I cannot access the Internet.

- Make sure the Wireless LAN PC card is properly inserted into the PC card slot on the left of the notebook.
- Check if your notebook and the access point are connected to one another.

Change text in this variable definition to document title.

- ❑ Check the access point settings. Refer to the instructions supplied with the access point.
- ❑ Move your notebook away from obstructions or closer to any access point you may be using.

The data transfer speed is slow.

- ❑ The Wireless LAN data transfer speed is affected by distance and obstructions between devices and access points. Other factors include device configurations, radio conditions, and software compatibility. To maximize the data transfer speed, move your notebook away from obstructions or closer to any Access Point you may be using.
- ❑ If you are using a Wireless LAN Access Point, the device may be temporarily overloaded depending on the number of other devices communicating via the access point.
- ❑ If your access point interferes with other access points, set up the wireless channel with the access point. Refer to the instructions supplied with the access point.

The communication speed is interrupted or slowed down when MPEG2 data is transferred.

The typical effective data transfer speed via an access point is 4-5 Mbps when adhering to the IEEE 802.11b standard. High-rate stream transfers with MPEG2 data may lower this rate.

Data transfers are interrupted.

Data transfer interruptions may occur with large files. Check if the access point connection is intact, see “Checking your connection status” and then do the following:

- 1 Right-click the Wireless Network Connection icon in the taskbar and select Status. The Wireless Network Connection Status dialog box appears.
- 2 Check the connection status.
- 3 Change the settings temporarily by performing the following actions:
 - 1 Click Start, and then Control Panel.

- 2 Click Network and Internet Connections, then Network Connections.
- 3 Right-click Wireless Network Connection and select Properties. The Wireless Network Connection Properties dialog box appears.
- 4 Select the Wireless Networks tab.
- 5 Click the “Use Windows to configure my wireless network settings” check box to deselect it.
- 6 Click OK.
- 7 Resume or restart the file transfer.
- 8 When the file transfer is completed, repeat the steps above to reselect the “Use Windows to configure my wireless network settings” check box.

Change text in this variable definition to document title.

Getting Help

Sony provides you with several support resources to answer questions about your VAIO® computer or the preinstalled software. Refer to these resources in the order they are listed.

Support Options

If you have questions about your computer or the preinstalled software, refer to the following sources for answers in the sequence listed below.

1 VAIO® Computer User Guide

The online VAIO® Computer User Guide and the printed VAIO® Computer Quick Start provide you with information on how to maximize your computer capabilities and solve common problems.

2 Software Manuals and Online Help Files

The software preinstalled on your computer may come with an online manual. These manuals are stored on the hard disk drive as online Help files. You can find the Help files from the Help menu under the specific software application. Some software applications may come with a printed manual.

3 Operating System Online Support

Your computer comes preinstalled with Microsoft® Windows®. For operating system support, you can access Microsoft® customer support at: <http://support.microsoft.com/directory/>.

4 VAIO Support Agent

You can find VAIO Support Agent by clicking Start and selecting Help and Support. Using advanced diagnostic technology, Sony's VAIO Support Agent runs scheduled protections of your applications, network settings, and other important software settings. When your software is protected, you can use VAIO Support Agent to repair software problems by restoring your software to any of the previously protected states.

5 Sony Computing Support

This service provides instant access to information on commonly encountered problems. Enter a description of your problem and the Knowledge Database searches for the corresponding solutions online. You can access Sony Computing Support at:
<http://www.sony.com/pcsupport>.

6 Sony Fax-on-Demand

This service, which requires a fax machine or your fax software, provides answers to commonly asked questions. You can use this automated service to request a list of available topics, and select the topics that you want to receive. To contact the Sony fax-on-demand service, call: 1-888-4-SONY-PC (1-888-476-6972).

7 Sony Customer Support

Sony and Microsoft software support is available free of charge for 90 days after the original date of purchase. You can call and speak with a Sony Customer Support Representative without using your computer by calling: 1-888-4-SONY-PC (1-888-476-6972).

8 Sony Service Center

For the Sony Service Center nearest you, call 1-888-4-SONY-PC (1-888-476-6972) or find Sony Customer Service on the Web at <http://www.sony.com/pcsupport>.

Index

A

- About This Computer tab 85
- AC Profile power setting 87
- Access Point, Wireless LAN 81
- adding
 - hardware 53
 - memory 99
 - peripherals 53
 - printers 68–69
- Alt key 13
- Application Recovery CD 121
- Applications key 13
- audio
 - connecting 62
 - connecting external speakers 79
 - external microphone 80
 - troubleshooting 142
- Audio tab 85
- audio-video (AV)
 - connecting 64

B

- Basic/Advanced tab 85
- Battery Information toolbar 90
- battery pack
 - Battery Information toolbar 90
 - power management settings 86
 - power saving modes 42
 - using a second 37
- battery packs
 - charge status icons 91
 - charging 38
 - indicator lights 15, 37

- removing 37, 39
- brightness
 - adjusting 16
- built-in speakers
 - See also speakers 16
- buttons
 - Eject 25

C

- cameras
 - digital video recorder 76
- canceling commands 13
- Caps Lock
 - indicator light 16
- CD/DVD discs
 - ejecting 26
 - inserting 25
- CD-R software 140
- CD-RW software 140
- CD-RW/DVD Combo Drive or DVD-ROM drive 25
- charging battery packs 38
- coin-operated telephones 44
- computer
 - connecting to another 78
 - customizing 83
 - expanding capabilities of 81
 - online support 149
 - setup screen 84
 - troubleshooting 130
- connecting
 - another computer 78
 - audio device 62

- coin-operated telephones 44
- digital video recorder 76
- external speakers 79
- floppy disk drive 54
- hard drives 30
- i.LINK device 76
- Local Area Network (LAN) 45
- microphone 80
- monitor 70
- multimedia computer display 71
- multiple phone lines 44
- network 30
- party phone lines 44
- PBX 44
- phone line 44
- port replicator 57
- printer 68–69
- projector 72
- PS/2 keyboard 61
- PS/2 mouse 61
- TV/VCR 64
- USB device 74
- weight saver 40

correction keys 13

Ctrl key 13

cursor-movement keys 13

customizing your computer 83

D

- digital video camera 76
- disconnecting port replicator 59
- display
 - mode 93
 - options 73
 - selecting 73
- Driver Recovery CD 122
- drives
 - floppy disk 54, 137
 - installing additional hard disk 30
 - optical 25

- DV In/Out 76

E

- Eject button 25, 26, 55
- ejecting
 - battery packs 39
 - CD/DVD discs 26
 - floppy disks 55
 - weight saver 41
- Escape key 13
- expanding your notebook capabilities 81
- expansion memory configuration 101
- external devices
 - display 73
 - display, see also monitor 70
 - speakers 16, 79
- external display
 - connecting 70

F

- floppy disk drive 137
 - connecting 54
 - disconnecting 56, 59
 - troubleshooting 137
- floppy disks
 - ejecting 55
 - handling 56
- Fn key 13
 - combination commands 16
- function keys 13

G

- getting help 149
- Guide Mode 23

H

- handling
 - floppy disks 56
- hard drives
 - indicator light 15
 - installing additional 30

help 149

Hibernate mode 17, 42

I

i.LINK 76

connecting 76

VAIO Action Setup 20

IEEE 1394 76

indicator lights 15

battery 15, 37

Caps Lock 16

hard disk 15

Num Lock 16

Scroll Lock 16

indicators 15–16

Insert key 13

installing

hard drives 30

hardware 53

memory module 104

peripherals 53

J

Jog Dial control

using 21

VAIO Action Setup 20

K

keyboard

key combinations 14, 16

PS/2 61

using 12

L

LAN

see Local Area Network

Launcher Mode 22

LCD

selecting to display output 73

troubleshooting 134

Local Area Network

connecting 45

M

MagicGate 32

Maximum Battery Life power setting
87

Maximum Performance power setting
87

memory

adding 99

memory module

expansion 101

installing 104

removing 102

Memory Stick

using 32

VAIO Action Setup 20

Memory Stick media 32

displaying contents 33

inserting 33

microphone

connecting 80

troubleshooting 142, 143

modem

troubleshooting 141

monitor

connecting 70

selecting 73

switching among 17

mouse

PS/2 61

troubleshooting 135

Mouse Properties 19

multimedia

audio device 62

multimedia computer display 71

multiple phone lines 44

N

navigation keys 13

network

- connecting 30
- Notebook
 - online support 149
 - troubleshooting 130
- Notebook Setup tabs 85
- Num Lock
 - indicator light 16

O

- online support 149
- operator keys 13
- optical disc drive
 - closing tray 26
 - opening tray 25
- optical discs
 - ejecting 26
- optical drive
 - tray 138
 - troubleshooting 137, 138
 - using 25
- output devices
 - adding ??-69

P

- party phone lines 44
- PBX 44
- PC Card
 - inserting 30
 - troubleshooting 137, 139
 - using 30
 - Wireless LAN Access Point 81
- PDA 81
- peripheral device
 - TV/VCR 65
- peripheral devices
 - troubleshooting 137
- Personal Digital Assistant 81
- phone
 - connecting line 44
- port replicator

- connecting 57
- disconnecting 59
- lever 59
- ports
 - printer 68-69
 - Serial port 57
- power 15
- power management
 - settings 86
- Power Management Off power setting 87
- Power On
 - Password tab 85
- power saving modes 42
 - Hibernate 17, 42
 - Normal mode 42
 - notes 43
 - Standby 42
- power setting
 - AC Profile 87
 - Maximum Battery Life 87
 - Maximum Performance 87
 - Power Management Off 87
 - Standby 89
- PowerPanel
 - customizing toolbar 87, 89
- Print Screen key 13
- printer
 - connecting 68-69
 - port 68-69
 - troubleshooting 144
- Printer tab 85
- projector 72
- PS/2 mouse or keyboard 61

R

- Recovery CDs 121
- removing
 - floppy disk drive 56, 59
 - floppy disks 55

- memory module 102
- replacing
 - battery packs 37
- restoring data 121
- S**
- Scroll Lock
 - indicator light 16
- Search window 14
- second battery pack 37
 - using 37
- selecting
 - display 73
 - LCD 73
 - monitor 73
- Serial port 57
- setup screen
 - About This Computer tab 85
 - Audio tab 85
 - Basic/Advanced tab 85
 - displaying 84
 - Power On Password tab 85
 - Printer tab 85
 - Touchpad tab 85
- setup tabs 85
- Shift key 13
- Smart Connect 78
- software
 - changing window design 95
 - Smart Connect 78
 - support information 115
 - troubleshooting 140
- Software list 107
- Sony Fax-on-Demand 150
- Sony Notebook Setup screen 84
- Sony Service Center 117
- speakers
 - external 79
 - switching 16
 - troubleshooting 142
- volume 16
- Standby mode 42, 89
- support
 - software 115
- support, Sony 149
- switching
 - display 17
 - monitor 17
- System Recovery CD 124
- T**
- technical support 149
- touchpad 18
 - troubleshooting 135
- Touchpad tab 85
- troubleshooting 129, 130
 - audio 142
 - drives, PC Cards, and peripheral devices 137
 - LCD 134
 - modem 141
 - mouse and touchpad 135
 - printer 144
 - software 140
- TV or a video deck 65, 66
- TV or video deck 64
- TV/VCR 64
- U**
- USB
 - connecting 74
 - mouse 74
 - port 74
- using 18
 - Jog Dial control 21
 - keyboard 12
 - Memory Stick 32
 - optical drive 25
 - second battery pack 37
 - touchpad 18

weight saver 40
using PC Card 30
Using the Jog Dial Control 24
V
VAIO
 help 14
VAIO Action Setup 20
video camera 76
viewing the amount of memory 105
volume control 16

W

weight saver
 attaching 37
 connecting 40
 removing 41
 using 40
window design of Sony software 93
Windows
 Explorer 14
 key 13
 key combinations 14
 taskbar 132
Wireless LAN 46
Wireless LAN Access Point 81

Change text in this variable definition to document title.

Change text in this variable definition to document title.

Change text in this variable definition to document title.

Free Manuals Download Website

<http://myh66.com>

<http://usermanuals.us>

<http://www.somanuals.com>

<http://www.4manuals.cc>

<http://www.manual-lib.com>

<http://www.404manual.com>

<http://www.luxmanual.com>

<http://aubethermostatmanual.com>

Golf course search by state

<http://golfingnear.com>

Email search by domain

<http://emailbydomain.com>

Auto manuals search

<http://auto.somanuals.com>

TV manuals search

<http://tv.somanuals.com>