

SONY®

VAIO® Notebook Computer User Guide

PCG-838



Notice to Users

© 1999 Sony Electronics Inc. All rights reserved. This manual and the software described herein, in whole or in part, may not be reproduced, translated, or reduced to any machine-readable form without prior written approval.

SONY ELECTRONICS INC. PROVIDES NO WARRANTY WITH REGARD TO THIS MANUAL, THE SOFTWARE, OR OTHER INFORMATION CONTAINED HEREIN AND HEREBY EXPRESSLY DISCLAIMS ANY IMPLIED WARRANTIES OF MERCHANTABILITY OR FITNESS FOR ANY PARTICULAR PURPOSE WITH REGARD TO THIS MANUAL, THE SOFTWARE, OR SUCH OTHER INFORMATION. IN NO EVENT SHALL SONY ELECTRONICS INC. BE LIABLE FOR ANY INCIDENTAL, CONSEQUENTIAL, OR SPECIAL DAMAGES, WHETHER BASED ON TORT, CONTRACT, OR OTHERWISE, ARISING OUT OF OR IN CONNECTION WITH THIS MANUAL, THE SOFTWARE, OR OTHER INFORMATION CONTAINED HEREIN OR THE USE THEREOF.

Sony Electronics Inc. reserves the right to make any modification to this manual or the information contained herein at any time without notice. The software described herein is governed by the terms of a separate user license agreement.

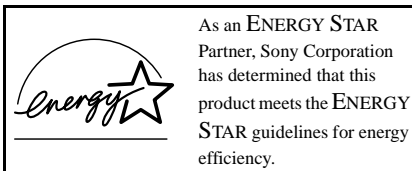

The International ENERGY STAR Office Equipment Program is an international program that promotes energy saving through the use of computers and other office equipment. The program backs the development and dissemination of products with functions that effectively

reduce energy consumption. It is an open system in which business proprietors can participate voluntarily. The targeted products are office equipment such as computers, displays, printers, facsimiles and copiers. Their standards and logos are uniform among participating nations. ENERGY STAR is a U.S. registered mark.

This product contains software owned by Sony and licensed by third parties. Use of such software is subject to the terms and conditions of license agreements enclosed with this product. Some of the software may not be transported or used outside the United States. Software specifications are subject to change without notice and may not necessarily be identical to current retail versions.

Updates and additions to software may require an additional charge. Subscriptions to online service providers may require a fee and credit card information. Financial services may require prior arrangements with participating financial institutions.

Sony, i.LINK, VAIO and the VAIO logo are trademarks of Sony Corporation. Windows, Windows NT, and the Windows 98 logo are registered trademarks of Microsoft Corporation. Intel, MMX, and Pentium are trademarks of Intel Corporation.

All other trademarks are trademarks of their respective owners.

Safety Information

Owner's Record

The model number and serial number are located on the bottom of your Sony VAIO Notebook Computer. Record the serial number in the space provided here. Refer to the model and serial number when you call your Sony Service Center.

Model Number: PCG-838

Serial Number: _____

WARNING

- To prevent fire or shock hazard, do not expose your notebook computer to rain or moisture.
- To avoid electrical shock, do not open the cabinet. Refer servicing to qualified personnel only.
- Never install modem or telephone wiring during a lightning storm.
- Never install telephone jacks in wet locations unless the jack is specifically designed for wet locations.
- Never touch uninsulated telephone wire or terminals unless the telephone line has been disconnected at the network interface.
- Use caution when installing or modifying telephone lines.
- Avoid using the modem during an electrical storm.
- Do not use the modem or a telephone to report a gas leak in the vicinity of the leak.
- A socket outlet should be as close as possible to the unit and easily accessible.

! The laser beam used in the DVD-ROM drive unit is harmful to the eyes. Do not attempt to disassemble the cabinet. Refer servicing to qualified personnel only.

AVERTISSEMENT

- Pour prévenir tout risque d'incendie ou d'électrocution, garder cet appareil à l'abri de la pluie et de l'humidité.
- Pour prévenir tout risque d'électrocution, ne pas ouvrir le châssis de cet appareil et ne confier son entretien qu'à une personne qualifiée.
- L'appareil doit être le plus près possible d'une prise murale pour en faciliter l'accès.

Regulatory Information

Declaration of Conformity

Trade Name: SONY

Model No: PCG-838

Responsible Party:
Sony Electronics Inc.

Address:
1 Sony Drive
Park Ridge, NJ 07656

Telephone No.: 201-930-6970

This device complies with Part 15 of the FCC rules. Operation is subject to the following two conditions: (1) This device may not cause harmful interference, and (2) this device must accept any interference received, including interference that may cause undesired operation.

This equipment has been tested and found to comply with the limits for a Class B digital device, pursuant to Part 15 of the Rules. These limits are designed to provide reasonable protection against harmful interference in a residential installation. This equipment generates, uses, and can radiate radio frequency energy and, if not installed and used in accordance with the instructions, may cause harmful interference to radio communications.

However, there is no guarantee that interference will not occur in a particular installation. If this equipment does cause harmful interference to radio or television reception, which can be determined by turning the equipment off and on, the user is encouraged to try to correct the interference by one or more of the following measures:

- ❑ Reorient or relocate the receiving antenna.
- ❑ Increase the separation between the equipment and the receiver.
- ❑ Connect the equipment into an outlet on a circuit different from that to which the receiver is connected.
- ❑ Consult the dealer or an experienced radio/TV technician for help.

You are cautioned that any changes or modifications not expressly approved in this manual could void your authority to operate this equipment.

Only peripherals (computer input/output devices, terminals, printers, etc.) that comply with FCC Class B limits may be attached to this computer product. Operation with non-compliant peripherals is likely to result in interference to radio and television reception.

All cables used to connect peripherals must be shielded and grounded. Operation with cables, connected to peripherals, that are not shielded and grounded, may result in interference to radio and television reception.

FCC Part 68

This equipment complies with Part 68 of the FCC rules. On the bottom of this equipment is a label that contains, among other information, the FCC equivalence number (REN) for this equipment. If requested, this information must be provided to the telephone company.

This modem uses the USOC RJ-11 telephone jack.

The REN is used to determine the quantity of devices which may be connected to the telephone line. Excessive RENs on the telephone line may result in the devices not ringing in response to an incoming call. In most, but not all areas, the sum of the RENs should not exceed five (5.0). To be certain of the number of devices that may be connected to the line, as determined by the total RENs, contact the telephone company to determine the maximum REN for the calling area.

If the terminal equipment (Notebook Computer PCG-838) causes harm to the telephone network, the telephone company will notify you in advance that temporary discontinuance of service may be required. But if advance notice is not practical, the telephone company will notify the customer as soon as possible. Also, you will be advised of your right to file a complaint with the FCC if you believe it is necessary.

The telephone company may make changes in its facilities, equipment, operations or procedures that could affect the operations of the equipment. If this happens, the telephone company will provide advance notice in order for you to make the necessary modifications in order to maintain uninterrupted service.

If trouble is experienced with this equipment (Notebook Computer PCG-838), please contact 1-888-4SONYPC (1-888-476-6972), or write to the Sony Customer Information Center, One Sony Drive, Park Ridge, NJ 07656 for repair and/or warranty information. If the trouble is causing harm to the telephone network, the telephone company may request that you remove the equipment from the network until the problem is resolved.

Repair of this equipment should be made only by a Sony Service Center or Sony authorized agent. For the Sony Service Center nearest you, call 1-888-4SONYPC (1-888-476-6972).

This equipment cannot be used on public coin service provided by the telephone company. Connection to Party Line Service is subject to state and possible provincial tariffs. (Contact the state or provincial utility service commission, public service commission or corporation commission for information.)

Telephone Consumer Protection Act of 1991 (United States)

The Telephone Consumer Protection Act of 1991 makes it unlawful for any person to use a computer or other electronic device to send any message via a telephone facsimile machine unless such message clearly contains, in a margin at the top or bottom of each transmitted page or on the first page of the transmission, the date and time it is sent and an identification of the business, other entity, or individual sending the message, and the telephone number of the sending machine or such business, other entity, or individual.

In order to program this information into your facsimile machine, see your fax software documentation.

Telephone Consumer Guidelines (Canada)

Please refer to your telephone directory under 'Privacy Issues' and/or 'Terms of Service'. For more detailed information please contact:

CRTC

Terrasses de la Chaudière, Tour centrale
1 promenade du Portage, 5 étage
Hull PQ K1A 0N2.

This Class B digital apparatus complies with Canadian ICES-003.

Cet appareil numérique de la classe B est conforme à la norme NMB-003 du Canada.

DISPOSAL OF LITHIUM ION BATTERY

You can return your unwanted lithium ion batteries to your nearest Sony Service Center or Factory Service Center.



In some areas the disposal of lithium ion batteries in household or business trash may be prohibited.

For the Sony Service Center nearest you call 1-888-476-6972 in the United States or 1-800-961-7669 in Canada.

! Do not handle damaged or leaking lithium ion batteries.

! Ne pas manipuler les batteries au lithium-ion qui fuient ou sont endommagées.

! Danger of explosion if battery is incorrectly replaced. Replace only with the same or equivalent type recommended by the manufacturer. Discard used batteries according to the manufacturer's instructions.

! Une batterie non conforme présente un danger d'explosion. La remplacer seulement par une batterie identique ou de type équivalent recommandé par le fabricant. Évacuer les batteries usées selon les directives du fabricant.

! The battery pack used in this device may present a fire or chemical burn hazard if mistreated. Do not disassemble, heat above 212°F (100°C) or incinerate. Dispose of used battery promptly. Keep away from children.

! La manutention incorrecte du module de batterie de cet appareil présente un risque d'incendie ou de brûlures chimiques. Ne pas démonter, incinérer ou exposer à une température de plus de 100°C. Évacuer promptement la batterie usée. Garder hors de portée des enfants.

INDUSTRY CANADA NOTICE

NOTICE: The Industry Canada label identifies certified equipment. This certification means that the equipment meets certain telecommunications network protective, operational and safety requirements as prescribed in the appropriate Terminal Equipment Technical Requirements document(s). The Department does not guarantee the equipment will operate to the user's satisfaction.

Before installing this equipment, users should ensure that it is permissible to be connected to the facilities of the local telecommunications company. The equipment must also be installed using an acceptable method of connection.

The customer should be aware that compliance with the above conditions may not prevent degradation of service in some situations.

Repairs to certified equipment should be coordinated by a representative designated by the supplier. Equipment malfunctions or any repairs or alterations made by the user to this equipment may give the

telecommunications company cause to request that the user disconnect the equipment.

Users should ensure for their own protection that the electrical ground connections of the power utility, telephone lines and internal metallic water pipe system, if present, are connected together. This precaution may be particularly important in rural areas.

Caution: Users should not attempt to make such connections themselves, but should contact the appropriate electric inspection authority, or electrician, as appropriate.

NOTICE: The Ringer Equivalence Number (REN) assigned to each terminal device provides an indication of the maximum number of terminals allowed to be connected to a telephone interface. The termination on an interface may consist of any combination of devices subject only to the requirement that the sum of the Ringer Equivalence Numbers of all the devices does not exceed 5. The Ringer Equivalence Number for this equipment is 0.3.

AVIS DE L'INDUSTRIE CANADA

AVIS: L'étiquette d'Industrie Canada identifie le matériel homologué.

Cette étiquette certifie que le matériel est conforme aux normes de protection, d'exploitation et de sécurité des réseaux de télécommunications, comme le prescrivent les documents concernant les exigences techniques relatives au matériel terminal. Le Ministère n'assume toutefois pas que le matériel fonctionnera à la satisfaction de l'utilisateur.

Avant d'installer ce matériel, l'utilisateur doit s'assurer qu'il est permis de le raccorder aux installations de l'entreprise locale de télécommunication. Le matériel doit également être installé en suivant une méthode acceptée de raccordement. L'abonné ne doit pas oublier qu'il est

possible que la conformité aux conditions énoncées ci-dessus n'empêche pas la dégradation du service dans certaines situations.

Les réparations de matériel homologué doivent être coordonnées par un représentant désigné par le fournisseur. L'entreprise de télécommunications peut demander à l'utilisateur de débrancher un appareil à la suite de réparations ou de modifications effectuées par l'utilisateur ou à cause de mauvais fonctionnement.

Pour sa propre protection, l'utilisateur doit s'assurer que tous les fils de mise à la terre de la source d'énergie électrique, des lignes téléphoniques et des canalisations d'eau métalliques, s'il y en a, sont raccordés ensemble. Cette précaution est particulièrement importante dans les régions rurales.

Avertissement: L'utilisateur ne doit pas tenter de faire ces raccordements lui-même; il doit avoir recours à un service d'inspection des installations électriques, ou à un électricien, selon le cas.

AVIS: L'indice d'équivalence de la sonnerie (IES) assigné à chaque dispositif terminal indique le nombre maximal de terminaux qui peuvent être raccordés à une interface.

La terminaison d'une interface téléphonique peut consister en une combinaison de quelques dispositifs, à la seule condition que la somme d'indices d'équivalence de la sonnerie de tous les dispositifs n'excède pas 5.

Contents

Welcome

Ergonomic Considerations	2
--------------------------------	---

Using Your Notebook Computer

Locating the Controls and Connectors	5
Connecting a Power Source	8
Starting Your Computer	12
Shutting Down Your Computer	13
Registering Windows® 98.....	14
Registering Your Computer	15
Using the Keyboard.....	16
Using the Touchpad	22
Using the Floppy Disk Drive	23
Using the DVD-ROM Drive	26
Using the Headphone with Remote Control	30
Using PC Cards	33
Using Infrared Communication Devices.....	36
Using Power Saving Modes	38
Using a Second Battery Pack.....	40
Using the Weight Saver	42

Connecting Peripheral Devices

Connecting a Phone Line.....	44
Connecting the Docking Station.....	45
Connecting a Printer.....	53
Connecting an External Display	54

Connecting an External Mouse or Keyboard	57
Connecting External Speakers.....	58
Connecting an External Microphone.....	59
Connecting a Digital Still Camera or Other Serial Device	60
Connecting a Digital Video Camera Recorder.....	61
Connecting a Universal Serial Bus (USB) Device	62

Customizing Your Notebook Computer

Displaying the Sony Notebook Setup Screen.....	63
Controlling Power Management.....	66
Displaying Battery Information	70
Selecting the Display Mode	73
Using the Dual Display Function.....	77

Getting Help

Troubleshooting	81
Using the System and Application Recovery CDs.....	88

Notes on Use

Adding Memory.....	96
--------------------	----

Limited Warranty Statement

Index..... 105

Welcome

Congratulations on your purchase of the Sony VAIO Notebook Computer. Sony has combined leading-edge technology in audio, video, computing, and communications to provide you with state-of-the-art personal computing.

About the User Guide

The User Guide offers a quick introduction and reference to your Sony Notebook computer.

- ❑ **Using Your VAIO® Notebook Computer** shows you how to use the standard components of your system.
- ❑ **Connecting Peripheral Devices** explains how you can add functionality by connecting various peripherals.
- ❑ **Getting Help** explains the support options available to you and offers basic troubleshooting tips.
- ❑ **Notes on Use** provides facts and advice about using your notebook computer.
- ❑ **Limited Warranty Statement** provides your product warranty statement and explains how to extend your warranty for an additional nine months.

The online *User Guide* is included with your computer as an electronic document. It includes additional information on using the Sony software products that are installed on your computer and how to customize your Sony notebook computer.

Ergonomic Considerations

You will be using your notebook computer as a portable device in a variety of environments. Whenever possible, you should attempt to apply the following ergonomic considerations to both stationary and portable environments.

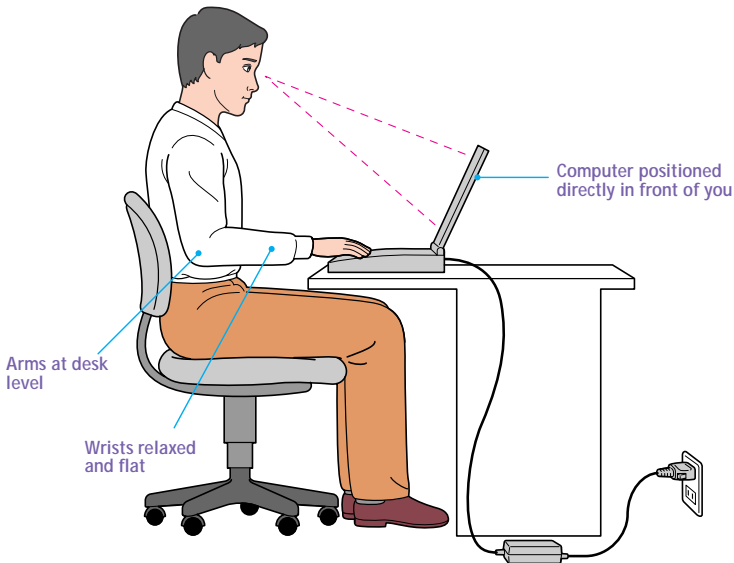

- ❑ **Position of your computer** – Place the computer directly in front of you as you work. Keep your forearms horizontal, with your wrists in a neutral, comfortable position while using the keyboard, touchpad, or external mouse. Let your upper arms hang naturally at your sides. Take breaks during sessions with your computer. Excessive use of the computer may strain muscles or tendons.
- ❑ **Furniture and posture** – Sit in a chair with good back support and armrests. Adjust the level of the chair so your feet are flat on the floor. A footrest may make you more comfortable. Sit in a relaxed, upright posture and avoid slouching forward or leaning far backward.
- ❑ **Viewing angle of the computer's display** – Use the display's tilting feature to find the best position. You can reduce eye strain and muscle fatigue by adjusting the tilt of the display to the proper position. Adjust the brightness setting of the display also.

- ❑ **Lighting** – Choose a location where windows and lights do not create glare and reflection on the display. Use indirect lighting to avoid bright spots on the display. You can also purchase accessories for your display that help reduce glare. Proper lighting adds to your comfort and work effectiveness.
- ❑ **Tilt stand** – You use the tilt stand to place the computer at an angle that allows comfortable typing.

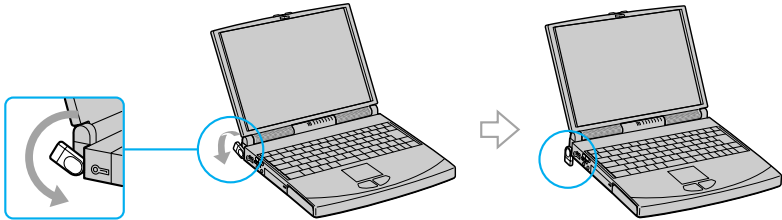

- ❑ **Placement of an external display** – When using an external display, set the display at a comfortable viewing distance. Make sure the display screen is at eye level or slightly lower when you are sitting in front of the monitor.

Using Your Notebook Computer

This section describes how to start using your computer and how to use your computer's internal and external devices, such as the touchpad, floppy disk drive, and DVD-ROM drive.

Locating the Controls and Connectors

Front

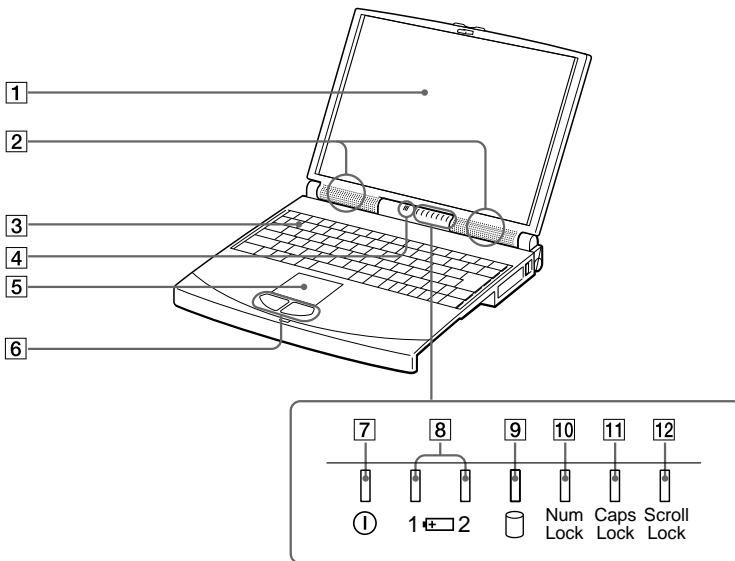

1 LCD screen (pages 20, 91)

2 Speakers (page 58)

3 Keyboard (page 16)

4 Microphone (page 59)

5 Touchpad (page 22)

6 Left/right buttons (page 22)

7 Power indicator (pages 12, 19)

8 Battery 1 and 2 indicators (pages 19, 70)

9 Hard disk drive indicator (page 19)

10 Num Lock indicator (page 19)

11 Caps Lock indicator (page 19)

12 Scroll Lock indicator (page 19)

Left

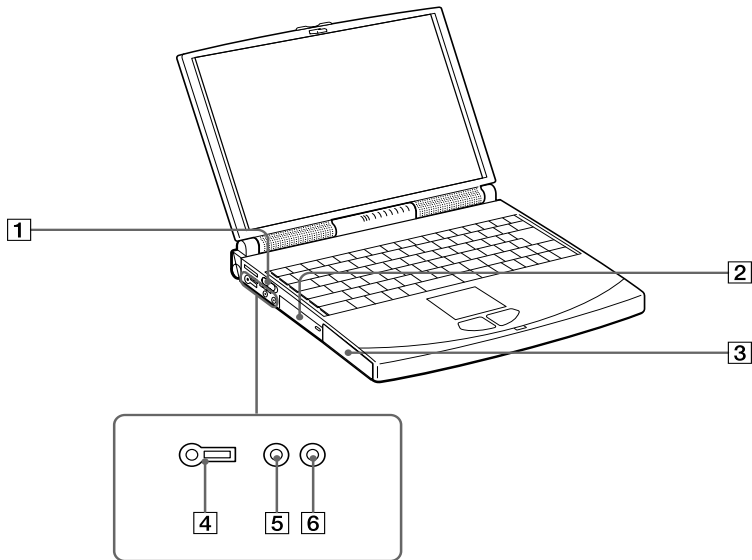

- | | | | |
|----------|---------------------------|----------|------------------------------------|
| 1 | Power switch (page 12) | 4 | Headphone connector (pages 30, 58) |
| 2 | Hard disk drive | 5 | Microphone connector (page 59) |
| 3 | Battery bay (pages 9, 48) | 6 | Line In connector |



There is a ventilation slot located directly above the headphone connector. Do not cover the ventilation slot when your computer is on.

Right

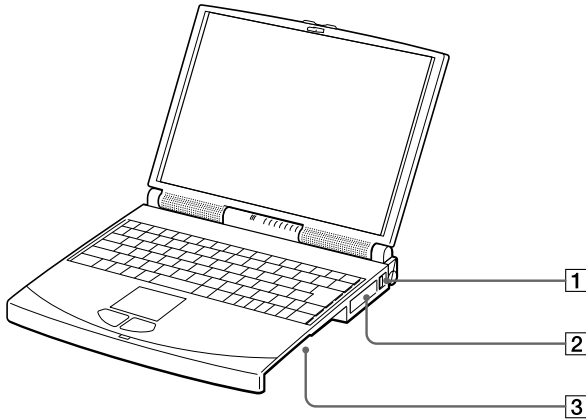

- 1 Phone line jack (page 44) 3 Drive bay (pages 23, 26)
- 2 PC card slots (page 33)

Back

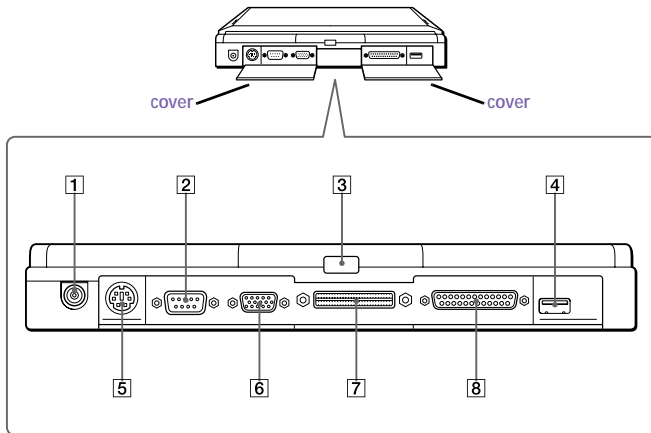

- 1 DC In (page 8) 6 Monitor connector (page 54)
- 2 Serial connector (page 60) 7 Docking station port (page 45)
- 3 Infrared port (page 36) 8 FDD/Printer connector (page 53)
- 4 USB connector (page 62)
- 5 Mouse/Keyboard connector (page 57)

Connecting a Power Source

You can use either AC power or a rechargeable battery pack as a power source.

Using the AC Adapter

- 1 Plug the cable attached to the AC adapter into the DC In connector on the computer.
- 2 Plug one end of the power cord into the AC adapter.
- 3 Plug the other end of the power cord into an AC outlet.

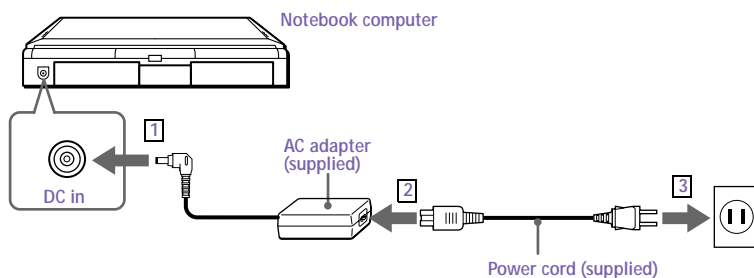

Using Battery Power

You can use one or two battery packs as a source of power. The second battery pack inserts into the drive bay on the right side of the computer. (See “Using Power Saving Modes” on page 38.) Additional battery packs are available as a separate option.

The battery pack that comes with your computer is not fully charged at the time of purchase. Follow the steps below to insert and charge the battery pack.

To insert the battery pack

- 1 Open the cover of the battery bay.

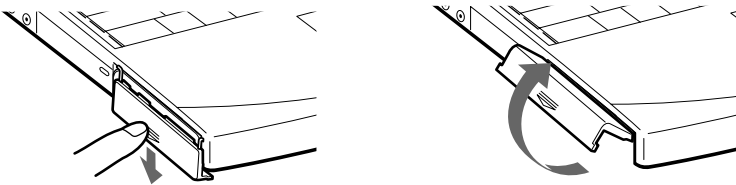

- 2 Insert the battery pack into the battery bay on the left side of the computer.

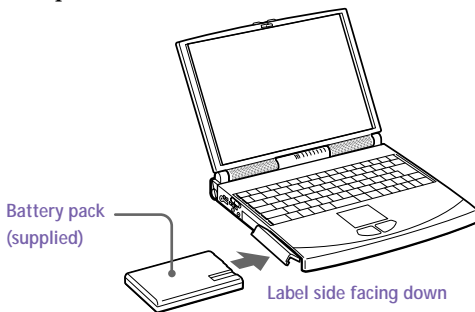

- 3 Close the cover of the battery bay.

To charge the battery pack



- 1 Connect the AC adapter to the computer.
- 2 Insert the battery pack.

The computer automatically charges the battery (the battery indicator light flashes in a double blink pattern as the battery charges). When the battery is 85 percent full, the battery indicator light turns off. This process takes approximately two hours. To charge the battery completely, continue charging for an additional hour.

A fully charged battery pack supplies power for approximately two to four hours. The time varies based on your system configuration. See “Displaying Detailed Battery Information” on page 71 for information on checking the battery life.

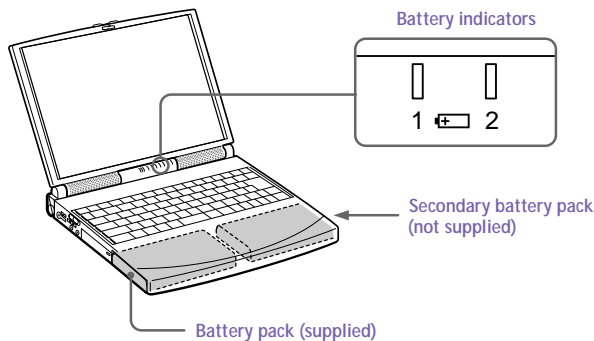
There are two battery indicator lights on the computer:



Battery Indicator	Meaning
1 	Indicates the status of the battery pack in the battery bay on the left side of the computer.
 2	Indicates the status of the battery pack in the drive bay on the right side of the computer.

Battery Indicator Light Status	Meaning
On	The computer is using battery power.
Single blink	The battery is running out of power.
Double blink	The battery is charging.
Off	The computer is using AC power.



When the battery is running out of power, both the battery and power indicators blink.

See “Using a Second Battery Pack” on page 40 for information on installing and charging a battery pack in the drive bay.

Keep the battery pack in the computer while it is directly connected to AC power. The battery pack continues to charge while you are using the computer.

If the battery level falls to below 10%, you should either attach the AC adapter to recharge the battery or shut down your computer and insert a fully charged battery.

You can extend battery life by changing the power management modes in the PowerPanel utility. See “Using Power Saving Modes” on page 38.

The battery pack supplied with your computer is a lithium ion battery and can be recharged at any time. Charging a partially discharged battery does not affect battery life.

The battery indicator light is on while you use the battery pack as a power source. When battery life is nearly depleted, the battery indicator starts flashing.

For some software applications and some peripheral devices, your computer may not enter System Hibernation mode when the battery life is low. To avoid loss of data when using battery power, you should save your data frequently and manually activate a power management mode, such as System Suspend or System Hibernation.

To remove the battery pack

- 1 **Open the cover of the battery bay.**
- 2 **Pull out the battery pack.**

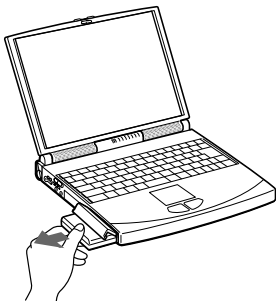

- 3 **Close the cover of the battery bay.**

! You may lose data if you remove the battery pack while the computer is on and not connected to the AC adapter or if you remove the battery while the computer is in System Suspend mode.

Starting Your Computer

- 1 Slide the LCD lock lever in the direction of the arrow, and lift the cover.

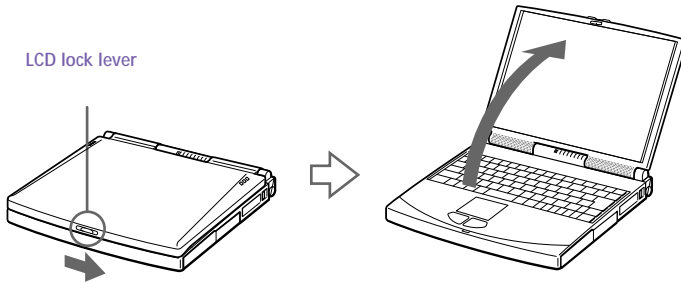

- 2 Slide the power switch on the left side toward the front of the computer until the green power indicator light turns on.

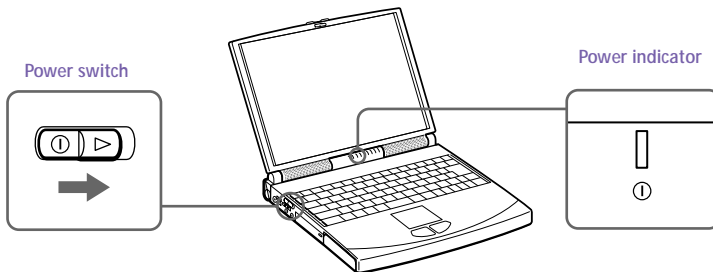

 If you hold the power switch in the on position for more than four seconds, the computer turns off.

- 3 If necessary, adjust the brightness controls for the LCD display. To decrease the brightness, press Fn+F5 and then the down or left arrow key. To increase the brightness, press Fn+F5 and then the up or right arrow key.

Shutting Down Your Computer

! To avoid potential loss of data, follow these steps to shut down your computer.

- 1 Click the Start button on the Windows 98 taskbar.
- 2 Click Shut Down at the bottom of the Start menu to display the Shut Down Windows dialog box.

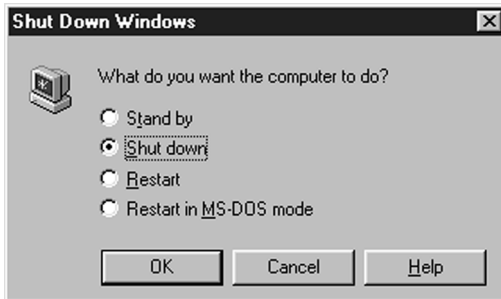

- 3 Select Shut down.
- 4 Click OK.

 Respond to any prompts warning you to save documents.

- 5 Wait for your computer to turn off automatically. The power indicator (green) turns off.
- 6 Turn off any peripherals connected to your computer.

 If you are unable to shut down your computer using the steps described above, press the Ctrl+Alt+Delete keys at the same time to restart the computer. If you are unable to restart the computer in this way, you can slide the power switch forward and hold for four seconds. This operation may result in data loss.

During a period of inactivity, you can conserve battery life by using System Suspend mode. See "Controlling Power Management" on page 66.

Registering Windows® 98

The first time you turn on your computer, you need to complete a few steps to register and configure the Windows 98 software that is already installed on your computer.



You must register Windows 98 before you can use the computer.

To install Windows NT® Workstation 4.0 drivers on your notebook computer, you need to use the Application Recovery CD. See “Using the Application Recovery CD(s)” on page 90 for instructions.

The on-screen instructions guide you through the registration and configuration process. The following is an overview of the process.

- 1 Gathering information:
 - Enter your name.
 - Read and accept the License Agreement.
 - Enter your Certificate of Authenticity number located on the cover of the Microsoft Windows 98 *Getting Started* manual.
- 2 Windows 98 setup: Click the Finish button on the Windows 98 Setup Wizard screen.
- 3 Selecting your computer settings: If necessary, change the Time Zone, Date and Time on the Date/Time Properties screen.
- 4 Registering your computer: For details on registering your computer, see “Registering Your Computer” on page 15. You can also sign up for your 100 free hours of Internet service at this time.
- 5 Learning about Windows 98: If you wish, take the tour of Windows 98.

Registering Your Computer

You can take advantage of Sony's commitment to quality customer support and receive the following benefits by registering your computer with Sony.

- ❑ **Sony Customer Support** – Talk to a Support Representative to troubleshoot problems you may be having with your computer.
- ❑ **Extended Limited Warranty** – Protect your investment. Extend your Warranty nine months for a total of 12 months from the original date of purchase when you register your computer.
- ❑ **Express service** – Provides convenient resolution of problems.
- ❑ **Free Internet access** – Use the Internet for up to 100 free hours when you sign up with GTE (no credit card necessary). Free access expires 100 hours or 60 days after signing up, whichever occurs first.

If you have not already registered, follow these steps to use your notebook computer's online registration service.



You must connect your phone line before using any online services, including the online registration service. See "Connecting a Phone Line" on page 44.

- 1 Click the Sony VAIO Registration icon on the VAIO desktop.
- 2 Enter the information requested on the first online registration form. Press the Tab key to move from box to box.
- 3 Click the Next button to advance to the next form.
- 4 Complete the remaining forms by clicking the Next button each time you complete a form.



The computer automatically transfers your registration information using your built-in modem and a toll-free telephone number.

Using the Keyboard

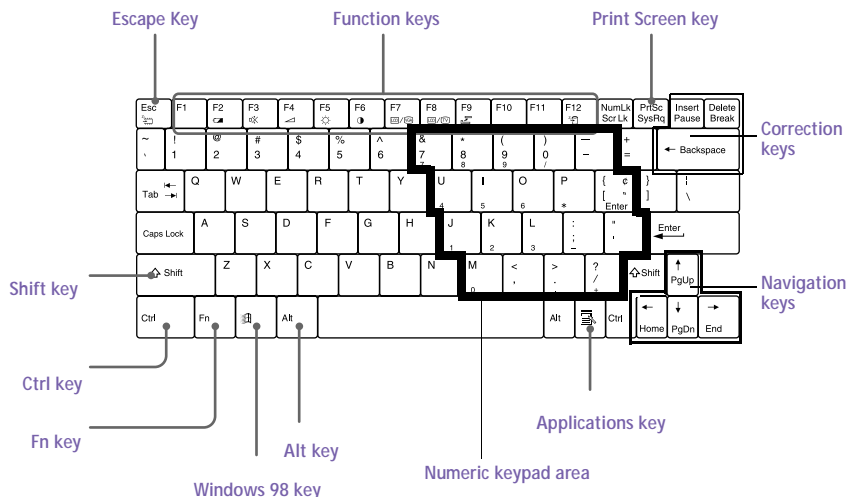







Your keyboard is very similar to a typewriter's, but the keyboard has additional keys that perform specific computer-related tasks.





Keys	Descriptions
Numeric keypad area	Contains the keys found on a typical calculator. Use the numeric keypad area to type numbers or to perform mathematical calculations such as addition and subtraction. Note that you must press the Num Lock key to activate the numeric keypad. (When you do so, the Num Lock light will be on.)
Navigation keys	Several keys are devoted to moving the cursor on the screen (the four arrow keys, which also function as the Home, End, Page Up, and Page Down keys).
Correction keys	The Insert, Back Space, and Delete keys enable you to make corrections in your documents.
Function keys	The twelve function keys along the top of the keyboard are used to perform designated tasks. For example, in many applications, F1 is the Help key. The task associated with each function key may vary from one application to the next.
Escape key	The Esc (Escape) key is used to cancel commands.

<i>Keys</i>	<i>Descriptions</i>
Print Screen key	The Print Screen key takes an electronic snapshot of the screen and places it in the Windows Clipboard. You can then paste the screen shot into a document and print it.
Operator keys	Several keys are always used with at least one other key: Ctrl, Alt, and Shift. When held down with another key, the Ctrl (Control) and Alt (Alternate) keys offer another way to give commands. For example, in many applications, instead of choosing the Save command from a menu, you can hold down Ctrl and press S (referred to as Ctrl+S). The Shift key operates the same way as on a typewriter; it is used to produce capital letters or special symbols such as @ and \$.
Windows 98 key 	The key with the Windows logo displays the Windows 98 Start menu; it is the equivalent of clicking the Start button on the task bar. See “Combinations and Functions with the Windows 98 Key” on page 18.
Fn key	The Fn key is used in combination with other keys to issue commands. The Fn keys at the left and right sides both work the same. See “Combinations and Functions with the Fn Key” on page 20.
Applications key 	The Applications key displays a shortcut menu of context-sensitive choices; pressing this key is the equivalent of clicking the right mouse button.

Combinations and Functions with the Windows 98 Key











<i>Combinations</i>	<i>Functions</i>
 + F1	Displays Windows Help.
 + Tab	Switches the selected button on the taskbar.
 + E	Displays Windows Explorer.
 + F	Displays the Windows Find: All Files window to find a file or folder. This is the equivalent of selecting Find and then Files or Folders from the Start menu.
 + Ctrl + F	Displays the Windows Find: Computer window where you can locate other computers. This is the equivalent of selecting Find and then Computer from the Start menu.
 + M	Minimizes all displayed windows.
Shift +  + M	Returns all minimized windows to their previous size.
 + R	Displays the Run window. This is the equivalent of selecting Run from the Start menu.
Fn +  + Insert	Displays the Properties window. This is the equivalent of double-clicking the System icon in the Control Panel.

Indicators

<i>Indicators</i>	<i>Functions</i>
Power ①	Lights when the power to the computer is turned on. Flashes in System Suspend mode. Turns off when the computer is in System Hibernation mode or powered off.
Battery 1 1 	Indicates the status of the battery inserted in the battery bay on the left side of the computer.
Battery 2  2	Indicates the status of the battery inserted in the drive bay on the right side of the computer.
Hard disk 	Lights when data is being read from or written to the hard drive. Do not enter System Suspend mode or turn off the computer when this indicator light is on.

<i>Light</i>	<i>On</i>	<i>Off</i>
Num Lock	The number keys in the numeric keypad are active.	The alphanumeric character keys in the keypad area are active.
Caps Lock	The letters appear in uppercase as you type. The Shift key lowers the case of typed letters when Caps Lock is on.	Letters appear in lower case as you type (unless you hold down the Shift key).
Scroll Lock	The screen scrolls differently. (Exactly how it scrolls depends on the specific application. It has no effect in many applications.)	Information moves across the display normally.

Combinations and Functions with the Fn Key

Combinations/ Feature	Functions
Fn+  (ESC) System Suspend	Puts the system into System Suspend mode, a power management state. To return the system to the active state, press any key or press the power switch on your computer. (Not available when connected to the docking station.)
Fn+  (F2) Display power source status	Displays the power status, as in the example below: <div style="display: flex; justify-content: space-around; align-items: center; margin-top: 10px;"> <div style="text-align: center;">  <p>Using AC power</p> </div> <div style="text-align: center;">  <p>Charging the battery</p> </div> </div>
Fn+  (F3) Mute on/off	Toggles the built-in speaker off and on.
Fn+  (F4) Speaker volume	Adjusts the built-in speaker volume. To increase volume, press Fn+F4, then ↑ or → . To decrease volume, press Fn+F4, then ↓ or ← .
Fn+  (F5) Brightness control	Adjusts the brightness of the LCD. To increase light intensity, press Fn+F5 and then ↑ or → . To decrease light intensity, press Fn+F5 and then ↓ or ← .
Fn+F6	Not available on this model.
Fn+  /  (F7) Switch to the external monitor/LCD	Toggles through the LCD, external display (connected to the ) and both LCD and external display. <div style="display: flex; justify-content: space-around; align-items: center; margin-top: 10px;"> <div style="text-align: center;"> <p>Only LCD</p> <p>→</p> </div> <div style="text-align: center;"> <p>LCD and external display</p> </div> <div style="text-align: center;"> <p>←</p> <p>Only external display</p> </div> </div>
Fn+F8	Not available on this model.
Fn+  (F9)	Disconnects from the docking station when the power is on. (Not available on all models.) Make sure there is a charged battery in the computer before you disconnect the docking station.

<i>Combinations/ Feature</i>	<i>Functions</i>
Fn+  (F12) System Hibernation	Provides for the lowest level of power consumption. When you execute this command, the state of the system and state of the peripheral devices are written to the hard disk and the system power is turned off. To return the system to the original state, use the power switch to turn on power. (Not available when connected to the docking station.)
Fn+F Change the display size	Zooms the display size in or out when the display is set to a low resolution.
Fn+D Video standby	Turns off the LCD in order to save power. To turn the LCD back on, press any key.

Using the Touchpad

The keyboard contains a cursor-pointing device called a touchpad. You can point to, select, drag, and scroll objects on the screen using the built-in touchpad.

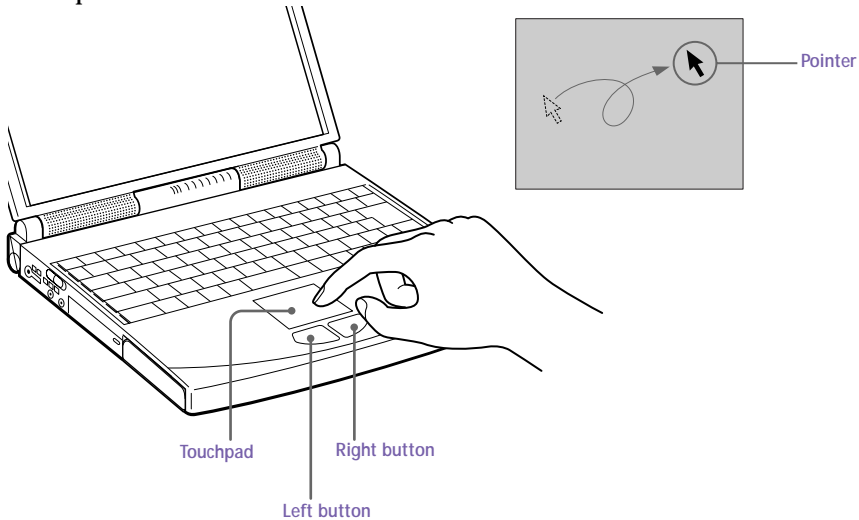

<i>Actions</i>	<i>Descriptions</i>
Point	Slide one finger on the touchpad to place the pointer on an item or object.
Click	Press the left button once.
Double-click	Press the left button twice.
Right-click	Press the right button once. In many applications, this action displays a shortcut menu of context-sensitive choices.
Drag	Slide one finger while pressing the left button. When your finger reaches a touchpad edge, the pointer keeps moving until you lift your finger. Use this action to select and move objects.
Scroll	Move your finger along the right edge of the touchpad to scroll vertically. Move your finger along the bottom to scroll horizontally. (The scroll function is available only with applications that support a touchpad scroll feature.)



See Mouseware Help for information on touchpad features, such as middle button click, adjusting touchpad speed, and Wheel Mouse functions. To access Mouseware Help, press the Start button, select Settings, and then select Control Panel. Click the Mouse icon in the Control Panel and click the Help button.

Using the Floppy Disk Drive



There are two ways to connect the floppy disk drive to your computer:

- ❑ Externally, by connecting it to the computer's FDD/Printer connector.
- ❑ Internally, by inserting it into the drive bay.

The computer comes with the DVD-ROM drive in the drive bay. If you want to use both the DVD-ROM and the floppy disk drive at the same time, use the floppy disk drive as an external drive.

If you connect the floppy disk drive externally while your computer is on, use the Sony Notebook Setup utility to select Floppy Disk Drive. See "Displaying the Sony Notebook Setup Screen" on page 63 for details.

To connect the floppy disk drive externally

Connect the floppy disk drive to the  /  FDD/Printer connector using the external floppy disk drive cable.

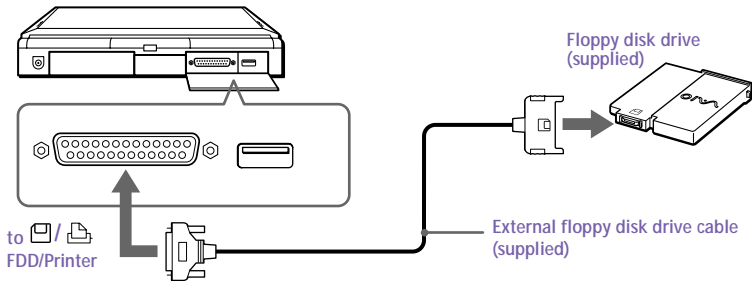

To insert the floppy disk drive

1 Turn off the computer.



If you use the Drive Bay tab in Sony Notebook Setup, you do not need to turn off the power before exchanging devices in the drive bay. See page 65.

2 If another device is in the drive bay, remove the device. See “To remove the DVD-ROM drive” on page 28 or “To remove the second battery pack” on page 41.

3 Insert the floppy disk drive into the drive bay with the VAIO label facing up. Continue pushing the drive into the bay until the Eject lever locks into place.

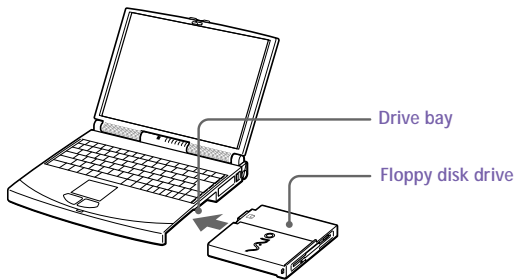

To insert a diskette

1 Hold the diskette with the label side facing up.

2 Gently push the diskette into the drive until it clicks into place.

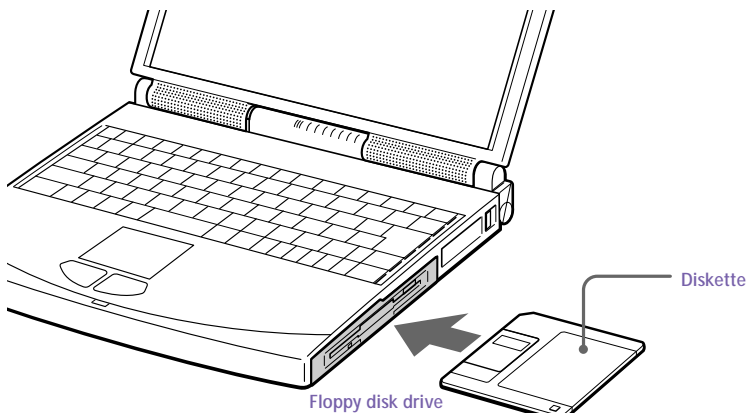

To remove a diskette

- When you finish using the diskette, wait until the LED indicator turns off and then press the Eject button to remove the diskette.

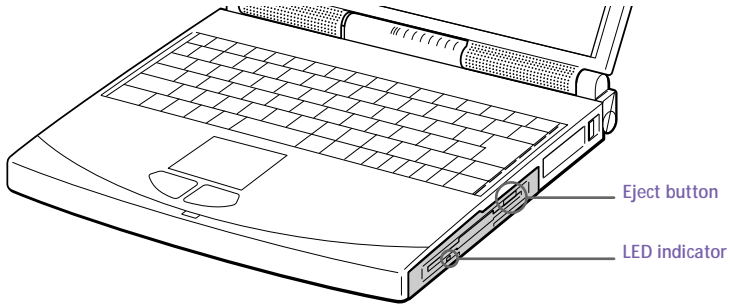

 If you have difficulty removing a diskette from the floppy disk drive, remove the floppy disk drive from the drive bay.

To remove the floppy disk drive

- 1 Turn off the computer.
- 2 There is an Eject lever on the bottom of the floppy disk drive. Slide this lever in the direction of the arrow.

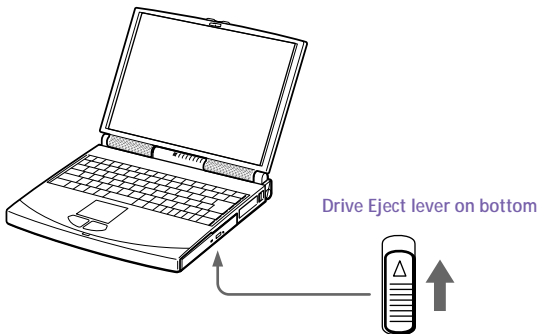

- 3 Slide the drive out of the drive bay.
- 4 Insert the weight saver. See "Using the Weight Saver" on page 42.

Using the DVD-ROM Drive

Your computer comes with the DVD-ROM drive in the drive bay. You can remove it so that you can use other devices in the drive bay. Your DVD-ROM drive plays both DVD-ROMs and CD-ROMs.

To insert a disc

1 Turn on the computer.



When the computer is in System Suspend or System Hibernation mode, you cannot insert a disc. See "Controlling Power Management" on page 66 for more information on System Suspend and System Hibernation modes.

If you use the Drive Bay tab in Sony Notebook Setup, you do not need to turn off the power before exchanging devices in the drive bay. See "Changing Devices in the Drive Bay Using the Drive Bay Tab" on page 65.

2 Press the Eject button to open the DVD-ROM drive.

The tray slides out.

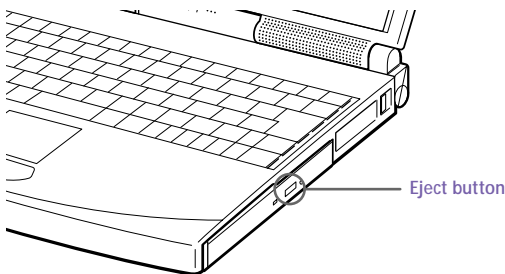

3 Place a CD-ROM in the tray with the label side facing up. For DVDs, which can be played on both sides, the side of the disc facing up is the side that plays. Push the disc onto the hub until the disc clicks into place.

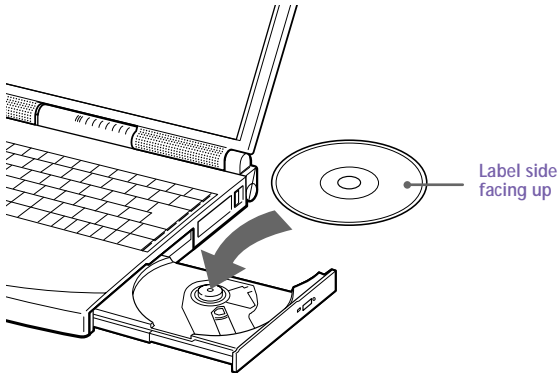

4 Close the tray by pushing it gently.

 Be sure to seat the disc firmly over the DVD-ROM drive hub fingers. If you do not seat the disc firmly, you could damage your DVD-ROM drive and you may not be able to open the tray.

When you finish using a disc, press the Eject button to remove the disc.

When the computer is in System Suspend or System Hibernation mode, you cannot remove a disc. See "Controlling Power Management" on page 66 for more information about System Suspend and System Hibernation modes.

If the disc does not come out when you press the Eject button, turn off the computer and insert a thin, pointed object into the manual eject hole.

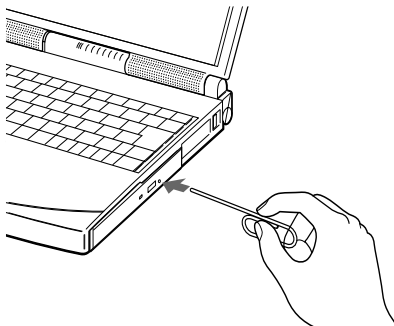

To remove the DVD-ROM drive

- 1 Turn off the computer before removing the DVD-ROM drive.
- 2 There is an Eject lever on the bottom of the DVD-ROM drive. Slide this lever in the direction of the arrow.

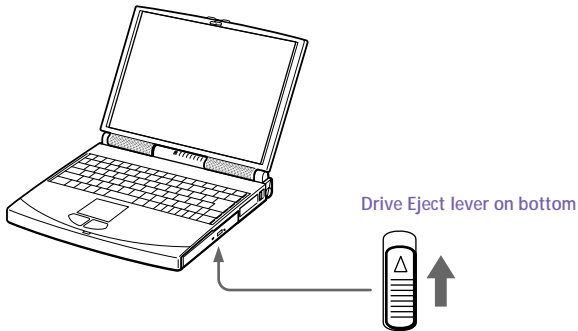

- 3 Slide the drive out of the drive bay.
- 4 Insert the weight saver. See “Using the Weight Saver” on page 42.

To reinsert the DVD-ROM drive

- 1 Turn off the computer.
- 2 If another device is in the drive bay, remove the device. See “To remove the floppy disk drive” on page 25 or “To remove the second battery pack” on page 41.
- 3 Insert the DVD-ROM drive into the drive bay with the label side facing up.

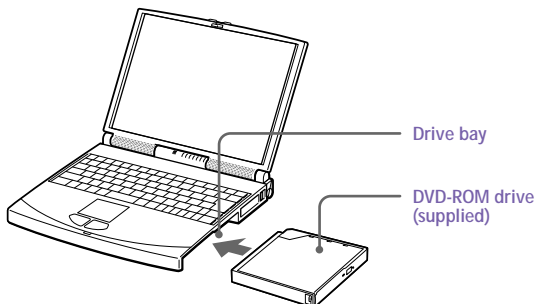

To play DVD-ROMs

To achieve optimum performance when playing DVD-ROMs, you should use the following recommendations: Your computer should not be connected to the docking station while playing DVD movies or using DVD applications. Close any open applications before playing a DVD-ROM movie. The DVD player automatically adjusts the screen properties when you play a DVD movie. Depending on the display setup properties you have selected, you may need to use the Fn + F command to expand the movie to full screen size.





When playing DVD movies on battery power, set the power management profile to Maximum Performance. With other profiles, the movies are choppy.

Using the Headphone with Remote Control

Your notebook computer includes a headphone, which you can use to listen to audio and video CDs and DVDs. You can listen to audio CDs even when your computer is in System Suspend mode.

To use the remote control when your computer is active, you must use the Digital Media Park software. To use the remote control when your computer is in System Suspend mode, follow the directions in the next section.

To use the remote control in System Suspend mode

- 1 Connect the micro-plug of the headphone to the headphone remote control, not to the  Headphone connector of the computer.
- 2 Connect the headphone remote control to the  Headphone connector on the computer.

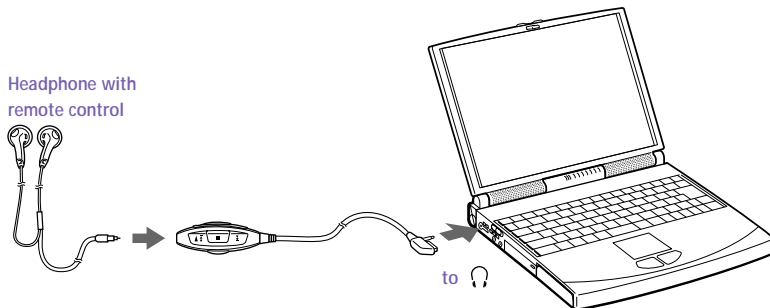

- 3 While holding down the Fn key, press Esc.
The computer enters System Suspend mode.
- 4 Press the ■ Stop button on the remote control.
- 5 Press the Eject button to open the DVD-ROM drive.
The tray slides out.
- 6 Place the audio CD/DVD in the tray and close the tray by gently pushing the tray.
- 7 Press the ► Play button on the remote control.
Playback begins.

To stop playback, press the ■ Stop button and press the Eject button on the DVD-ROM drive. Then remove the audio CD/DVD.



See "Controlling Power Management" on page 66 for more information about System Suspend mode.

To recover from System Suspend mode, press any key on the keyboard.

Use only the supplied headphone remote control. You cannot operate this computer with the remote control supplied with other models.

If you cannot hear an audio CD/DVD in your headphone, right-click the speaker icon on the taskbar, select Open Volume Controls from the shortcut menu, and adjust the volume levels.

To remove an audio CD/DVD from the DVD-ROM drive, remove the CD/DVD within one minute after pressing the ■ Stop button on the remote control. If the tray does not open, press the ■ Stop button and try again.

Using the Remote Control to Play an Audio CD or DVD

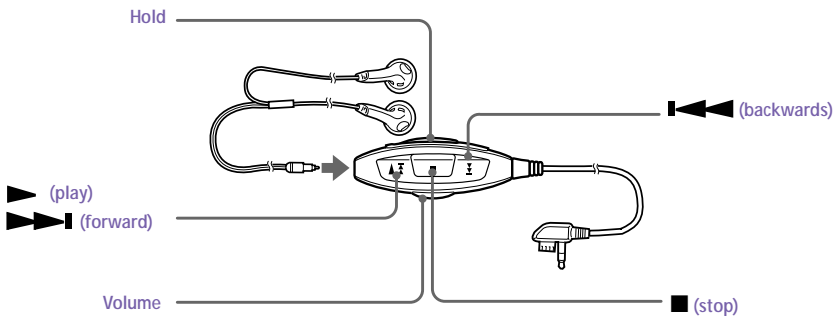

To	Press
Find the beginning of the current track (AMS*)	◀◀ once
Find the beginning of previous tracks (AMS)	◀◀ repeatedly
Find the beginning of the next track (AMS)	▶▶ once
Find the beginning of succeeding tracks (AMS)	▶▶ repeatedly
Go forward quickly	Hold down ▶▶
Go backwards quickly	Hold down ◀◀

*AMS = Automatic Music Sensor

Using the Hold Switch

You can use the Hold switch to lock the controls of the headphone remote control. When you are not using the headphone remote control, slide Hold in the direction of the arrow. To unlock, slide Hold back.

Using PC Cards

Your computer includes two PC card slots. PC cards allow you to connect portable external devices, such as another hard disk drive, or to connect a network.

 The PC card slots can accommodate (at the same time) two Type I, two Type II, or one Type III PC card. These slots are compatible with Card Bus and ZV (Zoomed Video) port.

Some PC cards may require that you disable idle devices when using the PC card. You can use Sony Notebook Setup to disable devices. See "Displaying the Sony Notebook Setup Screen" on page 63 for details.

Be sure to use the most recent software driver provided by the PC card manufacturer.

If an "!" mark appears on the Device Manager tab in the System Properties dialog box, remove the software driver and then reinstall it.

To insert a PC card

Use the lower slot for Type III PC cards.

 You do not need to shut down the computer before inserting or removing a PC card.

- 1 Pull the PC card release button up away from the computer and push it in toward the computer.

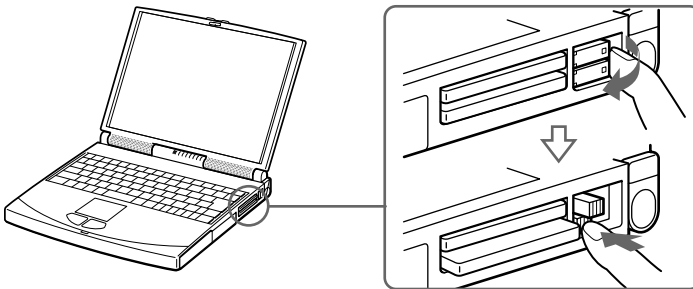

2 Remove the PC card slot protector.

When you use a Type III PC card, you need to remove both the top and bottom PC card slot protectors.

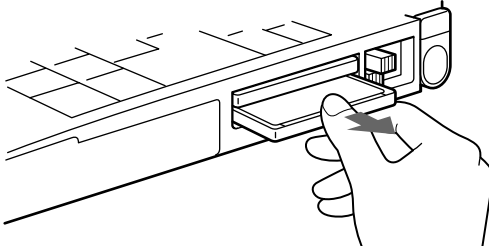

3 Insert the PC card into the PC card slot, front label facing up. Gently push the card into the slot until the card is fixed into the connector. The release button comes out.

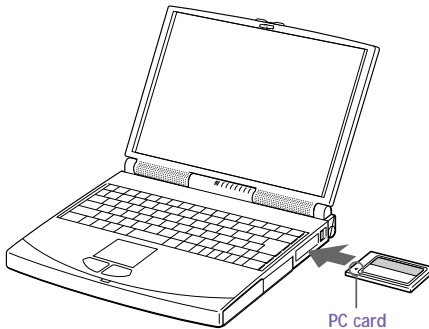

Do not force a card into the slot. It may damage the connector pins. If you have difficulty inserting a card, check that you are inserting the card with the correct orientation. See the manual that came with your PC card for more information on use.

To remove a PC card

- 1 Close any applications that are using the PC card.
- 2 Click the PC card icon in the taskbar and close the card.
- 3 Pull the PC card release button up and press it in toward the computer.
- 4 Gently grasp the card and pull it out.
- 5 Insert the PC card slot protector back into the empty slot.

Using Infrared Communication Devices

Your computer includes an infrared port, located on the back panel. You can use this port to communicate with other infrared-equipped devices with compatible protocols, such as a digital still camera or other computers.

To use infrared communication with a digital still camera

Align the infrared ports on the computer and the digital camera so that they are in a direct line.

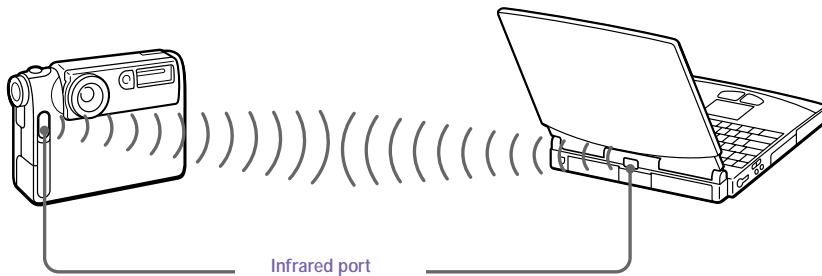

To use infrared communication with another computer

Align the infrared ports on the two computers so that they are in a direct line.

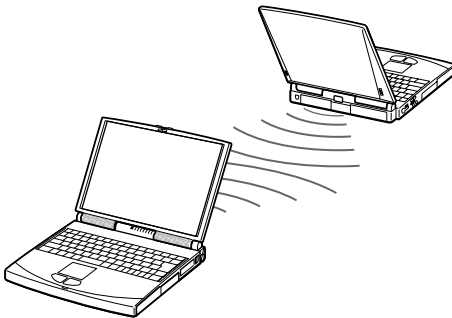



Infrared communication capability can be turned on and off. By default, it is not enabled when your system is shipped. To enable infrared use, click the infrared icon in the Windows Control Panel and select the Enable infrared communication checkbox on the Options tab.

You can disable infrared communication when you are not using it to conserve battery life.

Use the infrared icon in the Windows Control Panel to enable and disable infrared communication. Do not use the icon in the taskbar.

When you transfer files directly from devices other than the internal hard disk drive, such as a CD-ROM drive or hard disk drive on a network, set the System Suspend and System Hibernation timers to off.

Check the Status tag of the Infrared Monitor in the Windows Control Panel to determine if the infrared device is detected.

If the two devices are too far apart or too close together, data transfer may be interrupted or there may be noise in the transmission.

Do not cover the infrared ports with your hand or any other object.

Avoid direct sunlight, fluorescent light, or flashing incandescent light near the infrared ports.

See the manual that came with your digital still camera or other infrared communication device for more information on installation and use.

The active area of infrared transmission extends about $39 \frac{3}{8}$ inches (1m) with a radius of 15 degrees.

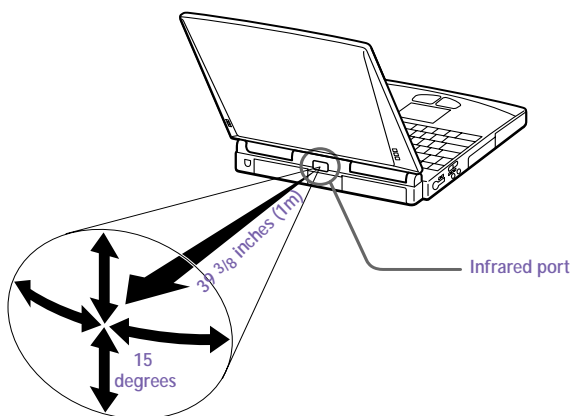

Using Power Saving Modes

When you use a battery as the source of power for your computer, you can take advantage of power management settings to conserve battery life. In addition to the normal operating mode, which allows you to turn off specific devices, your computer has two distinct power saving modes: System Suspend and System Hibernation. When using battery power, you should be aware that the computer automatically enters System Hibernation mode when the remaining battery charge drops below 7 percent, regardless of the power management setting you select.



If the battery level falls to below 10 percent, you should either attach the AC adapter to recharge the battery or shut down your computer and insert a fully charged battery.

Normal Mode

This is the normal state of your computer when it is in use. The green power indicator light is on in this mode. To save power, you can turn off a specific device such as the LCD or the hard disk.

System Suspend Mode

The computer saves the current state of the system in RAM and switches off power to the CPU. The amber power indicator light flashes in this mode.

To activate System Suspend mode

Press Fn+Esc, or slide the power switch forward and release it immediately. You can also use the PowerPanel utility to enter System Suspend mode.

To return to normal mode

Press any key.

System Hibernation Mode

The state of the system is saved on the hard drive and power is turned off. The power indicator light is off in this mode.

To activate System Hibernation mode

Press Fn+F12. The "Save to Disk Manager" screen appears, and then the computer enters System Hibernation mode. You can also use the PowerPanel utility to enter System Hibernation mode.

To return to normal mode

Turn on the computer by sliding the power switch forward. The computer returns to its previous state.



When returning from System Hibernation mode, the system status stored on the hard disk is erased and the computer starts normally if you slide the power switch forward and hold for more than four seconds.

- ❑ **Time to return to normal mode:**
System Suspend requires less time than System Hibernation
- ❑ **Power consumption:**
System Suspend uses more power than System Hibernation

Using a Second Battery Pack

You can purchase a second rechargeable battery pack. With two battery packs, you can extend the time that you use your computer with battery power. When using two battery packs, the battery pack you insert first charges first. The battery pack you insert second charges when the first battery pack is 85 percent full. You can monitor which battery pack is charging by observing the battery indicator lights.

To insert a second battery pack

- 1 If another device is in the drive bay, remove the device. See “To remove the floppy disk drive” on page 25 or “To remove the DVD-ROM drive” on page 28.



If you use the Drive Bay tab in Sony Notebook Setup, you do not need to turn off the power before exchanging devices in the drive bay. See page 65.

- 2 Insert the battery pack into the drive bay.

The battery 2 indicator light turns on.

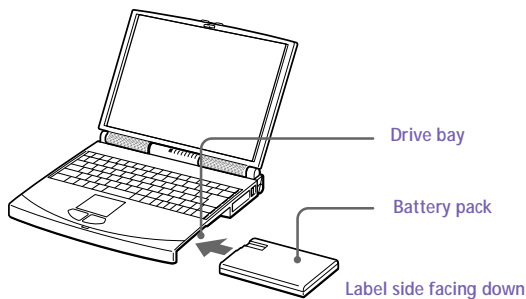

- 3 Attach the Weight Saver to the computer to stabilize the battery pack. See also “Using the Weight Saver” on page 42.

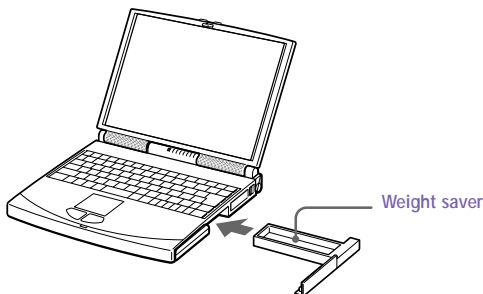

To charge the second battery pack

Keep the battery pack in the computer while it is connected to AC power. The battery indicator flashes while the battery is charging. See also “To charge the battery pack” on page 10 for more information.

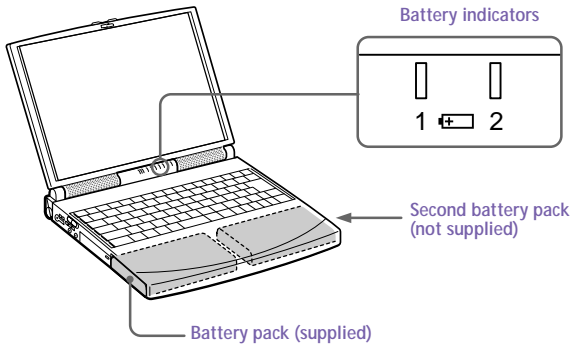

To determine the amount of time the battery lasts, see “Displaying Battery Information” on page 70.

To remove the second battery pack

- 1 There is an Eject lever on the bottom of the weight saver. To remove the battery pack, slide this lever in the direction of the arrow.

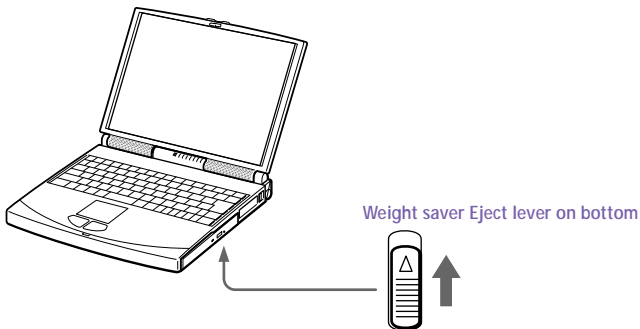

- 2 Remove the weight saver, and then pull out the battery pack.
- 3 Reinsert the weight saver. See “Using the Weight Saver” on page 42.

Using the Weight Saver

The weight saver protects the drive bay when it is empty.

To attach the Weight Saver

- 1 If another device is in the drive bay, remove the device. See “To remove the floppy disk drive” on page 25, “To remove the DVD-ROM drive” on page 28, or “To remove the second battery pack” on page 41.
- 2 Slide the weight saver in the direction of the arrow until it clicks.

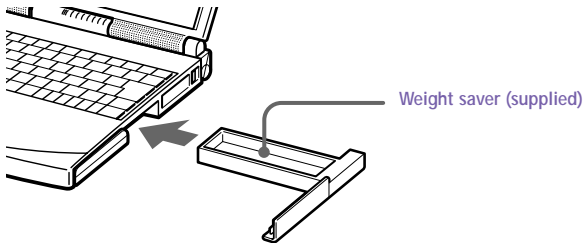

To remove the Weight Saver

There is an Eject lever on the bottom of the weight saver. To remove the weight saver, slide this lever in the direction of the arrow.

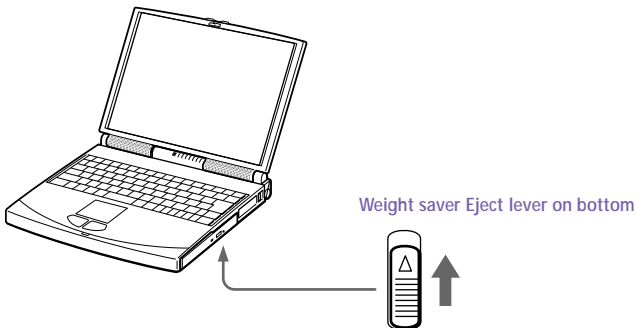

Connecting Peripheral Devices

You can add functionality to your computer by connecting any of these peripherals:

- ❑ Phone line (page 44)
- ❑ Docking station (page 45)
- ❑ Printer (page 53)
- ❑ External display (page 54)
- ❑ External mouse or keyboard (page 57)
- ❑ External speakers (page 58)
- ❑ External microphone (page 59)
- ❑ Digital still camera or other serial device (page 60)
- ❑ Digital video camera recorder (page 61)
- ❑ Universal Serial Bus (USB) device (page 62)



Before you connect peripherals, turn off the computer and all peripherals.

Connect the power cord only after connecting all cables.

Turn on the computer only after turning on all peripherals.

Connecting a Phone Line

You need to connect a phone line to take advantage of online services and the Internet.

 In order to register your Sony VAIO Notebook Computer, register your software online, and use Sony Customer Support, you must connect to a phone line. You must register your computer to receive the extended warranty.

- 1 Pull the PC card release buttons away from the computer.

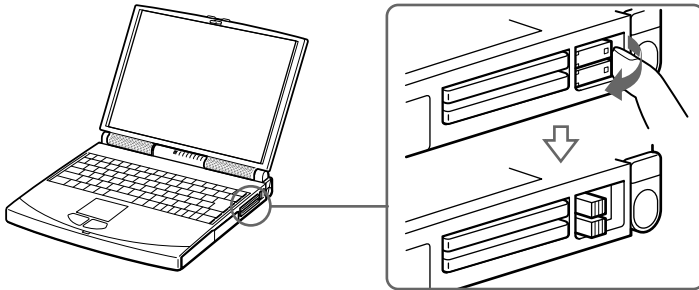

- 2 Plug one end of the phone cable into the phone line jack on the computer.
- 3 Plug the other end into the wall jack.

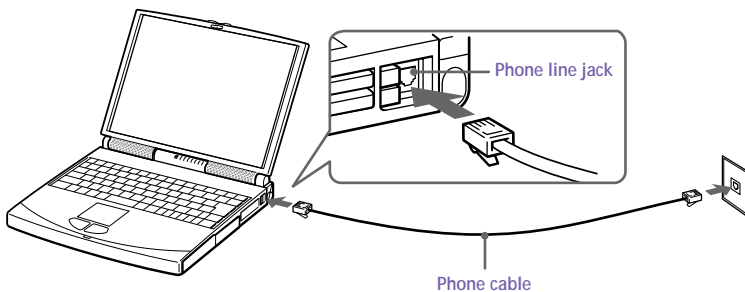

 Your computer does not work with party lines, cannot be connected to a coin-operated telephone, and may not work with multiple phone lines or a private branch exchange (PBX). Some of these connections might result in excess electrical current and could cause a malfunction in the internal modem.

Connecting the Docking Station

Your notebook computer supports the use of an optional docking station. Attaching a docking station enables you to connect additional peripherals to your computer. There are two types of docking stations: the Personal Docking Station (PCGA-DH8) and the Network Docking Station (PCGA-DB8). The Personal Docking Station does not include the SCSI, Network (ethernet), and i.LINK (IEEE 1394 interface) connectors.

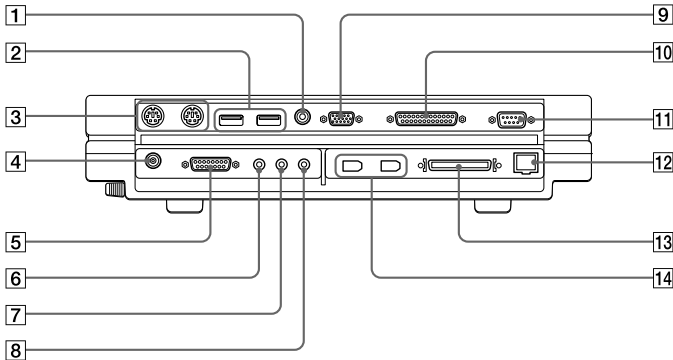

1 Video Out*

2 USB (page 62)

3 Mouse/Keyboard (page 57)

4 DC In (page 8)

5 Game

6 Microphone (page 59)

7 Line In

8 Line Out

9 Monitor (page 54)

10 Printer (page 53)

11 Serial (page 60)

12 Network (ethernet)†

13 SCSI†

14 i.LINK™ (IEEE 1394) (page 61)†

* Not available for the PCG-838.

† Network docking station only.



The docking station can be powered only with an AC power adapter. Do not remove the AC adapter from the docking station or the AC outlet while using the docking station; this may cause data damage or hardware malfunctions.

When your computer is connected to the docking station, you cannot use the System Suspend or System Hibernation power saving modes.

Your computer should not be connected to the docking station when playing DVD-ROM discs.

To attach your computer to the docking station

To supply power to your computer while it is connected to the docking station, you can connect the AC adapter directly to the docking station.

- 1 Turn off your computer and disconnect all peripherals.
- 2 On the back of the computer, lift the docking station port cover.

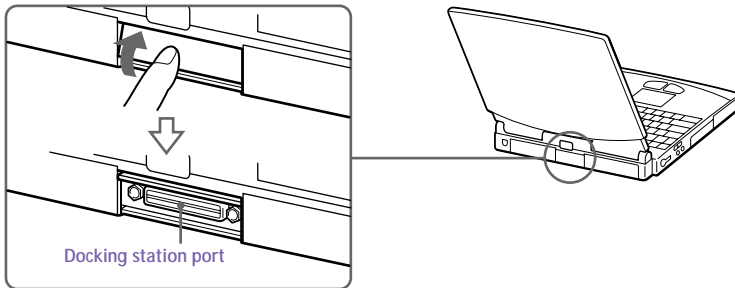

- 3 Align the indentation on the bottom of the computer with the guide post on the docking station.

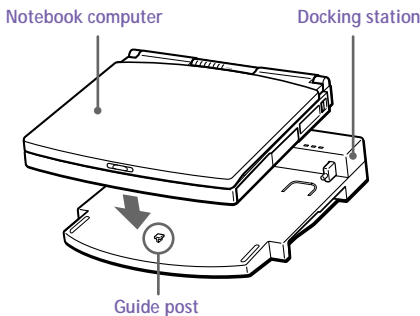

- 4 Make sure the docking station lever is in the **RELEASE** position. Align the guide posts on the docking station with the openings on the back of the computer, and then slide the computer in the direction of the arrow until it stops.

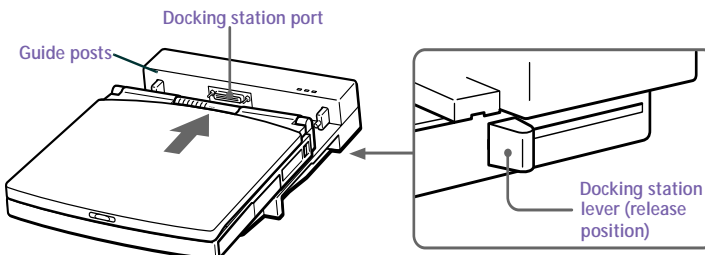

- 5 Slide the docking station lever into the **LOCK** position to secure your computer in the docking station.

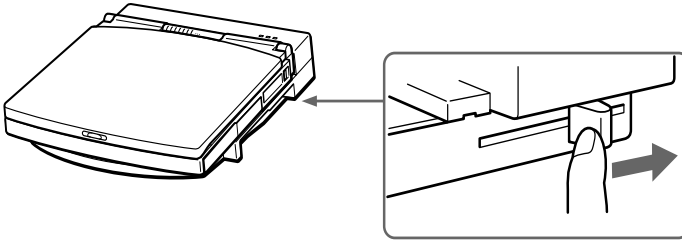

- 6 Plug the cable attached to the AC adapter into the **DC IN** connector on the docking station. Plug the power cord into the AC adapter and an AC outlet.

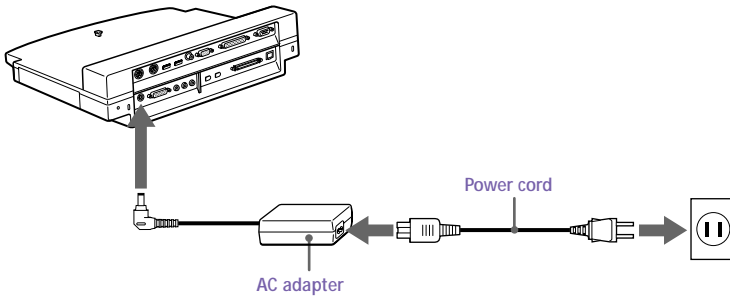

 Use the AC adapter that comes with your computer or the optional Sony PCGA-AC7/PCGA-AC71 adapters.

The **⓪** power indicator light turns green.

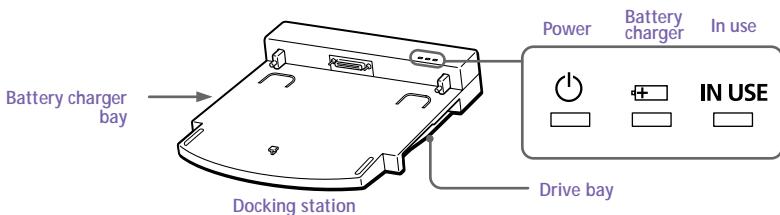

- 7 Turn on the computer.

The **IN USE** indicator light turns on.

To charge a battery pack using the docking station

- 1 Open the cover of the battery charger bay.

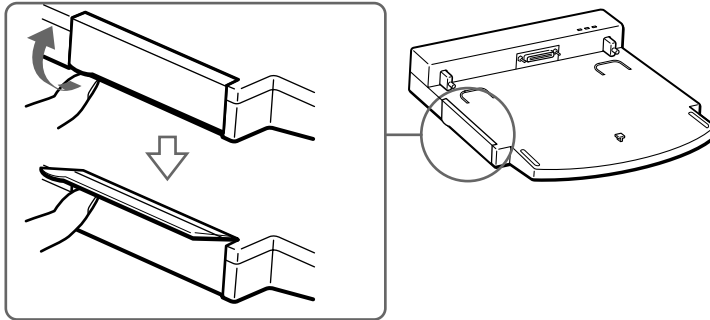

- 2 Insert the battery pack.

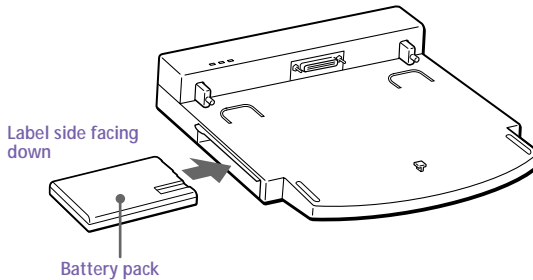

- 3 When the battery pack is fully inserted, close the cover.

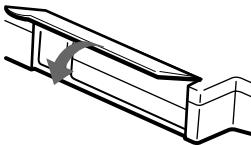

- 4 Connect the docking station to an AC outlet.

The docking station automatically charges the battery. The  battery charger indicator light is on while the battery is charging. When the battery is fully charged, the battery charger indicator light turns off.



Make sure the docking station is in a horizontal position and do not move the docking station while the battery is in the docking station charger bay.

To operate your computer using battery power, you must insert the battery in the computer's battery bay. The docking station bay is designed to charge batteries and cannot be used as a power source for your computer or docking station.

When charging two batteries at the same time, the battery in the computer's battery bay has priority over the battery in the docking station's battery bay. Use the computer's battery bay to charge the battery if you are in a hurry.

If the computer is attached to the docking station, you cannot charge the battery in the docking station battery bay while the computer's power indicator light is green or amber.

The  battery charger indicator light indicates that the battery is charging. To determine the actual amount of charge, insert the charged battery in the computer and use BatteryScope (see "Displaying Battery Information" on page 70).

To remove the battery pack

- 1 Open the cover of the battery charger bay.
- 2 Press the Eject button.

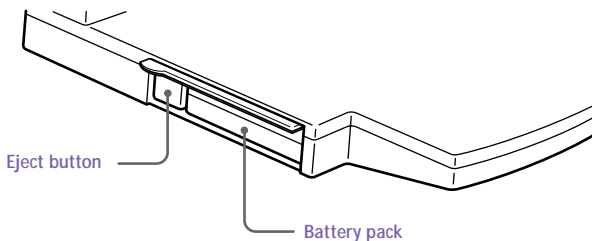

- 3 Pull out the battery pack.
- 4 Close the cover of the battery charger bay.

To insert the floppy disk drive into the docking station

You can use the floppy disk drive in the docking station while you are using the DVD-ROM drive in the computer. By using the drive bays in both the computer and the docking station, you can use both drives at the same time.

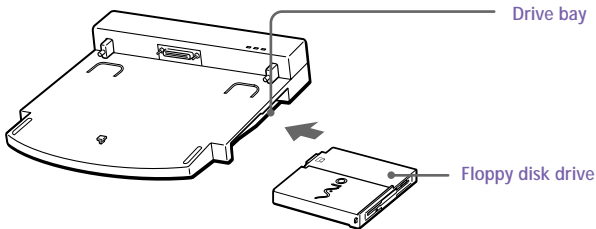

Turn off the computer before inserting or removing the drive.

Use of the DVD-ROM drive in the docking station is not supported.

To remove the drive

There is an Eject lever on the bottom of the drive. Slide the lever in the direction of the arrow, and then pull the drive out of the bay. Insert the weight saver into the drive bay. See “Using the Weight Saver” on page 42. Do not leave the drive bay empty.

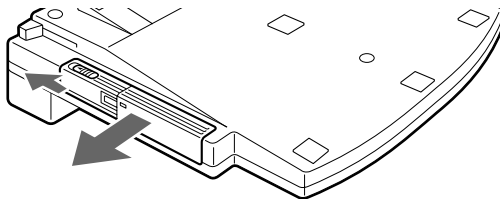

To remove your computer from the docking station when the power is on

- 1 Insert a charged battery in the computer.
- 2 On the Start menu, select Eject. Alternatively, press Fn+F9.

The **IN USE** indicator turns off. If you press Fn+F9, the computer beeps.



Do not remove the computer before the **IN USE** indicator light turns off. Removing the computer before the light turns off may cause a malfunction.

- 3 Slide the docking station lever forward into the **RELEASE** position to disengage the computer from the docking station.

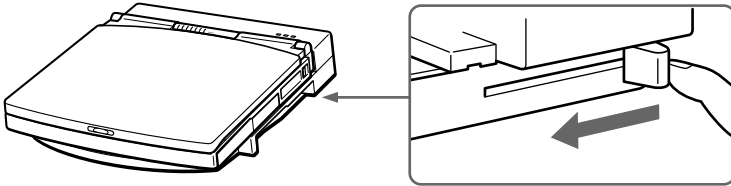

- 4 Lift the computer away from the docking station.

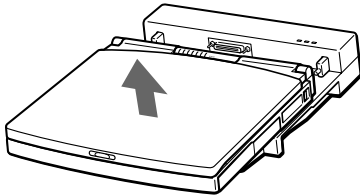

- 5 Close the docking station port cover on the back of your computer.



You cannot remove your computer from the docking station when the power is on unless you insert a charged battery in the computer first.

To remove your computer from the docking station when the power is off

- 1 Turn off your computer and the connected peripherals.
- 2 Slide the docking lever forward into the **RELEASE** position to disengage the computer from the docking station.
- 3 Lift the computer away from the docking station.
- 4 Close the docking station port cover on the back of your computer.



If the docking station lever does not move, insert a thin, pointed object into the manual eject hole on the rear of the docking station.

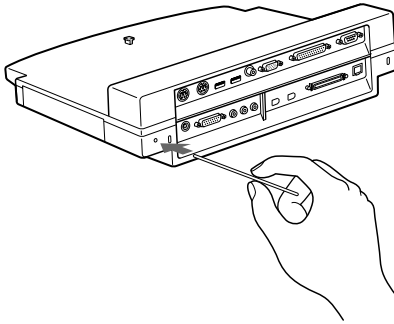



Connecting a Printer

You can connect a Windows 98-compatible printer to your computer to print documents.

To connect a printer

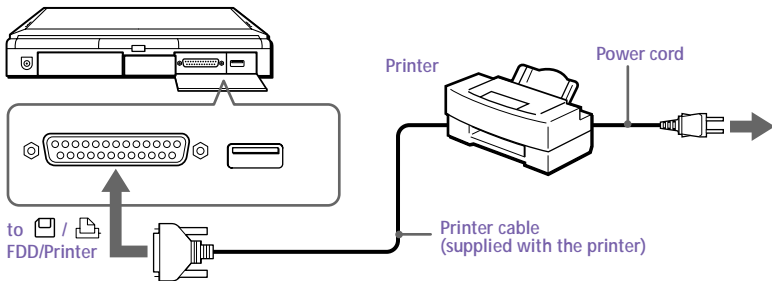
- Use the  symbol to locate the FDD/Printer connector. Plug the printer cable (supplied with the printer) into this port on the computer.



 See the manual that came with your printer for more information on installation and use.

Before using the printer, you may need to change the FDD/Printer setting in the Sony Notebook Setup software. See "Displaying the Sony Notebook Setup Screen" on page 63.

Connecting an External Display

You can connect an external display to your notebook computer. For example, you can use the computer with any of the following:

- ❑ Computer display (monitor) (page 54)
- ❑ Multimedia computer display (page 55)
- ❑ Projector (page 56)

To connect a computer display

- ❑ Use the  symbol on the back of the computer to locate the Monitor connector. Plug the display cable into this connector on the back of the computer.
- ❑ If necessary, plug one end of the display power cord into the display, and the other end into an AC outlet.

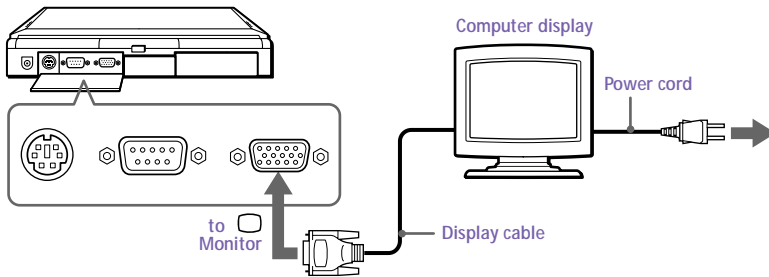

See the manual that came with your computer display for more information on installation and use.

To connect a multimedia computer display

You can connect the notebook computer to a multimedia computer display that includes built-in speakers and a microphone.

- 1 Use the □ symbol to locate the Monitor connector. Plug the display cable into this connector.
- 2 Use the ♫ symbol to locate the Headphone connector. Plug the speaker cable into this connector.
- 3 Use the 🎤 symbol to locate the Microphone connector. Plug the microphone cable into this connector.

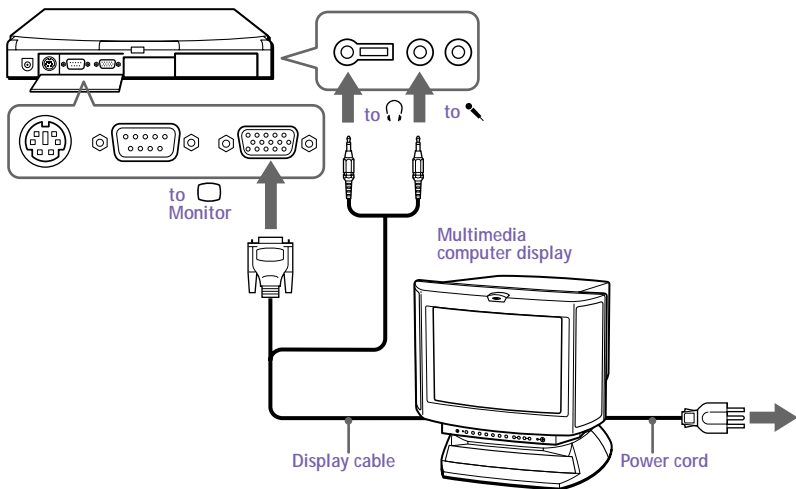

See the manual that came with your multimedia computer display for more information on installation and use.

To connect a projector

You can use a projector, such as the Sony LCD Projector, as an external display.

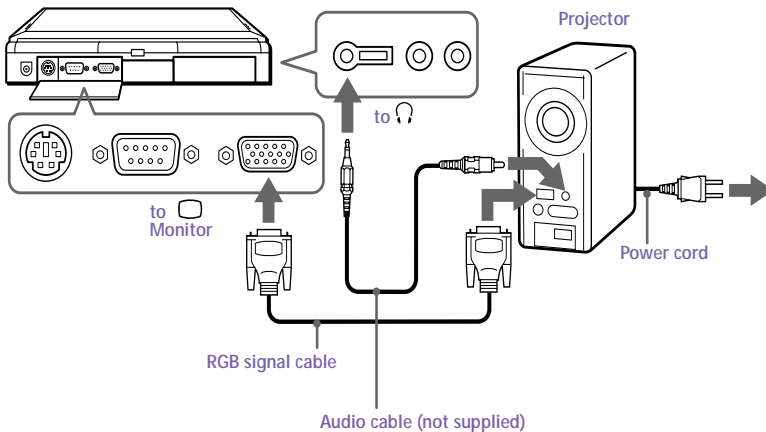

See the manual that came with your projector for more information on installation and use.

To select a display

When you connect an external display to the monitor connector, you can toggle the output among the Liquid Crystal Display (LCD), the external monitor, or both devices.

Use the Fn+F7 keys to select a display. See also “Selecting the Display Mode” on page 73 for more information.



To	Press	Result
Switch to an external display	Fn+F7	Toggles among the LCD, the external display connected to the Monitor connector, and both the LCD and external display.

Only LCD → LCD and external display → Only external display → Only LCD

Connecting an External Mouse or Keyboard

You can connect an external mouse or keyboard to your computer. To connect both a mouse and a keyboard, use the docking station (see “Connecting the Docking Station” on page 45). The Mouse/Keyboard connector requires a PS/2[®]-style plug or adapter.

To connect an external mouse or keyboard

- ❑ Use the  symbol to locate the Mouse/Keyboard connector. Plug the keyboard cable or mouse cable into this connector with the  mark facing up.

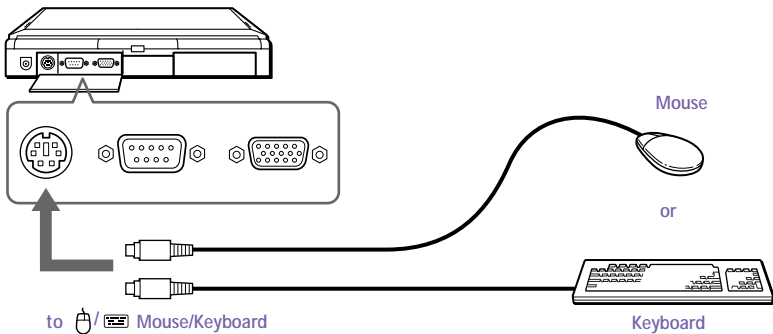

 See “Using the Keyboard” on page 16 for more information on using the keyboard.

See the manual that came with your mouse or keyboard for more information on installation and use.

Before you connect or disconnect the mouse or keyboard, turn off the computer.

Before connecting a mouse to the Serial port, make sure the mouse is compatible with a serial port.

Connecting External Speakers

You can enhance the sound quality of your computer by connecting external speakers.

 Make sure your speakers are designed for computer use.

Turn down the volume of the speakers before you turn them on.

Do not place diskettes on the speakers; the speakers' magnetic field may damage the data on the diskettes.

To connect external speakers

- Use the  symbol to locate the Headphone connector. Plug the speaker cable into this connector.

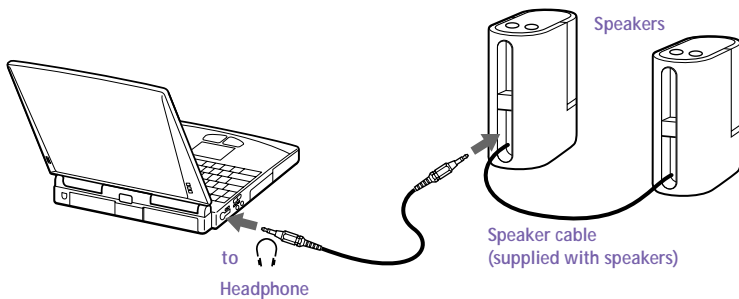

 See the manual that came with your speakers for more information on installation and use.

Connecting an External Microphone

You can enhance the quality of sound input by using an external microphone.

 Make sure your microphone is designed for computer use.

To connect an external microphone

- Use the  to locate the Microphone connector. Plug the microphone cable into this connector.

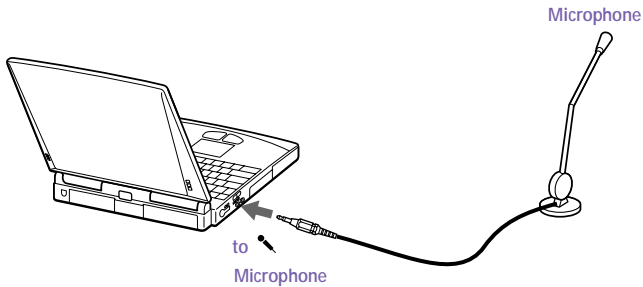

 See the manual that came with your microphone for more information on installation and use.

Connecting a Digital Still Camera or Other Serial Device

You can connect other computer peripherals, such as the Sony Digital Still Camera, to the Serial connector on your computer.

To connect a digital still camera

- Use the  symbol to locate the Serial connector. Plug the connecting cable into this port on the computer and into the Digital I/O connector on the digital still camera.

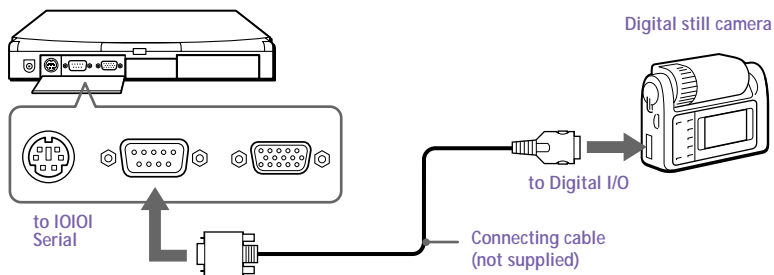

 The Sony Digital Still Camera is pictured; you may need to connect your camera differently.

See the manual that came with your digital camera or other serial device for more information on installation and use.

If you use a digital camera that has an infrared data communication system or other infrared communication device, see "Using Infrared Communication Devices" on page 36.

Connecting a Digital Video Camera Recorder

You can connect a digital video camera recorder to the i.LINK (IEEE 1394) connector on the docking station. See “Connecting the Docking Station” on page 45.

To connect a digital video camera recorder

- ❑ Plug one end of the i.LINK cable into the i.LINK connector on the rear of the docking station and the other end into the DV In/Out connector on the digital video camera recorder.

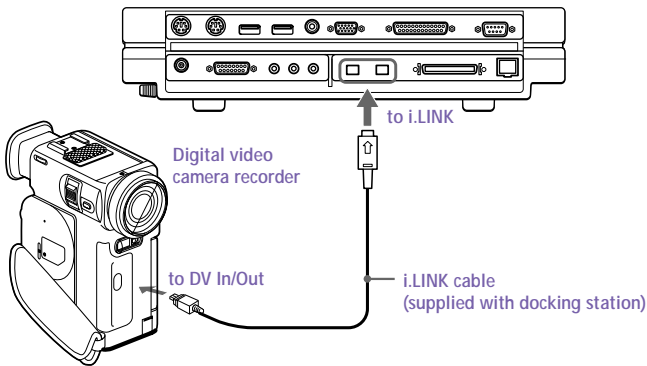

The Sony digital video camera recorder (DCR-PC7) is pictured; your digital video camera recorder may need to be connected differently.

On Sony digital video cameras, connectors labeled “DV In/Out” or “i.LINK” are i.LINK-compatible.

See the manual that came with your digital video camera recorder for more information on installation and use.

Do not connect more than one digital video camera at a time. The software supplied with your computer will not recognize multiple cameras.

The i.LINK connector on the docking station does not supply power to external devices. If the external device requires power from the i.LINK connector, you cannot use the device with the docking station.

The docking station supports transfer rates up to 200 Mbps; however, the actual transfer rate is the lowest transfer rate of the external device.

The i.LINK features available may vary depending on the software applications you use. See the documentation that came with your software for more information.

Connecting a Universal Serial Bus (USB) Device

You can connect a USB device to your computer.

To connect a USB device

- Use the  symbol to locate the USB connector. Plug one end of the USB cable into this port and the other end into the USB device.

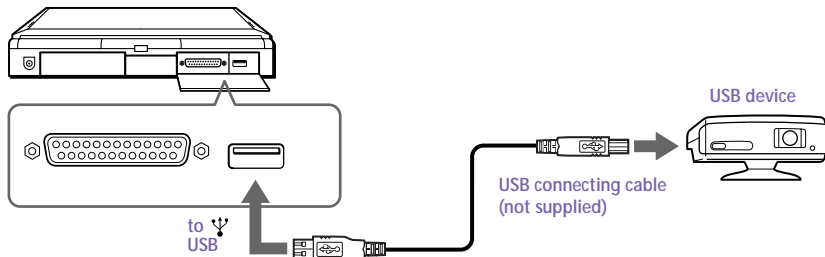

 See the manual that came with your USB device for more information on installation and use.

When you enable the PowerPanel setting that allows the computer to enter System Suspend mode or System Hibernation mode, your computer may enter System Suspend mode or System Hibernation mode while you are using a USB device, such as a USB mouse or a USB keyboard. Therefore, when using a USB device, select the AC Profile or change the profile setting in PowerPanel so that the computer does not enter System Suspend mode or System Hibernation mode. The default AC Profile settings do not allow the computer to enter System Suspend mode or System Hibernation mode. For details, see the PowerPanel Help.

Customizing Your Notebook Computer

You can customize the settings of your notebook computer. The following sections briefly describe how to change your computer's default settings. You can also refer to the Sony Notebook Setup Help for more detailed information.

Displaying the Sony Notebook Setup Screen

To display the Sony Notebook Setup screen:

- 1 Click the Start button on the Windows 98 taskbar.
- 2 Point to VAIO and click Sony Notebook Setup.

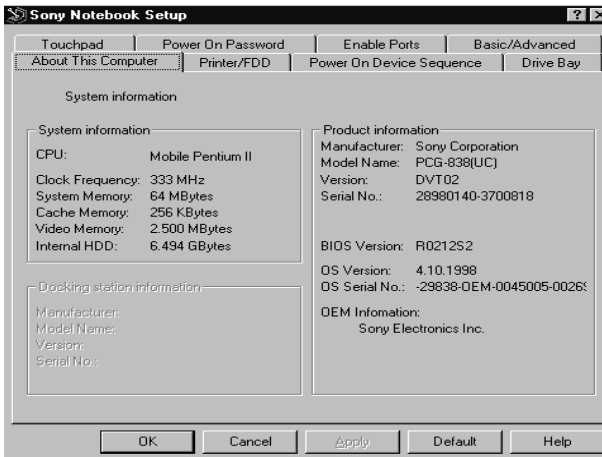

- 3 Select the tab for the item you want to change. See "Notebook Setup Tabs" on page 64.
- 4 After you finish, click OK.

Notebook Setup Tabs

<i>Tab</i>	<i>Descriptions</i>
About This Computer	Display system information, including memory capacity, serial number, and BIOS version.
Printer/FDD	Switch between connecting a printer or floppy disk drive without turning off the power. Change printer port mode settings.
Power On Device Sequence	Select the order of drives and devices from which you want to load the operating system. You can specify the hard drive inserted into the docking station as well as other drives inserted into your computer.
Touchpad	When you connect an optional mouse to the Serial port of your computer, you can make your touchpad inactive. You can also customize the settings of your mouse using the mouse utility.
Drive Bay	Change the device in the drive bay without turning off the power.
Power On Password	Set the password to secure your computer.
Enable Ports	Change the hardware resources such as I/O address, IRQ, or DMA depending on the optional hardware or software you use. Disabling ports releases resources to the system. To change the serial, audio, and modem settings, click Advanced on the Basic/Advanced tab.
Basic/Advanced	Toggle between Advanced mode (additional screens with advanced settings) and Basic mode of display. Advanced mode includes Serial, Audio, Built-in Modem, Enable Ports, View Resources, and Infrared tabs.



For more information about each option, click Help on the Sony Notebook Setup screen to display the help file.

Changing Devices in the Drive Bay Using the Drive Bay Tab

To exchange devices while the power is on, you should be aware of the following:







- ❑ Do not attempt to change devices in the drive bay while the power is on unless you use the sequence of steps on the Drive Bay tab.
- ❑ Do not switch to System Hibernation mode or System Suspend mode while changing a device.
- ❑ Do not change a device in the drive bay while your computer is accessing a CD-ROM, DVD-ROM, or floppy disk. Doing so may cause loss of data. Be sure to close active applications, other than Sony Notebook Setup, before changing a device.
- ❑ When installing a hard disk drive to the drive bay for the first time, it may take several minutes before you are able to use your computer.
- ❑ For optimum performance, you should turn off your computer when you insert a hard disk drive. If you insert a hard drive without turning off the power, you must reboot in order for the drive to run at optimum speed.
- ❑ When changing a device in the drive bay of the docking station, you must turn off the computer.



Controlling Power Management

The PowerPanel utility allows you to control the power management of your notebook computer and provides key information about system activity and battery life. The following sections briefly describe how to conserve your computer's battery power. You can also refer to the PowerPanel Help for more detailed information. To activate a profile or command, see "To activate the PowerPanel Profiles toolbar" on page 68.

Power Management Profiles





PowerPanel provides four predefined power management profiles. Each profile consists of a group of specific power management settings that are designed to meet specific power management goals—ranging from maximum power management to no power management. You can change the settings for any of the predefined profiles or you can create your own profile to suit your portable computing needs. The predefined profiles are:



<i>Icon</i>	<i>Description</i>
	Maximum Performance – Provides the best system performance while still conserving power.
	Maximum Battery Life – Provides power saving features to give you maximum battery life and good performance. It slows the computer and puts it into System Suspend mode after a specified time period.
	Power Management Off – Turns off all power management features such as System Suspend and System Hibernation modes.
	AC Profile – The power management state when AC power is in use. Similar to the Power Management Off setting. PowerPanel automatically loads the AC profile unless you disable this feature.
	Games – Disables the display and the Hard Disk Spindle Down timer.
	Presentation – Keeps the display on at all times while it conserves power. This option is ideal for slide show presentations. You can establish settings for LCD (Video) Standby, Hard Disk Sleep, and System Suspend to optimize power management for your system.

<i>Icon</i>	<i>Description</i>
	Word Processing – Optimizes power management with longer timeouts on the hard disk and display screen. You can also establish settings for LCD (Video) Standby, Hard Disk Sleep, and System Suspend to optimize power management for your system.
	Communications – Extends battery life by initiating a quick display timeout. The Internal modem remains powered. You can also establish settings for LCD (Video) Standby, Hard Disk Sleep, and System Suspend to optimize power management for your system.

Power Management Commands

PowerPanel also provides power management commands that you can use to activate specific power management functions and to control power for a specific device. You might use these commands when you want to override a profile setting or initiate an immediate action, such as putting the system into Video Standby mode before the Video Standby timer expires.

<i>Icon</i>	<i>Description</i>
	System Suspend – Puts the system into System Suspend mode, a power management state that saves the state of the system and peripheral devices in memory (RAM). Power consumption reduces to a minimum, and the system remains on. To return the system to the active state, press any key or the power switch on your computer.
	System Hibernation – Provides for the lowest level of power consumption. The system writes the state of the system and peripheral devices to the hard disk and turns off the system power. To return the system to the original state, use the power switch to turn on power. The system saves the data in the Save to Disk Partition on the hard drive.
	LCD (Video) Standby – Turns off the LCD to save power. If you turn off the Video Standby timer, the display remains active except when the system enters System Suspend mode. The video display system is one of the largest consumers of power in the system.
	Hard Disk Sleep – Turns off the hard disk spindle motor. Although you can manually turn off the power to the hard disk through this command, any system request to the hard disk turns on the power to the hard disk.

Icon	Description
	CPU Speed Control - Controls the speed at which the CPU performs. Click this button to open the Speed Control dialog box. When you select the Autocheck box, the CPU performs at full speed while the system is active and at 25% of full speed during periods of inactivity. Auto is the recommended option. You can also choose to run the CPU at 100%, 75%, 50%, or 25% of full speed regardless of whether the system is active or inactive. Using this command can help conserve battery power.
	PC Card – Controls the PC card sockets. Click this button to open the PC Card (PCMCIA) Properties dialog box. You can view the properties for the PC cards.

To activate the PowerPanel Profiles toolbar

- 1 Double-click the  (atom) icon on the taskbar.

The Profiles toolbar appears. When you move the pointer over the atom icon on the taskbar, a tooltip with the name of the active power management profile appears.



 When the Profiles toolbar is already visible on the desktop, double-clicking the atom icon hides the toolbar.

- 2 Click the button you want to set.

The power management settings associated with the profile you select become active.

 To display the Commands toolbar, right-click an empty portion of the toolbar and select Commands from the shortcut menu. Refer to the PowerPanel Help for information on customizing the PowerPanel toolbars.

When you use the battery pack to power your computer, your system selects the Maximum Battery Life power management profile by default. If you select a different power management profile while using battery power, that profile is selected automatically the next time you use the battery pack to power your computer.

Changing the power management settings using the PowerPanel Profiles toolbar

You can change power management settings, such as the settings for the System Suspend timer or the speed at which the CPU performs.

- 1 Click the  (atom) icon on the taskbar. The PowerPanel bar appears. (If the bar does not appear, click the Start button and point to Tool Center. Then point to Notebook Utility and select PowerPanel.)
- 2 Right-click the Profiles icon for the item you want to change, then click Open. The Profile Manager starts.
- 3 Double-click the item you want to change. A list of settings appears with a check mark indicating the current setting.
- 4 Click the desired setting.
- 5 Click the File menu, then click Save.
- 6 Click the File menu, then click Close. The Profile Manager closes and the new setting is activated.

Displaying Battery Information

You can display detailed information for each of the batteries in your computer and docking station. The following sections briefly describe how to display your computer's general battery information. You can also refer to the BatteryScope Help for more detailed information.

Activating BatteryScope

To activate BatteryScope

- 1 Click the Start button on the Windows 98 taskbar.
- 2 Point to Tool Center and click BatteryScope. The battery icon appears on the taskbar.

When you move the pointer over the battery icon on the taskbar, a tooltip appears indicating the total capacity remaining in the battery and the estimated time until the battery fully discharges.

You can also view battery gauges on the shared PowerPanel and BatteryScope toolbar.



- **Percentage indicator**
Displays the percentage of the remaining capacity.
- **Time indicator**
Displays estimated time (hours/minutes) remaining before the battery fully drains, also referred to as the time-to-empty.

Battery Icon Descriptions

Battery icon	Battery status
	Discharging
	Charging
	Not in use
	No battery



Displaying Detailed Battery Information

You can obtain detailed information about the batteries.

- ❑ Click the battery icon on the toolbar to display the BatteryScope window.

The screen appears displaying the General tab, which contains information such as the estimated time-to-empty and charging time.

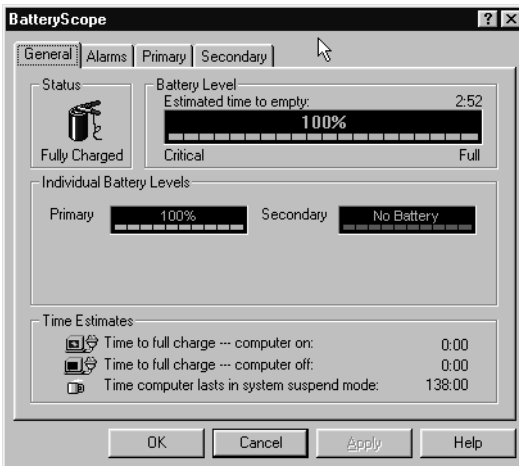

To display information on individual batteries

- 1 Click the Primary battery tab to display information for the battery in the bay on the left side.
- 2 Click the Secondary battery tab to display information for the battery in the bay on the right side.

You can display the information about each battery, such as estimated time-to-empty, manufacturer, capacity, and other information.

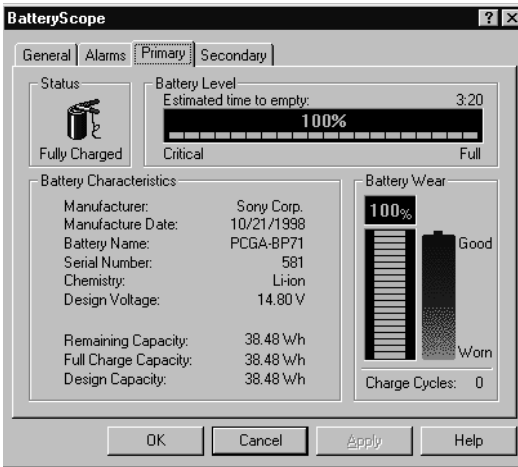

To customize the BatteryScope toolbar and alarm system

You can customize the BatteryScope toolbar to suit your portable computing needs, including modifications to the alarm settings. Refer to the BatteryScope Help for more information.

Selecting the Display Mode

When you connect an external display, you can toggle the display mode between the LCD on your computer and external displays.

- 1 Click the Start button on the Windows 98 taskbar.
- 2 Point to Settings and click Control Panel.
- 3 Click Display.
- 4 Click the Settings tab, then click the Advanced button.
- 5 Click the NeoMagic® tab.

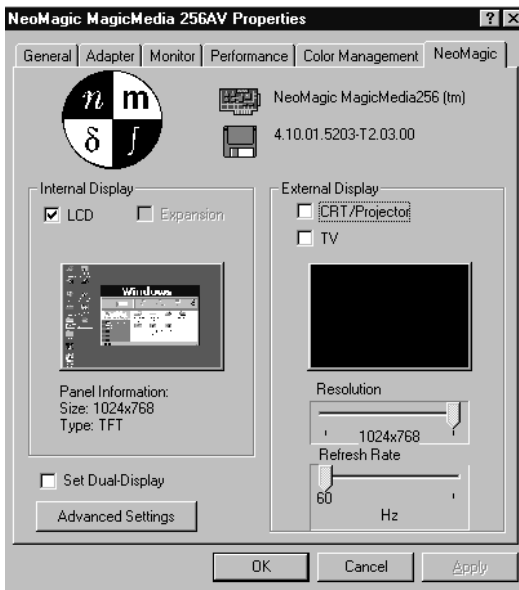

6 Select the type of external display:

CRT/Projector	Displays an external computer display or RGB connected projector that is connected to the Monitor connector on your computer.
TV	This feature is not available on the PCG-838.



If you select CRT/Projector, you can turn off the computer's LCD display by removing the checkmark from the LCD option under Internal Display.

If you select CRT/Projector and turn off the LCD, you can use the Refresh Rate slider to change the display's horizontal frequency. This setting can be made only for CRT display. If you select Independent Display Timing (see page 75), you can change both the resolution and the refresh rate.

7 Click OK. If you have made changes, the System settings change dialog box appears. Select Yes to restart Windows.

8 If you have not made changes, click OK to close the Display Properties screen.



Depending on the types of computer displays and projectors you are using, you may not be able to display the computer's LCD and external display simultaneously.

Using a CRT or Projector

When you select CRT/Projector as the display mode, you can make additional settings, described as follows:

- 1 After selecting CRT/Projector as the type of external display (step 6 on page 74), click Advanced Settings.
- 2 Click the External Display Options tab.
- 3 Select the following options:

External Display Device:

CRT	Connects with the external computer display.
-----	--

Projector	Connects with the projector.
-----------	------------------------------

Monitor Settings:

Independent Display Timing	Click to place a checkmark when you want to set the resolution and refresh rate differently from the computer's LCD. To change the resolution and refresh rate, see the notes to step 6 on page 74.
----------------------------	---

Projector Settings:

Type	Select the projector's resolution from the drop-down box.
------	---

- 4 Click OK.



You cannot select Independent Display Timing when the display is set to True Color (24 bit).

Display Specifications

LCD Display Mode

<i>Resolution</i>	<i>Number of colors</i>
1024 x 768	16,770,000*
800 x 600	16,770,000*
640 x 480	16,770,000*

* Achieved by graphic accelerator's dithering function

External Display Mode

<i>Resolution</i>	<i>Number of colors</i>
1280 x 1024	256
1024 x 768	16,770,000
800 x 600	16,770,000
640 x 480	16,770,000

Using the Dual Display Function

The dual display function allows you to distribute portions of your desktop across separate displays. For example, if you have an external monitor attached to the monitor connector, your LCD display and the monitor can function as a single desktop. You can move the cursor off one display and onto the other. This allows you to drag objects, such as an open application window or a toolbar, from one display to the other. This configuration of a single desktop distributed across separate displays is referred to as a virtual desktop.

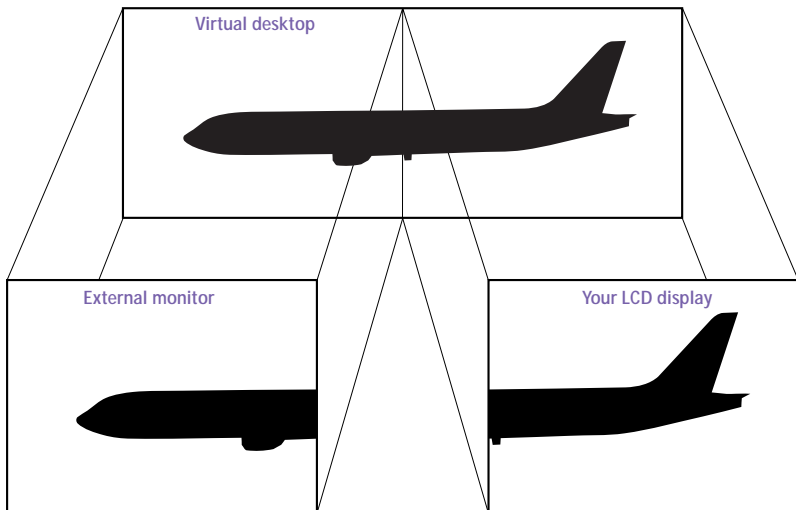

Selecting dual display mode

You must restart Windows to use dual display mode. Save your work and close any open applications before changing to dual display mode, then follow these steps:

- 1 Click the Start button on the Windows 98 taskbar.
- 2 Point to Settings and click Control Panel.
- 3 Click the Display icon.
- 4 Click the Settings tab.
- 5 Click the Advanced button.
- 6 Click the NeoMagic tab.

- 7 Check the Set Dual-Display option and click OK. The System Settings Change dialog box appears.
- 8 Click Yes to restart your system.
- 9 Repeat steps 1 to 3 to display the Display Properties screen.
- 10 Click the display icon number 2.
- 11 Click Yes.
- 12 Click OK.

Setting the colors and resolution for each display

You can set the display colors and resolution for each display that is part of a virtual desktop.

Follow steps 1 to 4 above to display the Display Properties screen. Select the display you wish to change (1 or 2) by clicking on the icon of the display. You can change colors by selecting an option from the Colors list. Use the slider in the Screen area to change the resolution. Click OK or Apply. Click OK to confirm that you want to make the changes.

Customizing the virtual desktop

You can customize dual display mode by changing the position of the two desktops that comprise the virtual desktop.

In the Display Properties screen, drag the icons of display 1 or display 2, moving them to a new position relative to each other. The two display icons must be connected to create a virtual desktop. Click OK to apply the change.

Releasing the dual display setting

You must restart Windows to return to single display mode. Save your work and close any open applications before returning to single display mode. Follow the steps in the section above on Selecting dual display mode. In step 7, remove the check from the Set Dual-Display option. You must restart Windows before the change takes effect.

Getting Help

Sony provides several support options for your Sony computer. When you have questions about your computer and the preinstalled software, check these sources for answers, in the following sequence:

1	<i>VAIO Notebook Computer Read Me First</i>	Contains a complete list of the items that ship with your computer, product specifications, software support information, and the most up-to-date information on using your computer.
2	<i>VAIO Notebook Computer User Guide</i>	Explains how to use your notebook computer and connect peripheral devices.
3	Online <i>User Guide</i>	This electronic version of the <i>User Guide</i> contains additional information on the preinstalled software titles. You can access this guide from the Windows Start menu by selecting Programs/VAIO/Documentation.
4	Manuals and online help files that may accompany your preinstalled software	Most of the manuals for preinstalled software are located on your hard disk drive as online help files. You can access the online help files from the Help menu in the specific application. A printed manual is available for some applications.
5	Knowledge Database	Provides instant access to information on commonly encountered problems. Enter a description of your problem and the Knowledge Database searches for the corresponding solutions online. You can access the Sony Knowledge Database at: http://www.sony.com/pcsupport/

-
- | | |
|---------------------------------|--|
| 6 Sony Fax-on-Demand | This service provides you with answers to commonly asked questions. You can use this automated service to request a list of available topics and then select the topics that you want to receive. To contact the Sony fax-on-demand service, call 1-888-4SONYPC (1-888-476-6972). (Requires a fax machine or your fax software.) |
| 7 Calling Sony Customer Support | You can call and speak with a Sony Customer Support Representative without using your computer by calling 1-888-4SONYPC (1-888-476-6972). Software support is available free of charge for 90 days after the original date of purchase. |
-

Troubleshooting

This section describes how to solve common problems you may encounter when using your computer. Many problems have simple solutions, so try these suggestions before you call Sony Customer Support.



When you reconnect devices be sure to turn off the computer as described in “Shutting Down Your Computer” on page 13. Turning off the computer using other methods may result in data loss.

My computer does not start

- ❑ Check that the computer is plugged into a power source and that it is turned on. Check that the power indicator on the front panel of the computer indicates that the power is on.
- ❑ Check that the battery packs are inserted properly and that they are charged.
- ❑ Make sure there is no diskette in the floppy disk drive.
- ❑ Confirm that the power cord and all cables are connected firmly, as described in “Connecting Peripheral Devices” on page 43.
- ❑ If you plugged the computer into a power strip or UPS, make sure the power strip or UPS is turned on and working.
- ❑ If you are using an external display, check that it is plugged into a power source and turned on. Check that the brightness and contrast controls are adjusted correctly. See the manual that came with your display for details.
- ❑ Moisture condensation may have occurred. Do not use the computer for at least one hour and then turn on the computer.
- ❑ When the internal backup battery is low on power, it may not be able to boot your system properly. You can correct this situation as follows. Plug in the AC adapter and allow the computer to charge for one hour while the power is on. Do not use the computer during this time. After one hour, turn the power off and then on again. To charge the internal backup battery fully, keep the AC adapter connected for more than 24 hours after turning the power on. You can use your computer while charging the battery.

When I turn on my computer, the message “Operating system not found” appears and Windows does not start

- ❑ Check the floppy disk drive to see if a non-bootable diskette is in the drive.
- ❑ If a non-bootable diskette is in the drive, turn off the computer, remove the diskette, and then turn on the computer again. Confirm that Windows starts properly. If Windows still does not start, follow the procedure below to initialize the BIOS.
- ❑ If the floppy disk drive is empty, follow the steps below to initialize the BIOS:
 - 1 Remove any peripheral devices connected to the computer.
 - 2 Turn the computer off and then turn it on again.
 - 3 Turn on the computer and press the F2 key when the Sony logo appears. The BIOS setup menu screen appears.
 - 4 Press the arrow keys to select the Exit menu.
 - 5 Press the arrow keys to select Get Default Values and then press the Enter key. The message “Load default configuration now?” appears.
 - 6 Check that [Yes] is selected, then press the Enter key.
 - 7 Press the arrow keys to select Exit (Save Changes) and then press the Enter key. The message “Save configuration changes and exit now?” appears.
 - 8 Check that [Yes] is selected, then press the Enter key. The computer restarts.

If your computer still displays the message “Operating system not found” and Windows does not start, contact Sony Customer Support.

My LCD does not display anything

- ❑ Check that the computer is plugged into a power source and that it is turned on. Check that the power indicator on the front panel of the computer is on.
- ❑ Check that the battery packs are inserted properly and that they are charged.
- ❑ The computer may be in LCD (Video) Standby mode. Press any key to activate the display.
- ❑ The video output may be directed to an external display. Press Fn+F7 until video output appears on the LCD.

The screen image on my external display is not centered or sized properly

Use the controls on your external display to adjust the image. See the manual supplied with your display for more information.

The video image on my screen is too dark

If an external display is connected to the Monitor connector, disconnect the display.

My computer "locks up"

- ❑ Try restarting the computer. On the Windows taskbar, click the Start button, click Shut Down, and then click Restart the computer.
- ❑ If you cannot restart as described in the preceding step, you can restart the computer by pressing Ctrl+Alt+Delete.
- ❑ If the previous step does not work, slide the power switch toward the front and hold it for at least four seconds. This turns off the power.
- ❑ If your computer locks up while playing a CD-ROM, stop the CD-ROM, and restart the computer by pressing Ctrl+Alt+Delete.



Pressing Ctrl+Alt+Delete may result in data loss in files that are currently open.

My software program "locks up" or crashes

Contact the software publisher or designated provider for technical support. See the online *User Guide* for a complete list of phone numbers.

My DVD-ROM drive tray does not open

- ❑ Check that the DVD-ROM drive is properly inserted.
- ❑ Make sure the computer is turned on.
- ❑ Press the Eject button on the DVD-ROM drive.
- ❑ If the Eject button does not work, you can open the tray by inserting a sharp, pointed object into the hole to the right of the Eject button.

I cannot play a CD-ROM

- ❑ Make sure the label of the CD-ROM is facing up.
- ❑ If the CD-ROM requires software, make sure the software is installed according to the program's instructions.
- ❑ Moisture condensation may have occurred. Leave the computer for at least 1 hour while the computer is turned on.
- ❑ Make sure the DVD-ROM drive is properly inserted.
- ❑ Clean the CD-ROM.
- ❑ Check the speaker volume.

I cannot play a DVD-ROM

- ❑ If a region code warning appears when you are using the DVD player, it could be that the DVD-ROM you are trying to play is incompatible with the DVD-ROM drive in your notebook computer. The region code is listed on the disc's packaging.
- ❑ If you hear audio but cannot see video, your computer's video resolution may be set too high. For best results, change the Windows Control Panel/Display/Settings to 800 x 600 using 256 colors.
- ❑ If you see video but cannot hear audio, check all of the following: Make sure the mute setting is off in your DVD player. Check the master volume setting in the audio Mixer. If you have connected speakers externally, check the volume settings in your computer speakers and check the connections between your speakers and the computer. Check the Windows Control Panel/System/Device Manager to see that the drivers are installed properly.
- ❑ A dirty or damaged disc may cause the computer to "hang" while it tries to read the disc. If necessary, reboot the computer, remove the disc, and then check that it is not dirty or damaged. For cleaning instructions, see "On Cleaning CD-ROMs and DVD-ROMs" on page 94.

When I click an application icon a message appears, such as "You must insert the application CD into your CD-ROM drive", and the software does not start

- ❑ Some titles require specific files that are located on the application's CD-ROM. Insert the disc and try starting the program again.
- ❑ Make sure you place the disc in the tray with the label side facing up.

My floppy disk drive cannot write to a diskette

- ❑ If the diskette is write-protected, disable the write-protect feature or use a diskette that is not write-protected.
- ❑ Check that the diskette is properly inserted into the floppy disk drive.

My speakers have no sound

- ❑ If the built-in speakers are turned off, press Fn+F3 to turn on the speakers.
- ❑ If the speaker volume is turned to the minimum, press Fn+F4, and then press **↑** or **→** to increase the volume.
- ❑ If your computer is powered by batteries, check that the battery packs are inserted properly and that they are charged.

- ❑ If you are using an application that has its own volume control, check that the volume is turned up.
- ❑ Check the volume controls in Windows 98.
- ❑ If you connect external speakers, check that the speakers are properly connected and the volume is turned up. If the speakers have a mute button, make sure it is off. If the speakers are powered by batteries, check that the batteries are inserted properly and that they are charged.
- ❑ If you have connected a headphone or an audio cable to the Headphone connector, disconnect the cable.

When I press Fn+F3, I see the message "Sound Disabled"

Click the System icon in the Control Panel. Change the settings under Device Manager so that sound is enabled.

My modem does not work

- ❑ Check that the phone line is plugged into the line jack. See "Connecting a Phone Line" on page 44 for details.
- ❑ Check that the phone line is working. You can check the line by plugging in an ordinary phone and listening for a dial tone.
- ❑ Check the PowerPanel modem setting. Select Modem On from the PowerPanel toolbar or menu.
- ❑ Check that the phone number the program is dialing is correct.
- ❑ Check that the software you are using is compatible with the notebook computer modem. (All preinstalled programs are compatible.) Call the software publisher or Sony Customer Support.

My modem connection is slow

The computer's modem uses K56flex™ technology and V.90 capability. Many factors influence modem connection speed, including telephone line noise or compatibility with telephone equipment (such as fax machines or other modems). If you think your modem is not connecting properly to other PC-based modems, fax machines, or your Internet Service Provider, check the following:

- ❑ Have your phone company check that your phone line is free from any line noise.
- ❑ If your problem is fax-related, check that there are no problems with the fax machine you are calling and that it is compatible with fax modems.

- ❑ If you are having a problem connecting with your Internet Service Provider, check that the ISP is not experiencing technical problems.
- ❑ If you have a second phone line available, try connecting the modem to that line.

My microphone does not work

If you are using an external microphone, check that the microphone is plugged into the Microphone connector. See “Connecting an External Microphone” on page 59 for details.

My mouse does not work

- ❑ If you are using an external mouse, check that the mouse is plugged into the mouse connector. See “Connecting an External Mouse or Keyboard” on page 57 for details.
- ❑ If you connected an external mouse while your computer is on, you must restart your computer.

I cannot use DV devices. The message “DV equipment seems to be disconnected or turned off” appears.

- ❑ Check that the DV device is turned on and that the cables are properly connected.
- ❑ If you are using multiple i.LINK devices, the combination of the connected devices may cause unstable operation. In this case, turn off the power to all connected devices and disconnect unused devices. Check the connection, then turn on the power again.

My touchpad interprets a single tap as a double-click

Click the Mouse icon in the Control Panel and then change the button assignments in the Mouse Properties dialog box. One of the buttons is assigned to the double-click action.

My computer does not shut down

It is best to shut down your computer using the Shut Down command on the Windows 98 Start menu. Using other methods, including those listed here, may result in loss of unsaved data. If the Shut Down command does not work properly, follow these steps:

- ❑ Restart the computer by pressing Ctrl+Alt+Delete. If this does not work, slide the power switch forward and hold it for at least four seconds to turn off the power.
- ❑ Unplug the computer from the AC adapter and remove the battery pack from your computer.

My PC card is not working

- ❑ Make sure the PC card is compatible with Windows 98.
- ❑ Use the Sony Notebook Setup utility to disable devices you are not currently using.

The sound of my computer's fan is too loud

Use the PowerPanel utility to change the Thermal Control Strategy setting to Quiet. This setting disables the fan. See the PowerPanel Help for more information.

I cannot print

The default setting for the printer port mode is correct for most printers. If you cannot print, try changing the printer port mode. In Sony Notebook Setup, select the Printer/FDD tab. If the printer port mode is set to ECP, change it to bi-directional. If the printer port mode is set to bi-directional, change it to ECP. See “Displaying the Sony Notebook Setup Screen” on page 63 for details on using Sony Notebook Setup.

Using the System and Application Recovery CDs

The following sections describe how to use the System Recovery and Application Recovery utilities.

Using the System Recovery CD(s)

You can reinstall software titles that shipped with your computer if they are corrupted or accidentally erased. You may not need to recover the entire contents of your hard drive. If you experience a problem with your computer, reinstalling an individual device driver or software title may correct the problem. Use the Application Recovery CD(s) to reinstall individual applications or device drivers. See “Using the Application Recovery CD(s)” on page 90.

The System Recovery CD contains a backup copy of all the software originally installed on your hard disk drive. **It can be used only to recover the hard disk of the notebook computer you purchased.**

The System Recovery utility gives you three options:

- ❑ **Full Restore without Format** restores all the software titles that originally came with your computer without formatting the hard disk.
- ❑ **Full Restore with Format** formats the hard disk drive and then restores all the original software.
- ❑ **Operating System Only** restores the Windows 98 operating system, the notebook computer utility programs, and the device drivers that shipped with your computer.

! If you choose the Full Restore with Format or Operating System Only option, your hard disk will be formatted, which removes all the information on the hard disk drive. You will lose any software you have installed and any other files you have created since you started to use your computer. This means you will have to reinstall any applications that were not included with the computer when you purchased it. If you choose the Full Restore without Format option, you may need to reinstall applications that were not included with the computer when you purchased it. If you have any questions on using the System Recovery CD, contact Sony Customer Support.

To use the System Recovery CD(s)



The DVD-ROM drive must be inserted in the computer to use the System Recovery CD. You cannot use the DVD-ROM drive in the docking station.

You need to complete the Windows 98 registration process when you use the System Recovery CD. Make sure you have the product ID number located on the cover of your Microsoft Windows 98 "Getting Started" manual. You will need this number to complete the recovery process.

1 Insert the Sony System Recovery CD in the DVD-ROM drive.



The System recovery utility boots from the DVD-ROM drive. It must be in the DVD-ROM drive when you turn on the computer.

2 Shut down your computer as described in "Shutting Down Your Computer" on page 13.

3 Wait four seconds and turn on your computer.

4 Click OK to signify you have read and accept the Microsoft End-User License Agreement.

5 When the System Recovery menu appears, follow the on-screen instructions to complete the recovery process.



Your system may include one or two System Recovery CDs. If you have two System Recovery CDs, insert the first CD to run the System Recovery program. You are prompted to insert the second CD once the information from the first CD has been installed.

The recovery process takes from 30 to 60 minutes to complete.

If your computer does not start from the Recovery CD

1 Slide the power switch forward and hold it for more than four seconds to turn off the computer.

2 Turn on the computer. When the Sony logo is displayed, press the F2 key. The BIOS setup menu screen appears.

3 Press the arrow keys to select the Exit menu.

4 Press the arrow keys to select Get Default Values and then press the Enter key. The message "Load default configuration now?" appears.

5 Check that [Yes] is selected, then press the Enter key.

- 6 Press the arrow keys to select Exit (Save Changes) and then press the Enter key. The message "Save configuration changes and exit now?" appears.
- 7 Check that [Yes] is selected, then press the Enter key. The computer restarts from the Recovery CD.

Using the Application Recovery CD(s)

The Application Recovery CD(s) allows you to reinstall individual applications and device drivers if they are corrupted or accidentally erased. Reinstalling an individual device driver or software title may correct a problem you are experiencing with your computer, and you may not need to recover the entire contents of your hard drive. If you do need to reinstall all the software titles that shipped with your computer, use the System Recovery CD(s). See "Using the System Recovery CD(s)" on page 88.

You can also use the Application Recovery CD to install Windows NT[®] Workstation 4.0 drivers on your computer.



You must be in Windows to run the Application Recovery CD(s). The application will not run from DOS. If you have any questions on using the Application Recovery CD(s), contact Sony Customer Support.

To use the Application Recovery CD(s)

- 1 Turn on your computer. If your computer is already on, close all applications.
- 2 When the Windows desktop appears, insert the Sony Application Recovery CD in the DVD-ROM drive. The Application Recovery utility loads automatically.
- 3 When the Application Recovery menu appears, select the icon for the application you want to restore and then follow the on-screen instructions to complete the recovery process.



Your system may include one or two Application Recovery CDs. If you have two Application Recovery CDs, insert the first CD to run the Application Recovery program. You may be prompted to insert the second CD, depending on the application you wish to restore.

For a list of the contents of the Application Recovery CD(s), see the online version of *Read Me First*.

Notes on Use

This section describes safety guidelines and precautions to help protect your computer from potential damage.

On Handling the LCD Screen

- ❑ Do not leave the LCD facing the sun as it can damage the LCD. Be careful when using the computer near a window.
- ❑ Do not scratch the LCD or exert pressure on it. This could cause malfunction.
- ❑ Using the computer in low temperature conditions may produce a residual image on the screen. This is not a malfunction. When the computer returns to normal temperature, the screen returns to normal.
- ❑ A residual image may appear on the screen if the same image is displayed for a lengthy period of time. The residual image disappears in a while. You can use a screen saver to prevent residual images.
- ❑ The screen becomes warm during operation. This is normal and does not indicate a malfunction.
- ❑ The LCD is manufactured using high-precision technology. You may, however, see tiny black points and/or bright points (red, blue, or green) that continuously appear on the LCD. This is a normal result of the manufacturing process and does not indicate a malfunction.

On the Power Source

- ❑ Your computer operates on 100V-240V AC 50/60 Hz.
- ❑ Do not share the AC outlet with other power-consuming equipment, such as a copying machine or shredder.
- ❑ You can purchase a power strip with a surge protector. This device prevents damage to your computer caused by sudden power surges such as those that may occur during an electrical storm.
- ❑ Do not place heavy objects on the power cord.

- ❑ To disconnect the cord, pull it out by the plug. Never pull the cord itself.
- ❑ Unplug your computer from the wall outlet if you will not be using the computer for a long time.
- ❑ When the AC adapter is not used, unplug it from the AC outlet.
- ❑ Use only the AC adapter supplied. Do not use any other AC adapter.

On Handling

- ❑ Clean the cabinet with a soft, dry cloth or a soft cloth lightly moistened with a mild detergent solution. Do not use any type of abrasive pad, scouring powder, or solvent such as alcohol or benzine, as these may damage the finish of your computer.
- ❑ Should any solid object or liquid fall into the computer, shut down your computer and then unplug it. You may want to have the computer checked by qualified personnel before operating it any further.
- ❑ Do not drop the computer or place heavy objects on top of the computer.

On Installation

- ❑ Do not place your computer in a location subject to:
 - ❑ Heat sources, such as radiators or air ducts
 - ❑ Direct sunlight
 - ❑ Excessive dust
 - ❑ Moisture or rain
 - ❑ Mechanical vibration or shock
 - ❑ Strong magnets or speakers that are not magnetically shielded
 - ❑ Ambient temperature of more than 95° F (35° C) or less than 50° F (10° C)
 - ❑ High humidity
- ❑ Do not place electronic equipment near your computer. The computer's electromagnetic field may cause a malfunction.
- ❑ Provide adequate air circulation to prevent internal heat build-up. Do not place your computer on porous surfaces such as rugs or blankets, or near materials such as curtains or draperies that may block its ventilation slots. Leave a space of at least 8 inches behind the back panel of the computer.

- ❑ The computer uses high-frequency radio signals and may cause interference to radio or TV reception. Should this occur, relocate the computer a suitable distance away from the set.
- ❑ Use only specified peripheral equipment and interface cables; otherwise, problems may result.
- ❑ Do not use cut or damaged connection cables.
- ❑ Your computer will not work with party lines, cannot be connected to a coin-operated telephone, and may not work with multiple phone lines or a private branch exchange (PBX).
- ❑ If the telephone company makes a service call to your home or office and determines that your computer is responsible for a problem, the telephone company may bill you for the service call. Also, if you do not disconnect your computer when it is adversely affecting the telephone line, the telephone company has the right to disconnect your service until you correct the problem.

On Moisture Condensation

If the computer is brought directly from a cold location to a warm one, moisture may condense inside your computer. In this case, allow at least an hour before turning on your computer. If any problems occur, unplug your computer, and contact your Sony Service Center.

On Upgrading the System

- ❑ The procedures described in “Adding Memory” on page 96 assume familiarity with the general terminology associated with personal computers and with the safety practices and regulatory compliance required for using and modifying electronic equipment.
- ❑ Disconnect the system from its power source and from any telecommunications links, networks, or modems before you open the system or do any of the procedures described in “Adding Memory”. Failure to do so may result in personal injury or equipment damage.
- ❑ Electrostatic discharge (ESD) can damage disk drives and other components. Perform the procedures described in “Adding Memory” only at an ESD workstation. If such a station is not available, do not work in a carpeted area, and do not handle materials that produce or hold static electricity (cellophane wrappers, for example). Ground yourself by maintaining contact with an unpainted metal portion of the chassis while performing the procedure.

On Handling Diskettes

- ❑ Do not open the shutter manually and touch the surface of the diskette.
- ❑ Keep diskettes away from magnets.
- ❑ Keep diskettes away from direct sunlight and other heat sources.

On Handling CD-ROMs and DVD-ROMs

- ❑ Do not touch the surface of the disc.
- ❑ Do not drop or bend the disc.

On Cleaning CD-ROMs and DVD-ROMs

- ❑ Fingerprints and dust on the surface of a disc may cause read errors. Proper care of the disc is essential to maintain its reliability. Do not use solvents such as benzine, thinner, commercially available cleaners or anti-static spray, as they may cause damage to the disc.
- ❑ For normal cleaning, hold the disc by its edge and use a soft cloth to wipe the surface from the center out.
- ❑ If the disc is badly soiled, moisten a soft cloth with water, wring it out well, and use it to wipe the surface of the disc from the center out. Wipe off any remaining moisture with a dry soft cloth.

On Using Batteries

- ❑ Never leave the battery pack in temperatures above 140° F (60° C), such as under direct sunlight or in a car parked in the sun.
- ❑ Battery life is shorter in a cold environment. This is due to decreased battery efficiency at low temperatures.
- ❑ Charge the batteries at temperatures between 50° F and 80° F (10° C to 30° C). Lower temperatures require a longer charging time.
- ❑ While the battery is in use or being discharged, the battery pack heats up. This is normal and is not cause for concern.
- ❑ Keep the battery pack away from all sources of heat.
- ❑ Keep the battery pack dry.
- ❑ Do not open or try to disassemble the battery pack.
- ❑ Do not expose the battery pack to any mechanical shock.
- ❑ If you are not using the computer for an extended period of time, remove the battery pack from the computer to prevent damage to the battery.

- ❑ If, after fully charging the battery pack, the battery power is still low, the battery pack may be reaching the end of its life and should be replaced.
- ❑ You do not need to discharge the battery before recharging.
- ❑ If you have not used the battery pack for a considerable amount of time, recharge the battery.

On Using the Headphone

- ❑ **Road safety** – Do not use headphone while driving, cycling, or operating any motorized vehicle. It may create a traffic hazard and is illegal in some areas. It can also be potentially dangerous to play your headphone at high volume while walking, especially at pedestrian crossings. You should exercise extreme caution or discontinue use in potentially hazardous situations.
- ❑ **Preventing hearing damage** – Avoid using headphone at high volume. Hearing experts advise against continuous, loud and extended play. If you experience a ringing in your ears, reduce the volume or discontinue use.

On Maintenance

- ❑ Make sure to disconnect the power cord before cleaning the computer.
- ❑ Avoid rubbing the LCD screen as this can damage the screen. Use a soft, dry cloth to wipe the LCD screen.
- ❑ Clean the computer with a soft cloth lightly moistened with a mild detergent solution. Do not use any type of abrasive pad, scouring powder or solvent, such as alcohol or benzine.

Adding Memory

In the future you may want to install memory modules to expand the functionality of your computer. You can increase memory to 192 MB by installing optional memory modules. A 64 MB memory module is already installed on your computer. You can add another memory module in a slot. 16, 32, 64, and 128 MB Expansion Memory Modules are available as optional memory modules.

! Make sure you observe the proper safety precautions when you install memory modules in your computer. See "On Upgrading the System" on page 93.

Be careful when adding memory. Mistakes when installing or removing a memory module may cause a malfunction.



Electrostatic discharge can damage electronic components. Before touching a memory expansion board, ensure the following:

- You are discharged of static electricity by touching a grounded metal object.
- Do not work in a carpeted area.
- Do not open the package of the memory module until ready for use. The package protects the memory module from electrostatic discharge.
- Use the special bag for preventing electrostatic discharge or use aluminum foil when you store the memory module.

To install a memory module

- 1 Shut down your computer and disconnect all peripheral devices, such as your printer.
- 2 Unplug your computer and remove the battery packs.

- 3 Wait until the computer cools down. Then turn your computer upside down and open the cover on the bottom.

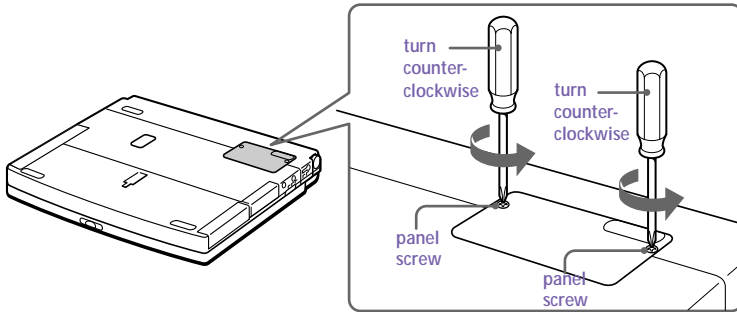

- 4 Remove the memory module from its packaging.
- 5 Install the memory module.

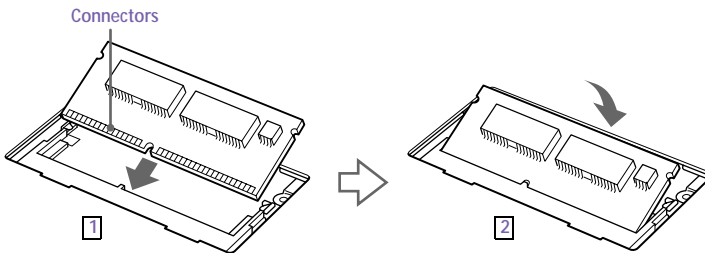

- 1 Slide the memory module into the slot.
- 2 The connectors snap into place when the board is correctly seated.

- 6 Close the cover and tighten the screws.
- 7 Turn on the computer.
- 8 Click the My Computer icon with the right mouse button and select Properties.
The System Properties screen appears.
- 9 Click the Performance tab to view memory.

If the additional memory is not shown, repeat steps 1-9.

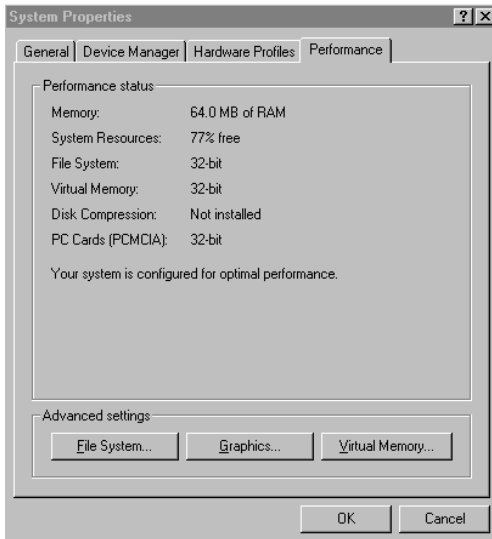

To remove a memory module

- 1 Shut down your computer and disconnect all peripheral devices.
- 2 Unplug your computer and remove the battery packs.
- 3 Turn your computer upside down and open the cover on the bottom.
- 4 Touch a metal object (such as the connector panel on the back of your computer) to discharge static electricity.
- 5 Remove the memory module.

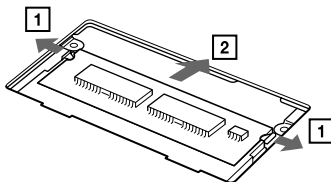

-
- 1 Pull the tabs in the direction of the arrows. The memory module is released.
 - 2 Pull the memory module in the direction of the arrow.
-

- 6 Close the cover.

Limited Warranty Statement

Notebook Computer Warranty

The limited warranty on your VAIO Notebook computer covers parts and labor against defects in material or workmanship for a period of three months from the original date of purchase. You can extend the warranty period for an additional nine months by registering your computer. See “Registering Your Computer” on page 15. Once you register your computer, the limited warranty period is twelve months from the original date of purchase.

There is a separate warranty for the battery included with your computer. See “Battery Limited Warranty” on page 103.

For the purpose of this Limited Warranty “SONY” means SONY ELECTRONICS INC. for Products purchased in the United States of America and Sony of Canada Ltd. for Products purchased in Canada. SONY warrants this computer hardware product (“the Product”) against defects in material or workmanship as follows:

1. Labor: For a period of ninety (90) calendar days from the original date of purchase from SONY or a SONY authorized reseller, SONY will repair defects in material or workmanship in the Product at no charge, or pay the associated labor charges to a SONY authorized personal computer service facility. The ninety (90) day warranty period is extendible only to the original purchaser, for an additional period of nine (9) months, for a total of twelve (12) months from date of purchase when the Product is registered electronically prior to the expiry of ninety (90) days from the original date of purchase. After the applicable period you must pay for all labor charges.

2. Parts: For a period of ninety (90) calendar days from the original date of purchase from SONY or a SONY authorized reseller, SONY will supply, at no charge, new or rebuilt, at SONY’s option, replacement parts in exchange for defective parts. Any replacement parts will be warranted for the remainder of the original warranty period or ninety (90) calendar days from installation by SONY’s authorized personal computer service facility, whichever is longer. The ninety (90) day warranty period is extendible only to the original purchaser, for an additional period of nine (9) months, for a total of twelve (12) months from date of purchase when the Product is registered electronically prior to the expiry of ninety (90) days from the original date of purchase. All defective parts replaced under this Limited Warranty will become the property of SONY.

This Limited Warranty covers only the hardware components packaged with the Product. It does not cover technical assistance for hardware or software usage and it does not cover any software products whether or not contained in the Product; SONY excludes all warranties express or implied in respect of any software provided with the product and any such software is provided “AS IS” unless expressly provided for in any enclosed software limited warranty. Please refer to the End User License Agreements included with the Product for your rights and obligations with respect to the software.

This Limited Warranty is non-transferable. Proof of purchase in the form of a bill of sale (which is evidence that the Product is within the warranty period) must be presented to obtain warranty service. In addition, if replacement parts are required and you wish to receive the most expedient service available, you will be required to provide SONY with a credit card authorization to bill your credit card in the event you fail to return the original parts in the postage-paid envelope we provide. The credit card will only be charged for SONY's list price for the part if the original part has not been returned within thirty (30) days.

In respect of certain components you may be entitled to express warranty service during the warranty period, subject to certain restrictions. Please contact SONY as indicated below for further information.

With respect to all service provided, it is your responsibility prior to Product service to backup the contents of your hard drive, including any data you have stored or software you have installed on the hard drive. It is likely that the contents of your hard drive will be lost or reformatted in the course of service and SONY will not be responsible for any damage to or loss of any programs, data or other information stored on any media or any part of any Product serviced hereunder or any consequential damages resulting therefrom.

IF DURING THE REPAIR OF THE PRODUCT THE CONTENTS OF THE HARD DRIVE ARE ALTERED, DELETED, OR IN ANY WAY MODIFIED, SONY IS NOT RESPONSIBLE WHATSOEVER. YOUR PRODUCT WILL BE RETURNED TO YOU CONFIGURED AS ORIGINALLY PURCHASED (SUBJECT TO AVAILABILITY OF SOFTWARE).

Be sure to remove all third party hardware, software, features, parts, options, alterations, and attachments not warranted by SONY prior to sending the Product to SONY for service. SONY is not liable for any loss or damage to these items.

This Limited Warranty does not cover any consumable items (such as batteries) supplied with this Product; cosmetic damages; damage or loss to any software programs, data, or removable storage media; or damage due to (1) acts of God, accident, misuse, abuse, negligence, commercial use or modifications of this Product; (2) improper operation or maintenance of this Product; (3) connection to improper voltage supply; or (4) attempted repair by any party other than a SONY authorized personal computer service facility. This Limited Warranty does not apply when the malfunction results from the use of this Product in conjunction with accessories, products or ancillary or peripheral equipment, or where it is determined by SONY that there is no fault with this Product itself. This Limited Warranty is valid only in the United States of America and Canada. This Limited Warranty is invalid if the factory applied serial number has been altered or removed from the Product.

Repair or replacement of defective parts or hardware as provided under this Limited Warranty is the exclusive remedy of the consumer. SONY SHALL NOT BE LIABLE FOR ANY INCIDENTAL OR CONSEQUENTIAL DAMAGES OR OTHER DAMAGES INCLUDING BUT NOT LIMITED TO, LOSS OF PROFITS, LOSS OF REVENUE, LOSS OF DATA, LOSS OF USE OF THE PRODUCT OR ANY ASSOCIATED EQUIPMENT, DOWN TIME AND PURCHASER'S TIME. FOR BREACH OF ANY EXPRESS OR IMPLIED WARRANTY, BREACH OF CONTRACT, NEGLIGENCE, STRICT LIABILITY OR ANY OTHER LEGAL THEORY RELATED TO THIS PRODUCT, EXCEPT TO THE EXTENT PROHIBITED BY APPLICABLE LAW, ANY IMPLIED WARRANTY OF MERCHANTABILITY OR FITNESS FOR A PARTICULAR PURPOSE ON THIS PRODUCT IS LIMITED IN DURATION TO THE DURATION OF THIS WARRANTY.

Some states or provinces do not allow the exclusion or limitation of incidental or consequential damages, or allow limitations on how long an implied warranty lasts, so the above limitations or exclusions may not apply to you. This Limited Warranty gives you specific legal rights, and you may have other rights which vary from state to state, or province to province.

Technical Support: Although technical support is not provided free of charge under this Limited Warranty, SONY has established a telephone number for technical support. Charges may apply for technical support, unless and to the extent that free technical support for a limited period is provided in writing as a feature of your Product. Prior to placing your call, please have available the model and serial number for your Product, date of purchase, a list of all options installed in your Product and a detailed description of the problem.

For Product support, online knowledge base, frequently asked questions, and free updates via the Internet: <http://www.sony.com/pcsupport/>

For Product information, service assistance, resolution of a service problem, or technical assistance, call: 1-888-4SONYPC (476 – 6972)

Save this for future reference.

© 1998 Sony Electronics Inc. and Sony of Canada Ltd. Reproduction in whole or in part without written permission is prohibited. All rights reserved. SONY is a registered trademark of Sony.

GARANTIE RESTREINTE

SONY DU CANADA LTÉE (“SONY”) garantit comme suit ce Produit d’ordinateur (“le Produit”) contre tous vices de matières premières et de fabrication :

1. Main-d’oeuvre : Pendant une période de quatre-vingt-dix (90) jours à compter de la date d’achat originale chez SONY ou chez un de ses revendeurs autorisés, SONY réparera le Produit à ses frais ou en remboursera les frais de main-d’oeuvre au centre de réparation d’ordinateur personnel autorisé SONY. La période de garantie de quatre-vingt-dix (90) jours peut être prolongée au bénéfice de l’acheteur original pour une période additionnelle de neuf (9) mois, soit un total de douze (12) mois à compter de la date d’achat, lorsque le Produit est enregistré électroniquement. Après la période applicable, l’acheteur doit payer tous les frais de main-d’oeuvre.

2. Pièces : Pendant une période de quatre-vingt-dix (90) jours à compter de la date d’achat originale chez SONY ou chez un de ses revendeurs autorisés, SONY fournira à ses frais des pièces de rechange neuves ou reconstruites, à sa discrétion, en échange des pièces défectueuses. Ces pièces de remplacement seront garanties pour le reste de la période originale de garantie ou pour quatre-vingt-dix (90) jours à compter de leur installation par un centre de service d’ordinateur personnel autorisé SONY, au plus long des deux termes. La période de garantie de quatre-vingt-dix (90) jours peut être prolongée au bénéfice de l’acheteur original pour une période additionnelle de neuf (9) mois, soit un total de douze (12) mois à compter de la date d’achat, lorsque le Produit est enregistré électroniquement. Toutes les pièces défectueuses remplacées au titre de cette garantie restreinte deviennent la propriété de SONY.

Cette garantie restreinte couvre uniquement les composants physiques emballés avec le Produit. Elle n’inclut pas l’assistance technique en rapport avec l’utilisation du matériel ou du logiciel et ne couvre aucun logiciel, qu’il soit ou non fourni avec le Produit. Les logiciels sont fournis “TELS QUELS” à moins d’être expressément couverts par une autre garantie restreinte spécifique. Veuillez vous reporter aux Contrats de licence d’utilisation accompagnant le Produit quant à vos obligations en rapport avec les logiciels.

Cette garantie restreinte est incessible.

Pour vous prévaloir du service au titre de la garantie, vous devrez présenter une preuve d’achat sous forme de facture de vente attestant que le Produit est couvert par la garantie en vigueur. Par ailleurs, si des pièces doivent être remplacées et que vous désirez obtenir le service le plus rapide possible, vous devrez fournir à SONY une autorisation lui permettant d’en porter le montant à votre carte de crédit advenant que vous négligiez de retourner les pièces originales dans l’enveloppe affranchie qui vous est fournie. Seul le prix courant de SONY pour cette pièce sera porté à votre carte de crédit si la pièce ne lui est pas retournée dans un délai de trente (30) jours.

Vous pouvez avoir droit au service de garantie exprès durant la période de garantie, sous réserve de certaines restrictions. Pour tout renseignement, veuillez communiquer avec SONY de la façon indiquée ci-après.

Vous avez l’entière responsabilité de faire une copie de sauvegarde du contenu du disque dur, incluant toute donnée en mémoire ou tout logiciel que vous y avez installé. Il est fort probable que le contenu du disque dur sera reformaté ou perdu en cours de service et SONY ne pourra être tenue responsable d’aucun dommage ni de la perte des programmes, des données ou de toute autre information gardée en mémoire sur tout support d’information ou sur toute partie de tout Produit en réparation.

SI, DURANT LA RÉPARATION DU PRODUIT, LE CONTENU DU DISQUE DUR EST ALTÉRÉ, SUPPRIMÉ OU MODIFIÉ, SONY N’EN SERA AUCUNEMENT RESPONSABLE. LE PRODUIT VOUS SERA RETOURNÉ TEL QU’IL ÉTAIT CONFIGURÉ QUAND VOUS L’AVEZ ACHETÉ (SOUS RÉSERVE DE LA DISPONIBILITÉ DU LOGICIEL).

Avant d'envoyer le Produit à SONY pour le faire réparer, assurez-vous d'en retirer tous produits de tierce partie, logiciels, caractéristiques, pièces, options, altérations et accessoires non garantis par SONY car SONY n'est pas responsable de la perte ou de l'endommagement de ces articles.

Cette garantie restreinte exclut les articles consommables (comme les batteries) fournis avec le Produit ; les dommages cosmétiques ; l'endommagement ou la perte des logiciels, données et supports informatiques amovibles ; les dommages dus à 1) un cas fortuit, un accident, une mauvaise utilisation, un abus, une négligence, une utilisation commerciale ou une modification du Produit ; 2) l'utilisation ou l'entretien incorrect du Produit ; 3) le branchement à une source électrique non conforme ; ou 4) toute tentative de réparation par tout autre qu'un centre de service d'ordinateur personnel autorisé SONY. Cette garantie restreinte ne s'applique pas si la défectuosité est causée par l'utilisation du Produit en conjonction avec des accessoires, articles ou équipements périphériques ou connexes, ou si SONY détermine que le Produit lui-même ne comporte aucun défaut. Cette garantie restreinte n'est valide qu'au Canada.

Cette garantie restreinte est nulle si le numéro de série appliqué en usine a été modifié ou enlevé du Produit.

La réparation ou le remplacement du matériel ou des pièces défectueuses tel que prévu au titre de cette garantie est le seul recours de l'acheteur. SONY NE SERA AUCUNEMENT RESPONSABLE DE TOUT DOMMAGE INDIRECT OU CONSÉCUTIF POUR DÉROGATION À TOUTE GARANTIE EXPRESSE OU TACITE, RUPTURE DE CONTRAT, NÉGLIGENCE, RESPONSABILITÉ STRICTE OU TOUTE AUTRE THÉORIE JURIDIQUE EN RAPPORT AVEC CE PRODUIT. DE TELS DOMMAGES INCLUENT, ENTRE AUTRES, LE TEMPS DE L'ACHETEUR, LA PERTE DE PRODUCTIVITÉ, DE REVENUS ET DE PROFITS, ET LA PERTE DE DONNÉES OU D'UTILISATION DU PRODUIT OU DE TOUT ÉQUIPEMENT CONNEXE. SAUF DANS LA LIMITE OÙ LA LOI APPLICABLE L'INTERDIT, TOUTE GARANTIE TACITE DE VALEUR MARCHANDE OU DE CONVENANCE À UNE FIN PARTICULIÈRE DE CE PRODUIT EST RESTREINTE DANS SA DURÉE À LA DURÉE DE CETTE GARANTIE.

Certaines provinces ne permettent pas l'exclusion ou la restriction des dommages accidentels ou indirects et n'admettent pas de limites quant à la durée d'une garantie tacite, de sorte que les exclusions/restrictions exprimées ci-dessus peuvent ne pas s'appliquer. Cette garantie vous donne des droits spécifiques et vous pouvez en avoir d'autres qui varient selon la province.

Soutien technique : Bien que le soutien technique ne soit pas offert gratuitement au titre de cette garantie restreinte, SONY a prévu une ligne téléphonique à cet effet. Des frais peuvent être exigés à moins que le soutien technique gratuit et temporaire ne soit expressément indiqué par écrit comme caractéristique de votre Produit. Avant de placer l'appel, assurez-vous d'avoir les numéros de modèle et de série du Produit, la date d'achat, la liste des options qui y sont installées et une description détaillée du problème.

Vous trouverez sur l'Internet un appui direct, une base de renseignements, une foire aux questions et des mises à jour gratuites sous <http://www.sony.com/pcsupport/>

Pour de l'information sur les produits, de l'aide avec le service, la résolution de problèmes de service ou pour une aide technique, veuillez composer le 1-888-4SONYPC (476-6972).

À conserver pour référence future.

©1998 Sony du Canada Ltée. Reproduction partielle ou complète interdite sans autorisation écrite préalable. Tous droits réservés. SONY est une marque déposée de Sony.

Battery Limited Warranty

The limited warranty on the battery included with your Sony VAIO Notebook Computer covers defects in material or workmanship for a period of 30 days from the original date of purchase. This warranty is not extendible.

For the purposes of this Limited Warranty, "SONY" means Sony Electronics Inc. for Products purchased in the United States of America and Sony of Canada Ltd. for Products purchased in Canada. Sony warrants this Product against defects in material or workmanship for thirty (30) days from your purchase date. If this Product is determined to be defective, SONY will replace the Product at no charge to you. This Limited Warranty contains your exclusive remedy. SONY shall not be liable for any incidental or consequential damages for breach of any express or implied warranty on this product. Some states and provinces do not allow the exclusion or limitation of incidental or consequential damages, so the above limitation or exclusion may not apply to you. This warranty gives you specific legal rights which vary from state to state or province to province. For information on obtaining warranty service, please call SONY at 1-888-4SONYPC (1-888-476-6972).

GARANTIE RESTREINTE

Au titre de cette garantie restreinte, "SONY" signifie Sony du Canada Ltée pour les produits achetés au Canada et Sony Electronics Inc. pour les produits achetés aux États-Unis. SONY garantit ce produit contre tous vices de matières premières et de fabrication pour trente (30) jours à compter de la date d'achat. Si ce produit est reconnu défectueux, SONY le remplacera à ses frais. Cette garantie restreinte est votre seul recours. SONY ne sera aucunement responsable de tout dommage indirect ou consécutif pour dérogation à toute garantie tacite ou expresse sur ce produit. Certaines provinces ne permettent pas l'exclusion ou la restriction des dommages accidentels ou indirects, de sorte que les exclusions/restrictions exprimées ci-dessus peuvent ne pas s'appliquer. Cette garantie vous donne des droits spécifiques et vous pouvez en avoir d'autres qui varient selon la province. Pour de l'information sur le service au titre de la garantie, veuillez appeler Sony au 1-888-4SONYPC (1-888-476-6972).

Index

A

- About This Computer tab 64
- AC adapter 5, 8
- AC power 8
- AC Profile power setting 66
- accessing online support 14
- adding
 - hardware 43
 - memory 96
 - peripherals 43
 - printers 53
- adjusting
 - brightness 20
- air circulation 92
- Alt key 17
- AMS (Automatic Music Sensor) 32
- Application Recovery CD 90
- Applications key 17
- attaching docking station 46

B

- Basic/Advanced tab 64
- battery bay 6
- battery packs 5, 9, 94
 - charge status icons 71
 - charging 10, 41
 - indicator light status 10
 - indicator lights 5, 10, 19, 40
 - inserting 9
 - inserting into battery bay 9
 - inserting into docking station 48
 - loading 9
 - power status 10
 - rechargeable 8
 - removing 11, 40, 41

- BatteryScope utility 70, 72
- brightness
 - adjusting 12, 20
- built-in speakers 5
- buttons
 - Eject 26, 27
 - Finish 14
 - left 5
 - Play 32
 - right 5
 - Start (Windows 98) 13, 63

C

- cables
 - floppy disk drive 5
 - phone 5
 - power cord 8
 - video 5
- cameras
 - digital video recorder 61
 - Sony Digital Still 60
- canceling commands 17
- Caps Lock 5
 - indicator light 19
- CD player 32
 - remote control 32
 - volume 32
- CD-ROM/DVD-ROM discs
 - cleaning 94
 - ejecting 27
 - handling 94
 - inserting 26
 - playing 32
- CD-ROM/DVD-ROM drive
 - closing tray 27

- opening tray 26
 - using 26
 - changing
 - display size 21
 - charge status indicator light 10
 - charging battery packs 10, 41
 - using docking station 48
 - choosing
 - power source 9
 - cleaning computer 92
 - coin-operated telephones 44
 - computer
 - cleaning 92
 - condensation 93
 - customizing 63
 - lithium ion battery
 - setting up 5
 - online support 79
 - setup screen 63
 - starting 12
 - troubleshooting 81, 83
 - upgrading 93
 - connecting
 - coin-operated telephones 44
 - digital still camera 60
 - digital video recorder 61
 - docking station 45, 46
 - external keyboard 45, 57
 - external mouse 57
 - external speakers 58
 - floppy disk drive 23
 - game 45
 - hard drives 33
 - keyboard 57
 - microphone 59
 - monitor 45, 54
 - mouse 45
 - multimedia computer display 55
 - multiple phone lines 44
 - network 33, 45
 - party phone lines 44
 - PBX 44
 - phone line 44
 - power source 8
 - printer 53
 - serial device 60
 - USB device 62
 - weight saver 42
 - connectors
 - DC In 7, 8, 45
 - FDD/Printer 7, 23, 53
 - game 45
 - headphone 6
 - i.LINK 45
 - infrared 7, 36
 - keyboard 5, 7, 45
 - Line In 6, 45
 - Line Out 45
 - microphone 5, 6, 45
 - monitor 45
 - mouse 7, 45
 - network 45
 - phone line 7
 - printer 53
 - SCSI 45
 - Serial port 7, 45
 - USB 7, 45
 - correction keys 16, 17
 - Ctrl key 17
 - cursor-movement keys 17
 - customer assistance
 - support options 79
 - customizing your computer 63
- ## D
- DC In 7, 8, 45
 - digital still camera 36
 - connecting 60
 - digital video camera 61
 - disconnecting
 - docking station 20, 52
 - diskettes
 - ejecting 25
 - handling 94
 - inserting into drive 24
 - troubleshooting 84
 - display
 - changing size 21
 - dual display 77
 - mode 73
 - options 66
 - See also monitor

- selecting 56
- disposal of lithium ion battery *v*
- docking station 7
 - connecting 45, 46
 - disconnecting 20, 52
 - inserting battery packs 48
 - lever 46, 51
 - network 45
 - personal 45
 - using to charge batteries 48
- Double-click the (atom) icon on the taskbar. 68
- drive bay 7
 - weight saver 42
- Drive Bay tab 65
- drives 28
 - DVD-ROM 28
 - floppy disk 5, 23
 - installing additional hard disk 33
- dual display function 77
- DV In/Out 45, 61
- DVD-ROM discs
 - troubleshooting 84
- DVD-ROM drive tray
 - troubleshooting 83

E

- Eject button 25, 26, 27
- Eject lever 24, 25, 28, 41, 42, 50
- ejecting
 - battery packs 41
 - CD-ROM/DVD-ROM discs 27
 - diskettes 25
 - weight saver 42
- electronic
 - documentation 79
- Enable Ports tab 64
- ergonomic considerations 2, 3
- Escape key 16
- Express Service technical support 15
- external devices
 - display 3, 56
 - See also monitor
 - keyboard 57
 - mouse 57
 - speakers 58

F

- faxes
 - laws governing *v*
- FDD/Printer connector 7, 23, 45, 53
- Finish button 14
- floppy disk drive 5
 - bay 7
 - cable 5
 - connecting 23
 - disconnecting 25
 - troubleshooting 84
- Fn key 17
 - combination commands 20
- function keys 16, 17

G

- game connector 45
- glare 2

H

- handling
 - audio CDs 94
 - CD-ROM/DVD-ROM discs 94
 - diskettes 94
- Hard Disk Standby power setting 67
- hard drives 6
 - indicator light 5, 19
 - installing additional 33
- hardware
 - installing memory modules 96
 - online support 79
- headphone 5
 - connector 6
 - precautions 95
- headphones 55
- Help
 - Mouseware 22
- help 79
- Hold switch 32

I

- i.LINK 45, 61
- IEEE 1394 45, 61
- indicator lights 19
 - battery 5, 10, 19, 40

- Caps Lock 5, 19
 - charge status 10
 - hard drive 5, 19
 - Num Lock 5, 19
 - power 5
 - Scroll Lock 5, 19
- infrared communication devices 36
 - other computers 36
- infrared port 7, 36
- infrared transmission
 - active distance 37
 - troubleshooting 37
- input devices *iv*
- Insert key 17
- inserting
 - battery pack 9
 - CD-ROM/DVD-ROM discs 26
 - diskettes into drive 24
- installing
 - hard drives 33
 - hardware 43
 - memory 33, 96
 - memory modules 96
 - peripherals 43
- interference *iv*, 92
- internal speakers
 - See speakers

K

- keyboard 17, 45
 - connecting 57
 - connector 5, 7, 57

L

- LCD 91
 - lock lever 12
 - reducing glare 2
 - selecting to display output 56
 - troubleshooting 82, 83
- left button 5
- lever
 - docking station 46, 51
 - Eject 24, 25, 28, 41, 42, 50
 - LCD 12
- lighting 2
- Limited Warranty 99

- Limited Warranty card 15
- Line In 6, 45
- Line Out 45
- Liquid Crystal Display screen
 - See LCD
- lithium ion battery
 - disposal *v*
 - safety precautions *v*
- loading
 - battery pack 9
- location for computer 2

M

- maintenance 92, 95
- Maximum Battery Life power setting 66
- Maximum Performance power setting 66
- memory module 96, 97
 - installing 33, 96
 - removing 98
- microphone 6
 - connecting 59
 - connector 5, 45, 55
 - troubleshooting 86
- modem
 - laws governing *v*
 - troubleshooting 85
- moisture condensation 93
- monitor 7, 45
 - connecting 54
 - connector 55
 - selecting 56
 - switching among 20
- mouse
 - connecting 57
 - connector 7
 - troubleshooting 86
- Mouse Properties screen 22
- Mouseware
 - accessing help 22
 - features 22
- multimedia computer display 55
- multiple phone lines 44

N

navigation keys 16, 17

network

connecting 33

connector 45

docking station 45

Notebook Computer 5

Notebook Setup tabs 64

Notebook Setup utility 23

Num Lock 5

indicator light 19

numeric keypad area 16

O

online

help 79

support

options 79

opening

CD-ROM/DVD-ROM drive tray

26

operator keys 17

output devices *iv*

adding 53

P

party phone lines 44

PBX 44

PC card

inserting 33

release button 33, 44

removing 35

slot protector 34

slots 33

troubleshooting 87

Type III 33

Performance tab 97

personal docking station 45

phone

cable 5

connecting line 44

jack 7, 44

laws governing *v*

power 19

cord 8

indicator light 5

switch 6, 12

Power Management

toolbar 68

power management

settings 66

Power Management Off power setting

66

Power On

Device Sequence tab 64

Password tab 64

power saving modes 38

System Hibernation 21, 38

System Suspend 38

Video Standby 21

power setting

AC Profile 66

Maximum Battery Life 66

Maximum Performance 66

Power Management Off 66

System Hibernation 67

System Suspend 67

Video Standby 67

power sources 9, 91

connecting 8

power standby

Hard Disk Standby 67

PowerPanel

activating 68

customizing toolbar 66, 67

PowerPanel Profiles toolbar 68

precautions 92

Print Screen key 17

printer 7

connecting 45, 53

connector 23, 53

port 53

Printer tab 64

R

radio interference *iv*, 92

rechargeable battery packs 8, 9

recharging battery packs 10

Recovery CD 90

registering

Windows 98 14

- your computer 15
- regulatory information iii
- remote control
 - audio CD player 32
 - Hold switch 32
- removing
 - battery packs 11
 - diskettes 25
 - floppy disk drive 25
 - memory module 98
- replacing
 - battery packs 40
- restoring data 90
- right button 5
- S**
- screen
 - See LCD
- Scroll Lock 5
 - indicator light 19
- SCSI connector 45
- second battery pack 9, 40
- selecting
 - display 56
 - LCD 56
 - monitor 56
 - power source 9
- Serial connector 7, 45, 60
- serial devices
 - connecting 60
 - digital still camera 60
- setting up
 - Windows 98 14
- setting up your PC
 - online support 79
- setup screen
 - About This Computer tab 64
 - Basic/Advanced tab 64
 - displaying 63
 - Drive Bay tab 65
 - Enable Ports tab 64
 - Power On Device Sequence tab 64
 - Power On Password tab 64
 - Printer tab 64
 - Touchpad tab 64
- setup tabs 64
- Shift key 17
- Shut Down Windows dialog box 13
- Sony Fax-on-Demand service 80
- Sony Notebook Setup screen 63
- Sony Notebook Setup utility 23
- speakers 5
 - built-in 5
 - external 58
 - troubleshooting 84
 - volume 20
- Start button 13, 63
- starting
 - computer 12
- startup problems 13
- switching
 - display 20
 - monitor 20
- System Hibernation mode 21, 38, 67
- System Suspend mode 20, 38, 67
- T**
- technical support
 - support options 79
- touchpad 5, 22
- Touchpad tab 64
- troubleshooting 81
 - startup 13, 81
- turning on
 - computer 12
- TV
 - interference iv, 92
- U**
- upgrading
 - computer 93
- USB
 - connecting 62
 - connector 7, 45, 62
- V**
- ventilation 92
- video cable 5
- video camera 61
- Video Standby mode 21

W

warranty 15, 99

weight saver 5

 attaching 40

 connecting 42

 removing 42

Windows 98

 Certificate of Authenticity 14

 Control Panel 37

 Explorer 18

 Find window 18

 Finish button 14

 help 18

 key 17

 key combinations 18

 License Agreement 14

 registering 14

 setup 14

 Setup Wizard screen 14

 Start button 13

 taskbar 13, 83

Free Manuals Download Website

<http://myh66.com>

<http://usermanuals.us>

<http://www.somanuals.com>

<http://www.4manuals.cc>

<http://www.manual-lib.com>

<http://www.404manual.com>

<http://www.luxmanual.com>

<http://aubethermostatmanual.com>

Golf course search by state

<http://golfingnear.com>

Email search by domain

<http://emailbydomain.com>

Auto manuals search

<http://auto.somanuals.com>

TV manuals search

<http://tv.somanuals.com>