

SONY.

***VAIO® Notebook
User Guide***

**PCG-FX120/FX120K, PCG-FX140/FX140K,
PCG-FX150/FX150K, PCG-FX170/FX170K,
PCG-FX190/FX190K**

Notice to Users

© 2001 Sony Electronics Inc. All rights reserved. This manual and the software described herein, in whole or in part, may not be reproduced, translated, or reduced to any machine-readable form without prior written approval.

SONY ELECTRONICS INC. PROVIDES NO WARRANTY WITH REGARD TO THIS MANUAL, THE SOFTWARE, OR OTHER INFORMATION CONTAINED HEREIN AND HEREBY EXPRESSLY DISCLAIMS ANY IMPLIED WARRANTIES OF MERCHANTABILITY OR FITNESS FOR ANY PARTICULAR PURPOSE WITH REGARD TO THIS MANUAL, THE SOFTWARE, OR SUCH OTHER INFORMATION. IN NO EVENT SHALL SONY ELECTRONICS INC. BE LIABLE FOR ANY INCIDENTAL, CONSEQUENTIAL, OR SPECIAL DAMAGES, WHETHER BASED ON TORT, CONTRACT, OR OTHERWISE, ARISING OUT OF OR IN CONNECTION WITH THIS MANUAL, THE SOFTWARE, OR OTHER INFORMATION CONTAINED HEREIN OR THE USE THEREOF.

Sony Electronics Inc. reserves the right to make any modification to this manual or the information contained herein at any time without notice. The software described herein is governed by the terms of a separate user license agreement.

This product contains software owned by Sony and licensed by third parties. Use of such software is subject to the terms and conditions of license agreements enclosed with this product. Some of the software may not be transported or used outside the United States. Software specifications are subject to change without notice and may not necessarily be identical to current retail versions.

Updates and additions to software may require an additional charge. Subscriptions to online service providers may require a fee and credit card information. Financial services may require prior arrangements with participating financial institutions.

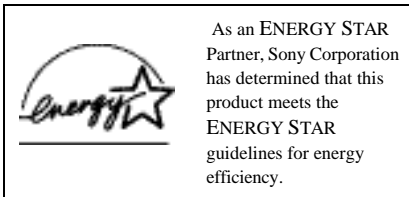

The International ENERGY STAR Office Equipment Program is an international program that promotes energy saving through the use of computers and other office equipment. The program backs the development and dissemination of products with functions that effectively reduce energy consumption. It is an open system in which business proprietors can participate voluntarily. The targeted products are office equipment such as computers, displays, printers, facsimiles and copiers. Their standards and logos are uniform among participating nations. ENERGY STAR is a U.S. registered mark.

Sony, Handycam, i.LINK, Mavica, Media Bar, MovieShaker, PictureGear, VAIO and the VAIO logo are trademarks of Sony Corporation. Microsoft, Windows Me, Windows Media, Windows, Windows NT, and the Windows logo are registered trademarks of Microsoft Corporation. Intel, SpeedStep, and Pentium are trademarks of Intel Corporation. PS/2 is a registered trademark of IBM.

This product incorporates copyright protection technology that is protected by method claims of certain U.S. patents and other intellectual property rights owned by Macrovision Corporation and other rights owners. Use of this copyright protection technology must be authorized by Macrovision Corporation, and is

intended for home and other limited viewing uses only unless otherwise authorized by Macrovision Corporation. Reverse engineering or disassembly is prohibited. i.LINK is a SONY trademark used only to designate that a product contains an IEEE 1394 connector. All products with an i.LINK connector may not communicate with each other.

All other trademarks are trademarks of their respective owners.

Owner's Record

The model number and serial number are located on the bottom of your Sony VAIO® Notebook. Refer to the model and serial number when you call your Sony Service Center.

Model Numbers: PCG-9512, PCG-9522, PCG-9532, PCG 9542, PCG-9552, PCG-951A, PCG-952A, PCG-953A, PCG-954A, PCG-955A

Serial Number: _____

Safety Information

WARNING

- ❑ To prevent fire or shock hazard, do not expose your notebook computer to rain or moisture.
- ❑ To avoid electrical shock, do not open the cabinet. Refer servicing to qualified personnel only.
- ❑ Never install modem or telephone wiring during a lightning storm.
- ❑ Never install telephone jacks in wet locations unless the jack is specifically designed for wet locations.

- ❑ Never touch uninsulated telephone wire or terminals unless the telephone line has been disconnected at the network interface.
- ❑ Use caution when installing or modifying telephone lines.
- ❑ Avoid using the modem during an electrical storm.
- ❑ Do not use the modem or a telephone to report a gas leak in the vicinity of the leak.
- ❑ A socket outlet should be as close as possible to the unit and easily accessible.

! To change the backup battery, please contact your nearest Sony Service Center.

! Caution - The use of optical instruments with this product will increase eye hazard. As the laser beam used in this product is harmful to the eyes, do not attempt to disassemble the cabinet. Refer servicing to qualified personnel only.

! For CD-RW/DVD-ROM drive, DVD-ROM drive: Danger - Visible and invisible laser radiation when open. Avoid direct exposure to beam.

! Caution: To reduce the risk of fire, use only No. 26 AWG or larger telecommunication line cord.

AVERTISSEMENT

- ❑ Pour prévenir tout risque d'incendie ou d'électrocution, garder cet appareil à l'abri de la pluie et de l'humidité.
- ❑ Pour prévenir tout risque d'électrocution, ne pas ouvrir le châssis de cet appareil et ne confier son entretien qu'à une personne qualifiée.
- ❑ Ne jamais effectuer l'installation de fil modem ou téléphone durant un orage électrique.
- ❑ Ne jamais effectuer l'installation d'une prise téléphonique dans un endroit mouillé à moins que la prise soit conçue à cet effet.
- ❑ Ne jamais toucher un fil téléphonique à découvert ou un terminal à moins que la ligne téléphonique n'ait été débranché de l'interface réseau.
- ❑ Soyez très prudent lorsque vous installez ou modifiez les lignes téléphoniques.
- ❑ Évitez d'utiliser le modem durant un orage électrique.
- ❑ N'utilisez pas le modem ni le téléphone pour prévenir d'une fuite de gaz vous êtes près de la fuite.
- ❑ L'appareil doit être le plus près possible d'une prise murale pour en faciliter l'accès

! Pour changer la pile de rechange, veuillez contacter votre centre de service Sony le plus près.

! Avertissement - L'utilisation d'instruments optiques avec ce produit augmente les risques pour les yeux. Puisque le faisceau laser utilisé dans ce produit est dommageable pour les yeux, ne tentez pas de désassembler le boîtier. Adressez-vous à un agent de service qualifié.

! Pour les lecteur CD-RW/DVD-ROM, lecteur DVD-ROM: Danger : Radiation laser visible et invisible si ouvert. Évitez l'exposition directe au faisceau.

! Attention : Afin de réduire les risques d'incendie, n'utilisez qu'un cordon de communication NO. 26 AWG ou plus gros.

If you have questions about this product, you can reach the Sony Customer Information Service Center at 1-888-4SONYPC; or write to the Sony Customer Information Service Center at 12451 Gateway Blvd., Ft. Myers, FL 33913 or find Sony Customer Service on the web at: <http://www.sony.com/pcsupport>

Regulatory Information

Declaration of Conformity

Trade Name:	SONY
Model No.:	PCG-9512 PCG-9522 PCG-9532 PCG-9542 PCG-9552 PCG-951A PCG-952A PCG-953A PCG-954A PCG-955A
Responsible Party:	Sony Electronics Inc.
Address:	1 Sony Drive Park Ridge, NJ 07656
Telephone: (For FCC-related matters only.)	201-930-6972
This device complies with Part 15 of the FCC rules. Operation is subject to the following two conditions:	
(1) This device may not cause harmful interference.	
(2) This device must accept any interference received, including interference that may cause undesired operation.	

This equipment has been tested and found to comply with the limits for a Class B digital device, pursuant to Part 15 of the Rules. These limits are designed to provide reasonable protection against harmful interference in a residential installation. This equipment generates, uses, and can radiate radio frequency energy and, if not installed and used in accordance with the instructions, may cause

harmful interference to radio communications. However, there is no guarantee that interference will not occur in a particular installation. If this equipment does cause harmful interference to radio or television reception, which can be determined by turning the equipment off and on, the user is encouraged to try to correct the interference by one or more of the following measures:

- Reorient or relocate the receiving antenna.
- Increase the separation between the equipment and the receiver.
- Connect the equipment into an outlet on a circuit different from that to which the receiver is connected.
- Consult the dealer or an experienced radio/TV technician for help.

You are cautioned that any changes or modifications not expressly approved in this manual could void your authority to operate this equipment.

Only peripherals (computer input/output devices, terminals, printers, etc.) that comply with FCC Class B limits may be attached to this computer product. Operation with non-compliant peripherals is likely to result in interference to radio and television reception.

All cables used to connect peripherals must be shielded and grounded. Operation with cables, connected to peripherals, that are not shielded and grounded, may result in interference to radio and television reception.

FCC Part 68

This equipment complies with Part 68 of the FCC rules. On the bottom of this equipment is a label that contains, among other information,

the FCC equivalence number (REN) for this equipment. If requested, this information must be provided to the telephone company.

This modem uses the USOC RJ-11 telephone jack.

The REN is used to determine the quantity of devices which may be connected to the telephone line. Excessive RENs on the telephone line may result in the devices not ringing in response to an incoming call. In most, but not all areas, the sum of the RENs should not exceed five (5.0). To be certain of the number of devices that may be connected to the line, as determined by the total RENs, contact the telephone company to determine the maximum REN for the calling area.

If the terminal equipment causes harm to the telephone network, the telephone company will notify you in advance that temporary discontinuance of service may be required. But if advance notice is not practical, the telephone company will notify the customer as soon as possible. Also, you will be advised of your right to file a complaint with the FCC if you believe it is necessary.

The telephone company may make changes in its facilities, equipment, operations or procedures that could affect the operations of the equipment. If this happens, the telephone company will provide advance notice in order for you to make the necessary modifications in order to maintain uninterrupted service.

If trouble is experienced with this equipment, you can reach the Sony Customer Information Service Center at 1-888-4SONYPC; or write to the Sony Customer Information Service Center at 12451 Gateway Blvd., Ft. Myers, FL 33913 or find Sony Customer Service on the web at: <http://www.sony.com/pcsupport>

Repair of this equipment should be made only by a Sony Service Center or Sony authorized agent. For the Sony Service Center nearest you, call 1-888-4SONYPC (1-888-476-6972).

This equipment cannot be used on public coin service provided by the telephone company. Connection to Party Line Service is subject to state and possible provincial tariffs. (Contact the state or provincial utility service commission, public service commission, or corporation commission, for information.)

Telephone Consumer Protection Act of 1991 (United States)

The Telephone Consumer Protection Act of 1991 makes it unlawful for any person to use a computer or other electronic device to send any message via a telephone facsimile machine unless such message clearly contains, in a margin at the top or bottom of each transmitted page or on the first page of the transmission, the date and time it is sent and an identification of the business, other entity, or individual sending the message, and the telephone number of the sending machine or such business, other entity, or individual.

In order to program this information into your facsimile machine, see your fax software documentation.

Telephone Consumer Guidelines (Canada)

Please refer to your telephone directory under 'Privacy Issues' and/or 'Terms of Service.' For more detailed information, please contact:

CRTC
Terrasses de la Chaudière, Tour centrale
1 promenade du Portage, 5 étage Hull
PQ K1A 0N2.

This Class B digital apparatus complies with Canadian ICES-003.

Cet appareil numérique de la classe B est conforme à la norme NMB-003 du Canada.

DISPOSAL OF LITHIUM ION BATTERY

You can return your unwanted lithium ion batteries to your nearest Sony Service Center or Factory Service Center.

 In some areas the disposal of lithium ion batteries in household or business trash may be prohibited.

For the Sony Service Center nearest you, call 1-888-476-6972 in the United States or 1-800-961-7669 in Canada.

! Do not handle damaged or leaking lithium ion batteries.

! Ne pas manipuler les batteries au lithium-ion qui fuient ou sont endommagées.

! Danger of explosion if battery is incorrectly replaced. Replace only with the same or equivalent type recommended by the manufacturer. Discard used batteries according to the manufacturer's instructions.

! Une batterie non conforme présente un danger d'explosion. La remplacer seulement par une batterie identique ou de type équivalent recommandé par le fabricant. Évacuer les batteries usées selon les directives du fabricant.

! The battery pack used in this device may present a fire or chemical burn hazard if mistreated. Do not disassemble, heat above 212°F (100°C) or incinerate.

Dispose of used battery promptly. Keep away from children.

! La manutention incorrecte du module de batterie de cet appareil présente un risque d'incendie ou de brûlures chimiques. Ne pas démonter, incinérer ou exposer à une température de plus de 100°C. Évacuer promptement la batterie usée. Garder hors de portée des enfants.

INDUSTRY CANADA NOTICE

NOTICE: The Industry Canada label identifies certified equipment. This certification means that the equipment meets certain telecommunications network protective, operational and safety requirements as prescribed in the appropriate Terminal Equipment Technical Requirements document(s). The Department does not guarantee the equipment will operate to the user's satisfaction.

Before installing this equipment, users should ensure that it is permissible to be connected to the facilities of the local telecommunications company. The equipment must also be installed using an acceptable method of connection.

The customer should be aware that compliance with the above conditions may not prevent degradation of service in some situations.

Repairs to certified equipment should be coordinated by a representative designated by the supplier. Equipment malfunctions or any repairs or alterations made by the user to this

equipment may give the telecommunications company cause to request that the user disconnect the equipment.

Users should ensure for their own protection that the electrical ground connections of the power utility, telephone lines and internal metallic water pipe system, if present, are connected together. This precaution may be particularly important in rural areas.

Caution: Users should not attempt to make such connections themselves, but should contact the appropriate electric inspection authority, or electrician, as appropriate.

NOTICE: The Ringer Equivalence Number (REN) assigned to each terminal device provides an indication of the maximum number of terminals allowed to be connected to a telephone interface. The termination on an interface may consist of any combination of devices subject only to the requirement that the sum of the Ringer Equivalence Numbers of all the devices does not exceed 5. The Ringer Equivalence Number for this equipment is 0.2.

AVIS DE L'INDUSTRIE CANADA

AVIS: L'étiquette d'Industrie Canada identifie le matériel homologué.

Cette étiquette certifie que le matériel est conforme aux normes de protection, d'exploitation et de sécurité des réseaux de télécommunications, comme le prescrivent les documents concernant les exigences techniques relatives au matériel terminal. Le Ministère n'assure toutefois pas que le matériel fonctionnera à la satisfaction de l'utilisateur.

Avant d'installer ce matériel, l'utilisateur doit s'assurer qu'il est permis de le raccorder aux installations de l'entreprise locale de télécommunication. Le matériel doit également être installé en suivant une méthode acceptée de raccordement. L'abonné ne doit pas oublier

qu'il est possible que la conformité aux conditions énoncées ci-dessus n'empêche pas la dégradation du service dans certaines situations.

Les réparations de matériel homologué doivent être coordonnées par un représentant désigné par le fournisseur. L'entreprise de télécommunications peut demander à l'utilisateur de débrancher un appareil à la suite de réparations ou de modifications effectuées par l'utilisateur ou à cause de mauvais fonctionnement.

Pour sa propre protection, l'utilisateur doit s'assurer que tous les fils de mise à la terre de la source d'énergie électrique, des lignes téléphoniques et des canalisations d'eau métalliques, s'il y en a, sont raccordés ensemble. Cette précaution est particulièrement importante dans les régions rurales.

Avertissement: L'utilisateur ne doit pas tenter de faire ces raccordements lui-même; il doit avoir recours à un service d'inspection des installations électriques, ou à un électricien, selon le cas.

AVIS: L'indice d'équivalence de la sonnerie (IES) assigné à chaque dispositif terminal indique le nombre maximal de terminaux qui peuvent être raccordés à une interface.

La terminaison d'une interface téléphonique peut consister en une combinaison de quelques dispositifs, à la seule condition que la somme d'indices d'équivalence de la sonnerie de tous les dispositifs n'excède pas 5. L'indice d'équivalence de la sonnerie de ce matériel est de 0.2.

Contents

Welcome	11
Features	11
Unpacking Your Notebook	12
Ergonomic Considerations	14
Setting Up Your VAIO® Notebook	19
Locating Controls and Connectors	19
Connecting a Power Source	24
Starting Your Computer	30
Shutting Down Your Computer	31
Using Your VAIO® Notebook	33
Using the Keyboard	33
Using the Touchpad	38
Using the Floppy Disk Drive	40
Using the Optical Drive	43
Using PC Cards	49
Using a Second Battery Pack	52
Using the Weight Saver	55
Using Smart Connect	57
Power Saving Modes	58
Connecting a Phone Line	60
Connecting to the Local Area Network (LAN)	61
Connecting Peripheral Devices	63
Connecting the Port Replicator	64
Connecting an External Mouse or Keyboard	68
Connecting a Printer	69
Connecting an External Display	70
Connecting a TV Display (For Models with TV Out Only)	73
Connecting a Universal Serial Bus (USB) Device	75
Connecting an i.LINK® Device	76
Connecting External Speakers	78
Connecting an External Microphone	79

Customizing Your VAIO® Notebook	81
Displaying the Sony Notebook Setup Screen	81
Controlling Power Management	83
Displaying Battery Information	87
Selecting the Display Mode	89
Adding Memory	93
About the Software on Your Notebook	97
Overview	97
MovieShaker™	101
PictureGear™	105
Software Support Information	107
Application, System, and Driver Recovery CDs	109
Using Your Recovery CDs	110
Troubleshooting	115
Specifications	127

* i.LINK is a SONY trademark used to designate that a product contains an IEEE 1394 connector. All products with an i.LINK connector may not communicate with each other.

Welcome

Congratulations on your purchase of the Sony VAIO® notebook. Sony has combined leading-edge technology in audio, video, computing, and communications to provide you with state-of-the-art personal computing.

Features

 For a complete description of the specifications of your VAIO® Notebook, see "Specifications"

- ❑ **Exceptional performance** — Your notebook includes a mobile Intel® Pentium® III processor featuring Intel® SpeedStep™ technology and a V.90 compatible K56flex modem.*
- ❑ **Portability** — Rechargeable battery pack provides hours of use without AC power.
- ❑ **Sony audio and video quality** — High-quality MPEG1/MPEG2 video, which supports full-screen display and enables you to take advantage of today's advanced multimedia applications, games, and entertainment software.
- ❑ **Multimedia features** — Enjoy the stereo speakers or use a headphone (not supplied) to listen to audio and video CDs.
- ❑ **Microsoft® Windows® operating system** — Your system includes Microsoft® Windows® Millennium Edition (WinMe) or Microsoft® Windows® 2000 Professional.
- ❑ **Communications** — Access popular online services, send e-mail, browse the Internet, and use fax features.
- ❑ **Optical drive (DVD-ROM or CD-RW/DVD-ROM)** — The CD-RW/DVD-ROM drive utilizes a new optical storage technology that combines the features of both a CD-RW drive and DVD-ROM drive, providing increased

* Actual upload and download speeds may vary due to line conditions, ISP support, and government regulations.

storage capacity and a rich multimedia computing experience. Optical drives play DVD-ROM, CD-ROM, CD-RW, and CD-R discs. (The CD-RW/DVD-ROM drive is available on select models only.)

 Your optical drive differs depending on the model you purchase.

Unpacking Your Notebook

Remove the following hardware items from the box:

Main unit*



Power cord



AC adapter

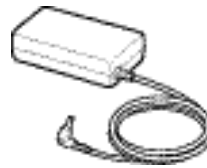

Video cable (PCG-FX150/PCG-FX150K PCG-FX170/PCG-FX170K PCG-FX190/PCG-FX190K only)



Rechargeable battery pack



Weight saver



* Removable floppy disk drive is in the multipurpose bay.

Manuals

- **VAIO® Quick Start** — Contains information on unpacking and setting up your notebook, supplementary updates, and software information.

- ❑ **Microsoft® Windows® Millennium Edition Getting Started manual or the Microsoft® Windows® 2000 Professional Getting Started manual** — Explains how to use the basic features of this latest Windows operating system.

Software CDs

- ❑ **Microsoft® Word 2000** — Allows you to reinstall Microsoft Word to the VAIO notebook you purchased.

Recovery CDs

- ❑ **System Recovery CD(s)** — Allows you to restore the software titles that shipped with your computer if they become corrupted or are erased. It can only be used to restore the hard disk of the VAIO notebook you purchased.
- ❑ **Application Recovery CD(s)** — Allows you to reinstall individual applications or device drivers if they become corrupted or erased.
- ❑ **Driver Recovery CD(s)** — Allows you to reinstall individual device drivers. Use it to restore corrupted or erased files.

Other

- ❑ Packet containing special product offers

Ergonomic Considerations

You will be using your notebook computer as a portable device in a variety of environments. Whenever possible, you should attempt to apply the following ergonomic considerations to both stationary and portable environments.

Ergonomic Position

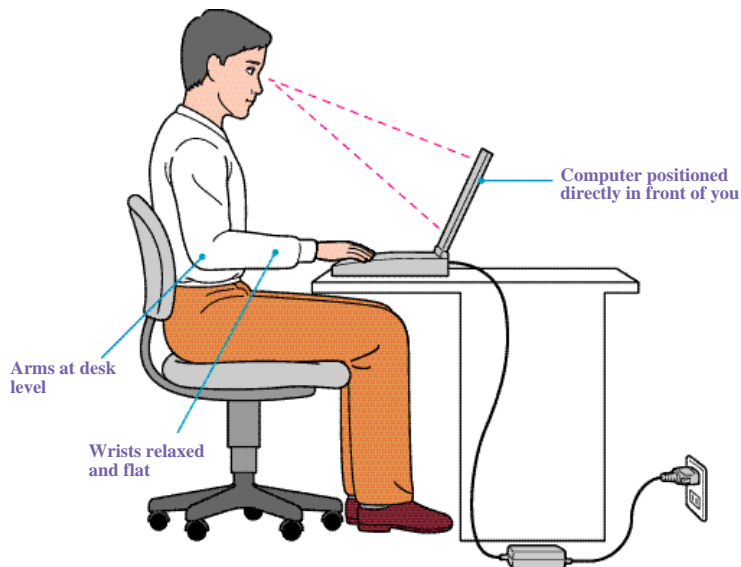

- ❑ **Position of your computer** — Place the computer directly in front of you as you work. Keep your forearms horizontal, with your wrists in a neutral, comfortable position while using the keyboard, touchpad, or external mouse. Let your upper arms hang naturally at your sides. Take breaks during sessions with your computer. Excessive use of the computer may strain muscles or tendons.
- ❑ **Furniture and posture** — Sit in a chair with good back support and armrests. Adjust the level of the chair so your feet are flat on the floor. A footrest may make you more comfortable. Sit in a relaxed, upright posture and avoid slouching forward or leaning far backward.
- ❑ **Viewing angle of the computer's display** — Use the display's tilting feature to find the best position. You can reduce eye strain and muscle

fatigue by adjusting the tilt of the display to the proper position. Adjust the brightness setting of the display also.

- ❑ **Lighting** — Choose a location where windows and lights do not create glare and reflection on the display. Use indirect lighting to avoid bright spots on the display. You can also purchase accessories for your display that help reduce glare. Proper lighting adds to your comfort and work effectiveness.
- ❑ **Placement of an external display** — When using an external display, set the display at a comfortable viewing distance. Make sure the display screen is at eye level or slightly lower when you are sitting in front of the monitor.

Notes on Setup

- ❑ Do not place your computer in a location subject to:
 - ❑ Heat sources, such as radiators or air ducts
 - ❑ Direct sunlight
 - ❑ Excessive dust
 - ❑ Moisture or rain
 - ❑ Mechanical vibration or shock
 - ❑ Strong magnets or speakers that are not magnetically shielded
 - ❑ Ambient temperature of more than 95° F (35° C) or less than 40° F (5° C)
 - ❑ High humidity
- ❑ Do not place electronic equipment near your computer. The computer's electromagnetic field may cause a malfunction.
- ❑ Provide adequate air circulation to prevent internal heat buildup. Do not place your computer on porous surfaces such as rugs or blankets, or near materials such as curtains or draperies that may block its ventilation slots. Leave a space of at least 8 inches (20 cm) behind the back panel of the computer.
- ❑ If the computer is brought directly from a cold location to a warm one, moisture may condense inside your computer. In this case, allow at least an hour before turning on your computer. If any problems occur, unplug your computer, and contact your Sony Service Center.
- ❑ The computer uses high-frequency radio signals and may cause interference to radio or TV reception. Should this occur, relocate the computer a suitable distance away from the set.

- ❑ Use only specified peripheral equipment and interface cables; otherwise, problems may result.
- ❑ Do not use cut or damaged connection cables.
- ❑ If the telephone company makes a service call to your home or office and determines that your computer is responsible for a problem, the telephone company may bill you for the service call. Also, if you do not disconnect your computer when it is adversely affecting the telephone line, the telephone company has the right to disconnect your service until you correct the problem.

Handling Your Notebook

- ❑ Clean the cabinet with a soft, dry cloth or a soft cloth lightly moistened with a mild detergent solution. Do not use any type of abrasive pad, scouring powder, or solvent such as alcohol or benzine, as these may damage the finish of your computer.
- ❑ Should any solid object or liquid fall into the computer, shut down your computer and then unplug it. You may want to have the computer checked by qualified personnel before operating it any further.
- ❑ Do not drop the computer or place heavy objects on top of the computer.

Cleaning Your Notebook

- ❑ Make sure to disconnect the power cord before cleaning the computer.
- ❑ Avoid rubbing the LCD screen as this can damage the screen. Use a soft, dry cloth to wipe the LCD screen.
- ❑ Clean the computer with a soft cloth lightly moistened with a mild detergent solution. Do not use any type of abrasive pad, scouring powder or solvent, such as alcohol or benzine.

Handling the LCD Screen

- ❑ Do not leave the LCD facing the sun as it can damage the LCD. Be careful when using the computer near a window.
- ❑ Do not scratch the LCD or exert pressure on it. This could cause malfunction.

- ❑ Using the computer in low temperature conditions may produce a residual image on the screen. This is not a malfunction. When the computer returns to normal temperature, the screen returns to normal.
- ❑ The screen becomes warm during operation. This is normal and does not indicate a malfunction.
- ❑ The LCD is manufactured using high-precision technology. You may, however, see tiny black points and/or bright points (red, blue, or green) that continuously appear on the LCD. This is a normal result of the manufacturing process and does not indicate a malfunction.

Setting Up Your VAIO® Notebook

This section describes all the controls and connectors on your computer, how to connect your computer to a power source, and how to start and shut down your computer.

Locating Controls and Connectors

Front

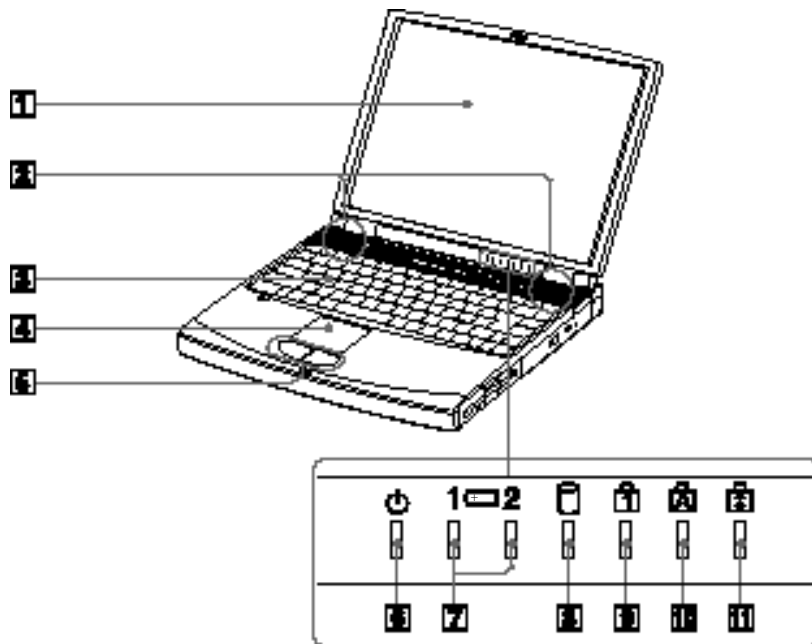

1	LCD (Liquid Crystal Display) screen	7	Battery 1 and 2 indicators
2	Speakers	8	Hard disk drive indicator
3	Keyboard	9	Num Lock indicator

4	<i>Touchpad</i>	10	<i>Caps Lock indicator</i>
5	<i>Left/right buttons</i>	11	<i>Scroll Lock indicator</i>
6	<i>Power indicator</i>		

Left

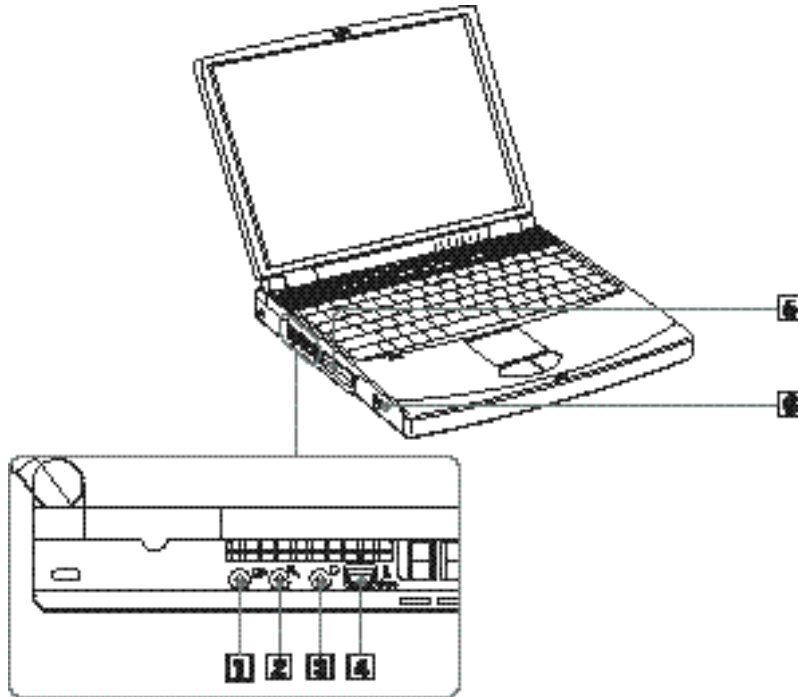

1	Video out (select models only)	4	i.LINK® (IEEE1394) S400 connector*
2	Microphone connector	5	PC card slots
3	Headphone connector	6	Battery bay

* i.LINK is a SONY trademark used only to designate that a product contains an IEEE 1394 connector. All products with an i.LINK connector may not communicate with each other.

Right



-
- | | |
|---|--|
| 1 | <i>PPK buttons</i> |
| 2 | <i>Power button</i> |
| 3 | <i>Optical drive(CD-RW/DVD-ROM drive for PCG-FX170/PCG-FX170K
PCG-FX190/PCG-FX190K)
(DVD-ROM drive for PCG-FX120/PCG-FX120K/PCG-FX140
PCG-FX140K/PCG-FX150/PCG-FX150K)</i> |
| 4 | <i>Multipurpose bay</i> |
-

[Back](#)

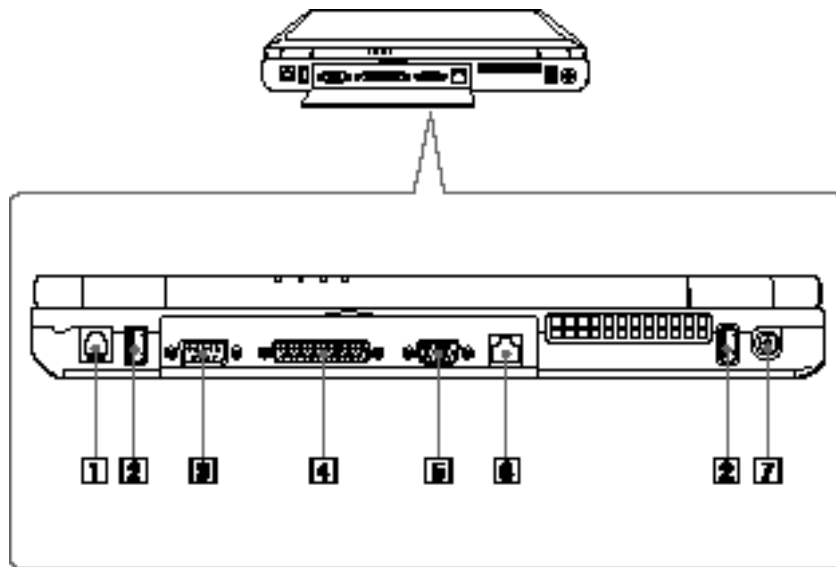

1	Modem jack	5	Monitor connector
2	USB connectors	6	Ethernet connector
3	Serial connector	7	DC In connector
4	Printer connector		



Warning:

Only connect 10BASE-T and 100BASE-TX cables to the Ethernet network port. Do not connect any other type of network cable or any telephone line. Connecting cables other than those listed above may result in an electric current overload and could cause a malfunction, excessive heat, or fire in the connector. To connect the unit to the network, contact your network administrator.



There is a ventilation slot located between the Ethernet connector and the USB connector. Do not cover the ventilation slot when your computer is on.

Bottom

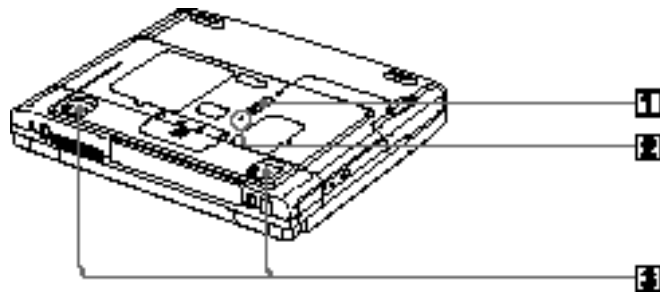

1 Multipurpose bay RELEASE lever

2 Reset switch

3 Tilt stands

Connecting a Power Source

You can use either AC power or a rechargeable battery pack as a power source.

Using the AC Adapter

- 1 Plug the cable attached to the AC adapter into the DC In connector on the computer.
- 2 Plug one end of the power cord into the AC adapter.
- 3 Plug the other end of the power cord into an AC outlet.

Connecting the AC adapter

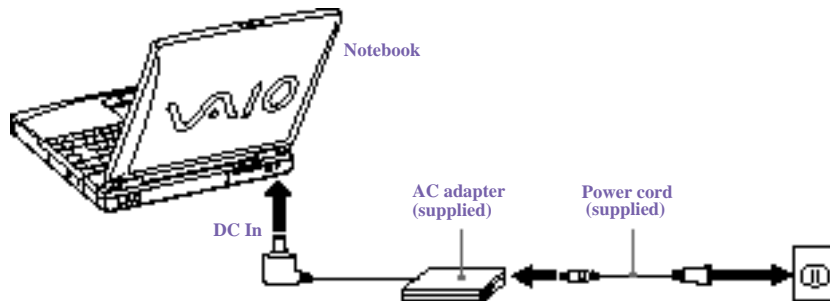

Notes on the AC Adapter

- ❑ Your computer operates on 100V-240V AC 50/60 Hz.
- ❑ Do not share the AC outlet with other power-consuming equipment, such as a copy machine or shredder.
- ❑ You can purchase a power strip with a surge protector. This device prevents damage to your computer caused by sudden power surges such as those that may occur during an electrical storm.
- ❑ Do not place heavy objects on the power cord.
- ❑ To disconnect the cord, pull it out by the plug. Never pull the cord itself.
- ❑ Unplug your computer from the wall outlet if you will not be using the computer for a long time.
- ❑ The LED indicator on the AC adapter may be turned on until the AC adapter is unplugged from your notebook.
- ❑ When the AC adapter is not used, unplug it from the AC outlet.

- ❑ Use only the AC adapter supplied. Do not use any other AC adapter.

Using Battery Power

You can use one or two battery packs as a source of power. The second battery pack inserts into the multipurpose bay on the right side of the computer. (See “Using a Second Battery Pack”) Additional battery packs are available as a separate option.

The battery pack that comes with your computer is not fully charged at the time of purchase. Follow the steps below to insert and charge the battery pack.

To insert the battery pack

- 1 To open the battery bay, press cover down.

 Cover swings out but does not detach.

Battery bay



- 2 Insert the battery pack into the battery bay on the left side of the computer.

Inserting battery pack

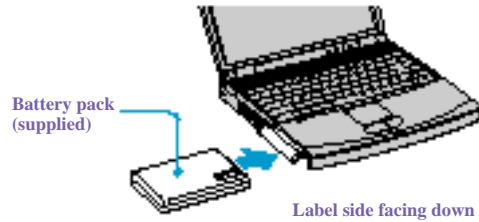

- 3 Close the cover of the battery bay until it clicks.

 If the port replicator is attached to your computer, do not attempt to insert or remove the battery pack. Lifting and turning the computer with a port replicator attached could cause a temporary loss of power.

To charge the battery pack



- 1 Connect the AC adapter to the computer.
- 2 Insert the battery pack.
The computer automatically charges the battery (the battery indicator light flashes in a double blink pattern as the battery charges).
- 3 When the battery is 85% full, the battery indicator light turns off. For PCG-FX120/FX120K, PCG-FX140/FX140K models, this process takes approximately 1.5 hours. For PCG-FX150/FX150K, PCG-FX170/FX170K, PCG-FX190/FX190K models, this process takes approximately 3.0 hours.

 To charge the battery completely, continue charging for an additional hour. See "Displaying Battery Information"

There are two battery indicator lights on the computer

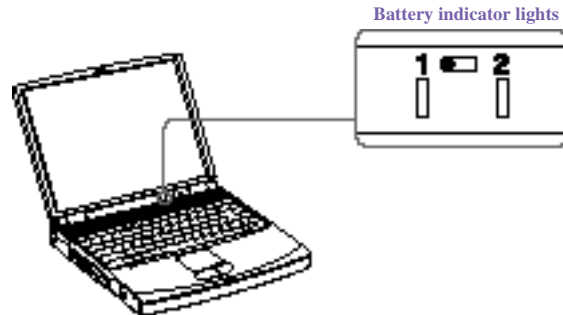
Battery indicator lights



Battery Indicator	Description
1 	Indicates the status of the battery pack in the battery bay on the left side of the computer.
2 	Indicates the status of the battery pack in the multipurpose bay on the right side of the computer.

Battery Indicator Light Status	Description
On	The computer is using battery power.
Single blink	The battery is running out of power.
Double blink	The battery is charging.
Off	The computer is using AC power.

To remove the battery pack

- 1 Open the battery bay cover.
- 2 Pull out the battery pack.

Removing the battery pack



- 3 Close the cover of the battery bay.



You will lose data if you remove the battery pack while the computer is on and not connected to the AC adapter or if you remove the battery while the computer is in a power-saving mode

Notes on the battery

- ❑ To determine the remaining battery charge, see “Displaying Battery Information.”
- ❑ When the battery power is running low, both the battery and power indicators blink.
- ❑ When the computer is directly connected to AC power and has a battery pack in the battery bay, it uses power from the AC outlet.
- ❑ See “Using a Second Battery Pack” for information on installing and charging a battery pack in the multipurpose bay.
- ❑ Keep the battery pack in the computer while it is directly connected to AC power. The battery pack continues to charge while you are using the computer.
- ❑ If the battery level falls below 10%, you should either attach the AC adapter to recharge the battery or shut down your computer and insert a fully charged battery.

- ❑ You can extend battery life by changing the power-management modes in the PowerPanel utility. See “Power Saving Modes”
- ❑ The battery pack supplied with your computer is a lithium-ion battery and can be recharged at any time. Charging a partially discharged battery does not affect battery life.
- ❑ The battery indicator light is on while you use the battery pack as a power source. When battery life is nearly depleted, the battery indicator starts flashing.
- ❑ For some software applications and some peripheral devices, your computer may not enter Hibernate mode when the battery life is low. To avoid loss of data when using battery power, you should save your data frequently and manually activate a power-management mode, such as Standby or Hibernate.
- ❑ Never leave the battery pack in temperatures above 140° F (60° C), such as under direct sunlight or in a car parked in the sun.
- ❑ Battery life is shorter in a cold environment. This is due to decreased battery efficiency at low temperatures.
- ❑ Charge the batteries at temperatures between 50° F and 80° F (10° C to 30° C). Lower temperatures require a longer charging time.
- ❑ While the battery is in use or being discharged, the battery pack heats up. This is normal and is not cause for concern.
- ❑ Keep the battery pack away from all sources of heat.
- ❑ Keep the battery pack dry.
- ❑ Do not open or try to disassemble the battery pack.
- ❑ Do not expose the battery pack to any mechanical shock.
- ❑ If you are not using the computer for an extended period of time, remove the battery pack from the computer to prevent damage to the battery.
- ❑ If, after fully charging the battery pack, the battery power is still low, the battery pack may be reaching the end of its life and should be replaced.
- ❑ You do not need to discharge the battery before recharging.
- ❑ If you have not used the battery pack for a considerable amount of time, recharge the battery.

Starting Your Computer

- 1 Slide the LCD lock lever in the direction of the arrow, and lift the cover.

Opening the computer

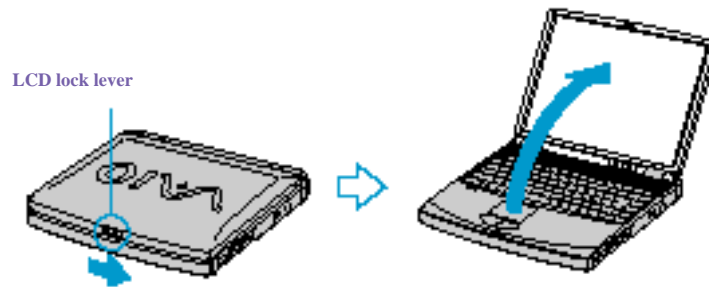

- 2 Press the power button on top of the computer until the green power indicator light turns on.

 (Windows Me™ only) When starting your notebook for the first time, the VAIO InitManager dialog box will appear. Please select "OK" to begin initial setup. If you do not execute the initial setup, you cannot use VAIO original hardware functions such as PPK, Power Management tools, the scroll function of the touchpad, and keyboard shortcut key combined with Fn key.

Power button





 If you hold the power button in the On position for more than four seconds, the computer turns off.

- 3 If necessary, adjust the brightness controls for the LCD display as follows:
 - To decrease brightness, press Fn+F5 then the down or left arrow key.
 - To increase brightness, press Fn+F5 then the up or right arrow key.

Shutting Down Your Computer

To avoid potential loss of data, follow these steps to shut down your computer.

- 1 Click the Start button on the Windows® taskbar.
 - 2 Click Shut Down at the bottom of the Start menu to display the Shut Down Windows dialog box.
 - 3 Select Shut Down.
 - 4 Click OK.
-  Respond to any prompts warning you to save documents.
- 5 Wait for your computer to turn off automatically—power indicator turns off.
 - 6 Turn off any peripherals connected to your computer.

 During a period of inactivity, you can conserve battery life by using Standby mode. See "Controlling Power Management" .

If you are unable to shut down your computer.

- 1 Close or end all operations as follows:
 - Close all applications.
 - Remove the PC cards.
 - Disconnect USB devices.
- 2 Restart the computer. You can restart your computer by pressing Ctrl+Alt+Delete keys (at the same time).

 If you are still unable to shut down the computer, you can press the power button and hold it for 5 seconds. This operation may result in data loss.

Using Your VAIO® Notebook



Using the Keyboard

Your keyboard is very similar to a typewriter's, but the keyboard has additional keys that perform specific computer-related tasks.

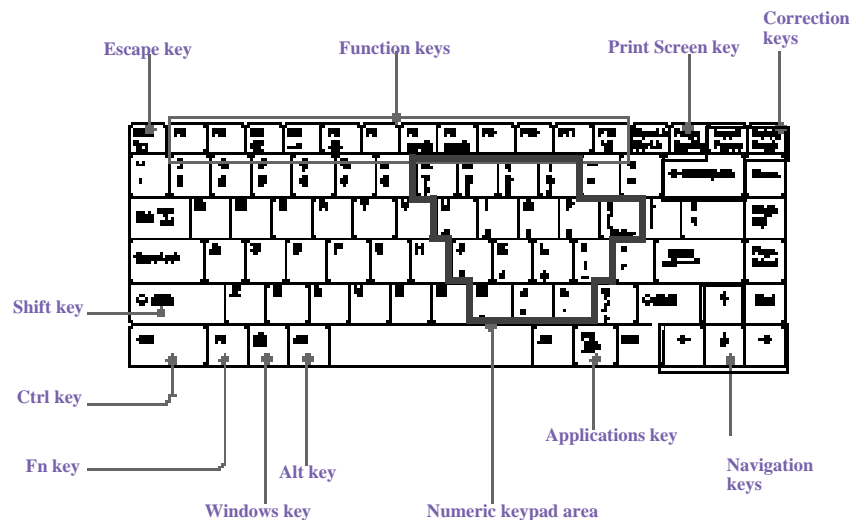



Keyboard







<i>Key</i>	<i>Description</i>
Numeric keypad area	Contains the keys found on a typical calculator. Use the numeric keypad area to type numbers or to perform mathematical calculations such as addition and subtraction. Note that you must press the Num Lock key to activate the numeric keypad. (When you do so, the Num Lock light will be on.)
Navigation keys	Several keys are devoted to moving the cursor on the screen.
Correction keys	The Insert, Back Space, and Delete keys enable you to make corrections in your documents.





<i>Key</i>	<i>Description</i>
Function keys	The twelve function keys along the top of the keyboard are used to perform designated tasks. For example, in many applications, F1 is the Help key. The task associated with each function key may vary from one application to the next.
Escape key	The Esc (Escape) key is used to cancel commands.
Print Screen key	The Print Screen key takes an electronic snapshot of the screen and places it in the Windows Clipboard. You can then paste the screen shot into a document and print it.
Operator keys	Several keys are always used with at least one other key: Ctrl, Alt, and Shift. When held down with another key, the Ctrl (Control) and Alt (Alternate) keys offer another way to give commands. For example, in many applications, instead of choosing the Save command from a menu, you can hold down Ctrl and press S (referred to as Ctrl+S). The Shift key operates the same way as on a typewriter; it is used to produce capital letters or special symbols such as @ and \$.
Windows key 	The key with the Windows logo displays the Windows Start menu; it is the equivalent of clicking the Start button on the taskbar. See “Combinations and Functions with the Windows Key”.
Fn key	The Fn key is used in combination with other keys to issue commands. See “Combinations and Functions with the Fn Key”.
Applications key 	The Applications key displays a shortcut menu of context-sensitive choices. Pressing this key is the equivalent of clicking the right mouse button.

Combinations and Functions with the Windows Key

<i>Combination</i>	<i>Function</i>
 + F1	Displays Windows Help.
 + Tab	Switches the selected button on the taskbar.
 + E	Displays Windows Explorer.
 + F	Displays the Windows Find: All Files window to find a file or folder. This is the equivalent of selecting Find and then Files or Folders from the Start menu.

<i>Combination</i>	<i>Function</i>
 + Ctrl + F	Displays the Windows Find: Computer window where you can locate other computers. This is the equivalent of selecting Find and then Computer from the Start menu.
 + M	Minimizes all displayed windows.
Shift +  + M	Returns all minimized windows to their previous size.
 + R	Displays the Run window. This is the equivalent of selecting Run from the Start menu.
Fn +  + Insert	Displays the Properties window. This is the equivalent of double-clicking the System icon in the Control Panel.













Indicators

<i>Indicator</i>	<i>Function</i>
Power 	Light is green when the power to the computer is turned on, flashes amber in Standby mode, and turns off when the computer is in Hibernate mode or powered off.
Battery 1 1 	Indicates the status of the battery inserted in the battery bay on the left side of the computer.
Battery 2  2	Indicates the status of the battery inserted in the multipurpose drive bay on the right side of the computer.
Hard disk 	Lights when data is being read from or written to the hard drive. Do not enter Standby mode or turn off the computer when this indicator light is on.



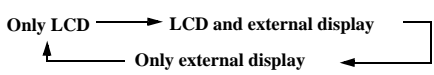

Indicator (continued)

<i>Light</i>	<i>On</i>	<i>Off</i>
Num Lock	The number keys in the numeric keypad are active.	The alphanumeric character keys in the keypad area are active.
Caps Lock	The letters appear in uppercase as you type. The Shift key lowers the case of typed letters when Caps Lock is on.	Letters appear in lower case as you type (unless you hold down the Shift key).
Scroll Lock	The screen scrolls differently. (Exactly how it scrolls depends on the specific application. It has no effect in many applications.)	Information moves across the display normally.

Combinations and Functions with the Fn Key

<i>Combinations/ Feature</i>	<i>Function</i>
Fn+  (ESC) Standby	Puts the system into Standby mode, a power- management state. To return the system to the active state, press any key or press the power button on your computer.
Fn+  (F3) Mute On/Off	Toggles the built-in speaker off and on.
Fn+  (F4) Speaker volume	Adjusts the built-in speaker volume. To increase volume, press Fn+F4, then  or  . To decrease volume, press Fn+F4, then  or  .
Fn+  (F5) Brightness control	Adjusts the brightness of the LCD. To increase light intensity, press Fn+F5 and then  or  . To decrease light intensity, press Fn+F5 and then  or  .
Fn+  (F7) Switch to the external monitor/ LCD	Toggles through the LCD, external display (connected to the <input type="checkbox"/> Monitor connector) and both LCD and external display. <div style="text-align: center;">  <p>Only LCD → LCD and external display ← Only external display ←</p> </div> <p>Connect the cable before you turn on the computer, otherwise Fn + F7 will not work.</p>

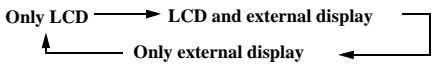
Combinations and Functions with the Fn Key (Continued)

Combinations/ Feature	Function
Fn+  only/  (F8) Control TV out (for models with TV Out only)	<p>Toggles between LCD-only and dual LCD/TV display modes.</p>  <p>Connect the cable before you turn on the computer, otherwise Fn + F8 will not work.</p>
Fn+  (F12) Hibernate	Provides for the lowest level of power consumption. When you execute this command, the state of the system and state of the peripheral devices are written to the hard disk and the system power is turned off. To return the system to its original state, use the power button to turn on power.
Fn+D Video standby	Turns off the LCD to save power. To turn the LCD back on, press any key (Windows™ Me only).

 Some functions are not available until Windows launches.

Using the Touchpad

The keyboard contains a cursor-pointing device called a touchpad. You can point to, select, drag, and scroll objects on the screen using the built-in touchpad.

Touchpad

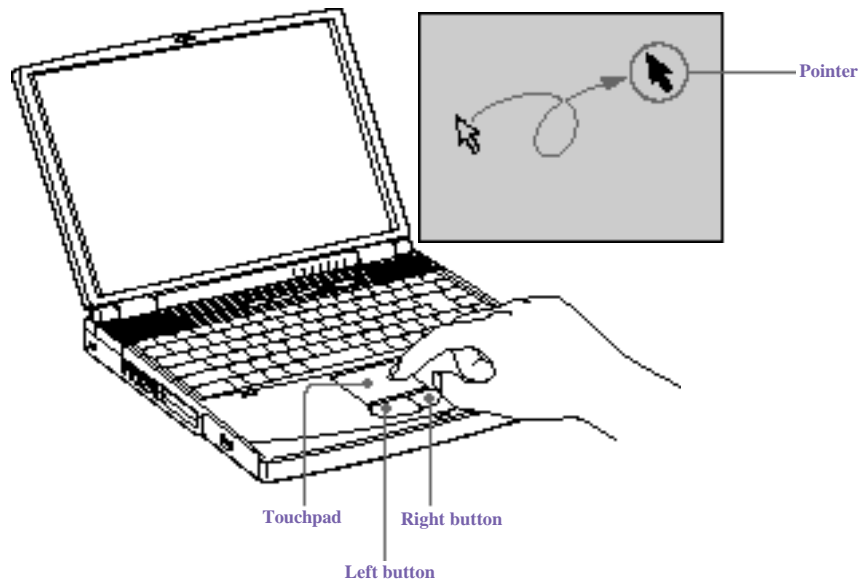

<i>Action</i>	<i>Description</i>
Point	Slide one finger on the touchpad to place the pointer on an item or object.
Click	Press the left button once.
Double-click	Press the left button twice.
Right-click	Press the right button once. In many applications, this action displays a shortcut menu of context-sensitive choices.
Drag	Slide one finger while pressing the left button.
Scroll	Move your finger along the right edge of the touchpad to scroll vertically. Move your finger along the bottom to scroll horizontally. (The scroll function is available only with applications that support a touchpad scroll feature.)

 See Mouse Properties for information on touchpad features, such as clicking both buttons simultaneously, adjusting touchpad speed, and Easy Launcher functions. To access Mouse Properties, click the Start button, point to Settings, point to Control Panel, and then click the Mouse icon in the Control Panel.

Using the Floppy Disk Drive

Your computer comes with the floppy disk drive in the multipurpose bay.

To insert a diskette

- 1 Hold the diskette the label side facing up.
- 2 Gently push the diskette into the drive until it clicks into place.



To remove a diskette

- When you finish using the diskette, wait until the LED indicator light turns off and then press the Eject button to remove the diskette.

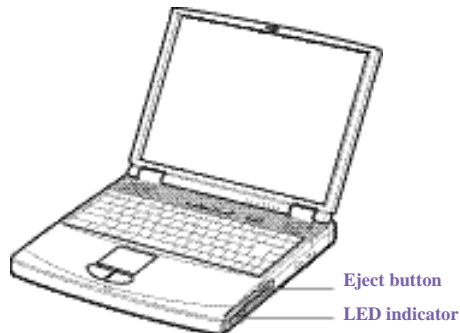

 Do not push the eject button when the LED indicator is turned on. Otherwise, data may be lost.

To remove the floppy disk drive

- 1 Turn off the computer.
- 2 There is a RELEASE lever on the bottom of the computer. Slide this lever in the direction of the arrow.

Multipurpose bay release lever

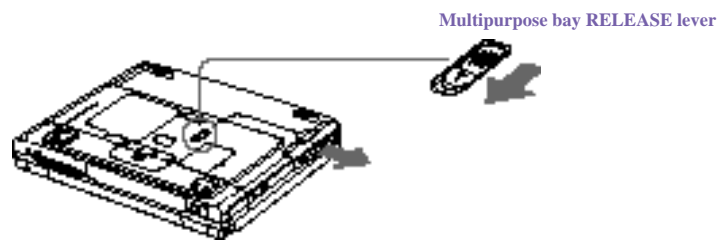

- 3 Slide the drive out of the multipurpose bay.
- 4 Insert the weight saver. See “Using the Weight Saver”.

To reinsert the floppy disk drive

- 1 Turn off the computer.
- 2 If another device is in the multipurpose bay, remove the device. See “To remove the second battery pack”.

- 3 Insert the floppy disk drive into the multipurpose bay with the VAIO label facing up. Continue pushing the drive into the bay until the RELEASE lever locks into place.

Inserting the floppy disk drive

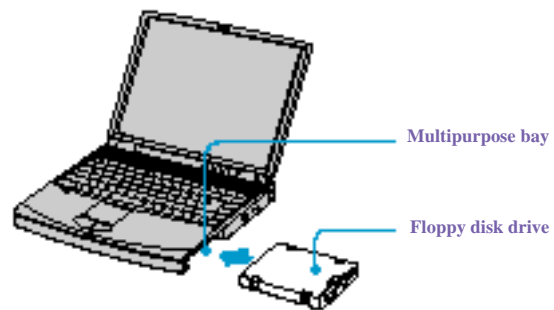

Using the Optical Drive

Your computer comes with an optical drive (CD-RW/DVD-ROM drive or DVD-ROM drive), depending on the model you purchase.

To insert a disc

- 1 Turn on the computer.

 When the computer is in Standby or Hibernate mode, you cannot insert a disc. See "Controlling Power Management" for more information on Standby and Hibernate modes.

- 2 Press the Eject button to open the CD-RW/DVD-ROM drive.

The tray slides out.

Ejecting the tray

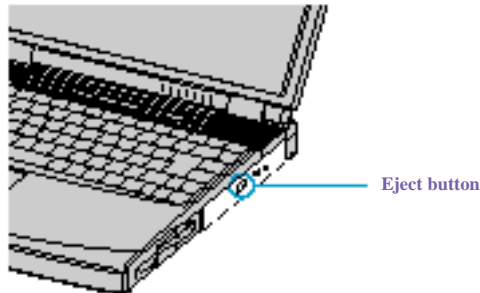

- 3 Place an optical disc on the tray with the label side facing up. For DVDs which can be played on both sides, the side of the disc facing up is the side that plays.

- 4 Push the disc onto the hub until the disc clicks securely into place.

Inserting an optical disc

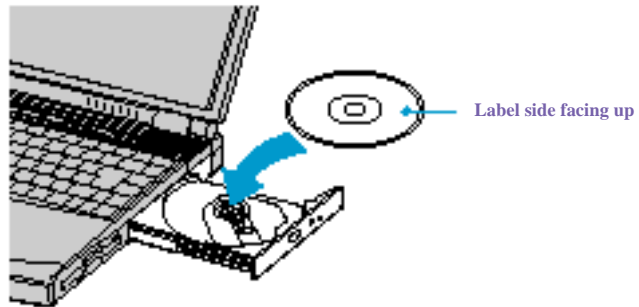

5 Close the tray by pushing it gently.

 Be sure to seat the disc firmly over the hub fingers. If you do not seat the disc firmly, you could damage your optical drive and you may not be able to open the tray.

When you finish using a disc, wait until the LED indicator light turns off, then press the Eject button to remove the disc.

When the computer is in power saving modes, you cannot remove a disc. See "Controlling Power Management" for more information about power saving modes.

If the disc does not come out when you press the Eject button, turn off the computer and insert a thin, pointed object into the manual eject hole.

Manual eject hole

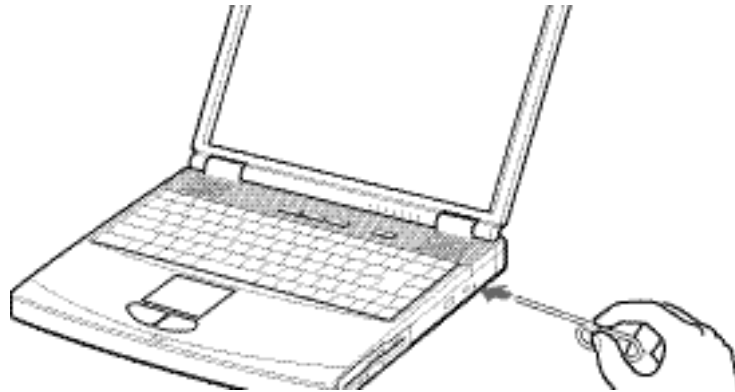

Playing a DVD

To achieve optimum performance when playing DVDs, it is recommended that your computer not be connected to the port replicator while playing DVD movies or using DVD applications. Close any open applications before playing a DVD movie.

 When playing DVD movies on battery power, set the power management profile to DVD. With other profiles, the movies are choppy. As an alternative, you can set the power management profile to Automatic Profile Selection, which will cause the DVD profile to be selected automatically whenever you insert a DVD. See "Controlling Power Management" for information on how to set the power management profile.

- You can play DVDs using the DVD-ROM drive and the WinDVD software. See the help file that comes with the WinDVD software for details.

Some discs recorded at 20 or 24 bits may produce noise while playing. If you have audio devices connected, this may cause damage to your hearing and the speakers. Reduce the volume before playing such discs.

You cannot switch between LCD and TV if you press Fn+F8 when a DVD is inserted in the optical drive.

If you have connected a TV, follow the instructions in “Selecting the Display Mode”.

 For Models with TV Out Only

When a TV is connected to a notebook that is set to factory settings, a part of the video screen will not appear. To view the entire screen, adjust the display resolution to 640x 480 and refer to “Selecting the Display Mode”.

If you set the display resolution higher than the default setting (1280 x 1024, 24 bits), the DVD video may not play properly.

(For PCG-FX190/FX190K models only) To view the DVD video clearly, set the display resolution to 1024 x 768 dots (16 bits).

(For models with SXGA+ panel only) If the DVD video does not play properly, change the display resolution to 1024x 768 dots (16 bits).

- ! Do not switch the power saving modes while you are playing the DVD disc.
- ! Do not switch between LCD and the external display while you are playing the DVD video.
- ! Change the setting to disable the screen saver and the virus checker (if it is active).
- ! Do not use memory-resident utility software to speed up disc access. This may cause the computer to malfunction.

Notes on CD and DVD media

- ❑ Do not drop or bend the disc.
- ❑ Do not touch the surface of the disc. Fingerprints and dust on the surface of a disc may cause read errors. Proper care of the disc is essential to maintain its reliability. Do not use solvents such as benzine, thinner, commercially available cleaners or anti-static spray, as they may cause damage to the disc.
- ❑ For normal cleaning, hold the disc by its edge and use a soft cloth to wipe the surface from the center out.
- ❑ If the disc is badly soiled, moisten a soft cloth with water, wring it out well, and use it to wipe the surface of the disc from the center out. Wipe off any remaining moisture with a dry soft cloth

Writing data to CD-RW/CD-R media (For models with a CD-RW/DVD-ROM drive)

If you use DirectCD™ to write data, you must first format the disc before writing on a new CD-RW or CD-R. If you do not format the disc, your computer will not recognize it.

 If you use Easy CD Creator™ to write data to a CD-RW or CD-R, you do not have to format the disc.

Formatting time and available capacity after formatting when you use a 74-minute CD-RW or CD-R is as follows:

<i>Media</i>	<i>Formatting Time</i>	<i>Capacity After Formatting</i>
CD-RW	Approximately 30 minutes	Approximately 530 MB
CD-R	Approximately 5 seconds	Approximately 620 MB

To make a CD-R to which data has been written readable on a CD-ROM drive, you need to complete the disc when you eject it. To complete this process, follow the instructions included with your software.

 For optimal writing speed, deactivate the screen saver and exit anti-virus software before writing data to a disc.

For best results, use CD-Rs that are compatible with 4x speed, as DirectCD™ and Easy CD Creator™ are preset to that speed. Your notebook does not support 1x writing speed. If you use CD-RW or CD-R writing software other than DirectCD™, use PowerPanel to select the DVD Profile.

When using Easy Creator™ Standard, be sure to close and exit all other applications.

If your notebook computer has preinstalled Microsoft® Office applications, such as Excel, Word, and Outlook, turn off the FindFast application.

Do not put your notebook into power saving mode while using DirectCD™ to write data, or while using Easy CD Creator™.



Never touch the surface of the disc. Fingerprints and dust on the surface of a disc may cause writing errors.

Do not strike or shake the computer while writing data to a disc.

Memory-resident disc utilities may cause unstable operation or data loss. Deactivate these utilities before writing data to a disc.

Always use the AC adapter as the power source for your computer when you are writing data to a CD-RW or CD-R. Using battery power may result in data transfer failure.

Using PC Cards

Your computer includes two PC card slots. PC cards allow you to connect portable external devices such as another hard disk drive, or to connect a network.

 The PC card slots can accommodate two Type I/II PC cards, or one Type III PC card. These slots are compatible with CardBus. Use the lower slot for Type III PC cards. You do not need to shut down your notebook before inserting or removing a PC card.

To insert a PC card

- 1 Push the Release button once. The Release button pops out.

PC card release button

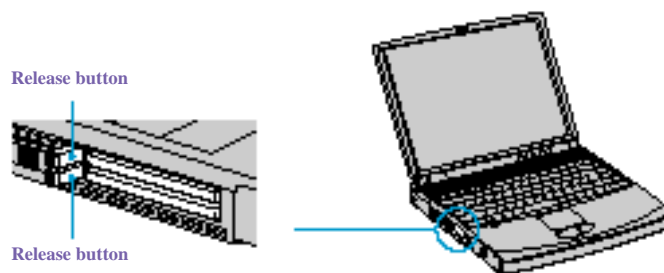

- 2 Push the Release button a second time. The PC card pops out.
When you use a Type III PC card, you need to remove both the top and

bottom PC card slot protectors.

PC card slot protector

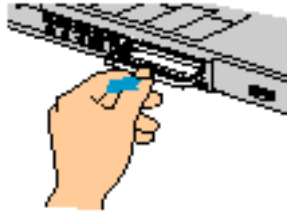

- 3 Insert the PC card into the PC card slot. Make sure the front label of the PC card is facing up.
- 4 Push the the PC card slot gently into the connector. The PC card is automatically detected by your system. The  (Unplug or Eject Hardware icon) appears in the taskbar.

Inserting a PC card

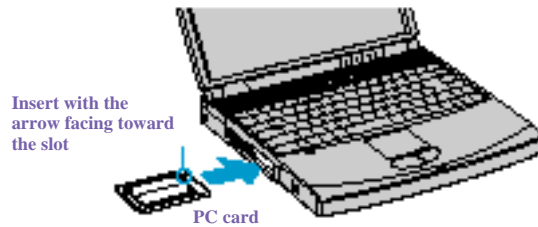

Do not force a PC card into the slot as this may damage the connector pins.

Do not carry your computer while touching the head of a PC card (such as a wireless LAN card), pressure or shock may damage the connector pins.

To remove a PC card



If your computer is turned off, you do not have to follow these instructions.

- 1 Double-click  in the taskbar. The “Unplug or Eject Hardware” dialog box appears.
- 2 Select the hardware device you wish to remove.
- 3 Click Stop. In the “Stop a Hardware device” dialog box, confirm that the device can be safely removed from the system.
- 4 Click OK. The message, “PC Card can now be safely removed from the system” appears.
- 5 Click OK again and click Close.
- 6 Push the Release button. The Release button pops out.
- 7 Push the Release button a second time. The PC card pops out. Gently grasp the card and pull it out of the slot.
- 8 Insert the PC card slot protector into the empty slot.

Notes on using PC cards

- ❑ For some PC cards, if you alternate between normal power operation and the Standby or Hibernate power-management modes while the card is inserted, you may find that a device connected to your system is not recognized. Reboot your system to correct the problem.
- ❑ Some PC cards may require that you disable idle devices when using the PC card. You can use Sony Notebook Setup to disable devices. See “Displaying the Sony Notebook Setup Screen” for details.
- ❑ Be sure to use the most recent software driver provided by the PC card manufacturer.
- ❑ If an “!” mark appears on the Device Manager tab in the System Properties dialog box, remove the software driver and then reinstall it.
- ❑ You may not be able to use some PC cards or some functions of the PC card with this computer. If you have difficulty inserting a card, check that you are orienting the card correctly. See the manual that came with your PC card for more information on use.

Using a Second Battery Pack

You can purchase a second rechargeable battery pack. With two battery packs, you can extend the time that you use your computer with battery power. When using two battery packs, the battery pack you insert first charges first. The battery pack you insert second charges when the first battery pack is 85 percent full. You can monitor which battery pack is charging by observing the battery indicator lights.

To insert a second battery pack

- 1 If another device is in the multipurpose bay, remove the device.
- 2 Insert the battery pack into the multipurpose bay.
If the battery is being used, the battery 2 indicator light turns on.

Second battery in multipurpose bay

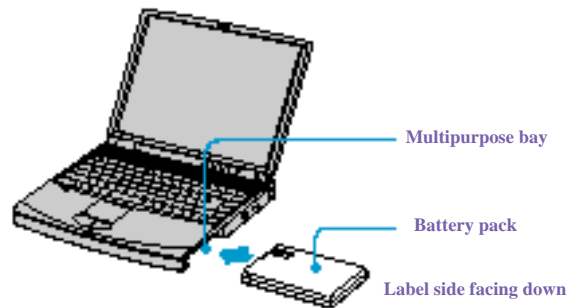

- 3 Attach the weight saver to the computer to stabilize the battery pack. There is a RELEASE lever on the bottom of the weight saver. Slide the lever toward the front of the computer to lock the weight saver. See also “Using the Weight Saver”.

To charge the second battery pack

Using weight saver for second battery cover

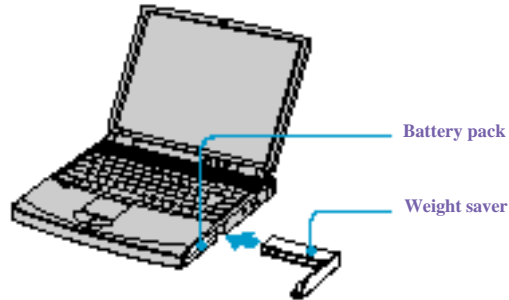

Keep the battery pack in the computer while it is connected to AC power. The battery indicator flashes while the battery is charging. See also “To charge the battery pack” for more information.

Charging the second battery

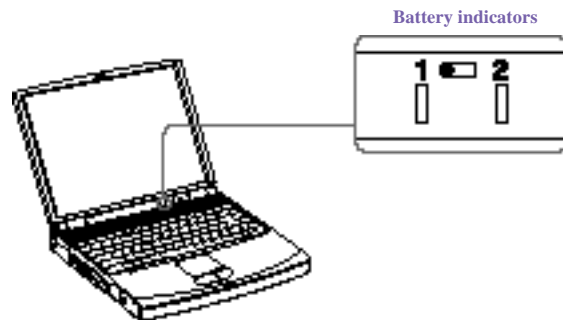

 To determine the amount of time the battery lasts, see “Displaying Battery Information”

To remove the second battery pack

If you attach two battery packs, you can remove either of them without shutting down the computer. When removing one battery pack, make sure that the other battery pack's indicator light is on. If the indicator light of the battery pack you are removing is on, right-click the battery icon on the task tray and click the "Switch discharge battery" option.

- 1 There is a Release lever on the bottom of the weight saver. To remove the battery pack, slide this lever in the direction of arrow 1, then slide the RELEASE lever on the bottom of the computer in the direction of arrow 2.

Multipurpose bay release levers

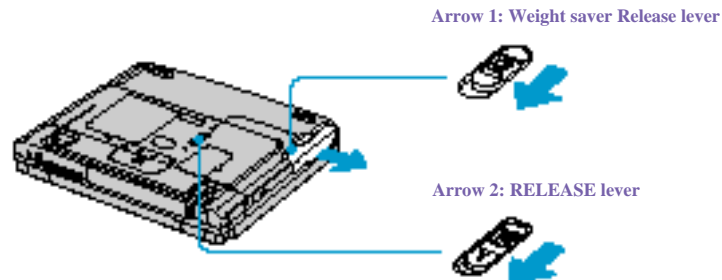

- 2 Remove the weight saver, and then pull out the battery pack.
- 3 Reinsert the weight saver. See "Using the Weight Saver".

Using the Weight Saver

The weight saver protects the multipurpose bay when it is empty.

To attach the weight saver

- 1 If another device is in the multipurpose bay, remove the device. See “To remove the second battery pack”.
- 2 Fold out the hinged arm of the weight saver and then push on the hinged arm to lock it into place. Slide the weight saver in the direction of the arrow until it clicks.

Inserting the weight saver

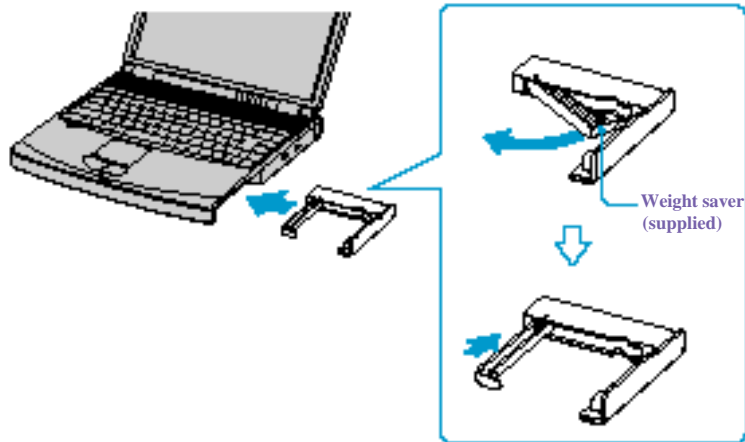

- 3 Manually lock the weight saver's Release lever.

To remove the Weight Saver

- 1 There is a release lever on the bottom of the weight saver. To remove the weight saver, slide this lever in the direction of arrow 1, then slide the Release lever on the bottom of the computer in the direction of arrow 2.

Multipurpose bay release levers

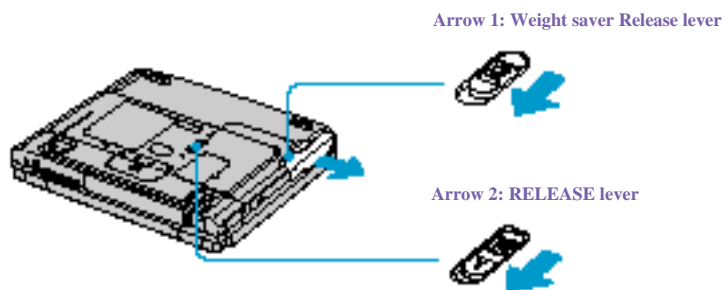

- 2 After removing the weight saver, pull out the weight saver's hinged arm and fold it into the weight saver.

Using Smart Connect

Windows Me™

You can connect your VAIO® notebook to another VAIO computer that has the preinstalled Windows Me operating system or the Sony Smart Connect 3.0 software preinstalled. You may use an i.LINK® cable (optional) to connect the two systems and then use one computer to edit, copy, or delete files on the other computer. You can also print from a printer that is attached to either computer. Select the STD mode in Smart Connect 3.0 software to connect with another computer that has Windows Me preinstalled.

Connecting with an i.LINK cable

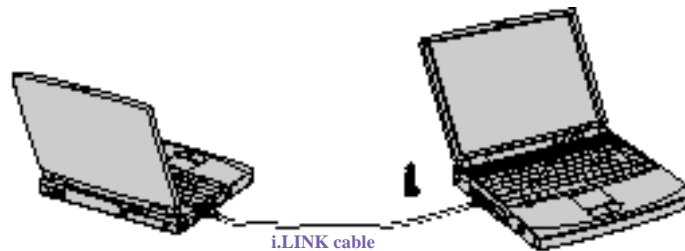

Windows 2000

The preinstalled Smart Connect software allows you to use an i.LINK® cable (optional) to connect your VAIO notebook to another VAIO computer that also has Smart Connect or preinstalled Windows Me. You can then use one computer to edit, copy or delete files on the other computer. You can also print from a printer attached to either computer.

See Smart Connect online help for more information.

 When you connect two VAIO computers, you must assign each computer a unique name. The computers can be identified by this unique name when the two computers are networked together.

* i.LINK is a SONY trademark used only to designate that a product contains an IEEE 1394 connector. All products with an i.LINK connector may not communicate with each other.

 If you have previously purchased a VAIO computer or notebook that does not have the Windows Me operating system or Smart Connect 3.0 software preinstalled, consult the Sony website for support options (<http://www.sony.com/pcsupport>).

Power Saving Modes

When you use a battery as the source of power for your computer, you can take advantage of power management settings to conserve battery life. In addition to the normal operating mode, which allows you to turn off specific devices, your computer has two distinct power saving modes: Standby and Hibernate. When using battery power, be aware that the computer automatically enters Hibernate mode when the remaining battery charge drops below 5 percent, regardless of the power management setting you select.

 If the battery level falls below 10 percent, you should either attach the AC adapter to recharge the battery or shut down your computer and insert a fully charged battery.

Normal Mode

Normal mode is the normal state of your computer when it is in use. The power indicator light displays green when your computer is in this mode. To save power, you can turn off a specific device such as the LCD or the hard disk.

Standby Mode

In Standby Mode the computer saves the current state of the system in RAM and switches off power to the CPU. The amber power indicator light flashes in this mode.

To activate Standby mode

To activate Standby mode, press the key combination Fn+Esc, or press the power button and release it immediately. You can also use the PowerPanel utility to enter Standby mode.

To return to normal mode

Press any key to return to normal mode.

Hibernate Mode

In the Hibernate mode, the state of the system is saved on the hard drive and power is turned off. The power indicator light is off in this mode.

To activate Hibernate mode

To activate Hibernate mode, press the key combination Fn+F12.

 (Windows 2000) The "Save to Disk Manager" screen appears, and then the computer enters Hibernate mode.

 Do not move the notebook until its power indicator light turns off.

To return to normal mode

To return to normal mode, turn on the computer by pressing the power button. The computer returns to its previous state.

 When returning from Hibernate mode, the system status stored on the hard disk is erased and the computer starts normally if you press the power button and hold for more than four seconds.

- Time required to return to normal mode
Standby requires less time than Hibernate to return to normal mode.
- Power consumption
Standby uses more power than Hibernate.

Connecting a Phone Line

You need to connect a phone line to take advantage of online services and the Internet.

 In order to register your Sony VAIO notebook, register your software online, and use Sony Customer Support, you must connect to a phone line.

- 1 Plug one end of the phone cable into the modem jack on the computer.

Connecting phone cable

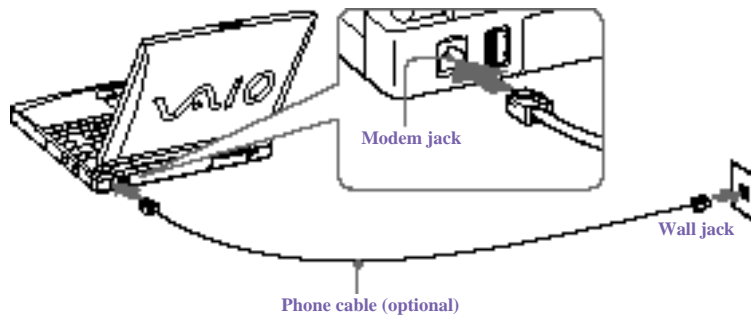

- 2 Plug the other end into the wall jack.

 Your computer does not work with party lines, cannot be connected to a coin-operated telephone, and may not work with multiple phone lines or a private branch exchange (PBX). Some of these connections may result in excess electrical current and could cause a malfunction in the internal modem.

If you connect a phone line coming through a splitter, the modem or connected device may not work properly.

Connecting to the Local Area Network (LAN)

You can connect your computer to 10BASE-T and 100BASE-TX-type networks. For the detailed settings and devices needed to connect to the network, ask your network administrator.

Connecting to LAN

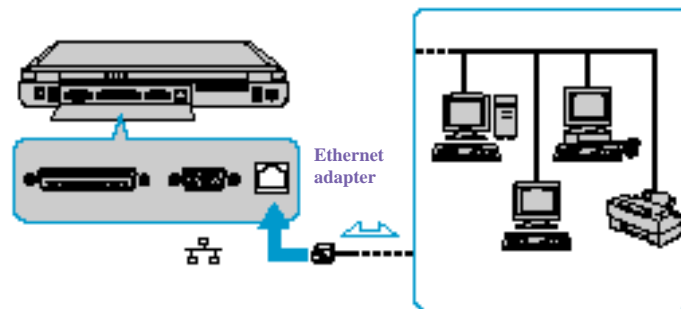

Warning: Only connect 10BASE-T and 100BASE-TX cables to the  (Ethernet network) port. Do not connect any other type of network cable or any telephone line. Connecting cables other than those listed above may result in an electric current overload and could cause a malfunction, excessive heat, or fire in the connector. To connect the unit to the network, contact your network administrator.

Note that if you enable Wake on LAN, the power saving mode will be switched to Standby mode.

Setting Up Your Ethernet Connection

Windows Me™ models

- 1 Right-click Network Neighborhood and select Properties.
- 2 Click Add to add a client, adapter, protocol, or service.
- 3 Click File and Print Sharing to enable these functions.
- 4 Select a Primary Network Logon.

- 5 Click the Identification tab to set the computer name, workgroup, and computer description.
- 6 Click the Access Control tab to set the share level or user level access control.

Windows 2000 models

To connect to the network

- 1 Right-click My Network Places and select Properties.
- 2 Click Advanced and select Network Identification to set the computer name, domain, workgroup, and DNS suffix. You can also use the Network Identification Wizard.

To set the connections, bindings, and provider order

- 1 Right-click My Network Places and select Properties
- 2 Click Advanced and select Advanced Settings. This will give you access to Adapters and Protocol Bindings and Provider Order.

Connecting Peripheral Devices

You can add functionality to your computer by connecting a variety of peripherals, as discussed in the following sections:





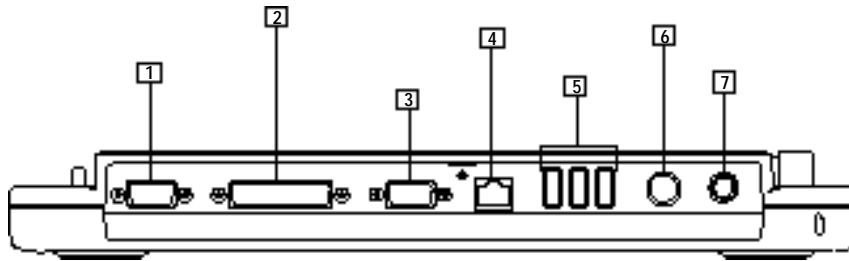

- ❑ “Connecting the Port Replicator”
- ❑ “Connecting an External Mouse or Keyboard”
- ❑ “Connecting a Printer”
- ❑ “Connecting an External Display”
- ❑ “Connecting a TV Display (For Models with TV Out Only)”
- ❑ “Connecting a Universal Serial Bus (USB) Device”
- ❑ “Connecting an i.LINK® Device”
- ❑ “Connecting External Speakers”
- ❑ “Connecting an External Microphone”

Connecting the Port Replicator

Your notebook supports the use of an optional port replicator (PCGA-PRFX1). Attaching a port replicator enables you to connect additional peripherals to your computer.

Port replicator



1	 Serial Port	5	 USB Ports
2	 Printer Port	6	 Mouse/Keyboard (PS/2 Port)
3	 Monitor Port	7	 DC In
4	 Network (Ethernet 10BaseT)		

 The port replicator can be powered only with an AC power adapter. Do not remove the AC adapter from the port replicator or the AC outlet while using the port replicator; this may cause data damage or hardware malfunctions.

When you attach your computer to the port replicator for the first time, the installation of the network driver starts automatically.

To attach your computer to the port replicator

To supply power to your computer while it is connected to the port replicator, you can connect the AC adapter directly to the port replicator.

 When attaching your computer to the port replicator, do not attempt to insert or remove the battery pack. Lifting and turning the computer with an attached port replicator could cause a temporary loss of power.

- 1 Turn off your computer and disconnect all peripheral devices.
- 2 On the bottom of the computer, slide the port replicator connector cover open.

Port replicator connector

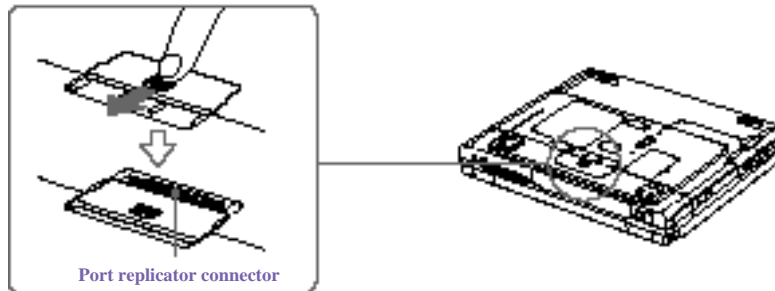

- 3 Attach the bottom of the computer to the port replicator connector until it clicks.

Attaching computer to port replicator

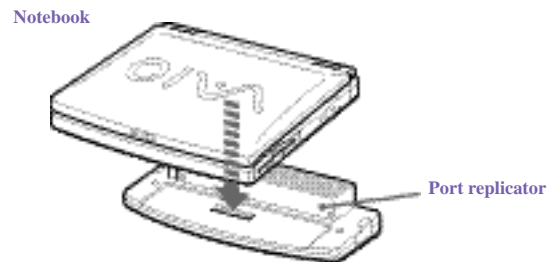

- 4 Plug the cable attached to the AC adapter into the DC IN connector on the port replicator. Plug the power cord into the AC adapter and an AC outlet.

Connecting AC adapter to port replicator

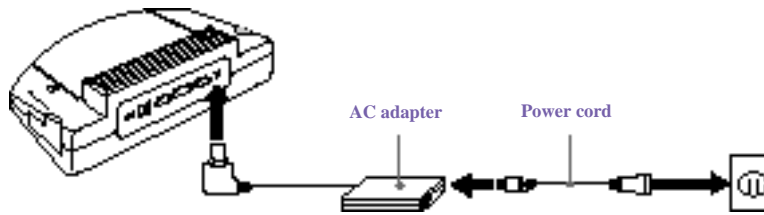

Use the AC adapter that comes with your computer or the optional Sony PCGA-AC19V1 adapter.

The power indicator light turns green.

Power indicator light

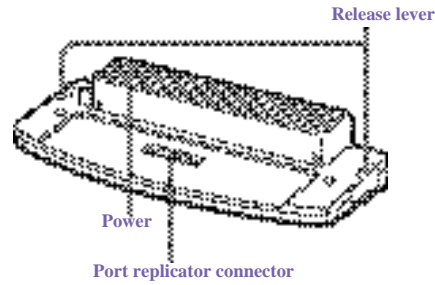

- 5 Turn on the computer.

To remove your computer from the port replicator when the power is off

- 1 Turn off your computer and the connected peripherals.
- 2 Pull the levers on each side of the port replicator to disengage the computer from the port replicator.

Disengaging computer from port replicator

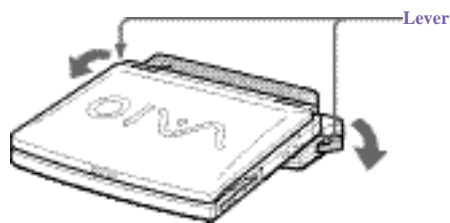

- 3 Lift the computer away from the port replicator.

Port replicator connector cover



- 4 Close the port replicator connector cover on the bottom of your computer.

 It is extremely important to close the port replicator connector cover after removing your computer from the port replicator. If the cover is left open, dirt may get inside and damage the computer.



Connecting an External Mouse or Keyboard

You can connect an external mouse or keyboard to the optional port replicator using a PS/2-style plug or adapter.

 Before you connect or disconnect the mouse or keyboard, turn off the computer.

You can only connect one external device at a time. Therefore, it is impossible to connect both a PS/2 mouse and PS/2 keyboard simultaneously.

To connect an external mouse or keyboard

- Locate the mouse/keyboard connector on the port replicator identified by the  /  symbols.
- Plug the mouse or the keyboard cable into this connector with the arrow facing up.

 See the manual that came with your mouse or keyboard for more information on its installation and use.

Connecting a Printer

You can connect a Windows Me/Windows 2000-compatible printer to your computer to print documents.

To connect a printer

- Locate the Printer connector identified by the  symbol. Plug the printer cable (supplied with the printer) into this port on the computer.

Printer connector

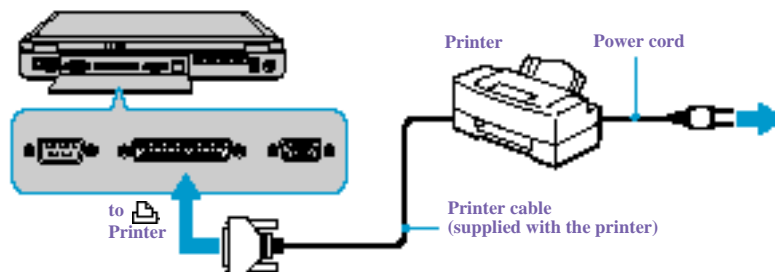

 See the manual that came with your printer for more information on installation and use.

If your printer stops functioning after resuming from a power-saving mode, see "Troubleshooting the printer" .

Before using the printer, you may need to change the Printer setting in the Sony Notebook Setup software. See "Displaying the Sony Notebook Setup Screen" .

Connecting an External Display

You can connect an external display to your notebook. For example, you can use the computer with any of the following:

- ❑ Computer display (monitor) (See “To connect a computer display”.)
- ❑ Multimedia computer display (See “To connect a multimedia computer display”.)
- ❑ Projector (See “To connect a projector”.)

 Connect an external display before you turn on the computer.

To connect a computer display

- ❑ Locate the Monitor connector identified by the  symbol on the back of the computer. Plug the display cable (not supplied) into this connector.
- ❑ If necessary, plug one end of the display power cord into the display, and the other end into an AC outlet.

Connecting an external computer display

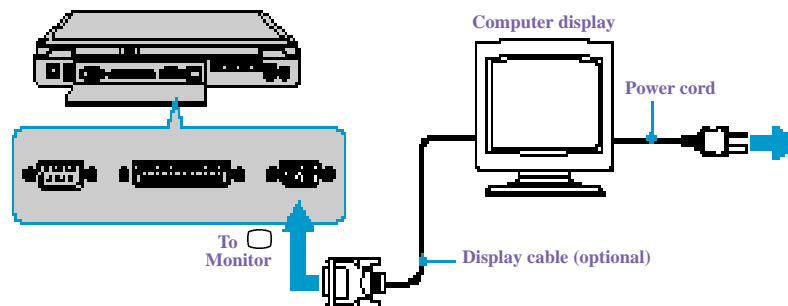

 See the manual that came with your computer display for more information on installation and use.

To connect a multimedia computer display

You can connect the notebook to a multimedia computer display that includes built-in speakers and a microphone.

- 1 Locate the Monitor connector identified by the □ symbol. Plug the display cable into this connector.
- 2 Locate the Headphone connector identified by the ♪ symbol. Plug the speaker cable into this connector.
- 3 Locate the Microphone connector identified by the 🎤 symbol. Plug the microphone cable into this connector.

📖 See the manual that came with your multimedia computer display for more information on installation and use.

To connect a projector

You can use a projector, such as the Sony LCD Projector, as an external display.

Connecting a projector

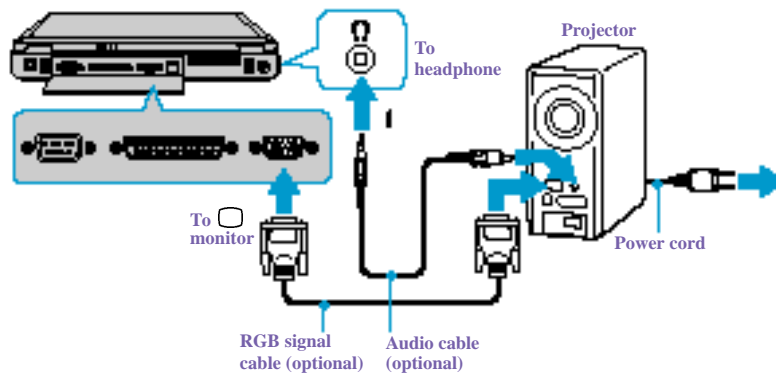

📖 See the manual that came with your projector for more information on its installation and use.

To select a display

When you connect an external display to the monitor connector, you can toggle the output between the Liquid Crystal Display (LCD), the external monitor, or both devices.

Use the Fn+F7 keys to select a display. See also “Selecting the Display Mode” for more information.

<i>To</i>	<i>Press</i>	<i>Result</i>
Switch to an external display	Fn+F7	Toggles between the LCD, the external display connected to the Monitor connector, or both the LCD and external display.

```
graph TD; A[Only LCD] --> B[LCD and external display]; B --> C[Only external display]; C --> A;
```

 Connect the cable before you turn on the computer, otherwise Fn + 7 will not work.

Connecting a TV Display (For Models with TV Out Only)

You can enjoy playing audio/video by connecting AV devices to your computer. See also the manuals supplied with your AV devices.

To Connect a TV

- Connect the computer to a TV using audio/video cables. Switch the input channel of the TV to external input. You also need to set up the TV configuration system.

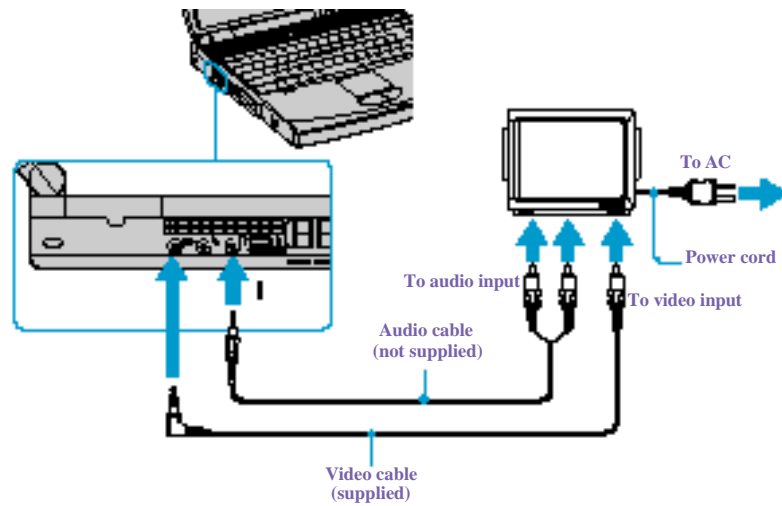

- ✎ See the manual that came with your peripheral device for more information on installation and use.
- ✎ If you insert a DVD in your DVD drive to watch a video on your TV, the Fn+F8 key combination might not activate the function to toggle between your LCD and TV. Take the following steps:
 1. Connect the TV to the Computer.
 2. Restart the computer and wait until it finishes.
 2. Toggle between your LCD and your TV with the Fn+F8 key combination.Your image is now displayed on both LCD and TV. Re-insert your DVD to launch your DVD software.
- ✎ A part of the image cannot be displayed on your TV display if the resolution of your computer is more than 800 x 600 dots. The hidden area on your TV display can be seen by moving the cursor on your computer. If you want to display the full image, change the resolution of your computer to 640 x 480.

Connecting a Universal Serial Bus (USB) Device

You can connect USB devices such as an external mouse, keyboard, speaker, and microphone to your computer.

To connect a USB device

 Before you connect or disconnect a mouse, turn off the computer.

The following steps describe the procedure for connecting a USB mouse to your computer. Use the same procedure for connecting all USB devices.

- Locate the USB device identified by the  symbol. Plug one end of the USB cable into this port and the other end into the USB device.

Connecting USB device to USB connector

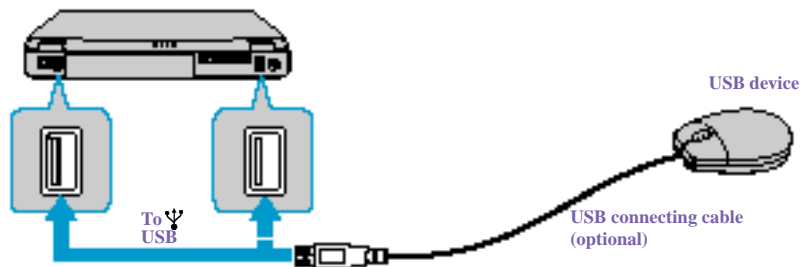

You can use an optional Sony USB mouse PCGA-UMS1 series (not supplied) with this computer. Since the USB mouse software driver is preinstalled in the computer, you simply plug the USB mouse into the USB connector to use it. One USB connector supports one USB device.

 See the manual that came with your USB device for more information on its installation and use.

Connecting an i.LINK® Device

You can connect an i.LINK-enabled digital video camera recorder to the i.LINK® S400 (IEEE1394) connector.

To connect a digital video camera recorder

- Plug one end of the i.LINK cable (not supplied) into the i.LINK connector on the left side of the computer and the other end into the DV In/Out connector on the digital video camera recorder.

 i.LINK cables compatible with your VAIO notebook include cables with the following part numbers: VMC-IL4415 (a 1.5-meter cable with a 4-pin connector at each end), VMC-IL4615 (a 1.5 meter-cable with a 4-pin connector at one end and a 6-pin connector at the other), and VMC-IL4408A (a 0.8-meter cable with a 4-pin connector at each end). You can purchase these cables from your local retailer, through the Sony VAIO® Direct Web site (<http://www.sonydirect.com>), or by calling 1-888-315-7669 (toll free).

Connecting digital video camera recorder to i.LINK connector

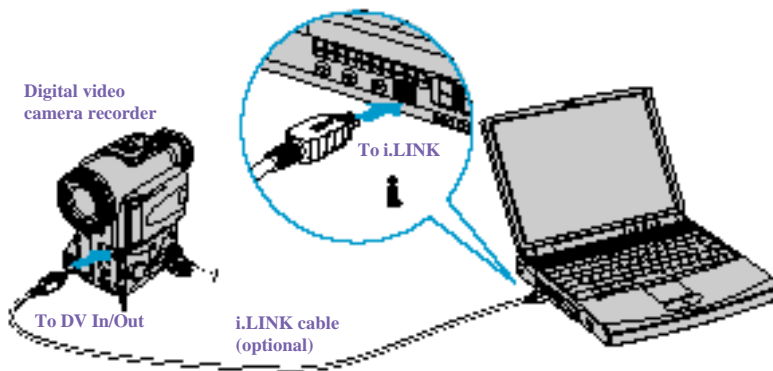

* i.LINK is a SONY trademark used to designate that a product contains an IEEE 1394 connector. All products with an i.LINK connector may not communicate with each other.

 The Sony digital video camera recorder is pictured; you may need to connect your camera differently.

On Sony digital video cameras, connectors labeled "DV In/Out" or "i.LINK" are i.LINK-compatible.

See the manual that came with your digital video camera recorder for more information on installation and use.

Do not connect more than one digital video camera at a time. The software supplied with your computer will not recognize multiple cameras.

The i.LINK connector on the computer does not supply power to external devices. If the external device requires power from the i.LINK connector, you cannot use the device with the computer.

The computer supports transfer rates up to 400 Mbps; however, the actual transfer rate is the lowest transfer rate of the external device.

The i.LINK features available may vary depending on the software applications you use. See the documentation that came with your software for more information.

Connecting External Speakers

You can enhance the sound quality of your computer by connecting external speakers.

 Make sure your speakers are designed for computer use.

Turn down the volume of the speakers before you turn them on.

Do not place diskettes on the speakers; the speakers' magnetic field may damage the data on the diskettes.

To connect external speakers

- Locate the Headphone connector identified by the Ω symbol on the side of the computer. Plug the speaker cable into this connector.

Connecting speakers to the headphone connector

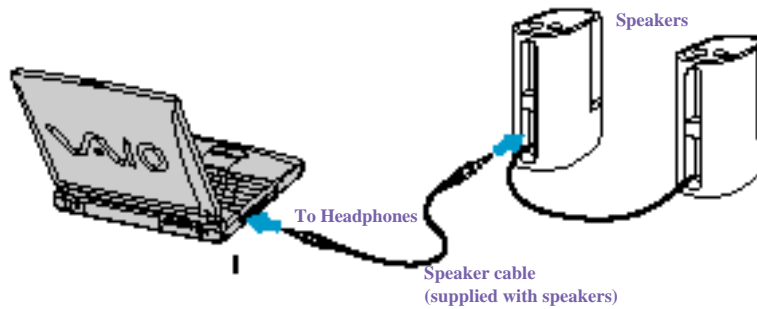

 See the manual that came with your speakers for more information on installation and use.

Connecting an External Microphone

You can enhance the quality of sound input by using an external microphone.

 Make sure your microphone is designed for computer use. The microphone should be compliant with the plug-in power microphone.

To connect an external microphone

- Locate the Microphone connector identified by the  symbol on the side of the computer. Plug the microphone cable into this connector.

Connecting microphone to microphone connector

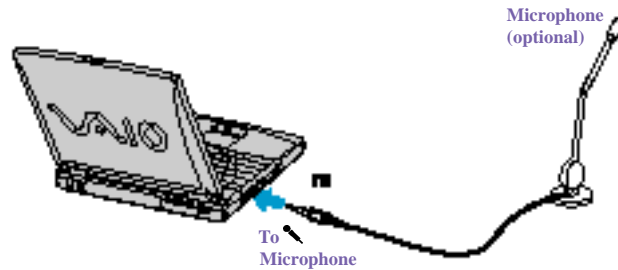

 See the manual that came with your microphone for more information on installation and use.

Customizing Your VAIO® Notebook

You can customize the settings of your notebook. The following sections briefly describe how to change your computer's default settings. You can also refer to Sony Notebook Setup Help for more detailed information.

Displaying the Sony Notebook Setup Screen

To display the Sony Notebook Setup screen:

- 1 Click the Start button on the Windows® taskbar.
- 2 Point to VAIO and click Sony Notebook Setup.

Sony Notebook Setup Screen



- 3 Select the tab for the item you want to change. See “Sony Notebook Setup Tabs”.
- 4 After you finish making your changes, click OK.

Sony Notebook Setup Tabs

<i>Tab</i>	<i>Description</i>
About This Computer	Display system information, including memory capacity, serial number, and BIOS version.
Printer	Select printer port mode settings.
Initial Setting	Change the volume of the sounds that play while the operating system is loading. Select the order of drives and devices from which you want to load the operating system. You can specify the hard drive as well as other drives inserted into your computer.
Touchpad	When you connect an optional mouse to your computer, you can make your touchpad inactive. You can also customize the settings of your mouse using the mouse utility.
Power On Password	Set the password to secure your computer.
Enable Ports	Enable or disable ports. Disabling ports releases resources to the system. To change the serial settings, click Advanced on the Basic/Advanced tab.
Basic/Advanced	Switch between Advanced mode (additional screens with advanced settings) and Basic mode of display.

 For more information about each option, click Help on the Sony Notebook Setup screen to display the Help file.

Controlling Power Management

The PowerPanel utility allows you to control the power management of your notebook computer and provides key information about system activity and battery life. The following sections briefly describe how to conserve your computer's battery power. You can also refer to PowerPanel Help for more detailed information. To activate a profile or command, see "Displaying Battery Information".

Viewing the Power Management status icons

The Power Management status icons are displayed in the task tray at the lower right side of your screen. Move the pointer over the icons to see the tool tip that displays information about the active profile. The Battery status icon indicates of battery power level and the CPU status icon indicates the performance level of the CPU.

To activate the Power Management Toolbar

- 1 Right-click on the taskbar at the bottom of the screen.
- 2 Select Toolbars from the pop-up menu, and then click Power Management. The Power Management toolbar appears on the taskbar.

The current profile icon is highlighted on the Power Management toolbar. It is the first icon farthest to the left, and its appearance changes depending on which power management profile is currently selected. To change the power management profile, click the current profile icon, and then select a profile from the pop-up list. See "Power Management Profiles" for a description of available options. To select another power management profile, click that icon in the Power Management toolbar.

 When you use the battery pack to power your notebook, your system selects the Maximum Battery Life power management profile by default. If you select a different power management profile while using battery power, that profile is selected automatically the next time you use the battery pack to power your notebook.

Refer to the PowerPanel Help for information on customizing the Power Management toolbars.



You can change the power management settings, such as the system timer and the brightness of the screen.









To customize power management settings

- 1 Click the Current Profile icon on the Power Management toolbar.
- 2 Select Edit/Create Profiles from the menu.
- 3 Click a profile whose setting you want to change from the list in the left field.
- 4 Double-click an item whose setting you want to change from the list in the right field.
- 5 Click the desired setting.
- 6 Click the File menu, and then click Save.
- 7 Click the File menu, and then click Exit.

Power Management Profiles



The PowerPanel utility provides several predefined power management profiles. Each profile consists of a group of power management settings that are designed to meet specific power management goals—ranging from maximum power management to no power management. You can change the settings for any of the predefined profiles (except for the Disable Power Management profile), or you can create your own profile to suit your portable computing needs. The predefined profiles are:

<i>Icon</i>	<i>Description</i>
	Maximum Performance Provides the best system performance while still conserving power.
	Maximum Battery Life Provides power saving features to give you maximum battery life and good performance. It slows the computer and puts it into Standby mode after a specified time period.
	Disable Power Management Turns off all power management features such as Standby and Hibernate modes. You can not change the settings of this profile.

<i>Icon</i>	<i>Description</i>
	AC Power The power management state when AC power is in use. Similar to the Power Management Off setting. Power Management automatically loads the AC profile unless you disable this feature.
	Games Disables the display and the Hard Disk Standby timer.
	Presentation Keeps the display on at all times while it conserves power. This option is ideal for slide show presentations. You can establish settings for LCD (Video) Standby, Hard Disk Standby, and Standby mode to optimize power management for your system.
	Camera Optimizes performance and power requirements for camera usage.
	DVD Optimizes performance and power requirements for DVD usage.
	Word Processing Optimizes power management with longer timeouts on the hard disk and display screen. You can also establish settings for LCD (Video) Standby, Hard Disk Standby, and Standby mode to optimize power management for your system.
	Spreadsheet Optimizes performance and power requirements for spreadsheet applications.
	Communications Extends battery life by initiating a quick display timeout. The Internal modem remains powered. You can also establish settings for LCD (Video) Standby, Hard Disk Standby, and Standby mode to optimize power management for your system.
	Automatic Profile Selection Automatically switches to a profile suitable for active applications.

Power Management Commands

PowerPanel also provides power management commands that you can use to activate specific power management functions and to control power for a specific device. You can use these commands to override a profile setting or initiate an immediate action.

<i>Icon</i>	<i>Description</i>
	Standby Puts the system into Standby mode, a power management state that saves the state of the system and peripheral devices in memory (RAM). Power consumption reduces to a minimum, and the system remains on. To return the system to the active state, press any key or the power button on your computer.
	Hibernate Provides for the lowest level of power consumption. The system writes the state of the system and peripheral devices to the hard disk and turns off the system power. To return the system to the original state, use the power button to turn on power. The system saves the data in the Save to Disk Partition on the hard drive.
	LCD (Video) Standby (Windows Me™ only) Turns off the video display to save power. If you turn off the Video Standby timer, the display remains active except when the system enters Standby mode. The video display system is one of the largest consumers of power in the system.

Conserving Battery Power

When using the notebook with a battery, the LCD display and the hard drive can be set to switch off automatically to conserve battery power.

For details, see “Power Management Profiles”.

Displaying Battery Information

You can display information for each of the batteries in your computer. The following sections briefly describe how to display your computer's general battery information. Refer to PowerPanel Help for more detailed information.

To activate the Battery Information toolbar

- 1 Right-click on the taskbar at the bottom of the screen.
- 2 Select Toolbars from the pop-up menu, then click Battery Information. The Battery Information toolbar appears on the taskbar.



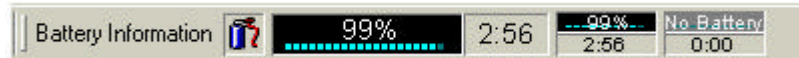

To view the total capacity remaining in the battery, place the pointer over the batter status icon in the task tray on the lower right side of the screen.

Battery Information Toolbar



- Percentage indicator** — Displays the percentage of the remaining capacity.
- Time indicator** — Displays estimated time (hours/minutes) remaining before the battery fully drains, also known as the time-to-empty.

Battery Icon Descriptions

Battery icon	Battery status
	Charging
	Fully charged
	Discharging
	No battery

Displaying Detailed Battery Information

Double-click the battery icon on the task tray to display the Battery Information window. The screen appears displaying the Battery tab, which contains information such as the estimated time-to-empty and charging time.

Battery Information Window

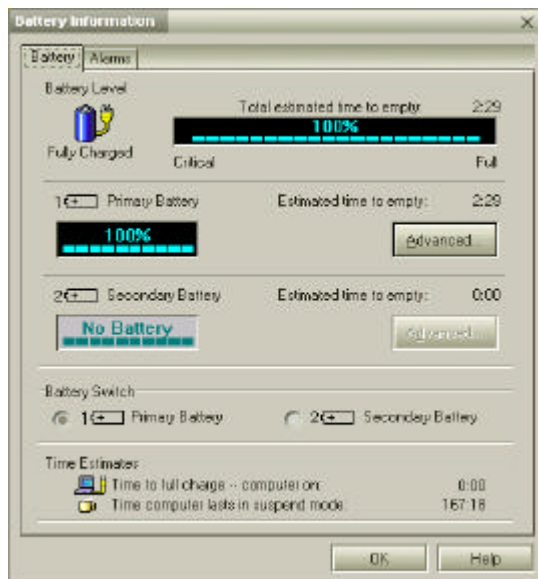

Customizing the Battery Information toolbar and alarm system

You can customize the Battery Information toolbar and modify the alarm settings, to suit your portable computing needs. Refer to PowerPanel Help for more information.

Selecting the Display Mode

This notebook uses the Intel® video controller, which enables you to select the desired display when the notebook is connected to an external monitor. When you connect an external display, you can switch the display mode between your notebook's LCD display and the external monitor.

To select the display mode, proceed as follows: (See also “Connecting an External Display” .)

 Connect an external display before you turn on the computer.

- 1 Click the Start button, point to Settings, then point to Control Panel.
- 2 Click Display, to access the Display Properties window.
- 3 Click the Settings tab, then click the Advanced button, to display the Intel® 82815 Graphics Controller Properties dialog box.

Intel® 82815 Graphics Controller Properties Screen

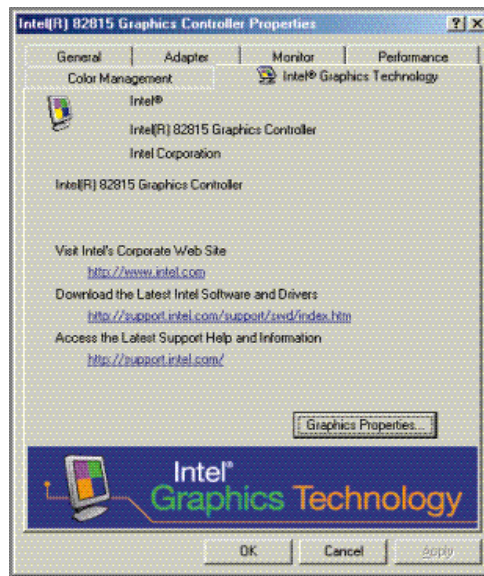

- 4 Click the Intel® 82815 Graphics Technology tab, then click the Graphics Properties button. (For models with TV Out) Continue on to step 7.
- 5 Click the Driver Configuration tab.
- 6 Ensure that the Synchronous Display Mode box is selected, then click Apply.

For Models with TV Out Only

If you want to use the TV as a display, deselect the Synchronous Display Mode box, then click Apply. You cannot use the TV and another display simultaneously.

- 7 Click the Device tab.
- 8 Select the type of display.

 You may not be able to display the notebook LCD screen and an external display or projector at the same time, depending on the types of computer displays and projectors you are using.

If the display resolution of your computer is more than 800 x 600 dots, a part of the image will not show up on your TV display. To see the hidden area, move the cursor on your computer. To display the full image, change the display resolution settings to 640 x 480 dots.

Turn on the computer after you turn on the peripheral devices.

Changing the Window Design of Sony Software

To change the window design

- 1 Click the Start button, point to Settings, then point to Control Panel.
- 2 Click UI Design Selector.
- 3 Click << or >> and select the desired design.
- 4 Click Apply.
- 5 The “UI Design Selector” window design changes. The window design for your Sony software will match the “UI Design Selector” window.
- 6 To try another selection, click << or >> then click OK.

- 7 The UI Design Selector closes and the Sony software window design displays.

 This feature is available with UI Design Selector-compatible software only.

Adding Memory

In the future you may want to install memory modules to expand the functionality of your computer. You can increase memory up to 512 MB (256 MB x 2), by installing optional memory modules. For selected models 128 MB of memory is pre-installed (128 MB x 1); for other models, 64 MB of memory is pre-installed (64 MB x 1). You can add an expansion memory module (64 MB, 128 MB, or 256 MB) in the memory module bay. Expansion memory modules are available as options. For memory upgrades, use only PC100 (CL2) SDRAM SO-DIMM (gold lead contacts).

! Make sure you observe the proper safety precautions when you install memory modules in your computer. See the bulleted list below. Be careful when adding memory. Mistakes when installing or removing a memory module may cause a malfunction.

Before you start

- ❑ The procedures described below assume you are familiar with the general terminology associated with personal computers and with common safety practices required for using and modifying electronic equipment.
- ❑ Disconnect your system from its power source and from any telecommunications links, networks, or modems before you open the system or follow any of the procedures described below. Personal injury or equipment damage may result from failure to take these precautions.
- ❑ Electrostatic discharge (ESD) can damage memory modules and other components. Perform the procedures described below only at an ESD workstation. If such a station is not available, do not work in a carpeted area, and do not handle materials that produce or hold static electricity (cellophane wrappers, for example). Ground yourself by maintaining contact with an unpainted metal portion of the chassis while performing the procedure.
- ❑ Do not open the memory module package until you are ready to install the module. The package protects the module from ESD.

- ❑ Use the special bag for preventing ESD or use aluminum foil when you store the memory module.

For Models with 64 MB Memory

Typical expansion memory configuration

<i>Total System Memory (MB)</i>	<i>Slot 1 (MB)</i>	<i>Slot 2 (MB)</i>
128	64	64
192	64	128
256	128	128
512	256	256

For Models with 128 MB Memory

Typical expansion memory configuration

<i>Total System Memory (MB)</i>	<i>Slot 1 (MB)</i>	<i>Slot 2 (MB)</i>
128	128	
192	128	64
256	128	128
512	256	256

To remove a memory module

- 1 Shut down your computer and disconnect all peripheral devices, such as your printer.
- 2 Unplug the computer and remove the battery pack(s).

- 3 After the computer has cooled, loosen and remove the screw that secures the cover of the memory bay on the bottom of your computer. Use an appropriate screwdriver.

Removing the memory module cover

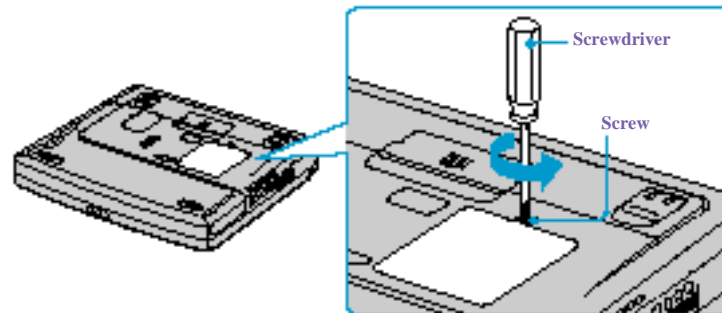

- 4 Touch a metal object (such as the connector panel on the back of your computer) to discharge any static electricity.
- 5 Remove the memory module.

Removing memory module

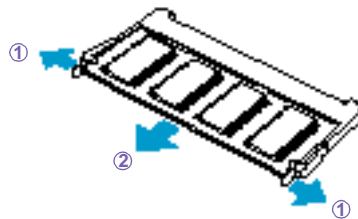

① Pull the tabs in the direction of the arrows. The memory module is released.

② Pull the memory module in the direction of the arrow.

- 6 Tighten the screw on the memory bay cover.

 Your computer comes with a memory module installed in the memory slot. To upgrade your memory, remove this module from the slot before installing your upgrade memory module.

To install a memory module

- 1 Follow steps 1 to 4 of “To remove a memory module.”
- 2 Remove the memory module from its packaging.
- 3 Install the memory module.

Installing memory module

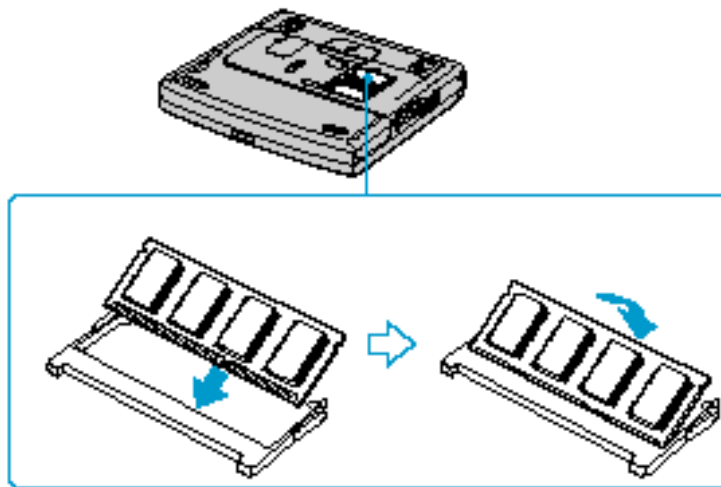

1 Slide the memory module into the slot.

2 Press the module into place until it clicks.

- 4 Tighten the screw on the cover of the memory bay.

To view the amount of memory

- 1 Restart the computer.
- 2 Click the Start button on the Windows status bar, point to VAIO option, and click “Sony Notebook Setup.”
The Sony Notebook Setup screen appears.
- 3 Click the “About This Computer” tab to view the amount of system memory.
If the additional memory is not shown, repeat steps 1 through 4 in “To install a memory module.”

About the Software on Your Notebook

Your VAIO notebook is ready to help you work, play, learn, and communicate as soon as you turn it on. This section gives you the following:

- ❑ An overview of the various software that come with your computer and the activities you can perform with your software
- ❑ Software support information
- ❑ Details on your Sony application and system recovery CDs

Overview

Adaptec Easy CD Creator™ and DirectCD™ (on select models only)

Adaptec, Inc.

Adaptec Easy CD Creator makes it easier than ever to create music, photo, video, and data CDs. It enables you to access music on the Internet, fine-tune your music tracks, edit and enhance photos and videos with a pro's touch. Save and share data with confidence. With DirectCD, CD recording has become as easy as using a disk drive or floppy disk. You can save files directly from your application software directly to your CD-R disc; you can drag and drop files, rename files, delete files, and create new directories right on the CD-R.

Adobe Acrobat Reader®

Adobe Systems Inc.

Acrobat Reader software allows you to view, navigate, and print electronic documents in Adobe Portable Document Format (PDF), an open file format that is intended to preserve the fidelity of documents created on all major computer platforms.

Adobe PhotoDeluxe® Home Edition

Adobe Systems Inc.

Create amazing photo effects with Adobe PhotoDeluxe. Without learning complex software, you can enhance, restore, and be creative with your photos. Includes built-in guided activities, stock photos, clip art and templates to assist you.

Adobe Premiere® LE

Adobe Systems Incorporated

Adobe Premiere LE offers an interface and editing tool for producing movies for video, multimedia, or the Web. View source clips and edited footage simultaneously on the monitor window. Create video clips up to three hours long with complete audio-video synchronization.

America Online® (Windows Me only)

America Online

America Online is a popular Internet online service. Stay in touch with family and friends with easy-to-use e-mail, manage your personal finances, get the latest news and sports scores, and chat with thousands of others who share your interests.

ArcSoft® PhotoPrinter™ 2000 Pro

ArcSoft, Inc.

ArcSoft PhotoPrinter 2000 is an easy-to-use, advanced printing program that lets you quickly lay out multiple images in multiple sizes on a single sheet of paper. PhotoPrinter Pro offers a wide selection of templates including landscape, portrait, free style, mixed sizes, custom templates and more. The application includes enhancement tools and special effects for improving photos while giving you the ability to add text to any image.

CompuServe® 2000 (Windows Me only)

CompuServe, Inc.

CompuServe is the most comprehensive source of organized business and educational information online today. CompuServe allows you to access the vastness of the Internet, without wasting time wading through it. Maximize your time online with CompuServe.

DVgate™

Sony Electronics

Connect a digital video camera recorder to the i.LINK® connector and capture your own video clips and still images. You can edit clips from your video, add others, and combine clips into new movie segments. You can also save your images in a variety of popular file formats.

* i.LINK is a SONY trademark used to designate that a product contains an IEEE 1394 connector. All products with an i.LINK connector may not communicate with each other.

EarthLink Network TotalAccess® (Windows Me only)

EarthLink Network, Inc.

An Internet Service Provider that supplies access, information, and assistance to its customers, introducing them to the Internet. Member benefits include e-mail, newsgroups, a personal start page, a free 6 MB web site, a member newsletter, and 24-hour technical support.

McAfee® VirusScan®

Network Associates, Inc.

Protect your computer from viruses. VirusScan can detect viruses from floppy disks, Internet downloads, e-mail attachments, intranets, shared files, CD-ROMs, and online services.

Media Bar™

Sony Electronics

Media Bar software is your all-in-one solution for audio/video playback. Media Bar software handles all common computer multimedia formats and controls selected Sony devices. In addition to audio/video library cataloging and playlist management, Media Bar software includes digital video quality control and effects features. Media Bar software seamlessly integrates a variety of new media formats with an easy-to-use software interface.

Microsoft® Internet Explorer

Microsoft Corporation

Internet Explorer delivers the web the way you want it. It is safe, easy to use, and you can personalize how you access the web. Outlook Express and other tools in Internet Explorer also help you have a great experience when you are on the web.

Microsoft® Word 2000

Microsoft Corporation

Microsoft Word 2000 makes it easy to create shared Web, e-mail, and print documents for use around the world. It embraces HTML as a first-class file format and extends Word's ease-of-use to the Web and e-mail. Word 2000 also extends that ease-of-use to international users, making it simple to create multilingual documents.

MovieShaker™

Sony Electronics

Sony's original MovieShaker software creates personal movies that have transitions, background music and text. Just import your video clips and "shake" with a click of the mouse. Your personal movies are easy to create and fun to share with family and friends. (See "MovieShaker™" below.)

Netscape Communicator®

Netscape Communications

Netscape Communicator is an all-in-one Internet tool that makes it easy to browse the web, send Internet e-mail, chat, read newsgroups, and compose great web documents.

PictureGear™

Sony Electronics

This image management software displays images from your hard drive, a Sony digital still camera, or a Sony Mavica® camera. The images appear in a convenient light-table format, so that you can easily view the contents of an entire folder. (See “PictureGear™” below.)

Prodigy Internet® (Windows Me only)

Prodigy Communications Corporation

An online service that helps you find what you need online faster and smarter. Prodigy delivers powerful online content such as sports scores, stock quotes, news, and easy access to Excite, plus quality customer service, all at a competitive price.

Quicken® 2001

Intuit, Inc.

Quicken is a fast, easy way to organize your finances. Quicken works just like your checkbook, so it is easy to learn and use. Quicken manages all your finances, bank accounts, credit cards, investments, and loans. You can even pay your bills online.

Smart Capture

Sony Electronics

Smart Capture is a fun new way to send multimedia messages via e-mail. Smart Capture manages the i.LINK® connection between your computer and a Sony Digital Handycam® Camcorder that supports the i.LINK interface. It allows you to capture compressed video or still images that you can save or share via e-mail. A smart solution to computer, digital audio/video and network convergence.

Smart Connect (Windows 2000 only)

Sony Electronics

Smart Connect allows you to use an i.LINK cable to connect your VAIO computer to another VAIO computer that supports Smart Connect. You can then use one computer to copy, delete, and edit files on the other computer. You can also print from a printer attached to either computer.

Sound Forge® XP

Sonic Foundry

Sound Forge XP allows you to put powerful audio processing tools and effects to work on your notebook. Simply cut, copy, and paste your way to striking multimedia files for use in everything from Web pages to desktop presentations.

WinDVD

InterVideo, Inc.

WinDVD is a simple-to-use DVD player combining all the features you would expect to find in a standard consumer DVD player, in addition to some very advanced functionality, such as full VCD 2.0 support, full precision video decode, a choice of user interfaces, and video display options. You can play DVD titles or Video CDs. WinDVD automatically determines the type of disc in the DVD drive and uses the correct playback method.



MovieShaker™

This application can be used to create fun and innovative movies without any knowledge of film editing. In a few simple steps, motion pictures can be combined with special effects, still images (pictures), and music files and then saved in a format most computers can play.

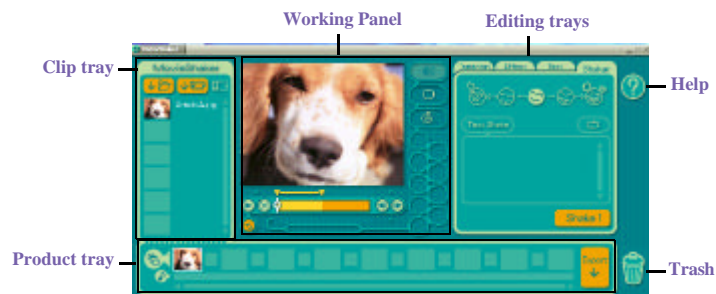
Main Window



Importing Images and Sound Clips

- 1 Click  (File Import) or  (DV Import).
- 2 Find the file you want to add.
- 3 Select the file.

- 4 Click Open. The file is added to the Clip tray.

 Importing files over 75 seconds in length may cause MovieShaker to stop responding.

Create a Movie using Shaker

After adding clip(s) to the Clip tray, you can create a short movie using the Shaker feature. Shaker randomly select clips from the Clip tray to create a 30-second scene.

- 1 Click the Shake tab.
- 2 Select a mood by clicking a face in the Shaker tray.

Shaker Tray



- 3 Click **Shake !**. A thirty second scene is automatically generated and saved to the Product tray.
- 4 To preview, switch the Work Panel to Product tray mode and press play.

 Scenes created with Shaker begin with black frame and after processing are placed in the first available slot on the Product tray. Limit the number of scenes placed on the Product tray to 10 or less. MovieShaker may stop responding if too many scenes are placed on the Product tray.

Editing Clips and Scenes

You can edit your movie by adding effects and text, adjusting the color and contrast, and modifying the length of clips.

Working Panel

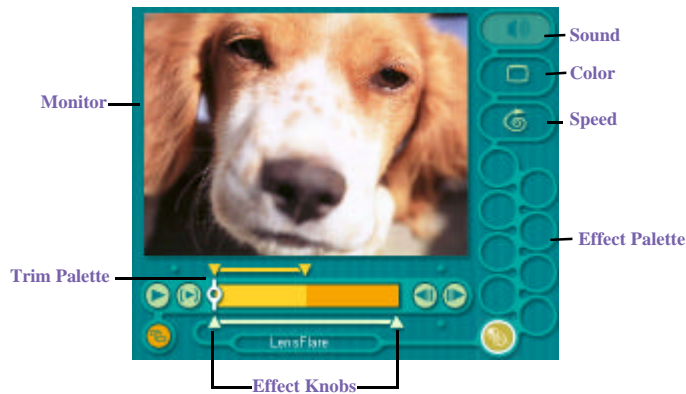

Adding effects to a scene or a clip:

- 1 Double-click the clip or scene to move it to the Working Panel.
- 2 Select the Effects tab from the Editing tray.
- 3 Drag and drop the Effect you want to add from the Effects tray to the Effects palette on the Working Panel.

 To preview an Effect, click on the clip in the Working panel monitor. Your clip displays with the new effect on the Effect tray monitor.

- 4 See help for instructions on adjusting effect duration and replaying clips/scenes.

Saving a Movie

- 1 Verify that the clip(s) you want to save is on the Product tray. See Help for more details on saving movies.
- 2 Click Export.

- 3 Select the format in which you want the document to be saved.
- 4 Click Next.
- 5 Locate the folder to which you want the file saved.
- 6 Name the file.
- 7 Click Save.

! Exporting movies may take a long time to complete—Save movie as DV (Digital Video) takes the longest and Quick-Save is the fastest. MovieShaker can play video files up to 65 MB in length.

 For DV playback and smooth video playback, we recommend the following resolution/refresh rates: 1024 x 768/75 Hz or lower.

PictureGear™

PictureGear is a digital image management application that allows you to see all the images stored in any directory on your computer. Thumbnail views provide quick reminders of your pictures. Brighten, contrast, enhance, resize, crop, and color-correct your pictures. Create panoramic views, animations, screen savers, wallpaper, still pictures from MPEG, and even html photo albums.

Managing Your Pictures

Use the collection feature to manage your pictures.

- 1 Click the Folder tab and browse to locate your pictures.
- 2 Select the pictures you want to have in a collection.
- 3 From Collection menu, select Create New Collection.
- 4 Enter a name for the collection and then click okay.

Creating a Photo Album

- 1 Select the pictures you want to use to make an album.
- 2 From the Utilities menu, select Album Maker.
- 3 Choose the type of Album you want and click Okay.

- 4 Now add more pictures, frames, text, and effects.
- 5 When you are finished, select Create Album in File menu or click the Create Album icon on the toolbar.
- 6 Designate the folder you where want to save the Album.
- 7 Enter the Target Album name, select Thumbnails and click Okay.
- 8 The new album can be viewed using most internet browsers.

Using Panorama Maker

Panorama Maker stitches a group of still images into a 360 degree panoramic picture. The source images should be the same size and overlap 20%.

How to stitch a panoramic picture:

- 1 Gather the source images into the same folder or collection.
- 2 Select the images you want to use.

 We recommend 12 landscaped or 16 portrait pictures.

- 3 From the Utilities menu select Panorama Maker.
- 4 Select the correct lens and click Okay. (If 35mm lens is selected the prompt, does not appear; to select a different lens, click the lens icon.)
- 5 Click the panoramic icon, near the bottom of the window.
- 6 Click Full Stitch.

Making Still Images and Panoramic from MPEG

- 1 Select the MPEG file.
- 2 From the Movie/Sound menu, select Scene break down.
- 3 Then select Movie Stitch, to create a panoramic picture.

Software Support Information

Adaptec, Inc.

Web site	http://www.adaptec.com/
phone	408-945-8600
fax	408-262-2533

Acrobat® Reader, Adobe PhotoDeluxe® Business Edition, Adobe Premiere® LE (Adobe Systems Incorporated)

Web site	http://www.adobe.com/
phone	206-675-6126 (fee-based support)
e-mail	techdocs@adobe.com
hours	M-F, 6 AM-5 PM PT

America Online® (America Online)

Web site	http://www.aol.com
phone	800-827-3338
hours	7 days a week, 24 hours a day

CompuServe® 2000 (CompuServe, Inc.)

Web site	http://www.compuserve.com
phone	800-848-8990

EarthLink Network TotalAccess® (EarthLink Network, Inc.)

Web site	http://help.earthlink.net/techsupport/
phone	800-395-8410
e-mail	support@earthlink.net
hours	7 days a week, 24 hours a day

McAfee® VirusScan® (Network Associates, Inc.)

Web site	http://support.mcafee.com
phone	408-988-3832
e-mail	cybr@nai.com
hours	M-F 9AM-5PM Central Time

Netscape Communicator® (Netscape Communications Corporation)

Web site	http://www.netscape.com/
phone	888-4SONYPC (888-476-6972)*
hours	7 days a week, 24 hours a day

PhotoPrinter™ 2000 Pro (ArcSoft, Inc.)

Web site(s)	http://www.arcsoft.com http://www.photoisland.com
phone	510-440-9901
fax	510-440-1270
e-mail	techsupport@arcsoft.com
hours	M-F, 8:30 AM-5:30 PM PT

Prodigy Internet® (Prodigy Communications Corporation)

Web site	http://www.prodigy.com
phone	800-213-0992
hours	7 AM - 3 AM ET

Quicken® 2001 (Intuit Inc.)

Web site	http://www.intuit.com/support
phone	900-555-4688
hours	7 days a week, 24 hours a day

Windows Operating System, Internet Explorer (Microsoft Corporation)

Web site	http://www.microsoft.com/support/
phone	888-4SONYPC (888-476-6972)*
hours	7 days a week, 24 hours a day

WinDVD

Web site	http://www.intervideo.com
phone	510-651-0888

* Support from 1-888-4SONYPC is free of charge for 90 days after the original date of purchase.

Sony Service Center

For the Sony Service Center nearest you, call 1-888-4SONYPC (1-888-476-6972) or find Sony Customer Service on the Web at <http://www.sony.com/pcsupport>.

Application, System, and Driver Recovery CDs

Your computer comes with the following application and system recovery CDs. (To use your recovery CDs, see “Using Your Recovery CDs” .)

Application Recovery CD(s)

Sony Electronics

This program allows you to reinstall individual applications and device drivers. Use it to restore corrupted or accidentally erased files.

System Recovery CD(s)

Sony Electronics

This program allows you to restore the software titles that shipped with your computer if they become corrupted or are erased accidentally. It can be used only to restore the hard disk of this Sony computer.

Driver Recovery CD(s)

Sony Electronics

This program allows you to reinstall individual device drivers. Use it to restore corrupted or accidentally erased files.

Using Your Recovery CDs

The following sections describe how to use the Application Recovery and System Recovery utilities.

Using the Application Recovery CD(s)

The Application Recovery CD(s) allows you to reinstall individual applications if they become corrupted or are accidentally erased. Reinstalling an individual software title may correct a problem you are experiencing with your computer or software application; you may not need to reinstall the entire contents of your hard drive. If you need to reinstall all the software titles that shipped with your computer, use the System Recovery CD(s). See “Using the System Recovery CD(s)” .

You can also use the Application Recovery CD to install Windows 2000 drivers on your computer.

 You must be in Windows to run the Application Recovery CD. If you have any questions on using the Application Recovery CD, contact Sony Customer Support.

To use the Application Recovery CD(s)

- 1 Turn on your computer. If your computer is already on, close all applications.
- 2 When the Windows desktop appears, insert the Sony Application Recovery CD in the optical drive. The Application Recovery utility loads automatically.
- 3 When the Application Recovery menu appears, select the icon for the application you want to restore and then follow the on-screen instructions to complete the recovery process.

 Your system may include one or two Application Recovery CDs. If you have two Application Recovery CDs, insert the first CD to run the Application Recovery program. You may be prompted to insert the second CD, depending on the application you wish to restore.

Using the System Recovery CD(s)

You can reinstall software titles that shipped with your computer if they are corrupted or erased. You may not need to recover the entire contents of your hard drive. If you experience a problem with your computer, reinstalling an individual device driver or software title may correct the problem. Use the Application Recovery CD(s) to reinstall individual applications or device drivers. See “Using the Application Recovery CD(s)” .

The System Recovery CD contains a backup copy of all the software originally installed on your hard disk drive. **It can be used only to recover the hard disk of the notebook you purchased.**

The System Recovery utility gives you Full Restore with Format, that is it formats the hard disk drive then restores all the original software.

! Full Restore with Format removes all the information on the hard disk drive. You will lose any software you have installed and any other files you have created since you started to use your computer. This means you will have to reinstall any applications that were not included with the computer when you purchased it. If you have any questions on using the System Recovery CD, contact Sony Customer Support.

To use the System Recovery CD(s)

- 1** Insert the Sony System Recovery CD in the optical drive.
- 2** Shut down your computer as described in “Shutting Down Your Computer” .
- 3** Wait four seconds and turn on your computer.
- 4** Click OK to signify you have read and accept the Microsoft End-User License Agreement.
- 5** When the System Recovery menu appears, follow the on-screen instructions to complete the recovery process.

If your computer does not start from the Recovery CD

- 1** Press the power button and hold it for more than four seconds to turn off the computer.
- 2** Turn on the computer. When the Sony logo is displayed, press the F2 key. The BIOS setup menu screen appears.

- 3 Press the arrow keys to select the Exit menu.
- 4 Press the arrow keys to select “Get Default Values” and then press the Enter key. The message “Load default configuration now?” appears.
- 5 Check that “Yes” is selected, then press the Enter key.
- 6 Press the arrow keys to select “Exit” (Save Changes) and then press the Enter key. The message “Save configuration changes and exit now?” appears.
- 7 Check that “Yes” is selected, then press the Enter key. The computer restarts from the Recovery CD.

 Your system may include one or two System Recovery CDs. If you have two System Recovery CDs, insert the first CD to run the System Recovery program. You are prompted to insert the second CD once the information from the first CD has been installed.

The recovery process takes from 30 to 60 minutes to complete.

After recovering your system using the SRC, you may be prompted to insert your ARCD after restarting Windows. Insert the ARCD to automatically complete recovery of your system.

Using the Driver Recovery CD(s)

The Driver Recovery CD utility allows you to reinstall individual drivers and repair software applications if they become corrupted or are accidentally erased. You can reinstall an individual driver to correct a problem that you are experiencing with your computer, hardware, or software application. VAIO Support Agent uses a vault feature on the Driver Recovery CD(s) to repair software applications.

 You must be in Windows to run the Driver Recovery CD utility.

To use the Driver Recovery CD(s)

- 1 Turn on your computer. If your computer is already on, close all applications.
- 2 When the Windows desktop appears, insert the Driver Recovery CD in the optical drive. The Driver Recovery utility loads automatically.

- 3 When the Driver Recovery menu appears, follow the on-screen instructions to complete the recovery process.

To repair software applications using VAIO Support Agent

The Driver Recovery CD utility has an information vault that contains the original characteristics for the preinstalled software applications that are protected by VAIO Support Agent.

Troubleshooting

This section describes how to solve common problems you may encounter when using your notebook. Many problems have simple solutions, so try these suggestions before you contact Sony PC Support (<http://www.sony.com/pcsupport>).

Troubleshooting your notebook

(Windows Me only) When starting your notebook for the first time, the VAIO InitManager dialog box will appear. Please select “OK” to begin initial setup. If you do not execute the initial setup, you cannot use part of VAIO original hardware functions such as Power Management tool, scroll function of touchpad, and keyboard shortcut key function combined with the Fn key.

My notebook does not start

- Check that the notebook is plugged into a power source and that it is turned on. Check that the power indicator on the front panel of the notebook indicates that the power is on.
- Check that the battery packs are inserted properly and that they are charged.
- Make sure there is no diskette in the floppy disk drive.
- Confirm that the power cord and all cables are connected firmly, as described in “Connecting a Power Source” .
- If you plugged the notebook into a power strip or UPS, make sure the power strip or UPS is turned on and working.
- If you are using an external display, check that it is plugged into a power source and turned on. Check that the brightness and contrast controls are adjusted correctly. See the manual that came with your display for details.
- Moisture condensation may have occurred. Do not use the notebook for at least one hour and then turn on the notebook.
- Take the battery pack off the notebook, unplug the power cord and plug it again, then turn on the power.

My notebook starts, but my system doesn't start properly

- When the internal backup battery is low on power, it may not start your system properly. The message “Press <F1> to resume, <F2> to setup” appears at the bottom of the screen. Follow these steps:
 - 1 Press F2. The BIOS Setup menu appears.
 - 2 Set the date (month/day/year). Press Enter.
 - 3 Press ↓ to select System Time, then set the time (hour: minute: second). Press Enter.
 - 4 Press → to select Exit, then press ↓ to select Get Default Values. The message “Load default configuration now?” appears.
 - 5 Select Yes and press Enter.
 - 6 Select Exit (Save Changes), and then press Enter. The message “Save Configuration changes and exit now?” appears.
 - 7 Select Yes, and then press Enter. The notebook restarts.

My notebook starts, but the message “Operating system not found” appears and Windows does not start

- Make sure there is no diskette in the floppy disk drive (non-bootable).
- If a non-bootable diskette is in the drive, follow these steps:
 - 1 Turn off the notebook, and then remove the diskette.
 - 2 Restart the notebook and confirm that Windows starts properly.
- If Windows still does not start, follow the steps below to initialize the BIOS:
 - 1 Remove any diskette from the floppy disk drive.
 - 2 Turn off the notebook.
 - 3 Remove any peripheral devices connected to the notebook.
 - 4 Turn the notebook back on.
 - 5 Press the F2 key when the Sony logo appears. The BIOS setup menu screen appears.
 - 6 Press the directional arrow keys to select the Exit menu.

- 7 Press the arrow keys to select “Get Default Values” and then press Enter. The message “Load default configuration now?” appears.
- 8 Select Yes, then press Enter.
- 9 Use the directional arrow keys to select “Exit” (Save Changes), and then press Enter. The message “Save configuration changes and exit now?” appears.
- 10 Select Yes, then press Enter. The notebook restarts.

If your notebook continues to display the message “Operating system not found”, and Windows does not start, contact Sony Customer Support.

My notebook stops responding or does not shut down

It is best to shut down your notebook using the Shut Down command on the Windows Start menu. Using other methods, including those listed here, may result in loss of unsaved data.

- ❑ Try restarting the notebook. On the Windows taskbar, click the Start button, click Shut Down, and then click Restart.
- ❑ (Windows Me) If you cannot restart as described in the preceding step, you can restart the notebook by pressing Ctrl+Alt+Delete (at the same time) twice.
(Windows 2000) If you cannot restart as described in the preceding step, you can restart the notebook by pressing Ctrl+Alt+Delete (at the same time) and clicking Shut Down on the Windows Security screen.
- ❑ If the previous step does not work, press and hold the power button for at least four seconds. This turns off the power.
- ❑ (Windows Me) If your notebook stops responding while playing a CD or DVD, stop the CD/DVD, and restart the notebook by pressing Ctrl+Alt+Delete (at the same time) twice.
(Windows 2000) If your notebook stops responding while playing a CD or DVD, stop the CD/DVD, and restart the notebook by pressing Ctrl+Alt+Delete (at the same time) and clicking Shut Down on the Windows Security screen.
- ❑ Unplug the notebook from the AC adapter and remove the battery pack from your notebook.

 Pressing Ctrl+Alt+Delete (at the same time) or turning off the notebook with the power switch may result in data loss in files that are currently open.

My notebook does not enter the power saving mode I selected. (Windows Me only)

- Click Start, point to Program, point to Accessories, point to System Tools, and then click System Information.
The Help and Support window appears.
- Click System Configuration Utility under the Tools menu.
- Click the Advanced button on the General tab, and Confirm the following information:
 - 1 Enable Deep Sleep is selected with a checkmark.
 - 2 The message “Standby function is enabled” is displayed. If the message reads “Standby function is disabled”, click the Enable button.
 - 3 The message “Hibernate feature is enabled” is displayed. If the message reads “Hibernate feature is disabled”, click the Enable button.
 - 4 Click OK and restart your notebook.

My system enters System Idle mode when System Suspend mode has been selected

If you are connecting an optical disc drive with a PC card, disconnect it by stopping the PC card. See “To remove a PC card”. Make sure the PC card is compatible with your notebook’s Windows® operating system.

 (Windows 2000 only) When the notebook returns from a power saving mode after removing the optical drive, the message “Unsafe Removal of Device” may appear and the device name may be displayed as “Secondary IDE Channel”. Click OK.

The Power Management setting is not responding

Your notebook’s operating system may become unstable if a lower power state, such as system hibernate is initiated and then changed before the notebook completely enters the lower power state. To restore the notebook to its normal operating stability:

- Close all open applications.

- ❑ Push and hold the power button for four seconds or longer to shut down the notebook.

The sound of my notebook's fan is too loud

Use the PowerPanel utility to change the Thermal Control Strategy setting to Quiet. This setting slows down the CPU speed. See PowerPanel Help for more information.

Troubleshooting the LCD screen

My LCD screen is blank

- ❑ Check that the notebook is plugged into a power source and that it is turned on.
- ❑ Check that the power indicator on the notebook is on.
- ❑ Check that the battery pack(s) is inserted properly and that they are charged.
- ❑ The notebook may be in LCD (Video) Standby mode. Press any key to activate the screen.
- ❑ The display mode may be set to external display mode. Press and hold the Fn key while pressing F7 several times.

My LCD screen continues to show the previous screen.

Press the Windows key and D key twice to refresh the screen.

The image on my connected external display is not centered or sized properly

Use the controls on your external display to adjust the image. See the manual that came with your display for more information.

I want to change the video resolution of my display

You can use independent controls to change the video resolution of your display.

- ❑ Click Start, point to Settings, point to Control Panel, and then click the Display icon.
The Display Properties dialog box appears.
- ❑ Click on the Settings tab.
- ❑ Move the Screen Area slider to change your video resolution.

*I cannot switch the LCD display to TV and vice versa.
(For models with TV Out only)*

Remove the DVD video disc if it is inserted in the DVD-ROM drive.

Troubleshooting the mouse and touchpad

My mouse does not work

- ❑ If you are using an external mouse, check that the mouse is plugged into the mouse connector. See “Connecting an External Display” for details.
- ❑ If you are using an optional Sony USB mouse PCGA-UMS1 series, check that the mouse is plugged into the USB connector.

My touchpad does not work properly

- ❑ You may have disabled the touchpad without a mouse being connected to the notebook. To enable the touchpad:
 - 1 Click Start, point to Programs, and click Sony Notebook Setup.
 - 2 Click Touchpad tab.
 - 3 Click Use touchpad, and then click OK.(Please check the instructions that came with your notebook.)
- ❑ You must restart the notebook to make the touchpad work again.
- ❑ If your touchpad is interpreting a single tap as a double-click, you must adjust the button assignments. Follow these steps:
 - 1 Click Start, point to Control Panel, and then click on the Mouse icon.
 - 2 Change the button assignments in the Mouse Properties dialog box. (One of the buttons is assigned to the double-click action.)

The pointer does not move (while using the Touchpad or Mouse)

- ❑ Click the Start button on the Windows taskbar, and select Shut Down to display the Shut Down Windows dialog box, then press Enter.
- ❑ (Windows Me) If you cannot turn off your notebook as described in the step above, press Ctrl+Alt+Delete (at the same time) to restart the notebook.
(Windows 2000) If you cannot turn off your notebook as described in the

step above, press Ctrl+Alt+Delete (at the same time) and click Shut Down on the Windows® Security screen to restart the notebook.

- ❑ If you cannot restart your notebook as described in the step above, press and hold the power button for more than four seconds to turn off the notebook.
- ❑ If the pointer does not move while playing a disc, press Ctrl+Alt+Delete to stop playback and restart the notebook.

Troubleshooting drives, PC cards and peripheral devices

My floppy disk drive can not write to a diskette

- ❑ If the diskette is write-protected, disable the write-protect feature or use a diskette that is not write-protected.
- ❑ Check that the diskette is properly inserted into the floppy disk drive.

My optical drive is not playing my CD or DVD properly

- ❑ Make sure the label of the disc is facing up.
- ❑ If the disc requires software, make sure the software is installed according to the manufacturer's instructions.
- ❑ A dirty or damaged disc may cause the notebook to stop responding while it tries to read the disc. If necessary, restart the notebook, remove the disc, and then check it for dirt or damage.
- ❑ If you see video but can not hear audio, check all of the following:
 - ❑ Check that your optical drive does not have the mute setting enabled.
 - ❑ Check the volume setting in the audio mixer.
 - ❑ If you are using external speakers, check the volume settings, and then check the connections between your external speakers and the notebook.
 - ❑ Click Start >Control Panel > System > Device Manager. Check that the correct drivers are installed properly.
- ❑ Do not use adhesive labels to identify the CD. The label may come off while the disc is in use in the optical drive and cause the drive to malfunction.
- ❑ If a region code warning appears when you try to use your optical drive, it may be that the DVD you are trying to play is incompatible with the optical drive. Check the region code listing on the DVD packaging.

- ❑ Moisture condensation may have occurred. Leave the notebook idle for at least 1 hour with the notebook turned on.

My optical drive tray does not open

- ❑ Make sure the notebook is turned on.
- ❑ Press the Eject button on the optical drive.
- ❑ If the Eject button does not work, open the tray by inserting a sharp, pointed object in the hole to the right of the Eject button.

I cannot use digital video (DV) devices. The message "DV equipment seems to be disconnected or turned off" appears.

- ❑ Check that the DV device is turned on and that the cables are properly connected.
- ❑ If you are using multiple i.LINK* devices, the combination of the connected devices may cause unstable operation. In this case, turn off your notebook and all connected devices. Disconnect the devices that are not in use. Check the connections for each device, then restart your notebook.

My PC card is not working

- ❑ Make sure the PC card is compatible with Microsoft® Windows®.
- ❑ Use the Sony Notebook Setup utility to disable devices you are not currently using.
- ❑ If you are using two PC cards, use the Sony Notebook Setup utility to disable the devices you are not currently using.

Troubleshooting software

My software program stops responding or crashes

Contact the software publisher or designated provider for technical support. See the "Software Support Information".

* i.LINK is a SONY trademark used to designate that a product contains an IEEE 1394 connector. All products with an i.LINK connector may not communicate with each other.

When I click an application icon, the message "You must insert the application CD into your optical drive" appears and the software does not start

- ❑ Some titles require specific files that are located on the application CD. Insert the disc and try starting the program again.
- ❑ Make sure you place the CD in the tray with the label side facing up.

I hear background "noise" while using Windows Media Player to play my music CDs

Sony suggests using the preinstalled Media Bar software to play audio CDs.

I can not use the DVgate software

If your notebook is using the Ultimate Battery Life profile for its power saving mode, you cannot use DVgate or Smart Connect software. Please select another profile.

Troubleshooting the modem

My modem does not work

- ❑ Check that the phone line is plugged into the line jack. See "Connecting a Phone Line" for details.
- ❑ Check that the phone line is working. You can check the line by plugging in an ordinary phone and listening for a dial tone.
- ❑ Check that the phone number the program is dialing is correct.
- ❑ Check that the software you are using is compatible with the notebook's modem. (All preinstalled Sony programs are compatible.)

My modem connection is slow

Your notebook is equipped with a 56K/V.90 compatible modem. Many factors may influence modem connection speed, including telephone line noise or compatibility with telephone equipment (such as fax machines or other modems). If you think your modem is not connecting properly to other PC-based modems, fax machines, or your Internet Service Provider, check the following:

- ❑ Have your phone company check that your phone line is free from any line noise.

- ❑ If your problem is fax-related, check that there are no problems with the fax machine you are calling and that it is compatible with fax modems.
- ❑ If you are having a problem connecting with your Internet Service Provider, check that the ISP is not experiencing technical problems.
- ❑ If you have a second phone line available, try connecting the modem to that line.

Troubleshooting audio

My speakers have no sound

- ❑ If the built-in speakers are turned off, press Fn+F3 to turn on the speakers. You can also turn on the speakers using the Jog Dial control.
- ❑ If the speaker volume is turned to the minimum, press Fn+F4, and then press **↑** or **→** to increase the volume or you can use the Jog Dial control to control the volume.
- ❑ If nothing is displayed when you press Fn+F3 or Fn+F4.
 - 1 Double click System in Control Panel.
 - 2 Set the sound device to enable in Device Manager.
- ❑ If your notebook is powered by batteries, check that the battery packs are inserted properly and that they are charged.
- ❑ If you are using an application that has its own volume control, check that the volume is turned up.
- ❑ Check the volume controls in Windows®.
- ❑ If you connect external speakers, check that the speakers are properly connected and the volume is turned up. If the speakers have a mute button, make sure it is off. If the speakers are powered by batteries, check that the batteries are inserted properly and that they are charged.
- ❑ If you have connected an audio cable to the Headphone connector, disconnect the cable.

My microphone does not work

If you are using an external microphone, check that the microphone is plugged into the Microphone connector. See “Connecting an External Microphone” for details.

Troubleshooting the printer

I cannot print

- ❑ The default setting for the printer port mode is correct for most printers. If you cannot print, try changing the printer port mode. In Sony Notebook Setup, select the Printer tab. If the printer port mode is set to ECP, change it to bi-directional. If the printer port mode is set to bi-directional, change it to ECP. See “Displaying the Sony Notebook Setup Screen” for details on using Sony Notebook Setup.
- ❑ Your connected printer may not function after the notebook resumes from a power saving mode. If this occurs, follow these steps to reset the printer connection:

Windows Me Only

- ❑ Right-click My Computer icon on the desktop, then select Properties.
- ❑ Click the Device Manager tab.
- ❑ Select Refresh, then click OK. The printer should function properly.

Windows 2000 Only

- ❑ Double-click My Computer icon on the desktop, then double-click on the Control Panel folder.
- ❑ Double-click on the Printers folder.
- ❑ Right-click on the icon of the printer that is not functioning, and select Properties to access the Properties window.
- ❑ Click OK to close the Properties window. The printer should function properly.

Specifications

The following table details the hardware specifications for your computer.

Model	PCG-FX120/FX120K PCG-FX140/ FX-140K	PCG-FX150/FX150K	PCG-FX170/FX170K PCG-FX190/FX190K
Processor	700 MHz* Intel® Pentium® III with Intel® SpeedStep™ Technology†	750 MHz* Intel® Pentium® III with Intel® SpeedStep™ Technology†	800 MHz* (PCG-FX170 PCG-FX170K) 850 MHz* (PCG-FX190 PCG-FX190K) Intel® Pentium® III with Intel® SpeedStep™ Technology†
L2 Cache Memory	256KB (CPU Integrated)		
Hard Disk Drive C/D Partition (Approximate)	10 GB‡ 40% and 60%	20 GB‡ 40% and 60%	20 GB‡ (PCG-FX170 PCG-FX170K) 30 GB‡ (PCG-FX190 PCG-FX190K) 40% and 60%
Standard RAM	64 MB SDRAM (PCG-FX120/FX-120K) 128 MB SDRAM (PCG-FX140/FX-140K) Expandable to 512 MB	128 MB SDRAM	
LCD Screen	13.3" XGA TFT (PCG-FX120/FX120K) 14.1" XGA TFT (PCG-FX140/FX-140K)	15.0" XGA TFT	15.0" XGA TFT (PCG-FX170 PCG-FX170K) 15.0" SXGA+ TFT (PCG-FX190 PCG-FX190K)
MPEG	Available		
Graphics	Intel® 815 EM Chipset integrated 3D accelerator		
Sound Capabilities	Windows® sound system compatible, 3D surround Analog devices AD1881A		
Diskette Drive	Removable 3.5" 1.44 MB		

Model	PCG-FX120/FX120K PCG-FX140/ FX-140K	PCG-FX150/FX150K	PCG-FX170/FX170K PCG-FX190/FX190K
Optical drive	DVD-ROM drive: Reads data up to 24x max. CD-ROM reading speed. Reads data up to 8x max. DVD-ROM reading speed. ^{††}		CD-RW/DVD-ROM drive: Reads data up to 24x max. CD-ROM reading speed. Reads data up to 8x max. CD-R writing speed. Reads data up to 4x max. CD-RW writing speed. Reads data up to 8x max. DVD-ROM reading speed.
Laser Diode Properties	Wave Length: 780 nm and 650 nm Laser Output: 30.2 uW		Wave Length: 785 nm and 660 nm Laser Output: 85 mW
Modem	V.90/K56flex data/fax compatible modem ^{††}		
Drive Bay	<ul style="list-style-type: none"> • Supports floppy disk drive (included) • Supports second rechargeable battery (optional) 		
Expansion Capabilities	Type I/II PC cards and Type III PC card with CardBus support		
Connection Capabilities	<ul style="list-style-type: none"> • 2 USB ports • i.LINK^{†††} • Serial port • VGA monitor • Parallel (printer) • Phone line (RJ-11) • Microphone • Headphone 		
		<ul style="list-style-type: none"> • TV out • Port replicator 	
Supplied Accessories	<ul style="list-style-type: none"> • Floppy disk drive • Rechargeable battery • AC adapter and power cord • Weight saver 		
		<ul style="list-style-type: none"> • Video cable 	
Power Requirements	58.5 watts maximum (19.5V DC/AC 100-240V)		

Model	PCG-FX120/FX120K PCG-FX140/ FX-140K	PCG-FX150/FX150K	PCG-FX170/FX170K PCG-FX190/FX190K
Power Management	<ul style="list-style-type: none"> • Energy Star compliant • Advanced Configuration and Power Interface (ACPI) 		
Battery	<ul style="list-style-type: none"> • Lithium-ion • Supports dual battery operation 		
Dimensions	12.8"(w) x 1.9"(h)** x 10.3" (d) (324 x 48.1 x 265.5mm)	12.8"(w) x 2.2"(h)** x 10.3" (d) (324 x 55.3 x 265.5mm)	
Weight	<ul style="list-style-type: none"> • 6.2 lbs. (2.8 kg) (with battery and weight saver) • 6.6 lbs. (3.0 kg) (with battery and floppy disk drive) 	<ul style="list-style-type: none"> • 6.8 lbs. (3.1 kg) (with battery and weight saver) • 3.1 lbs. (3.4 kg) (with battery and floppy disk drive) 	
Operating Temperature	40° F to 95° F (+5° C to 35° C) temperature gradient less than 50° F (10° C) per hour		
Operating Humidity	20% to 80% (not condensed), provided that humidity is less than 65% at 95° F (35° C), hygrometer reading of less than 84° F (29° C)		
Storage Temperature	-4° F to 140° F (-20° C to 60° C), temperature gradient less than 18° F (-10° C) per hour		
Storage Humidity	10% to 90% (not condensed) provided that humidity is less than 20% at 140° F (60° C), hygrometer reading of less than 95° F (35° C)		

* MHz denotes microprocessor internal clock speed; other factors may affect application performance.

† The processor may be reduced to a lower operating speed when operating on battery power.

‡ The size of your hard disk may differ if you purchased a specially configured system. GB means one billion bytes when referring to hard drive capacity. Accessible capacity may vary.

†† If a region code warning appears when you are using the DVD player, it could be that the DVD you are trying to play is incompatible with the optical drive in your VAIO notebook. Region code indicators such as a "1" or "ALL" are labeled on some DVDs to indicate what type of player can play the discs. Unless a "1" or "ALL" is identified on your DVDs or on the packaging, you cannot play the disc on this player.

‡‡ Maximum speed for faxing is 14.4 kbps. Your 56K/V.90 compatible modem is capable of downloading at 53 kbps. Your online service or Internet Service Provider, however, may not support this technology or operate at this speed.

** Height measured at thickest point. The thinnest height for PCG-FX120/FX120K/FX140/FX140K is 1.3". The thinnest height for PCG-FX150/FX150K/FX170/FX170K/FX190/FX190K is 1.4".

††† i.LINK is a SONY trademark used to designate that a product contains an IEEE 1394 connector. All products with an i.LINK connector may not communicate with each other.

NOTE: Specifications are subject to change without notice.

Index

A

- About This Computer tab 82
- AC adapter 19, 24
- AC power 24
- AC Profile power setting 85
- adding
 - hardware 63
 - memory 93
 - peripherals 63
 - printers 69
- adjusting
 - brightness 31, 36
- Alt key 34
- Application Recovery CD 110
- Applications key 34
- attaching port replicator 64
- Audio tab 82

B

- Basic/Advanced tab 82
- battery packs 19, 25
 - charge status icons 87
 - charging 26, 53
 - indicator lights 27, 35, 52
 - inserting 25
 - inserting into battery bay 25
 - loading 25
 - rechargeable 24
 - removing 28, 52, 54
- BatteryScope utility 87
- brightness
 - adjusting 31, 36

- built-in speakers
 - See also speakers 36
- buttons
 - Eject 43, 45
 - Start 31, 81

C

- cables
 - phone 19
 - power cord 24
- cameras
 - digital video recorder 76
- canceling commands 34
- Caps Lock
 - indicator light 36
- CD-ROM/DVD-ROM discs
 - ejecting 45
 - inserting 43
- CD-ROMs
 - handling 47
- CD-RW/DVD-ROM drive 43
- charge status indicator light 27
- charging battery packs 26, 53
- choosing
 - power source 25
- coin-operated telephones 60
- computer
 - customizing 81
 - handling 16
 - lithium ion battery 7
 - setting up 19
 - setup screen 81

- starting 30
 - troubleshooting 115, 122
 - unpacking 12
 - connecting
 - coin-operated telephones 60
 - digital video recorder 76
 - external speakers 78
 - hard drives 49
 - microphone 79
 - monitor 70
 - multimedia computer display 70
 - multiple phone lines 60
 - network 49, 64
 - party phone lines 60
 - PBX 60
 - phone line 60
 - port replicator 64
 - power source 24
 - printer 69
 - projector 71
 - USB device 75
 - weight saver 55
 - connectors
 - DC In 24
 - network 64
 - printer 69
 - Serial port 64
 - correction keys 34
 - Ctrl key 34
 - cursor-movement keys 34
 - customizing your computer 81
- D**
- DC In 24
 - digital video camera 76
 - disconnecting port replicator 67
 - diskettes
 - troubleshooting 121
 - display
 - mode 89
 - options 71
 - selecting 71
- disposal of lithium ion battery 7
- Driver Recovery CD 112
- drives
 - floppy disk 19
 - installing additional hard disk 49
- DV In/Out 76
- DVD-ROM drive
 - closing tray 45
 - opening tray 43
 - using 43
- DVD-ROM drive tray
 - troubleshooting 122
- DVD-ROMs
 - handling 47
- E**
- Eject button 43, 45
 - ejecting
 - battery packs 54
 - CD-ROM/DVD-ROM discs 45
 - weight saver 56
 - Energy Star 2
 - ergonomic considerations 14
 - Escape key 34
 - expansion memory configuration 94
 - external devices
 - display 71
 - See also monitor
 - speakers 36, 78
- F**
- faxes
 - laws governing 6
 - floppy disk drive 19
 - cable 19

- disconnecting 41
- troubleshooting 121
- Fn key 34
 - combination commands 36
- function keys 34

H

- handling 16
 - CD-ROMs and DVD-ROMs 47
- handling the LCD screen 16
- hard drives
 - indicator light 35
 - installing additional 49
- Help
 - Mouseware 39
- Hibernate mode 37, 59

I

- i.LINK 76
- IEEE 1394 76
- indicator lights 35
 - battery 27, 35, 52
 - Caps Lock 36
 - charge status 27
 - hard drive 35
 - Num Lock 36
 - Scroll Lock 36
- input devices 5
- Insert key 34
- inserting
 - battery pack 25
 - CD-ROM/DVD-ROM discs 43
- installation 15
- installing
 - hard drives 49
 - hardware 63
 - memory module 96
 - peripherals 63

- interference 5

K

- keyboard 34

L

- LCD
 - lock lever 30
 - selecting to display output 71
 - troubleshooting 119
- LCD screen
 - handling 16
- lever
 - LCD 30
 - weight saver release 54
- lithium ion battery
 - disposal 7
 - safety precautions 7
- loading
 - battery pack 25

M

- maintenance 16
- Maximum Battery Life power setting 84
- Maximum Performance power setting 84
- memory module
 - expansion 94
 - installing 96
 - removing 94
- microphone
 - connecting 79
 - troubleshooting 124
- modem
 - laws governing 6
 - troubleshooting 123
- monitor

- connecting 70
- selecting 71
- switching among 36
- mouse
 - troubleshooting 120
- Mouse Properties screen 39
- Mouseware
 - accessing help 39
 - features 39
- MovieShaker instructions 101
- multimedia computer display 70
- multiple phone lines 60

N

- navigation keys 34
- network
 - connecting 49
 - connector 64
 - port replicator 64
- Notebook Computer 19
- Notebook Setup tabs 82
- Num Lock
 - indicator light 36

O

- opening
 - DVD-ROM drive tray 43
- operator keys 34
- output devices 5
 - adding 69

P

- party phone lines 60
- PBX 60
- PC card
 - inserting 49
 - slots 49
 - troubleshooting 122

- phone
 - cable 19
 - connecting line 60
 - jack 60
 - laws governing 6
- PictureGear 105
- port replicator
 - connecting 64
 - disconnecting 67
 - lever 67
 - network 64
- power 35
 - cord 24
 - switch 30
- power management
 - settings 83
- Power Management Off power setting 84
- Power On
 - Password tab 82
- power saving modes 58
 - Hibernate 37, 59
 - Suspend 58
 - Video Standby 37
- power setting
 - AC Profile 85
 - Hibernate 86
 - Maximum Battery Life 84
 - Maximum Performance 84
 - Power Management Off 84
 - Suspend 86
 - Video Standby 86
- power source 24
- power sources 25
 - connecting 24
- PowerPanel
 - activating 83
 - customizing toolbar 84, 86
- Print Screen key 34

-
- printer
 - connecting 69
 - port 69
 - Printer tab 82
 - projector 71
 - R**
 - radio interference 5
 - rechargeable battery packs 24, 25
 - recharging battery packs 26
 - Recovery CD 110
 - regulatory information 5
 - removing
 - battery packs 28
 - floppy disk drive 41
 - memory module 94
 - replacing
 - battery packs 52
 - restoring data 110
 - S**
 - Scroll Lock
 - indicator light 36
 - second battery pack 25, 52
 - selecting
 - display 71
 - LCD 71
 - monitor 71
 - power source 25
 - Serial connector 64
 - setup screen
 - About This Computer tab 82
 - Audio tab 82
 - Basic/Advanced tab 82
 - displaying 81
 - Power On Password tab 82
 - Printer tab 82
 - Touchpad tab 82
 - setup tabs 82
 - Shift key 34
 - Shut Down Windows dialog box 31
 - shutting down 31
 - Software list 97
 - Sony Notebook Setup screen 81
 - Sony Service Center 109
 - speakers
 - external 78
 - switching 36
 - troubleshooting 124
 - volume 36
 - Specifications 127
 - Start button 81
 - starting
 - computer 30
 - startup problems 31
 - switching
 - display 36
 - monitor 36
 - Suspend mode 36, 58, 86
 - T**
 - touchpad 38
 - Touchpad tab 82
 - troubleshooting 115
 - startup 31, 115
 - turning on
 - computer 30
 - TV
 - interference 5
 - U**
 - unpacking the computer 12
 - USB
 - connecting 75
 - connector 75
 - mouse 75

V

- VAIO Support Agent 112
- ventilation slot 22
- video camera 76
- Video Standby mode 37
- viewing the amount of memory 96
- volume control 36

W

- weight saver
 - attaching 52
 - connecting 55
 - fold-out arm 55
 - removing 56
- window design of Sony software 90
- Windows
 - Explorer 34
 - Find window 34
 - help 34
 - key 34
 - key combinations 34
 - Start button 31
 - taskbar 31, 117

Free Manuals Download Website

<http://myh66.com>

<http://usermanuals.us>

<http://www.somanuals.com>

<http://www.4manuals.cc>

<http://www.manual-lib.com>

<http://www.404manual.com>

<http://www.luxmanual.com>

<http://aubethermostatmanual.com>

Golf course search by state

<http://golfingnear.com>

Email search by domain

<http://emailbydomain.com>

Auto manuals search

<http://auto.somanuals.com>

TV manuals search

<http://tv.somanuals.com>