

SONY[®]

4-117-793-32(1)

Wireless Audio System

Operating Instructions
AIR-SA20PK

S-AIR
DIGITAL WIRELESS

© 2008 Sony Corporation

Download from Www.Somanuals.com. All Manuals Search And Download.

WARNING

To reduce the risk of fire or electric shock, do not expose this apparatus to rain or moisture.

To reduce the risk of fire, do not cover the ventilation opening of the apparatus with newspapers, tablecloths, curtains, etc. Do not place the naked flame sources such as lighted candles on the apparatus.

To reduce the risk of fire or electric shock, do not expose this apparatus to dripping or splashing, and do not place objects filled with liquids, such as vases, on the apparatus.

As the main plug is used to disconnect the unit from the mains, connect the unit to an easily accessible AC outlet. Should you notice an abnormality in the unit, disconnect the main plug from the AC outlet immediately.

The unit is not disconnected from the mains as long as it is connected to the AC outlet, even if the unit itself has been turned off.

Do not install the appliance in a confined space, such as a bookcase or built-in cabinet.

Do not expose batteries or apparatus with battery-installed to excessive heat such as sunshine, fire or the like.

The nameplate is located on the bottom exterior.

AIR-SA15R only

Excessive sound pressure from earphones and headphones can cause hearing loss.

Notice for customers: the following information is only applicable to equipment sold in countries applying EU Directives

The manufacturer of this product is Sony Corporation, 1-7-1 Konan Minato-ku, Tokyo, 108-0075 Japan.

The Authorized Representative for EMC and product safety is Sony Deutschland GmbH, Hedelfinger Strasse 61, 70327 Stuttgart, Germany.

For any service or guarantee matters, please refer to the addresses given in separate service or guarantee documents.



Disposal of Old Electrical & Electronic Equipment (Applicable in the European Union and other European countries with separate collection systems)

This symbol on the product or on its packaging indicates that this product shall not be treated as household waste. Instead it shall be handed over to the applicable collection point for the recycling of electrical and electronic equipment. By ensuring this product is disposed of correctly, you will help prevent potential negative consequences for the environment and human health, which could otherwise be caused by inappropriate waste handling of this product. The recycling of materials will help to conserve natural resources. For more detailed information about recycling of this product, please contact your local Civic Office, your household waste disposal service or the shop where you purchased the product.

Applicable accessories: Wireless Transceiver (EZW-RT10/EZW-RT10A)



Disposal of waste batteries (applicable in the European Union and other European countries with separate collection systems)



Pb

This symbol on the battery or on the packaging indicates that the battery provided with this product shall not be treated as household waste. On certain batteries this symbol might be used in combination with a chemical symbol. The chemical symbols for mercury (Hg) or lead (Pb) are added if the battery contains more than 0.0005% mercury or 0.004% lead. By ensuring these batteries are disposed of correctly, you will help prevent potentially negative consequences for the environment and human health which could otherwise be caused by inappropriate waste handling of the battery. The recycling of the materials will help to conserve natural resources. In case of products that for safety, performance or data integrity reasons require a permanent connection with an incorporated battery, this battery should be replaced by qualified service staff only. To ensure that the battery will be treated properly, hand over the product at end-of-life to the applicable collection point for the recycling of electrical and electronic equipment.

For all other batteries, please view the section on how to remove the battery from the product safely. Hand the battery over to the applicable collection point for the recycling of waste batteries.

For more detailed information about recycling of this product or battery, please contact your local Civic Office, your household waste disposal service or the shop where you purchased the product.

- “S-AIR” and its logo are trademarks of Sony Corporation.
- iPod is a trademark of Apple Inc., registered in the U.S. and other countries.
- The Bluetooth word mark and logos are owned by the Bluetooth SIG, Inc. and any use of such marks by Sony Corporation is under license. Other trademarks and trade names are those of their respective owners.
- All other trademarks and registered trademarks are of their respective holders. In this manual, ™ and ® marks are not specified.

Table of Contents

Features	6
Unpacking	7
Guide to parts and controls	8

Getting Started

Hooking up the system.....	16
Establishing the S-AIR connection	18
Setting the clock of the sub units	21

Operations

Selecting the S-AIR mode	22
Listening to iPod music using the S-AIR connection.....	23
Listening to the radio using the S-AIR connection.....	25
Presetting radio stations	26
Using an optional AV system	27
Changing the display	28
Using the Timers.....	29
Turning off the remote control function of the sub units.....	31
Changing the illumination brightness of the main unit.....	31

Others

Troubleshooting.....	32
Messages.....	36
Precautions.....	36
Specifications	38
Compatible iPod models.....	40
Index.....	41

Features

The AIR-SA20PK is an “S-AIR” compatible packaged product that consists of one S-AIR main unit AIR-SA15Ti and two S-AIR sub units AIR-SA15R.

Connecting the S-AIR main unit (hereafter called “Main unit”) with the S-AIR sub units (hereafter called “Sub units”) using “S-AIR” technology, you can use each unit in a remote location.

For example, you can install the sub units, one in the study room and the other in the bedroom, and then install the main unit in the living room. You can then listen to the music from the main unit located in the living room by controlling the sub units.

You can also connect the main unit to an optional AV system (such as a TV), and on this optional AV system you can enjoy audio, video and photo contents of an iPod which is connected to the main unit.

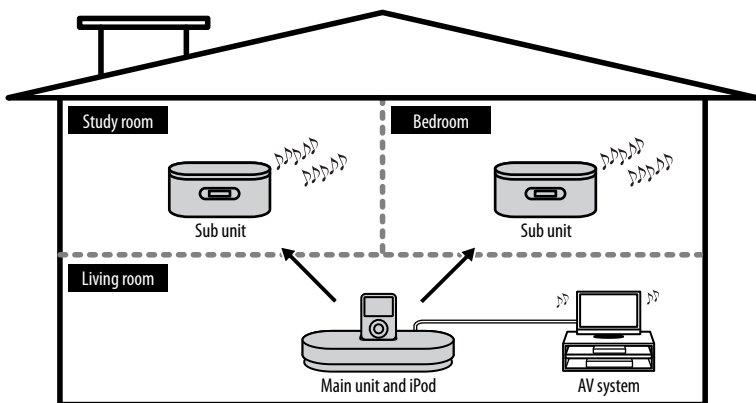

S-AIR (Sony Audio Interactive Radio frequency)

Recent times have seen the rapid spread of DVD media, Digital Broadcasting, and other high-quality media.

To ensure that the subtle nuances of these high-quality media are transmitted with no deterioration, Sony has developed a technology called “S-AIR” for the radio transmission of digital audio signals with no compression, and has incorporated this technology into the EZW-RT10/EZW-RT10A.

This technology transfers digital audio signals with no compression using the 2.4 GHz band range of ISM band (Industrial, Scientific, and Medical band), such as wireless LANs and Bluetooth applications.

Unpacking

Check that you have all the following items.

■ Main unit

Main unit (AIR-SA15Ti) (1)

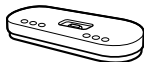

Wireless transceiver (EZW-RT10 or EZW-RT10A) (1)*



Remote (RM-ANU045) (1)

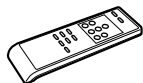

R03 (size AAA) batteries (2)*



FM lead antenna (1)

One of the following two antennas is supplied.



or



AM loop antenna (1)



iPod Dock Adapters (1 set)



■ Sub unit

Sub unit (AIR-SA15R) (2)



Wireless transceiver (EZW-RT10 or EZW-RT10A) (2)*



Remote (RM-ANU046) (2)

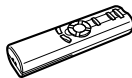

R03 (size AAA) batteries (4)*



■ Others

Operating Instructions (this manual) (provided in each language)

Warranty (1)

* The same type of wireless transceivers and batteries are used for the main unit and the sub units.

Guide to parts and controls

Main unit (AIR-SA15Ti/Wireless Audio Transmitter)

Front panel

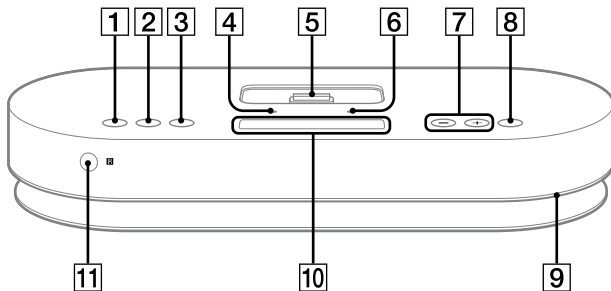

Rear panel

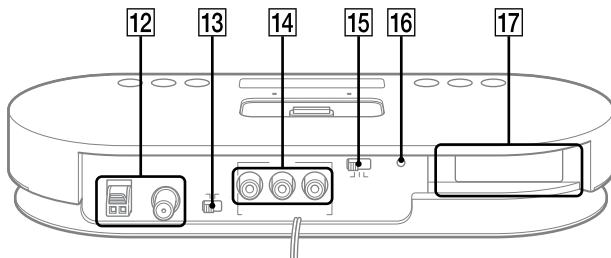

Remote for the main unit (RM-ANU045)

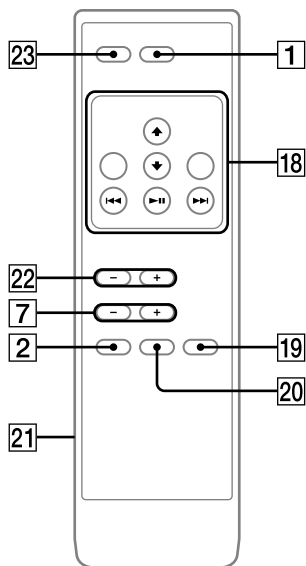

1
ILLUMINATION (31)
Press to change the illumination brightness.

2
BAND (25)
Press to select FM or AM reception mode.

3
SYSTEM MENU (20, 23, 26, 35)
Press to enter the system menu.

4
POWER indicator (18)
Lights up when the main unit is turned on.

5
iPod connector (17, 23, 27)
Place an iPod on the connector to listen to audio contents stored in the iPod. You need to connect the supplied iPod Dock Adapter first to use an iPod. For details on the supplied iPod Dock Adapters, refer to the instructions supplied with the iPod Dock Adapters.

6
S-AIR indicator
Lights up when the main unit is turned on with the supplied wireless transceiver inserted.

7
Unit: TUNING/SELECT +/- (20, 23, 25, 26, 35)
Press to tune in the desired station. Press to select a menu item.
Remote: TUNING +/- (25, 26)
Press to tune in the desired station.

8
ENTER (20, 23, 26, 35)
Press to enter the settings.

9
Illumination (31)
You can change the brightness using ILLUMINATION **1**.

Continued

10

Display (11)

11

Remote sensor

12

ANTENNA jacks (16, 17)

Connect the supplied FM lead antenna and AM loop antenna.

13

POWER switch (18, 32)

Switch for turning the main unit on or off.

14

iPod AUDIO OUT L/R jacks (27)

iPod VIDEO OUT jack (27)

Connect an optional AV system, such as a TV, etc.

15

S-AIR ID selector (17, 18)

Select the S-AIR ID to connect with the sub units.

16

PAIRING button (20)

Press to perform pairing.

17

EZW-RT10 slot (17)

Insert the supplied wireless transceiver.

18

Buttons for controlling an iPod

▶|| (play/pause) (24)

Press to start or pause playback.

◀◀/▶▶ (24)

Press to skip to the previous/next track.
Hold down to find a point in a track.

MENU (24)

Press to return to the previous menu.
Works much like the Menu button on the iPod.

▲/▼ (24)

Press to select a menu item or track for playback.

ENTER (24)

Press to execute the selected item or play the selected track.

19

PARTY CH (23, 25, 27)

Press to select the sound source when the S-AIR mode is set to "PARTY."

20

S-AIR MODE (23)

Press to select the S-AIR mode.

21

Battery compartment lid (18)

22**PRESET +/- (27)**

Press to select a preset station.

23**DISPLAY (23, 27, 28)**

Press to view the information on the display.

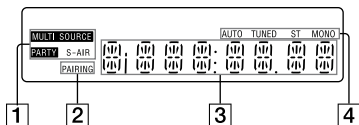
Display**1**

S-AIR mode indicator (23)

2

PAIRING indicator (19)

3

Text information

4

Tuner reception mode (25)

Tuner reception (25)

Continued 

Sub unit (AIR-SA15R/Wireless Speaker System)

Front panel

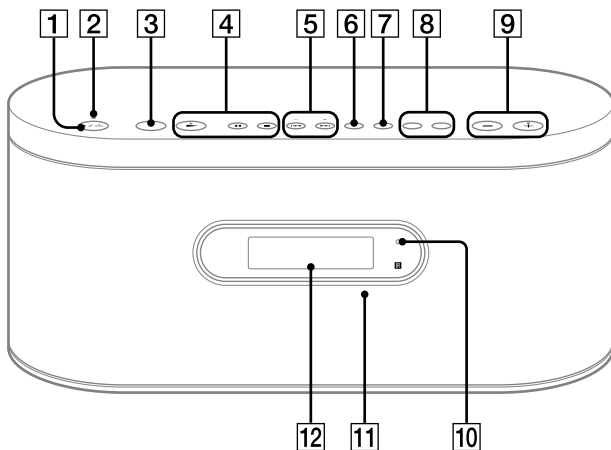

Rear Panel

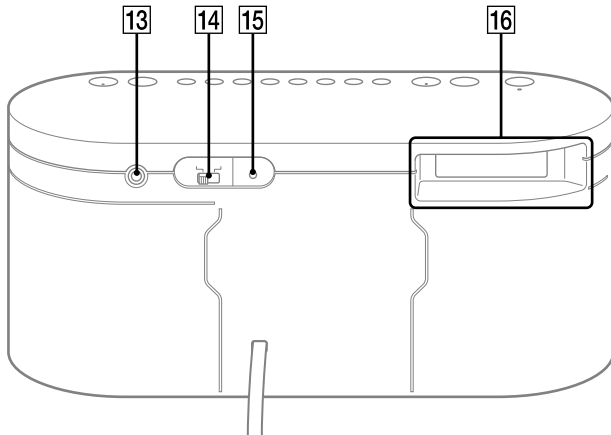

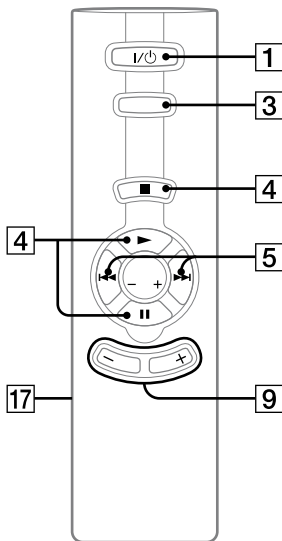
Remote for the sub unit (RM-ANU046)

1
I/⏻ (power) (18, 30, 35)
 Press to turn on or off the sub unit.

2
STANDBY indicator (32)
 Lights up when the sub unit is turned off.

3
S-AIR CH (24, 26, 27)
 Press to select the S-AIR channel of the connected main unit.

4
▶ (play) (24, 30)
 Press to start or pause playback of an iPod connected to the main unit.

⏸ (pause) (24)
 Press to pause or start playback of an iPod connected to the main unit.

■/CANCEL (stop/cancel) (24, 35)
 Press to pause playback of an iPod connected to the main unit.

5
⏮/▶▶ (21, 24, 29)
 Press to skip to the previous/next track of an iPod connected to the main unit.
 Hold down to find a point in a track of an iPod connected to the main unit.

PRESET +/- (27)
 Press to select a preset station.

6
DISPLAY (28, 31, 35)
 Press to display the information of the connected main unit or clock in the display.

7
SLEEP (29)
 Press to set the Sleep Timer.

Continued

8

CLOCK TIMER/MENU (21, 29)

CLOCK TIMER/ENTER (21, 29, 31)

Press to set the clock and the Daily Timer.

9

VOLUME +/- (24, 29, 31)

Press to adjust the volume.

10

S-AIR indicator (19)

Lights up while the sub unit is connected to the main unit.

Flashes when the sub unit is not connected to the main unit.

11

Remote sensor

12

Display (15)

13

 **(headphones) jack**

Connect optional headphones.

14

S-AIR ID selector (17, 18)

Select the same S-AIR ID as the main unit.

15

PAIRING button (20)

Press to perform pairing.

16

EZW-RT10 slot (17)

Insert the supplied wireless transceiver.

17

Battery compartment lid (18)

Display

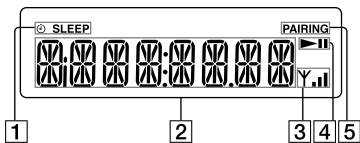

1

Timer indicator (29)

2

Text information

3

Wireless strength

Indicates the S-AIR signal strength.

4

Play/Pause

5

PAIRING indicator (19)

Getting Started

Hooking up the system

Main unit

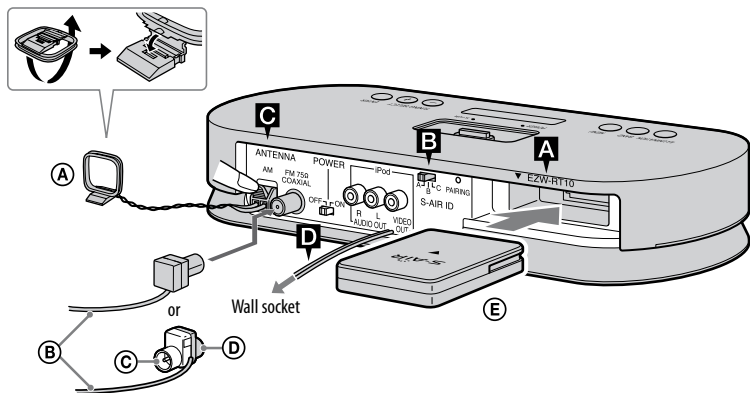

Sub unit

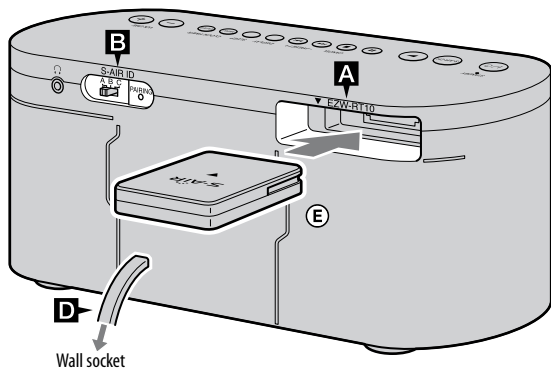

- (A) AM loop antenna
- (B) FM lead antenna (Extend it horizontally.)
- (C) White side for North American model
- (D) Brown side for other models
- (E) Wireless transceiver

A Wireless transceiver

Insert the supplied wireless transceiver (EZW-RT10 or EZW-RT10A) securely into the EZW-RT10 slot on the rear panel of each unit.

Check the orientation of the ▼ mark when inserting the supplied wireless transceivers (EZW-RT10 or EZW-RT10A). Failure to do so may result in damage to the unit.

Notes

- Make sure to turn off the main unit and the sub units when inserting or removing the supplied wireless transceivers (EZW-RT10 or EZW-RT10A). Failure to do so may result in damage to the unit.
- Do not touch the terminals of the supplied wireless transceivers (EZW-RT10 or EZW-RT10A).
- Do not insert any device other than the supplied wireless transceivers (EZW-RT10 or EZW-RT10A) into the EZW-RT10 slot.

B S-AIR ID selector

Set the same S-AIR ID for the main unit and the sub units. For details on setting the S-AIR ID, see “Establishing the S-AIR connection” (page 18).

C FM/AM antennas

Find a location and an orientation that provide good reception, and then set up the antenna.

Keep the antennas away from the power supply cord to avoid picking up noise.

D Power

Connect the power supply cord and the power cord to a wall socket.

To use the iPod

Insert an iPod Dock Adapter into the iPod connector on the main unit before use.

For details on the supplied iPod Dock Adapters, refer to the instructions supplied with the Dock Adapters.

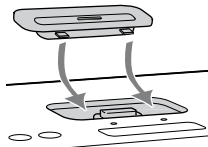

To remove the iPod Dock Adapter, pull it up with your fingernail or a flat object using the slot inside the adapter.

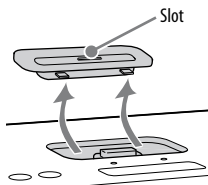

To use the remote

Slide and remove the battery compartment lid, and insert the two supplied R03 (size AAA) batteries,  side first, matching the polarities shown below.

Remote for the main unit (RM-ANU045)

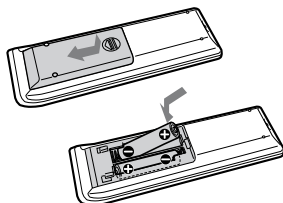

Remote for the sub unit (RM-ANU046)

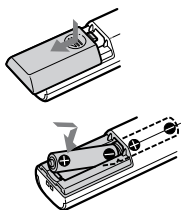

Notes on using the remote

- With normal use, the batteries should last for about six months.
- Do not mix an old battery with a new one or mix different types of batteries.
- If you do not use the remote for a long period of time, remove the batteries to avoid damage from battery leakage and corrosion.

Establishing the S-AIR connection

You can easily establish the connection by setting the same S-AIR ID for the main unit and the sub units.

- 1 Check that the wireless transceivers are inserted securely to the main unit and the sub units (page 17).
- 2 Turn on the main unit and the sub units.

Main unit

Set the POWER switch on the rear panel to "ON."
The POWER indicator on the unit lights up.

Sub units

Press .

- 3 Set the same S-AIR ID for the main unit and the sub units.

Main unit

Set the S-AIR ID selector on the rear panel to the desired S-AIR ID.

Sub units

Set the S-AIR ID selector on the rear panel to the same S-AIR ID as the main unit.

Tip

The S-AIR ID is set at the factory to "A."

4 Confirm the connection status.

Once the connection between the main unit and the sub units is established, the S-AIR indicators on the sub units light up and “LINKED” appears in the displays of the sub units for about 2 seconds.

Tip

Up to 10 sub units (sold separately) can be connected with the main unit.

Identifying the main unit with a specific sub unit (Pairing operation)

It is easy to set the same S-AIR ID for the main unit and the sub units to establish the connection.

However, if a neighbor has an S-AIR main unit with the same S-AIR ID as your S-AIR main unit, you may be able to hear the audio transmitted from your neighbor's S-AIR main unit on your system. To prevent this, you can identify the main unit with a specific sub unit by performing the pairing operation.

Before pairing

The connection is established by the S-AIR ID (example).

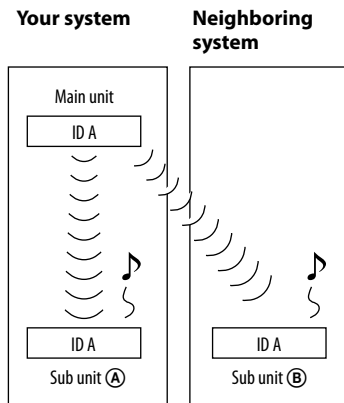

After pairing

The connection is established between the paired main unit and sub unit.

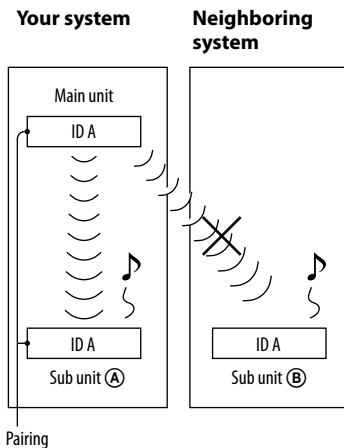

Continued 

1 Place the sub unit to be paired near the main unit.
Pair the main unit with the sub units one at a time.

2 Check that the power of the main unit and the sub unit are turned on.

3 Check that the S-AIR ID of the main unit is the same as the S-AIR ID of the sub unit.

4 Press the PAIRING buttons on the rear panel of the main unit and the sub unit using a pointed object.

When pairing is performed, the displays on both the main unit and the sub unit change as follows:
“PAIRING” → “COMPLETE”

To cancel pairing

Change the S-AIR IDs of the main unit and the sub unit to different S-AIR IDs.

To stop the pairing operation midway

Press the PAIRING button again.

To pair the main unit with multiple sub units

Repeat steps 1 through 4.

If the S-AIR connection is unstable

Since the S-AIR product uses radio waves that share the same frequency (2.4 GHz) as other wireless systems, such as wireless LAN or Bluetooth devices, interference or poor transmission may result if you use other wireless systems near the main unit and/or the sub units.

In this case, the connection may be improved by changing the RF CHANGE (Radio Frequency Change) setting on the main unit.

1 Press SYSTEM MENU on the unit.

2 Press TUNING/SELECT +/- on the unit repeatedly until “RF CHG” appears, then press ENTER on the unit.

3 Press TUNING/SELECT +/- on the unit repeatedly to select the desired setting.

The default setting is underlined.

AUTO:

Normally select this setting. The main unit changes the RF CHANGE setting to “ON” or “OFF” automatically.

ON:

The main unit transmits sound by searching for the best channel for transmission.

OFF:

The main unit transmits sound using a fixed channel for transmission.

When you select this setting, select the S-AIR ID that provides the best connection.

- 4 Press ENTER on the unit to exit the system menu.

Setting the clock of the sub units

Use buttons on the unit to set the clock.

- 1 Press I/⏻ to turn on the unit.
- 2 Select the clock set mode.
Press CLOCK/TIMER MENU. If the current mode appears on the display, press ◀/▶ repeatedly to select "CLOCK," and then press CLOCK/TIMER ENTER.
- 3 Set the time.
Press ◀/▶ repeatedly to set the hour, and then press CLOCK/TIMER ENTER. Use the same procedure to set the minute.

Note

The clock settings are canceled when you disconnect the power cord or if a power failure occurs.

Operations

Selecting the S-AIR mode

When connecting to multiple sub units, you can listen to different sound sources on each sub unit (MULTI SOURCE mode) or to the same sound source on both sub units (PARTY mode) by selecting the S-AIR mode accordingly.

Use the main unit to set the S-AIR mode.

■ MULTI SOURCE mode

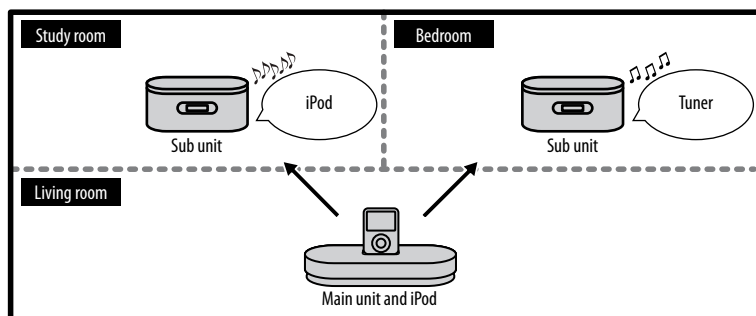

■ PARTY mode

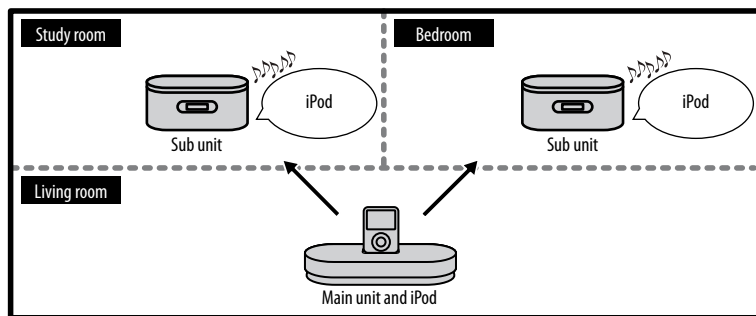

Press S-AIR MODE on the remote repeatedly until the desired S-AIR mode indicator lights up in the display.

The default setting is underlined.

MULTI SOURCE:

Select this setting to listen to different sound sources on each sub unit.

PARTY:

Select this setting to listen to the same sound source on multiple sub units.

To select the S-AIR mode from the system menu

- 1 Press SYSTEM MENU on the unit.
- 2 Press TUNING/SELECT +/- on the unit repeatedly until "MODE" appears, then press ENTER on the unit.
- 3 Press TUNING/SELECT +/- on the unit repeatedly to select "MULTI" or "PARTY," then press ENTER on the unit.
The selected S-AIR mode appears on the display.

To check the S-AIR mode when the display of the main unit is turned off

Press DISPLAY on the remote.

Notes

- When you change the S-AIR mode, the iPod channel is automatically selected for the connected sub units.
- When connecting the main unit to an S-AIR sub unit (such as the AIR-SA10) which is not compatible with the MULTI SOURCE mode, set the main unit to the PARTY mode. You can then select the S-AIR channel from the S-AIR sub unit.

Listening to iPod music using the S-AIR connection

Use the sub units to listen to the music of an iPod connected to the main unit. You can control the connected iPod from either the main unit or the sub units.

To use an iPod, refer to the user's guide of your iPod.

Using the main unit

- 1 Place an iPod on the iPod connector as shown below.

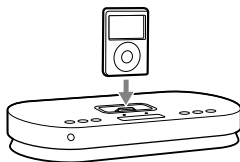

Now, you are ready to listen to the connected iPod using the sub units.

- 2 Select the iPod channel.

When the S-AIR mode is set to "PARTY":

Press PARTY CH on the remote repeatedly until "iPod" appears in the display.

When the S-AIR mode is set to "MULTI SOURCE":

The iPod channel is internally activated. Go to step 3.

Continued

3 Start playback.

Operate the iPod to start playing the music. You can also operate the iPod using the remote (see “To control the iPod using the main unit”).

Using the sub units

1 Place an iPod on the iPod connector on the main unit.

2 Select the iPod channel.











Press S-AIR CH repeatedly until “iPod” appears in the display.

3 Start playback.

Operate the iPod to start playing the music. You can also operate the iPod using the remote (see “To control the iPod using the sub units”).

To control the iPod using the main unit











You can control your iPod with the following buttons on the remote.

To	Press
Start playback	 
Pause playback	 To resume playback, press  again.
Select a menu or track for playback	 /  . You can scroll up or down the iPod menus.
Skip a track	 / 
Find a point in a track	Hold down  /  during playback, and release the button at the desired point.

To	Press
Choose the selected item	ENTER. You can choose the selected item much like the center button on the iPod.
Return to the previous menu	MENU. You can return to the previous menu much like the Menu button on the iPod.

To control the iPod using the sub units

You can control your iPod with the following buttons on the remote or unit.

To	Press
Start playback	
Pause playback	 ,  or  /CANCEL. To resume playback, press  or  .
Skip a track	 / 
Find a point in a track	Hold down  /  during playback, and release the button at the desired point.
Adjust the volume	VOLUME +/–.

To use the main unit as a battery charger

You can use the main unit as a battery charger for the iPod when the main unit is on.

The charging begins when the iPod is placed on the iPod connector. The charging status appears in the iPod display. For details, refer to the user's guide of your iPod.

To stop charging the iPod, remove the iPod or turn off the main unit.

Notes

- When placing or removing the iPod, handle the iPod in the same angle as that of the iPod connector on the main unit and do not twist or sway the iPod to prevent connector damage.
- Do not carry the main unit with an iPod set on the connector. Doing so may cause a malfunction.
- When placing or removing the iPod, brace the main unit with one hand and take care not to press the controls of the iPod by mistake.
- Before disconnecting the iPod, pause playback.
- You cannot adjust the volume using the main unit.
- The volume level does not change even if adjusted on the iPod.
- The main unit is designed for iPod only. You cannot connect any other portable audio players.
- Depending on the iPod model you are using and its status, operations using the main unit and the sub units may not be accepted or the wrong operations may be performed.
- Sony cannot accept responsibility in the event that data recorded to iPod is lost or damaged when using an iPod with this S-AIR product.

Listening to the radio using the S-AIR connection

Using the main unit

- 1 Select the tuner channel.

When the S-AIR mode is set to "PARTY":

Press PARTY CH on the remote repeatedly until "FM" or "AM" appears in the display.

When the S-AIR mode is set to "MULTI SOURCE":

The tuner channel is internally activated. Go to step 2.

- 2 Select "FM" or "AM."

Press BAND repeatedly.

- 3 Perform automatic tuning.

Press and hold TUNING +/- on the remote (or TUNING/SELECT +/- on the unit) until the frequency indication changes and then release.

"AUTO" lights up in the display. Scanning stops automatically when a station is tuned in, and then "TUNED" and "ST" (for FM stereo programs only) appear.

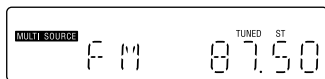

When you tune in a station that provides RDS services, the station name appears on the display.

Continued

Using the sub units

When a radio station is tuned on the main unit, you can listen to that station by following the steps below.

To tune in a radio station using the sub units, that station needs to be preset beforehand (see "To call up a preset radio station using the sub units" (page 27)).

- 1 Select the tuner channel.
Press S-AIR CH repeatedly until "TUNER" appears in the display.

- 2 Select "FM" or "AM."
Press and hold S-AIR CH until "FM" changes to "AM" or vice versa.

To tune in a station with a weak signal using the main unit

If "TUNED" does not appear and the scanning does not stop, press TUNING +/- on the remote (or TUNING/SELECT +/- on the unit) repeatedly to tune in the desired station.

To reduce static noise on a weak FM stereo station using the main unit

- 1 Press SYSTEM MENU on the unit.
- 2 Press TUNING/SELECT +/- on the unit repeatedly until "FM MODE" appears, then press ENTER on the unit.
- 3 Press TUNING/SELECT +/- on the unit repeatedly until "MONO" appears, then press ENTER on the unit.
There will be no stereo effect, but the reception will improve.

Presetting radio stations

You can preset your favorite radio stations and tune them in instantly by selecting the corresponding preset number.

Use the main unit to preset the radio stations.

- 1 Tune in the desired station.
See "Listening to the radio using the S-AIR connection" (page 25).
- 2 Press SYSTEM MENU on the unit.
- 3 Press TUNING/SELECT +/- on the unit repeatedly until "MEMORY" appears, then press ENTER on the unit.

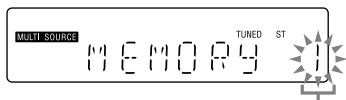

Preset number

- 4 Press TUNING/SELECT +/- on the unit repeatedly to select your desired preset number.
If another station is already assigned to the selected preset number, the station is replaced by the new stations.

- 5 Press ENTER on the unit.
- 6 Repeat steps 1 through 5 to store other stations.
You can preset up to 20 FM and 10 AM stations. The preset stations are retained for about half a day even if you disconnect the power supply cord or if a power failure occurs.

To call up a preset radio station using the main unit

Press PRESET +/- repeatedly.

To call up a preset radio station using the sub units

- 1 Preset radio stations on the main unit (see "Presetting radio stations" (page 26)).
- 2 Select the tuner channel.
Press S-AIR CH repeatedly until "TUNER" appears in the display.
- 3 Select "FM" or "AM."
Press and hold S-AIR CH until "FM" changes to "AM" or vice versa.
- 4 Press PRESET +/- repeatedly to select a preset station.

To check the frequency of the station name

Press DISPLAY on the remote for the main unit or DISPLAY on the sub unit while the station name is displayed. To return the station name indication, press DISPLAY while the frequency is displayed. The display on both the main unit and sub unit is switched if DISPLAY is pressed on either the main unit or sub unit.

Using an optional AV system

You can enjoy audio and video of the connected iPod with an optional AV system.

- 1 Connect an optional AV system (such as a TV, etc.) to the iPod AUDIO OUT L/R jacks and/or the iPod VIDEO OUT jack of the main unit using an optional audio cord and/or video cable.
- 2 Place an iPod on the iPod connector on the main unit.
- 3 Start playback of the iPod.
See "Listening to iPod music using the S-AIR connection" (page 23).

Note

- The tuner's sound cannot be output through the iPod AUDIO OUT L/R jacks.
- Before enjoying video, adjust the video settings on the iPod to the appropriate settings according to your situation.

Tip

Even if you change the S-AIR mode or the S-AIR channel using PARTY CH, audio and/or video from the connected iPod will continue to be output from the iPod AUDIO L/R jacks and/or the iPod VIDEO OUT jack.

Changing the display

Using the main unit

To view the information on the display

Press DISPLAY on the remote.

Using the sub units

To change the information on the display while the sub unit is on

Press DISPLAY on the unit. Each time you press the button, the display changes as follows:

When the sub unit is connected to the main unit:

Information of the connected main unit¹⁾

→ Model name of the connected main unit²⁾ → Clock²⁾ → ...

When the sub unit is not connected to the main unit:

“S-AIR” → “UNLINKED”²⁾ → Clock²⁾ → ...

¹⁾ Depending on the iPod model you are using, up to 16 characters of the following information can be viewed, for example, while playing the iPod.

- Track name
- Artist name
- Album name
- Elapsed playing time of the track

Characters that cannot be displayed appear as “_”.

When listening to the radio, the frequency or the station name is displayed.

²⁾ Displayed for about 8 seconds.

To turn off the display of the sub unit

When the sub unit is turned off, the clock is displayed. You can turn off the clock display to minimize the amount of power consumed (Power Saving Mode).

Press DISPLAY on the unit when the clock is displayed.

Press the button again to display the clock.

Note

Regardless of the selected S-AIR mode, when the same S-AIR channel is selected on multiple sub units and you change the display of any one of them, the display on all sub units will change (only when the information of the connected main unit is displayed).

Using the Timers

The sub units offer two timer functions. If you use the Daily Timer with the Sleep Timer, the Sleep Timer has priority. Use buttons on the unit to set the timers.

Sleep Timer:

You can fall asleep to music. This function works even if the clock is not set.

Press SLEEP repeatedly.

Note

Even if you set the timer, no sound is output from the sub units if playback on the connected main unit ends within the set time period or if communication with the main unit is cut off.

Daily Timer:

You can wake up to the sound of the connected main unit at a preset time. Make sure you have set the clock.

- 1 Press VOLUME +/- repeatedly to adjust the volume level while viewing the volume level indication on the display.
- 2 Press CLOCK/TIMER MENU.
- 3 Press I◀◀/▶▶I repeatedly to select "TIMER," then press CLOCK/TIMER ENTER. "ON TIME" appears, and the hour indication flashes.

- 4 Set the time to start playing. Press I◀◀/▶▶I repeatedly to set the hour, and then press CLOCK/TIMER ENTER. The minute indication flashes. Use the procedure above to set the minute.
- 5 Use the same procedure as in step 4 to set the time to stop playing.
- 6 Press I◀◀/▶▶I repeatedly to select the desired option. The default setting is underlined.

ALARM:

An alarm is output.

AUTO:

Sound from the connected main unit is output. However, an alarm sounds in the following cases.

- When communication with the main unit is cut off.
- When no sound is output from the main unit or the audio signal level is too low.
- When the main unit is not ready for playback at the set start time. Note that the alarm continues to sound even if the main unit becomes ready after the start time has passed.

- 7 Press CLOCK/TIMER ENTER. The display shows the timer settings.

Continued 

- 8** If you selected "ALARM" in step 6, go to step 9.
If you selected "AUTO" in step 6, prepare the sound source on the main unit.

iPod:

Select the track to be played back by the timer, and set the iPod to the pause mode.

Tuner:

Tune in the desired station (see "Listening to the radio using the S-AIR connection" (page 25) and "Presetting radio stations" (page 26)).

- 9** Press **I/⏸** to turn off the unit.
The sub unit turns on about 45 seconds before the preset time.
If the sub unit is on at the preset time, the Daily Timer will not play.

To stop the alarm

Press any button.

To activate or check the timer again

- 1 Press **CLOCK/TIMER MENU**.
"SELECT" flashes in the display.
- 2 Press **CLOCK/TIMER ENTER**.
- 3 Press **⏮/⏭** repeatedly to select "TIMER."
- 4 Press **CLOCK/TIMER ENTER**.

To cancel the timer

- 1 Press **CLOCK/TIMER MENU**.
"SELECT" flashes in the display.
- 2 Press **CLOCK/TIMER ENTER**.
- 3 Press **⏮/⏭** repeatedly to select "OFF."
- 4 Press **CLOCK/TIMER ENTER**.

To change the setting

Start over from step 1.

Note

Even when "AUTO" is selected in step 6 and the iPod is to be played using the timer, timer playback may not start and the iPod may be set to the pause mode if the iPod was being played by another sub unit when the timer started operating. In this case, press **▶** on the sub unit.

Tip

The Daily Timer setting remains as long as the setting is not canceled manually.

Turning off the remote control function of the sub units

When using the multiple sub units near each other, all the sub units may receive the same signal from the remote and the main unit may not function properly. To prevent this, you can turn off the remote control function of the sub units.

Use buttons on the sub unit whose remote control function you want to turn off.

- 1 Press **I/⏻** to turn off the unit.
- 2 Press **DISPLAY** repeatedly until the clock is displayed.
- 3 Press **I/⏻** while holding down **CLOCK/TIMER ENTER**.
“RMT OFF” appears in the display and the sub unit is turned on. If you try controlling the sub unit using the remote, “RMT OFF” appears in the display and the sub unit will not accept the signal from the remote.

To turn on the remote control function

Perform steps 1 and 3 above and check that “RMT ON” appears in the display.

Note

Even when the remote control function is turned off, **I/⏻** and **VOLUME +/-** on the remote will continue to function.

Changing the illumination brightness of the main unit

Press **ILLUMINATION** repeatedly. Each time you press the button, the illumination brightness changes as follows:

Bright → Darkened → Off

Troubleshooting

- 1 Make sure the power supply cord and the power cord are correctly and firmly connected.
- 2 Find your problem in the checklist below, and take the indicated corrective action.

If the issue persists, contact your nearest Sony dealer.
When bringing the product in for repairs, be sure to bring in the entire system (the main unit, the sub units and wireless transceivers).
This product is a system product, and the entire system is needed to determine the location requiring repair.

If "PROTECT" appears on the display of the main unit

Set the POWER switch on the rear panel to "OFF" to turn off the unit, and then unplug the power supply cord. After checking that there is no indication on the display, reconnect the power supply cord and set the POWER switch to "ON" to turn on the unit. If the issue persists, contact your nearest Sony dealer.

If the STANDBY indicator on the sub unit flashes

Immediately unplug the power cord, and check if anything is blocking the ventilation holes on the rear panel of the unit.

After the STANDBY indicator stops flashing, reconnect the power cord, and turn on the unit. If the issue persists, contact your nearest Sony dealer.

General

The remote does not function.

- Remove any obstacles between the remote and the remote sensor, and position the main unit and the sub units away from fluorescent lights.
- Point the remote at the remote sensor.
- Move the remote closer to the main unit or the sub units.
- The remote control function of the sub unit is off. Turn on the remote control function (page 31).
- Check whether you are using the remote for the main unit to operate the main unit and the remote for the sub unit to operate the sub unit.

The S-AIR indicators on the main unit and the sub units are turned off.

- Check that the power supply cord and the power cord are connected securely and the main unit and the sub units are turned on.
- Check that the supplied wireless transceivers are inserted securely to the main unit and the sub units (page 17).

Connecting the main unit and the sub units is not possible. (The S-AIR indicator on the main unit is turned off and/or the S-AIR indicator on the sub unit flashes.)

- Check that the supplied wireless transceivers are inserted securely to the main unit and the sub units (page 17).
- If you use another S-AIR main unit, place it more than 8 m away from the main unit.
- Confirm the S-AIR IDs of the main unit and the sub units.
- The main unit is paired with another S-AIR sub unit. Pair the main unit with the sub unit you are using.

- The main unit is paired with another S-AIR sub unit. Cancel pairing.
- Place so that the main unit and the sub units are separated from other wireless devices.
- Stop using any other wireless devices.
- The main unit or the sub unit is turned off. Make sure the power supply cord and the power cord are connected and turn on the main unit and the sub units.

The S-AIR channel fails to change.

- Check that the main unit and the sub units are connected properly.
- If you are using an optional S-AIR sub unit (such as the AIR-SA10) which is not compatible with the MULTI SOURCE mode, set the main unit to the PARTY mode.

There is no sound.

- If you use another S-AIR main unit, place it more than 8 m away from the main unit.
- Confirm the S-AIR IDs of the main unit and the sub units.
- Check the pairing setting.
- Place so that the main unit and the sub units are closer.
- Stop using any equipment that generates electromagnetic energy such as a microwave oven.
- Place so that the main unit and the sub units are separated from other wireless devices.
- Stop using any other wireless devices.
- Change the S-AIR ID settings of the main unit and the sub units.
- Turn off the main unit and the sub units and then turn them on again.

- Check that the power supply cord and the power cord are connected securely and the main unit and the sub units are turned on.
- Increase the volume of the sub units.
- Check that headphones are not connected to the  (headphones) jack on the rear panel of the sub units.
- Change the RF CHANGE setting on the main unit (page 20).

There is noise or the sound skips.

- If you use another S-AIR main unit, place it more than 8 m away from the main unit.
- Place so that the main unit and the sub units are closer.
- Stop using any equipment that generates electromagnetic energy such as a microwave oven.
- Place so that the main unit and the sub units are separated from other wireless devices.
- Stop using any other wireless devices.
- Change the S-AIR ID settings of the main unit and the sub units.
- Do not place a mobile phone near the main unit and the sub units, as this may result in noise.
- Change the RF CHANGE setting on the main unit (page 20).

Continued 

iPod

There is no sound.

- Make sure the iPod is connected securely.
- Make sure the iPod is playing music.
- Adjust the volume of the sub units.
- Update your iPod to use the latest software.

The iPod cannot be operated by the main unit or the sub units.

- Check that the iPod and the main unit are connected properly and that the main unit and the sub units are connected properly.
- Depending on the iPod model you are using and its status, it may not be possible to operate the iPod using the main unit or the sub units.
- Update your iPod to use the latest software.

The sound is distorted.

- Turn down the volume of the sub units.
- Set the "EQ" setting of the iPod to "Off" or "Flat."

The iPod cannot be charged.

- Make sure the iPod is connected securely.
- Check that the power supply cord is connected securely and the main unit is turned on.

The iPod track information cannot be obtained.

- Depending on the iPod model you are using and its status, it may not be possible to obtain the track information properly during playback.
- Up to 16 characters can be displayed on the displays of the sub units.
- Check that the track information has been entered into the iPod.

Video/Photo image from the connected iPod does not appear on the TV screen.

- Make the connection according to your AV system.
- Switch the TV input to the video input connected to the main unit.
- Check that the TV output setting on the iPod is on (Refer to the user's guide of your iPod).
- Check that the iPod is compatible with video output (Refer to the user's guide of your iPod).

Tuner

Severe hum or noise, or stations cannot be received. ("TUNED" or "ST" flashes on the display of the main unit.)

- Connect the antennas properly.
- Find a location and an orientation that provide good reception, and then set up the antennas again.
- Keep the antennas away from the power supply cord to avoid picking up noise.
- Connect a commercially available external antenna.
- Consult your nearest Sony dealer if the supplied AM antenna has come off the plastic stand.
- Turn off nearby electrical equipment.

To reset the main unit to factory settings

If the main unit still does not operate properly, reset the main unit to factory settings.

- 1 Disconnect and reconnect the power supply cord, and then turn on the unit.
- 2 Press SYSTEM MENU on the unit.
- 3 Press TUNING/SELECT +/- on the unit repeatedly until "RESET" appears, then press ENTER on the unit. "RESET OK" appears.
- 4 Press ENTER on the unit again to confirm the setting.
All user-configured settings are deleted, such as preset radio stations.

To reset the sub unit to factory settings

If the sub unit still does not operate properly, reset the sub unit to factory settings.

- 1 Disconnect and reconnect the power cord, and then turn on the unit.
- 2 Press ■/CANCEL, DISPLAY and I/⏻ on the unit at the same time.
All user-configured settings, such as timer, clock, etc. are deleted.

Messages

CANCEL : Time out without pairing.

COMPLETE : Pairing is completed.

ID A : Sets the S-AIR ID to "A."

ID B : Sets the S-AIR ID to "B."

ID C : Sets the S-AIR ID to "C."

LINKED* : The sub unit is connected to the main unit.

PAIRING : Pairing is in progress.

RMT OFF* : The sub units are not accepting signals from the remote because the remote control function is set to "RMT OFF"

S-AIR* : Displayed from the point power of the sub unit is turned on until connection with the main unit is established.

TIME NG* : The Daily Timer start and end times are set to the same time.

UNLINKED* : The connection with the main unit is cut off.

* Displayed on the sub units only.

Precautions

Notes on use of the S-AIR product

- As the S-AIR product transmits sound by radio waves, sound may skip when radio waves are obstructed. This is a characteristic of radio waves and is not a malfunction.
- As the S-AIR product transmits sound by radio waves, equipment that generates electromagnetic energy, such as a microwave oven, may interfere with sound transmission.
- As the S-AIR product uses the radio waves that share the same frequency as other wireless systems, such as wireless LAN or Bluetooth devices, interference or poor transmission may result. In this case, take the following steps:
 - Do not install the S-AIR product near other wireless systems.
 - Do not use the S-AIR product and the other wireless systems at the same time.
- The transmission distance differs depending on the usage environment. Find a location where transmission between the main unit and the sub units is most effective, and install the main unit and the sub units there.

On safety

- Completely disconnect the power supply cord and the power cord from the wall socket (mains) if the main unit and the sub units are not going to be used for an extended period of time. When unplugging the units, always grip the plug. Never pull the cord itself.
- Should any solid object or liquid get into the main unit and the sub units, unplug the units, and have them checked by qualified personnel before operating them again.
- The power supply cord and the power cord can be changed only by a qualified service facility.

On placement

- Do not place the main unit and the sub units in an inclined position or in locations that are extremely hot, cold, dusty, dirty, or humid or lacking adequate ventilation, or subject to vibration, direct sunlight or a bright light.
- Be careful when placing the main unit and the sub units on surfaces that have been specially treated (for example, with wax, oil, polish) as staining or discoloration of the surface may result.

On heat buildup

- Heat buildup on the main unit and the sub units during operation is normal and is not cause for alarm.
- Do not touch the cabinet if it has been used continuously at a high volume because the cabinet may have become hot.*
- Do not obstruct the ventilation holes.*

* The sub units only.

On the speaker system*

This speaker system is not magnetically shielded, and the picture on nearby TV sets may become magnetically distorted. In this situation, turn off the TV, wait about 15 to 30 minutes, and turn it back on.

If there is no improvement, move the unit far away from the TV.

* The sub units only.

Cleaning the cabinet

Clean the cabinet with a soft dry cloth.

Do not use any type of abrasive pad, scouring powder, or solvent, such as thinner, benzene, or alcohol.

Specifications

Main unit (AIR-SA15Ti)

Output

AUDIO OUT:

voltage 775 mV, impedance

47 kilohms

VIDEO OUT:

Max. output level 1 Vp-p, unbalanced,

Sync. negative, load impedance

75 ohms (Composite Video Out)

Wireless transceiver (EZW-RT10/EZW-RT10A)

Communication System:

S-AIR Specification version 1.0

Frequency band:

2.4000 GHz — 2.4835 GHz

Modulation method:

DSSS

Power requirements:

DC 3.3 V, 350 mA

Dimensions (w/h/d):

50 × 13 × 60 mm

Mass:

24 g

Tuner section

FM stereo, FM/AM superheterodyne tuner

FM tuner section:

Tuning range:

87.5 — 108.0 MHz (50 kHz step)

Antenna:

FM lead antenna

Antenna terminals:

75 ohms unbalanced

Intermediate frequency:

10.7 MHz

AM tuner section:

Tuning range:

531 — 1,602 kHz (9 kHz step)

Antenna:

AM loop antenna, external antenna terminal

Intermediate frequency:

450 kHz

General

Power requirements:

230 V AC, 50/60 Hz

Power consumption:

15 watts

Dimensions (w/h/d) (excluding the AC power supply unit):

Approx. 295 × 43 × 110 mm

Mass (including the AC power supply unit):

Approx. 1.1 kg

Sub unit (AIR-SA15R)

Amplifier section

DIN power output (rated):
3 + 3 watts (3 ohms at 1 kHz, DIN)
Continuous RMS power output (reference):
4 + 4 watts (3 ohms at 1 kHz, 10% THD)

Output

🎧 (stereo mini jack):
Accepts headphones with an impedance of 8 ohms or more

Speaker section

Speaker system:
Full range, bass-reflex type
Speaker units:
65 mm, cone type (2)
Nominal impedance:
3 ohms

Wireless transceiver (EZW-RT10/EZW-RT10A)

Communication System:
S-AIR Specification version 1.0
Frequency band:
2.4000 GHz — 2.4835 GHz
Modulation method:
DSSS
Power requirements:
DC 3.3 V, 350 mA
Dimensions (w/h/d):
50 × 13 × 60 mm
Mass:
24 g

General

Power requirements:
230 V AC, 50/60 Hz
Power consumption:
15 watts
Standby power consumption:
Max. 1 watt
Dimensions (w/h/d):
Approx. 300 × 136 × 115 mm
Mass:
Approx. 2.2 kg

Design and specifications are subject to change without notice.

Halogenated flame retardants are not used in the certain printed wiring boards.

Compatible iPod models

You can use the following iPod models on the main unit. Update your iPod with the latest software before using it.



iPod touch 2nd generation



iPod nano 4th generation (video)



iPod touch 1st generation



iPod nano 3rd generation (video)



iPod classic



iPod nano 2nd generation (aluminum)



iPod 5th generation (video)



iPod nano 1st generation



iPod 4th generation (color display)



iPod 4th generation



iPod mini

Index

A

Alarm 29
Antennas 17
Automatic tuning 25

B

Batteries 18

C

Clock 21
Compatible iPod 40

I

Illumination 31
Installation 6
iPod
 Charging 25
 Controlling 24
 Listening 23
iPod AUDIO OUT L/R 27
iPod Dock Adapters 17
iPod VIDEO OUT 27

M

Main unit 8
MULTI SOURCE mode 22

O

Other component hookup 27

P

Pairing 19
PARTY mode 22
Power Saving Mode 28
Presetting radio stations 26

R

Radio 25
Remote 9, 13, 31
Reset 35
RF CHANGE 20

S

S-AIR 6
S-AIR connection 18
S-AIR ID 17, 18
S-AIR mode 22
Sub unit 12

T

Timer
 Daily Timer 29
 Sleep Timer 29
Troubleshooting 32

W

Wireless transceiver 17

Free Manuals Download Website

<http://myh66.com>

<http://usermanuals.us>

<http://www.somanuals.com>

<http://www.4manuals.cc>

<http://www.manual-lib.com>

<http://www.404manual.com>

<http://www.luxmanual.com>

<http://aubethermostatmanual.com>

Golf course search by state

<http://golfingnear.com>

Email search by domain

<http://emailbydomain.com>

Auto manuals search

<http://auto.somanuals.com>

TV manuals search

<http://tv.somanuals.com>