



4-253-595-11(1)

The player

Portable USB Memory Player

Operating Instructions

pavit

AZ-ES1/ES128/ES256

©2004 Sony Corporation

Download from [Www.Somanuals.com](http://www.somanuals.com). All Manuals Search And Download.

WARNING

To prevent fire or shock hazard, do not expose the unit to rain or moisture.

Do not install the appliance in a confined space, such as a bookcase or built-in cabinet.

To prevent fire, do not cover the ventilation of the apparatus with news papers, table cloths, curtains, etc. And don't place lighted candles on the apparatus.

To prevent fire or shock hazard, do not place objects filled with liquids, such as vases, on the apparatus.

Warning

Certain countries may regulate disposal of the battery used to power this product. Please consult with your local authority.

The validity of the CE marking is restricted to only those countries where it is legally enforced, mainly in the countries EEA (European Economic Area).

Table of Contents

Overview

What you can do with your player	4
Main features	5

Getting started

Step 1: Check the package contents.	6
Step 2: Insert a battery.	7
Locating controls	8

Basic operations

Listening to music	9
1. Connect the headphones.	9
2. Put on the headphones.	10
3. Insert the “pavit” into the player.	11
4. Start playback.	11

► Advanced operations

Changing the sound quality (M.D.S.E)	14
Playing a track repeatedly (REP 1) / Playing all tracks in random order (SHUF)	14
Locking the controls (HOLD)	15
Turning off the beep sounds (BEEP)	15

► Additional information

Precautions	16
Cleaning	16
Troubleshooting	17
Specifications	19
Index	Back cover

What you can do with your player

AZ-ES1/ES128/ES256 is a portable USB memory player specially designed for use with a USB storage media called “pavit.” You can send MP3 files from your computer to the “pavit,” insert the “pavit” into the player, and carry your favorite songs anywhere.

1 Send your favorite songs to the “pavit.”

Use the supplied “Music Transfer pavit Edition” software to send MP3 files from your computer to the “pavit.”



2 Enjoy music anywhere with your player!



What is “pavit”?

The “pavit” is a compact, lightweight, new-generation USB storage media* with a large storage capacity. Although the “pavit” is dedicated to “pavit”-compatible devices, it can also be used as an external storage media for your computer, since it connects directly to the USB port, a standard interface for personal computers.

* Storage media is a device that can store data, such as floppy disk, hard disk and magneto-optic disk (MO).

The “pavit” complies with USB2.0 (High-Speed USB).

Main features

- Compact size, lightweight, highly portable, with skip-proof operation
 - Up to 120 minutes of music can be stored in a 128-MB “pavit” and 240 minutes in a 256-MB “pavit.”*
 - MP3 files on your computer are sent to the “pavit” by simple and easy operations using the supplied “Music Transfer pavit Edition” software.
 - The “pavit” connects directly to the USB port on your computer for high-speed data transfer.
 - You can also store a variety of data other than MP3 files in the new-generation USB storage media “pavit.”
- * The time length varies according to the bit rate used when encoding MP3 files. The times indicated here are for 128-kbps MP3 files.

Notes

- Music you record is limited to private use only. Any other use requires the permission of the copyright holders.
- Sony is not liable for incomplete data transfer or damaged data due to problems of this product or your computer.

Getting started

Step 1: Check the package contents.

Check the accessories enclosed in the package.

- Portable USB memory player (1)



- USB storage media “pavit”* (1)

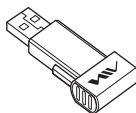

- Stereo headphones (1)



- CD-ROM (“Music Transfer pavit Edition”) (1)

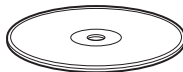

- Headphone extension cord (1)
- Neck strap (1)
- Operating instructions for the application software “Music Transfer pavit Edition” (1)
- Quick start guide (1)

* Supplied with AZ-ES128 and AZ-ES256 only. For AZ-ES1, see “Optional accessories” on page 19.

Step 2: Insert a battery.

Insert one LR03 (size AAA) alkaline battery into the battery compartment as illustrated below.

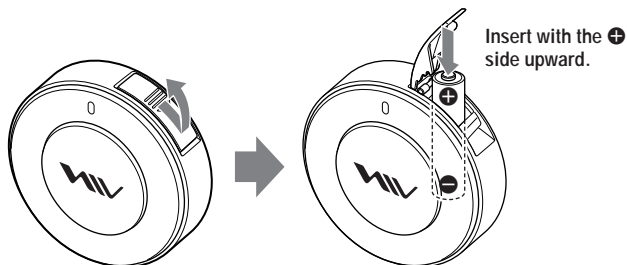

Battery duration

Approximately 11 hours (continuous playback, with a Sony LR03 (size AAA) alkaline battery)

When the battery is drained, playback stops and the power is turned off automatically. If you try to turn on the power in this state, the LED indicator will not light up and you cannot start playback.

Replace the battery with a new one.

When you turn on the power after replacing the battery, playback starts from the track whose playback was interrupted by battery drain.

To remove the battery

Turn the player upside down and push the battery inward a little to draw out the battery.

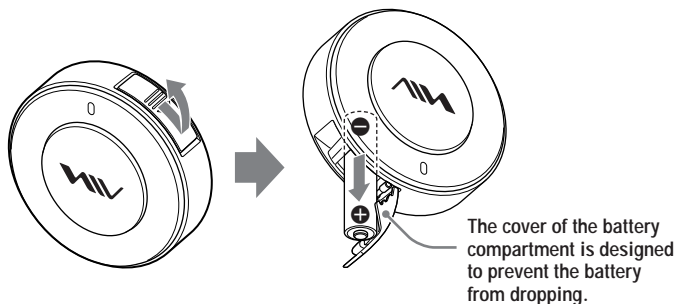

Notes on dry batteries

- Do not throw batteries into fire.
- Do not carry batteries with coins or other metallic objects. It can generate heat if the positive and negative terminals of the battery are accidentally contacted by a metallic object.
- When the player is not to be used for a long time, remove the battery.
- If battery leakage occurs, wipe off any deposit in the battery compartment, and insert a new battery. In case the deposit adheres to you, wash it off thoroughly.

Locating controls

Player (front/side)

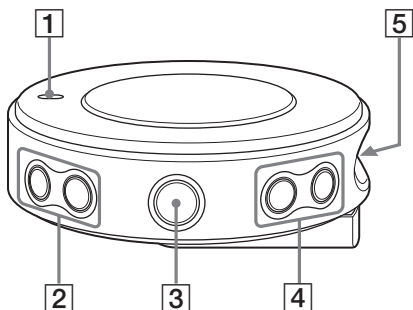

- 1** LED indicator
- 2** VOLUME $-/+$ * buttons
- 3** $\blacktriangleright \blacksquare$ * (play/stop) button
- 4** $\blacktriangleleft / \blacktriangleright$ (skip) buttons
- 5** "pavit" slot

* The button has a tactile dot.

Player (rear)

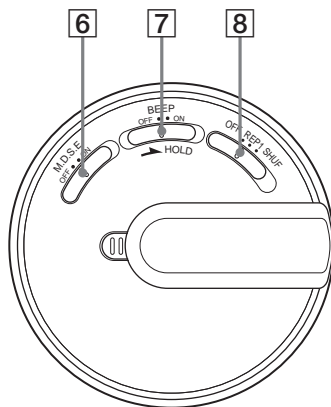

- 6** M.D.S.E (MP3 Digital Sound Enhancer) switch
- 7** HOLD/BEEP switch
- 8** REP 1 (repeat 1)/SHUF (shuffle) switch

Listening to music

First, send MP3 files to the “pavit” from your computer using the supplied “Music Transfer pavit Edition” software. Refer to the separate manual for “Music Transfer pavit Edition” about how to send MP3 files to the “pavit.”

1. Connect the headphones.

1 Remove the plug cover from the player.

While pressing the latch ①, slide and lift the plug cover ②.

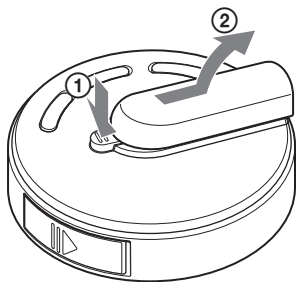

2 Pass the headphone cord through the notch in the plug cover.

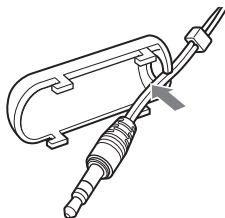

3 Connect the headphone plug to the (headphones) jack, and reattach the plug cover to the player.

Slide the plug cover so that it clicks into place securely.

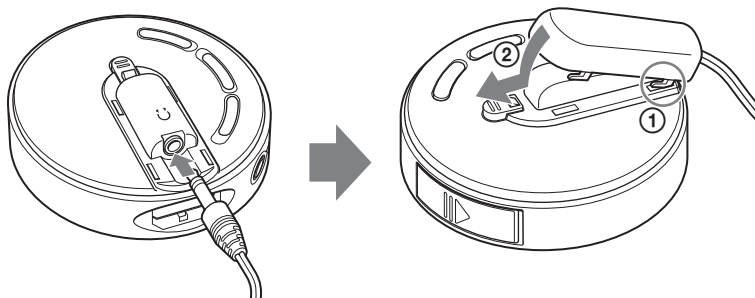

(Continued)

2. Put on the headphones.

You can hang the player from your neck with the supplied neck strap.
To use the player while carrying it in a pocket or bag, connect the supplied headphone extension cord (see page 13).

- 1** Fold one end of the supplied neck strap as illustrated to secure the headphone cord.

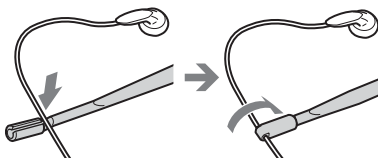

- 2** Place the strap around your neck, then fold the other end of the neck strap to secure the headphone cord.

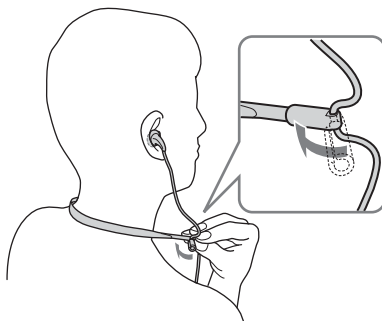
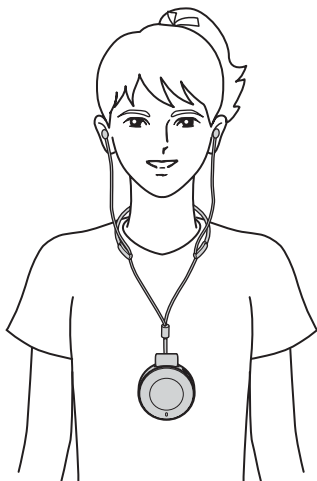

Note

Hold the folded-over end of the neck strap when adjusting the length of the headphone cord.

3. Insert the "pavit" into the player.

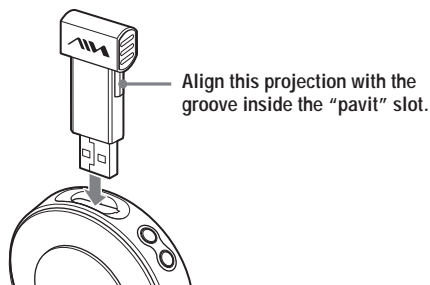

4. Start playback.

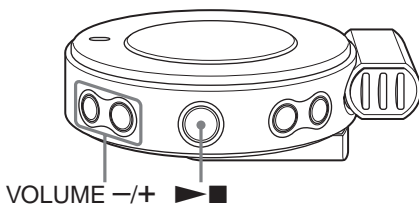

1 Press and hold ►■.

The power is turned on, a short beep is heard in the headphones (when the HOLD/BEEP switch is set to BEEP ON), and playback starts.

2 Press VOLUME -/+ to adjust the volume.

Audio files (tracks) are played in the order of the Playlist created by the "Music Transfer pavit Edition" software.

During play mode, the LED indicator slowly flashes in green.

Playback stops after the last track has been played.

(Continued)

Other operations

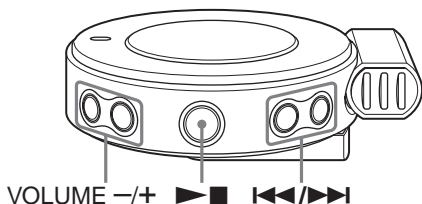

To	Do this
Go to the beginning of the next track	Press ▶▶.*1
Go to the beginning of the current track	Press ■.
Go to the beginning of previous tracks	Press ◀◀ repeatedly.*1 To quickly locate the desired track, press and hold ◀◀ until you find it.*2
Go to the beginning of succeeding tracks	Press ▶▶ repeatedly.*1 To quickly locate the desired track, press and hold ▶▶ until you find it.*2
Adjust the volume	Press VOLUME -/+. Press and hold VOLUME -/+ to quickly turn up or down the volume.
Stop playback	Press ■.*3
Turn off the power	Press and hold ▶■.

*1 A short beep sounds for each track. When the first track is reached, the player emits a different beep sound.

*2 While holding down the button, a short beep sounds for each track. When the first track is reached, the player emits a different beep sound and playback of the first track will start.

*3 The power is automatically turned off if the player is not operated for about 10 seconds while playback is stopped.

If playback does not start

Make sure that the HOLD/BEEP switch is slid in the direction opposite to the arrow (see page 15).

To remove the “pavit”

Always turn off the power before you remove the “pavit.” The audio data or the “pavit” itself might be destructed if you remove the “pavit” with the player’s power turned on.

Tip

Playback starts from the position where it was last stopped.

To start playback from the first track, press ◀◀ or ▶▶ repeatedly, or press and hold ◀◀ or ▶▶ to return to the first track.

Playback will also start from the first track when:

- you remove the “pavit” and insert a different “pavit.”
- you reset the player.

Using the headphone extension cord

The headphone extension cord makes it easy to use the player while carrying it in your pocket or bag.

- 1 Remove the plug cover from the player.

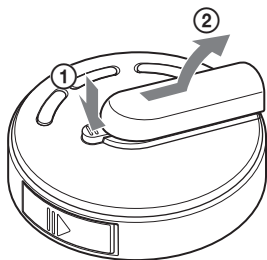

- 2 Connect the plug of the headphone extension cord to the  (headphones) jack on the player.

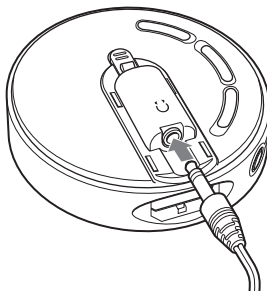

- 3 Connect the headphone plug to the headphone extension cord.

Notes

- The plug cover cannot be attached to the player when using the extension cord. Keep the plug cover in a safe place so that you will not lose it.
- To prevent the wire from breaking, do not pull on the headphone cord when you connect or disconnect the headphones, or when attaching or detaching the plug cover. Also, do not hang the player from your neck when the headphone extension cord is connected.

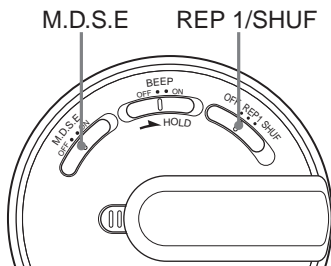

Changing the sound quality (M.D.S.E)

The M.D.S.E (MP3 Digital Sound Enhancer) allows you to enjoy clear digital sound and a resonant bass.

Set the M.D.S.E switch to ON.

To return to the normal sound

Set the M.D.S.E switch to OFF.

Playing a track repeatedly (REP 1) / Playing all tracks in random order (SHUF)

To	Set the REP 1/ SHUF switch to
Play the current track repeatedly* ¹	REP 1
Play all tracks in random order* ²	SHUF

*¹ After the track has been played 10 times repeatedly, playback stops.

*² Playback stops when all the tracks in the "pavit" have been played.

To return to the normal play mode

Set the REP 1/SHUF switch to OFF.

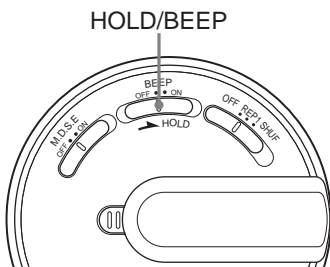

Locking the controls (HOLD)

When carrying the player in a bag, the HOLD function can be used to prevent accidental pressing of the buttons.

Slide the HOLD/BEEP switch in the direction of the arrow.

A yellow mark behind the switch becomes visible, and all operation buttons except for the switches on the rear side are disabled.

To release the HOLD function

Slide the HOLD/BEEP switch in the direction opposite to the arrow.

Turning off the beep sounds (BEEP)

Set the HOLD/BEEP switch to BEEP OFF.

To turn on the beep sounds

Set the HOLD/BEEP switch to BEEP ON. It is recommended you set the HOLD/BEEP switch to BEEP ON, as many operations can be confirmed by beep sounds.

Precautions

General

Never place the player in a place:

- under direct sunlight or near heat sources
- in a car with its windows closed (especially in summer)
- where it will be subjected to excessive moisture such as in a bathroom
- where there is much dust
- near magnets or magnetized items such as speakers or TV

Headphones

Road Safety

Do not use headphones while driving, cycling, or operating any motorized vehicle. It may create a traffic hazard and is illegal in many areas. It can also be potentially dangerous to play your player at a high volume while walking, especially at pedestrian crossings. You should exercise extreme caution or discontinue use in potentially hazardous situations.

Preventing hearing damage

Avoid using the headphones at a high volume. Hearing experts advise against continuous, loud and extended play. If you experience a ringing in your ears, reduce the volume or discontinue use.

Consideration for others

Keep the volume at a moderate level. This will allow you to hear outside sounds and to be considerate to the people around you.

Warning

If there is lightning when you are using your player, take off the headphones immediately.

In case of failure of this player, consult your Aiwa dealer without opening the casing. If failure occurs while the “pavit” is inserted in the player, it is recommended not to remove the “pavit” from the player to ensure an early solution to the problem.

Cleaning

Clean your player’s casing with a soft cloth slightly moistened with water or a mild detergent solution.

Note

Do not use any type of abrasive pad, scouring powder or solvent such as alcohol or benzene as it may mar the finish of the casing.

Cleaning the headphone plug

If the headphone plug is dirty, it may cause noise or sound skipping. To ensure good sound quality, clean the headphone plug periodically with a soft, dry cloth.

If you have any questions or problems concerning your player, please consult your nearest Aiwa dealer.

Troubleshooting

If you experience any of the following difficulties while using your player, use this troubleshooting guide to help you to remedy the problem. Should any problem persist, consult your nearest Aiwa dealer.

For trouble concerning operations while connected to your computer, also refer to “Troubleshooting” in the separate manual for the “Music Transfer pavit Edition” software.

Operation

Symptom	Cause/Remedy
There is no sound.	<ul style="list-style-type: none">→ The volume level is set to the minimum level. Increase the volume (page 11).→ The headphone plug is not connected properly. Connect the headphone plug properly.→ The headphone plug is dirty. Clean the headphone plug with a soft dry cloth.
The buttons do not work.	<ul style="list-style-type: none">→ The HOLD function is activated. Release the HOLD function (page 15).→ The player contains moisture condensation. Let your player sit for a few hours.→ The battery is exhausted. Replace the battery with a new one (page 7).
The volume will not increase.	<ul style="list-style-type: none">→ The HOLD function is activated. Release the HOLD function (page 15).
The sound is distorted.	<ul style="list-style-type: none">→ The bit rate used when encoding the MP3 files was low. Transfer MP3 files encoded with higher bit rates to the “pavit.”
There is no sound output from the right headphone.	<ul style="list-style-type: none">→ The headphone plug is not fully connected. Connect the headphone plug fully.
Playback stops suddenly.	<ul style="list-style-type: none">→ The battery is exhausted. Replace the battery with a new one (page 7).
There is noise in the playback sound.	<ul style="list-style-type: none">→ The audio data itself contains noise. Noise may have been introduced when creating audio data due to the conditions of the computer. Create the audio data again.
The LED indicator flashes red even though the battery has just been replaced.	<ul style="list-style-type: none">→ The player is not functioning normally. Remove the “pavit” from the player and hold down  for more than 5 seconds to reset the player.→ Send the audio data to the “pavit” again, as the data stored in the “pavit” may have been destructed.

(Continued)

Battery

Symptom	Cause/Remedy
Battery life is short.	→ The operating temperature is below 0°C (32°F). Battery life becomes shorter in cold temperatures due to battery characteristics. This is not a malfunction.

Other

Symptom	Cause/Remedy
The "pavit" cannot be inserted into the player.	→ The "pavit" is being inserted backwards. Insert the "pavit" in the correct orientation.
The player gets warm.	→ The player gets warm if it is used for an extended period of time. This is not a malfunction.
The "pavit" which has been used on another device does not work.	→ The "pavit" has been formatted on a computer or another device. Make a backup copy of any important data in the "pavit," such as by copying it to the hard disk of your computer. Then reformat the "pavit," using the supplied "Music Transfer pavit Edition" software. As Music Transfer pavit Edition is not compatible with FAT32 file systems, reformat the "pavit" with FAT or FAT16 format.

Specifications

Supported audio file format

MP3 Bit rate: 8 - 320 kbps*

Sampling frequencies: 24/22.05/16/12/
11.025/8/32/44.1/48 kHz

* 128 kbps or a higher bit rate is recommended.

Frequency response

20 - 20,000 Hz (single signal measurement)

Output

Headphones: Stereo mini-jack

Operating temperature

5°C - 35°C (41°F - 95°F)

Power source

One LR03 (size AAA) alkaline battery:
1.5 V DC × 1

Battery life

Approx. 11 hours with a Sony LR03 (size AAA)
alkaline battery

Dimensions

Approx. 65 × 65 × 17.8 mm

(2 ⁵/₈ × 2 ⁵/₈ × ²³/₃₂ in.)

(w/h/d, excluding projecting parts)

Approx. 65 × 75.1 × 28.8 mm

(2 ⁵/₈ × 3 × 1 ³/₁₆ in.)

(w/h/d, including projecting parts)

Mass

Approx. 50 g (1.8 oz) (including battery)

Accessories

See page 6.

Optional accessories

USB storage media "pavit"

AZ-RM128P: 128 MB

AZ-RM256P: 256 MB

Design and specifications are subject to change
without notice.

Index

A, B

Battery 7

Beep 15

C, D, E

Cleaning 16

F, G

Format 18

H, I, J, K

Headphones

connect 9

extension cord 13

precautions 16

HOLD 15

L

Listening 9

Locking the controls (HOLD function) 15

M

M.D.S.E (MP3 Digital Sound Enhancer) 14

MP3 4, 5

Music Transfer pavit Edition 4, 9

N, O

Neck strap 10

P, Q

“pavit” 4, 5

insert 11

remove 12

Playback 11

R

Repeat 14

Reset 17

S

Shuffle 14

Skip 12

Sound 14

T, U

Troubleshooting 17

V, W, X, Y, Z

Volume 11, 12

Free Manuals Download Website

<http://myh66.com>

<http://usermanuals.us>

<http://www.somanuals.com>

<http://www.4manuals.cc>

<http://www.manual-lib.com>

<http://www.404manual.com>

<http://www.luxmanual.com>

<http://aubethermostatmanual.com>

Golf course search by state

<http://golfingnear.com>

Email search by domain

<http://emailbydomain.com>

Auto manuals search

<http://auto.somanuals.com>

TV manuals search

<http://tv.somanuals.com>