



4-254-119-11(1)

The player

Portable USB Memory Player

Operating Instructions

pavit

AZ-HS1/HS128/HS256

©2004 Sony Corporation

Download from Www.Somanuals.com. All Manuals Search And Download.

WARNING

To prevent fire or shock hazard, do not expose the unit to rain or moisture.

To prevent fire, do not cover the ventilation of the apparatus with news papers, table cloths, curtains, etc. And don't place lighted candles on the apparatus.

Warning

Certain countries may regulate disposal of the battery used to power this product. Please consult with your local authority.

The validity of the CE marking is restricted to only those countries where it is legally enforced, mainly in the countries EEA (European Economic Area).

For the customers in the United States

Owner's Record

The model number and the serial number are located on the inner rim of the left ear side of the headphones, and the serial number is located in the battery compartment of the left ear side of the headphones. Record the serial number in the space provided below.

Refer to them whenever you call your Aiwa dealer regarding this product.

Model No.

Serial No. _____

NOTE

This equipment has been tested and found to comply with the limits for a Class B digital device, pursuant to Part 15 of the FCC Rules. These limits are designed to provide reasonable protection against harmful interference in a residential installation. This equipment generates, uses, and can radiate radio frequency energy and, if not installed and used in accordance with the instructions, may cause harmful interference to radio communications.

However, there is no guarantee that interference will not occur in a particular installation. If this equipment does cause harmful interference to radio or television reception, which can be determined by turning the equipment off and on, the user is encouraged to try to correct the interference using one or more of the following measures:

- Reorient or relocate the receiving antenna.
- Increase the separation between the equipment and receiver.
- Connect the equipment into an outlet on a circuit different from that to which the receiver is connected.
- Consult the dealer or an experienced radio/TV technician for help.

CAUTION

You are cautioned that any changes or modifications not expressly approved in this manual could void your authority to operate this equipment.

AZ-HS1: No "pavit" supplied

AZ-HS128: AZ-RM128 (a 128 MB "pavit") supplied

AZ-HS256: AZ-RM256 (a 256 MB "pavit") supplied

If you have any questions about this product, you may call;

Aiwa Customer Information Service Center

1-800-289-2492 or

<http://www.us.aiwa.com/>.

Declaration of Conformity

Trade Name: AIWA

Model: AZ-RM256P

AZ-RM128P

Responsible Party: Sony Electronics Inc.

Address: 16450 W. Bernardo Dr, San Diego, CA 92127 U.S.A.

Telephone Number: 858-942-2230

This device complies with Part 15 of the FCC Rules.

Operation is subject to the following two conditions:

(1) This device may not cause harmful interference, and (2) this device must accept any interference received, including interference that may cause undesired operation.

This device complies with Part 15 of the FCC Rules. Operation is subject to the following two conditions: (1) This device may not cause harmful interference, and (2) this device must accept any interference received, including interference that may cause undesired operation.

Before using this player, install the application software on your computer using the supplied CD-ROM, and send some music data to the player.

Table of Contents

Overview

What you can do with your player	4
Main features	5

Getting started

Step 1: Check the package contents	6
Step 2: Insert a battery	7
Locating controls	8

Basic operations

Listening to music	9
1. Put the player on your ears.	9
2. Insert the "pavit" into the player.	10
3. Start playback.	10

► Advanced operations

Changing the sound quality (M.D.S.E)	13
Playing a track repeatedly (REPEAT) / Playing all tracks in random order (SHUFFLE)	13
Locking the controls (HOLD)	14
Turning off the beep sounds (BEEP)	14
Using the player as stereo headphones	15

► Additional information

Precautions	16
Cleaning	16
Troubleshooting	17
Specifications	19
Index	Back cover

What you can do with your player

AZ-HS1/HS128/HS256 is a portable USB memory player specially designed for use with a USB storage media called “pavit.” You can send MP3 files from your computer to the “pavit,” insert the “pavit” into the player, and carry your favorite songs anywhere.

1 Send your favorite songs to the “pavit.”

Use the supplied “Music Transfer pavit Edition” software to send MP3 files from your computer to the “pavit.”



2 Enjoy music anywhere with your player!



What is “pavit”?

The “pavit” is a compact, lightweight, new-generation USB storage media* with a large storage capacity. Although the “pavit” is dedicated to “pavit”-compatible devices, it can also be used as an external storage media for your computer, since it connects directly to the USB port, a standard interface for personal computers.

* Storage media is a device that can store data, such as floppy disk, hard disk and magneto-optic disk (MO).

The “pavit” complies with USB2.0 (High-Speed USB).

Main features

- Headphone-style USB memory player
 - Highly portable with the player built into the headphones
 - Skip-proof operation
 - Up to 120 minutes of music can be stored in a 128-MB “pavit” and 240 minutes in a 256-MB “pavit.”*
 - MP3 files on your computer are sent to the “pavit” by simple and easy operations using the supplied “Music Transfer pavit Edition” software.
 - The “pavit” connects directly to the USB port on your computer for high-speed data transfer.
 - You can also store a variety of data other than MP3 files in the new-generation USB storage media “pavit.”
- * The time length varies according to the bit rate used when encoding MP3 files. The times indicated here are for 128-kbps MP3 files.

Notes

- Music you record is limited to private use only. Any other use requires the permission of the copyright holders.
- Sony is not liable for incomplete data transfer or damaged data due to problems of this product or your computer.

Step 1: Check the package contents

Check the accessories enclosed in the package.

- Portable USB memory player (1)



- CD-ROM* (“Music Transfer pavit Edition”) (1)



- USB storage media “pavit” (1)
(not supplied with AZ-HS1)



- Operating instructions for the application software “Music Transfer pavit Edition” (1)
- Quick start guide (1)

About the serial number

The serial number provided for your player is printed in the battery compartment of the left ear side of the headphones.

* Do not play the CD-ROM on an audio CD player.

Step 2: Insert a battery

The battery compartment is provided on the left ear side.

Insert one LR03 (size AAA) alkaline battery into the battery compartment as illustrated below.

Push and slide the ▽ part.

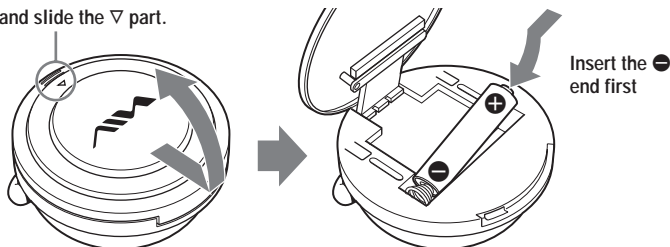

Battery duration

Approximately 11 hours (continuous playback, with a Sony LR03 (size AAA) alkaline battery)

When the battery is drained, playback stops and the power is turned off automatically.

Operations of the buttons and switches may also become disabled. Even if you try to turn on the power in this state, the LED indicator will not flash and you cannot start playback.

Replace the battery with a new one.

When you turn on the power after replacing the battery, playback starts from the track whose playback was interrupted by battery drain.

To remove the battery

Remove the battery as illustrated below.

Push and slide the ▽ part.

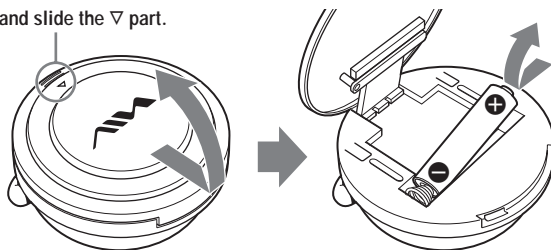

Notes on dry batteries

- Do not throw batteries into fire.
- Do not carry batteries with coins or other metallic objects. It can generate heat if the positive and negative terminals of the battery are accidentally contacted by a metallic object.
- When the player is not to be used for a long time, remove the battery.
- If battery leakage occurs, wipe off any deposit in the battery compartment, and insert a new battery. In case the deposit adheres to you, wash it off thoroughly.

Locating controls

Player (right ear side)

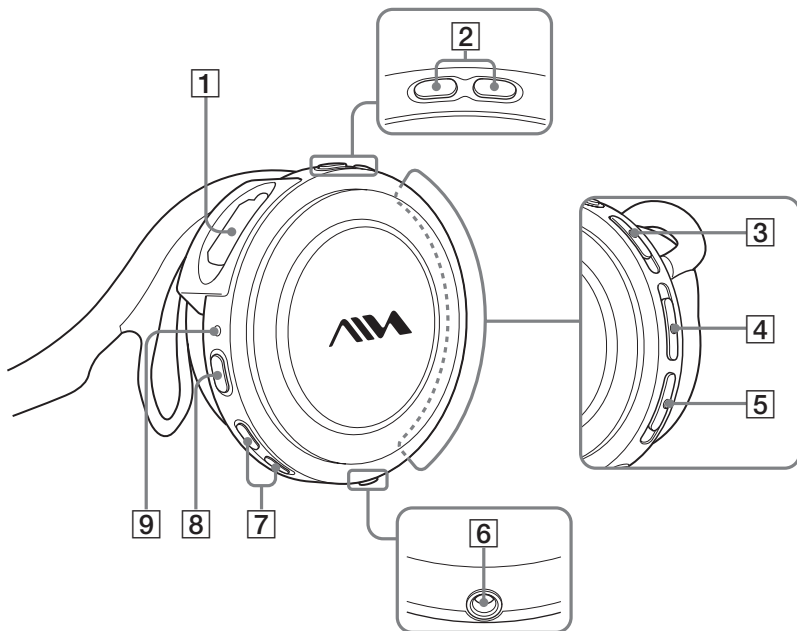

- 1** “pavit” slot
- 2** VOL -/+* buttons
- 3** REP1 (repeat)/SHUF (shuffle) switch
- 4** HOLD/BEEP switch
- 5** M.D.S.E (MP3 Digital Sound Enhancer) switch

- 6** INPUT jack
- 7** ◀◀ / ▶▶ (skip) buttons
- 8** ▶■ (play/stop)* button
- 9** LED indicator

* The button has a tactile dot.

Listening to music

First, send MP3 files to the “pavit” from your computer using the supplied “Music Transfer pavit Edition” software. Refer to the separate manual for “Music Transfer pavit Edition” about how to send MP3 files to the “pavit.”

1. Insert the “pavit” into the player.

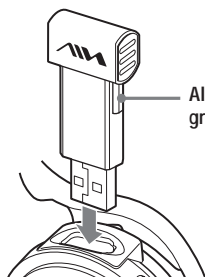

Align this projection with the groove inside the “pavit” slot.

2. Put the player on your ears.

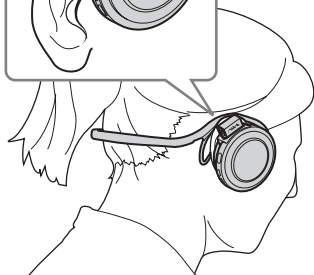

Note

Remove earrings before wearing the player to avoid injury.



(Continued)

3. Start playback.

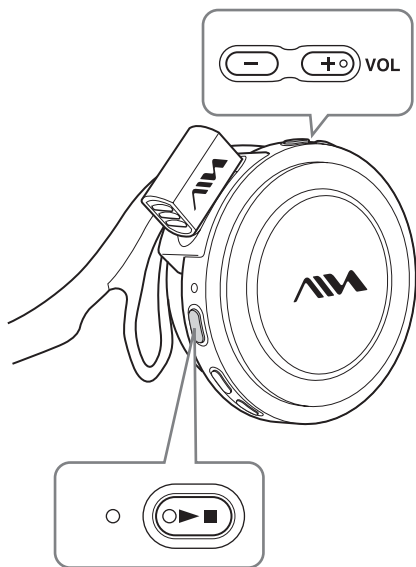

1 Press and hold ►■.

The power is turned on, a short beep is heard in the headphones (when the HOLD/BEEP switch is set to BEEP ON) and playback starts.

2 Press VOL -/+ to adjust the volume.

Audio files (tracks) are played in the order of the playlist created by the "Music Transfer pavit Edition" software.

During play mode, the LED indicator slowly flashes in green.

Playback stops after the last track has been played.

Other operations

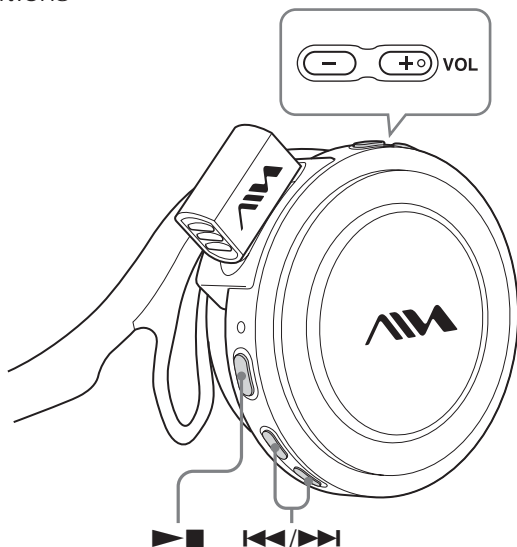

To	Do this
Go to the beginning of the next track	Press ►►.*1
Go to the beginning of the current track	Press ◀◀.
Go to the beginning of previous tracks	Press ◀◀ repeatedly.*1 To quickly locate the desired track, press and hold ◀◀ until you find it.*2
Go to the beginning of succeeding tracks	Press ►► repeatedly.*1 To quickly locate the desired track, press and hold ►► until you find it.*2
Adjust the volume	Press VOL -/+. Press and hold VOL -/+ to quickly turn up or down the volume.
Stop playback	Press ►■.*3
Turn off the power	Press and hold ►■.

*1 A short beep sounds for each track. When the first track is reached, the player emits a different beep sound.

*2 While holding down the button, a short beep sounds for each track. When the first track is reached, the player emits a different beep sound and playback of the first track will start.

*3 The power is automatically turned off if the player is not operated for about 10 seconds while playback is stopped.

(Continued)

If playback does not start

Make sure that the HOLD/BEEP switch is slid in the direction opposite to the arrow (see page 14).

To remove the “pavit”

Always turn off the power before you remove the “pavit.” The audio data or the “pavit” itself might be destructed if you remove the “pavit” with the player’s power turned on.

Tip

Playback starts from the position where it was last stopped.

To start playback from the first track, press and hold ◀◀ or ▶▶ to return to the first track.

Playback will also start from the first track when:

- you remove the “pavit” and insert a different “pavit.”
- you reset the player (see page 17).

How to fold the headphones

Fold the headphones as illustrated below.

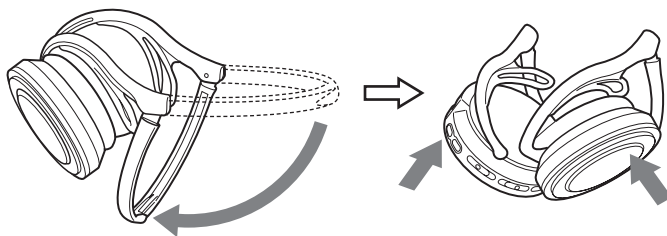

When you put the player in your bag or pocket to carry it, fold the player.

Moreover, when you are not to use the player for a long time, keep it folded.

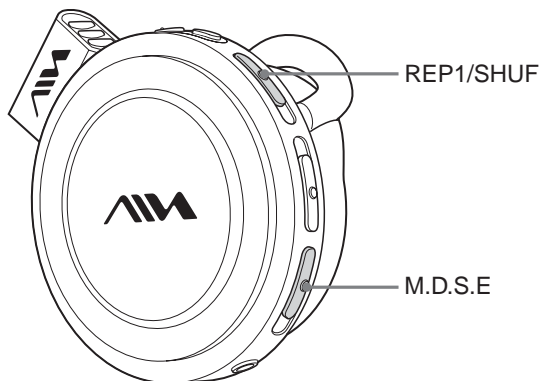

Changing the sound quality (M.D.S.E)

The M.D.S.E (MP3 Digital Sound Enhancer) allows you to enjoy clear digital sound and a resonant bass.

Set the M.D.S.E switch to ON.

Note

If the sound is distorted when using the M.D.S.E function, turn down the volume.

To return to the normal sound

Set the M.D.S.E switch to OFF.

Playing a track repeatedly (REPEAT) / Playing all tracks in random order (SHUFFLE)

To	Set the REP1/SHUF switch to
Play the current track repeatedly*1	REP1
Play all tracks in random order*2	SHUF

*1 After the track has been played 10 times repeatedly, playback stops.

*2 Playback stops when all the tracks in the "pavit" have been played.

To return to normal play mode

Set the REP1/SHUF switch to OFF.

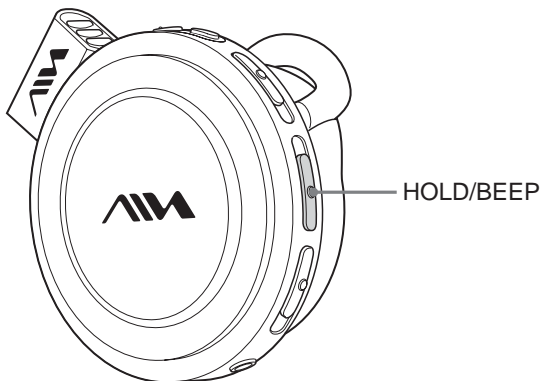

Locking the controls (HOLD)

When carrying the player in a bag, the HOLD function can be used to prevent accidental pressing of the buttons.

Set the HOLD/BEEP switch in the direction of the arrow.

A yellow mark behind the switch becomes visible, and all operation buttons except for the switches on the right ear side are disabled.

To release the HOLD function

Set the HOLD/BEEP switch in the direction opposite to that of the arrow.

Turning off the beep sounds (BEEP)

Set the HOLD/BEEP switch to BEEP OFF.

To turn on the beep sounds

Set the HOLD/BEEP switch to BEEP ON.

Note

It is recommended to set the HOLD/BEEP switch to BEEP ON, as many of your operations can be confirmed by beep sounds.

Using the player as stereo headphones

You can use the player as a pair of ordinary stereo headphones using an analog connection cord (not supplied).

When you use the player as stereo headphones, turn off the power of the player.

To prevent wrong operation, we recommend you use the player with the battery and “pavit” removed.

1 Connect the player to another audio device.

Connect an analog connection cord (not supplied) to the INPUT jack of the player and to the headphones jack of the other audio device.

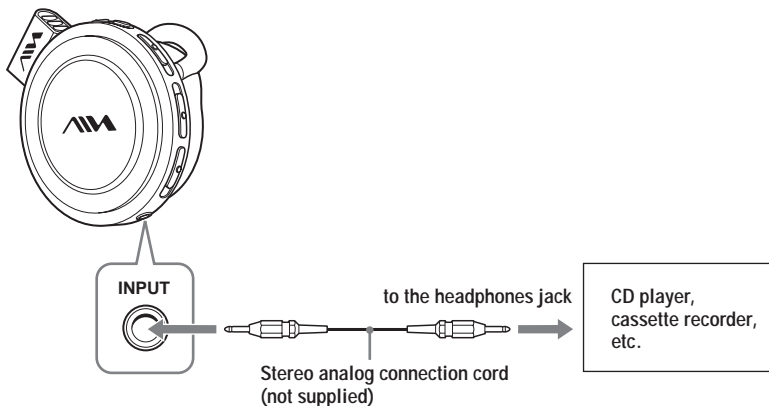

2 Start playback on the other audio device.

Adjust the volume on the connected audio device.

Notes

- Even if you press **▶■** on the player while using as headphones, the sound from the player (“pavit”) will not be heard.
- You cannot adjust the volume or change the sound quality on this player while using it as the ordinary headphones.

Precautions

General

Never place the player in a place:

- under direct sunlight or near heat sources
- in a car with its windows closed (especially in summer)
- where it will be subjected to excessive moisture such as in a bathroom
- where there is much dust
- near magnets or magnetized items such as speakers or TV

Road Safety

Do not use this player while driving, cycling, or operating any motorized vehicle. It may create a traffic hazard and is illegal in many areas. It can also be potentially dangerous to play your player at a high volume while walking, especially at pedestrian crossings. You should exercise extreme caution or discontinue use in potentially hazardous situations.

Preventing hearing damage

Avoid using this player at a high volume. Hearing experts advise against continuous, loud and extended play. If you experience a ringing in your ears, reduce the volume or discontinue use.

Consideration for others

Keep the volume at a moderate level. This will allow you to hear outside sounds and to be considerate to the people around you.

Warning

If there is lightning when you are using your player, take off the player from your ears immediately.

Battery

- When the battery is drained, remove the battery from the player.
- When the player is not to be used for a long time, remove the battery.

In case of failure of this player, consult your Aiwa dealer without opening the casing. If failure occurs while the “pavit” is inserted in the player, it is recommended not to remove the “pavit” from the player to ensure an early solution to the problem.

Cleaning

Clean your player’s casing with a soft cloth slightly moistened with water or a mild detergent solution.

Note

Do not use any type of abrasive pad, scouring powder or solvent such as alcohol or benzene as it may mar the finish of the casing.

If you have any questions or problems concerning your player, please consult your nearest Aiwa dealer.

Troubleshooting

If you experience any of the following difficulties while using your player, use this troubleshooting guide to help you to remedy the problem. Should any problem persist, consult your nearest Aiwa dealer.

For trouble concerning operations while connected to your computer, also refer to "Troubleshooting" in the separate manual for the "Music Transfer pavit Edition" software.

Operation

Symptom	Cause/Remedy
There is no sound.	→ The volume level is set to the minimum level. Increase the volume (page 10).
The buttons do not work.	→ The HOLD function is activated. Release the HOLD function (page 14). → The player contains moisture condensation. Let your player sit for a few hours. → The battery is exhausted. Replace the battery with a new one (page 7).
The volume will not increase.	→ The HOLD function is activated. Release the HOLD function (page 14).
The sound is distorted.	→ The bit rate used when encoding the MP3 files was low. Transfer MP3 files encoded with higher bit rates to the "pavit." → The M.D.S.E function is turned on. Turn off the M.D.S.E function (page 13).
Playback stops suddenly.	→ The battery is exhausted. Replace the battery with a new one (page 7).
There is noise in the playback sound.	→ The audio data itself contains noise. Noise may have been introduced when creating audio data due to the conditions of the computer. Create the audio data again.
The LED indicator flashes red even though the battery has just been replaced.	→ The player is not functioning normally. Remove the "pavit" from the player and hold down  for more than 5 seconds to reset the player. → Send the audio data to the "pavit" again, as the data stored in the "pavit" may have been destructed.

(Continued)

Battery

Symptom	Cause/Remedy
Battery life is short.	→ The operating temperature is below 0°C (32°F). Battery life becomes shorter in cold temperatures due to battery characteristics. This is not a malfunction.

Other

Symptom	Cause/Remedy
The "pavit" cannot be inserted into the player.	→ The "pavit" is being inserted backwards. Insert the "pavit" in the correct orientation.
The player gets warm.	→ The player gets warm if it is used for an extended period of time. This is not a malfunction.
The "pavit" which has been used on another device does not work.	→ The "pavit" has been formatted on a computer or other device. Make a backup copy of any important data in the "pavit," such as by copying it to the hard disk of your computer. Then reformat the "pavit," using the supplied "Music Transfer pavit Edition" software. As "Music Transfer pavit Edition" is not compatible with FAT32 file systems, reformat the "pavit" with FAT or FAT16 format.

To attach the battery compartment lid

Attach as illustrated below.

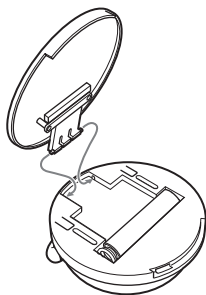

Specifications

Supported audio file format

MP3 Transfer bit rate*: 8 - 320 kbps

Sampling frequencies: 24/22.05/16/12/
11.025/8/32/44.1/48 kHz

* 128 kbps or a higher bit rate is recommended.

Frequency response

20 - 20,000 Hz (single signal measurement)

Power output

USA model: 7 mW + 7 mW

Other models: 3 mW + 3 mW

Input

Stereo mini-jack: 1000 mW + 1000 mW

Operating temperature

5°C - 35°C (41°F - 95°F)

Power source

One LR03 (size AAA) alkaline battery:

1.5 V DC × 1

Battery life

Approx. 11 hours with a Sony LR03 (size AAA)
alkaline battery

Mass

Approx. 129 g (4.5 oz) (including battery)

Accessories

See page 6.

Optional accessories

USB storage media "pavit"

AZ-RM256P: 256 MB

USB storage media "pavit"

AZ-RM128P: 128 MB

Design and specifications are subject to change
without notice.

Index

A, B

Battery 7
Beep 14

C, D, E

Cleaning 16

F, G

Format 18

H, I, J, K

HOLD 14

L

Listening 9
Locking the controls (HOLD function) 14

M

M.D.S.E (MP3 Digital Sound Enhancer) 13
MP3 4, 5
Music Transfer pavit Edition 4, 9

N, O, P, Q

“pavit” 4, 5
 insert 10
 remove 12
Playback 10
Precantions 16

R

Repeat 13
Reset 17

S

Shuffle 13
Skip 8
Sound 13

T, U

Troubleshooting 17
Using as stereo headphones 15

V, W, X, Y, Z

Volume 10, 11

<http://www.aiwa.com/>

Sony Corporation Printed in Korea

Download from [Www.Somanuals.com](http://www.Somanuals.com). All Manuals Search And Download.

For the customers in the USA

For assistance and information
visit us on the internet at
www.us.aiwa.com
call toll free 1-800-BUY-AIWA
(United States only)

Free Manuals Download Website

<http://myh66.com>

<http://usermanuals.us>

<http://www.somanuals.com>

<http://www.4manuals.cc>

<http://www.manual-lib.com>

<http://www.404manual.com>

<http://www.luxmanual.com>

<http://aubethermostatmanual.com>

Golf course search by state

<http://golfingnear.com>

Email search by domain

<http://emailbydomain.com>

Auto manuals search

<http://auto.somanuals.com>

TV manuals search

<http://tv.somanuals.com>