

Precautions

On safety

- As the laser beam used in the CD player section is harmful to the eyes, do not attempt to disassemble the casing. Refer servicing to qualified personnel only.
- Should any solid object or liquid fall into the player, unplug the player, and have it checked by qualified personnel before operating it any further.
- Discs with non-standard shapes (e.g., heart, square, star) cannot be played on this player. Attempting to do so may damage the player. Do not use such discs.

Cleaning the cabinet

- Clean the cabinet, panel and controls with a soft cloth slightly moistened with a mild detergent solution. Do not use any type of abrasive pad, scouring powder, or solvent, such as alcohol or benzine.

On power sources

- For AC operation, check that the player's operating voltage is identical with your local power supply (see "Specifications") and use the supplied mains lead; do not use any other type. The voltage selector is located at the rear of the player (Saudi Arabian model only).
- The player is not disconnected from the AC power source (mains) as long as it is connected to the wall outlet, even if the player itself has been turned off.
- For battery operation, use eight R20 (size D) batteries.
- When the batteries are not to be used, remove them to avoid damage that can be caused by battery leakage or corrosion.
- The nameplate indicating operating voltage, power consumption, etc. is located at the bottom.

On placement

- Do not leave the player in a location near heat sources, or in a place subject to direct sunlight, excessive dust or mechanical shock.
- Do not place the player on an inclined or unstable place.
- Do not place anything within 10 mm of the side of the cabinet. The ventilation holes must be unobstructed for the player to operate properly and prolong the life of its components.
- If the player is left in a car parked in the sun, be sure to choose a location in the car where the player will not be subjected to the direct rays of the sun.
- Since a strong magnet is used for the speakers, keep personal credit cards using magnetic coding or spring-wound watches away from the player to prevent possible damage from the magnet.

On operation

- If the player is brought directly from a cold to a warm location, or is placed in a very damp room, moisture may condense on the lenses inside the CD player section. Should this occur, the player will not operate properly. In this case, remove the CD and wait about an hour for the moisture to evaporate.
- If the player has not been used for a long time, set it in the playback mode to warm it up for a few minutes before inserting a cassette.

Notes on cassettes

- Break off the cassette tab from side A or B to prevent accidental recording. If you want to reuse the tape for recording, cover the broken tab with adhesive tape.

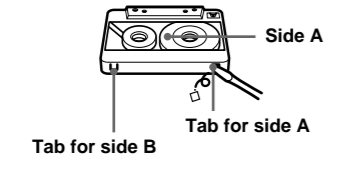

- The use of a cassette with more than 90 minutes of play time is not recommended except for long, continuous recording or playback.

Notes on CDs

- Before playing, clean the CD with a cleaning cloth. Wipe the CD from the center out.

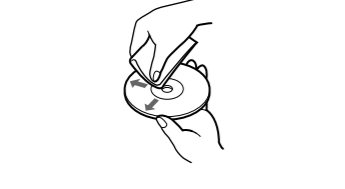

- Do not use solvents such as benzine, thinner, commercially available cleaners or anti-static spray intended for vinyl LPs.
- Do not expose the CD to direct sunlight or heat sources such as hot air ducts, nor leave it in a car parked in direct sunlight as there can be a considerable rise in temperature inside the car.
- Do not stick paper or sticker on the CD, nor scratch the surface of the CD.
- After playing, store the CD in its case. If there is a scratch, dirt or fingerprints on the CD, it may cause tracking error.

About CD-Rs/CD-RWs

This player can play CD-Rs/CD-RWs recorded in the CD-DA format*, but playback capability may vary depending on the quality of the disc and the condition of the recording device.

* CD-DA is the abbreviation for Compact Disc Digital Audio. It is a recording standard used for Audio CDs.

If you have any questions or problems concerning your player, please consult your nearest Sony dealer.

Troubleshooting

General

The power does not come on.

- Connect the mains lead to a wall outlet securely.
- Make sure the batteries are inserted correctly.
- Replace all the batteries with new ones if they are weak.
- You cannot turn on the player with the remote when you operate the player on batteries.

There is no audio.

- Make sure the function you want to use appears in the display window.
- Adjust the volume.
- Unplug the headphones when listening through speakers.

Noise is heard.

- Someone is using a portable telephone or other equipment that emits radio waves near the player. →Move the portable telephone, etc., away from the player.

CD Player

The CD does not play or “no DISC” lights in the display even when a CD is in place.

- Place the CD with the label surface up.
- Make sure that the CD compartment is closed.
- Clean the CD.
- Take out the CD and leave the CD compartment open for about an hour to dry moisture condensation.
- Make sure “Cd” appears in the display.
- The CD-R,CD-RW was not finalized. Finalize the CD-R/CD-RW with the recording device.
- There is a problem with the quality of the CD-R/CD-RW, recording device, or application software.

The sound drops out.

Noise is heard.

- Reduce the volume.
- Clean the CD, or replace it if the CD is badly damaged.
- Place the player in a location free from vibration.
- Clean the lens with a commercially available blower.
- The sound may drop out or noise may be heard when using poor quality CD-Rs/CD-RWs or if there is a problem with the recording device or application software.

Radio

Reception is poor.

- Reorient the antenna to improve FM reception.

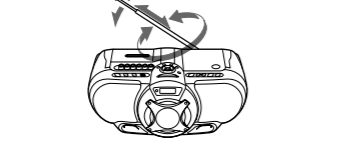

- Reorient the player itself to improve AM reception.

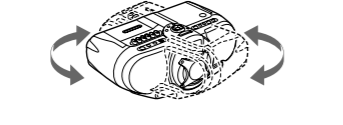

The audio is weak or has poor quality.

- Replace all the batteries with new ones if they are weak.
- Move the player away from the TV.
- If you are using the remote while listening to AM radio, noise may be heard. This is unavoidable.

The picture of your TV becomes unstable.

- If you are listening to an FM programme near the TV with an indoor antenna, move the player away from the TV.

Tape Player

The tape does not move when you press an operation button.

- Close the cassette compartment securely.

The REC ● button does not function or the tape does not play or record.

- Make sure the safety tab on the cassette is in place.
- Make sure “TAPE” appears in the display.

Poor or distorted playback, recording or erasing quality.

- Clean the heads, pinch roller and capstan with a cleaning swab slightly moistened with cleaning fluid or alcohol.
- Replace all the batteries with new ones if they are weak.
- TYPE II (high position) or TYPE IV (metal) tape is being used. Use TYPE I (normal) tape only.
- Demagnetize the heads using a commercially available tape head demagnetizer.

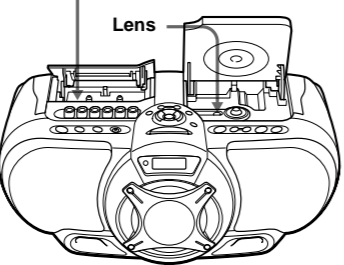
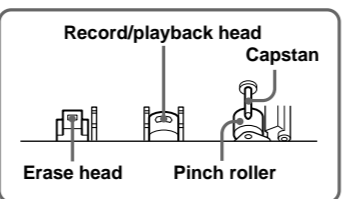

Remote

The remote does not function.

- Replace the battery in the remote with new one if it is weak.
- Make sure that you are pointing the remote at the remote sensor on the player.
- Remove any obstacles in the path of the remote and the player.
- Make sure the remote sensor is not exposed to strong light such as direct sunlight or fluorescent lamp light.
- Move closer to the player when using the remote.

After trying the above remedies, if you still have problems, unplug the mains lead and remove all the batteries. After all the indications in the display disappear, plug the power cord and insert the batteries again. If the problem persists, please consult your nearest Sony dealer.

Specifications

CD player section

System
Compact disc digital audio system
Laser diode properties
Material: GaAlAs
Wave length: 780 nm
Emission duration: Continuous
Laser output: Less than 44.6 μW
(This output is the value measured at a distance of about 200 mm from the objective lens surface on the optical pick-up block with 7 mm aperture.)

Spindle speed
200 r/min (rpm) to 500 r/min (rpm) (CLV)
Number of channels
2
Frequency response
20 - 20 000 Hz +1/−2 dB
Wow and flutter
Below measurable limit

Radio section

Frequency range
FM: 87.5 - 108 MHz
AM: 531 - 1 611 kHz (9 kHz step)
530 - 1 610 kHz (10 kHz step)
IF
FM: 10.7 MHz
AM: 450 kHz
Aerials
FM: Telescopic aerial
AM: Built-in ferrite bar aerial

Cassette-corder section

Recording system
4-track 2 channel stereo
Fast winding time
Approx. 11.5 s (sec.) with Sony cassette C-60
Frequency response
TYPE I (normal): 70 - 13 000 Hz

General

Speaker
Main speaker: 10 cm (4 in.) dia., 3.2 Ω, cone type (2)
Subwoofer: 8 cm (3 1⁄ in.) dia., 4 Ω, cone type (1)
Outputs
Headphones jack (stereo minijack)
For 16 - 68 Ω impedance headphones
Maximum power output
Main speaker: 8 W
Subwoofer: 12 W
Power requirements
For CD radio cassette-corder:
Saudi Arabian model:
110 - 127V, 220 - 240V AC selectable, 60 Hz
Other models:
230 V AC, 50 Hz
12 V DC, 8 R20 (size D) batteries
For remote control:
3 V DC, 2 R6 (size AA) batteries
Power consumption
AC 30 W
Battery life
For CD radio cassette-corder:

FM recording
Sony R20P: approx. 6 h
Sony alkaline LR20: approx. 18 h
Tape playback
Sony R20P: approx. 1.5 h
Sony alkaline LR20: approx. 6 h
CD playback
Sony R20P: approx. 1 h
Sony alkaline LR20: approx. 4 h

Dimensions
Approx. 456 × 195 × 330 mm (w/h/d) (18 × 7 7⁄ 8 × 13 inches)(incl. projecting parts)
Mass
Approx. 6.8 kg (14 lb. 16 oz) (incl. batteries)
Supplied accessory
Mains lead (1)
Remote control (1)

Design and specifications are subject to change without notice.

Optional accessories
Sony MDR headphone series

SONY[®]

CD Radio Cassette-Corder

Operating Instructions

CFD-G55

Sony Corporation ©2002
3-241-310-41 (1)
http://www.sony.net/

Power Sources

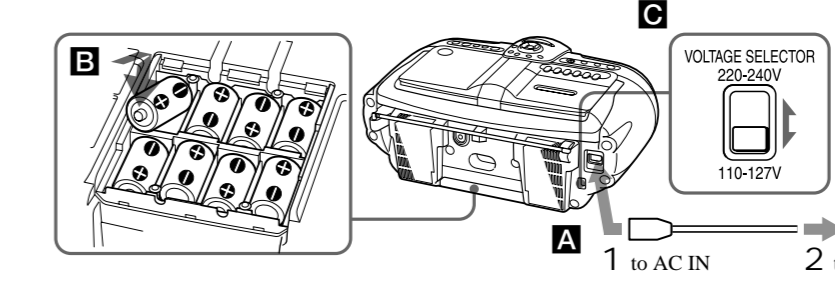

Connect the mains lead **A** or insert eight R20 (size D) batteries (not supplied) into the battery compartment **B**.

Notes

- Replace the batteries when the OPR/BATT indicator dims or when the player stops operating. Replace all the batteries with new ones. Before you replace the batteries, be sure to take out the CD from the player.
- When you operate the player on batteries, the backlight in the display does not light.
- To use the player on batteries, disconnect the mains lead from the player.
- When you operate the player on batteries, you cannot turn on the player using the remote.

Saudi Arabian model only: Adjusting the voltage **C**

Be sure to set the VOLTAGE SELECTOR (at the rear) to your local power supply.

Tip

Only for the customers supplied with an AC plug adaptor: Use the supplied AC plug adaptor if the plug of the mains lead does not match your outlet.

Preparing the remote **D**

Insert two R6 (size AA) batteries (not supplied).

Replacing batteries

With normal use, the batteries should last for about six months. When the remote no longer operates the player, replace two batteries with new ones.

Location of controls

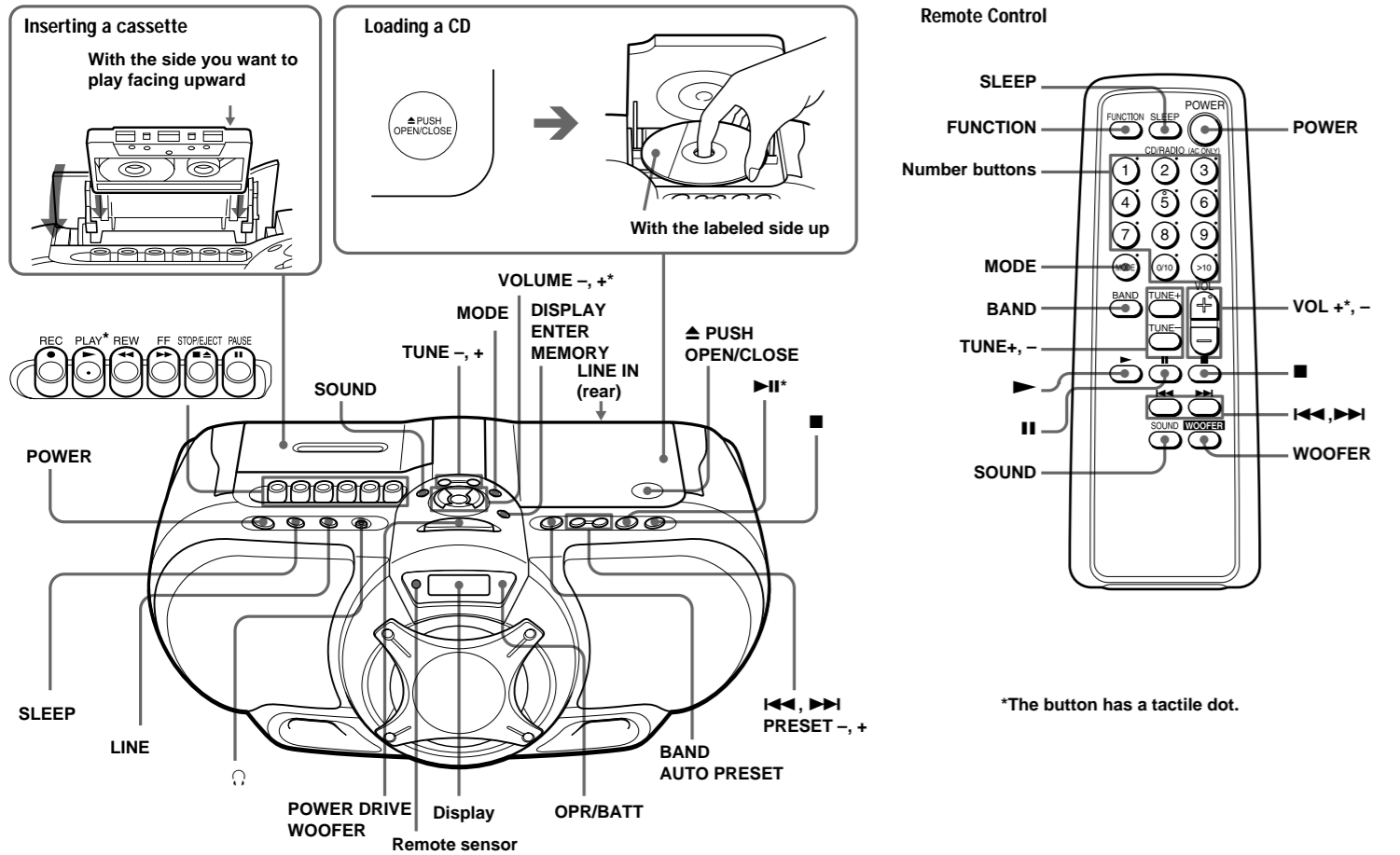

To turn on/off the power

Press POWER.

To adjust the volume

Press VOLUME +, - (VOL +, - on the remote).

To listen through headphones

Connect the headphones to the (headphones) jack.

Adjusting the audio emphasis

To select the sound characteristic

Press SOUND repeatedly to select the audio emphasis you want.

Choose	To get
	powerful, clean sounds, emphasizing low and high range audio
	light, bright sounds emphasizing high and middle range audio
	percussive sounds, emphasizing bass audio
	the presence of vocals, stressing middle range audio
	the whole dynamic range for music such as classical music

To reinforce the bass sound

Press POWER DRIVE WOOFER (WOOFER on the remote) to select or in the display. is more effective. When POWER DRIVE WOOFER function works, the button lights up.

To return to normal sound, press the button until the indication disappears from the display .

Notes

- While the sleeping timer is on, the POWER DRIVE WOOFER button does not light, even if the WOOFER function works.
- When using the headphones, the WOOFER function does not work.

Falling asleep to music

- Play the music source you want.
- Press SLEEP.
- Press SLEEP to select the minutes until the player goes off automatically. Each time you press the button, the indication changes as follows: “60” → “90” → “120” → “OFF” → “10” → “20” → “30”.

To cancel the sleep function

Press POWER to turn off the power.

Notes

- The backlight in the display does not light while the sleeping timer is on.
- When you are playing a tape using this function: If the tape length of one side is longer than the set time, the player will not go off until the tape reaches the end.

Playing a CD

- Press POWER to turn on the player.
- Load a CD in the CD compartment.
- Press to close the CD compartment.
- Press (▶) on the remote). The player plays all the tracks once.

To	Press
stop playback	
pause playback	(on the remote) Press the button again to resume play after pause.
go to the next track	
go back to the previous track	
remove the CD	
locate a point while listening to the sound	(forward) or (backward) while playing until you find the point.
locate a point while observing the display	(forward) or (backward) in pause until you find the point.
locate a specific track directly*	a number button of the track on the remote.

* You cannot locate a specific track if “SHUF” or “PGM” is lit in the display. Turn off the indication by pressing .

Tip

To locate a track numbered over 10, press >10 first, then the corresponding number buttons on the remote.

Example: To play track number 23, press >10 first, then 2 and 3.

Using the display

To check the total track number and playing time

Press DISPLAY•ENTER•MEMORY in stop mode (see fig.).

To check the remaining time

Press DISPLAY•ENTER•MEMORY repeatedly while playing a CD. The display changes as follows:

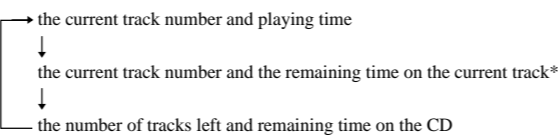

* For a track whose number is more than 20, the remaining time appears as “-:-” in the display.

Selecting the play mode

Press MODE until “REP 1” “REP ALL” “SHUF” “SHUF REP” “PGM” “PGM REP” appears in the display. Then proceed as follows:

To	Select	Then do this
repeat a single track	“REP 1”	Press or to select the track that you want to repeat, then press .
repeat all tracks	“REP ALL”	Press .
shuffle play	“SHUF”	Press .
repeat tracks in random order	“SHUF REP”	Press .
programme play	“PGM”	Press or then press DISPLAY•ENTER•MEMORY for the tracks you want to programme in the order you want up to 20 tracks (see fig.). Then press .
repeat programmed tracks	“PGM REP”	Press or then press DISPLAY•ENTER•MEMORY for the tracks you want to programme in the order you want up to 20 tracks. Then Press .

On the remote

When you’ve selected “PGM” or “PGM REP”, press the number buttons for the track you want up to 20 tracks, then press .

To cancel selected play mode

Press MODE until the selected mode disappears from the display.

To check the programmed track and playing order in the display

To check the order of tracks before play, press DISPLAY•ENTER•MEMORY.

Every time you press the button, the track number appears in the programmed order.

To change the current programme

Press once if the CD is stopped and twice if the CD is playing. The current programme will be erased. Then create a new programme following the programming procedure.

Tips

- You can play the same programme again, since the programme is saved until you open the CD compartment.
- You can record your own programme. After you’ve created the programme, insert a blank tape and press to start recording.

Listening to the radio

- Press POWER to turn on the player.
- Press BAND•AUTO PRESET until the band you want appears in the display. Each time you press the button, the indication changes as follows: “FM” → “AM”.
- Hold down TUNE + or – until the frequency digits begin to change in the display.

The player automatically scans the radio frequencies and stops when it finds a clear station.

If you can’t tune in a station, press the button repeatedly to change the frequency step by step.

Tip

If the FM broadcast is noisy, press MODE until “Mono” appears in the display and the radio will play in monaural.

Changing the AM tuning interval

If you need to change the AM tuning interval, do the following:

- Press BAND•AUTO PRESET until “AM” is displayed.
- Press DISPLAY•ENTER•MEMORY for 2 seconds.
- Press BAND•AUTO PRESET for 2 seconds. “AM 9” or “AM 10” appears.
- Press TUNE + or – to select “AM 9” for 9 kHz interval or “AM 10” for 10 kHz interval.
- Press DISPLAY•ENTER•MEMORY.

After changing the tuning interval, you need to reset your preset AM radio stations.

Presetting radio stations

You can store radio stations into the player’s memory. You can preset up to 30 radio stations, 20 for FM and 10 for AM in any order.

- Press POWER to turn on the player.
- Press BAND•AUTO PRESET to select the band.
- Hold down BAND•AUTO PRESET for 2 seconds until “AUTO” flashes in the display.
- Press DISPLAY•ENTER•MEMORY. The stations are stored in memory from the lower frequencies to the higher ones.

If a station cannot be preset automatically

You need to preset a station with a weak signal manually.

- Press POWER to turn on the player.
- Press BAND•AUTO PRESET to select the band.
- Tune in a station you want.
- Hold down DISPLAY•ENTER•MEMORY for 2 seconds until the preset number flashes in the display.
- Press PRESET + or – until the preset number you want for the station flashes in the display.
- Press DISPLAY•ENTER•MEMORY. The new station replaces the old one.

On the remote

- Press BAND until the band you want appears in the display.
- Tune in a station you want.
- Hold down the number buttons that you want to preset the new station on for about 2 seconds. To select the preset number over 10, press >10 first, then the corresponding number buttons. You need to hold down the last number button to enter for about 2 seconds. (Example: To select 12, press >10 and 1 first, then hold down 2 for about 2 seconds.)

Playing preset radio stations

- Press POWER to turn on the player.
- Press BAND•AUTO PRESET to select the band.
- Press PRESET + or – tune in the stored station.

On the remote

- Press BAND.
- Press the number buttons to tune in the stored station. To tune in a preset station over 10, press >10 first, then corresponding number buttons. (Example: To tune in a preset station 12, press >10 and 1 first, and then press 2.)

Playing a tape

- Press POWER to turn on the player.
- Press to open the tape compartment and insert a recorded tape. Close the compartment. Use TYPE I (normal) tape only.
- Press .

To	Press
stop playback	
fast-forward or rewind the tape	or
pause playback	 Press the button again to resume play after pause.
eject the cassette	

Recording

- Press POWER to turn on the player.
- Press to open the tape compartment and insert a blank tape. Use TYPE I (normal) tape only.
- Select the programme source you want to record.
 - To record from the CD player**
Press and load a CD (See “Playing a CD”).
 - To record from the radio**
Press BAND•AUTO PRESET and tune in the station you want (See “Listening to the radio”).
- Press to start recording. (is depressed automatically.)

To	Press
stop recording	
pause recording	 Press the button again to resume recording.

Tips

- Adjusting the volume or the audio emphasis will not affect the recording level.
- For the best results, use the AC power as a power source for recording.
- To erase a recording, proceed as follows:
 - Insert a tape with the recording you want to erase.
 - Press .
 - Press .
 - Press .
 - Press .

Connecting optional components

You can enjoy the sound from other components, such as TV, VCR and portable MD, CD player through the speakers of this player.

Be sure to turn off the power of each component before making connections. For details, refer to the instructions of the component to be connected.

Connecting a component

- Connect the LINE IN jack on the rear panel of this player with the line output jack or headphones jack of a TV, VCR or other component using the audio connecting cable (RK-G129, RK-G136, not supplied).
- Press LINE to display “LInE”.
- Play the optional component connected to the LINE IN jack of the player.

Recording the sound from the connected components

- Insert a blank cassette.
- Press LINE to display “LInE”.
- Press . Recording starts.
- Play the optional component connected to the LINE IN jack of the player.

Note

Connect the cords firmly to avoid any malfunction.

Free Manuals Download Website

<http://myh66.com>

<http://usermanuals.us>

<http://www.somanuals.com>

<http://www.4manuals.cc>

<http://www.manual-lib.com>

<http://www.404manual.com>

<http://www.luxmanual.com>

<http://aubethermostatmanual.com>

Golf course search by state

<http://golfingnear.com>

Email search by domain

<http://emailbydomain.com>

Auto manuals search

<http://auto.somanuals.com>

TV manuals search

<http://tv.somanuals.com>