

SONY®

STEREO CASSETTE-CORDER

WM-D6C

OPERATING INSTRUCTIONS

Please read this operating manual thoroughly before operating this high quality electronic unit, so that you can obtain the maximum enjoyment from it.

This manual should be retained for future reference and used to answer your operational questions as they arise.

WALKMAN PROFESSIONAL

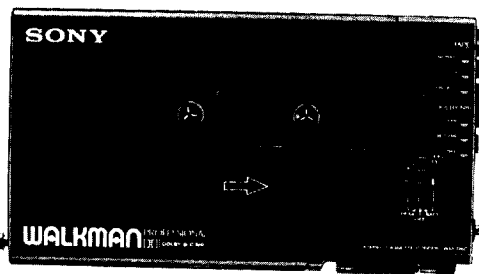

WALKMAN is a trademark of Sony Corporation

© 1983 by Sony Corporation

OWNER'S RECORD

The model number is located at the rear and the serial number is located in the battery compartment.

Record the serial number in the space provided below.

Refer to these numbers whenever you call upon your Sony dealer regarding this product.

Model No. WM-D6C

Serial No. _____

INFORMATION

This equipment has been tested and found to comply with the limits for a Class B digital device, pursuant to Part 15 of the FCC Rules. These limits are designed to provide reasonable protection against harmful interference in a residential installation. This equipment generates, uses, and can radiate radio frequency energy and, if not installed and used in accordance with the instructions, may cause harmful interference to radio communications. However, there is no guarantee that interference will not occur in a particular installation. If this equipment does cause harmful interference to radio or television reception, which can be determined by turning the equipment off and on, the user is encouraged to try to correct the interference by one or more of the following measures:

- Reorient or relocate the receiving antenna.
- Increase the separation between the equipment and receiver.
- Connect the equipment into an outlet on a circuit different from that to which the receiver is connected.
- Consult the dealer or an experienced radio/TV technician for help.

Warning

You are cautioned that any changes or modifications not expressly approved in this manual could void your authority to operate this equipment.

TABLE OF CONTENTS

Features	3
Precautions	3
Battery insertion	4
Cassette insertion	5
Playback	6
Recording	8
Other power sources	9
Functions to make recording/playback easy	10
How to use the carrying case and shoulder strap	11
Maintenance	12
Specifications	12
Parts identification	14

FEATURES

- **Quartz lock capstan servo system** assures accurate and stable tape speed.
- In addition to the conventional B-type Dolby * NR system, the WM-D6C employs the **C-type Dolby NR system** which reduces tape noise twice as effectively as the B-type system.
- **Speed control** adjusts the tape speed accurately (approx. $\pm 4\%$) in the playback mode.
- **DC-DC converter** boosts the low voltage of DC 6V and maintains sufficient power.
- **Amorphous head** for recording/playback provides a wider dynamic range and a more extended frequency response.
- **Tape selector** for optimum recording with standard tapes as well as high-performance tapes.
- **Microphone attenuator** eliminates the distortion which may be caused by high-level input signal.
- **MIC (PLUG IN POWER) jack** can supply power to an ECM-909A electret condenser stereo microphone (optional).
- **Three different power sources:** batteries, house current, and 12 V car battery.
- **5-LED peak/battery indicator** shows both the peak level and the battery strength.
- **Stereo minijacks** can be used for connecting to audio components.

* Dolby noise reduction manufactured under license from Dolby Laboratories Licensing Corporation.
"DOLBY" and the double-D symbol  are trademarks of Dolby Laboratories Licensing Corporation.

PRECAUTIONS

- Operate the set only on 6 V dc.
- Do not leave the set near heat sources such as radiators or airducts, or in a place subject to direct sunlight, excessive dust, moisture, rain, or mechanical shock.
- Should any liquid or solid object fall into the set, remove the batteries and disconnect the ac power adaptor or the car battery cord, and have the set checked by qualified personnel before operating it any further.

On headphones

Road safety

Do not use headphones while driving, cycling, or operating any motorized vehicle. It may create a traffic hazard and is illegal in some areas. It can also be potentially dangerous to play your headsets at high volume while walking, especially at pedestrian crossings. You should exercise extreme caution or discontinue use in potentially hazardous situations.

Preventing hearing damage

Do not use headphones at high volume. Hearing experts advise against continuous, loud and extended play. If you experience a ringing in your ears, reduce volume or discontinue use.

Caring for others

Keep the volume at a moderate level. This will allow you to hear outside sounds and to be considerate to the people around you.

- The record button cannot be depressed in the following cases. Never depress the button forcibly.
- No cassette in the cassette compartment.
- The cassette inserted has had the tabs removed.

If you have any question or problem concerning your set that is not covered in this manual, please consult the nearest Sony Service Station authorized to service tape recorders.

BATTERY INSERTION

Insert four batteries, size AA (IEC designation R6), with correct polarity, referring to the illustration below.

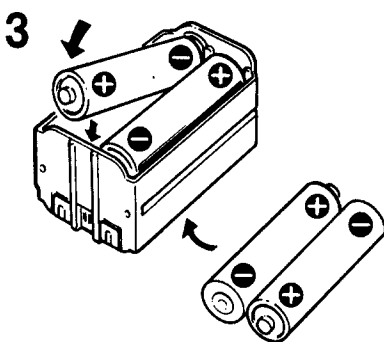
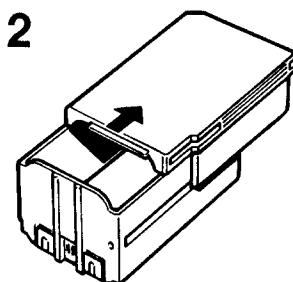
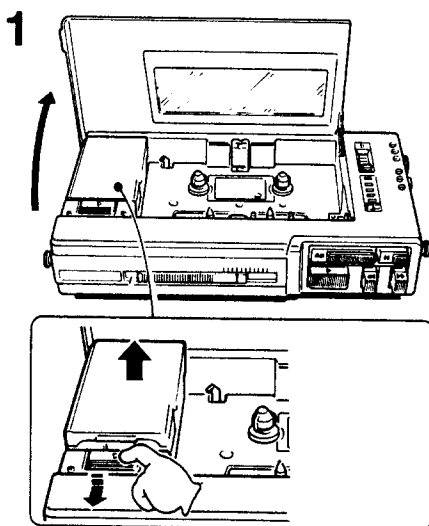

4

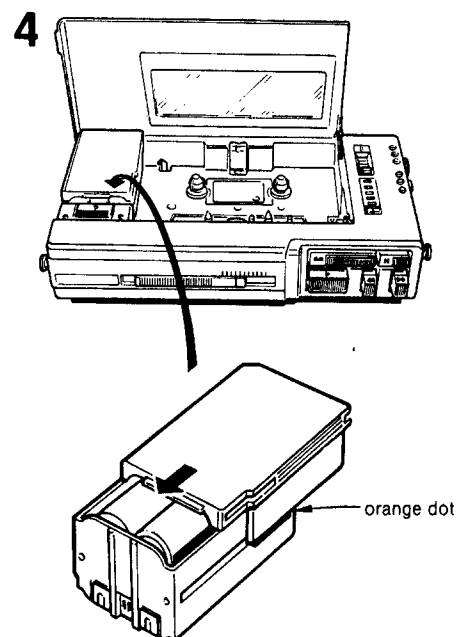

Note: When the set is not to be used for a long period of time or is to be operated extensively on other power sources, remove the batteries to avoid set damage caused by battery leakage and corrosion.

Battery life

type of cassette batteries	continuous recording		continuous playback
	TYPE IV	TYPE I	TYPE I, IV
Sony AM3 (N) alkaline batteries	4	5	6
Sony SUM-3 (NS) batteries	2	2.5	3

(hours)

To check the battery condition, press any of the function buttons and set the peak/battery indication selector to BATT. The bottom-most LED will glow showing battery condition. If the indicator glows faintly replace all batteries at once.

● The life of other type batteries or batteries of other manufacturers may be different.

CASSETTE INSERTION

Take up any slack in the tape with a thick pencil, and insert a cassette with the desired side up. Avoid touching the tape surface.

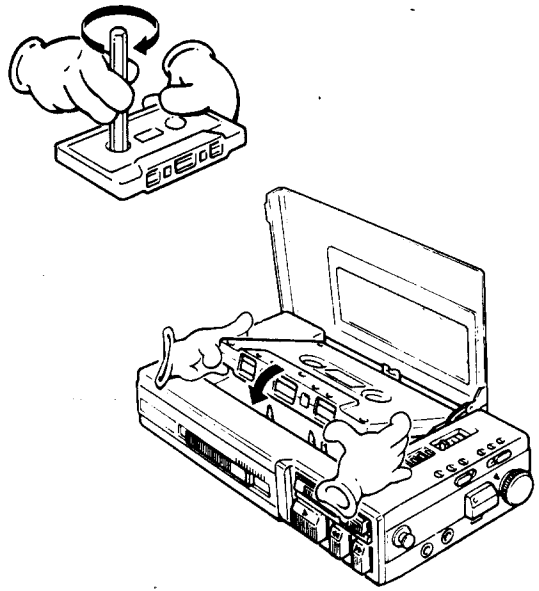

PLAYBACK

CONNECTION

For playback through the headphones

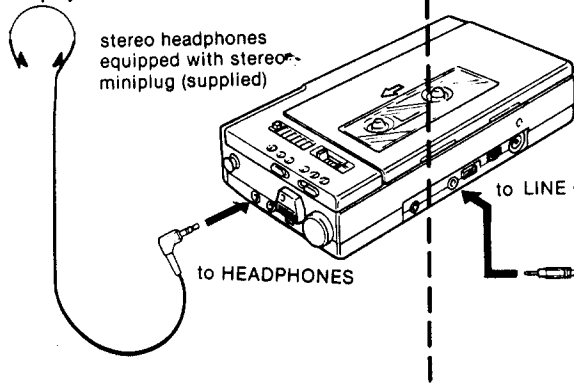

For playback through speakers

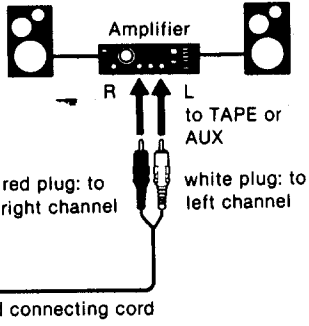

OPERATION

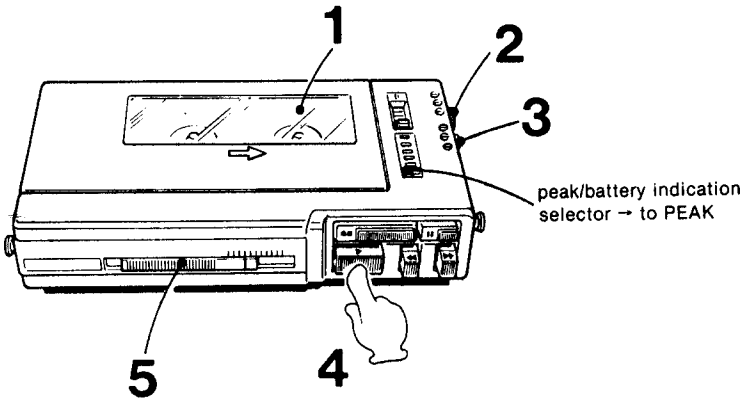

- 1 Insert a cassette.
- 2 Set the TAPE selector to the appropriate position.
- 3 For Dolby B-type NR processed tape, set the DOLBY NR selector to B-TYPE.
For Dolby C-type NR processed tape, set it to C-TYPE.
For non-Dolby NR processed tape, set it to OFF.
- 4 Depress the ► PLAY button. Playback will begin.

- 5 Adjust the volume of the headphones with the HEADPHONE VOLUME control.
Adjust the volume of the speakers with the volume control of the amplifier.

To stop the tape during playback, press the ▲■ button.

To rewind the tape, press the ◀◀ REVIEW button.

To advance the tape rapidly, press the ▶▶ CUE button.

SPEED TUNE SELECTOR AND CONTROL

The playback speed can be adjusted to tune the pitch of a tape, recorded on another tape recorder. Set the SPEED TUNE selector to ON and turn the SPEED TUNE control to F (fast) or S (slow). For normal tape speed, set it to OFF.

When the ● RECORD button is pressed, this selector is automatically set to the OFF position.

TO DUPLICATE ONTO ANOTHER TAPE RECORDER

Use the supplied connecting cord, or an optional RK-G129HG or RK-G136HG connecting cord.

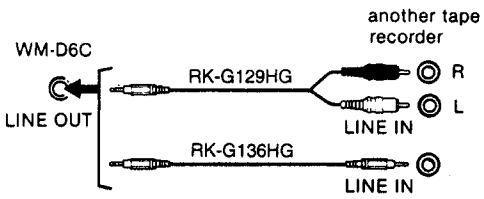

RECORDING

CONNECTION

For microphone recording

ECM-909A electret condenser stereo microphone (optional)

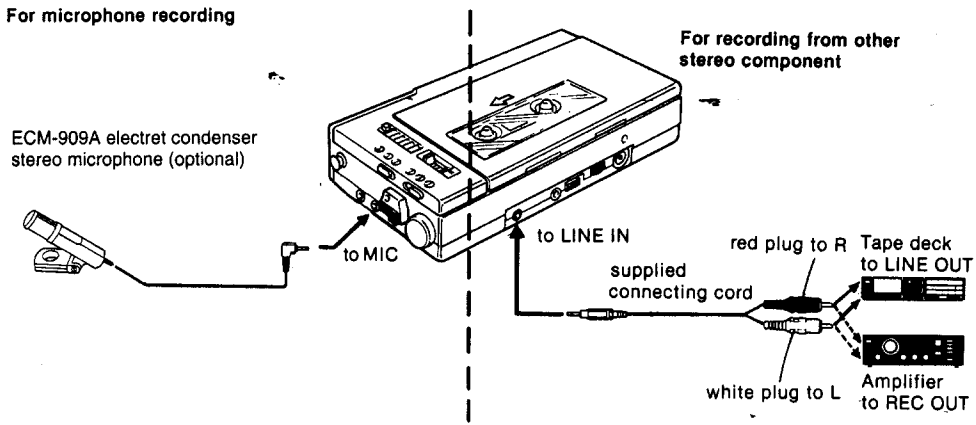

Notes

- To connect a stereo microphone with two L and R miniplugs or two microphones with a miniplug, use an optional PC-239S plug adaptor.
- This set supplies power to the ECM-909A from the MIC jack. When you use the ECM-909A, remove the battery inside the ECM-909A.

OPERATION

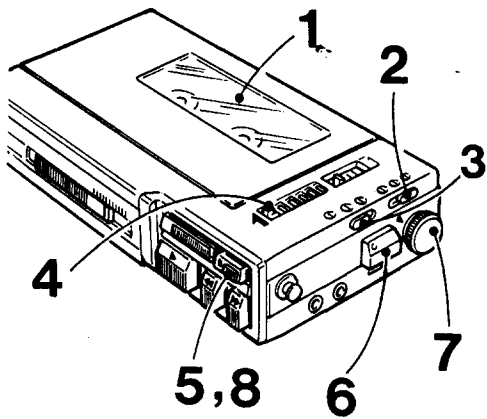

- 1 Insert a cassette.
- 2 Set the TAPE selector to the appropriate position.
- 3 For recording with Dolby B-type NR process, set the DOLBY NR selector to B-TYPE. For recording with Dolby C-type NR process, set it to C-TYPE. For recording without Dolby NR process, set it to OFF.
- 4 Adjust the recording level following steps 4 to 7. Set the peak/battery indication selector to PEAK.
- 5 Depress the **||** button.
- 6 Depress the **●** RECORD button.
- 7 Adjust the REC LEVEL control, referring to the level meter.
- 8 Press the **||** button again to release the pause mode. Recording will begin.
To listen to the sound being recorded, connect the headphones.

To stop recording, press the **▲■** button.

Recording levels for metal, CrO₂ and normal tapes are different. When recording with metal tapes, the level meter should peak at about +6 dB. For CrO₂ and normal tapes, the peak level should be about +3 dB. The peak/battery indicator will show the highest peak at the time for either the left or right channel, whichever is higher at that instant.

OTHER POWER SOURCES

HOUSE CURRENT

Use the Sony AC-D4HG AC power adaptor (optional).

First connect the adaptor to DC IN 6V jack, and then to a wall outlet.

Before connecting, be sure to read the instruction manual for the adaptor.

12V CAR BATTERY

Use the Sony DCC-120A car battery cord (optional), and connect the DC IN 6V jack on the set to the cigarette lighter socket of a car. Set the voltage selector of the DCC-120A to 6V. For further details, refer to the instruction manual of the car battery cord.

Notes

- When the AC power adaptor or the car battery cord is connected to the DC IN 6V jack, the internal batteries (if present) are automatically disconnected.

- Use only the AC-D4HG AC power adaptor or DCC-120A car battery cord. Do not use any other AC power adaptor or car battery cord.

FUNCTIONS TO MAKE RECORDING/PLAYBACK EASY

MIC ATT (attenuator) switch

The microphone attenuator is useful for recording a large input signal on location (like rock music) or recording with a microphone very close to the source without overloading the recorder amplifier. Normally set this switch to the 0dB position. Set it to the 20dB position to avoid overloading the amplifier of the recorder, when you make a live recording with high input signals.

The "20dB" position attenuates the input level by 20dB.

Cue and review function

During playback, you may skip-over unnecessary portions of the tape by pressing the ►► CUE button or repeat a certain portion of the tape by pressing the ◀◀ REVIEW button. (The sound is muted during this function.) When the ►► CUE or ◀◀ REVIEW button is released, the recorder will automatically return to the playback mode.

|| (pause) button

Depress the || button to stop the tape for a moment in playback or recording mode. To restart, press the button again to release it. To stop the tape for an extended time, use the ▲■ button.

Automatic shut-off mechanism

In playback or recording mode, tape motion stops at the end of the tape and the locked buttons will return to the original position automatically.

In fast forward or rewind mode, however, the locked button will not be released automatically. Be sure to press the ▲■ button to release it.

One touch review function

During recording, you can listen to the material just recorded with this function. While recording, when the ◀◀ REVIEW button is depressed, only the ● RECORD button will be released and the tape will be rewound. By releasing the ◀◀ REVIEW button, the recorder will go into the playback mode.

10

Instant edit function

During playback, simply depress the ● RECORD button, and the recorder will immediately change to the recording mode. This function is convenient for correcting a previously recorded portion.

Peak/battery indicator and indication selector

To observe the input level during recording or recorded level during playback, set this selector to PEAK.

The indicator will show the input level or the recorded level for either the left or right channel, whichever is higher at that instant.

To check the battery condition, set the selector to BATT. The bottom-most LED will light to show the battery condition. If the indicator glows faintly, replace all batteries at once.

When the selector is set to OFF, no LED will light up.

Tape counter for indexing the tape contents

Before recording, push the reset button to set the counter to "000". Make a note of the figures to help you locate later a desired program on the tape.

To prevent accidental erasure

Break out the small tabs on the rear of the cassette. The ● RECORD button cannot be depressed if a cassette with its tabs broken out is used. To reuse a cassette for recording after the tabs have been removed, simply cover the slots with a small piece of cellophane or vinyl tape.

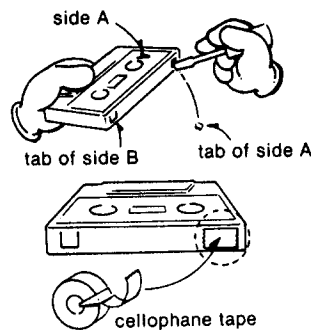

To make a blank erasure

- 1 Insert a cassette.
- 2 Ensure that nothing is connected to the LINE IN and MIC jacks.
- 3 Set the REC LEVEL control to minimum.
- 4 Depress the ● RECORD button.

HOW TO USE THE CARRYING CASE AND SHOULDER STRAP

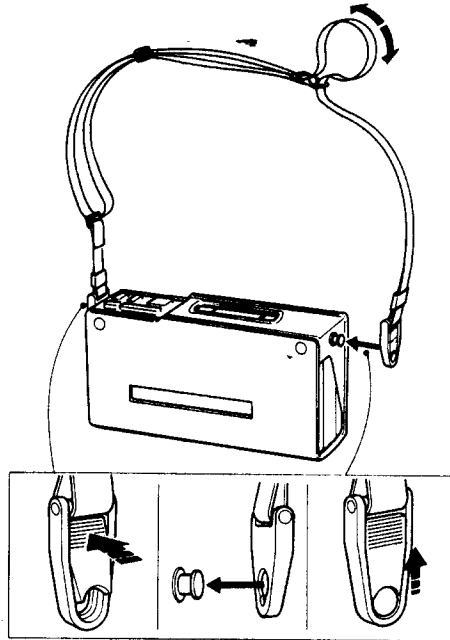
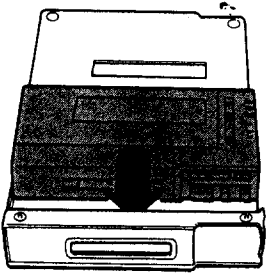

MAINTENANCE

CLEANING THE HEADS

Clean the heads after every 10 hours of use to enjoy optimum hi-fi stereo sound: moisten a cotton swab or a soft cloth with denatured alcohol, and gently wipe the parts shown below.

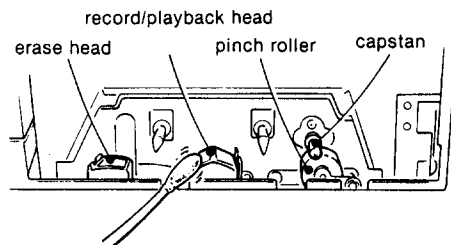

DEMAGNETIZING THE HEADS

Either prolonged use, or an accidental contact with a piece of magnetized steel (screwdriver, scissors, etc.) will magnetize the heads causing an increase in tape noise. In such an event, demagnetize the heads using a commercially available head demagnetizer.

CLEANING THE CASING

Clean the casing with a soft cloth slightly moistened with water or a mild detergent solution. Do not use solvents such as alcohol, benzine, or thinner as they may mar the finish of the casing.

SPECIFICATIONS

Recording system

4-track, 2-channel stereo

Wow and flutter

$\pm 0.14\%$ (DIN)
 0.04% WRMS (NAB)

Tape speed deviation

$\pm 0.3\%$ (speed tuning OFF)

Speed tuner variations

Approx. $\pm 4\%$

Frequency response

DOLBY NR OFF

- With TYPE IV cassette
40 – 15,000 Hz ± 3 dB
- With TYPE II cassette
40 – 15,000 Hz ± 3 dB
- With TYPE I cassette
40 – 15,000 Hz ± 3 dB

S/N (NAB, at peak level)

DOLBY NR C

- TYPE IV cassette
71 dB
- TYPE II cassette
71 dB
- TYPE I cassette
67 dB

DOLBY NR B

- TYPE IV cassette
65 dB
- TYPE II cassette
65 dB
- TYPE I cassette
61 dB

DOLBY NR OFF

- TYPE IV cassette
58 dB
- TYPE II cassette
58 dB
- TYPE I cassette
54 dB

Total harmonic distortion

0.9% with TYPE IV cassette

Inputs

MIC (PLUG IN POWER)
(stereo minijack) $\times 1$
0.25 mV with low impedance
microphone
LINE IN (stereo minijack) $\times 1$
77.5 mV (47 kilohms)

Outputs LINE OUT (stereo minijack) × 1
 output level 0.25 V (less than 4.7 kilohms)
 Headphones (stereo minijack) × 1
 load impedance 8–300 ohms

Power output Headphones
 30 mW + 30 mW (at 10% harmonic distortion)
 load impedance 32 ohms

Battery life See page 4.

Power requirements
 6 V dc, four batteries, size AA (IEC designation R6)
 External power input jack (required power 6 V dc) accepts Sony AC-D4HG AC power adaptor (optional) for use on 120 V ac 60 Hz or Sony DCC-120A car battery cord (optional) for use on 12 V car battery

Dimensions 181 × 40 × 95 mm (w/h/d)
 (7¹/₄ × 1⁵/₈ × 3³/₄ inches) including projecting parts

Weight Approx. 640 g (1 lb 7 oz) including batteries

Supplied accessories

Stereo headphones (1)
 Connecting cord (1)
 Carrying case and shoulder strap (1 set)

Design and specifications subject to change without notice.

OPTIONAL ACCESSORIES

AC power adaptor AC-D4HG
 Car battery cord DCC-120A
 Electret condenser stereo microphone (with stereo miniplug) ECM-909A
 Stereo headphones
 MDR-94, MDR-CD550
 Connecting cord
 RK-G129HG (stereo miniplug to two phono plugs)
 RK-G136HG (stereo miniplug to stereo mini-plug)
 Plug adaptor PC-239S (stereo miniplug to two minijacks)

Continued trouble-free operation of any tape recorder is dependent on the quality of the cassettes used in conjunction with it. The use of Sony cassettes is recommended for high quality recording and trouble-free operation.

Your dealer may not handle some of the above listed optional accessories. Please ask the dealer for detailed information about the optional accessories available in your country.

PARTS IDENTIFICATION

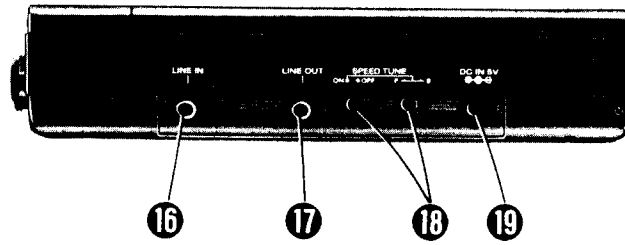
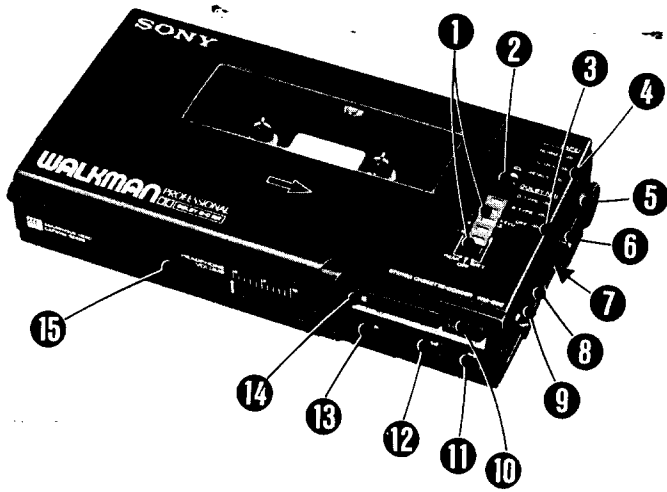

- | | |
|--|-----------------------------------|
| ① Peak/battery indicator and indication selector | ⑩ (pause) button |
| ② Tape counter and reset button | ⑪ ►► (fast forward) CUE button |
| ③ DOLBY NR selector | ⑫ ◀◀ (rewind) REVIEW button |
| ④ TAPE selector | ⑬ ► PLAY (playback) button |
| ⑤ REC LEVEL (recording level) control | ⑭ ▲■ (eject/stop) button |
| ⑥ ● RECORD button | ⑮ HEADPHONE VOLUME control |
| ⑦ MIC ATT (microphone attenuator) switch | ⑯ LINE IN jack |
| ⑧ MIC (PLUG IN POWER) jack (stereo mini-jack) | ⑰ LINE OUT jack |
| ⑨ HEADPHONES jack | ⑱ SPEED TUNE selector and control |
| | ⑳ DC IN 6V jack |

Free Manuals Download Website

<http://myh66.com>

<http://usermanuals.us>

<http://www.somanuals.com>

<http://www.4manuals.cc>

<http://www.manual-lib.com>

<http://www.404manual.com>

<http://www.luxmanual.com>

<http://aubethermostatmanual.com>

Golf course search by state

<http://golfingnear.com>

Email search by domain

<http://emailbydomain.com>

Auto manuals search

<http://auto.somanuals.com>

TV manuals search

<http://tv.somanuals.com>