

IC Recorder

Operating Instructions

IC RECORDER

ICD-MS515

For the customers in the United States

Owner's Record

The model number is located at the rear panel and the serial number is located inside the battery compartment. Record the serial number in the space provided below. Refer to these numbers whenever you call upon your Sony dealer regarding this product.

Model No. ICD-MS515 Serial No. _____

INFORMATION

This equipment has been tested and found to comply with the limits for a Class B digital device, pursuant to Part 15 of the FCC Rules. These limits are designed to provide reasonable protection against harmful interference in a residential installation. This equipment generates, uses, and can radiate radio frequency energy and, if not installed and used in accordance with the instructions, may cause harmful interference to radio communications.

However, there is no guarantee that interference will not occur in a particular installation. If this equipment does cause harmful interference to radio or television reception, which can be determined by turning the equipment off and on, the user is encouraged to try to correct the interference by one or more of the following measures:

- Reorient or relocate the receiving antenna.
- Increase the separation between the equipment and receiver.
- Connect the equipment into an outlet on a circuit different from that to which the receiver is connected.
- Consult the dealer or an experienced radio/TV technician for help.

You are cautioned that any changes or modifications not expressly approved in this manual could void your authority to operate this equipment.

For "Memory Stick"

This device complies with Part 15 of the FCC Rules. Operation is subject to the following two conditions: (1) This device may not cause harmful interference, and (2) this device must accept any interference received, including interference that may cause undesired operation.

If you have any questions about this product, you may call:

Sony Direct Response Center 1-(800)-222-7669

or write to:

Sony Direct Response Center 12451 Gateway Blvd. Fort Myers, Florida 33913

Declaration of Conformity

Trade Name: SONY
Model No.: ICD-MS515
Responsible Party: Sony Electronics Inc.
Address: 680 Kinderkamack Road, Oradell NJ 07649 U.S.A.
Telephone No.: 201-930-6972

This device complies with part 15 of the FCC Rules. Operation is subject to the following two conditions: (1) this device may not cause harmful interference, and (2) this device must accept any interference received, including interference that may cause undesired operation.



The validity of the CE marking is restricted to only those countries where it is legally enforced, mainly in the countries EEA (European Economic Area)

Notice for users

Program © 1999, 2000, 2001, 2002 Sony Corporation
Documentation ©2002 Sony Corporation



All rights reserved. This manual or the software described herein, in whole or in part, may not be reproduced, translated or reduced to any machine readable form without prior written approval from Sony Corporation.

IN NO EVENT SHALL SONY CORPORATION BE LIABLE FOR ANY INCIDENTAL, CONSEQUENTIAL OR SPECIAL DAMAGES, WHETHER BASED ON TORT, CONTRACT, OR OTHERWISE, ARISING OUT OF OR IN CONNECTION WITH THIS MANUAL, THE SOFTWARE OR OTHER INFORMATION CONTAINED HEREIN OR THE USE THEREOF.

Sony Corporation reserves the right to make any modification to this manual or the information contained herein at any time without notice.

The software described herein may also be governed by the terms of a separate user license agreement.

Trademarks

- "Memory Stick" and  are trademarks of Sony Corporation.
- "MagicGate Memory Stick" and  are trademarks of Sony Corporation.
- "LPEC" is the trademark of Sony Corporation.
- IBM and PC/AT are registered trademarks of International Business Machines Corporation.
- Microsoft, Windows and Outlook are trademarks of Microsoft Corporation, registered in the U.S.A. and other countries.
Copyright ©1995 Microsoft Corporation.
All rights reserved.
Portion Copyright ©1995 Microsoft Corporation
- Apple and Macintosh are trademarks of Apple Computer Inc., registered in the U.S.A. and other countries.
- Pentium is a registered trademark of Intel Corporation.
- Dragon Systems, L&H, and NaturallySpeaking are registered trademarks of L&H in the United States and/or other countries.
- All other trademarks and registered trademarks are trademarks or registered trademarks of their respective holders. Furthermore, "TM" and "®" are not mentioned in each case in this manual.

The Memory Stick Voice Editor uses software modules as shown below:

Microsoft® DirectX® Media Runtime

©2001 Microsoft Corporation. All rights reserved.

Information

IN NO EVENT SHALL SELLER BE LIABLE FOR ANY DIRECT, INCIDENTAL OR CONSEQUENTIAL DAMAGES OF ANY NATURE, OR LOSSES OR EXPENSES RESULTING FROM ANY DEFECTIVE PRODUCT OR THE USE OF ANY PRODUCT.

Table of Contents

Before You Begin

What is the Memory Stick IC recorder?	6
What is "Memory Stick" ?	7
Features	9

Getting Started

Step 1: Installing the Batteries	10
Step 2: Setting the Clock	12
Step 3: Inserting a "Memory Stick" into the IC Recorder	14

Basic Operations

Recording Messages	16
Other Operations	18
Playing Back Messages	21
Other Operations	22
Erasing Messages	25
Erasing Messages one by one	25
Erasing All Messages in a Folder	27

Various Ways of Playback

Adjusting the Playback Speed — DPC (Digital Pitch Control)	28
Adding a Bookmark	29
Playing Back the Specified Section Repeatedly — A-B Repeat	30

Editing Messages

Adding a Recording	31
Adding a Recording to a Previously Recorded Message	31
Adding an Overwrite Recording during Playback	32
Dividing a Message into Two/Combining Messages — Index Function ...	33
Dividing a Message by Adding an Index	33
Combining Messages by Erasing the Index	35
Adding / Deleting Folders	37
Adding Folders	37
Deleting Folders	38
Moving Messages to a Different Folder	39
Adding Priority Mark(s)— Priority Mark Function	40
Adding Priority Mark(s) in the Stop Mode	40
Adding Priority Mark(s) during Playback	41

Labeling Folders or Messages — Folder/Message/User Name	42
Labeling Folders	42
Labeling Messages	44
Setting the User Name	45
Entering Characters	46

Other Functions

Playing Back a Message at a Desired Time with an Alarm	48
Preventing Accidental Operation — HOLD function	52
Selecting the Display Mode	53
Formatting a “Memory Stick”	56
Changing the Settings — MENU	58
Operating the Menu	58
Menu Items	59

“Memory Stick Voice Editor” Software Operations

Overview of the Software	61
What You Can Do with the “Memory Stick Voice Editor” Software ...	61
About the File Formats	63
About the “Memory Stick” Folder Structures	65
System Requirements	66
Installing the software	68
Transferring the “Memory Stick” data onto your computer	70
Connecting the IC Recorder to your Computer	70
Inserting a “Memory Stick” to your Computer	71
Starting the software	73
Starting/Exiting the Software	73
Using Online Help Files of the Software	75
Names and Functions of the Main Window	76

Additional Information

Precautions	79
Troubleshooting	81
Error messages of the IC Recorder	86
System Limitations	88
Specifications	90
Index to Parts and Controls	91
Index	94

Notes

- The illustrations in this manual may differ from the actual software.
- Explanations in this manual assume that you are familiar with basic operations of Windows. For how to use your computer and operating system, please refer to the respective manuals.

► Before You Begin

What is the Memory Stick IC recorder?

The Memory Stick IC recorder enables you to record and play back oral messages recorded on a "Memory Stick".

● Recording

When a new message is recorded, it is automatically added after the last recorded messages.

Unlike with tape recorders, you do not need to worry about recording over previously recorded messages by mistake.

Since you do not need to search for the end of the last recording, you can start recording quickly whenever you wish.

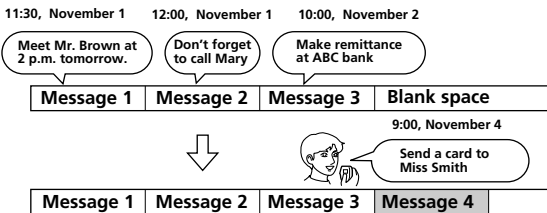

● Playback

Unlike with tape recorders, you do not need to rewind the tape. With this IC recorder, you can quickly locate the message you want to play back.

Reviewing the current recording is also very easy.

● Erasing

You can quickly erase unwanted messages with an easy operation. When a message is erased, the next message automatically advances, leaving no blank space.

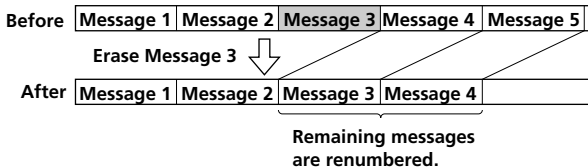

What is "Memory Stick" ?

● What is "Memory Stick"?

"Memory Stick" is a new compact, portable and versatile IC recording medium with a data capacity that exceeds a floppy disk. "Memory Stick" is specially designed for exchanging and sharing digital data among "Memory Stick" compatible products. Because it is removable, "Memory Stick" can also be used for external data storage.

One "Memory Stick" can be used to save and use images recorded by another unit as well as the voice messages using this unit.

● The type of "Memory Stick" you can use with this IC Recorder

You can also use other "Memory Stick" instead of the supplied "Memory Stick." The maximum recording time varies depending on the capacity of the "Memory Stick".

You can also use "MagicGate (MG) Memory Stick" the same as "Memory Stick".

Note

"MagicGate" is a copyright protection technology that uses an encryption technology. This unit does not support the MagicGate standard, therefore, recorded data using this unit is not subject to the protection of copyrights by MagicGate.

● Maximum recording time of a "Memory Stick"*

Mode**	4MB	8MB	16MB	32MB	64MB	128MB
SP	30min.	1hr 4min.	2hr 10min.	4hr 24min.	8hr 52min.	17hr 47min.
LP	1hr 22min.	2hr 51min.	5hr 47min.	11hr 45min.	23hr 38min.	47hr 26min.

(hr: hours / min.: minutes)

* When using each "Memory Stick" for use with ICD-MS515 only and by the initial setting with three folders.

**The initial setting is SP mode.

The amount may change depending on use. For more information, see page 88.

● On file format

This unit compresses voice data in “Memory Stick” voice format (MSV LPEC format: extension .msv). Voice data is saved in a VOICE folder in the “Memory Stick” together with message list (MSF) files that control voice data information (for example, the order of voice messages).

You can play back and edit voice messages recorded on a “Memory Stick” on a computer using the supplied “Memory Stick Voice Editor 2” software. See page 63 for details.

Note

When you connect the “Memory Stick” to your computer, you can check the contents using Windows Explorer. But use the supplied “Memory Stick Voice Editor 2” software to play back and edit messages.

● Notes on using a “Memory Stick”

- Recorded data may be lost or damaged in the following situations:
 - If you remove the “Memory Stick”, turn the power off, or detach the battery for replacement when accessing.
 - If you use the “Memory Stick” near static electricity or electrical noise.
- We recommend backing up important data.

● About formatting of a “Memory Stick”

The supplied “Memory Stick” is already formatted in FAT format. Use “Memory Stick” compatible devices to format a “Memory Stick”. To format using this unit, see page 56.

Note

If you format the “Memory Stick” using the computer, further operation with this unit is not guaranteed.

Backup recommendations

To avoid potential risk of data loss caused by accidental operation, damage of the “Memory Stick”, or malfunction of the IC recorder, we recommend that you save a backup copy of your recorded messages on a tape recorder or to a computer, etc.

You can transfer and save the messages in the “Memory Stick” to your computer using the supplied “Memory Stick Voice Editor” software.

Features

- **Long recording time capability (page 7)**
- **Additional folders can be created to organize messages (page 37)**
- **Labeling folders and messages (page 42)**
- **Various record, playback, and edit functions**

Cue/Review function (page 23)

You can quickly search for the desired parts during playback using the cue or review function.

Easy search function (page 24)

You can quickly search for the point (10 seconds ahead or 3 seconds back) and start playback.

Overwrite and additional recording function (page 31)

You can overwrite after the desired point on a recorded message or add a new recording to a previously recorded message.

Repeat play function (pages 24, 30)

This unit can play back one message or the selected section repeatedly.

Playback speed control (DPC: Digital Pitch Control) (page 28)

You can play back messages rapidly or slowly in natural digitally-processed tone.

Bookmark function (page 29)

You can add a bookmark in a message so that you can easily find the point and start playback.

Alarm function (page 48)

You can start playing back a desired message with an alarm on a desired date and time.

Index function (page 33)

You can divide a message into two and combine messages.

Priority Mark function (page 40)

You can add priority marks. Messages can be sorted in order of the number of priority marks.

Advanced VOR function (page 59)

- **The supplied "Memory Stick Voice Editor" software (page 61)**

You can transfer the messages recorded in "Memory Stick" to the computer with the supplied "Memory Stick Voice Editor" software*.

* For Windows® XP Home Edition/XP Professional/2000 Professional/Me/98

► Getting Started

Step 1: Installing the Batteries

- 1 Slide and lift the battery compartment lid.

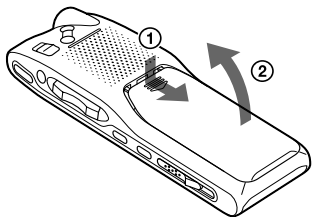

- 2 Insert two LR03 (size AAA) alkaline batteries with correct polarity, and close the lid.

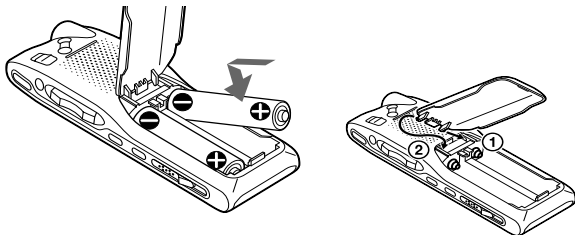

If the battery compartment lid is accidentally detached, attach it as illustrated.

Clock setting display appears when you insert batteries for the first time, or when you insert batteries after the unit has been without batteries for a certain period of time. Please refer to Steps 2 to 4 in "Step 2: Setting the Clock" on pages 12 and 13 to set the date and time.

Replacing the batteries

The battery indicator on the display window shows the battery condition.

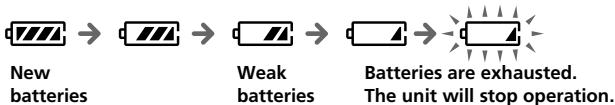

When "LOW BATTERY" is displayed, replace the batteries with new ones.

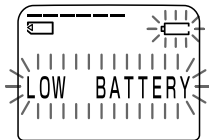

Battery life*

With continuous use, approx. 10 hours (SP)/12 hours (LP) of recording or approx. 12 hours (SP/LP) of playback is possible.

* Using Sony alkaline batteries LR03 (SG)

* When playing back through the internal speaker with VOL control at around 4

The battery life may shorten depending on the operation of the unit.

Notes

- Do not use manganese batteries for this unit.
- When you replace the batteries, insert the new ones within 3 minutes after you removed the exhausted ones. Otherwise, the display may show the clock setting display or incorrect date and time when you re-insert the batteries. In this case, set the date and time again.
The recorded messages and alarm setting, however, will remain.
- When replacing the batteries, be sure to replace both batteries with new ones.
- Do not charge dry batteries.
- When you are not going to use the unit for a long time, remove the batteries to prevent damage from battery leakage and corrosion.

Step 2: Setting the Clock

You need to set the clock to use the alarm function or record the date and time.

Clock setting display appears when you insert battery for the first time, or when you insert battery after the unit has been without battery for a certain period of time. In this case, proceed from step 4.

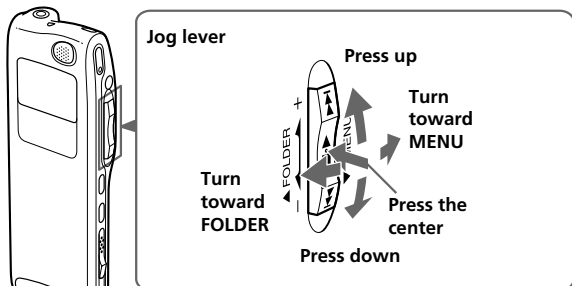

1 Turn the jog lever toward MENU.

The menu mode will be displayed in the display window.

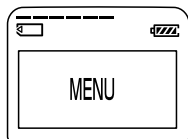

2 Press the jog lever up (▶▶) four times to select "DATE&TIME".



3 Press the jog lever (■▶).

The date and time setting window is displayed. The year digits will flash.

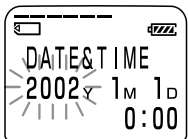

4 Set the date and time.

- ① Press the jog lever up or down (▶▶/◀◀) to select the digits of the year.
- ② Press the jog lever (■•▶).
The month digits will flash.
- ③ Set the month, day, and the time in sequence, then press the jog lever (■•▶).

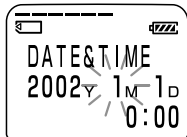

The menu mode will be displayed again.

5 Turn the jog lever toward MENU.

The window will return to normal display.

To display the current time

Press ■ STOP button during the sleep display mode (page 53).

The current time will be displayed for three seconds.

Step 3: Inserting a "Memory Stick" into the IC Recorder

Insert a "Memory Stick" into the Memory Stick slot with the terminal side facing up as shown below.

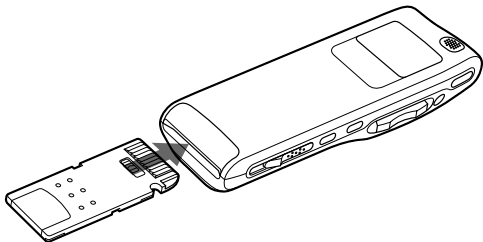

Notes

- Make sure to insert the "Memory Stick" firmly.
- Do not insert a "Memory Stick" in a different direction. It may cause malfunction of the unit.

After inserting a "Memory Stick"

The following display will appear. If you insert a "Memory Stick" for the first time after purchasing or one with no data, three folders (FOLDER 01, FOLDER 02, FOLDER 03) will be made in the "Memory Stick" automatically.

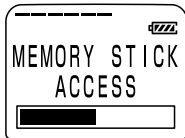

Note

The unit is accessing while "ACCESS" appears in the display window or the OPR indicator flashes in orange. While accessing, do not remove the "Memory Stick", batteries, or the AC adaptor. Doing so may damage the data.

About write-protect of a "Memory Stick"

Write-protect switch

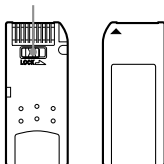

You cannot record or erase data when the write-protect switch on the "Memory Stick" is set to "LOCK".

Removing the "Memory Stick"

Slide the EJECT lever in the direction of the arrow and remove the "Memory Stick" from the slot as shown below.

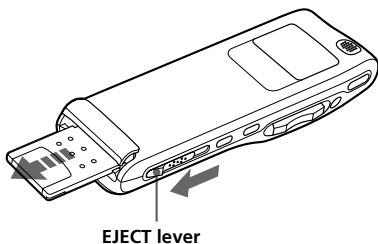

Recording Messages

Since a newly recorded message is automatically added behind the last recorded message, you can press ●REC/REC PAUSE to start recording quickly without searching for the end of the last recording.

e.g.

Message 1	Message 2	Newly recorded message	Blank space
-----------	-----------	------------------------	-------------

Notes

- The maximum recording time and the number of messages you can make varies depending on the conditions or capacity of the "Memory Stick" (page 7).
- Before making a long recording, be sure to insert new batteries and check the battery indicator (page 11).

1

Select the folder.

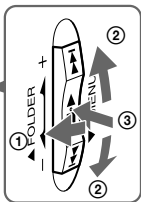
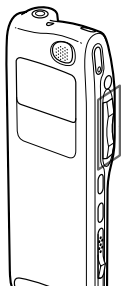

- ① Turn the jog lever toward FOLDER.
The folder is selected.
- ② Press the jog lever up or down (▶|/|◀) to display the folder in which you wish to record messages.

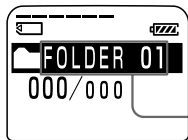

Folder name
(page 42)

- ③ Press the jog lever (■▶) again to select the folder.
To add a new folder, see page 37.

2

Start recording.

OPR indicator (lights in red during recording)

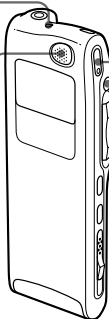

built-in microphone

- 1 Press **●REC/REC PAUSE** button.
You do not need to keep pressing **●REC/REC PAUSE** while recording.

Remaining memory indication

Current message number

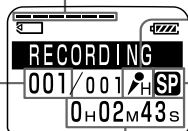

Microphone sensitivity indication

Recording mode indication

Counter display

(The display selected with the DISPLAY in the menu (page 53) appears.)

- 2 Speak into the built-in microphone.

Note on recording

Noise may be recorded if an object, such as your finger, etc., accidentally rubs or scratches the unit during recording.

3

Stop recording.

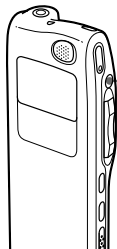

Press **■STOP**.

The unit stops at the beginning of the current recording. If you do not change the folder after you stop recording, the next time you record you will record in the same folder.

Note

While the OPR indicator flashes or lights in orange or red, do not remove the "Memory Stick", or batteries. Doing so may damage the data.

Continued

Recording Messages (continued)

Other Operations

To pause recording

To	Do this
pause recording*	Press ●REC/REC PAUSE. During recording pause, the OPR indicator flashes in red and "PAUSE" flashes in the display window.
release pause and resume recording	Press ●REC/REC PAUSE again. Recording resumes from that point. (To stop recording after pausing recording, press ■STOP.)

* 1 hour after you pause recording, recording pause is automatically released and the unit goes into the stop mode.

To review the current recording instantly

Press the jog lever (■•►) during recording. Recording stops and playback starts from the beginning of the message just recorded.

To review during recording

If you press the jog lever down (◀◀) during recording, recording stops and you can search backwards while listening to fast playback sound. After you release the jog lever, playback starts from that point. You can also do this operation during recording pause. However, you cannot hear the sound during review in this case.

Adding a recording

To add a recording to a previously recorded message or to add an overwrite recording during playback, see pages 31 and 32.

Starting Recording Automatically in Response to the Sound — Advanced VOR function

When the VOR (voice operated recording) function is set to on in the menu, recording starts when the recorder detects sound and stops when no sound is heard.

When you record messages with VOR set to ON, the recording pauses when no sound is detected, and “VOR REC PAUSE” appears in the display window. You can change the VOR setting with the menu during recording (page 59).

Note

VOR function is affected by the sound around you. Set the MIC SENS to either H or L according to the recording conditions. If recording is not satisfactory after you have changed the microphone sensitivity, or for important recording, set the VOR to OFF.

To select the recording mode (SP/LP)

You can select the recording mode by setting MODE in the menu (page 60). LP mode is suitable for long time recording as a meeting. But if you wish to record for better tone quality, then SP mode is suitable for this purpose. (Usually, SP mode is suitable for recording.)

To select the microphone sensitivity

You can select the microphone sensitivity by setting the MIC SENS in the menu to H (high) or L (low) according to the recording conditions (page 59). You can change the MIC SENS setting with the menu during recording.

To monitor the recording

Connect the supplied ear receiver to the EAR jack. You can adjust the volume with VOL +/-, but the recording level is fixed.

Note

If you turn up the volume excessively or place the ear receiver near the microphone while monitoring recording, the microphone may pick up the sound from the ear receiver, causing acoustic feedback (howling sound).

Continued

Recording Messages (continued)

Recording with an external microphone or from other equipment

Connect a plug-in-power type microphone or other equipment to the MIC (PLUG IN POWER) jack.

When you connect an external microphone, the built-in microphone is automatically cut off. When a plug-in-power type microphone is connected, power is automatically supplied to the microphone from the IC recorder.

Remaining memory indication

During recording, the remaining memory indicator decreases one by one. You can check the remaining recording time by changing to the remaining time display mode (page 53).

If the "Memory Stick" contains files other than sound data, the amount of those files is subtracted from the remaining memory amount. To check the remaining recording time, use the menu to switch the display mode to the remaining time. You can switch the display mode during recording.

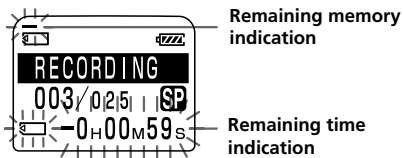

When the remaining recording time reaches 5 minutes, the remaining memory indication flashes. When the remaining time reaches 1 minute, the remaining time indication will flash in the display window regardless of the display mode (page 53). When the memory is full, recording automatically stops and "NO MEMORY SPACE" will flash in the display window with an alarm sound. To continue recording, first erase some of the messages (page 25).

Playing Back Messages

When playing back a previously recorded message, start from Step 1.
When playing back a message you have just finished recording, start from Step 3.

1 Select the folder.

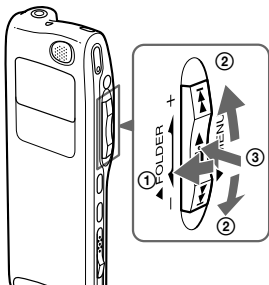

- ① Turn the jog lever toward FOLDER.
The folder is selected.
- ② Press the jog lever up or down (▶▶/◀◀) to display the folder containing the message you want to play back.

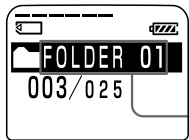

- ③ Press the jog lever (■▶) again to select the folder.

2 Select the message number.

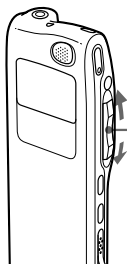

- Press the jog lever up or down (▶▶/◀◀) to display the desired message number.
Press up (▶▶): for next message number.
Press down (◀◀): for previous message number.

Selected message number

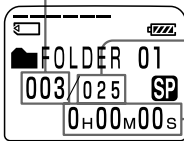

The number of message in a folder

Counter display (The display selected with the DISPLAY in the menu (page 53) appears.)

Continued

Playing Back Messages (continued)

3 Start playback.

OPR indicator
(lights in green during playback)



EAR jack

① Press the jog lever (■▶).

② Adjust the volume with VOL +/- .

After playing back one message, the unit stops at the beginning of the next message.

When the last message in a folder has been played back, the unit stops at the beginning of the last message.

For private listening

Connect an ear receiver or headphones (not supplied) to the EAR jack. The built-in speaker will be automatically disconnected. If you plug in headphones, you will get monaural output from both left and right channels.

Other Operations

To stop playback

To	Do this
stop at the beginning of the current message	Press ■STOP.
stop at the current position (Playback Pause function)*	Press the jog lever (■▶). To resume playback from that point, press the jog lever (■▶) again.

* After an hour, the unit goes into the stop mode at the current position.

Other operations

To	Do this
go back to the beginning of the current message**	Press the jog lever down (◀◀) once.***
go back to previous messages	Press the jog lever down (◀◀) repeatedly.*** (During stop mode, keep the button pressed to go back the messages continuously.)
skip to the next message**	Press the jog lever up (▶▶) once.***
skip to the succeeding messages	Press the jog lever up (▶▶) repeatedly.***

** If you have set a bookmark on the message, the unit stops at the bookmark.

*** These operations are for when EASY-S is set to OFF. For operations when EASY-S is set to ON, see page 59.

Playing back a message rapidly or slowly — DPC (Digital Pitch Control)

You can adjust the playback speed with the DPC in the menu (page 28). When you set the playback speed faster or slower of the normal speed, “FAST PLAY” or “SLOW PLAY” flashes three times. You can change the setting during playback.

Playing back all messages in a folder continuously — Continuous Play

You can select the continuous play mode with the CONT. in the menu (page 59). When you set CONT. to ON, you can play back all messages in a folder continuously. You can change the setting during playback.

Searching forward/backward during playback (Cue/Review)

- **To search forward:** Keep pressing the jog lever up (▶▶) during playback and release it at the point you wish to resume playback.
- **To search backward:** Keep pressing the jog lever down (◀◀) during playback and release it at the point you wish to resume playback.

The unit searches at slow speed (unit of 4 seconds) with playback sound. It is useful to check one word forward or behind. Then, if you keep pressing the jog lever up or down, the unit starts to search at higher speed. During cue/review, the counter will be displayed, regardless of the display mode setting (page 53).

You can cue/review during playback pause. Press the jog lever up or down and release it at the point you want to resume playback pause.

Continued

Playing Back Messages (continued)

Tip

When fast playback is done to the end of the last message, "MSG. END" flashes for 3 seconds and the OPR indicator lights up in green. (You cannot hear the playback sound.)

If you keep pressing the jog lever down (◀◀) while "MSG.END" is flashing, the messages are played back rapidly, and normal playback will start at the point you release the button. When "MSG. END" stops flashing and the OPR indicator goes off, the unit will stop at the beginning of the last message.

If the last message is long and you wish to start playback at a later part of the message, keep pressing the jog lever up (▶▶) to go to the end of the message and then press the jog lever down (◀◀) while "MSG.END" is flashing to go back to the desired point .

(For messages other than the last one, go to the beginning of the next message and play backward to the desired point.)

Locating quickly the point you wish to start playback (Easy Search)

When EASY-S is set to ON (page 59) in the menu, you can quickly locate the point you wish to start playback by pressing the jog lever up or down (▶▶/◀◀) repeatedly during playback or playback pause.

You can go back approx. 3 seconds by pressing the jog lever down (◀◀) once, or advance approx. 10 seconds by pressing the jog lever up (▶▶) once. This function is useful when locating a desired point in a long recording.

Playing back a message repeatedly — Repeat Play

During playback, press the jog lever (■▶) for more than one second.

"MSG.REPEAT" will be displayed and the selected message will be played back repeatedly.

To resume normal playback, press the jog lever (■▶) again. To stop playback, press ■STOP.

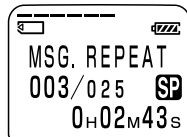

Playing back the specified section repeatedly — A-B Repeat

You can specify the start (A) and end (B) points and play back the specified section repeatedly (page 30).

Erasing Messages

You can erase the recorded messages one by one or all messages in a folder at a time.

Note that once a recording has been erased, you cannot retrieve it.

Erasing Messages one by one

When a message is erased, the remaining messages will advance and renumbered so that there will be no space between messages.

Erase Message 3

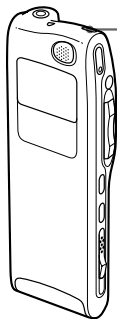
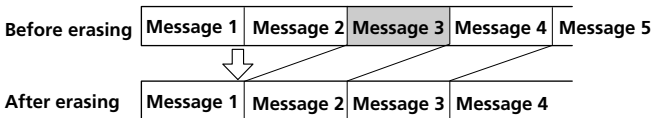

- 1 Press the ERASE button while playing back the message you want to erase or press the ERASE button for more than 1 second during stop mode.

A beep will sound and the message number and "ERASE?" will flash while the first and last 5 seconds of the message are played back 10 times.

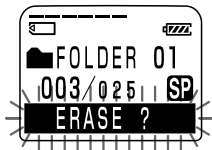

- 2 Press the ERASE button while the message is being played back.

The message is erased and the remaining messages will be renumbered. (For example, if you erase Message 3, Message 4 will be renumbered as Message 3. When erasing is completed, the unit will stop at the beginning of the following message.)

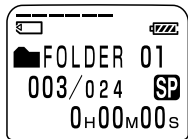

Continued

Erasing Messages (continued)

To cancel erasing

Press ■STOP before step ②.

To erase other messages

Repeat steps ① and ②.

To erase a message partially

First divide the message by adding an index (see page 33) and then follow the steps on page 25 to erase the message.

Note

An error message will be displayed in the display window when you cannot erase a message. For more information, see “Troubleshooting” (page 81).

Erasing All Messages in a Folder

You can erase all recorded messages in a folder, but the folder itself will not be deleted. If you want to delete a folder, see page 38.

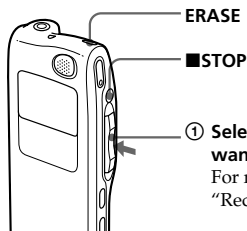

For more information see Step 1 of "Recording Messages" (page 16).

- ② While pressing ■STOP, press ERASE for more than 1 second.
"ERASE ALL?" will flash for 10 seconds.

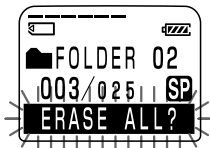

- ③ While the display is flashing, press ERASE.



To cancel erasing

Press ■STOP before step 3.

Notes

- While "ERASE ALL" is displayed in the display window or the OPR indicator flashes in orange, do not remove the "Memory Stick", batteries, or the AC adaptor. This may damage the data.
- An error message will appear in the display window when you cannot erase all messages in a folder. For more information, see "Troubleshooting" (page 81).

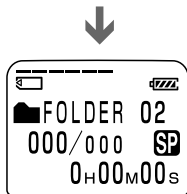

► Various Ways of Playback

Adjusting the Playback Speed — DPC (Digital Pitch Control)

You can adjust the speed of the playback between twice the normal speed (+100%) and half the normal speed (-50%). The message is played back in natural tone thanks to the digital processing function. You can change the playback speed during playback.

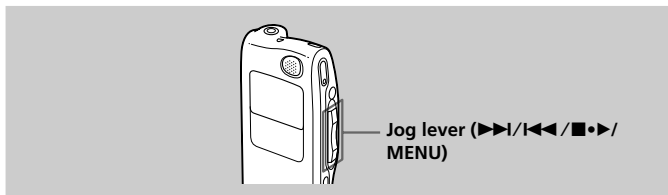

1 Turn the jog lever toward MENU to display the menu mode.

2 Press the jog lever up or down (▶▶/|◀◀) to select "DPC", then press the jog lever (■•▶).

The DPC setting mode will be displayed.

3 Set the playback speed.

① Press the jog lever up or down (▶▶/|◀◀) to select "ON", and then press the jog lever (■•▶).

② Press the jog lever up or down (▶▶/|◀◀) to set the playback speed:

- Slow play (down to -50% by 5%): Press down (|◀◀).
- Fast play (up to +100% by 10%): Press up (▶▶).

③ Press the jog lever (■•▶).

4 Press the jog lever toward MENU to exit the menu mode.

To resume normal playback

Select "OFF" and press the job lever (■•▶) in step 2.

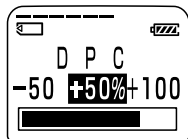
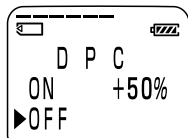

Adding a Bookmark

You can add a bookmark at a point in a message, so that you can access the point quickly by pressing the jog lever up or down (▶▶|/|◀◀) and start playback.

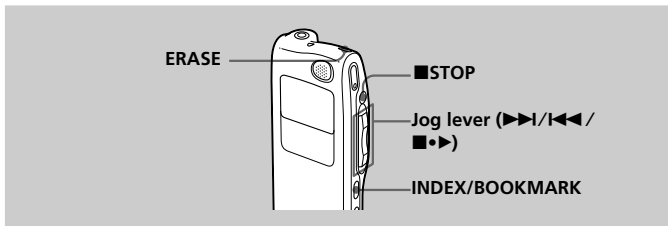

During playback or stop, press INDEX/BOOKMARK for more than 1 second.

A bookmark is added and the bookmark indicator (✍) flashes 3 times.

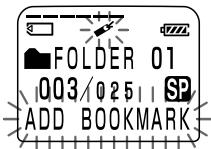

To start playback at the bookmark

Press the jog lever up or down (▶▶|/|◀◀) during stop so that the bookmark indicator flashes 3 times. Then press the jog lever (■•▶).

To delete the bookmark

- 1 In stop mode, press the jog lever up or down (▶▶|/|◀◀) to display the number of the message with the bookmark you wish to delete.
- 2 While pressing INDEX/BOOKMARK, press ERASE for more than 1 second.
- 3 Press ERASE while the bookmark indicator and "ERASE MARK?" are flashing.

Notes on adding/erasing index

- You can add only one bookmark in each message.
- If you add a bookmark, a previously added bookmark is deleted automatically.

Playing Back the Specified Section Repeatedly — A-B Repeat

While playing back a message, you can set the start (A) and end (B) points for a section you wish to play repeatedly.

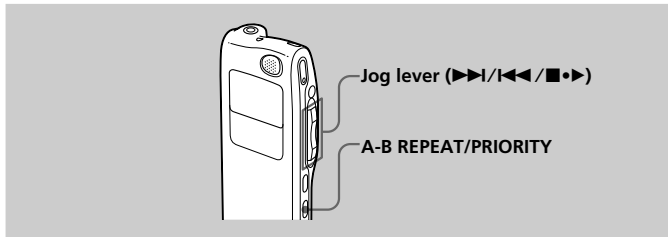

1 During playback, press A-B REPEAT/PRIORITY briefly.

The starting point (A) of the section you wish to play repeatedly is set. "A-B B?" flashes.

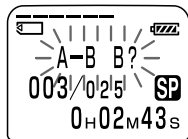

2 During playback, press A-B REPEAT/PRIORITY briefly.

The finishing point (B) of the section is set. "A-B" is displayed and the specified section is played back repeatedly.

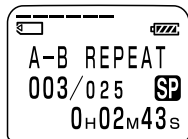

To resume normal playback

Press the jog lever (■•▶).

To stop A-B Repeat playback

Press ■STOP.

Notes

- You cannot set A-B Repeat for a section that overlaps two or more messages.
- If you do not set the finishing point (B), the finishing point is automatically set at the end (or the beginning) of the message.

Adding a Recording

Adding a Recording to a Previously Recorded Message

You can add a recording to the message being played back.

The added recording will be placed after the current message and counted as a part of the message.

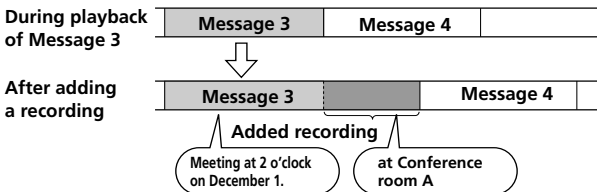
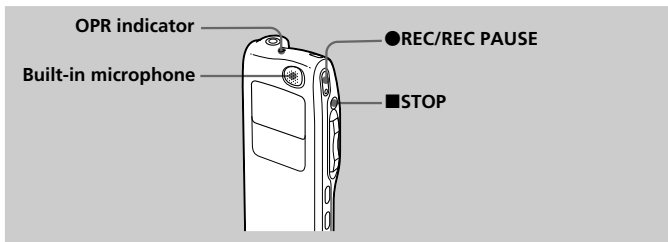

1 During playback, press ● REC/REC PAUSE for more than 1 second.

The "ADD REC" flashes three times on the display window. The OPR indicator will turn red.

The new recording will be added at the end of the current message.

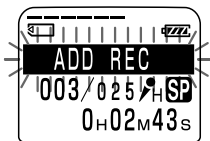

2 Press ● REC/REC PAUSE or ■ STOP to stop the recording.

Continued

Adding a Recording (continued)

Adding an Overwrite Recording during Playback

You can add an overwrite recording after the selected point in a recorded message. The part of the message after the selected point is deleted.

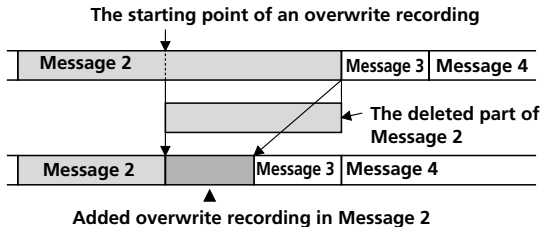

- 1** During playback, press **●REC/REC PAUSE** briefly.
“OVERWRITE?” flashes on the display window and the OPR indicator flashes in red.

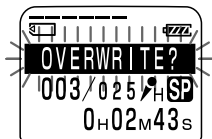

- 2** Press **●REC/REC PAUSE** to start recording.
“REC” is displayed and the OPR indicator turns red.
- 3** Press **■STOP** to stop the recording.

Notes

- The added message will be recorded in the same recording mode (SP or LP; see page 60) as the original message, regardless of the current recording mode setting.
- You cannot overwrite if the remaining memory of the “Memory Stick” is not long enough. For more information, see “Troubleshooting” (page 81).

Dividing a Message into Two/ Combining Messages — Index Function

You can divide a message by adding an index, or combine messages by erasing the index.

While recording/playing back messages, you can add an index (see below). In stop mode, you can erase the index (see page 35).

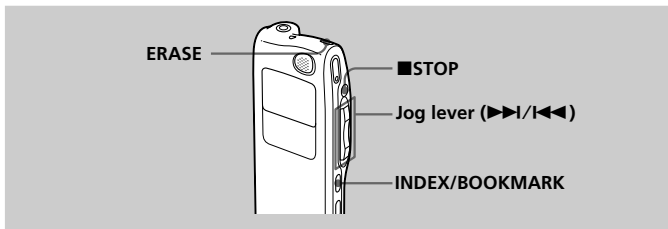

Dividing a Message by Adding an Index

You can add an index to a message during recording or playback.

By dividing a message, you can easily find the point you want to play back when you make a long recording such as a meeting.

When you add an index, the message numbers will increase as follows.

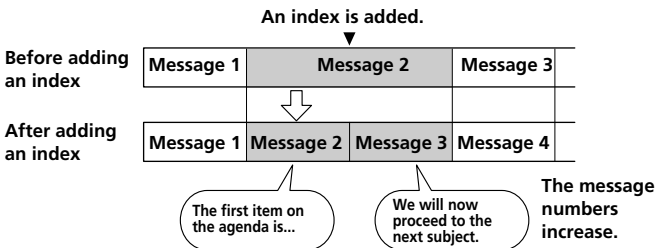

Continued

Dividing a Message into Two/Combining Messages — Index Function (continued)

To mark an index during recording

While recording a message, press INDEX/BOOKMARK at the point you want to divide. The new message number is added at the point you pressed INDEX/BOOKMARK button, and “ADD INDEX” flashes three times. The message will be divided in two messages; however, the messages will be recorded without a break.



An index is added.

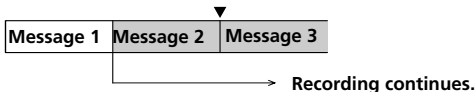

Tip

You can add an index during recording pause (page 18).

To add an index during playback

While playing back a message, press INDEX/BOOKMARK at the point you want to divide. The message is divided in two and the new message number flashes three times. An index mark is added and the following index numbers will increase by one.

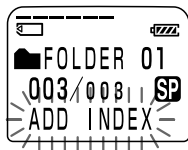

To play the message you marked with an index

Press the jog lever up or down (▶▶/◀◀) to display the message number as the divided messages each have message numbers.

To play the divided messages continuously

Select “ON” for “CONT.” in the menu as described in “Changing the Settings” on page 59.

Notes

- You need a certain amount of space in the “Memory Stick” to add an index. For more information, see “System Limitations” on page 88.
- You cannot add an index when “INDEX FULL” appears in the display window. Erase some messages before adding an index. For more information, see “System Limitations” on page 88.
- The recorded date and time of the latter part of the divided message by adding an index, is the same as that (the starting date and time of recording) of the divided message.
- If you add an index to a labeled message that was divided, the other part of the divided message will have the same message name.
- If you add an index to a message with priority mark(s), priority mark(s) will be added to both parts of the divided message.
- If you add an index to the point the bookmark is specified, the bookmark is erased.

Combining Messages by Erasing the Index

You can combine two messages into one by erasing the index.

An index is erased.

Message 1	Message 2	Message 3	Message 4
			
Message 1	Message 2	Message 3	

The message numbers decrease.

In stop mode, follow the steps below:

- 1** Press the jog lever up or down (▶▶/◀◀) to display the number of the second of the two messages you want to combine.

Continued

Dividing a Message into Two/Combining Messages — Index Function (continued)

- 2** While pressing INDEX/BOOKMARK, press ERASE for more than 1 second. "ERASE INDEX?" will flash for 10 seconds.

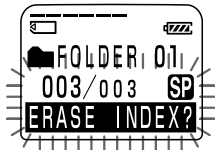

- 3** Press ERASE while the display is flashing.

The two messages are combined into one and the messages will be renumbered as in the illustration above.

To cancel erasing

Press ■STOP before step 3.

Notes

- After combining messages by erasing an index, the latter message's alarm setting, priority mark(s) and bookmark will be deleted.
- If a bookmark has been added to the message, the above steps first delete the bookmark (page 29). Repeat the steps to erase the index.
- Due to the recording system of an IC recorder, you may not be able to add or delete an index in some cases (pages 87 and 88).
- Depending on the file format of the message, you may not be able to add or delete an index (pages 87 and 88).

Adding / Deleting Folders

By default setting, there are three folders: "FOLDER 01", "FOLDER 02", and "FOLDER 03". You can add folders as you like. You can also delete unnecessary folders.

Note

The maximum number of folders you can add varies depending on the capacity of a "Memory Stick" or using conditions. "FOLDER FULL" is displayed in the display window when you cannot add any folder because of the system limitations of the IC recorder (page 88).

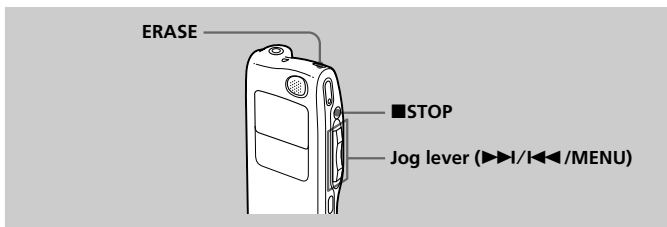

Adding Folders

- 1 Turn the jog lever toward MENU.**
The menu mode will be displayed.
- 2 Press the jog lever up or down (▶▶/◀◀) to select "NEW FOLDER", and then press the jog lever (■•▶).**
The new folder creation window will be displayed.
- 3 Press the jog lever up or down (▶▶/◀◀) to select "YES", and then press the jog lever (■•▶).**
"NEW FOLDER" will flash three times on the display and a folder will be added.

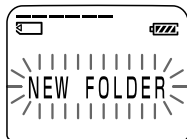

Continued

Adding / Deleting Folders (continued)

About added folder names

The new folder is labeled automatically with double figures or letter like "FOLDER 04" or "FOLDER AB". If there is a missing number or letter among the folder names, the new one is labeled using the missing number or letters automatically.

You can change the folder name as you like (page 42).

Deleting Folders

You can only delete a folder that has no recorded messages.

1 Select the folder you want to delete.

For information on selecting a folder, see step 1 of "Recording Messages" on page 16.

Note

You cannot delete a folder that has some recorded messages. First, erase all messages in the folder (see page 27) or move them (see the next page).

2 Press ERASE for more than 1 second while pressing ■STOP.

"ERASE FOLDER?" will flash for 10 seconds on the display.

3 Press ERASE while the display is flashing.

The folder will be deleted.

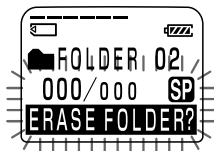

To cancel deleting

Press ■STOP before step 3.

Notes

- You cannot delete the last folder left in a "Memory Stick".
- After deleting a folder, the name of other folders are not changed. If "FOLDER 03" is erased, the name of "FOLDER 04" will remain the same.

Moving Messages to a Different Folder

You can move the recorded messages to another folder.

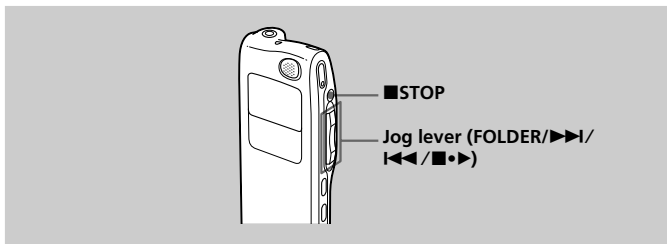

Example: Moving Message 3 in Folder A to Folder C

1 Play back the message you want to move.

2 Turn the jog lever toward FOLDER.

The first and last 5 seconds of the message will be played back 10 times, while "MOVE MSG." is displayed and flashes and the destination folder with a black background.

3 Press the jog lever up or down (▶▶/◀◀) to select the folder you want to move the message into, and then press the jog lever (◼▶).

The message is moved in the destination folder. Messages are sorted in order of the recorded date and time or the number of the priority marks in the folder.

The folder with the message you want to move

The destination folder



To cancel moving the message(s)

Press ■STOP before step 3.

Note

The move function does not duplicate a message in another folder. When you move a message to another folder, the one in the previous folder will be deleted.

Adding Priority Mark(s) — Priority Mark Function

Usually the recorded messages are lined up in the order of recording. By adding priority marks (▲) to important messages, you can renumber the messages in the order of their priority. There are four levels, “▲▲▲” (the most important), “▲▲”, “▲”, and no priority mark. You can add priority marks both in the stop mode and in playback mode.

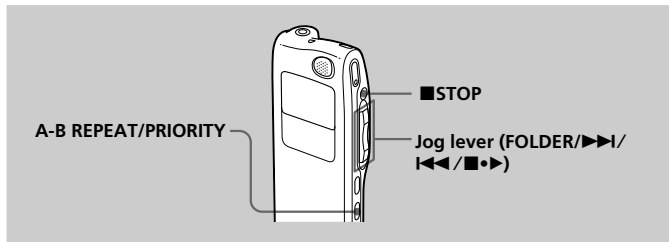

Adding Priority Mark(s) in the Stop Mode

- 1 Select the message you want to mark.
- 2 Press **A-B REPEAT/PRIORITY** for more than 1 second.
“▲” and “PRIORITY” will flash on the display window.

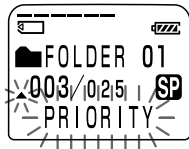

- 3 Press **A-B REPEAT/PRIORITY** repeatedly to select the number of priority mark(s) (▲) while “PRIORITY” is flashing.
The setting is finished when the priority mark(s) (▲) light(s) steadily in the display window and the messages are renumbered.

Adding Priority Mark(s) during Playback

- 1** Press A-B REPEAT/PRIORITY button for more than 1 second during playback of the message you want to mark.

“▲” and “PRIORITY” will flash on the display window while the first and last 5 seconds of the message is played back 10 times.

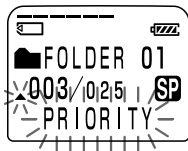

- 2** Press A-B REPEAT/PRIORITY repeatedly or press the jog lever up or down (▶▶|/◀◀) to select the number of priority mark(s) (▲).

- 3** Press the jog lever (■•▶) to fix the setting.

The setting is finished and the messages will be renumbered.

Messages with priority mark(s)

Messages are sorted in order of the number of priority mark(s) (▲) in a folder. Messages without a priority mark are moved behind the messages with priority mark(s).

Tip

If there are over 2 messages with the same number of priority marks in a folder, these messages are sorted by the recorded date and time (The oldest one comes first).

e.g. When there are 3 messages in a folder

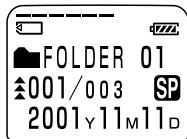

Message 1

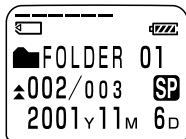

Message 2

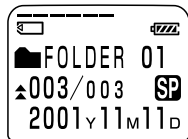

Message 3

Note

You can also add priority mark(s) using the supplied “Memory Stick Voice Editor” software. But messages are not sorted in order of the number of the priority marks unless you sorted by the number of priority marks using the software.

Labeling Folders or Messages — Folder/Message/User Name

You can label folders, messages, or the user name of the messages yourself.

Tip

You can also label folder or messages using the supplied "Memory Stick Voice Editor" software. For more information, see online help.

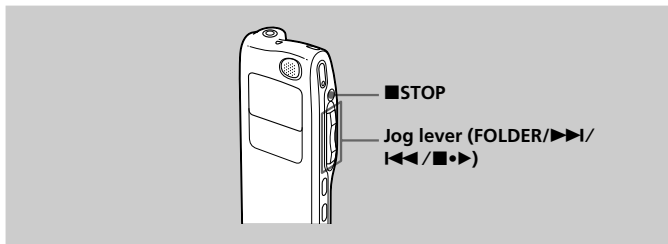

Labeling Folders

Folders have been labeled automatically like "FOLDER 03", but you can label folders as you like by using template names or creating on your own.

- 1 Turn the jog lever toward MENU.**
The menu mode will be displayed.
- 2 Press the jog lever up or down (▶▶|/|◀◀) to select "FOLDER NAME", and then press the jog lever (■•▶).**
The folder name input window will be displayed.
- 3 Press the jog lever up or down (▶▶|/|◀◀) to select "TEMPLATES" or "ALPHABET", and press the jog lever (■•▶).**

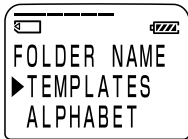
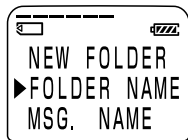

4 Set the folder name.

To select a folder name from templates:

Press the jog lever up or down (▶▶|/|◀◀) to select a template name and press the jog lever (■•▶) to set the name.

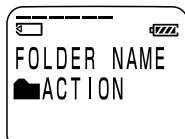

Registered template names

ACTION, SCHEDULE, MEETING, OFFICE, HOME, MEMO, REPORT, SPEECH, INTERVIEW, TRAVEL, PERSONAL, PLACE, SHOP LIST, CLASS, MESSAGE, EXPENSE

⚙ Longer folder names

You can change the folder name selected from the templates later by the method to enter characters.

To enter characters:

You can enter up to 44 characters to label a folder.

The cursor flashes after the last character of the current folder name. You can add after the current name or change it.

To enter and replace characters, see page 46.

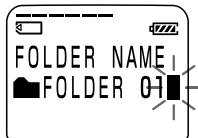

5 Press the jog lever (■•▶) for more than one second to fix the name.

6 Turn the jog lever toward MENU to exit the menu mode.

The window will return to normal display.

⚙ Longer folder names

The display window can display up to 10 characters only.

If the name is more than 10 characters, it can be read by scrolling in the display window when the folder name is selected (see step 1 on page 16 or 21).

The name cannot be scrolled in other display windows.

⚙ To cancel labeling

Press ■STOP.

Continued

Labeling Folders or Messages — Folder/Message/ User Name (continued)

Labeling Messages

Messages are not labeled automatically, but you can label messages yourself.

- 1 Turn the jog lever toward MENU.**
The menu mode window will be displayed.

- 2 Press the jog lever up or down (▶▶|/
|◀◀) to select “MSG. NAME”, and then
press the jog lever (■•▶).**

The message name input window will be displayed.

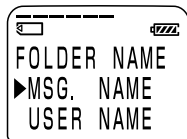

- 3 Enter characters.**

You can enter up to 254 characters to label a message.

To enter and replace characters, see page 46.

- 4 Press the jog lever (■•▶) for more than
one second to fix the name.**

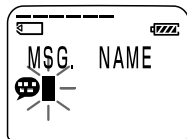

- 5 Turn the jog lever toward MENU to
exit the menu mode.**

The window will return to normal display.

Longer message names

The display window can display up to 10 characters only.

If the name is longer, it can be scrolled when changing display modes or during playback of the message.

To cancel labeling

Press ■STOP.

Setting the User Name

By setting the IC recorder user name, you can automatically add the user name to a recorded message. When the message is displayed in the “Memory Stick Voice Editor” software, the user name specified here is displayed as “User Name”.

Note

The user name is not displayed on the IC recorder.

1 Turn the jog lever toward MENU.
The menu mode window will be displayed.

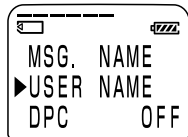

2 Press the jog lever up or down (▶▶/◀◀) to select “USER NAME”, and then press the jog lever (■•▶).
The user name input window will be displayed.

3 Enter characters.

You can enter up to 20 characters for a user name.
To enter and replace characters, see page 46.

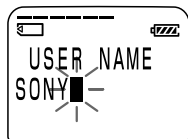

4 Press the jog lever (■•▶) for more than one second to fix the name.

5 Turn the jog lever toward MENU to exit the menu mode.

The window will return to normal display.

 **To cancel setting the user name**

Press ■STOP.

Continued

Labeling Folders or Messages — Folder/Message/ User Name (continued)

Entering Characters

Follow the steps below when the display prompts to enter characters (when the cursor is flashing in step 4 for labeling a folder on pages 43, or in step 3 for labeling a message and changing the user name on pages 44 and 45).

To enter characters

- ① Press the jog lever up or down (▶▶|/|◀◀) to select the desired character.
See the order of character sets on the next page.
- ② Press the jog lever (■•▶) briefly to fix.
The cursor moves to the next.
- ③ Repeat steps ① and ② to enter other characters.

To replace characters

When you make a mistake in entering a character or when you want to change the name, enter again after all characters have been deleted by pressing ERASE for more than one second or replace some of the characters as follows.

- ① Place the cursor at the character you want to change.
To move the cursor back (to the left), press INDEX/BOOKMARK briefly.
To move the cursor forward (to the right), press the jog lever (■•▶) briefly.
- ② Press the jog lever up or down (▶▶|/|◀◀) to select the desired character.
To delete a character and close up the space, place the cursor at the character you want to delete and press ERASE briefly.
- ③ Press the jog lever (■•▶) to move the cursor forward and repeat steps ① and ② to change other characters.

Note

You cannot insert a character into a name. You must simply replace all the characters following the character you want to insert.

Using the jog lever and buttons when labeling a folder / message

Do this	To do
Press the jog lever (■●▶) briefly	Set a character (The cursor moves the next).
Press the jog lever (■●▶) for more than 1 second	Set the name (Finishing entering the name).
Press the jog lever up (▶▶) briefly	Select characters (move to the next).
Press the jog lever up (▶▶) for more than 1 second	Select characters (move to the next quickly).
Press the jog lever down (◀◀) briefly	Select characters (return to the previous).
Press the jog lever down (◀◀) for more than 1 second	Select characters (return to the previous quickly).
Turn the jog lever toward FOLDER briefly	Change the character set.
Press ERASE briefly	Erase a character.
Press ERASE for more than 1 second	Erase all characters.
Press INDEX/BOOKMARK briefly	The cursor moves back to the left.
Press INDEX/BOOKMARK for more than 1 second	The cursor moves back to the left quickly.

Character sets

Order	Characters
1 (Capital letters)	A B C D ~ X Y Z
2 (Symbol 1)	' , / : (space)
3 (Small letters)	a b c d ~ x y z
4 (Symbol 1)	' , / : (space)
5 (Numbers)	0 1 2 ~ 8 9
6 (Symbol 2)	! # \$ % & () * . ; < = > ? @ _ ' + - ' , / : (space)

►Other Functions

Playing Back a Message at a Desired Time with an Alarm

You can sound an alarm and start playback of a selected message at a desired time.

You can use this function to remind you of the date and time of a meeting, etc. You can have the message played back at a specified date, once every week, or the same time everyday.

You can also sound the alarm without playing back a message.

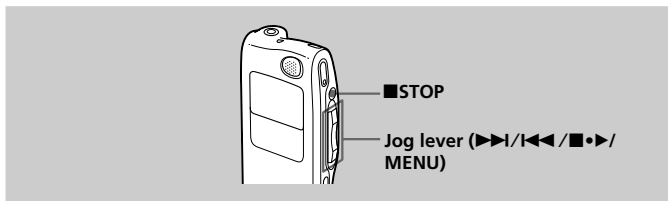

1 Select the message you want to play back.

For more information about selecting the desired message, see step 1 and 2 of "Playing Back Messages" on page 21.

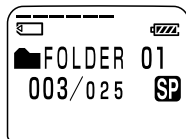

2 Enter the alarm setting mode.

- ① Press the jog lever toward MENU.
The menu mode will be displayed in the display window.
- ② Press the jog lever up or down (▶▶/◀◀) to select "ALARM".
- ③ Press the jog lever (■•▶).
The alarm setting mode will be displayed in the display window.
- ④ Press the jog lever up or down (▶▶/◀◀) to select "ON".
If "ON" has already been selected, follow the next steps.

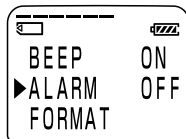

- ⑤ Press the jog lever (■•▶).
“DATE” will be displayed in the display window.



3 Set the alarm date and time.

To play back on a desired date

- ① Press the jog lever (■•▶) while “DATE” is displayed.
The year digits will flash.
- ② Press the jog lever up or down (▶▶|/|◀◀) to select the year digits and press the jog lever (■•▶).
The month digits will flash.
- ③ Set the month, day, and the time in sequence, then press the jog lever (■•▶).

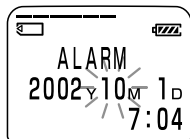
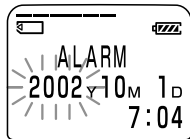

To play back once a week

- ① Press the jog lever up or down (▶▶|/|◀◀) to select the day of the week (“SUN” for Sunday to “FRI” for Friday).
- ② Press the jog lever (■•▶).
The hour digits will flash.
- ③ Press the jog lever up or down (▶▶|/|◀◀) to select the hour digits, and press the jog lever (■•▶).
The minute digit will flash.
- ④ Press the jog lever up or down (▶▶|/|◀◀) to select the minute digits, and press the jog lever (■•▶).

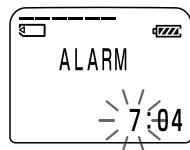
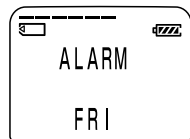

Continued

Playing Back a Message at a Desired Time with an Alarm (continued)

To play back at the same time every day

- ① Press the jog lever up or down (▶▶|/|◀◀) to select "DAILY".
- ② Press the jog lever (■•▶).
The hour digits will flash.
- ③ Press the jog lever up or down (▶▶|/|◀◀) to select the hour digits, and press the jog lever (■•▶).
The minute digit will flash.
- ④ Press the jog lever up or down (▶▶|/|◀◀) to select the minute digits, and press the jog lever (■•▶).

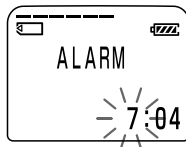
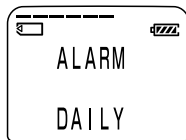

4 Select the alarm sound.

- ① Press the jog lever up or down (▶▶|/|◀◀) to select "BEEP & PLAY" or "BEEP ONLY".
- ② Press the jog lever (■•▶).



5 Press the jog lever toward MENU to exit the menu mode.

The display returns to the normal display.
"(*)" is displayed when the message having an alarm setting is selected.

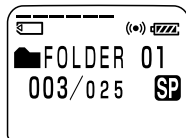

When the set date and time comes

At the set time, the alarm will sound for about 10 seconds and the selected message will be played back (If you have selected "BEEP ONLY" in step 4, only the alarm will sound).

During alarm playback, "ALARM" will flash in the display window.

When the playback ends, the unit will stop automatically at the beginning of that message.

To listen to the same message again

Press the jog lever (■•▶). The same message will be played back from the beginning.

To cancel the alarm setting before the playback starts

Press ■STOP while the alarm sound is heard. You can stop even when the HOLD function is activated.

Notes

- If the alarm time comes while another message is being played back with an alarm, the playback stops and the new message will be played back.
- If the alarm time comes during recording, the alarm will sound after the recording is finished. “(●)” will flash when the alarm time comes.
- If more than one alarm time comes during recording, only the first message will be played back.
- When the alarm time comes when the unit is in the menu mode, alarm will sound and the menu mode will be cancelled.
- If you erase the message you set the alarm for, the alarm setting will be cancelled.
- If you add an index to the message you set the alarm for, alarm setting remains on only the first part of the divided message.
- If you erase the index on the message you set the alarm for, the alarm setting of the latter message will be cancelled.
- You can adjust the playback volume with VOL +/-.
- If the alarm time comes during erasing, the alarm will sound after the erasing is finished.
- Alarm setting will not be cancelled when the alarm playback finishes. To cancel alarm setting, see below.

To check the alarm setting

Follow steps 1 and 2 on page 48 after selecting the alarm setting. The alarm date and time will be displayed in the display window.

To cancel the alarm setting or change the alarm time

- ① Select the message you set the alarm for, and press the jog lever toward MENU.
- ② Press the jog lever up or down (▶▶/◀◀) to select “ALARM” and press the jog lever (■●▶).

The current alarm setting is displayed.



- ③ **To cancel the alarm setting:** Press the jog lever up or down (▶▶/◀◀) to select “OFF” and press the jog lever (■●▶).

To change the alarm date and time: Press the jog lever (■●▶).

When the alarm date is displayed, follow steps 3 to 5 on pages 49 and 50 to change the alarm date and time.

- ④ Press the jog lever toward MENU to exit the menu mode.

Preventing Accidental Operation — HOLD function

HOLD switch

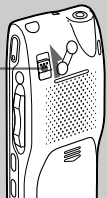

Slide the HOLD switch in the direction of the arrow. “HOLD” will flash three times, indicating that all the functions of the buttons are locked. When the HOLD function is activated during stop, all the display will be turned off after “HOLD” flashes three times.

To cancel the HOLD function, simply slide the HOLD switch in the opposite direction.

Note

When the HOLD function is activated during recording, cancel the HOLD function first to stop recording.

Tip

Even if the HOLD function is activated, you can stop the alarm playback. To stop the alarm or playback, press ■STOP. (You cannot stop usual playback.)

Selecting the Display Mode

You can select the display mode for stop, recording and playback modes.

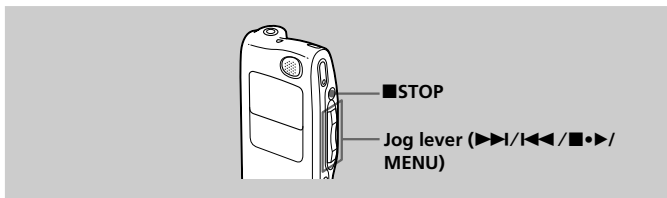

1 Turn the jog lever toward MENU.

The menu mode will be displayed.

2 Press the jog lever up or down (▶▶|/|◀◀) to select "DISPLAY", and then press the jog lever (■●▶).

The display setting window will be displayed.

3 Press the jog lever up or down (▶▶|/|◀◀) to select the display mode.

You can select the display from the following:

ELAPSE TIME (counter)

Elapsed playback/recording time of one message.

REMAIN TIME (remaining time)

In the playback mode: The remaining time indication of the message.

In the stop and recording mode: The remaining recording time indication.

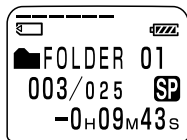
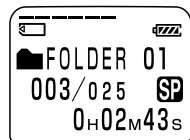
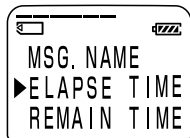

During playback

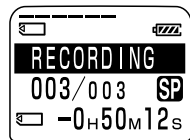

During recording
or stop

Continued

Selecting the Display Mode (continued)

REC DATE (recorded date)

The date the current message was recorded. (If the clock has not been set, “---Y--M--D” will be displayed.)

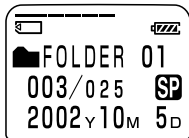

REC TIME (recorded date and time)

The date and time the current message was recorded. (If the clock has not been set, “--M--D--:--” will be displayed.) Only the starting time of the recorded message is displayed. The displayed time does not advance during the recording.

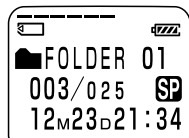

CODEC (file format)

The file format of the current message (LPEC or ADPCM)

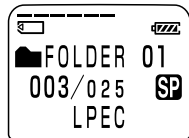

MSG.NAME (message name)

The message name will be displayed in the display window. If the message has no name, the message name will not be displayed in the display window.

Longer message names

A message name with more than 10 characters will be displayed with the scroll function.

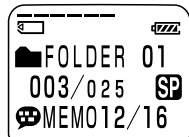

4 Press the jog lever (■●▶).

5 Turn the jog lever toward MENU to exit the menu mode.

On Sleep display mode

If the unit is left unused for more than 3 seconds in the stop mode, the display will turn to sleep display mode as shown to the right, regardless of the display mode setting.

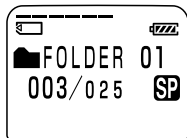

To display the current time

Press ■STOP button during the sleep display mode. The current time will be displayed for 3 seconds in the display window.

Formatting a "Memory Stick"

You can format a "Memory Stick" using the Memory Stick IC Recorder. Formatting will delete all data recorded in the "Memory Stick" including images and other data. Before formatting, check the data in the "Memory Stick".

Because a commercially available "Memory Stick" has already been formatted at the factory, you do not need to format a "Memory Stick" before the first use.

The supplied "Memory Stick" has also already been formatted.

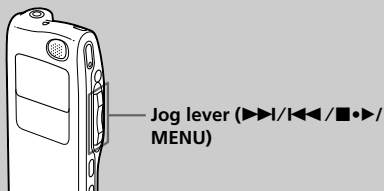

1 Turn the jog lever toward MENU.

The menu mode will be displayed in the display window.

2 Press the jog lever up or down (▶▶I/I◀◀) to select "FORMAT."



3 Press the jog lever (■•▶).

The formatting window will be displayed.

4 Press the jog lever up or down (▶▶I/I◀◀) to select "YES".

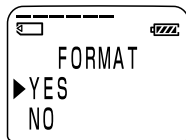

5 Press the jog lever (■•▶).

“OK?” will be displayed in the display window.

6 Press the jog lever (■•▶) again.

Formatting starts.

“FORMATTING” will be displayed on the display.

After formatting, the display in step 2 will appear in the display window.

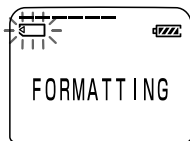

7 Press the jog lever toward MENU to exit the menu mode.

The window will return to normal display.

After formatting, three folders are automatically made in the “Memory Stick” (This is the same after inserting a “Memory Stick” for the first time.)

To cancel formatting

Select “NO” in the step 4 or press ■STOP while “OK ?” is displayed in step 5.

Note

You cannot format when the write-protect switch on the “Memory Stick” is set to “LOCK”.

Changing the Settings — MENU

Operating the Menu

During stop, playback or recording, you can use the menu to change the operation modes in playback and recording, display mode, or other settings. Display the menu and change the settings as follows:

- 1 Turn the jog lever toward MENU.**
The menu mode will be displayed.
- 2 Press the jog lever up or down (▶▶|/|◀◀) to select the menu item for which you want to change setting.**
The “Menu items” on the next page will be displayed. During playback and recording, the menu items to be displayed are limited.
- 3 Press the jog lever (■•▶).**
The setting mode of the selected menu item will be displayed.
- 4 Press the jog lever up or down (▶▶|/|◀◀) to select the setting that you want to set, and then press the jog lever (■•▶).**
The setting will be changed. For the settings, refer to the “Menu items” on the next page.
- 5 Turn the jog lever toward MENU to exit the menu mode.**
The window will return to normal display.

Menu Items

Menu items	Settings (*: Initial setting)
MIC SENS	H *(high): To record at meetings or in a quiet and/or spacious place. L (low): To record dictation or in a noisy place.
VOR	ON: The VOR (Voice Operated Recording) function is activated. Recording starts when the unit detects sound and stops when no sound is heard, eliminating recording from soundless period. OFF*: The VOR function is disabled. Normal recording operation is selected.
NEW FOLDER	Displays the window to add a new folder (YES/NO*). See page 37.
FOLDER NAME	Displays the window to change a folder name. See page 42.
MSG.NAME	Displays the window to change the message name. See page 44.
USER NAME	Displays the window to change the IC recorder user name. See page 45.
DPC	Displays the window to set the playback speed (ON/OFF*). See page 28.
CONT.	ON: You can play back all messages in a folder continuously. OFF*: Playback stops at the end of each message.
EASY-S	ON: You can go back for approx. 3 seconds by pressing the jog lever down (◀◀), or advance for approx. 10 seconds by pressing the jog lever up (▶▶). OFF*: You can go back or forward the messages by pressing the jog lever down or up (◀◀/▶▶).

Continued

Changing the Settings — MENU (continued)

Menu items	Settings (*: Initial setting)
BEEP	ON*: A beep will sound to indicate that operation has been accepted. OFF: No beep sound will be heard except for the alarm.
ALARM	Displays the window to set the alarm (ON/OFF*). See page 48.
FORMAT	Displays the window to format a "Memory Stick" (YES/NO*). See page 56.
SET DATE	Displays the window to set the clock. See page 12.
DISPLAY	Displays the window to change the display mode. See page 53.
MODE	SP*: You can record with better sound. LP: You can record for longer time. For the maximum recording time, see page 7.

☞ **When no "Memory Stick" is inserted**

"NEW FOLDER", "FOLDER NAME", "MSG. NAME", "ALARM", "FORMAT" and "DISPLAY" menu items will not be displayed in the menu mode.

☞ **During playback**

You can change settings for "DPC", "CONT.", and "DISPLAY" menu items only.

☞ **During recording**

You can change settings for "MIC SENS", "VOR", and "DISPLAY" menu items only.

► "Memory Stick Voice Editor" Software Operations

Overview of the Software

What You Can Do with the "Memory Stick Voice Editor" Software

"Memory Stick Voice Editor" software allows you to transfer the messages to your display monitor, to save them on your computer's hard disk, and to play back and edit them.

Transferring the messages recorded on the IC recorder to your computer

You can transfer the messages to your computer and save them onto your computer's hard disk with either of the following methods:

- Removing the "Memory Stick" from the IC recorder and inserting it to your computer

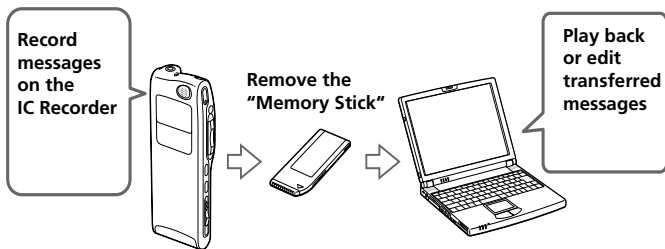

- Connection the USB connectors of the IC recorder and your computer

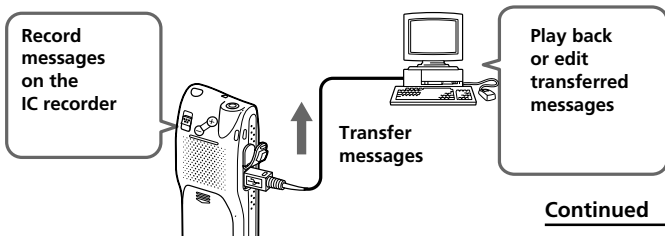

Continued

Overview of the Software (continued)

Saving the messages on your computer's hard disk

You can save the messages in the "Memory Stick" on your computer's hard disk. You can save them as the following file formats.

- MSV (Memory Stick Voice LPEC) file
- MSV (Memory Stick Voice ADPCM) file
- DVF (Digital Voice) file
- WAV file (8-/16-bit)

Viewing, playing, or editing the messages on your computer

In the "Memory Stick Voice Editor" window, you can do the following:

- You can display the list of messages contained in the Memory Stick and in your computer's hard disk.
- The message can be played back through computer's speakers. In addition to the normal playback, you can also enjoy various ways of playback.
- You can edit messages: renaming messages or folders, changing the priority or alarm settings, dividing/combining messages, or sending a voice e-mail. You can also convert the file format of a PC message.

Transferring messages back to the "Memory Stick" for playing back with the IC recorder

The messages saved in your computer or sound files (MSV, DVF, WAV, or MP3 files) received with an e-mail message can be added to the "Memory Stick" as MSV files, which can be played back on the IC recorder.

About the File Formats

The "Memory Stick Voice Editor 2" can handle the following file formats. You can save them on your computer's hard disk, play them back, edit them, or attach them to an e-mail. The file formats can also be converted into each other (some file conversion is not possible.).

MSV(LPEC) file (Memory Stick Voice file/file extension: *.msv)

The MSV(LPEC) file is a sound file format used in recording messages on this unit. The sound data is compressed so that the size of the data is relatively small. You can edit and play back the MSV(LPEC) files on the "Memory Stick Voice Editor 2", write them on the "Memory Stick" to be restored and played back on this unit.

MSV(ADPCM) file (Memory Stick Voice file/file extension: *.msv)

The MSV(ADPCM) file is a sound file format used in recording messages on the Memory Stick IC recorder ICD-MS1. You can play back and edit the MSV(ADPCM) files on the "Memory Stick Voice Editor".

On this unit, the MSV(ADPCM) files can only be played back. (No edition is possible.) On the "Memory Stick Voice Editor 2", an MSV (ADPCM) file can be converted into an MSV (LPEC) file and can be written on the "Memory Stick" to be played back and edited on this unit.

DVF file (Digital Voice File/file extension: *.dvf)

The DVF file is a sound file format used in recording messages on the Sony ICD-BP Series IC recorder equipped with a USB port. You can edit and play back the DVF files on both the "Memory Stick Voice Editor" and the Digital Voice Editor.

On the "Memory Stick Voice Editor 2", a DVF file can be converted into an MSV(LPEC) file and can be written on the "Memory Stick" to be played back on this unit.

Continued

Overview of the Software (continued)

WAV file (8/11/16kHz, 8/16 bit, monaural/44.1kHz, 16 bit, stereo wav file/file extension: *.wav)

The WAV file is a PCM 8/11/16kHz, 8/16 bit monaural, or 44.1kHz 16 bit stereo sound file used in recorded sound in standard Windows application software. You can play back a WAV file on the “Memory Stick Voice Editor” and on Windows software such as the “Sound Recorder”.

On the “Memory Stick Voice Editor 2”, a 11/16/44.1kHz WAV file can be converted into an MSV(LPEC, SP) and an 8 kHz WAV file can be converted into an MSV (LPEC, LP) file. They can be written on the “Memory Stick” to be played back on this unit.

ICS file (Sony IC recorder Sound file/file extension: *.ics)

The ICS file is Sony’s original sound file format used in recording messages on the IC recorder ICD-R100/R200. The “Memory Stick Voice Editor 2” does not support an ICS file. To use an ICS file with the “Memory Stick Voice Editor 2”, use the software compatible with the ICS file format such as “Sony ICD-PCLINK software” to convert an ICS file into a WAV file.

MP3 file (MP3 file/file extension: *.mp3)

The MP3 file, short for MPEG-1 Layer 3 (Moving Pictures Expert Group), stores digital audio such as sounds or songs and is commonly used to distribute it over internet. The file is compressed with little loss in sound quality. You can play back an MP3 using an MP3 player.

On the “Memory Stick Voice Editor 2,” an MP3 file can be viewed in the PC message list, played back and attached to an e-mail message. To view an MP3 file, select and check [View MP3 Files] from the [View] menu. You can also convert an MP3 file into an MSV file and add to the “Memory Stick.” For details, see the software online help.

About the "Memory Stick" Folder Structures

The "Memory Stick" contains the following folder structures with the VOICE folder as the root folder.

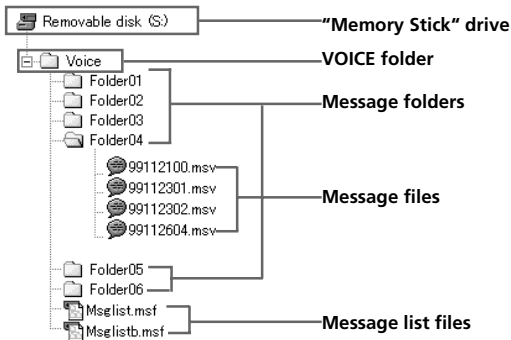

VOICE folder

The VOICE folder is to control messages properly both in the "Memory Stick Voice Editor" and the Memory Stick IC recorder.

When you insert a "Memory Stick" without the VOICE folder into your computer for the first time, the initial settings are performed and three message folders named "FOLDER 01," "FOLDER 02," and "FOLDER 03" are created. A message folder contains message files (*.msv).

Message list file

The message list file (Msglist.msf) describes and controls the VOICE folder structure, message and folder names, the number of messages contained in each message folder, the priority and alarm settings, and other file and folder information. A backup file (Msglistb.msf) is also saved.

Notes

- Windows Explorer can also view the folder structures of a "Memory Stick" in the same way, but never edit, move, copy, or delete messages in Explorer's window.
- Folder and files names indicated in Windows Explorer are different from the actual folder and message names (page 42).

Continued

65^{GB}

Overview of the software (continued)

Note on formatting a “Memory Stick”

To initialize a “Memory Stick”, make sure to use “FORMAT” menu of this unit. For details, see page 56.

System Requirements

Your computer and system software must meet the following minimum requirements.

- IBM PC/AT or compatible
 - CPU: 266MHz Pentium® II processor or higher
 - RAM: 64MB or more
 - Hard disk space: 70MB or more depending on the size and number of sound files you store.
 - CD-ROM drive
 - USB port
 - Sound board: Sound Blaster 16 compatible
 - Display: High color (16 bits) or more and 800 x 480 dots or more
- OS: Microsoft® Windows® XP Home Edition/XP Professional/2000 Professional/Millennium Edition/98/98 Second Edition standard installation (You cannot use this software with Windows® 95 or Windows® NT.)

Notes

- You cannot use the software with a Macintosh machine.
- A handmade computer, a computer whose operating system is installed or upgraded by the user, or a computer with multi-boot operating environment are not supported.
- If you do not connect your IC recorder to your computer via USB connectors, you need a computer with a “Memory Stick” slot or optional “Memory Stick” adaptors as shown below to transfer the “Memory Stick” data to your computer:
 - PC Card Adaptor for Memory Stick (MSAC-PC2N)
 - Memory Stick Reader/Writer (MSAC-US1/MSAC-US5)

Depending on the adaptors, more system requirements may be needed. We do not recommend the use of a floppy disk adaptor for “Memory Stick”.

Note on transcribing a message

When you use Dragon NaturallySpeaking® speech-recognition software to transcribe a message, your computer must also meet the system requirements that the Dragon NaturallySpeaking requires. For details, see "Guide for Voice Recognition".

Note on sending a voice e-mail

When you use Microsoft® Outlook Express 5.0/5.5/6.0 to send a voice e-mail of a message, your computer must also meet the system requirements that the Outlook Express requires.

Installing the software

Install “Memory Stick Voice Editor” software in your computer’s hard disk.

Notes

- When installing or uninstalling the software in Windows® 2000 Professional, make sure to log on Windows as the user name of “Administrator.”
- When installing or uninstalling the software in Windows® XP Professional/ Home Edition, log on as a user name with the “Computer administrator” user account. (To find if the user name has a “Comptuer administrator” user account, open the “User Accounts” from the “Control Panel” and refer to the section beneath the user name being displayed.
- After installing, the Microsoft DirectX module is also installed depending the operation system of your computer. This module is not deleted after uninstalling the software.

1 Turn on your computer and start up Windows.

Notes

- Be sure to close all running programs before installing the “Memory Stick Voice Editor” software.
- When a previous version of the “Memory Stick Voice Editor” software has already been installed, installing a newer version automatically remove the previous version. (Messages are not removed.)

2 Insert the supplied CD-ROM into the CD-ROM drive.

The installer starts up automatically and the following window appears. If the installer does not start up, double click [MSVE Setup.exe] in the [English] folder.



3 Follow the displayed instructions.

When the [Restart] dialog box appears, click [OK] to restart the computer.

Now the installation is completed.

Uninstalling the software

When you wish to uninstall the software, follow the steps below.

1 Click [Start] and select [Programs], [Sony Memory Stick Voice Editor 2.0] and then [Uninstall].

The uninstaller starts up.

2 Follow the displayed instructions.

Note

If you wish to move the software to another drive or directory after it is installed, you need to uninstall the software and then reinstall it. The software does not work properly if you just move the files.

Tips

- You can also start up the uninstaller by clicking [Start] and then selecting [Settings], [Control Panel], and [Add/Remove Programs].
- Uninstallation does not remove the message files.

Transferring the “Memory Stick” data onto your computer

You can transfer the Memory Stick data onto your computer either by connecting the IC recorder to the computer or inserting the Memory Stick into the computer.

Connecting the IC Recorder to your Computer

Use the USB connecting cable supplied with the IC recorder to connect the USB connectors of the IC recorder and your computer.

The IC recorder is recognized by the computer as soon as the cable is connected. You can connect or disconnect the cable when the IC recorder and the computer are turned on or off.

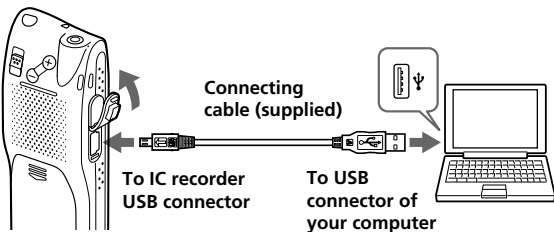

Notes

- Be sure to install the “Memory Stick Voice Editor” software before connecting the IC recorder to your computer.
- Do not connect more than two USB devices to your computer. Normal operation will not be guaranteed.
- Use of this IC recorder with a USB hub or a USB extension cable is not guaranteed.
- A malfunction may occur depending on the USB devices connected at any one time.
- Before connecting the IC recorder to the computer, check the remaining battery power of the IC recorder (more than one segment of the battery indicator “” should be on) . If the batteries are exhausted, communication between the IC recorder and the computer may not succeed.
- When you connect the IC recorder to the computer, make sure that the IC recorder is in the stop mode.
- We recommend you disconnect the cable from the computer when you do not use the “Memory Stick Voice Editor”.

Inserting a "Memory Stick" to your Computer

Remove the "Memory Stick" from the IC recorder and insert it to your computer by using either of the following methods:

If your computer has a "Memory Stick" slot

Insert the "Memory Stick" directly into the slot.

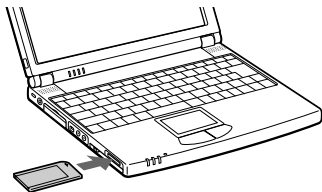

If your computer does not have a "Memory Stick" slot

Use either of the adaptors below to insert the "Memory Stick" to your computer. In either case, you need to install the driver for the adaptor. For details, refer to the instruction manual of the adaptor you use.

- **Using the Sony PC Card Adaptor MSAC-PC2N**

Insert the "Memory Stick" into the PC Card Adaptor. Then insert the PC Card Adaptor into the PC card slot of your computer.

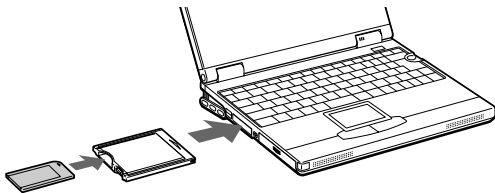

Note

When using the PC Card Adaptor, make sure to release the LOCK switch of the "Memory Stick".

Continued

Transferring the “Memory Stick” data onto your computer (continued)

- Using the USB-compatible Sony Memory Stick Reader/Writer MSAC-US1 or MSAC-US5

Connect the Memory Stick Reader/Writer to the USB port of your computer with the supplied cable. Insert the “Memory Stick” into the Memory Stick Reader/Writer.

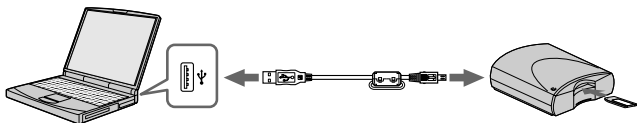

Starting the software

Starting/Exiting the Software

- 1 Turn on your computer and start Windows.
- 2 Connect the IC recorder to your computer or remove the "Memory Stick" from your IC recorder and insert it to your computer (pages 70 and 71).
- 3 Click [Start], and select [Programs], [Sony Memory Stick Voice Editor 2.0] and then [Memory Stick Voice Editor].
The "Memory Stick Voice Editor" starts up. The splash window appears, and after loading the message list file the following main window is displayed.

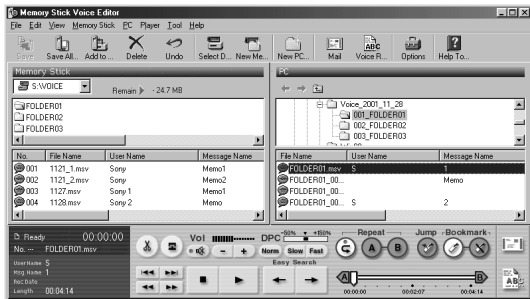

Note

If the setting of the display of Windows is set to "Large Font", the main window appears different from the above one. It is recommended to set "Small Font" in the setting of the display. To change the setting, refer to the instruction manual of Microsoft Windows.

Continued

Starting the software (continued)

The first time you start the software or when a “Memory Stick” drive is not found

After the splash window, the following dialog box for specifying the “Memory Stick” drive is displayed.



Select the “Memory Stick” drive from the drop-down list and click [OK]. The message folders of the selected drive’s VOICE folder are displayed in the folder list box.

Notes

- The drive letter for the “Memory Stick” differs depending on your computer’s settings or environment.
- If a new “Memory Stick” is inserted in the specified drive or you specify the drive without the VOICE folder, the dialog box used to inform you that no Message Folder exists in the specified drive “#” and ask you to create the new Message Folder is displayed. Click [Yes] to make the initial setting of the “Memory Stick” and display the main window. Click [Cancel] to display the [Select Drive] dialog box.
- Before starting the “Memory Stick Voice Editor”, make sure to connect the IC recorder to your computer or insert the “Memory Stick” into your computer. When you do after the “Memory Stick Voice Editor” is started, the “Memory Stick” drive cannot be recognized.
- Before disconnecting the IC recorder or removing the “Memory Stick” from your computer, make sure to exit the “Memory Stick Voice Editor”. Otherwise, data may be damaged.

To quit the “Memory Stick Voice Editor”

Click the close button in the right corner of the window or [Exit] from the [File] menu.

Using Online Help Files of the Software

For details on how to use the "Memory Stick Voice Editor" software, refer to the online Help files.



Tip

For the latest information, refer to the "readme.txt" file. To open the file, click [Start], [Programs], [Sony Memory Stick Voice Editor 2.0], and then [ReadMe].

There are three ways to open online Help file:

- Click [Start], [Programs], [Sony Memory Stick Voice Editor 2.0], and then [Help].
- After starting up the software, select [Help Topics] in the [Help] menu.
- After starting up the software, click  (Help topics) in the Toolbar.

To search from the table of contents in the Help files

- Double-click  to display the titles of the contents.
- Double-click  to display the explanations.

To search with a key word

Click [Key word] in the search dialog box in the Help topics. The list of key words is displayed.

Input the key word or scroll the list of key words.

To display the explanations of the key word, select the key word from the list and click [Find].

Notes

- From the [Help] menu, or  in the Toolbar, you can open English Help files only.
- Help files in your language may not be supplied with this software.

Names and Functions of the Main Window

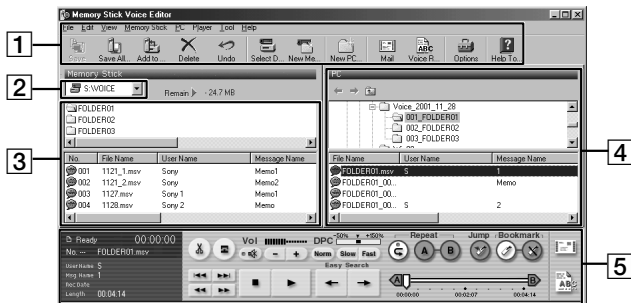

1 Menu bar/Toolbar



You can access and execute the menu commands from the menu bar. The toolbar contains the buttons for common menu command tasks, providing quick way to do tasks. For the details, see the online help.

2 Drive box

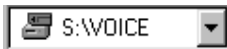

Select the desired drive from the drop-down list. Message folders in the VOICE folder in the selected drive are shown in the Memory Stick folder list.

3 "Memory Stick" message pane

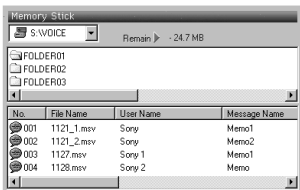

In the folder list beneath the drive box, message folders in the VOICE folder of the drive you selected in the drive box [2] are displayed. Click the desired folder from the list, so that the messages in the selected folder are displayed in the message list beneath the folder list.

The messages are displayed with the relevant information: message number, file name, user name, message name, recorded date, length, priority setting, bookmark setting, alarm setting, Codec, and recording mode (SP or LP).

Note

The remaining recording time displayed in the IC recorder may differ from that displayed in the Memory Stick Voice Editor, which is not malfunction. This is because the IC recorder displays the remaining time after subtracting the memory amount required for its system.

4 PC message pane

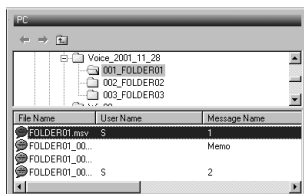

In the upper folder tree pane, the drives and folders are displayed in tree. Click the desired drive and folder in the folder tree pane, so that the messages in the selected folder are displayed in the message list beneath the folder tree pane.

The messages are displayed with the relevant information: file name, user name, message name, recorded date, length, priority setting, bookmark setting, Codec, and recording mode (SP or LP).

Names and Functions of the Main Window (continued)

5 Player pane

This pane controls playback operations. The information of the “Memory Stick” and the message being played back is displayed. For details, see the online help.

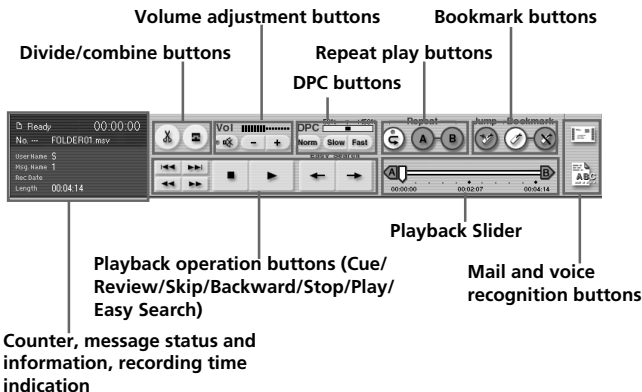

Precautions

On power

Operate the unit only on 3 V DC. Use two size AAA (LR03) alkaline batteries.

On safety

Do not operate the unit while driving, cycling or operating any motorized vehicle.

On handling

- Do not leave the unit in a location near heat sources, or in a place subject to direct sunlight, excessive dust or mechanical shock.
- Should any solid object or liquid fall into the unit, remove the batteries and have the unit checked by qualified personnel before operating it any further.

On noise

- Noise may be heard when the unit is placed near an AC power source, a fluorescent lamp or a mobile phone during recording or playback.
- Noise may be recorded when an object, such as your finger, etc., rubs or scratches the unit during recording.

On maintenance

To clean the exterior, use a soft cloth slightly moistened in water. Do not use alcohol, benzine or thinner.

Continued

Precautions (continued)

On using a "Memory Stick"

- Do not touch or allow metallic objects to come into contact with the metal parts of the connecting section.
- Stick the label supplied for the "Memory Stick" only on the labeling position. Do not use any other labels.
- Do not bend, drop or apply strong shock to the "Memory Stick".
- Do not disassemble or modify the "Memory Stick".
- Do not let the "Memory Stick" get wet.
- Do not use or keep the "Memory Stick" in locations that are:
 - Extremely hot such as in a car parked in the sun
 - Under direct sunlight
 - Very humid or subject to corrosive gases
- When you carry or store a "Memory Stick", put it in its case.

Data backup

After the repair, recorded data sometimes will be deleted. Back up important data regularly to avoid losing the data.

If you have any questions or problems concerning your unit, please consult your nearest Sony dealer.

Should a problem occur with the unit with the "Memory Stick" inserted, take it to your nearest Sony dealer without removing the "Memory Stick". This will allow the problem to be resolved more quickly.

Backup recommendations

To avoid potential risk of data loss caused by accidental operation or malfunction of the IC recorder, we recommend that you save a backup copy of your recorded messages on a tape recorder or to a computer, etc.

Troubleshooting

Before taking the unit for repair, check the following sections. Should any problem persist after you have made these checks, consult your nearest Sony dealer.

IC Recorder

Symptom	Remedy
The unit does not operate.	<ul style="list-style-type: none">•The batteries have been inserted with incorrect polarity (page 10).•The batteries are weak.•The buttons are locked with the HOLD switch (page 52). (If you press any button, "HOLD" will flash three times.)
No sound comes from the speaker.	<ul style="list-style-type: none">•The ear receiver or headphones are plugged in.•The volume is turned down completely.
You cannot start recording.	<ul style="list-style-type: none">•The "Memory Stick" is full. Erase some of the messages. See page 25.•There is no "Memory Stick" inserted.•The write-protect switch on the inserted "Memory Stick is set to "LOCK" (page 15).•999 messages have been recorded in the selected file. Select another file or erase some of the messages. See page 25.
You cannot erase a message.	<ul style="list-style-type: none">•The write-protect switch on the inserted "Memory Stick" is set to "LOCK" (page 15).•The message or the folder which contains the message is set to "Read-only" in the computer. Open the data in a "Memory Stick" using Windows Explorer and remove the check for "Read-only" under "Properties".•You cannot erase other formatted (except MSV file format) data using the unit.

Continued

Troubleshooting (continued)

Symptom	Remedy
You cannot erase all messages in a folder.	<ul style="list-style-type: none">•The write-protect switch on the inserted "Memory Stick" is set to "LOCK" (page 15).•The folder or the message in the folder is set to "Read-only" in the computer. Open data in a "Memory Stick" using Windows Explorer and remove the check for "Read-only" under "Properties".
You cannot overwrite.	<ul style="list-style-type: none">•The remaining memory is too short. The overwritten part will be deleted after the overwriting part finishes recording. Therefore, you can only overwrite within the remaining recording time.•You cannot overwrite an MSV (ADPCM) file recorded with the IC recorder ICD-MS1.
Noise is heard.	<ul style="list-style-type: none">•An object, such as your finger, etc., accidentally rubbed or scratched the unit during recording so that noise was recorded.•The unit was placed near an AC power source, a fluorescent lamp or a mobile phone during recording or playback.•Plug of the connected microphone was dirty when recording. Clean the plug.•Ear receiver/headphones plug is dirty. Clean the plug.
Recording level is low.	<ul style="list-style-type: none">•MIC SENS is set to "L". Display the menu and set MIC SENS to "H" (page 59).
Recording is interrupted.	<ul style="list-style-type: none">•The advanced VOR function is activated. Display the menu and set VOR to "OFF" (page 59).
Recording level is unstable (when recording music, etc.)	<ul style="list-style-type: none">•This unit is designed to automatically adjust the recording level when recording meetings, etc., and is not suitable for music recording.

Symptom	Remedy
Playback speed is too fast or too slow.	•The playback speed is adjusted in DPC. Display the menu and adjust the speed in DPC again (page 28).
"--:--" is displayed.	•You have not set the clock (page 12).
"--Y--M--D" or "--:--" is displayed on the REC DATE display.	•The date of recording will not be displayed if you recorded the message when the clock was not set.
There are fewer menu items in the menu mode.	•There are some menu items which are not displayed because a "Memory Stick" is not inserted (page 60).
A character in a folder or message name is displayed as "□".	•The unit cannot support and display some characters which are entered using the supplied "Memory Stick Voice Editor" software.
Messages are not sorted in order of the number of priority marks in a folder.	•Unless you sort messages using the supplied "Memory Stick Voice Editor" software, messages are sorted in the unit the same as the setting in the computer. Sort again in the order of the number of priority marks in the computer using the supplied "Memory Stick Voice Editor" software.
The remaining time displayed in the display window is shorter than that displayed in the supplied "Memory Stick Voice Editor" software.	•The unit requires a certain amount of memory for system operation. That amount is subtracted from the remaining time, which is the reason for the difference.
The unit does not operate correctly.	•Take out the batteries and insert them again (page10).

Please note that recorded messages may be erased during service or repair work.

Troubleshooting (continued)

“Memory Stick Voice Editor” Software

Symptom	Remedy
“Memory Stick Voice Editor” software cannot be installed.	<ul style="list-style-type: none">•The free disk or memory space on the computer is too small. Check the hard disk and memory space.
Messages recorded using the IC recorder cannot be transferred to the computer./The software does not operate correctly.	<ul style="list-style-type: none">•The “Memory Stick” is not recognized. Quit the software and reinsert the “Memory Stick”, and then restart the software. The software can only recognize the “Memory Stick” inserted before the startup.•When you connect the IC recorder to the USB port of your computer, check the connection as follows:<ul style="list-style-type: none">– When using an external USB hub, connect the IC recorder directly to the computer.– Disconnect and then connect the cable with the IC recorder.– When your computer is equipped with multiple USB ports, connect the IC recorder to another USB port.•Check that the “Memory Stick” adaptor is connected correctly. For more information, see the instruction manual of the adaptor.
Messages cannot be played back.	<ul style="list-style-type: none">•No sound board is installed.•No speaker is built-in or connected to the computer.•Sound is muted.
Playback sound is interrupted.	<ul style="list-style-type: none">•When you choose the floppy disk drive, playback sound is sometimes interrupted.
Saved message files cannot be played back or edited.	<ul style="list-style-type: none">•You cannot play back a message whose file format the Memory Stick Voice Editor does not support. Depending on the file format, you cannot use part of editorial features of the Memory Stick Voice Editor.

Symptom	Remedy
Playback sound volume is too low.	<ul style="list-style-type: none"> • Turn up the volume on the computer. (Refer to the instruction manual of the computer.)
Counter or slider moves incorrectly. There is noise.	<ul style="list-style-type: none"> • This happens when you play back messages in the computer to which you added/ deleted an index, overwrote, or added a recording. Save a message in MSV (LPEC) file format in the hard disk first, and then add it to the "Memory Stick".
Operation is slow when there are many messages.	<ul style="list-style-type: none"> • Regardless of the length of the recording time, when the total number of messages is large the operation becomes slower.
Display does not work during saving, adding, or deleting of messages.	<ul style="list-style-type: none"> • It takes more time to copy or delete long messages. After completing operations, the display works normally.
It takes too long to convert a file format.	<ul style="list-style-type: none"> • The time required for file conversion becomes longer as the file size is bigger.
The Software 'hangs' when "Memory Stick Voice Editor" Software starts up.	<ul style="list-style-type: none"> • There may be conflict between the software and other driver or application. • The message list file may be broken. Delete the message list file (Msglistb.msfl) in the VOICE folder on the Explorer window, and then restart the software. If the problem persists, delete "Msglist.msfl" file. If you delete "Msglist.msfl" file, the information of messages (for example, order of folders, folder names, priority setting, alarm setting) will be deleted (except message names). • Check if the write-protect switch of the "Memory Stick" is set to the "LOCK" position when you use the PC card adaptor.

Troubleshooting (continued)

Error messages of the IC Recorder

Error message	Cause/Remedy
"MEMORY STICK ERROR"	• Insert the "Memory Stick" again. After inserting, if this message is displayed again, the inserted "Memory Stick" may be out of order.
"NO MEMORY STICK"	• Insert the "Memory Stick" again if already inserted.
"UNKNOWN DATA"	• The unit cannot play or erase the selected message because the file type is different.
"ACCESS ERROR"	• If the write-protect switch is set to "LOCK" (page 15), release the switch and insert the "Memory Stick" again. If this is displayed again, the inserted "Memory Stick" needs to be formatted (page 56). Back up the data in the computer after checking the contents.
"FORMAT ERROR"	• You cannot use the "Memory Stick" formatted with other devices. Use the FORMAT in the menu to format the "Memory Stick".
MEMORY STICK LOCKED"	• The write-protect switch on the inserted Memory Stick is set to "LOCK" (page 15). You cannot record, edit or format in this condition. Slide the switch to the left and insert again.
"FILE PROTECTED"	• Messages have been set to "Read-only" in the computer. You cannot edit or erase messages and folders including these "Read-only" messages. Remove the check for "Read-only" under "Properties" of files that are opened by Windows Explorer.

Error message	Cause/Remedy
"FOLDER PROTECTED"	<ul style="list-style-type: none"> • Folders have been set to "Read-only" in the computer. You cannot edit, erase, add messages, or move messages in these "Read-only" folders. Remove the check for "Read-only" under "Properties" of folders that are opened by Windows Explorer.
"LOW BATTERY"	<ul style="list-style-type: none"> • Batteries are weak. Replace batteries with new ones.
"INDEX FULL"	<ul style="list-style-type: none"> • Because there are over 999 messages in the folders or the remaining memory of the Memory Stick is short, it is impossible to add an index. Erase some messages before adding.
"FOLDER FULL"	<ul style="list-style-type: none"> • Because the remaining memory of the "Memory Stick" is short, it is impossible to add a folder. Erase some folders or messages before adding.
"INVALID FUNCTION IN ADPCM"	<ul style="list-style-type: none"> • You cannot use part of editorial features of this unit for an MSV (ADPCM) file message.

For the error messages of the "Memory Stick Voice Editor", please refer to the online Help files.

Troubleshooting (continued)

System Limitations

There are some system limitations of the unit. Troubles as mentioned below are not malfunctions of the unit.

Symptom	Cause/Remedy
You cannot record messages up to the maximum recording time.	<ul style="list-style-type: none">• If you record messages in a mixture of SP and LP modes, the recordable time varies from the maximum SP mode recording time to the maximum LP recording time.• There may be other formatted data (for example, images) in the inserted "Memory Stick".• Due to the minimum recording unit, if the length of each message cannot be divided by the minimum recording unit, the remaining recording time may decrease by more than the total length of the messages.• The maximum recording time varies depending on the number of folders or messages.
You cannot add an index while recording/playing a message.	<ul style="list-style-type: none">• Remaining memory of the inserted "Memory Stick" is too short to add. If the amount of remaining memory is shorter than that of the minimum recording unit, you cannot add an index.• You cannot add an index in a folder which has over 999 messages.
You cannot erase the index.	<ul style="list-style-type: none">• You cannot erase an index to combine different recording mode (SP/LP) messages.
You cannot add a folder.	<ul style="list-style-type: none">• Remaining memory of the inserted "Memory Stick" is too short to add. If the amount of remaining memory is shorter than that of the minimum recording unit, you cannot add a folder.

About the minimum recording unit

For recording a message or adding an index or a folder, the time of the minimum recording unit is needed. Although the actual recording time of a message may be less than that of the minimum recording unit, the time of the message is counted as a minimum recording unit.

If the remaining recording time of the inserted "Memory Stick" is less than that of the minimum recording unit, you cannot add an index or a folder in the "Memory Stick".

The minimum recording unit

Capacity of the "Memory Stick"	SP mode	LP mode
4 MB	4 seconds	11 seconds
8 MB	4 seconds	11 seconds
16 MB	8 seconds	22 seconds
32 MB	8 seconds	22 seconds
64 MB	8 seconds	22 seconds
128 MB	8 seconds	22 seconds

About the maximum recording time and the maximum number of messages or folders

A "Memory Stick" saves not only recorded messages but also the information about indexes and the number of folders. Therefore, as the number of messages or folders increases, the amount of memory in the "Memory Stick" decreases.

The maximum recording time and the number of messages or folders varies depending on this.

However, only in the case that you recorded up to the maximum recording time, you can add up to two indexes. This means you can divide a message into three parts and delete the unnecessary part in the message that was recorded up to the maximum recording time.

Specifications

Recording media	“Memory Stick“, Monaural recording
Recording time	See page 7.
Frequency range	SP: 120 Hz - 7,000 Hz LP: 120 Hz - 3,500 Hz
Speaker	approx. 23 mm (²⁹ / ₃₂ in.) dia.
Power output	200 mW
Input/Output	<ul style="list-style-type: none">• Earphone jack (minijack) for 8 - 300 ohms ear receiver/headphones• Microphone jack (minijack, monaural) Plug in power Minimum input level: 0.7 mV 3 kilohms or lower impedance microphone• USB connector
Playback speed control	+100% to -50% (DPC)
Power requirements	Two size AAA (LR03) alkaline batteries: 3 V DC
Dimensions	34.4 x 106.3 x 18 mm (1 ³ / ₈ x 4 ¹ / ₄ x ²³ / ₃₂ in.) (w/h/d) (not incl. projecting parts and controls)
Mass	75 g (2.7 oz) (incl. batteries and a “Memory Stick“)
Supplied accessories	“Memory Stick“ x 1 “Memory Stick Voice Editor“ (CD-ROM) x 1 Ear receivers x 1 USB connecting cable x 1 Carrying case x 1 LR03 (size AAA) alkaline batteries x 2
Optional accessories	Monaural ear receiver MDR-EX17/Stereo ear receiver MDR-EX70/Active speaker SRS-T77/ Electret condenser microphone ECM-DM5P, ECM-T115, ECM-Z60 (zoom microphone)/Audio connecting cable RK-G64/Memory Stick MSA-8AN (8 MB), MSA-16AN (16 MB), MSA-32AN (32 MB), MSA-64AN (64 MB), MSA-128AN (128 MB)/ PC Card Adaptor for Memory Stick MSAC-PC2N/ USB-compatible Memory Stick Reader/Writer MSAC-US1A/MSAC-US5

Your dealer may not handle some of the above listed optional accessories. Please ask the dealer for detailed information.

Design and specifications are subject to change without notice.

Index to Parts and Controls

Refer to the pages indicated in parentheses for details.

Front

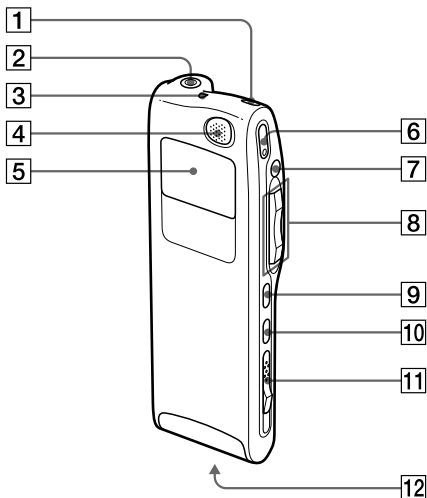

- | | |
|---|--|
| 1 ERASE button (25) | 8 Jog lever |
| 2 EAR (earphone) jack (19, 22) | FOLDER/MENU/ |
| 3 OPR (operation) indicator (17, 22) | ◀◀ (review / fast backward) / |
| 4 Built-in microphone (17, 31) | ▶▶ (cue / fast forward) / |
| 5 Display window (93) | ■ • ▶ (play / stop • enter) (12, 16, 21, 28, 58) |
| 6 ●REC (record) / REC | 9 INDEX / BOOKMARK |
| PAUSE button (17, 31) | button (29, 33) |
| 7 ■STOP button (17, 22, 27) | 10 A-B REPEAT / PRIORITY |
| | button (30, 40) |
| | 11 EJECT lever (15) |
| | 12 Memory Stick slot (14) |

Continued

91^{GB}

Index to Parts and Controls (continued)

Rear

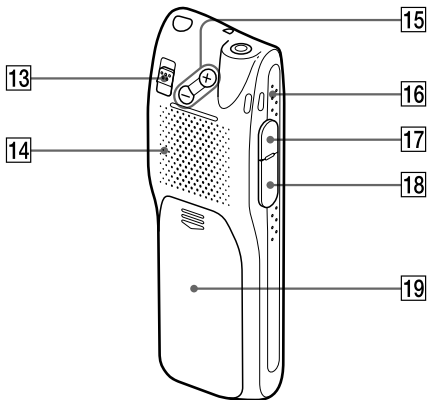

- 13** HOLD switch (52)
- 14** Speaker
- 15** VOL (volume) +/- buttons (22)
- 16** Slit for the supplied handstrap
- 17** MIC (PLUG IN POWER) jack (20)
- 18** USB connector (70)
- 19** Battery compartment (10)

Display window

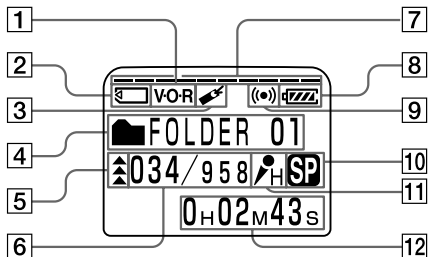

- 1 VOR (voice operated recording) indicator (19, 59)
- 2 "Memory Stick" indicator
- 3 Bookmark indicator (29)
- 4 Folder indication (Menu indication / Messages, etc.) (16, 21)
- 5 Priority marks (40)
- 6 Selected message number (17, 21)/Mode indication of the menu (ON, OFF, etc.) (59, 60)
- 7 Remaining memory indicator (20)
- 8 Remaining battery indicator (11)
- 9 Alarm indicator (48)
- 10 Recording mode indication (60)
- 11 MIC SENS (microphone sensitivity) indication (59)
- 12 Counter / Remaining time indication / Recording date and time indication / Current time indication (53)

Note

The effect of the back light of the display window may be reduced in a bright location.

Index

A

A-B repeat	30
Accidental operation	52
Add, bookmark	29
Add, index	33
Add, recording	31
Advanced VOR	19, 59
ADPCM	63
Alarm	48

B

Battery	10
Beep	50, 60
Bookmark	29
Built-in microphone	17

C

CD-ROM	68
Clock setting	12
Connecting computer	70
Connecting external microphone	20
Continuous playback	23, 34, 59
Counter display	53
Cue	23

D

Display window	93
Display mode	53
DPC	28
DVF file	63

E

Easy search	24
Entering characters	46
Erase, index	35
Erase, messages	25
Error messages	86
External microphone	20

F, G

File formats	63
Folder, adding/deleting	37
Folder, selecting	16, 21
Folder name	42

H

Hold	52
------------	----

I, J, K

ICS file	64
Index	33
Install	68

L

Labeling, folders	42
Labeling, message	44
LP mode	60
LPEC	63

M, N

Main window	76
Memory Stick, inserting	14
Memory Stick, folder structure ...	65
Memory Stick, formatting	56
Memory Stick Voice Editor	61
Memory Stick message pane	77
Menu	58
Message, erasing	25
Message, move	39
Message, playing back	21
Message, recording	16
Message number	17, 21
Microphone, built-in	17
Microphone, external	20
Microphone, connecting	20
Microphone sensitivity	19
Move	39
MSV file	63

O

Overwrite recording	32
---------------------------	----

P, Q

PC message pane	77
PC card adaptor	71
Personal computer	70
Play back continuously	23, 34, 59
Playback	21
Playback speed	28
Player pane	78
Plug in power	20
Priority mark	40

R

Recorded date	54
Recording	16
Recording mode	60
Remaining memory	20
Remaining recording time	53
Repeat play	24
Review	23

S

Search backward/forward	23
SP mode	60
Start the software	73
System limitations	88

T

Transfer the data to the computer	70
--	----

U

Uninstall	69
USB connector	61, 70
User name	45

V

Voice folder	65
Volume control	22
VOR	19, 59

W, X, Y, Z

WAV file	64
----------------	----

<http://www.sony.net/>



Printed on 100% recycled
paper using VOC (Volatile
Organic Compound)-free
vegetable oil based ink.

Printed in Japan

Download from [Www.Somanuals.com](http://www.somanuals.com). All Manuals Search And Download.

Free Manuals Download Website

<http://myh66.com>

<http://usermanuals.us>

<http://www.somanuals.com>

<http://www.4manuals.cc>

<http://www.manual-lib.com>

<http://www.404manual.com>

<http://www.luxmanual.com>

<http://aubethermostatmanual.com>

Golf course search by state

<http://golfingnear.com>

Email search by domain

<http://emailbydomain.com>

Auto manuals search

<http://auto.somanuals.com>

TV manuals search

<http://tv.somanuals.com>