

# ***MiniDisc Recorder***

---

Operating Instructions



***MDS-302***

## WARNING

To prevent fire or shock hazard, do not expose the unit to rain or moisture.

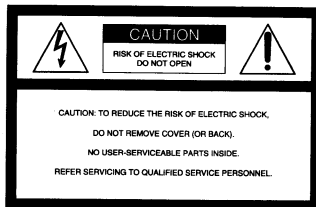

This symbol is intended to alert the user to the presence of uninsulated "dangerous voltage" within the product's enclosure that may be of sufficient magnitude to constitute a risk of electric shock to persons.



This symbol is intended to alert the user to the presence of important operating and maintenance (servicing) instructions in the literature accompanying the appliance.

The following caution label is located inside of the recorder.

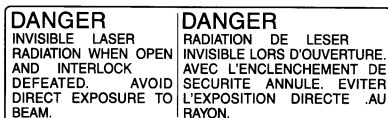

### Owner's record

The model and serial numbers are located on the rear of the unit. Record the serial number in the space provided below. Refer to these numbers whenever you call upon your Sony dealer regarding this product.

Model No. MDS-302

Serial No. \_\_\_\_\_

## IMPORTANT

This equipment has been tested and found to comply with the limits for a Class B digital device, pursuant to Part 15 of the FCC Rules.

These limits are designed to provide reasonable protection against harmful interference in a residential installation.

This equipment generates, uses, and can radiate radio frequency energy and, if not installed and used in accordance with the instructions, may cause harmful interference to radio communications.

However, there is no guarantee that interference will not occur in a particular installation. If this equipment does cause harmful interference to radio or television reception, which can be determined by turning the equipment off and on, the user is encouraged to try to correct the interference by one or more of the following measures:

- Reorient or relocate the receiving antenna.
- Increase the separation between the equipment and receiver.
- Connect the equipment into an outlet on a circuit different from that to which the receiver is connected.
- Consult the dealer or an experienced radio/TV technician for help.

## CAUTION

You are cautioned that any changes or modifications not expressly approved in this manual could void your authority to operate this equipment.

IN NO EVENT SHALL SELLER BE LIABLE FOR ANY DIRECT, INCIDENTAL OR CONSEQUENTIAL DAMAGES OF ANY NATURE, OR LOSSES OR EXPENSES RESULTING FROM ANY DEFECTIVE PRODUCT OR THE USE OF ANY PRODUCT.

## Welcome!

Thank you for purchasing the Sony MiniDisc Recorder. Before operating the recorder, please read this manual thoroughly and retain it for future reference.

## About This Manual

The instructions in this manual are for model MDS-302.

### Conventions

- Controls in the instructions are those on the recorder; these may, however, be substituted by controls on the remote that are similarly named or, when different, appear in the instructions within brackets.
- The following icons are used in this manual:



Indicates a procedure that requires use of the remote.



Indicates tips for making the task easier and hints.

# TABLE OF CONTENTS

---

## Getting Started

Unpacking .....	4
Hooking Up the System .....	4

---

## Recording on MDs

Recording on an MD .....	6
Notes on Recording .....	7
Useful Tips for Recording .....	8
Adjusting the Recording Level .....	8
Marking Track Numbers While Recording (Track Marking) .....	9
Synchro-Recording With a Sony CD Player .....	10
Recording on an MD Using a Timer .....	11

---

## Playing MDs

Playing an MD .....	12
Using the Display .....	13
Locating a Specific Track .....	14
Locating a Particular Point in a Track .....	14
Playing Tracks Repeatedly .....	15
Playing in Random Order (Shuffle Play) .....	15
Creating Your Own Program (Program Play) .....	16
Repeating a Specific Portion (A-B Repeat) .....	17
Useful Tips When Recording From MDs to Tape .....	17
Playing an MD Using a Timer .....	18

---

## Editing Recorded MDs

Notes on Editing .....	19
Erasing Recordings (Erase Function) .....	19
Dividing Recorded Tracks (Divide Function) .....	20
Combining Recorded Tracks (Combine Function) .....	21
Moving Recorded Tracks (Move Function) .....	22
Labeling Recordings (Title Function) .....	23

---

## Additional Information

Precautions .....	25
Display Messages .....	25
System Limitations .....	26
Troubleshooting .....	27
Specifications .....	27
Guide to the Serial Copy Management System .....	28

---

Index .....	30
-------------	----

## Unpacking

Check that you received the following items:

- Audio connecting cords (2)
- Remote commander (remote) (RM-D3M) (1)
- Sony SUM-3 (NS) batteries (2)

## Inserting batteries into the remote

You can control the recorder using the supplied remote.

Insert two R6 (size AA) batteries by matching the + and - on the batteries. When using the remote, point it at the remote sensor  on the recorder.

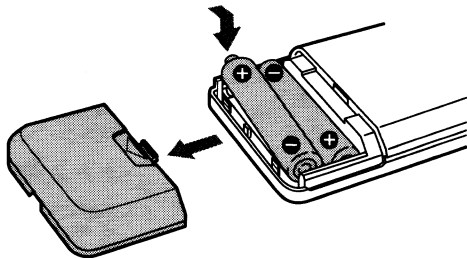

### When to replace batteries

With normal use, the batteries should last for about six months. When the remote no longer operates the recorder, replace all the batteries with new ones.

### Notes

- Do not leave the remote near an extremely hot or humid place.
- Do not drop any foreign object into the remote casing, particularly when replacing the batteries.
- Do not expose the remote sensor to direct sunlight or lighting apparatuses. Doing so may cause a malfunction.
- If you don't use the remote for an extended period of time, remove the batteries to avoid possible damage from battery leakage and corrosion.

## Hooking Up the System

### Overview

This section describes how to hook up the MD recorder to an amplifier or other components such as a CD player or DAT deck. Be sure to turn off the power of each component before connection.

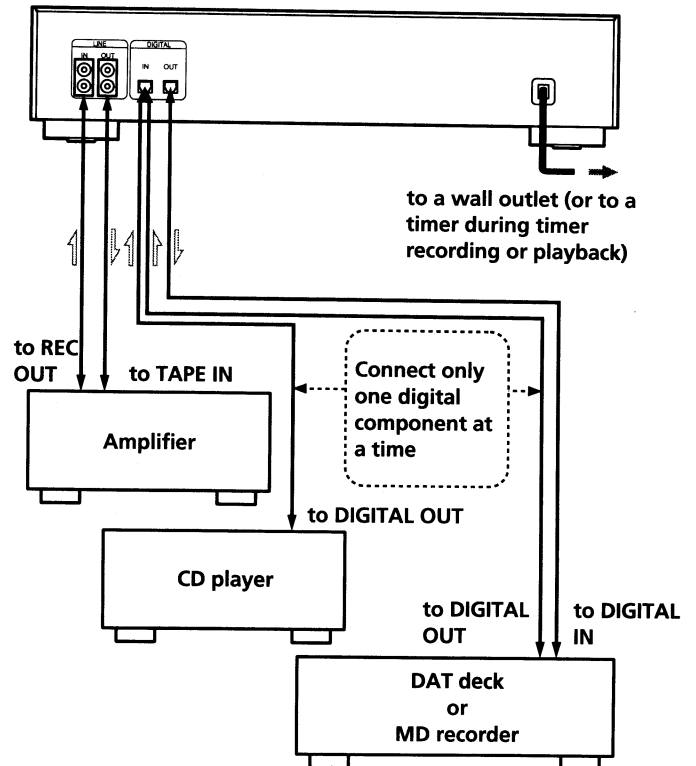

 : Signal flow

### What cords will I need?

- Audio connecting cords (supplied) (2)

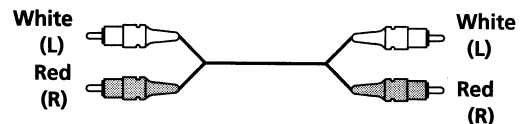

- Optical cable (not supplied) (1)

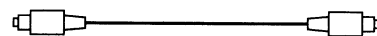

## Hookups

### • Connecting the recorder to an amplifier

Connect the amplifier to the LINE IN/OUT jacks using the audio connecting cords (supplied), making sure to match the color-coded cord to the appropriate jacks on the components: red (right) to red and white (left) to white. Be sure to make connections firmly to prevent hum and noise.

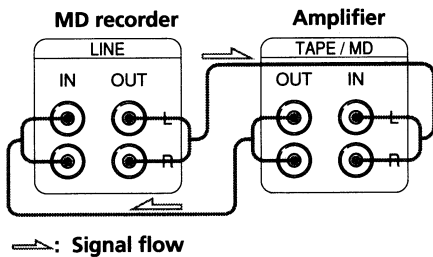

### • Connecting the recorder to a digital component such as a CD player, DAT deck, digital amplifier, or another MD recorder

Connect the component through the DIGITAL IN/OUT connectors using the optical cable (not supplied). Take off the cap and plug in the optical cable.

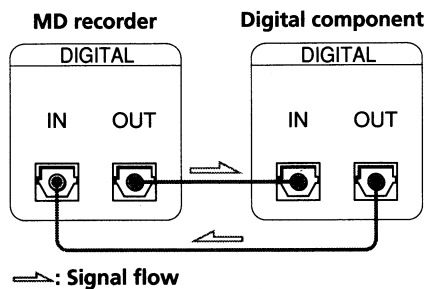

### Notes

- Digital program sources with different sampling frequencies cannot be recorded through the digital input jack. Only CD, MD (premastered) and DAT sources with a sampling frequency of 44.1 kHz can be recorded through the digital input connector. "Din Unlock" appears in the display when you attempt to record digital program sources with a sampling frequency different from that of the MD (such as 32- or 48-kHz DAT or BS). To record these program sources on an MD you must connect them through the analog LINE IN jacks and set INPUT to ANALOG.
- If "Cannot Copy" appears in the display, recording through the digital jack is not possible. In this case, record the program source through the LINE IN and OUT jacks with INPUT set to ANALOG.

## Connecting the AC power cord

Connect the AC power cord to a wall outlet or to the outlet of a timer.

### Note

Do not connect the AC power cord to a switched outlet.

## Where do I go next?

Now you're ready to use your recorder.

Before using the MD recorder, turn on the amplifier and select the MD recorder with the source selector on the amplifier.

## Recording on an MD

Before you begin, make sure you have correctly and firmly connected the recorder to an audio component such as an amplifier or CD player as indicated on page 5.

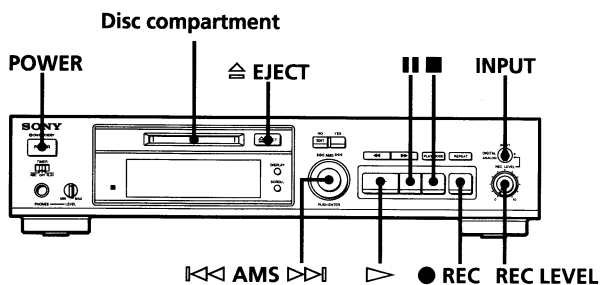

- 1 Turn on the amplifier and the program source, and set the program selector on the amplifier to the program source.
- 2 Press POWER to turn on the recorder. The ON/STANDBY indicator changes from red to green.
- 3 Insert the recordable MD with the label side up and the arrow pointing toward the opening into the disc compartment until the recorder grips it. If you insert the MD while the recorder is off, the recorder will turn on automatically and "Welcome" will appear in the display.

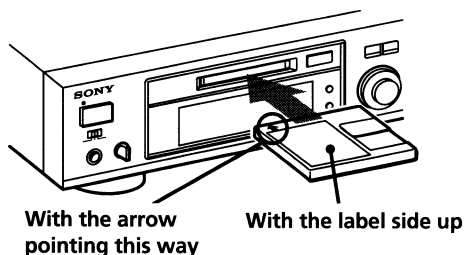

The total number of recorded tracks, total recorded time, and music calendar without a grid appear in the display.

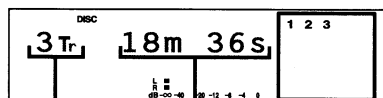

- 4 Set INPUT according to the input terminal connected to the program source.

When you want to record through	Set INPUT to
LINE IN	ANALOG
DIGITAL IN	DIGITAL

- 5 Locate the position on the MD where you want to start recording.
  - To record on a new (blank) recordable MD, skip this step, and go to Step 6.
  - To start recording from the end of the last recorded track, go to Step 6, or turn AMS (or press **◀◀** or **▶▶**) until "End" appears.
  - To record over an existing track, turn AMS (or press **◀◀** or **▶▶**) until the number of the track to be recorded over appears.
- 6 Press **●** REC. The recorder is now ready for recording.
  - If you are recording from the end of the last recorded track, or using a new recordable MD, "New" alternates with the remaining time indication in the display.
  - If you are recording over an existing track, "TRACK" flashes and "Overwrite" alternates with the remaining time indication in the display.
- 7 When you've set INPUT to ANALOG in Step 4, turn REC LEVEL to adjust the recording level. (The fourth dot is satisfactory for most purposes. However, for a more precise adjustment, see "Adjusting the Recording Level" on page 8.)
- 8 Press **||** or **▷** to start recording.
- 9 Start playing the program source you want to record.
- 10 After finishing, press **■** to stop recording. Then press **⊞** EJECT to remove the MD or press POWER to change the recorder to standby.

To	Press
Pause*	<b>  </b>
Resume recording after pause	<b>  </b> or <b>▷</b>
Remove the MD	<b>⊞</b> EJECT

\* Whenever you pause recording, the track number increases by one. For example, if you paused recording while recording on track 4, the track number increases by one and recording continues on the new track when restarted.

**To protect a MiniDisc against accidental erasure**

To make it impossible to record on an MD, slide the tab in the direction of arrow, opening the slot. To allow recording, close the slot.

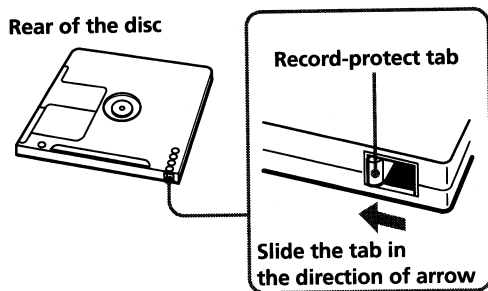

**You can start recording from the middle of a recorded track in Step 5**

Press  $\triangleright$  to start playback, press  $\blacksquare$  where you want to start recording, then do the procedure starting from Step 6 on page 6. However, you will not be able to record from the middle of a recorded track if "PROGRAM" or "SHUFFLE" appears in the display.

- When INPUT is at ANALOG, the source connected through LINE IN, and the "LEVEL-SYNC" setting OFF (see "Marking Track Numbers While Recording" on page 9) or when recording from DAT with INPUT at DIGITAL and the source connected through DIGITAL IN, the source will be recorded as a single track. You can divide the track afterwards using the Divide Function (see "Dividing Recorded Tracks" on page 20) or mark track numbers during recording by using the Track Marking Function on page 9. If "LEVEL-SYNC" appears in the display, the recorder automatically marks track numbers (see "Marking track numbers automatically" on page 9).

**If "TRACK" flashes in the display**

The recorder is recording over an existing track. "TRACK" lights continuously when the recorder reaches the end of the previously recorded portion.

**When "TOC" flashes in the display**

The recorder is currently updating the Table Of Contents (TOC). Do not move the recorder or pull out the AC power cord. Changes to an MD made through recording are saved only when you update the TOC by ejecting the MD or changing the recorder to standby by pressing POWER.

## Notes on Recording

**If "Protected" appears in the display**

The MD is record-protected. Close the slot to record on the disc (see "To protect a MiniDisc against accidental erasure" on this page).

**If "Din Unlock" appears in the display**

- The program source is not connected to DIGITAL IN even though you've selected DIGITAL in Step 4 or the sampling frequency of the program source does not match that of the MD recorder (44.1 kHz). To continue, connect the program source through DIGITAL IN or select ANALOG in Step 4 to record through LINE IN.
- The digital signal has been interrupted (stopped) while you were recording. To continue recording, restart the digital program source. To stop recording, press  $\blacksquare$  on the MD recorder.

**Depending on source being recorded, track numbers are marked in the two following ways:**

- When recording from a CD or MD with INPUT at DIGITAL and the source connected to DIGITAL IN, the recorder automatically marks track numbers in the same sequence as the original. However, if a track is played more than once (i.e., by repeated playback during program play or single-track repeat play), the same track is recorded as a single track no matter how many times it is played. If the source is an MD, track numbers may not be marked for tracks of less than 4 seconds.

**The MD recorder uses the SCMS (Serial Copy Management System on page 28)**

MDs recorded through DIGITAL IN cannot be copied onto other MDs through DIGITAL IN.

## Useful Tips for Recording

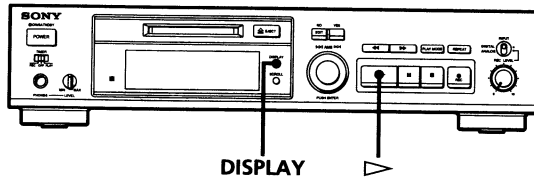

### Checking the remaining recordable time on the MD

- When you press DISPLAY while recording, the remaining recordable time on the MD appears.
- When you press DISPLAY repeatedly while the recorder is stopped, the display changes as follows: total recorded time, remaining recordable time on the MD, disc name (see page 13).

### If "Auto Cut" appears in the display

The Auto Cut Function has been activated. This happens when there is no sound input for more than 30 seconds while INPUT is at DIGITAL and the source connected through DIGITAL IN. The recorder changes to recording pause and the 30 seconds of silence are replaced by a blank of about 3 seconds.

### If "Smart Space" appears in the display

The Smart Space Function has been activated. This happens when there has been an extended silence (of not more than 30 seconds) between two input signals when INPUT is at DIGITAL and the source connected through DIGITAL IN. The Smart Space Function instantaneously replaces the silence with a blank of about 3 seconds even as the recorder continues recording.

### Playing back tracks just recorded

Do this procedure to immediately playback tracks that have just been recorded.

Press ▷ immediately after stopping recording. Playback starts from the first track of the material just recorded.

#### To play from the first track of the MD after recording

- 1 Press ■ again after stopping recording.
- 2 Press ▷.  
Playback starts from the first track of the MD.

## Adjusting the Recording Level

When recording a sound source while INPUT is at ANALOG and the source connected through LINE IN, use REC LEVEL to adjust the recording level before starting recording.

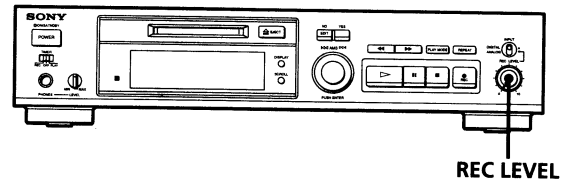

- 1 Do Steps 1 to 6 in "Recording on an MD" on page 6.
- 2 Play the portion of the program source with the strongest signal level.
- 3 While monitoring the sound, turn REC LEVEL to adjust the recording level so that the peak level meters reach their highest point without turning on the OVER indication. Occasional lighting of "OVER" is acceptable.

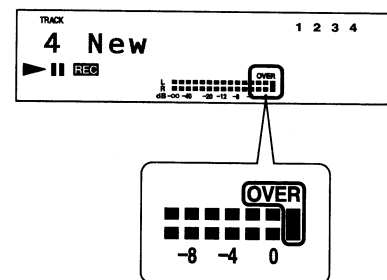

- 4 Stop playing the program source.
- 5 To start recording, do the procedure starting from Step 8 of "Recording on an MD" on page 6.



## Marking Track Numbers While Recording (Track Marking)

You can mark track numbers either manually or automatically. By marking track numbers at specific points, you can quickly locate the points later using the AMS Function or Editing Functions.

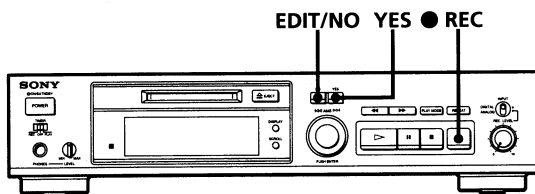

### Marking track numbers manually (Manual Track Marking)

You can mark track numbers at any time while recording on an MD.

Press ● REC at the place you want to add a track mark while recording.

### Marking track numbers automatically (Automatic Track Marking)

The recorder adds track marks differently in the following cases:

- When recording from CDs or MDs with INPUT at DIGITAL and the source connected through DIGITAL IN:  
The recorder marks track numbers automatically. When you record from a CD or MD, the track numbers are written as they are found on the original.
- When recording with INPUT at ANALOG and the source connected through LINE IN, or when recording from DAT with INPUT at DIGITAL and the DAT connected through DIGITAL IN:  
The recorder marks a new track number whenever the signal level drops and rises to a certain point\* (Automatic Track Marking). If "LEVEL-SYNC" does not light up, set the LevelSync to ON as follows:

- 1 Press EDIT/NO to display "LevelSync ?" during recording or recording pause.
- 2 Press YES twice to display "LevelSync ON."  
"LEVEL-SYNC" appears in the display.

### To cancel Automatic Track Marking

- 1 Press EDIT/NO during recording or recording pause.  
"LevelSync ?" appears in the display.
  - 2 Press YES.
  - 3 Press EDIT/NO.  
"LevelSyncOFF" appears in the display.
- \* The signal level must remain low for 2 or more seconds before a new track number is written.

**💡 When you want to mark track numbers after you've done the recording**  
Use the Divide Function (see "Dividing Recorded Tracks" on page 20).

## Synchro-Recording With a Sony CD Player

By connecting your recorder to a Sony CD player or Hi-Fi Component System, you can easily dub CDs onto MDs using the CD synchro buttons on the remote. If your recorder is connected to a Sony CD player by the optical cable through DIGITAL IN (digital input), tracks are automatically recorded in the same sequence as the original regardless of whether "LevelSync ON" or "LevelSyncOFF" is selected. If your recorder is connected to a Sony CD player by audio connecting cords through LINE IN (analog input), tracks are automatically recorded when you select "LevelSync ON" (see "Marking Track Numbers While Recording" on page 9).

As the same remote controls both the CD player and the recorder, you may have trouble operating both units if they are far from each other. If you do, place the CD player close to this recorder.

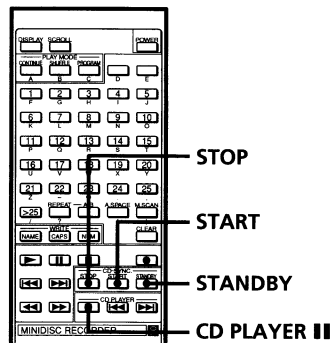

- 1** Set the source selector on the amplifier to CD.
- 2** Do Steps 2 to 5 in "Recording on an MD" on page 6 to prepare the recorder for recording.
- 3** Insert a CD into the CD player.
- 4** Select the playback mode (shuffle play, program play, etc.) on the CD player.
- 5** Press STANDBY.  
The CD player pauses for playing and the recorder pauses for recording.

- 6** Press START.  
The recorder starts recording and the CD player starts playback.  
The track number and elapsed recording time of the track appear in the display.

### If the CD player does not start playing

Some CD player models may not respond when you press START on the remote of the recorder. Press **■** on the remote of the CD player instead.

- 7** Press STOP to stop synchro-recording.

### To pause recording

Press STANDBY or CD PLAYER **■**.

To restart recording, press START or CD PLAYER **■**.

A new track number is created each time you pause recording.

### You can use the remote of the CD player during synchro-recording

Press **■**.

The CD player stops and the recorder pauses for recording.

To restart synchro-recording, press **▶**.

### You can change CDs during synchro-recording

Do the following steps instead of Step 7 above.

- 1** Press **■** on the remote of the CD player.  
The recorder pauses for recording.
- 2** Change the CD.
- 3** Press **▶** on the remote of the CD player.  
Synchro-recording restarts.

### You can check the remaining recordable time on the MD

Press DISPLAY (see page 8).

## Recording on an MD Using a Timer

You can start recording on an MD at a preset time by connecting a timer (not supplied). Please refer to the instructions of the timer for further help.

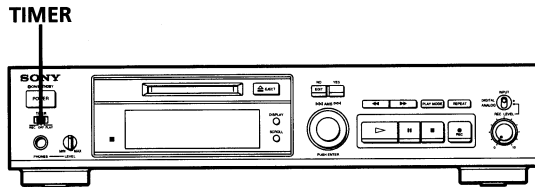

- 1 Insert a recordable MD.
- 2 Set the program selector on the amplifier to the source you want to record.
- 3 Set TIMER on the recorder to REC.
- 4 Set the timer to the time you want.  
The recorder turns off. When the specified time arrives, the recorder turns on and starts recording.
- 5 After you have finished using the timer, set TIMER on the recorder to OFF. Then either plug the AC power cord of the recorder into a wall outlet or set the timer to continuous on so that the recorder stays in standby status.

### Make sure to change the recorder to standby status within two or three days after timer recording is completed

When the recorder enters standby, the TOC on the MD is updated and the recorded contents are written to the MD. If the recorder's standby status is off due to disconnection from a power source for more than two or three days, the contents recorded with the timer may disappear.

### If "STANDBY" flashes when you change the recorder to standby status after timer recording is completed

The recorded contents have disappeared.

#### Notes

- If TIMER is left at REC, the recorder will automatically start recording the next time you turn the recorder on.
- During timer recording, new material is recorded from the end of existing material on the MD.
- Material recorded during timer recording will be saved to the disc the next time the recorder enters standby status. "TOC" will flash in the display at that time. Do not move the recorder or pull out the AC power cord while "TOC" is flashing.
- Timer recording will stop if the disc becomes full.

## Playing an MD

Before you begin, make sure you have connected the recorder to an amplifier correctly and firmly as indicated on page 5.

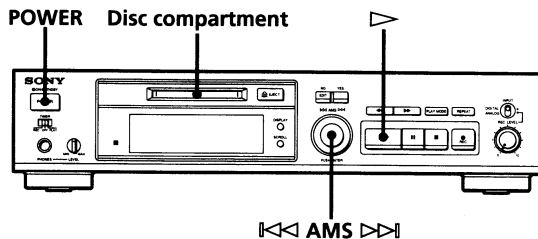

- 1 Turn on the amplifier and set the source selector to MD recorder.
- 2 Press POWER to turn on the recorder. The ON/STANDBY indicator changes from red to green.
- 3 Insert the MD with the label side up and the arrow pointing toward the opening into the disc compartment until the recorder grips it. If you insert the MD while the recorder is off, the recorder will turn on automatically. "Welcome" appears in the display.

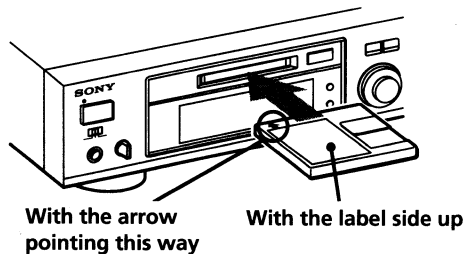

The disc name appears, followed by the total number of tracks (Tr) and total disc playing time. A music calendar showing all the track numbers appears within a grid if the MD is a premastered disc, or without a grid if the MD is a recordable disc.

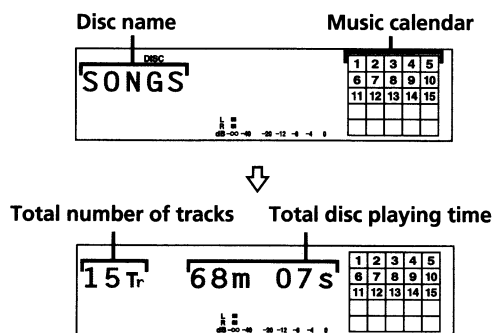

If the total track number exceeds 25, ► appears to the right of number 25 in the music calendar. To label a recordable disc and its tracks, see "Labeling Recordings" on page 23.

- 4 Press ►. The MD starts playing. The current track number, track title (if labeled), and elapsed playing time of the current track light up in the display.

### To stop playback

Press ■.

When you want to	Do the following:
Pause	Press ■■
Resume play after pause	Press ▷ or ■■
Go to the next track	Turn AMS clockwise (or press ►► on the remote)
Go back to the preceding track	Turn AMS counterclockwise (or press ◀◀ on the remote)
Remove the MD	Press ⏏ EJECT

### 💡 You can locate and play back a track while the recorder is stopped

- 1 Turn AMS (or press ◀◀ or ►►) until the number of the track you want to play appears.
- 2 Press AMS or ▷.

### 💡 When you listen with headphones

Connect the headphones to the PHONES jack. You can adjust the volume with the LEVEL control.

## Using the Display

You can use the display to check disc and track information such as the total track number, total playing time of the tracks, remaining recordable time of the disc, and disc name in the display.

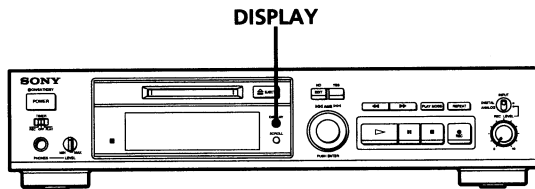

### Checking the total track number, total disc playing time, remaining recordable time of the disc and the title of the disc

Each time you press DISPLAY while the recorder is stopped, you can change the display as follows:

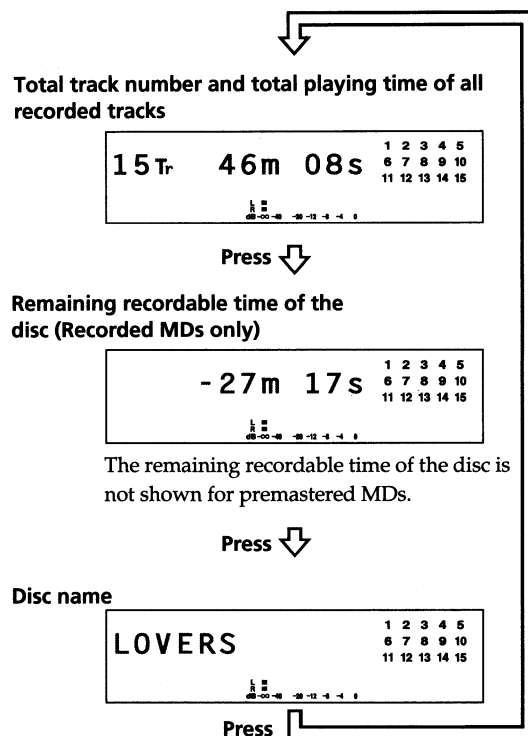

### Checking remaining time and the title of a track

Each time you press DISPLAY while playing an MD, you can change the display as shown below. The track numbers in the music calendar disappear after they are played.

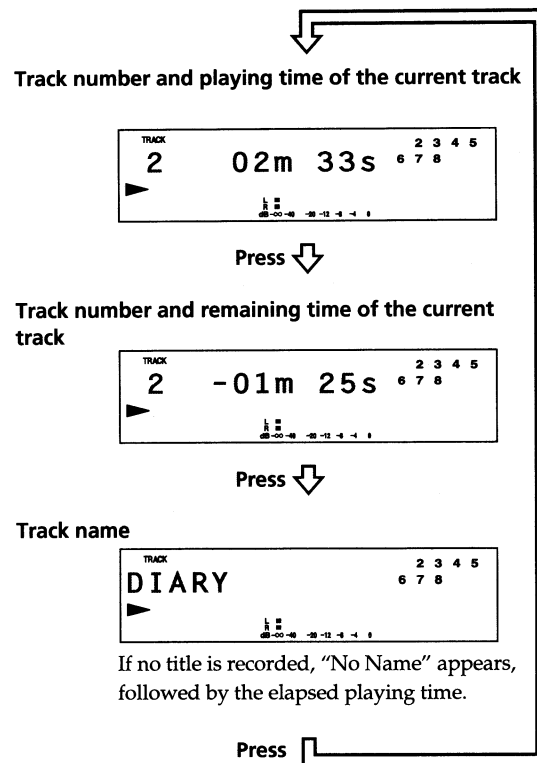

### 💡 You can check the track name at any time while playing an MD by pressing SCROLL

Since the display shows up to 12 characters at a time, press SCROLL again to see the rest of the track title if the title has 13 characters or more.

Press SCROLL again to pause scrolling, and again to continue scrolling.

## Locating a Specific Track

You can quickly locate any track while playing a disc by using AMS (Automatic Music Sensor), ◀◀ and ▶▶, number buttons or M.SCAN on the remote.

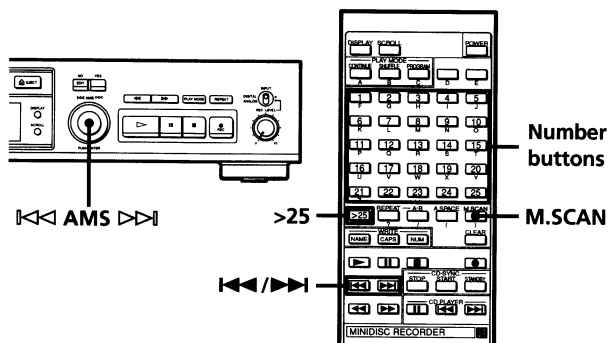

To locate	Do the following:
The next or succeeding tracks	Turn AMS clockwise or press ▶▶ repeatedly until you find the track
The current or preceding tracks	Turn AMS counterclockwise or press ◀◀ repeatedly until you find the track
A specific track directly	Press number buttons to enter the track number
By scanning each track for 6 seconds (music scan)	<ol style="list-style-type: none"> <li>1 Press M.SCAN before you start playing.</li> <li>2 When you find the track you want, press ▷ to start playing.</li> </ol>

### To pause playing at the beginning of a track

Turn AMS (or press ◀◀ or ▶▶) after pausing playback.

### To go quickly to the beginning of the last track

Turn AMS counterclockwise (or press ◀◀) while the display shows the total track number and total disc playing time (see page 13).

### When you directly locate a track with a number over 25

You must press >25 first, before entering the corresponding digits.  
 Press >25 once if it is a 2-digit track number, and twice if it is a 3-digit track number.

To enter "0," press button 10.

- Examples:
- To play track number 30  
Press >25 once, then 3 and 10.
  - To play track number 100  
Press >25 twice, then 1, 10 and 10.

### You can extend the playing time during music scan

While the recorder is stopped, press M.SCAN repeatedly until the playing time you want (6, 10 or 20 seconds) appears in the display. Each press changes the time in order of 6 to 20, then from 6 again.

## Locating a Particular Point in a Track

You can also use ◀◀ and ▶▶ to locate a particular point in a track while playing an MD or during playback pause.

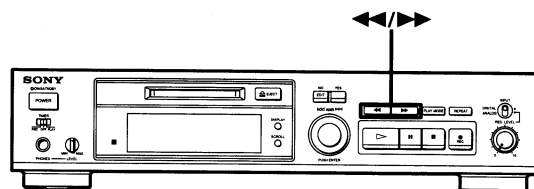

To locate a point	Press
While monitoring the sound	▶▶ (forward) or ◀◀ (backward) and keep pressing until you find the point
Quickly by observing the display during playback pause	▶▶ or ◀◀ and keep pressing until you find the point. There is no sound output during this operation.

### Notes

- If the disc reaches the end while you are pressing ▶▶ during playback pause, "OVER" appears in the display. Press ◀◀ (or ◀◀) or turn AMS counterclockwise to go back.
- If the disc reaches the end while you are pressing ▶▶ during sound monitoring, the recorder stops.
- Tracks that are only a few seconds long may be too short to scan using the search function. For such tracks, it is better to play the MD at normal speed.

## Playing Tracks Repeatedly

You can play tracks repeatedly in any play mode.

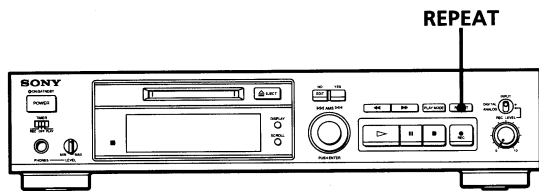

Press REPEAT while playing an MD. "REPEAT" appears in the display. The recorder repeats the tracks as follows:

When the MD is played in	The recorder repeats
Continuous play (page 12)	All the tracks
Shuffle play (this page)	All the tracks in random order
Program play (page 16)	The same program

### To cancel repeat play

Press REPEAT several times until "REPEAT" disappears. The recorder returns to the original playing mode.

## Repeating the current track

While the track you want to repeat is playing in continuous play, press REPEAT several times until "REPEAT 1" appears in the display.

## Playing in Random Order (Shuffle Play)

You can have the recorder "shuffle" tracks and play them in random order.

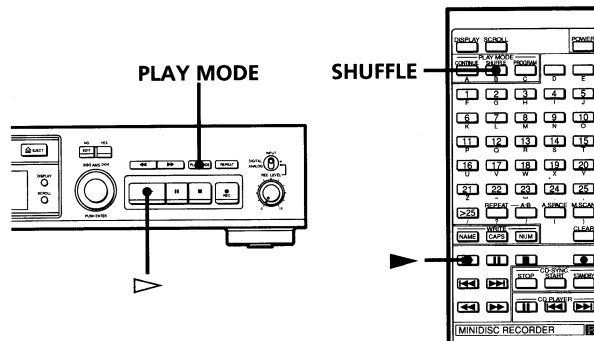

- 1 Press PLAY MODE repeatedly (or SHUFFLE once) until "SHUFFLE" appears in the display.
- 2 Press ▷ to start Shuffle Play. "EJ" appears in the display while the recorder is "shuffling" the tracks.

### To cancel Shuffle Play

Press PLAY MODE repeatedly (or CONTINUE once) until "SHUFFLE" disappears.

### 💡 You can specify tracks during Shuffle Play

- To play the next track, turn AMS clockwise (or press ►►).
- To play from the beginning of the current track again, turn AMS counterclockwise (or press ◀◀). You cannot use AMS (or ◀◀) to go to tracks that have already been played.

## Creating Your Own Program (Program Play)

You can specify the playback order of the tracks on an MD and create your own programs containing up to 25 tracks.

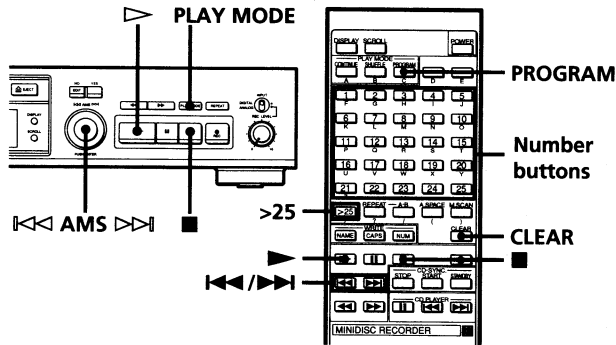

- 1** Press PLAY MODE repeatedly (or PROGRAM once) until "PROGRAM" appears in the display.
- 2** Do either a) or b):
  - a) When using the remote
    - Press the number buttons to enter the tracks you want to program in the order you want.
    - To program a track with a number over 25, use the >25 button (see page 14).
  - If you've made a mistake**  
Press CLEAR, then press the right number button.
  - b) When using the controls on the recorder
    - 1** Turn AMS until the track number you want appears in the display.
    - 2** Press AMS or PLAY MODE.
- 3** Repeat Step 2 to enter other tracks. Each time you enter a track, the total program time is added up and appears in the display.
- 4** Press ▷ to start Program Play.

### To cancel Program Play

Press PLAY MODE repeatedly (or CONTINUE once) until "PROGRAM" disappears.

### 💡 You can program the same track repeatedly

While the track number appears in the display, press AMS as many times as you want.

💡 **The program remains even after Program Play ends**  
When you press ▷, you can play the same program again.

### Note

The display shows "----" instead of the total playing time when the total playing time of the program exceeds 100 minutes.

## Checking the track order

You can check the order of tracks in your program during playback or playback pause.

Turn AMS (or press ◀◀ or ▶▶) during playback or playback pause. The track numbers appear in the order they were programmed.

## Changing the track order

You can change the order of the tracks in your program before you start playing.

To	Do the following:
Erase the last track in the program	Press CLEAR. Each time you press the button, the last track will be cleared.
Add tracks to the end of the program	Do the procedure on this page starting from Step 2
Change the whole program completely	<ol style="list-style-type: none"> <li>1 Press ■ (stop) while the recorder is stopped.</li> <li>2 Do the procedure on this page starting from Step 2.</li> </ol>



## Repeating a Specific Portion (A-B Repeat)

You can play a specific portion of a track repeatedly. This might be useful when you want to memorize lyrics.

Note that you can only repeat a portion within the boundaries of a single track.

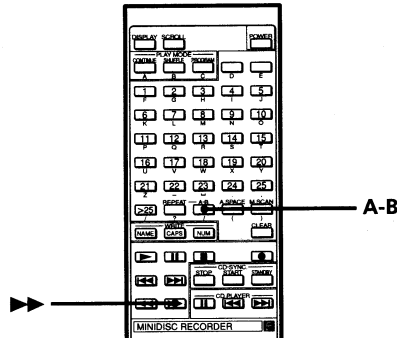

- 1 While playing a disc, press A-B at the starting point (point A) of the portion to be played repeatedly. "A-B" of "REPEAT A-B" flashes in the display.
- 2 Continue playing the track or press **▶▶** until you reach the ending point (point B), then press A-B again. "A-B" of "REPEAT A-B" lights continuously. The recorder starts to play the specified portion repeatedly.

### To cancel A-B Repeat

Press REPEAT.

## Setting new starting and ending points

You can repeat the portion immediately after the currently specified portion by changing the starting and ending points.

- 1 Press A-B while "REPEAT A-B" appears. The current ending point B becomes the new starting point A and "A-B" of "REPEAT A-B" flashes in the display.
- 2 Continue playing the track or press **▶▶** until you reach the new ending point (point B), then press A-B again. "A-B" of "REPEAT A-B" lights continuously and the recorder starts playing repeatedly the newly specified portion.

## Useful Tips When Recording From MDs to Tape

The Auto Space and Auto Pause Functions described in this section make recording from MDs to tape more easy.

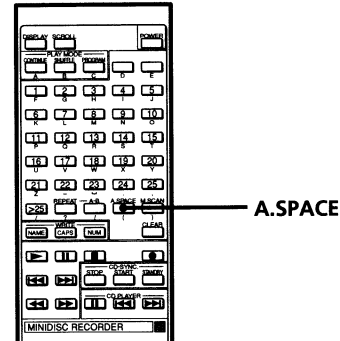

## Inserting blank spaces while recording to tape (Auto Space)

The Auto Space Function inserts a 3-second blank space between each track while recording from MDs to tapes, allowing you to use the AMS function during later playback.

Before the start of recording, press A.SPACE repeatedly until "A.SPACE" appears in the display.

### To cancel Auto Space

Press A.SPACE repeatedly until "A.SPACE" disappears.

### Note

If the Auto Space Function is on while recording a selection containing multiple track numbers, (for example, a medley or symphony), blank spaces will be inserted within the selection whenever the track number changes.

## Pausing after each track (Auto Pause)

When the Auto Pause Function is on, the recorder pauses after playing each track. Auto Pause is convenient when recording single tracks or multiple, non-consecutive tracks.

Press A.SPACE repeatedly until "A.PAUSE" appears in the display.

### To restart playback

Press **▷** or **||**.

### To cancel Auto Pause

Press A.SPACE repeatedly until "A.PAUSE" disappears.



## Notes on Editing

### If "Protected" appears in the display

The recorder could not erase the specified track because the record-protect slot on the MD is open. Erase the track after closing the slot.

### When "TOC" flashes in the display

Do not move the recorder or pull out the AC power cord. After editing, "TOC" lights continuously until you eject the MD or turn off the power. "TOC" flashes while the recorder is updating the TOC. When the recorder finishes updating the TOC, "TOC" goes off.

## Erasing Recordings (Erase Function)

Do the procedures below to erase following:

- A single track
- All tracks
- Parts of a track

**Note, however, that once erased, MD data cannot be recovered.**

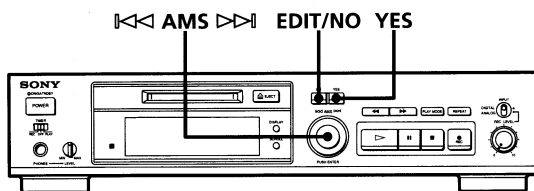

### Erasing a single track

You can erase a track simply by specifying the respective track number. When you erase a track, the total number of tracks on the MD decreases by one and all tracks following the erased one are renumbered. Since erasing merely updates the TOC, there is no need to record over material.

To avoid confusion when erasing multiple tracks, you should proceed in order of high to low track number to prevent the renumbering of tracks that have not been erased yet.

#### Example: Erasing B

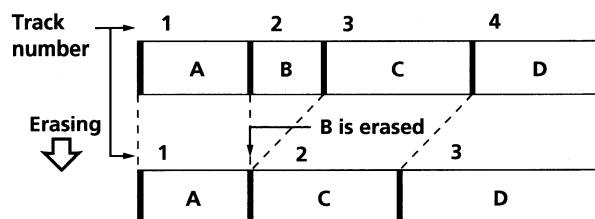

- 1 Turn AMS until the track number you want to erase appears in the display.
- 2 Press EDIT/NO repeatedly until "Erase?" appears in the display. The track number you selected starts flashing in the music calendar.
- 3 Press YES. When the track selected in Step 1 has been erased, "Complete" appears for a few seconds and the total number of tracks in the music calendar decreases by one. If you erase a track during playback, the track following the deleted track begins playing afterwards.
- 4 Repeat Steps 1 to 3 to erase more tracks.

#### To cancel the Erase Function

Press EDIT/NO, ■, or turn AMS to change the track number.

#### Note

If "Erase!!?" appears in the display, the track was recorded or edited on another MD recorder and is record-protected. If this indication appears, press YES to erase the track.

### Erasing all tracks on an MD

Erasing a recordable MD deletes the disc name, all recorded tracks, and titles (see page 24).

- 1 While the recorder is stopped, press EDIT/NO repeatedly until "All Erase?" appears in the display.
- 2 Press YES. All tracks in the music calendar start flashing.
- 3 Press YES again. When the disc name, all recorded tracks, and titles on the MD have been erased, "Complete" appears for a few seconds and the music calendar disappears.

#### To cancel the Erase Function

Press EDIT/NO or ■.

## Erasing a part of a track

By using the Divide (see this page), Erase (see page 19) and Combine (see page 21) Functions, you can erase specific portions of a track.

### Example: Erasing a part of track A

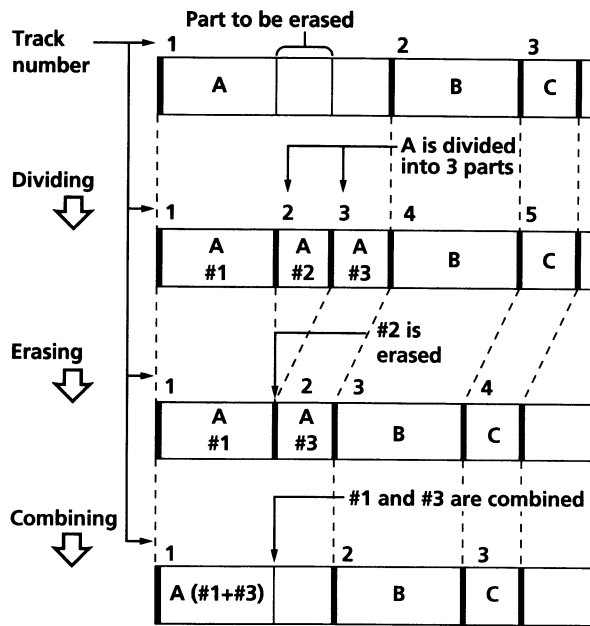

## Dividing Recorded Tracks (Divide Function)

With the Divide Function you can assign a track number at places that you want to randomly access afterwards. Use this function to add tracks to MDs recorded from an analog source (and therefore contain no track numbers), or to divide an existing track into multiple portions. When you divide a track, the total number of tracks on the MD increases by one and all tracks following the divided track are renumbered.

### Example: Dividing track 2 to create a new track for C

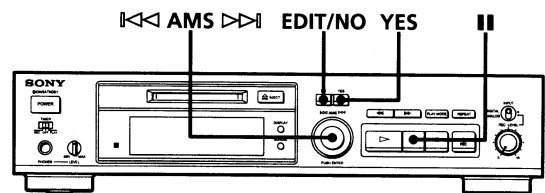
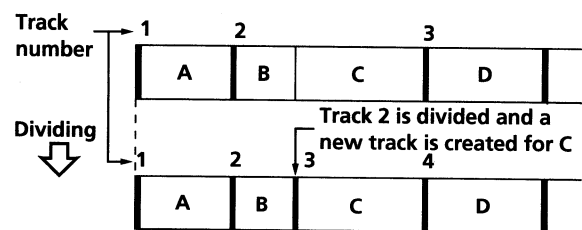

- 1 While playing the MD, press **||** at the point where you want to create a new track.  
The recorder pauses playing.
- 2 Press **EDIT/NO** repeatedly until "Divide ?" appears in the display.
- 3 Press **YES** to divide the track.  
"Rehearsal" alternates with "Position ok?" in the display, the track to be divided starts flashing in the music calendar, and the starting portion of the new track begins playing repeatedly.
- 4 If the starting position is incorrect, press **EDIT/NO**.  
(If it is correct, go to Step 7.)

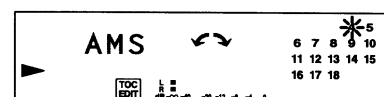

- 5 While monitoring the sound, turn AMS to find the starting position of the new track.  
The starting portion of the new track is played back repeatedly.  
"Rehearsal" alternates with "Position ok?" in the display.  
The starting position can be moved within a maximum range of -128 to +127 steps of about 0.06 second each within a track.
- 6 If the starting position is still incorrect, repeat Step 5 until it is correct.
- 7 Press YES or AMS when the position is correct.  
When the track has been divided, "Complete" appears for a few seconds and the newly created track begins playing. The new track will have no track title even if the original track was labeled.

**To cancel the Divide Function**

Press ■.

**💡 You can undo a track division**

Combine the tracks again (see "Combining Recorded Tracks" on this page) then redivide the tracks if necessary.

**💡 You can divide a track while recording**

Use the Track Marking Function (see page 9).

## Combining Recorded Tracks (Combine Function)

Use the Combine Function while the recorder is stopped, playing or in pause to combine consecutive tracks on a recorded MD. This function is useful for combining several songs into a single medley, or several independently recorded portions into a single track. When you combine two tracks, the total number of tracks decrease by one and all tracks following the combined tracks are renumbered.

**Example: Combining B and C**

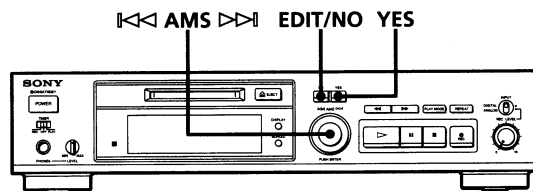
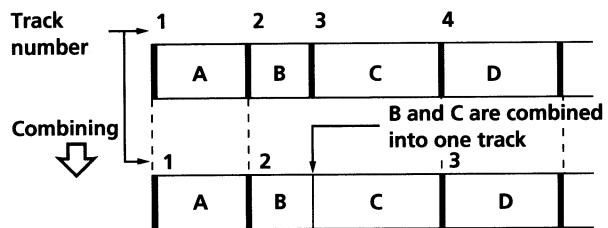

- 1 Turn AMS until the second track of the two to be combined appears.  
For example, when combining tracks 3 and 4, turn AMS until 4 appears.
- 2 Press EDIT/NO repeatedly until "Combine?" appears in the display.
- 3 Press YES.  
"Rehearsal" alternates with "Track ok?" in the display and the two tracks to be combined start flashing in the music calendar. The place where the two tracks will join (i.e., the end of the first track and the beginning of the second track) repeatedly plays back.
- 4 If the place is correct, press YES.  
When the tracks have been combined, "Complete" appears for a few seconds and the total number of tracks in the music calendar decreases by one. If both of the combined tracks have track titles, the title of the second track is erased.

### To cancel the Combine Function

Press EDIT/NO or ■.

### 💡 You can undo a track combination

Divide the tracks again (see "Dividing Recorded Tracks" on page 20), then repeat the combine function with the correct tracks if necessary.

### Note

If "Sorry" appears in the display, the tracks cannot be combined. This sometimes happens when you've edited the same track many times, and is due to a technical limitation of the MD system, not a mechanical error.

## Moving Recorded Tracks (Move Function)

Use the Move Function to change the order of any track. After you move a track, the track numbers between the new and old track positions are automatically renumbered.

### Example: Moving track 3 to track position 2

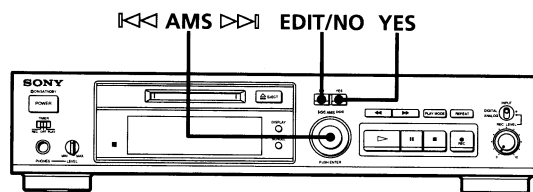
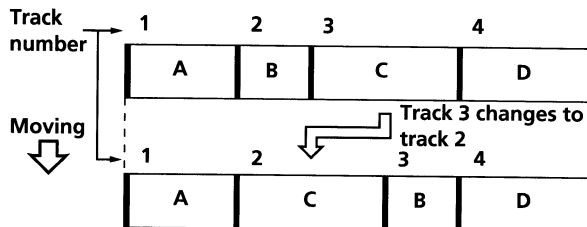

- 1 Turn AMS until the track number you want to move appears in the display.
- 2 Press EDIT/NO repeatedly until "Move ?" appears in the display.
- 3 Press YES.  
The track number to be moved and the new track position appears.

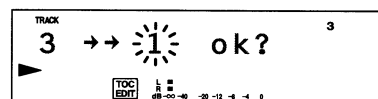

- 4 Turn AMS until the new track position appears.

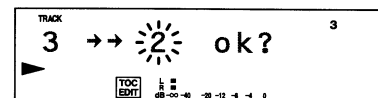

- 5 Press YES or AMS.  
After you have moved the track, "Complete" appears for a few seconds and the moved track begins playing back if the recorder is in playback mode.

### To cancel the Move Function

Press EDIT/NO or ■.

## Labeling Recordings (Title Function)

You can create titles for your recorded MDs and tracks. Titles — which may consist of uppercase and lowercase letters, numbers and symbols for a maximum of about 1,700 characters per disc — appear in the display during MD operation.

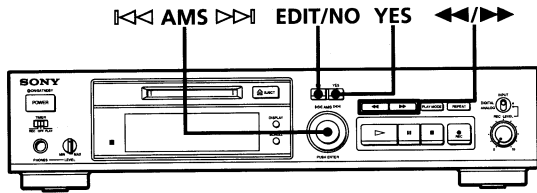

Use the following procedure to label a track or an MD. **You can label a track while it is playing, pausing or recording. If the track is playing, be sure to finish labeling before the track ends. If the track ends before you've completed the labeling procedure, the characters already entered are not recorded and the track will remain unlabeled.**

- 1 Press EDIT/NO repeatedly until "Name in ?" appears in the display, then do the following:

To label	Make sure that the recorder is
A track	Playing, pausing or recording the track to be labeled
An MD	Stopped

- 2 Press YES.  
A flashing cursor appears in the display.



- 3 Turn AMS to select the first character.

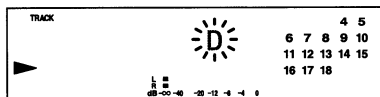

The selected character flashes.  
Letters, numbers, and symbols appear in sequential order as you turn AMS.  
You can use the following symbols in titles:  
! " # \$ % & ' ( ) \* + , - . / : ; < = > ? @ \_ `

- 4 Press AMS to enter the selected character.  
The cursor shifts rightward and waits for the input of the next character.

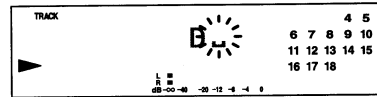

- 5 Repeat Steps 3 and 4 until you have entered the entire title.

### If you entered the wrong character

Press ◀ or ▶ until the character to be corrected starts flashing, and repeat Steps 3 and 4 to enter the correct character.

### To erase a character

Press ◀ or ▶ until the character to be erased starts flashing, then press EDIT/NO.

### To enter a space

Press AMS or ▶ while the cursor is flashing.

- 6 Press YES.  
This completes the labeling procedure and the title appears on the left side of the display.

### To cancel labeling

Press ■.

### Note

You cannot label a track or an MD while you are recording over an existing track.

## Labeling tracks and MDs with the remote



Use the following procedure to label a track or an MD with the remote.

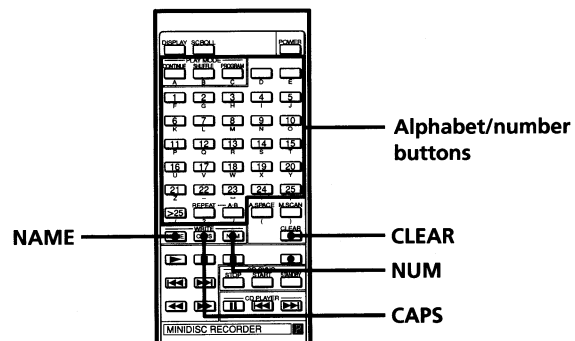

- 1 Press NAME repeatedly until a flashing cursor appears in the display, then do the following:

To label	Make sure that the recorder is
A track	Playing, pausing or recording the track to be labeled
An MD	Stopped

(Continued)

- 2** Select the character type as follows:

To select	Press
Lowercase letters	CAPS repeatedly until "Selected abc" appears in the display
Uppercase letters	CAPS repeatedly until "Selected ABC" appears in the display
Numbers	NUM repeatedly until "Selected 123" appears in the display

- 3** Enter one character at a time.  
After you enter a character, the cursor shifts rightward and waits for the input of the next character.
- 4** Repeat Steps 2 and 3 until you have entered the entire title.

**If you entered the wrong character**

Press ◀ or ▶ until the character to be corrected starts flashing.

Press CLEAR to erase the incorrect character, then enter the correct one.

- 5** Press NAME again.  
The entered title appears on the left side of the display window after the label has been recorded.

**To cancel labeling**

Press ■.

### Changing an existing title

- 1** Press NAME, then do the following:

To change	Make sure that the recorder is
A track title	Playing or pausing the track whose title is to be changed
A disc name	Stopped

- 2** Keep pressing CLEAR (or EDIT/NO on the recorder) until the current title is erased.
- 3** Enter the new title.  
Do Steps 3 to 5 of "Labeling Recordings" on page 23, or Steps 2 to 4 of "Labeling tracks and MDs with the remote" on this page.
- 4** Press NAME.

### Erasing all titles on a disc (Name Erase Function)

Use this function to erase all titles on an MD simultaneously.

**Note that once erased, titles cannot be recovered.**

- 1** Keep pressing EDIT/NO while the recorder is stopped until "All Erase ?" appears in the display.
- 2** Press EDIT/NO again. "Name Erase ?" appears in the display.
- 3** Press YES.  
All titles are erased.

**To cancel the Name Erase Function**

Press ■.



**You can erase all recorded tracks and titles**

See "Erasing all tracks on an MD" on page 19.



## Precautions

### On safety

- As the laser beam used in this recorder is harmful to the eyes, do not attempt to disassemble the cabinet. Refer servicing to qualified personnel only.
- Should any solid object or liquid fall into the cabinet, unplug the recorder and have it checked by qualified personnel before operating it any further.

### On power sources

- Before operating the recorder, check that the operating voltage of the recorder is identical with your local power supply. The operating voltage is indicated on the nameplate at the rear of the recorder.
- If you are not going to use the recorder for a long time, be sure to disconnect the recorder from the wall outlet. To disconnect the AC power cord, grasp the plug itself; never pull the cord.

### On operation

- If the recorder is brought directly from a cold to a warm location, or is placed in a very damp room, moisture may condense on the lenses inside the recorder. Should this occur, the recorder may not operate properly. In this case, remove the MD and leave the recorder turned on for about an hour until the moisture evaporates.

### On the MiniDisc cartridge

- Do not open the shutter to expose the MD.
- Do not place the cartridge where it will be subject to extremes of sunlight, temperature, moisture or dust.

### On cleaning

- Clean the cabinet, panel and controls with a soft cloth slightly moistened with a mild detergent solution. Do not use any type of abrasive pad, scouring powder or solvent such as alcohol or benzine.

If you have any questions or problems concerning your recorder, please consult your nearest Sony dealer.

## Display Messages

The following table explains the various messages that appear in the display.

Message	Meaning
Blank Disc	A new (blank) or erased MD has been inserted.
Cannot Copy	An attempt was made to make a second copy from a digitally dubbed MD (see page 28).
Cannot EDIT	An attempt was made to edit the MD during Program or Shuffle Play or the inserted disc contains Japanese characters.
Disc Error	The MD is scratched or missing a TOC.
Disc Full	The MD is full (see "System Limitations" on page 26).
Impossible	An attempt was made to combine tracks while playing back the first track.
Name Full	The titling capacity of the MD has reached its limit (about 1,792 characters).
NO DISC	There is no MD in the recorder.
No Track	The inserted MD has a disc title but no tracks.
Protected	The inserted MD is record-protected.
Retry	The first recording attempt failed due to a disturbance or scratch on the MD, and a second attempt is being made.
Retry Error	Due to vibrations to the recorder or scratches on the MD, several recording attempts were made but with no success.
Sorry	An attempt was made to combine tracks that cannot be combined.
STANDBY (flashing)	The contents recorded by timer have disappeared over time and are not be available for saving to disc, or Program Play could not be activated since the program has disappeared over time.

### System Limitations

The recording system in your MiniDisc recorder is radically different from those used in cassette and DAT decks and is characterized by the limitations described below. Note, however, that these limitations are due to the inherent nature of the MD recording system itself and not to mechanical causes.

#### **"Disc Full" lights up even before the MD has reached the maximum recording time (60 or 74 minutes)**

When 255 tracks have been recorded on the MD, "Disc Full" lights up regardless of the total recorded time. More than 255 tracks cannot be recorded on the MD. To continue recording, erase unnecessary tracks or use another recordable MD.

#### **"Disc Full" lights up before the maximum number of tracks is reached**

Fluctuations in emphasis within tracks are sometimes interpreted as track intervals, incrementing the track count and causing "Disc Full" to light up.

#### **The remaining recording time does not increase even after erasing numerous short tracks**

Tracks under 12 seconds in length are not counted and so erasing them may not lead to an increase in the recording time.

#### **Some tracks cannot be combined with others**

Track combination may become impossible when tracks are edited.

#### **The total recorded time and the remaining time on the MD may not total the maximum recording time (60 or 74 minutes)**

Recording is done in minimum units of 2 seconds each, no matter how short the material. The contents recorded may thus be shorter than the maximum recording capacity. Disc space may also be further reduced by scratches.

#### **Tracks created through editing may exhibit sound dropout during search operations.**

#### **Track numbers are not recorded correctly**

Incorrect assignment or recording of track numbers may result (1) when CD tracks are divided into several smaller tracks during digital recording, or (2) while recording certain CDs with the "LEVEL-SYNC" indication on (i.e., the automatic track marking function on).

#### **"TOC Reading" appears for a long time**

If the inserted recordable MD is brand new, "TOC Reading" appears in the display longer than for MDs that have been used.

#### **Limitations when recording over an existing track**

- The correct remaining recording time may not be displayed.
- You may find it impossible to record over a track if that track has been recorded over several times already. If this happens, erase the track using the Erase Function (see page 19).
- The remaining recording time may be shortened out of proportion to the total recorded time.
- Recording over a track to eliminate noise is not recommended since this may shorten the duration of the track.
- You may find it impossible to label a track while recording over it.

#### **The correct recorded/playing time may not be displayed during playback of monaural-format MDs.**

## Troubleshooting

If you experience any of the following difficulties while using the recorder, use this troubleshooting guide to help you remedy the problem. Should any problem persist, consult your nearest Sony dealer.

### The recorder does not operate or operates poorly.

- ➔The MD may be damaged ("Disc Error" appears). Take the MD out and insert it again. If "Disc Error" remains, replace the MD.

### The recorder does not play back.

- ➔Moisture has formed inside the recorder. Take the MD out and leave the recorder in a warm place for several hours until the moisture evaporates.
- ➔The recorder is not on. Press POWER to turn the recorder on.
- ➔The MD is inserted in the wrong direction. Slide the MD into the disc compartment with the label side up and the arrow pointing towards the opening until the recorder grips it.
- ➔The MD may not be recorded (the music calendar does not appear). Replace the disc with one that has been recorded.

### The recorder does not record.

- ➔The MD is record-protected ("Protected" appears). Close the record-protect slot (see page 7).
- ➔The recorder is not connected properly to the sound source. Make connections properly to the sound source.
- ➔The recording level is not adjusted properly (in case of input through LINE IN). Turn REC LEVEL to adjust the recording level properly (see page 8).
- ➔A premastered MD is inserted. Replace it with a recordable MD.
- ➔There is not enough time left on the MD. Replace it with another recordable MD with fewer recorded tracks, or erase unnecessary tracks.
- ➔There has been a power failure or the AC power code has been disconnected. Data recorded to that point may be lost. Repeat the recording procedure.

### An incompletely inserted MD cannot be pulled out.

- ➔The MD recorder's self-lock system has gripped the MD. Insert the MD completely, then press  $\cong$  EJECT.

### The sound has a lot of static.

- ➔Strong magnetism from a television or a similar device is interfering with operations. Move the recorder away from the source of strong magnetism.

### Note

If the recorder does not operate properly even after you've attempted the prescribed remedies, turn off the power, then reinsert the plug into the power outlet.

## Specifications

### MD recorder section

<b>System</b>	MiniDisc digital audio system
<b>Disc</b>	MiniDisc
<b>Laser</b>	Semiconductor laser
<b>Wavelength</b>	780 - 790nm
<b>Laser diode properties</b>	Material: GaAIAs Emission duration: continuous Laser output: less than 44.6 $\mu$ W (This output is the value measured at a distance of 200 mm from the lens surface on the optical pick-up block.)
<b>Revolutions</b>	400 rpm to 900 rpm (CLV)
<b>Error correction</b>	Advanced Cross Interleave Reed Solomon Code (ACIRC)
<b>Sampling frequency</b>	44.1 kHz
<b>Modulation system</b>	EFM (Eight-to-Fourteen Modulation)
<b>Number of channels</b>	2 stereo channels
<b>Frequency response</b>	5 to 20,000 Hz $\pm$ 0.5 dB
<b>Signal-to-noise ratio</b>	Over 96 dB (during playback)
<b>Wow and flutter</b>	Below measurable limit

### Inputs

	Jack type	Input impedance	Rated input	Minimum input
LINE IN	Phono jacks	Over 47 kilohms	500 mVrms	158 mVrms
DIGITAL IN	Square optical connector jack	Optical wave lengthh 660 nm	—	—

### Outputs

	Jack type	Rated output	Load impedance
LINE OUT	Phono jacks	2 Vrms (at 50 kilohms)	Over 10 kilohms
DIGITAL OUT	Square optical connector jack	-18 dBm	Wave lengthh: 660 nm
PHONES	Stereo phone jack	28 mW	32 ohms

## Additional Information

### General

#### Power requirements

120V AC, 60 Hz

#### Power consumption

19 W

#### Dimensions (approx) (w/h/d)

430 × 97.5 × 292 mm (17 × 3 7/8 × 11 1/2 in.) incl. projecting parts

#### Mass (approx)

3.5 kg (7 lbs 11 oz)

#### Supplied accessories

Audio connecting cords (2 phono plugs – 2 phono plugs) (2)  
Remote commander (remote) RM-D3M (1)  
Sony SUM-3 (NS) batteries (2)

#### Optional accessories

Recordable MDs: MDW-60 (60 min), MDW-74 (74 min)  
Optical cable: POC-15A

U.S. and foreign patents licensed from Dolby Laboratories Licensing Corporation.

Design and specifications are subject to change without notice.

## Guide to the Serial Copy Management System

This MD recorder uses the Serial Copy Management System which allows only a first-generation digital copy to be made of prerecorded software via the MD recorder's digital input/output jacks. An outline of this system appears below:

- 1 You can record from digital program sources (CDs, prerecorded MDs, and DAT equipment with a sampling frequency of 44.1 kHz) onto a recordable MD via the MD recorder's digital input jack. You cannot, however, record from the recorded MD onto another recordable MD via the MD recorder's digital output jack.

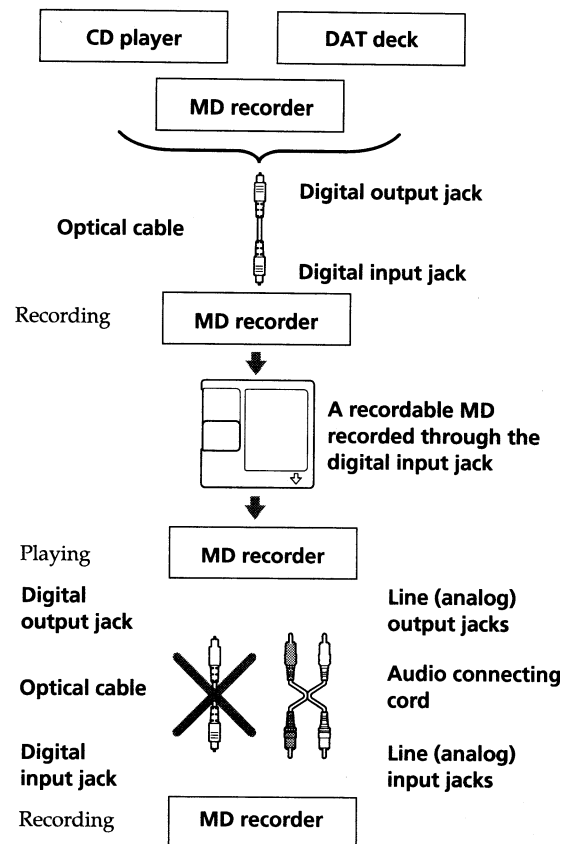

### Note

There are no copy generation restrictions on recording between two MD recorders connected via their respective analog input/output jacks.

- 2 You can record from an MD recorded via the MD recorder's analog input jacks to another recordable MD via the MD recorder's digital output jack. You cannot, however, make a second-generation MD copy via the MD recorder's digital output jack.

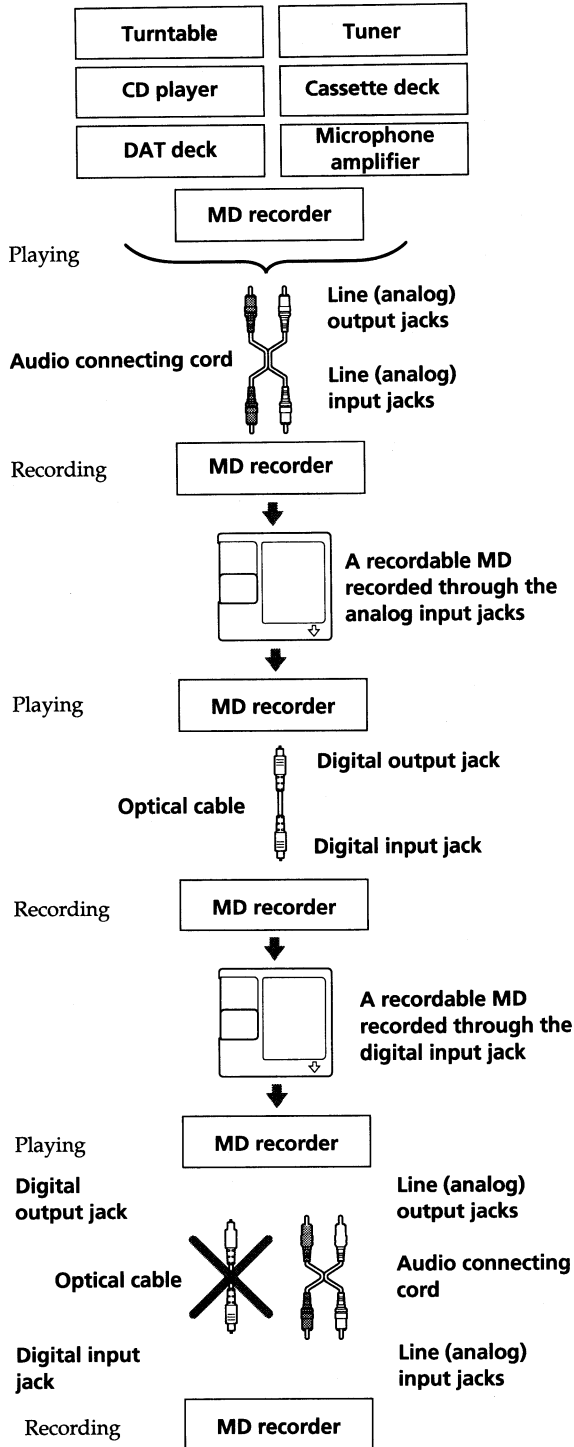

## Index

**A, B**

- A-B repeat 17
- AMS (Automatic Music Sensor) 14
- Auto cut 8
- Auto space 17
- Auto pause 17

**C**

- Cable
  - optical 4, 5
- CD synchro-recording 10
- Changing
  - an existing title 24
  - order of programmed tracks 16
- Checking
  - order of programmed tracks 16
  - remaining recordable time on the MD 8
- Cleaning 25
- Combining 21
- Cord
  - audio connecting 4, 5

**D**

- Display messages 25
- Dividing 20

**E, F, G**

- Ejecting an MD 6, 12
- Erasing
  - all titles 24
  - all tracks 19
  - a part of a track 20
  - a single track 19

**H**

- Hooking up
  - an analog component 5
  - a digital component 5

**I, J, K**

- Inserting an MD 6, 12

**L**

- Labeling
  - a track 23
  - an MD 23
- Locating
  - a particular point in a track 14
  - a specific track 14
- LEVEL-SYNC 9

**M, N**

- Moving 22
- Music scan 14

**O**

- Optional accessories 28

**P, Q**

- Pausing
  - playback 12
  - recording 6
- Playing an MD
  - normal play 12
  - program play 16
  - repeat play 15
  - shuffle play 15
- Premastered MD 12, 13

**R**

- Recordable MD 6, 12
- Recording on an MD 6
- Recording level 8
- Record-protect tab 7
- Remote commander (remote) 4

**S**

- Sampling frequency 5, 27
- SCMS (Serial Copy Management System) 7, 28
- Smart space 8
- Specifications 27
- Supplied accessories 4, 28
- System limitations 26

**T, U, V, W, X, Y, Z**

- TOC (Table Of Contents) 7, 19
- Track marking 9
  - automatic track marking 9
  - manual track marking 9
- Troubleshooting 27

## Names of controls

**Buttons**

- A - B 17
- Alphabet/Number 14, 16, 23
- A.SPACE 17
- CD PLAYER **II** 10
- CLEAR 16
- DISPLAY 8, 13
- EDIT/NO/YES 9, 19 to 23
- EJECT** 6, 12
- M.SCAN 14
- PLAY MODE 15, 16, 18
- PROGRAM 16
- REC** (recording) 6, 9
- REPEAT 15
- SCROLL 13
- SHUFFLE 15
- STANDBY 10
- START 10
- STOP 10
- >** (play) 6, 8, 12
- II** (pause) 6, 12
- (stop) 6, 16
- ◀▶** 14
- ◀▶/▶▶** 12, 14, 16
- >** 14, 16

**Switches**

- INPUT 6
- POWER 6, 12
- TIMER 11, 18

**Connectors**

- DIGITAL IN 4, 5
- DIGITAL OUT 4, 5

**Controls**

- ◀◀ AMS ▶▶** 6, 12, 14, 16, 19 to 23
- LEVEL 12
- REC LEVEL 6, 8

**Indicator**

- ON/STANDBY 6, 12

**Jacks**

- LINE IN 4, 5
- LINE OUT 4, 5
- PHONES 12

**Others**

- Disc compartment 6, 12
- Display 13
- Music calendar 6, 12, 13
- 4

## Free Manuals Download Website

<http://myh66.com>

<http://usermanuals.us>

<http://www.somanuals.com>

<http://www.4manuals.cc>

<http://www.manual-lib.com>

<http://www.404manual.com>

<http://www.luxmanual.com>

<http://aubethermostatmanual.com>

Golf course search by state

<http://golfingnear.com>

Email search by domain

<http://emailbydomain.com>

Auto manuals search

<http://auto.somanuals.com>

TV manuals search

<http://tv.somanuals.com>