

SONY

MD RECORDER

MDS-B1



OPERATION MANUAL English

1st Edition (Revised 2)

Serial No. 800001 and Higher (UC)

Serial No. 500001 and Higher (EK)

Organization of this manual

To get an idea of the contents of each chapter, read the chapter summaries below and at the start of each chapter.

Chapter 1 Overview

This chapter explains the main features of the MD recorder.

Chapter 2 Function of Parts and Controls

This chapter explains the functional parts of the MD recorder, how they work and how to use them.

Chapter 3 Preparations

This chapter explains precautions, connecting the MD recorder, taking care of discs, and setting the reference level of analog input/output signals.

Chapter 4 Recording

This chapter explains basic procedures for recording, displaying cycle, and labeling discs and tracks.

Chapter 5 Playback

This chapter explains basic procedures for playback, locating tracks, displaying information, and other playback functions.

Chapter 6 Editing Functions

This chapter explains dividing tracks, combining tracks and other basic editing procedures.

Chapter 7 Menu Functions

This chapter explains menu-specified functions such as AUTO PAUSE or AUTO CUE.

Chapter 8 Maintenance

This chapter explains how to maintain the MD recorder and the meaning of MD display messages.

Appendix

• Specifications

This appendix provides the technical specifications of the MD recorder.

• What is the MiniDisc?

This appendix explains the operating principles of the MD.

Index

This index provides easy access to important subjects and terms.

Conventions used

Explanation of procedures

Each step of a procedure is shown in an accompanying illustration connected by line to the respective key or switch to be operated. Switches or lamps that require checking during the procedure also appear in the illustration.

Technical terms and reference information

Definitions of technical terms appearing for the first time appear at the bottom of the respective page. Titles of chapters, sections, or manuals appear in italics when they are referred to.

Example:

6-3 Dividing a Recorded Track (Divide Function)

To randomly access certain portions of a track, the divide function allows you to create separate tracks for each portion. You can also use the divide function to erase selected portions of a track, by first specifying the portion as a separate track, then erasing that track (see *6-2 Erasing Recordings (Erase Function)*, page 6-4). Do the divide function while playing the disc.

Reference information →

Switches, etc. used in the procedure → STOP key

Explanation of operation →

Procedure step number → 1

Operation results or other operation-related information →

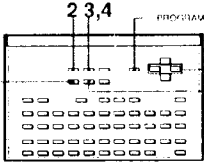

1 While playing the track to be divided, press the PLAY/PAUSE key at the point where the new track is to begin. The MD recorder changes to playback pause.

2 Press the ENTER/NO key until "Divide?" appears.

3 Press the ENTER/YES key. "Rehearsal" and "Position ok?" alternately appear and the starting portion of the new track plays back repeatedly.

Rehearsal 07:11.00

Position ok? 07:11.00

Figure 6-3: Dividing a Track 6-5

Example of a Procedure

Chapter 1 Overview

This chapter explains the main features and functions of the MDS-B1.

1-1	Introducing the MDS-B1	1-2
1-2	Features	1-3
1-2-1	Features of the MiniDisc Recorder	1-3
1-2-2	Operational Features	1-4

1-1 Introducing the MDS-B1

The MDS-B1 MD (MiniDisc) recorder provides the superior sound quality of digital MD recording and playback as well as MD recorder functions suited to the requirements of commercial broadcasting. The durability of MDs makes them ideal for playing repetitive material over long periods of time, such as background music or announcements at public facilities. The MDS-B1's analog input/output connectors allow signal transmissions over an XLR (balanced) cable. Its commercial broadcasting functions include highly accurate cueing, the indication of remaining play time, an EOM (end of message) indication, and an hours meter to indicate accumulated operating time for the laser diode and spindle motor. The MDS-B1 is compact enough to allow three units to be mounted in a standard 19" rack. It comes with a rear 25-pin REMOTE connector and a wire-connected remote controller that allows easy entry of titles and other text data on a standard typewriter keyboard.

1-2-1 Features of the MiniDisc Recorder

ATRAC (Adaptive Transform Acoustic Coding) data compression technology

By eliminating inaudible sound data to obtain a compression ratio of 1:5, ATRAC data compression technology enables the recording of sound information of almost the same quality and quantity as a CD, but on a smaller disc.

74 minutes of playback or recording

A single MD can be used to play back or record up to 74 minutes of sound information, far exceeding the capacity possible with IC memories.

Direct track access

You can use the supplied remote controller to directly access any of 255 MD tracks, without the long cuing time required for tape.

Various playback functions

The MDS-B1's various playback functions include repeated playback of tracks and programmed playback of tracks.

Multiple editing functions

The MDS-B1's editing functions allow you to divide, combine and move tracks, as well as monitor the sound while dividing tracks. Unlike tracks on analog cassette tape, specific MD tracks or an entire MD can be erased instantly.

Text entry

You can use the supplied wire-connected remote controller to enter text to create titles for recorded discs and tracks. Titles, which may be as long as 100 characters per title and totaling 1,792 characters per disc, appear in the display window during playback.

1-2 Features

Durability

Because the MDs use a non-contact system like compact discs, they are superior to the cassette tape in durability.

1-2-2 Operational Features

AUTO PAUSE function

You can use the AUTO PAUSE function to place an MD in playback pause at the beginning of a track, then press the PLAY/PAUSE key to start playback. Use this function to pre-cue tracks during on-the-air broadcasting with multiple MD recorders.

AUTO CUE function

When the AUTO CUE function is on, the MD recorder enters playback pause when it detects a rise in the audio signal (above -58 dB) following the inaudible portion at the start of a track. This function is effective for delivering special sound effects in theater productions, etc.

Playback display variations

While entering a track title, you can use a semicolon to divide the title, then display each part separately during playback by pressing the DISPLAY key. By holding down the DISPLAY key, you can also display the remaining playing time of the track alternately with the track title or elapsed playing time (auto display function).

LevelSync setting function

LevelSync setting is essentially the adding of track numbers at specified points while recording. Track numbers can be added automatically or manually.

End-of-message (EOM) indication

The display indication flashes when that the end of the track approaches (EOM indication). You can specify flashing to start at between 1 and 35 seconds before the end of the track.

Hours meter

The hours meter displays the accumulated time of laser diode recording operations and spindle motor operation. Use this information as the basis for replacing the BU block.

Remote control function

The MD recorder can be controlled by external control signals sent to the MDS-B1 through the REMOTE (25-pin) connector on the rear panel.

Rack mounting compatibility

Three MD recorders can be mounted side by side in a standard 19" EIA rack.

Chapter 2

Function of Parts and Controls

This chapter explains the names and functions of each part of the MDS-B1.

2-1 Front Panel	2-2
2-2 Rear Panel	2-4
2-3 Remote Controller	2-6

1 PLAYBACK/RECORD level controls

Adjust the analog input/output reference level during recording or playback by turning the control for each channel (CH-1:L/CH-2:R) with a bladed screwdriver.

2 MODE switch

Use to select monaural or stereo mode for the analog input/output signal.

When MONO is selected during playback, the signals of channel 1 and 2 are lowered to below -6 dB, then output from ANALOG OUT CH-1(L) and CH-2(R).

When MONO is selected during recording, the signal from ANALOG IN CH-1(L) and ANALOG IN CH-2(R) are lowered to below -6 dB, then recorded to channels 1 and 2.

Note

If a signal is recorded from only one ANALOG IN connector in MONO mode, the recording level will be -6 dB lower than that recorded in STEREO mode. In this case, use the PLAYBACK/RECORD level control to bring the recording level up to that of STEREO mode.

3 POWER switch

Press to turn on the MD recorder. Press again to turn the MD recorder off.

4 AC IN connector

Connect to an AC outlet with the supplied AC power cord.

5 \perp (ground) connector

Connect directly to the ground.

6 REMOTE connector (D-sub 25-pin)

Connect to external equipment for remote control.

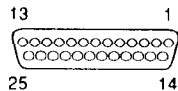
**Pin assignment**

Pin No.	Signal	Pin No.	Signal
1	GND (for status out)	14	CUE STDBY LED OUT
2	PLAY STATUS OUT	15	PAUSE STATUS OUT
3	EOM STATUS OUT	16	REC STATUS OUT
4	STOP STATUS OUT	17	PLAY/PAUSE LED OUT
5	EJECT LED OUT	18	5 V
6	NEXT COMMAND IN	19	Reserved
7	GND (for command IN)	20	PLAY COMMAND IN
8	Reserved	21	STOP COMMAND IN
9	EDIT COMMAND IN	22	DISPLAY COMMAND IN
10	ENTER COMMAND IN	23	REC COMMAND IN
11	KILL LOCAL COMMAND IN	24	CUE STDBY COMMAND IN
12	Reserved	25	PREVIOUS COMMAND IN
13	Reserved		

Caution

Do not set more than two COMMAND IN pins (pin numbers 6, 9, 10, 20, 21, 22, 23, 24, and 25) to LOW at the same time as this will cause the MD recorder to malfunction.

7 ANALOG OUT connectors (CH-1:L/CH-2:R, XLR 3-pin)

Output analog audio signals.

8 ANALOG IN connectors (CH-1:L/CH-2:R, XLR 3-pin)

Input analog audio signals.

Pin assignment

Pin No.	Signal
1	GND
2	HOT
3	COLD

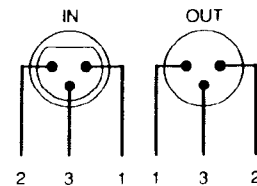

2-3 Remote Controller

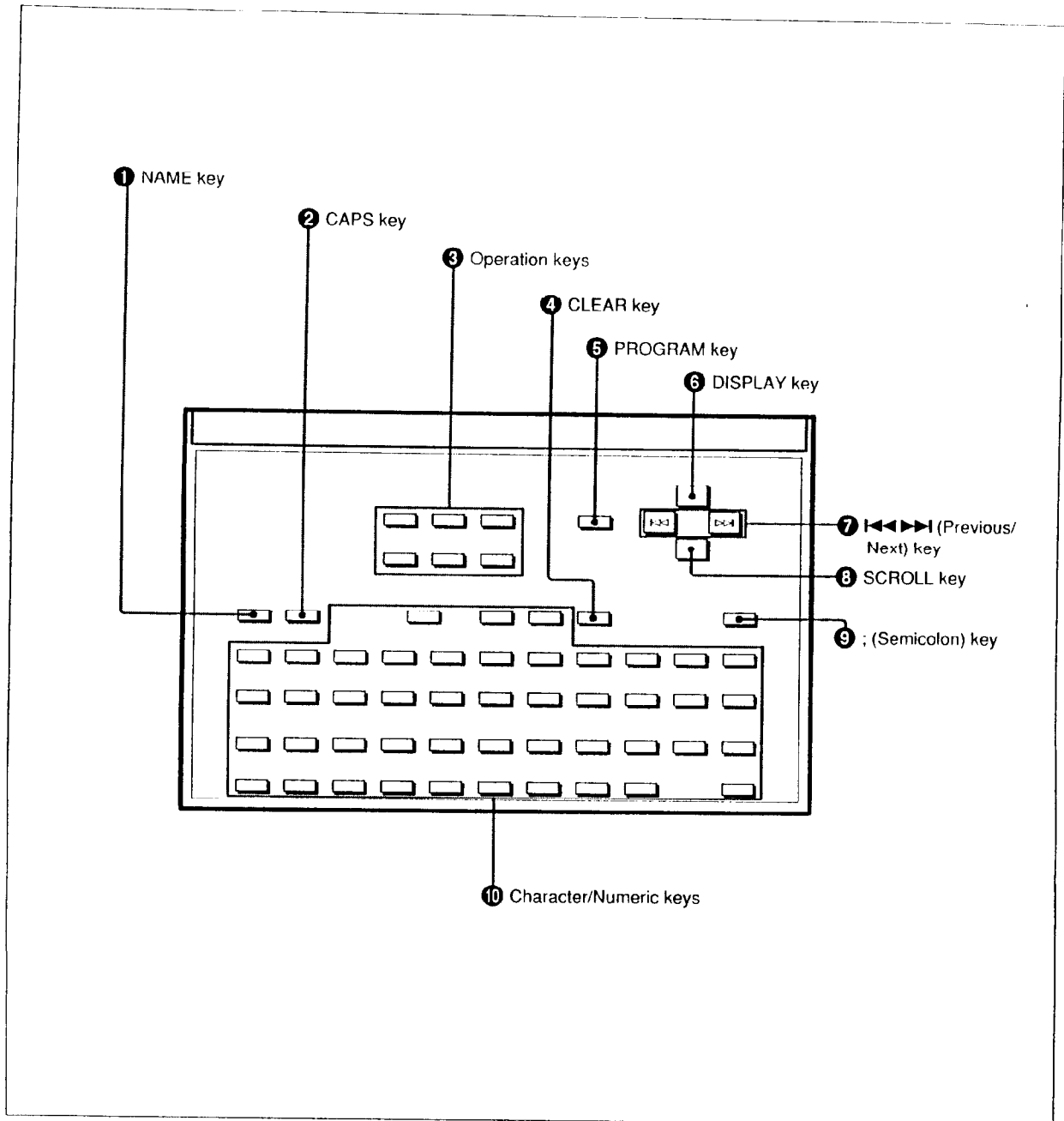

Remote controller

① NAME key

Press to activate the title function.

② CAPS (capital letters) key

Press to enter uppercase letters.

③ Operation keys

Use the following keys to do the same operations as the respective keys on the MD recorder.

EDIT/NO key

Press to specify or cancel an editing function:

ENTER/YES key

Press to execute a specified editing function.

REC (recording) key

Press once to pause recording, then press the PLAY/PAUSE key to start recording.

STOP key

Press to stop playback or recording, or to cancel program play.

PLAY/PAUSE key

Press to start playback or recording. Press during playback to temporarily stop the MD recorder; press again to cancel pause.

CUE STDBY (standby) key

Press to return to the position where you last pressed the PLAY/PAUSE key. After finding the position, the MD recorder enters playback pause. Use this key to check or return to a cuing position.

④ CLEAR key

Press to erase an entered character or number.

⑤ PROGRAM key

Press to activate program play.

⑥ DISPLAY key

Press this key to display disc information. The following items appear in sequential order each time you press this key.

When the recorder is stopped: Disc title, total track number and total disc playing time, remaining recording time on disc. (In case of premastered discs: disc title, total track number and total disc playing time.)

During playback or playback pause: Track title, remaining playing time of current track, and elapsed playing time.

Hold down the key for three seconds while the track title or elapsed playing time is on and the display will alternate with the remaining playing time (auto display function).

During recording: Elapsed recording time of current track, remaining recording time on disc. Press the DISPLAY key together with the STOP key to activate the menu setting function.

⑦ ⏮⏪⏩⏭ (Previous/Next) key

Press the respective key to cue to the beginning of the previous or next track.

Hold down the key during playback to scan backward or forward with sound output.

⑧ SCROLL key

Press to scroll titles over 13 characters in length.

⑨ ; (Semicolon) key

Press while entering a title to divide the title into independently displayable parts.

⑩ Character/Numeric keys

Use the numeric keys to specify tracks for immediate playback or program play. Use the character keys to enter disc and track titles.

Chapter 3 Preparations

This chapter explains precautions, making connections, taking care of discs, and setting the reference level of analog input/output signals.

3-1	Precautions	3-2
3-1-1	Installation Precautions	3-2
3-1-2	Handling Precautions	3-2
3-2	Connections	3-3
3-2-1	Precautions	3-3
3-2-2	Basic Connection Examples	3-3
3-3	Handling MiniDiscs	3-4
3-4	Setting the Analog Input/Output Reference Level	3-5

3-1 Precautions

3-1-1 Installation Precautions

Install the MD recorder on a flat surface in a temperature-controlled room. Avoid using or storing the MD recorder at a location that is:

- extremely hot or cold.
- damp.
- subject to severe vibrations.
- subject to strong magnetic fields.
- subject to many hours of direct sunlight or close to heating equipment.

3-1-2 Handling Precautions

- Check the MD recorder's operating voltage before you plug it in. It must be identical with that of your local power supply.
- If you drop any liquid or metal object inside the MD recorder, immediately stop using it, unplug the power cord from the socket, and contact Sony service personnel.
- If the MD recorder will be unused for a long time, make sure to unplug its power cord from the socket. When unplugging the power cord, grasp it by the plug, not the cord.
- Never remove the cabinet. The laser light used in the MD recorder can cause damage to your eyes. If the MD recorder needs to be inspected, contact Sony service personnel.

Condensation

Bringing in the MD recorder from a cold place or turning on the room heating may cause moisture to condense on the lens within the MD recorder, resulting in abnormal operation. If this occurs, leave the power on. The moisture will evaporate within an hour and the MD recorder will function normally again. If the MD recorder does not operate normally after a few hours, contact Sony service personnel.

If trouble occurs

Should you detect abnormal noise, smell, or smoke, immediately turn off the power, unplug the power cord from the socket, and contact Sony service personnel.

AC power cord

Do not use any power cord other than the one supplied with the MD recorder.

3-2 Connections

3-2-1 Precautions

- Turn off all equipment before connecting or disconnecting any cables.
- Insert all electrical plugs firmly since incomplete connections may cause noise.
- Use a cord somewhat longer than needed to prevent the plug from being pulled out when jarred or shaken.

3-2-2 Basic Connection Examples

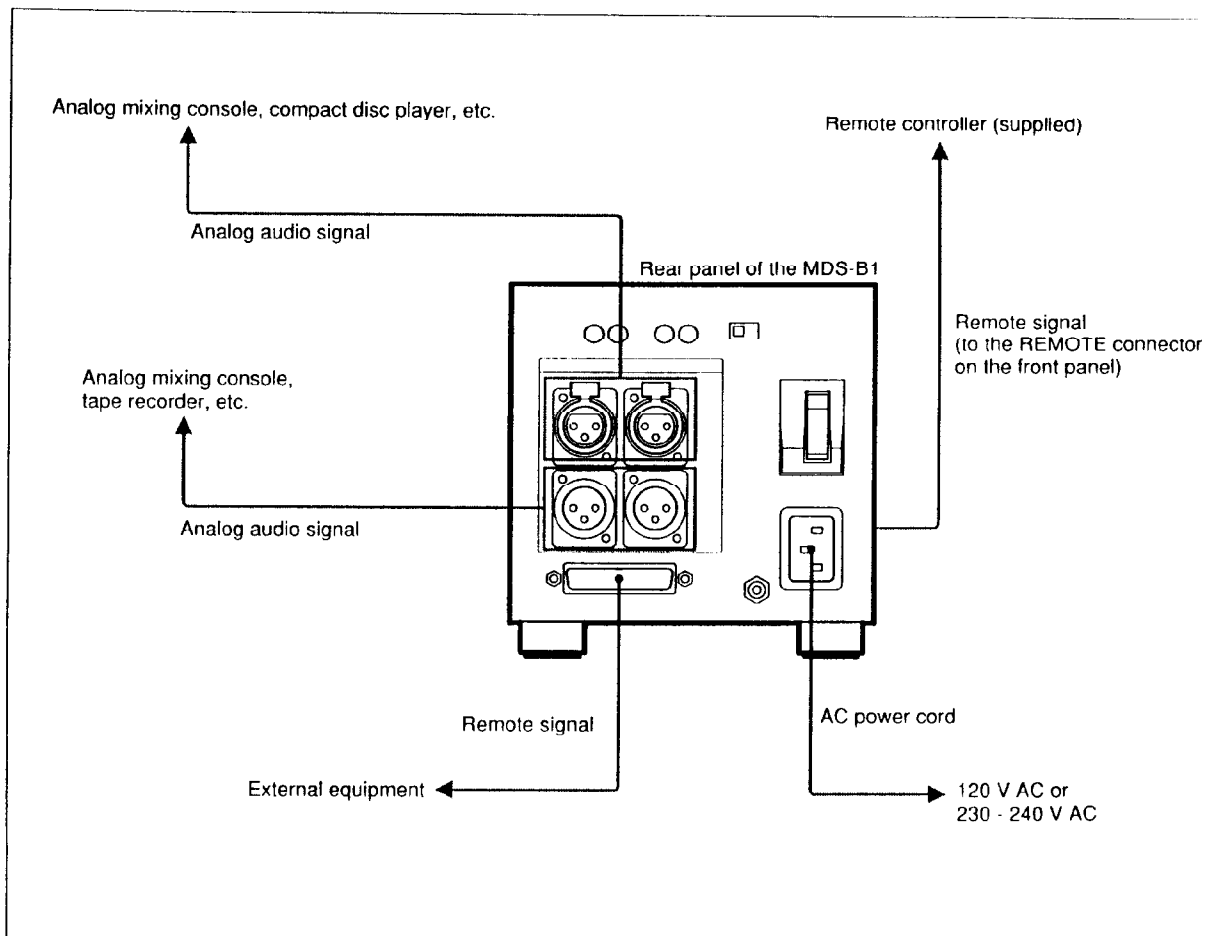

Basic connection examples

3-3 Handling MiniDiscs

Unlike CDs (Compact Discs), the MiniDisc is encased within a hard plastic cartridge which allows you to handle it without fear of dust or fingerprint contamination. However, a MiniDisc that has been contaminated or bent may cause the MD player to malfunction. To prevent damage to the contents of a disc and to enjoy clear sound permanently, take the following precautions when handling a MiniDisc:

Do not open the shutter to expose the disc

If you do so, the data on the disc may be damaged.

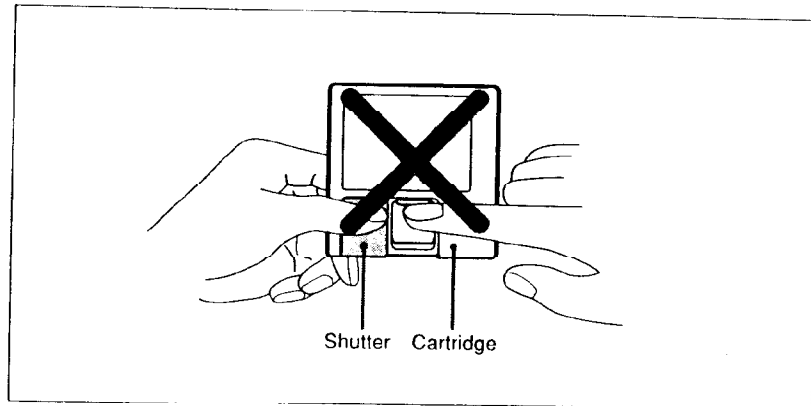

Handling MiniDiscs

Store MiniDiscs in a proper location

Do not place the cartridge where it will be subject to extremes of sunlight, temperature, moisture or dust.

Cleaning the MiniDisc

Gently wipe the cartridge with a dry soft cloth to remove dust.

3-4 Setting the Analog Input/Output Reference Level

You can adjust the analog input/output reference level during recording or playback within a range of +8 dB to -12 dB by turning the PLAYBACK/RECORD level controls on the rear of the MD recorder. The analog input/output reference level is set at +4 dB at -20 dB from the full bit level at the factory.

Setting the analog input/output reference level

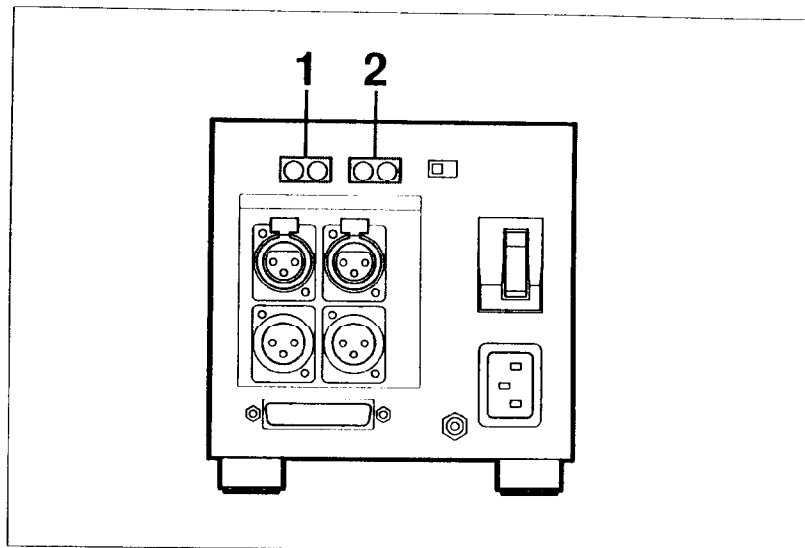

Setting the reference level

- 1** Playback a disc recorded at -20 dB from the full bit. Adjust the output level of the ANALOG OUT connectors with the PLAYBACK (CH-1/CH-2) controls.
- 2** Input an audio signal to the ANALOG IN connectors and adjust the recording level with the RECORD (CH-1/CH-2) controls.

Note

Adjust the PLAYBACK/RECORD level controls with a bladed screwdriver. Do not use excessive force when turning the screwdriver or touch the screwdriver to any part other than the PLAYBACK/RECORD level controls.

Chapter 4 Recording

This chapter explains the basic procedures for recording an MD, displaying data during recording, and recording disc and track titles.

4-1	Recording Procedure	4-2
4-2	Display Information During Recording	4-4
4-3	Adding Disc and Track Titles	4-5

4-1 Recording Procedure

If the inserted disc already contains recorded material, the MD recorder will automatically record the new material at the end of the existing material with a new track number.

To adjust the recording level, see "3-4 Setting the Analog Input/Output Reference Level" on page 3-5.

To record track numbers automatically at points of low signal level, see "7-4 Recording a Track Number Automatically (LevelSync Setting)" on page 7-6.

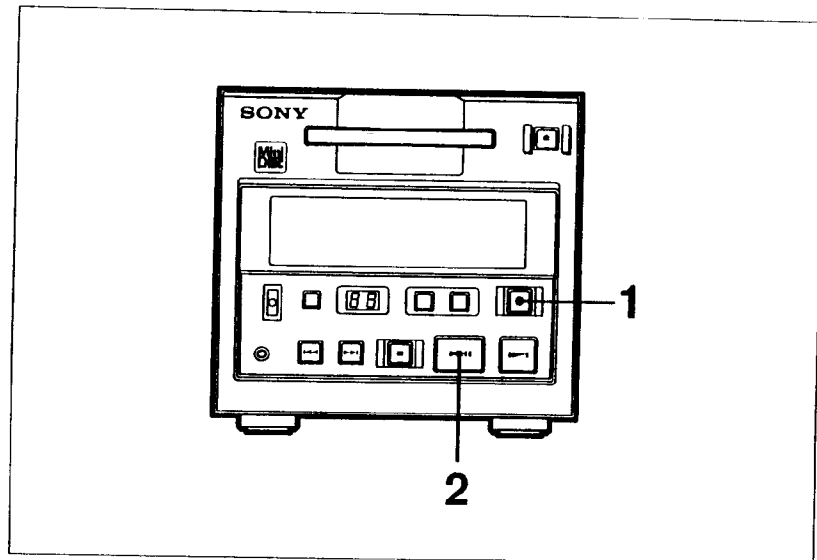

Recording procedure

- 1** Press the REC key.
The MD recorder enters recording pause. (The REC key lights and the PLAY/PAUSE key flashes.)
- 2** Press the PLAY/PAUSE key.
Recording starts. (The REC and PLAY/PAUSE keys light.)
- 3** Play the sound source to be recorded.
The track number being recorded and elapsed recording time appear in the display.

To record a track number manually during recording

Press the REC key at the required point.

To stop recording

Press the STOP key.

To stop recording temporarily

Press the PLAY/PAUSE key.

To resume recording, press the PLAY/PAUSE key again.

To eject the disc

Press the STOP key to stop the MD, then press the EJECT key.

Note

If the MD recorder stays in recording pause for more than ten minutes, the MD recorder cancels recording pause, then stops.

Preventing accidental erasure

Slide the record-protect tab to open the slot. To allow recording again, slide the tab to close the slot.

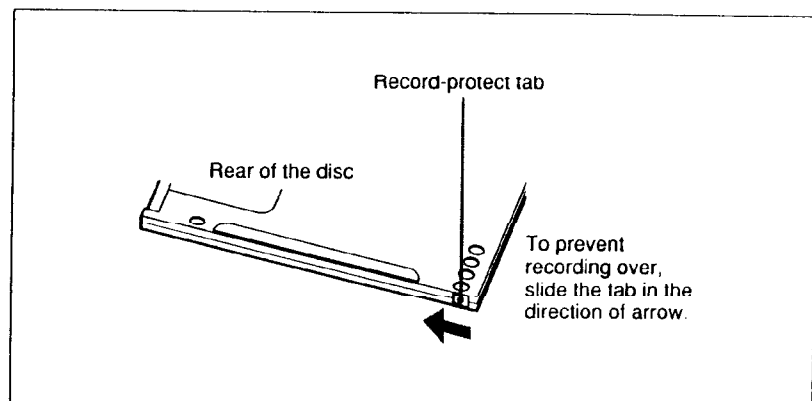

To protect a MiniDisc against accidental erasure

The recording system in your MD recorder is radically different from those used in cassette and DAT decks and is characterized by the limitations described below.

“Disc Full” lights up even before the disc has reached the maximum recording time (60 or 74 minutes)

When 255 tracks have been recorded on the disc, “Disc Full” lights up regardless of the total recorded time. More than 255 tracks cannot be recorded on the disc.

“Disc Full” lights up before the maximum number of tracks is reached

Fluctuations in emphasis within tracks are sometimes interpreted as track intervals, incrementing the track count.

The total recorded time and the remaining time on the disc may not equal the maximum recording time (60 or 74 minutes)

Recording is done in minimum units of 2 seconds each, no matter how short the material. The contents recorded may thus be shorter than the maximum recording capacity. Disc space may also be further reduced by scratches.

“TOC Reading” indication appears for a long time

If the inserted recorded disc is brand new, the “TOC Reading” indication appears on the display longer than for those that have been used.

Playback of a track of under 4 seconds may be accompanied by sound dropout at the start of the next track or misoperation of the MD recorder.

4-2 Display Information During Recording

Changing the display information during recording

Each press of the DISPLAY key during recording changes the information on the display as follows:

- Recorded time of the current track

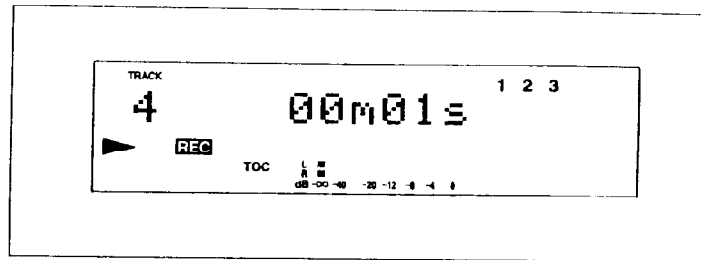

- Remaining recording time on disc

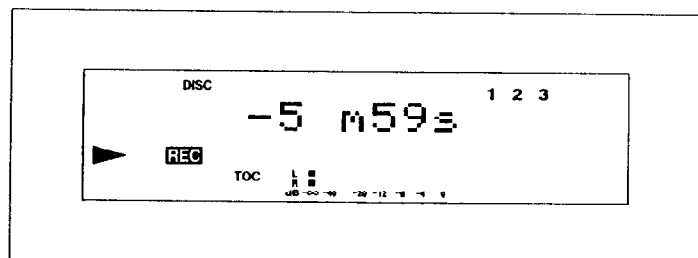

4-3 Adding Disc and Track Titles

Use the title function to add titles to your own discs and tracks with the character/numeric keys on the remote controller.

The maximum length of a single title is 100 characters, and the maximum number of characters for all titles on a disc is 1,792.

Newly added titles are temporarily stored in the recorder's memory (not saved to disc). To record the titles to the disc, press the STOP key or eject the disc before turning off the power.

For more details, see "6-1 Overview of Editing Functions" on page 6-2.

Adding a disc title

You can use this procedure while the MD recorder is stopped to add a title to the MiniDisc.

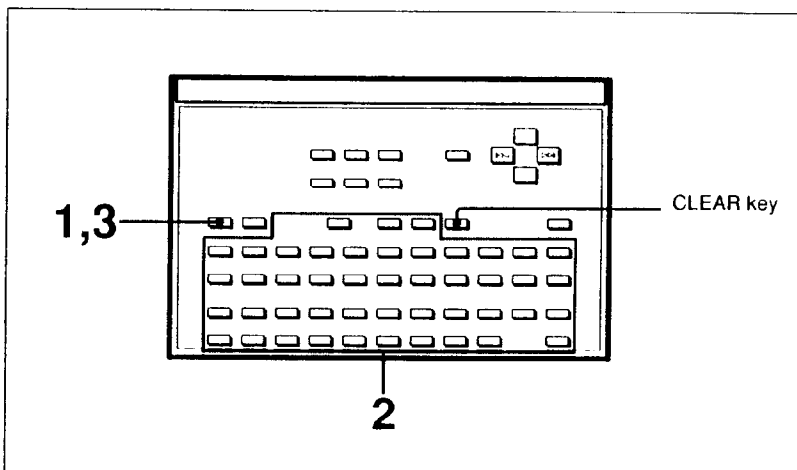

Adding a disc title

- 1 Insert the disc, then press the NAME key while the MD recorder is stopped.
A flashing cursor appears in the display.

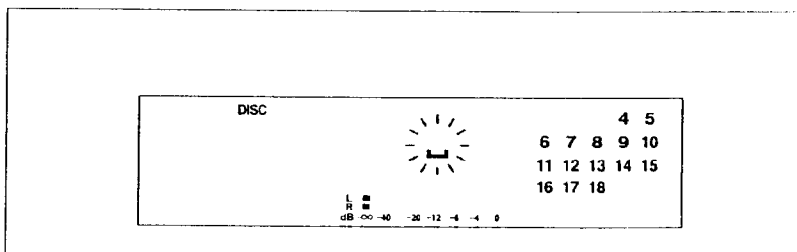

- 2 Type in a disc title with the character/numeric keys on the remote controller.
- 3 Press the NAME key.
The disc title is entered.

4-3 Adding Disc and Track Titles

Making a correction

Press the CLEAR key to erase a typing error, then enter the correct character.

Adding a track title

Follow the procedure below to add a title to a track during playback, playback pause, or recording.

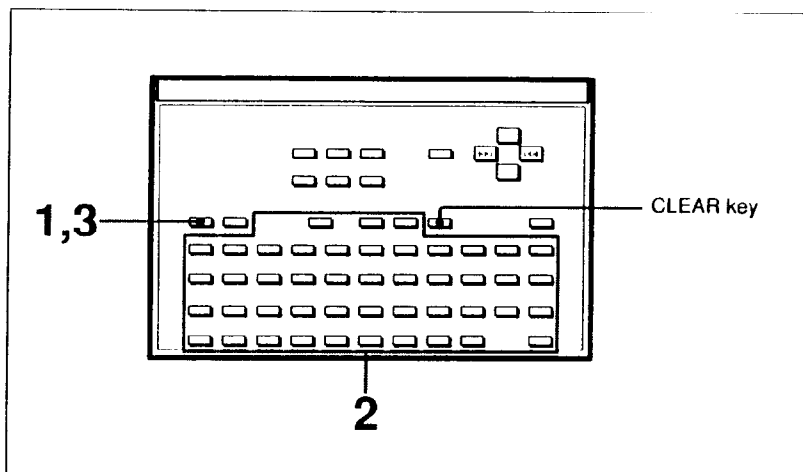

Adding a track title

- 1 Press the NAME key while playing, pausing or recording the track to be named.
A flashing cursor appears in the display.

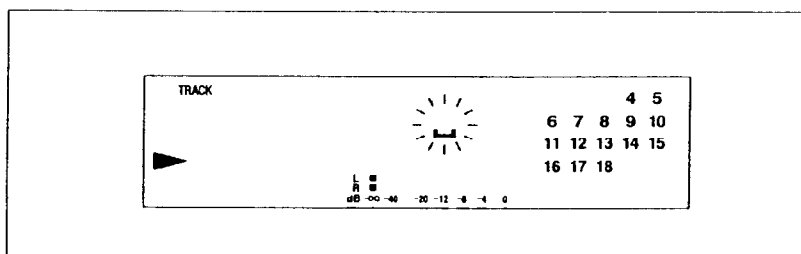

- 2 Type in the track title with the character/numeric keys on the remote controller.
- 3 Press the NAME key.
The track title is entered.

Making a correction

Press the CLEAR key to erase a typing error, then enter the correct character.

Dividing a track title into separate parts

When you add a track title, you can divide it by using semicolons, then display each part independently by pressing the DISPLAY key during playback of the track.

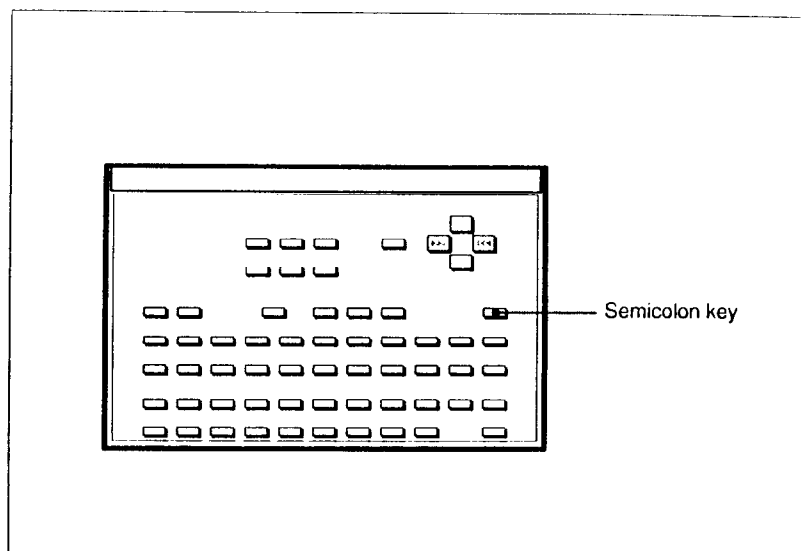

Dividing a track title into separate parts

Note

If "Protected" appears in the display

The record-protection slot on the disc is open and titles cannot be written to the disc. To add titles to the disc, eject the disc and close the slot.

Chapter 5 Playback

This chapter outlines the various playback functions of the MDS-B1 and explains the procedures for playing tracks, locating tracks, and displaying information during playback.

5-1 Overview of MDS-B1 Playback Functions	5-2
5-2 Playback Procedure	5-5
5-2-1 Playing Back	5-5
5-2-2 Locating a Specific Position (Search)	5-6
5-3 Locating a Track	5-7
5-3-1 Locating a Specific Track	5-7
5-3-2 Locating the Beginning of a Track (AMS)	5-8
5-4 Display Information During Playback	5-9
5-5 Playing Tracks Repeatedly	5-11
5-6 Playing Back a Program (Program Play)	5-12

5-1 Overview of MDS-B1 Playback Functions

The MDS-B1's many playback functions can be used in a variety of ways in broadcasting. This section gives an overview of these functions and their application.

AUTO PAUSE and AUTO CUE functions

AUTO PAUSE function

When AUTO PAUSE is on, the MD recorder pauses after locating the track.

How to activate it: Specify by menu.

For details, see page 7-4.

Purpose: Prevents on-the-air mistakes by pausing the MD recorder right before the start of play. When AUTO PAUSE is off, the MD recorder starts playing back immediately after locating the track.

AUTO CUE function

When the AUTO CUE function is on, the MD recorder changes to playback pause when it detects a rise in audio signal during a silent portion (-58 dB or less).

How to activate it: Specify by menu.

For details, see page 7-4.

Purpose: For precise cueing to play back sounds instantly.

When the MD recorder reaches a track with no sound while AUTO CUE is on

During one-track repeat play: The MD recorder pauses at the beginning of the track.

During all-tracks repeat play or when the repeat play function is off: The MD recorder locates the point where the audio level rises at the beginning of the next track.

Relation between the track location operation and AUTO PAUSE/AUTO CUE function

The following table indicates the respective track location operation of the MD recorder in relation to AUTO PAUSE/AUTO CUE function.

When locating a specific track with the numeric keys

AUTO PAUSE and AUTO CUE off	Begins playback immediately after locating the specified track.
AUTO PAUSE on	Changes to playback pause after locating the beginning of the specified track.
AUTO CUE on	Changes to playback pause just as the audio level rises (above -58 dB) at the beginning of the located track.

When locating the beginning of a track by pressing the NEXT or PREVIOUS key (AMS)

AUTO PAUSE and AUTO CUE off	Displays the track number after locating the specified track, then stops.
AUTO PAUSE on	Changes to playback pause after locating the beginning of the specified track.
AUTO CUE on	Changes to playback pause just as the audio level rises (above -58 dB) at the beginning of the located track.

Repeat playback functions

Three types of repeat playback functions can be used.

One-track repeat playback

The MD recorder plays back a specific track repeatedly.

How to activate it: Set the REPEAT1/OFF/REPEAT ALL switch to REPEAT1.

Purpose: For repeated playback of the same material.

All-tracks repeat playback

The MD recorder plays back all tracks repeatedly and in sequential order.

How to activate it: Set the REPEAT1/OFF/REPEAT ALL switch to REPEAT ALL.

Purpose: For repeated playback of a recorded or edited disc with a particular track sequence.

Program repeat playback

The MD recorder plays back a program repeatedly.

How to activate it: Set the REPEAT1/OFF/REPEAT ALL switch to either REPEAT1 or REPEAT ALL, then press the PROGRAM key.

Purpose: For repeated playback of the programmed tracks.

5-1 Overview of MDS-B1 Playback Functions

The following table indicates the respective repeat play operation of the MD recorder in relation to AUTO PAUSE.

	During one-track repeat play	During all-tracks repeat play	When repeat play function is OFF
When AUTO PAUSE or AUTO CUE are on ^{a)}			
When AUTO PAUSE and AUTO CUE are off			

- a) When AUTO PAUSE is on, the MD recorder pauses after locating the track.
 When AUTO CUE is on, the MD recorder pauses just as the audio level rises at the beginning of the located track.

Cue standby function

Pressing the CUE STDBY key causes the MD recorder to return to and enter playback pause at the last cueing position specified by pressing the PLAY/PAUSE key. Use this key to check or go to a previously set cueing position.

During program play, this function operates only within the currently playing track, and cannot be used to return to a cueing position within a previously played back.

5-2 Playback Procedure

5-2-1 Playing Back

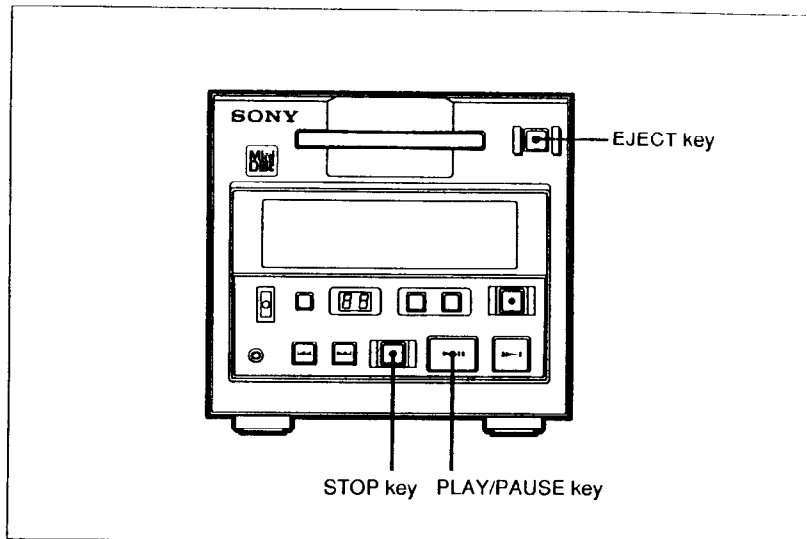

Playing Back

Press the PLAY/PAUSE key.

When AUTO PAUSE and AUTO CUE are off:

The MD recorder starts playing. The current track title appears in the display.

When AUTO PAUSE is on:

The MD recorder enters playback pause at the beginning of the first track. The current track title appears in the display.

When AUTO CUE is on:

The MD recorder enters playback pause just as the audio level rises (above -58 dB) at the beginning of the first track. The current track title appears in the display.

To stop playback

Press the STOP key.

To stop playback temporarily

Press the PLAY/PAUSE key.

To restart playback, press the PLAY/PAUSE key again.

To eject the disc

Press the STOP key to stop playback, then press the EJECT key.

Your MiniDisc recorder is designed as a stereo system and cannot be used to play back monaural format MDs.

5-2 Playback Procedure

5-2-2 Locating a Specific Position (Search)

To find a specific position on the MD, use the NEXT and PREVIOUS keys during playback to quickly scan forward or backward.

To forward scan the disc

Hold down the NEXT key during playback. Releasing the key causes the MD recorder to play from the new location.

To backward scan the disc

Hold down the PREVIOUS key during playback. Releasing the key causes the MD recorder to play from the new location.

Note

Tracks created through editing may exhibit sound dropout during search operations.

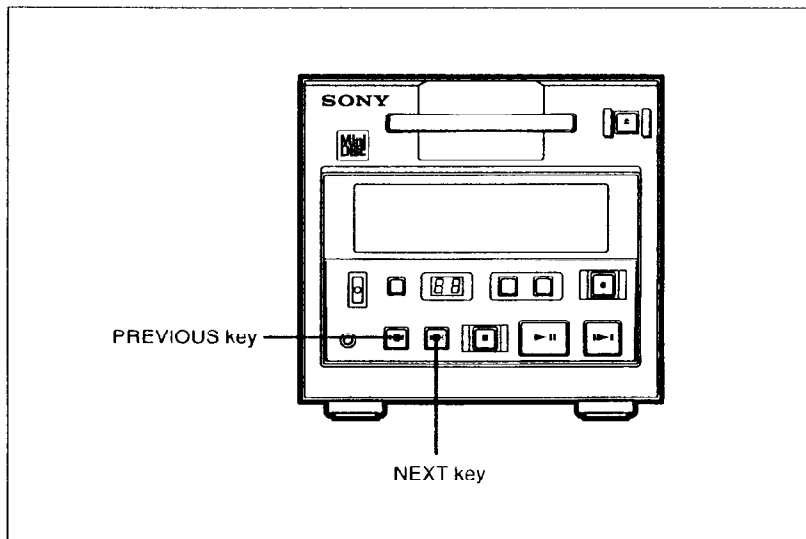

Locating a specific position

5-3 Locating a Track

5-3-1 Locating a Specific Track

Access specific tracks instantly by entering their respective track numbers with the numeric keys on the remote controller.

If AUTO PAUSE and AUTO CUE are off, the MD recorder begins playback immediately after locating the specified track.

If AUTO PAUSE is on, the MD recorder changes to playback pause after locating the beginning of the specified track.

If AUTO CUE is on, the MD recorder changes to playback pause just as the audio level rises (above -58 dB) at the beginning of the located track.

For details on the AUTO PAUSE and AUTO CUE functions, see "7-2 Setting the Timing of the EOM Indication" on page 7-3.

To specify track numbers greater than 10

Use the >10 key to specify the respective power of ten.

Example:

To locate the 15th track, press the >10 key once, then press 1 and 5.

To locate the 215th track, press the >10 key twice, then press 2, 1, and 5.

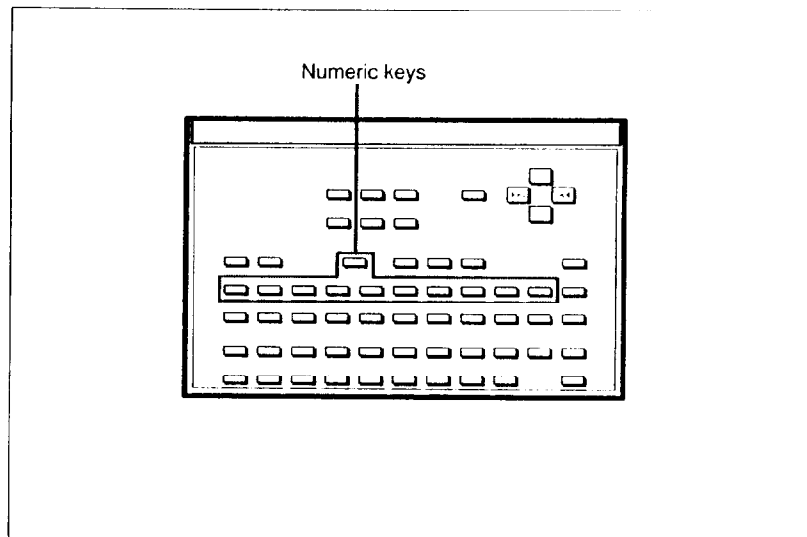

Locating a specific track

5-3 Locating a Track

5-3-2 Locating the Beginning of a Track (AMS¹⁾)

When the MD recorder is stopped or in playback pause, you can quickly skip to any track number before or after the current one by pressing the NEXT or PREVIOUS key. (Holding down a key causes the track numbers to change quickly.)

If AUTO PAUSE and AUTO CUE are off, the MD recorder displays the track number after locating the specified track, then stops.

If AUTO PAUSE is on, the MD recorder changes to playback pause after locating the beginning of the specified track.

If AUTO CUE is on, the MD recorder changes to playback pause just as the audio level rises (above -58 dB) at the beginning of the located track.

For details on the AUTO PAUSE and AUTO CUE functions, see "7-2 Setting the Timing of the EOM Indication" on page 7-3.

To go to the beginning of a preceding track

Press the PREVIOUS key. Each press of the key decreases the track number by one.

To go to the beginning of a proceeding track

Press the NEXT key. Each press of the key increases the track number by one.

To go quickly to the last track on the disc

Press the PREVIOUS key after inserting the disc.

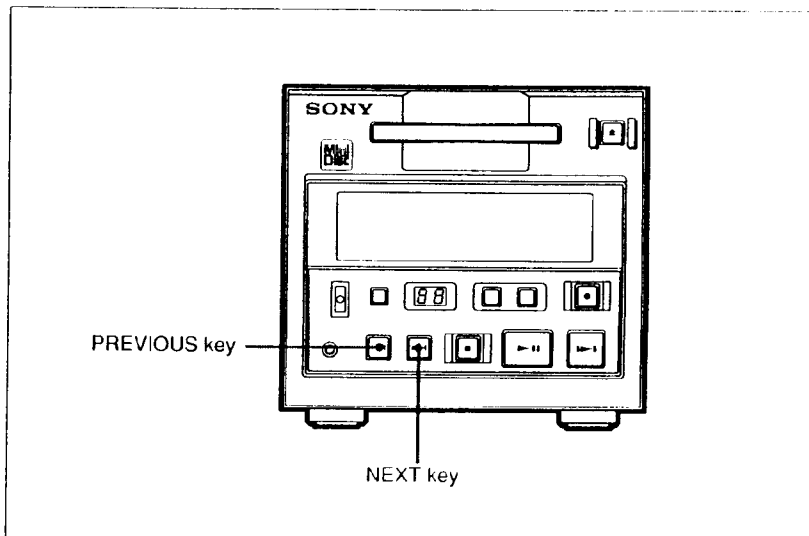

Locating a specific track

¹ AMS is the abbreviation for Automatic Music Sensor.

5-4 Display Information During Playback

Changing the display information during playback

Each press of the DISPLAY key during playback or playback pause, changes the information on the display as follows:

- Track title¹⁾

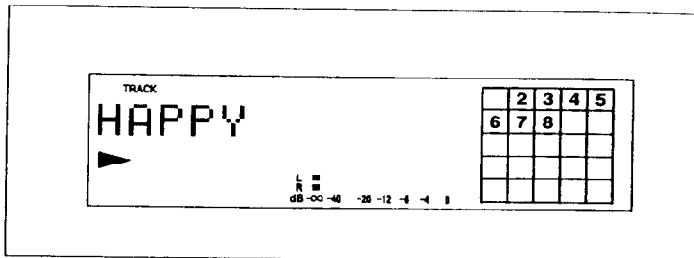

- Remaining playing time of the current track

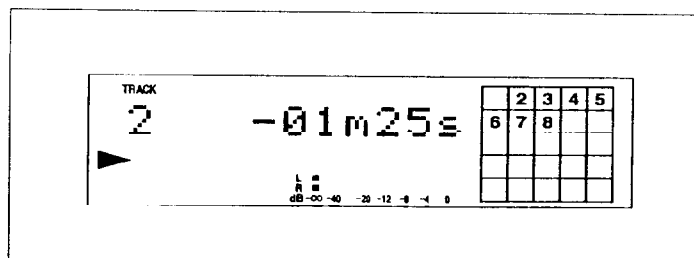

- Elapsed playing time of the current track

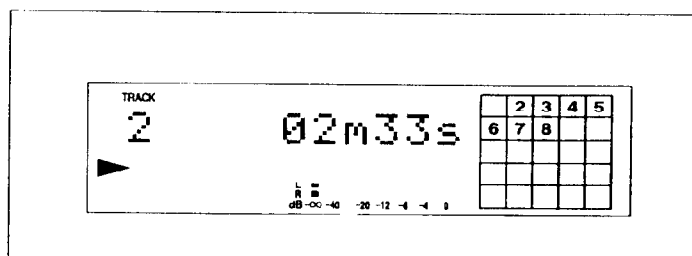

¹⁾ If the track title has been divided into separate parts by semicolons, each part is displayed independently each time you press the DISPLAY key.
To divide a track title into separate parts, see "Dividing a track title into separate parts" on page 4-7.

5-4 Display Information During Playback

Alternating display of title of current track and the remaining playing time (auto display function)

To cause the title of current track and remaining playing time to alternately appear on the display, hold down the DISPLAY key for about three seconds during playback, then release it.

Use this function when you want to check the remaining time and title of the current track during playback.

To cancel the alternating display, hold the DISPLAY key down for about three seconds again.

When an end of a track approaches

When the end of a track approaches, the indication in the display starts to flash (EOM indication).

To specify the timing of the indication, see "7-2 Setting the Timing of the EOM Indication" on page 7-3.

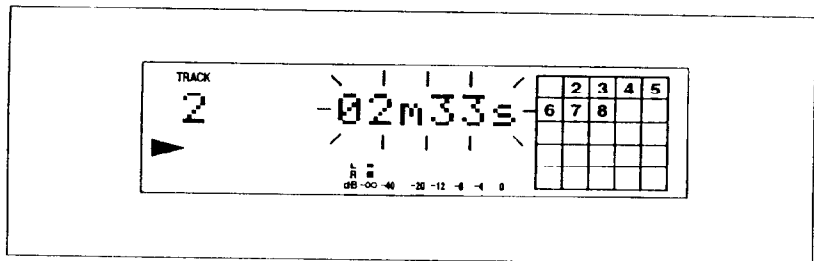

Display when the end of the track approaches

Note

If the EOM indication function activates while the auto display function is on, the track title stays on and begins to flash.

5-6 Playing Back a Program (Program Play)

Use the program play function to specify the playback sequence of multiple tracks.

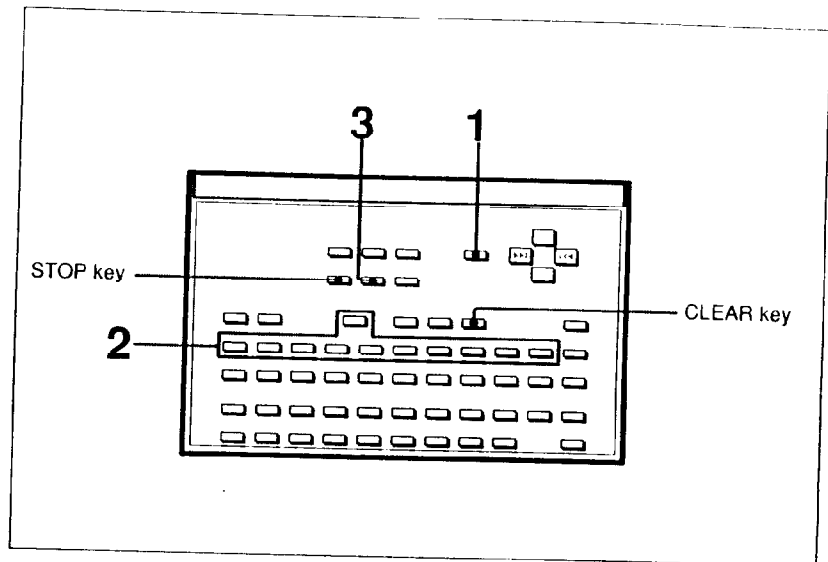

Program play

- 1** Press the PROGRAM key of the remote controller while the MD is stopped.
The PROGRAM indicator turns on.
- 2** Enter the numbers of the tracks to be played in the order of their playback.
When you enter a track number, the display shows the track number and the order of the specified track, followed by the total program time.
- 3** Press the PLAY/PAUSE key.
When AUTO PAUSE and AUTO CUE are off:
Program play starts from the first track of the program.
When AUTO PAUSE is on:
The MD recorder enters playback pause at the beginning of the first track of the program.
When AUTO CUE is on:
The MD recorder enters playback pause just as the audio level rises (above -58 dB) at the beginning of the first track of the program.

To enter track numbers greater than 10

Press the >10 key to indicate the respective power of ten.

Example:

To enter the 15th track, press the >10 key once, then press 1 and 5.

To enter the 215th track, press the >10 key twice, then press 2, 1, and 5.

5-5 Playing Tracks Repeatedly

You can select the following repeat functions with the REPEAT1/OFF/REPEAT ALL switch.

REPEAT1: The MD recorder plays back the current track repeatedly.

OFF: The MD recorder plays back each track once.

REPEAT ALL: The MD recorder plays back all tracks repeatedly and in sequential order. During program play, the MD recorder plays back selected tracks in a programmed order repeatedly.

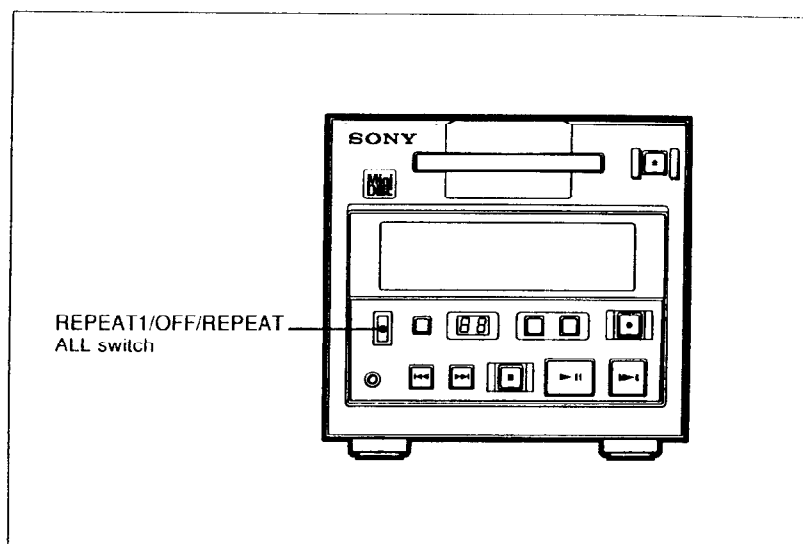

Playing tracks repeatedly

Once you have specified the repeat function during program play, you cannot use the REPEAT1 setting to playback repeatedly individual tracks within the program.

To erase tracks from a program

Press the CLEAR key. The displayed track number is erased from the program. To continue erasing tracks one at a time, press the CLEAR key repeatedly.

To erase an entire program

Press the STOP key.

To stop program play

Press the STOP key. Pressing the STOP key again erases the entire program.

To cancel program play

Press the PROGRAM key.
The PROGRAM indicator turns off.

Chapter 6

Editing Functions

This chapter explains MD editing functions such as erasing, dividing, combining, and moving tracks.

6-1 Overview of Editing Functions	6-2
6-2 Erasing Recordings (Erase Function)	6-3
6-3 Dividing a Recorded Track (Divide Function)	6-5
6-4 Combining Recorded Tracks (Combine Function)	6-7
6-5 Moving Recorded Tracks (Move Function)	6-9

6-1 Overview of Editing Functions

Purpose of editing functions

The MDS-B1 editing functions allow you to rearrange the contents of recorded MDs to make it easy to locate specific tracks during playback.

Front panel or remote controller operations

You can do MD editing on either the front panel on the MD recorder or the remote controller. Editing procedures are identical in both cases, except in the specification of tracks to be edited, which is done with the numeric keys on the remote controller and with the NEXT and PREVIOUS keys on the front panel.

Selecting the editing function

Select the editing function by pressing the EDIT/NO key. Each press of the key displays a different editing function as follows:

- Erase? — For erasing recorded tracks
- Divide? — For dividing recorded tracks
- Combine? — For combining recorded tracks
- Move? — For moving recorded tracks

Tips on editing

If an editing procedure increases or decreases the number of tracks on the MD, the MD recorder will automatically renumber the tracks on that MD. For example, if you erase the second track, the third track becomes track 2, and all proceeding track numbers decrease by one. Since track numbers may change several times during editing operations, you should check the name and contents of all tracks as you edit them.

STOP key function

If you make any changes to an MD using the editing functions, you must press the STOP key to record the changes in the table of contents (TOC) area of the disc before turning off the MD recorder. If you don't do this, the editing changes will not be saved and the original MD contents will be unchanged.

You can press the STOP key to record changes after each editing operation, or save all changes together by pressing STOP or EJECT key after the last editing operation.

6-2 Erasing Recordings (Erase Function)

Use the erase function to erase a single track, successive tracks, or all tracks from a recorded disc.

After erasing a track, each track number following the erased track and the total number of tracks decrease by one.

Erasing a single track

You can erase a single track while the MD recorder is stopped, playing, or in playback pause status.

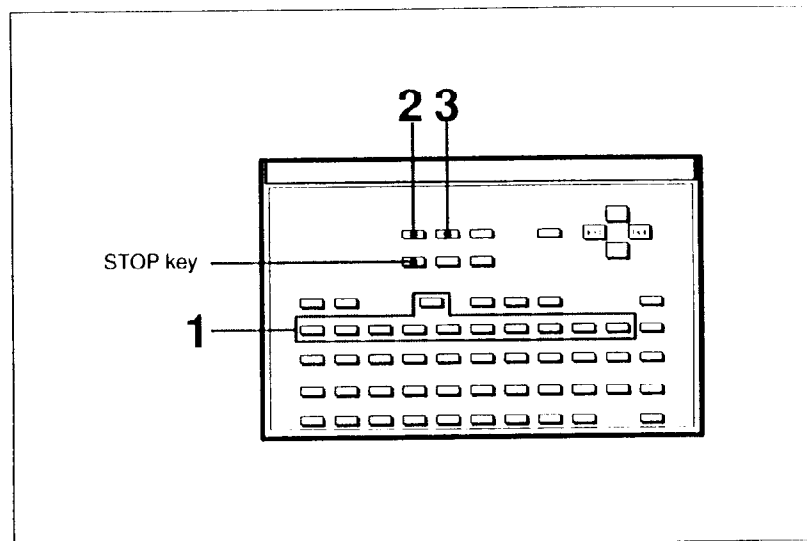

Erasing a single track

- 1** Enter the number of the track to be erased with the numeric keys (or the NEXT or PREVIOUS key on the front panel).
- 2** Press the EDIT/NO key until "Erase?" appears.
- 3** Press the ENTER/YES key.
"Complete" appears for a few seconds, then disappears when the specified track has been erased.

To continue erasing tracks

Repeat steps 2 and 3 to erase more tracks.

To cancel the erase function

Press the EDIT/NO or STOP key to make "Erase?" disappear.

6-2 Erasing Recordings (Erase Function)

Notes

- If “Erase!!?” appears, it means that the track was recorded or edited on another MD recorder and is write-protected. To erase the track, press the ENTER/YES key while “Erase!!?” is displayed.
- If “Protected” appears, it means that the record-protect slot on the MD is open and the track cannot be erased. Eject the disc and close the slot, then reinsert the MD to erase the track.

Erasing all tracks on an MD

You can erase all tracks on an MD when the MD recorder is stopped.

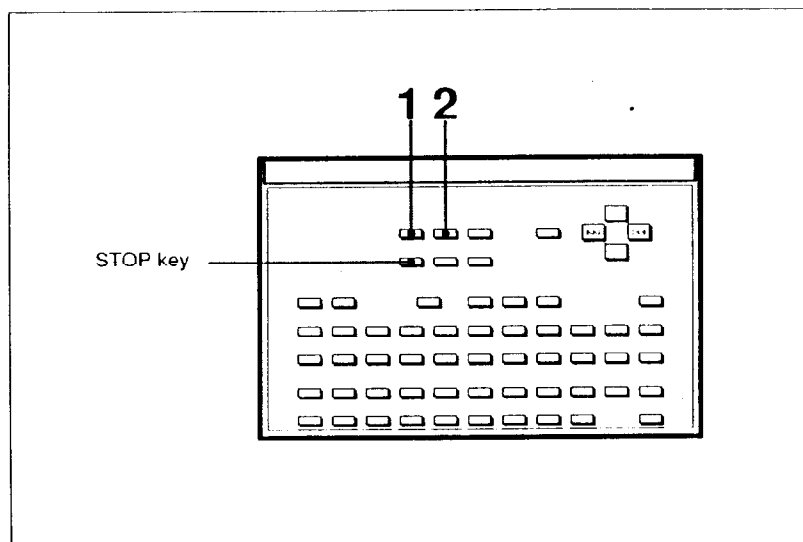

Erasing all tracks

- 1** Hold down the EDIT/NO key for about a second until “All Erase?” appears.
- 2** Press the ENTER/YES key. “Complete” appears for a few seconds, then disappears when all recorded tracks have been erased.

To cancel the Erase Function

Press the EDIT/NO or STOP key to make “All Erase?” disappear.

The remaining recording time does not increase even after erasing numerous short tracks

Tracks of under 8 seconds in length are not counted and so erasing them may not lead to an increase in the recording time.

6-3 Dividing a Recorded Track (Divide Function)

To randomly access certain portions of a track, the divide function allows you to create separate tracks for each portion. You can also use the divide function to erase selected portions of a track, by first specifying the portion as a separate track, then erasing that track (see "6-2 Erasing Recordings (Erase Function) on page 6-3). Do the divide function while playing the disc.

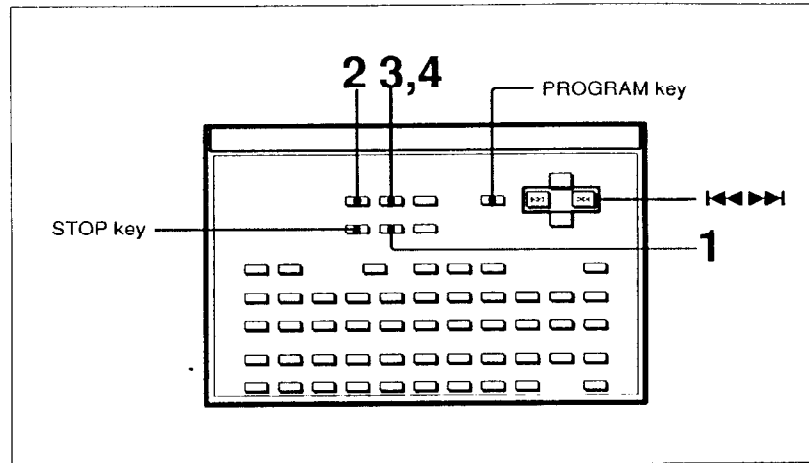

Dividing a recording track

- 1** While playing the track to be divided, press the PLAY/PAUSE key at the point where the new track is to begin. The MD recorder changes to playback pause.
- 2** Press the EDIT/NO key until "Divide?" appears.
- 3** Press the ENTER/YES key. "Rehearsal" and "Position ok?" alternately appear and the starting portion of the new track plays back repeatedly.

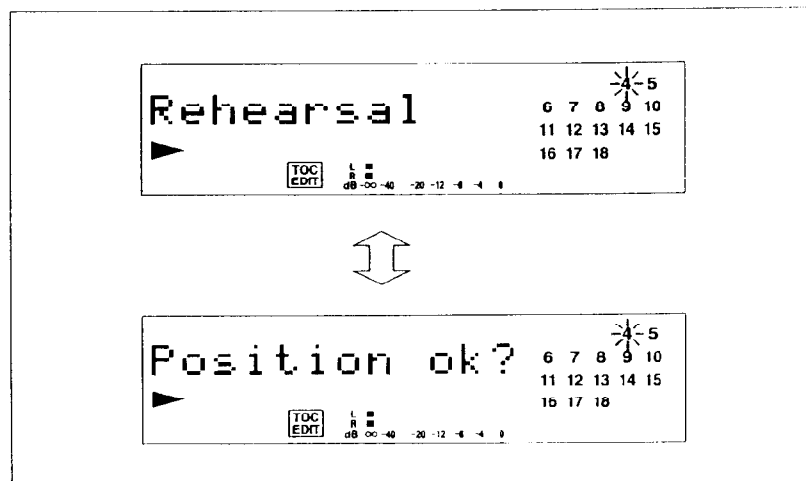

(Continued)

6-3 Dividing a Recorded Track (Divide Function)

- 4 When you find the correct position, press the ENTER/YES key. "Complete" appears for a few seconds, then disappears when the track has been divided. The MD recorder then begins playing from the point of division.

If the starting position is incorrect

Press the EDIT/NO key, then, while monitoring the sound, press the ►► (Next) or ◀◀ (Previous) key to change the starting position.

You can move the starting position in steps of ± 0.06 seconds, up to -128 to +127 steps from the original position.

"Rehearsal" and "Position ok?" alternately appear in the display while the starting position plays repeatedly.

To change the step interval

Press the PROGRAM key to select ± 1 for a step interval of ± 0.06 second, or ± 2 for a step interval of ± 0.12 second.

To cancel the divide function

Press the EDIT/NO or STOP key to make "Divide?" disappear.

Notes

- A new track created by the divide function will have no title even if the original track has one.
To add a title to the new track, see "4-3 Adding Disc and Track Titles" on page 4-5.
- If "Protected" appears, it means that the record-protect slot is open and the track cannot be divided. Eject the disc and close the slot, then reinsert the MD and divide the track.
- Some tracks of under 8 seconds long may not be divided.

6-4 Combining Recorded Tracks (Combine Function)

Use the combine function to combine consecutive tracks on a recorded disc.

You can combine tracks while the MD recorder is stopped, playing, or in playback pause status.

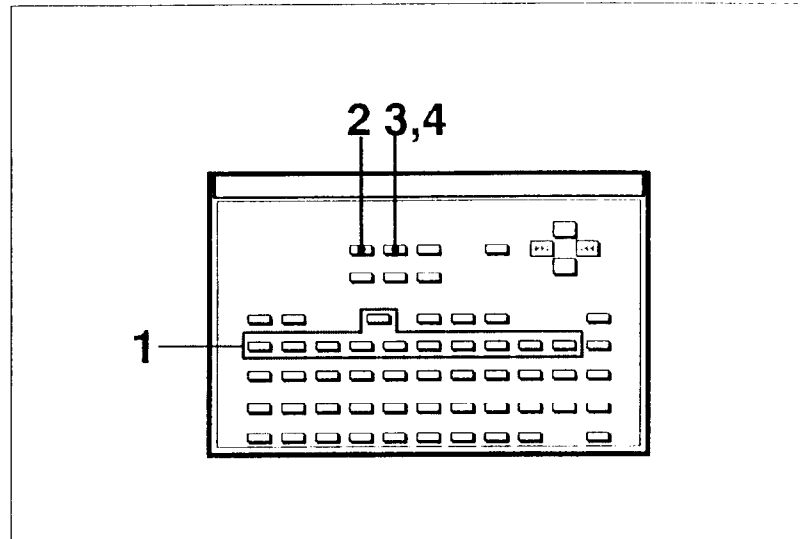

Combining recorded tracks

- 1 Specify the second track of the two tracks to be combined with the numeric keys (or the NEXT and PREVIOUS keys on the front panel).
For example, enter 4 to combine tracks 3 and 4.

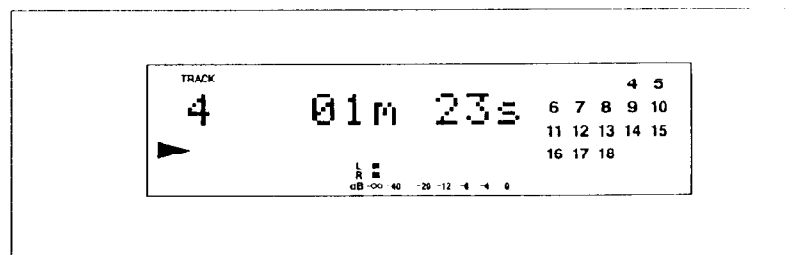

- 2 Press the EDIT/NO key until "Combine?" appears.

(Continued)

6-5 Moving Recorded Tracks (Move Function)

Use the move function to change the order of specific tracks. You can change the order of the tracks while the MD recorder is stopped, playing or in playback pause status.

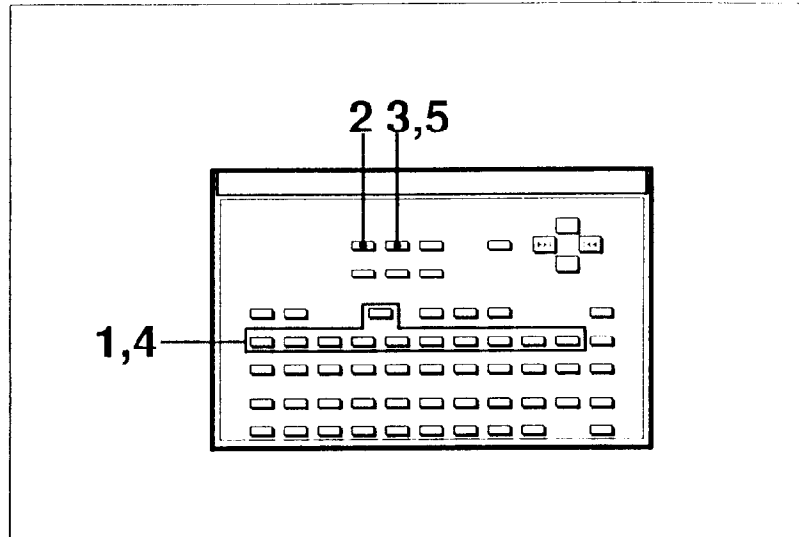

Moving recorded tracks

- 1 Specify the track to be moved with the numeric keys (or the NEXT and PREVIOUS keys on the front panel). For example, enter 3 to move track 3.

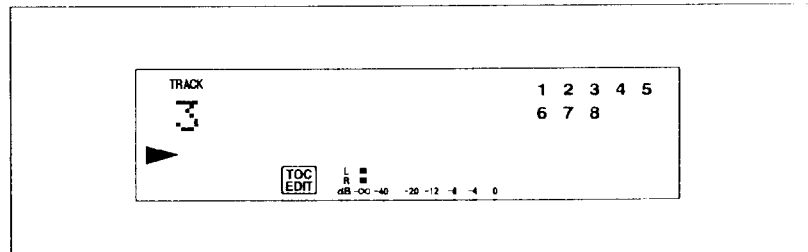

- 2 Press the EDIT/NO key until "Move?" appears.

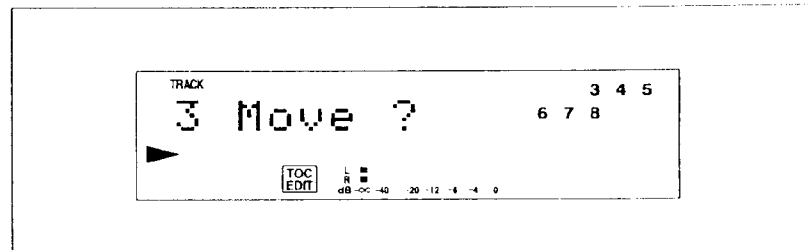

(Continued)

6-5 Moving Recorded Tracks (Move Function)

- 3** Press the ENTER/YES key.
The number of the track to be moved and the new track position appear.

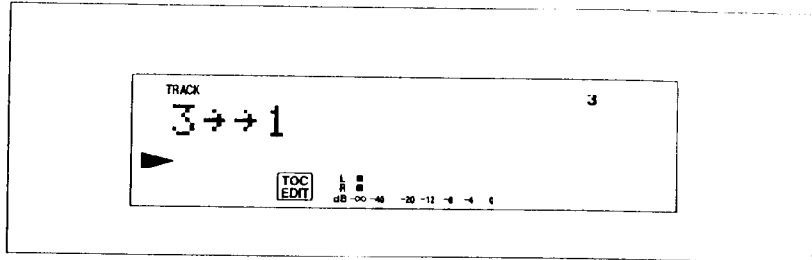

- 4** Specify the new position of the specified track with the numeric keys (or the NEXT and PREVIOUS keys on the front panel).
For example, enter 5 to move track 3 to track position 5.

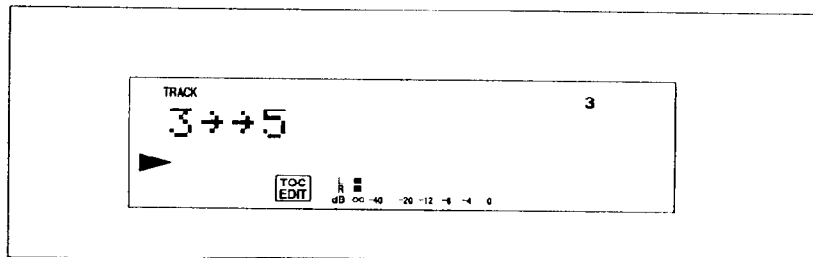

- 5** Press the ENTER/YES key.
"Complete" appears for a few seconds, then disappears when the track has been moved.

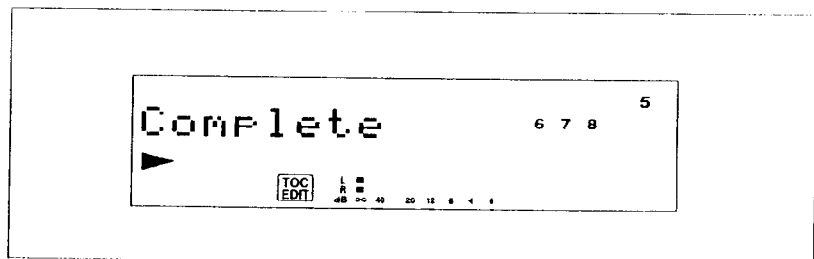

Notes

- If "Protected" appears, it means that the record-protect slot is open and the track cannot be moved. Eject the disc and close the slot, then reinsert the MD and move the track.
- Some tracks of under 8 seconds long may not be moved.

Chapter 7

Menu Functions

This chapter explains the MDS-B1's menu-selected functions that support and facilitate MD recorder operations during on-the-air broadcasting.

7-1 Using the Menu Functions	7-2
7-2 Setting the Timing of the EOM Indication	7-3
7-3 Pausing Before Playback (AUTO PAUSE and AUTO CUE Functions)	7-4
7-4 Recording a Track Number Automatically (LevelSync Setting)	7-6
7-5 Reading the Hours Meter	7-8

7-2 Setting the Timing of the EOM Indication

The EOM indication can be set to flash between 1 and 35 seconds before the end of a track to indicate that the end is approaching. Use the procedure below to set the timing.

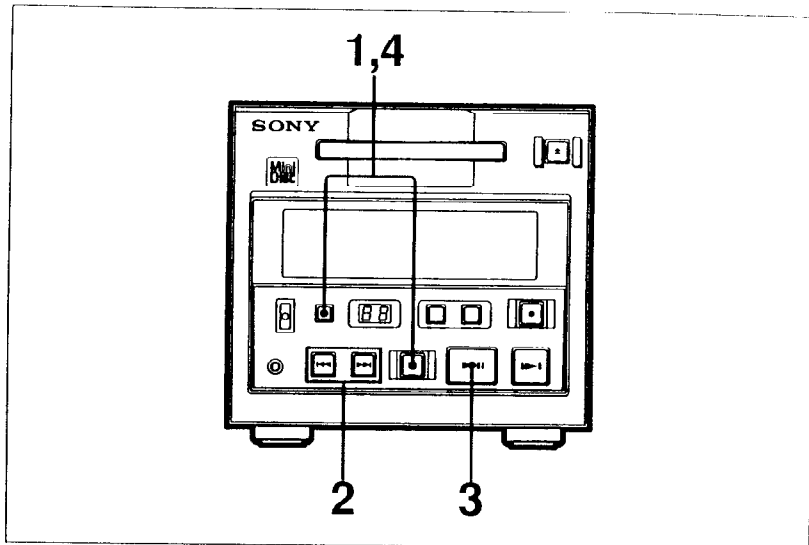

Setting the timing of the end-of-message (EOM) indication

- 1** Press the STOP and DISPLAY keys simultaneously. The EOM (end-of-message) function goes on.

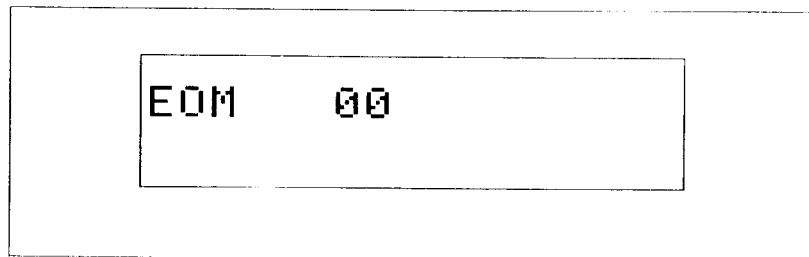

- 2** Press the NEXT or PREVIOUS key to select the timing.
- 3** Press the PLAY/PAUSE key to enter the EOM timing.
- 4** To continue with another menu function, press the DISPLAY key until the function appears. To cancel the menu, press the STOP key.

7-3 Pausing Before Playback (AUTO PAUSE and AUTO CUE Functions)

AUTO PAUSE function

When AUTO PAUSE is on, the MD recorder changes to playback pause at the start of the specified track, then starts playing the track when you press the PLAY/PAUSE key.

The AUTO PAUSE function is useful for pre-cueing tracks on multiple MD recorders during on-the-air broadcasting.

AUTO CUE function

When AUTO CUE is on, the MD recorder changes to playback pause just as the audio level rises (above -58 dB) at the start of a track. You can then play the track by pressing the PLAY/PAUSE key.

This function is useful for cueing to and delivering special sound effects during plays and other productions.

Activating the AUTO PAUSE/AUTO CUE functions

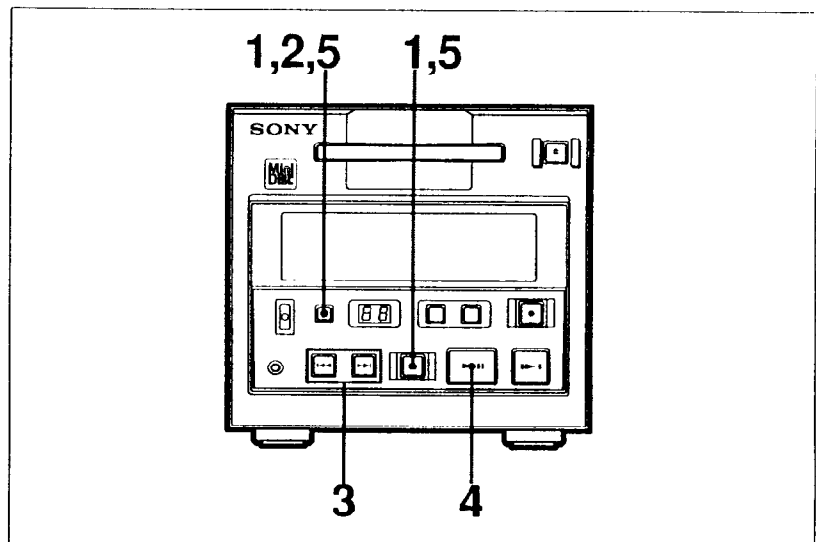

Activating the AUTO PAUSE/AUTO CUE functions

- 1 Press the STOP and DISPLAY keys simultaneously. A menu function appears.
- 2 Press the DISPLAY key until "AP AC OFF" appears.

AP AC OFF

- 3** Press the NEXT or PREVIOUS key to select the setting.
AP AC OFF: AUTO PAUSE and AUTO CUE are off.
A. PAUSE ON: AUTO PAUSE is on.
A. CUE ON: AUTO CUE is on.

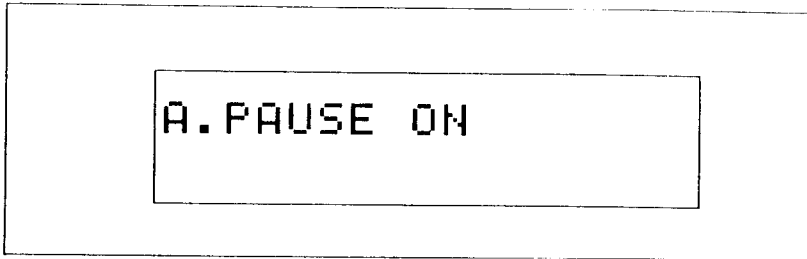

- 4** Press the PLAY/PAUSE key to enter the selected setting.
- 5** To continue with another menu function, press the DISPLAY key until the function appears.
To cancel the menu, press the STOP key.

7-4 Recording a Track Number Automatically (LevelSync Setting)

LevelSync setting is essentially the adding of track numbers at specified points while you record. This allows you to quickly locate those points later either by directly specifying the track number or by using the AMS function.

When track numbers are added automatically, the MD recorder system records track numbers whenever it detects a silent portion (i.e., the space between tracks). Manually you record track numbers by pressing the REC key during recording.

To add new track numbers to a track that has already been recorded, you must use the divide function to divide the track. See "6-3 Dividing a Recorded Track (Divide Function)" on page 6-5.

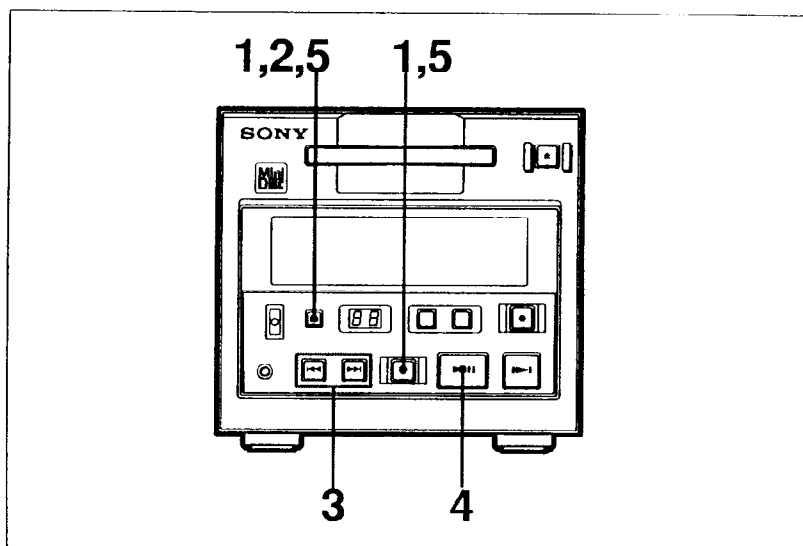

LevelSync setting function

- 1** Press the STOP and DISPLAY keys simultaneously. A menu function appears.
- 2** Press the DISPLAY key until "LevelSyncOFF" appears.

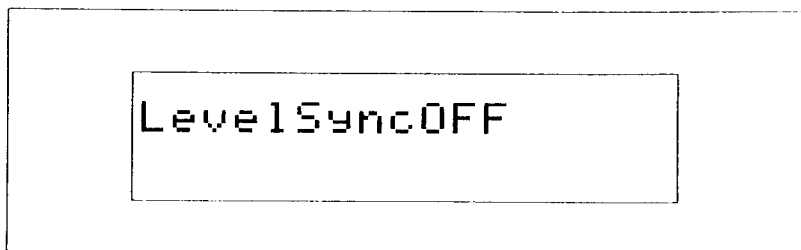

-
- 3** Press the NEXT or PREVIOUS key to select the setting.
 - ON:** Track marks are automatically recorded by the MD recorder system when it detects a sudden rise in audio level after a silent portion (i.e., a signal level of less than -58 dB that continues for 1.6 seconds, then jumps to -58 dB or more). The rise is taken to be the start of a new track.
 - OFF:** A track mark is recorded when you press the REC key during MD recording.
 - 4** Press the PLAY/PAUSE key to enter the levelsync setting.
 - 5** To continue with another menu function, press the DISPLAY key until the function appears.
To cancel the menu, press the STOP key.

Track numbers are not recorded correctly

Incorrect assignment or recording of track numbers may result when certain CDs are recorded with the "LevelSync ON" indication on.

7-5 Reading the Hours Meter

This function allows you to display the accumulated operating time of the laser diode (during recording operations) and of the spindle motor. Use this information as the basis for replacing the BU block.

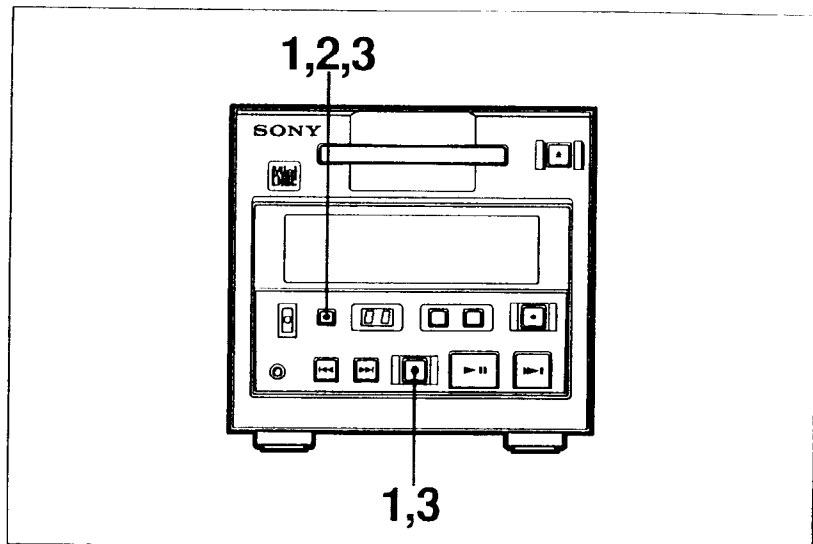

Reading the hours meter

- 1 Press the STOP and DISPLAY keys simultaneously. A menu function appears.
- 2 Press the DISPLAY key until the hours meter showing the accumulated operating times appears.
 - L: Accumulated laser diode operating time.
 - S: Accumulated spindle motor operating time.

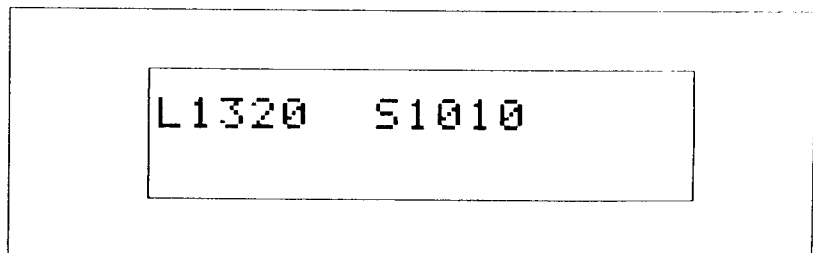

- 3 To continue with another menu function, press the DISPLAY key until the function appears. To cancel the menu, press the STOP key.

Note

When the BU block is replaced, a new EEP-ROM is installed and the hours meter is zeroed. Since this resets the other menu functions as well, you must make the applicable settings again.

Chapter 8 Maintenance

This chapter explains the cleaning of MD recorders and the meaning of display messages.

8-1	Cleaning the MD Recorder	8-2
8-2	Display Messages	8-2

8-1 Cleaning the MD Recorder

Use a soft cloth slightly moistened with a mild detergent solution to clean the cabinet and panel surface. Do not use solvents that may damage the surface such as paint thinner, benzine, or alcohol.

8-2 Display Messages

The following table explains the various messages that appear in the display window.

Message	Meaning
Blank Disc	A new (blank) or erased disc has been inserted.
Cannot EDIT	An attempt was made to edit the MD during program play, or the inserted disc contains Japanese ideograms.
Disc Error	The disc is abnormal (scratched or missing a TOC).
Disc Full	The disc is full.
Impossible	An attempt was made to combine tracks while playing back the first track.
Name Full	The titling capacity of the disc has reached its limit (about 1,792 characters).
No Disc	There is no disc in the unit.
No Track	The inserted disc has a disc title but no tracks.
Protected	The inserted disc is record-protected.
Retry	The first recording attempt failed due to a disturbance or scratch on the disc, and a second recording is being made.
Sorry	An attempt was made to combine tracks that cannot be combined.
TOC Reform?	The TOC has become almost full due to repeated editing operations. Press the ENTER/YES key to reform the TOC for a possible increase in recording time. Press the EDIT/NO key to bypass the reform process and turn off the message.

Appendix

Specifications	A-2
What is the MiniDisc?	A-4

Specifications

General

Power requirements	AC 120 V, 60 Hz (For the U.S.A. and Canada) AC 230 V to 240 V, 50/60 Hz (For Europe)
Power consumption	25 W
Operating temperature	5°C to 40°C (41°F to 104°F)
Storage temperature	-20°C to +55°C (-4°F to 131°F), without moisture condensation
Dimensions (w/h/d)	About 142 × 132 × 375 mm (5 ⁵ / ₈ × 5 ¹ / ₄ × 14 ⁷ / ₈ inches)
Weight	About 5 kg (11 lb)

Laser characteristics

Laser:	Semiconductor laser
Wavelength:	780 - 790nm
Laser diode properties	Material: GaAlAs Emission duration: continuous Laser output: less than 44.6 μW (This output is the value measured at a distance of 200 mm from the lens surface on the optical pick-up block.)

Digital audio signal format

System	MiniDisc digital audio system
Disc	MiniDisc
Modulation format	EFM (Eight-to-Fourteen Modulation)
Digital audio channel	2 channels
Sampling frequency	44.1 kHz
Error correction	ACIRC (Advanced Cross Interleave Reed Solomon Code)
Rotation mode	CLV (about 400 to 900 r.p.m.)

Input/output connectors

Analog input	
Connector	XLR-3-31
Reference level	+4 dB (factory set)
Adjustable range	-12 dB to +8 dBs
Maximum level	+24 dB
Input impedance	Approx. 10 kilohms, balanced

Analog output	
Connector	XLR-3-32
Reference level	+4 dB (load impedance 10 kilohms) (factory setting)
Adjustable range	-12 dB to +8 dBs (load impedance 10 kilohm) (factory setting)
Maximum level	+24 dB (load impedance 10 kilohms) (factory setting)
Output impedance	Approx. 250 ohms, balanced
Load impedance	More than 600 ohms
REMOTE (25P)	
Connector	D-SUB 25-pins (female)
Format	Parallel
Input level	L: ground short (less than 100 ohms) H: open collector (high impedance)
Output level	L: less than 0.8 V (Imax.: 25 mA) H: open collector (Vmax.: 12 V)
+5 V output	Imax. 50 mA

Audio characteristics

Frequency response	20 Hz to 20 kHz, ± 0.5 dB
Signal-to-noise ratio	More than 83 dB (with A-weight filter, when playing back recordable disc) More than 95 dB (with A-weight filter, when playing back premastered disc)
Total harmonic distortion	Less than 0.095% (at reference level ¹⁾ , 1 kHz, when playing back recordable disc) Less than 0.06% (at reference level ¹⁾ , 1 kHz, when playing back premastered disc)
Wow and flutter	Below measurable limit ($\pm 0.001\%$, W. Peak)

Supplied accessories

Wired remote controller RM-C1 (1)
Connecting cable (1)
Sony SUM-3 (NS) batteries (3)
AC power cord (1)
Operation manual (1)

US and foreign patents licensed from Dolby Laboratories Licensing Corporation.

Design and specifications are subject to change without notice.

¹⁾ The reference level is the level at -20 dB from the full bit on the peak level meter scale.

What is the MiniDisc?

How MiniDiscs Work

MiniDiscs (MD) come in two types: premastered (prerecorded) and recordable (blank). Premastered MDs, recorded at music studios, can be played back almost endlessly. However, they can't be recorded on or over like cassette tapes. To record, you use a "recordable MD".

Premastered MDs

Premastered MDs are recorded and played like regular CDs. A laser beam focuses on the pits in the surface of the MD and reflects the data back to the lens in the recorder. The recorder then decodes the signals and plays them back as music.

Recordable MDs

Recordable MDs, which use magneto-optical (MO) technology, can be recorded again and again. The laser inside the recorder applies heat to the MD, demagnetizing the magnetic layer of the MD. (See illustration below.) The recorder then applies a magnetic field to the layer. This magnetic field corresponds exactly to the audio signals generated by the connected source. (The north and south polarities equate to digital "1" and "0".) The demagnetized MD adopts the polarity of the magnetic field, resulting in a recorded MD.

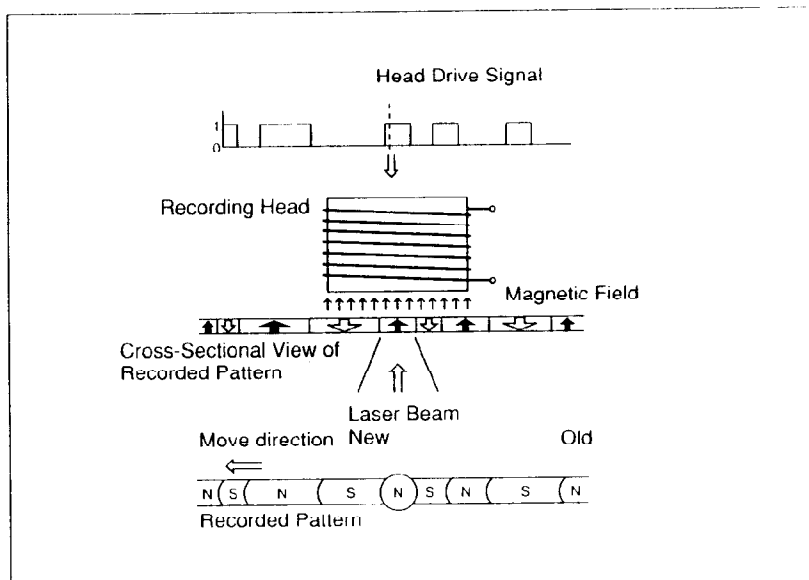

Recording Mechanism

How the MiniDisc Got So Small

The 2.5-inch MiniDisc, encased in a plastic cartridge that looks like a 3.5-inch diskette (see illustration below), uses a new digital audio compression technology called ATRAC (Adaptive Transform Acoustic Coding). To store more sound in less space, ATRAC extracts and encodes only those frequency components actually audible to the human ear.

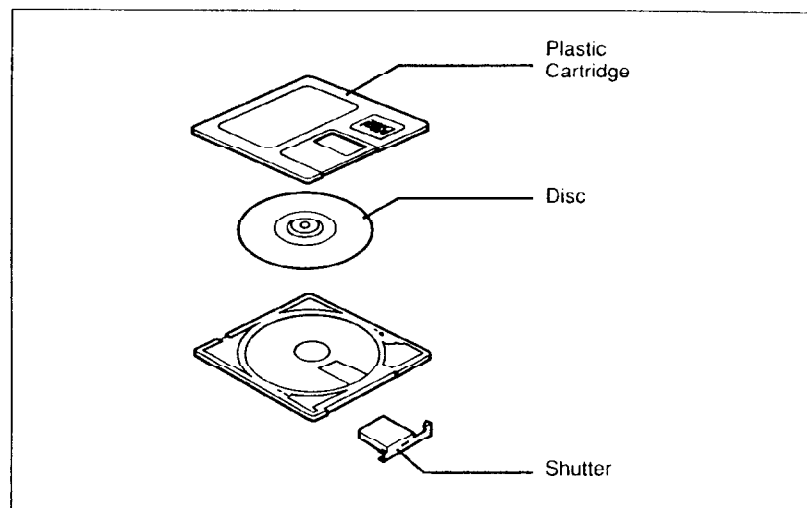

Parts Making Up a MiniDisc

How Quick Random Access and the TOC Systems Work

Like CDs, MDs offer instantaneous random access to the beginning of any music track. Premastered MDs are recorded with location addresses corresponding to each music selection. Recordable MDs are manufactured with a "User TOC¹⁾ Area" to contain the order of the music. The TOC system is similar to the "directory management system" of floppy disks. In other words, starting and ending addresses for all music tracks recorded on the disc are stored in this area. This lets you randomly access the beginning of any track as soon as you enter the track number (AMS), as well as label the location with a track name as you would a file on a diskette.

¹⁾ TOC is the acronym for Table of Contents.

What is the MiniDisc?

How the Shock-Resistant Memory Works

One major drawback of optical read systems is that they can skip or mute when subjected to vibration. The MD system resolves this problem by using a buffer memory that stores up to 10 seconds of audio data. This is possible because of a 1 second lag between the time audio data is picked up and when it is decoded (see illustration below). Should the optical pickup be jarred out of position, the correct audio data plays from the buffer memory. Using a concept called "sector repositioning," the optical pickup has the ability to within 13 milliseconds identify the disruption and resume reading from the correct point. As long as the optical pickup returns to the correct position within about 10 seconds, you never experience mistracking or muting.

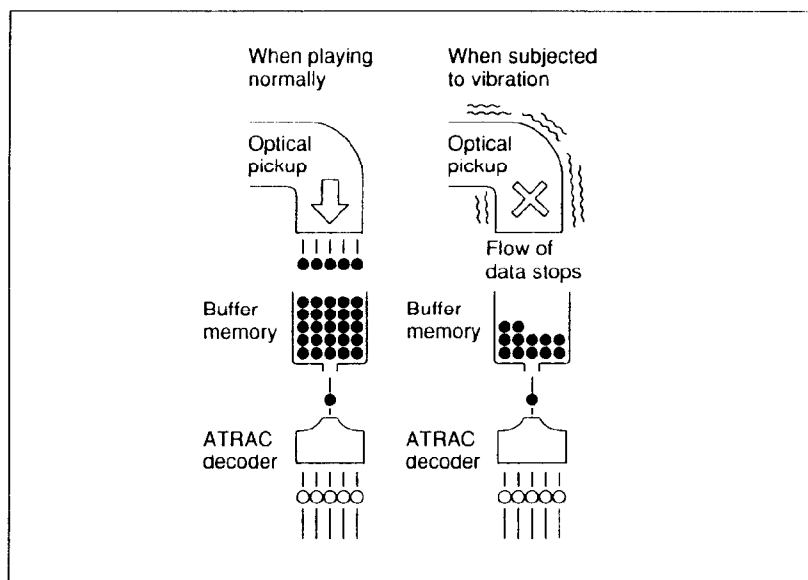

Shock-Resistant Memory System

Index

A

AMS (Automatic Music Sensor) 5-8
ANALOG IN connectors 2-5
Analog input/output signal
 ANALOG IN/OUT connectors 2-5
 Select monaural/stereo mode (MODE switch) 2-5
 Setting the analog input/output reference level 3-5
ANALOG OUT connectors 2-5
AUTO CUE function 7-4
Auto display function 5-10
AUTO PAUSE function 7-4

C

CAPS (capital letters) key 2-7
CLEAR key 2-7
Combine function 6-7
Connections 3-3
CUE STDBY (standby) key 2-3, 2-7

D

Display information
 Display information during playback 5-9
 Display information during recording 4-4
DISPLAY key 2-3, 2-7
Display messages 8-2
Divide function 6-5

E

EDIT key 2-3
Editing functions
 Combine function 6-7
 Divide function 6-5
 Erase function 6-3
 Move function 6-9
EDIT/NO key 2-7
EJECT key 2-3
End-of-message (EOM) indication 5-10, 7-3
ENTER key 2-3
ENTER/YES key 2-7
Erase function 6-3

H

Hours meter 7-8

L

LevelSync setting 7-6
Locating
 Locating a specific track 5-7
 Locating the beginning of a track (AMS) 5-8

M

Menu functions 7-2
MiniDisc (MD)
 Handling MiniDiscs 3-4
 Preventing accidental erasure 4-3
 What is the Minidisc? A-4
MODE switch 2-5
Move function 6-9

N

NAME key 2-7
NEXT/▶▶▶ key 2-3, 2-7
NEXT PLAY display 2-3

P

Playback
 Display information during playback 5-9
 Playing back 5-5
 Program play 5-12
 Program repeat playback 5-3
 Repeat playback functions 5-3, 5-11
PLAYBACK/RECORD level controls 2-5, 3-5
PLAY/PAUSE key 2-3, 2-7
PREVIOUS/◀◀◀ key 2-3, 2-7
PROGRAM key 2-7

Index

R

- REC (recording) key 2-3, 2-7
- Recording
 - Adding disc and track titles 4-5
 - Display information during recording 4-4
 - Recording procedure 4-2
- REMOTE connector 2-5
- Remote controller 2-6
- REPEAT1/OFF/REPEAT ALL switch 2-3, 5-11

S

- Scan forward/backward 5-6
- Search 5-6
- STOP key 2-3, 2-7

T

- Titles
 - Adding a disc title 4-5
 - Adding a track title 4-6
 - Dividing a track title into separate parts 4-7

Free Manuals Download Website

<http://myh66.com>

<http://usermanuals.us>

<http://www.somanuals.com>

<http://www.4manuals.cc>

<http://www.manual-lib.com>

<http://www.404manual.com>

<http://www.luxmanual.com>

<http://aubethermostatmanual.com>

Golf course search by state

<http://golfingnear.com>

Email search by domain

<http://emailbydomain.com>

Auto manuals search

<http://auto.somanuals.com>

TV manuals search

<http://tv.somanuals.com>