

SONY®

***VAIO® Computer
Quick Start***

PCG-GRT100 Series

<i>Notice to Users</i>	5
<i>Setting Up</i>	15
Unpacking Your Computer	16
Applying Ergonomics	18
Locating Controls and Ports	19
<i>Getting Started</i>	25
Turning On Your Computer	26
Using the Touch Pad	31
Registering Your Computer	32
Locating Your VAIO Computer User Guide	33
Setting Up A Dial-Up Connection	36
Turning Off Your Computer	38
<i>Expanding Your Computing Power</i>	39
Upgrading Memory	40
Locating Preinstalled Programs	40
<i>Caring for Your Computer</i>	41
Storing Your Computer	42
Using Cables and Connections.....	42
Cleaning Your Computer	43
Handling the LCD Screen	43
<i>VAIO Recovery Options</i>	45
About Recovery Options	46

About the Recovery Media Kit 48
Using the VAIO Recovery Wizard 52

Using the Application Recovery and System Recovery CDs 61

Application and System Recovery CDs..... 62
Using Your Recovery CDs 62

Troubleshooting 69

Computer 69
Support Options 74

Index 75

Notice to Users

© 2003 Sony Electronics Inc. All rights reserved. This manual and the software described herein, in whole or in part, may not be reproduced, translated, or reduced to any machine-readable form without prior written approval.

SONY ELECTRONICS INC. PROVIDES NO WARRANTY WITH REGARD TO THIS MANUAL, THE SOFTWARE, OR OTHER INFORMATION CONTAINED HEREIN AND HEREBY EXPRESSLY DISCLAIMS ANY IMPLIED WARRANTIES OF MERCHANTABILITY OR FITNESS FOR ANY PARTICULAR PURPOSE WITH REGARD TO THIS MANUAL, THE SOFTWARE, OR SUCH OTHER INFORMATION. IN NO EVENT SHALL SONY ELECTRONICS INC. BE LIABLE FOR ANY INCIDENTAL, CONSEQUENTIAL, OR SPECIAL DAMAGES, WHETHER BASED ON TORT, CONTRACT, OR OTHERWISE, ARISING OUT OF OR IN CONNECTION WITH THIS MANUAL, THE SOFTWARE, OR OTHER INFORMATION CONTAINED HEREIN OR THE USE THEREOF.

Sony Electronics Inc. reserves the right to make any modification to this manual or the information contained herein at any time without notice. The software described herein is governed by the terms of a separate user license agreement.

This product contains software owned by Sony and licensed by third parties. Use of such software is subject to the terms and conditions of license agreements enclosed with this product. Some of the software may not be

transported or used outside the United States. Software specifications are subject to change without notice and may not necessarily be identical to current retail versions.

Updates and additions to software may require an additional charge. Subscriptions to online service providers may require a fee and credit card information. Financial services may require prior arrangements with participating financial institutions.



As an ENERGY STAR® Partner, Sony Corporation has determined that this product meets the ENERGY STAR® guidelines for energy efficiency.

The International ENERGY STAR® Office Equipment Program is an international program that promotes energy saving through the use of computers and other office equipment. The program backs the development and dissemination of products with functions that effectively reduce energy consumption. It is an open system in which business proprietors can participate voluntarily. The targeted products are office equipment such as computers, displays, printers, facsimiles and copiers. Their standards and logos are uniform among participating nations. ENERGY STAR is a U.S. registered mark.



The Wireless LAN functionality*, which is incorporated into selected models only, has passed Wi-Fi certification and complies with the interoperability specifications established by WECA (Wireless Ethernet Compatibility Alliance).

* Selected models may come with a PC Card.

Sony, DVgate Plus, Handycam, i.LINK, Mavica, MagicGate™ Memory Stick, Memory Stick, VAIO, and the VAIO logo are trademarks of Sony Corporation. Microsoft, Windows Media, Windows, Windows NT, and the Windows logo are registered trademarks of Microsoft Corporation. Intel, SpeedStep, and Pentium are trademarks or registered trademarks of Intel Corporation. PS/2 is a registered trademark of IBM. Acrobat Reader, Photoshop, Photoshop Elements, and Premiere are trademarks of Adobe Systems Incorporated. PowerPanel is a trademark of Phoenix Technologies Ltd.

This product incorporates copyright protection technology that is protected by U.S. patents and other intellectual property rights owned by Macrovision Corporation. Use of this copyright protection technology must be authorized by Macrovision, and is intended for home and other limited viewing uses only unless otherwise authorized by Macrovision. Reverse engineering or disassembly is prohibited.

i.LINK is a trademark of Sony used only to designate that a product contains an IEEE 1394 connection. The i.LINK connection may vary, depending on the software applications, operating system, and compatible i.LINK devices. All products with an i.LINK connection may not communicate with each other. Please refer to the documentation that came with your compatible i.LINK device for information on operating conditions and proper connection. Before connecting compatible i.LINK PC peripherals to your system, confirm their operating system compatibility and required operating conditions. All other trademarks are trademarks of their respective owners.

End User / Product Activation Requirements

Certain software product(s) included with this computer may include features such as copy protection and content management technology. Use of the software product(s) requires agreement to applicable end user agreements and full compliance with applicable product activation procedures. Product activation procedures and privacy policies will be detailed during initial launch of the software product(s), or upon certain reinstallations of the software product(s) or reconfiguration of the computer, and may be completed by Internet or telephone (toll charges may apply).

Owner's Record

The model number and serial number are located on the bottom of your Sony VAIO® computer. Record the model and serial numbers in the space provided here, and keep in a secure location. Refer to the model and serial numbers when you call your Sony Service Center.

Model Number: _____

Serial Number: _____

Safety Information

WARNING

- To prevent fire or shock hazard, do not expose your computer to rain or moisture.
- To avoid electrical shock, do not open the cabinet. Refer servicing to qualified personnel only.
- Never install modem or telephone wiring during a lightning storm.
- Never install telephone jacks in wet locations unless the jack is specifically designed for wet locations.
- Never touch uninsulated telephone wire or terminals unless the telephone line has been disconnected at the network interface.
- Use caution when installing or modifying telephone lines.
- Avoid using the modem during an electrical storm.
- Do not use the modem or a telephone to report a gas leak in the vicinity of the leak.
- A socket outlet should be as close as possible to the unit and easily accessible.
- i.LINK, PC Card, and USB connectors are not supplied with Limited Power Sources.



To change the backup battery, please contact your nearest Sony Service Center.

Caution: The use of optical instruments with this product will increase eye hazard. As the laser beam used in this product is harmful to the eyes, do not attempt to disassemble the cabinet. Refer servicing to qualified personnel only.

(For optical drive) Danger: Visible and invisible laser radiation when open. Avoid direct exposure to beam.

Caution: To reduce the risk of fire, use only No. 26 AWG or larger telecommunication line cord.

AVERTISSEMENT

- Pour prévenir tout risque d'incendie ou d'électrocution, garder cet appareil à l'abri de la pluie et de l'humidité.
- Pour prévenir tout risque d'électrocution, ne pas ouvrir le châssis de cet appareil et ne confier son entretien qu'à une personne qualifiée.
- Ne jamais effectuer l'installation de fil modem ou téléphone durant un orage électrique.
- Ne jamais effectuer l'installation d'une prise téléphonique dans un endroit mouillé à moins que la prise soit conçue à cet effet.
- Ne jamais toucher un fil téléphonique à découvert ou un terminal à moins que la ligne téléphonique n'ait été débranchée de l'interface réseau.

- ❑ Soyez très prudent lorsque vous installez ou modifiez les lignes téléphoniques.
- ❑ Évitez d'utiliser le modem durant un orage électrique.
- ❑ N'utilisez pas le modem ni le téléphone pour prévenir d'une fuite de gaz quand vous êtes près de la fuite.
- ❑ L'appareil doit être le plus près possible d'une prise murale pour en faciliter l'accès.
- ❑ Des connecteurs i.LINK, PC Card, et USB ne sont pas fournis avec des Sources d'Énergie Limitées.



Pour changer la pile de recharge, veuillez contacter votre centre de service Sony le plus près.

Avertissement: L'utilisation d'instruments optiques avec ce produit augmente les risques pour les yeux. Puisque le faisceau laser utilisé dans ce produit est dommageable pour les yeux, ne tentez pas de désassembler le boîtier. Adressez-vous à un agent de service qualifié.

(Pour le lecteur optique) Danger: Radiation laser visible et invisible si ouvert. Évitez l'exposition directe au faisceau.

Attention : Afin de réduire les risques d'incendie, n'utilisez qu'un cordon de communication NO. 26 AWG ou plus gros.

If you have questions about this product, you can write to the Sony Customer Information Service Center at 12451 Gateway Blvd., Ft. Myers, FL 33913 or find Sony Customer Service on the Web at:
<http://www.sony.com/pcsupport>.

Regulatory Information

Declaration of Conformity

Trade Name:	Sony
Model No.:	PCG-8M2L, PCG-8M3L, PCG-8M1R, PCG-8M2R
Responsible Party:	Sony Electronics Inc.
Address:	680 Kinderkamack Road Oradell, NJ 07649
Telephone:	201-930-6972 (For FCC-related matters only.)

This device complies with Part 15 of the FCC rules. Operation is subject to the following two conditions:

- (1) This device may not cause harmful interference, and
- (2) this device must accept any interference received, including interference that may cause undesired operation.

This equipment has been tested and found to comply with the limits for a Class B digital device, pursuant to Part 15 of the FCC Rules. These limits are designed to provide reasonable protection against harmful interference in a residential installation. This equipment generates, uses, and can radiate radio frequency energy and, if not installed and used in accordance with the instructions, may cause harmful interference to radio communications. However, there is no guarantee that interference will not occur in a particular installation. If this

equipment does cause harmful interference to radio or television reception, which can be

determined by turning the equipment off and on, the user is encouraged to try to correct the interference by one or more of the following measures:

- Reorient or relocate the receiving antenna.
- Increase the separation between the equipment and the receiver.
- Connect the equipment to an outlet on a circuit different from that to which the receiver is connected.
- Consult the dealer or an experienced radio/TV technician for help.

You are cautioned that any changes or modifications to the computer not expressly approved in this manual could void your authority to operate this equipment.

Only peripherals (computer input/output devices, terminals, printers, etc.) that comply with FCC Class B limits may be attached to this computer product. Operation with non-compliant peripherals is likely to result in interference to radio and television reception.

All cables used to connect peripherals must be shielded and grounded. Operation with cables connected to peripherals that are not shielded and grounded may result in interference to radio and television reception.

FCC Part 68

This equipment complies with Part 68 of the FCC rules and the requirements adopted by the ACTA. On the bottom of this equipment is a label that contains, among other information, a product identifier in the format US:AAAEQ##TXXXX. If requested, this information must be provided to the telephone company.

This modem uses the USOC RJ11C telephone jack.

A telephone plug and jack used to connect this equipment to the premises wiring and telephone network must comply with the applicable FCC Part 68 rules and requirements adopted by the ACTA.

The REN is used to determine the number of devices which may be connected to the telephone line. Excessive RENs on a telephone line may result in the devices not ringing in response to an incoming call. In most, but not all areas, the sum of RENs should not exceed five (5.0). To be certain of the number of devices that may be connected to a line, as determined by the total RENs, contact the telephone company. For products approved after July 23, 2001, the REN for this product is part of the product identifier that has the format US:AAAEQ##TXXXX. The digits represented by ## are the REN without a decimal point (e.g., 03 is a REN of 0.3). For earlier products, the REN is separately shown on the label.

If this equipment causes harm to the telephone network, the telephone company will notify you in advance that temporary discontinuance of service may be required. But if advance notice is not practical, the telephone company will notify the customer as soon as possible. Also, you will be advised of your right to file a complaint with the FCC if you believe it is necessary.

The telephone company may make changes in its facilities, equipment, operations, or procedures that could affect the operation of the equipment. If this happens, the telephone company will provide advance notice in order for you to make the necessary modifications in order to maintain uninterrupted service.

If trouble is experienced with this equipment, for repair or warranty information, please contact 1-888-4-SONY-PC (1-888-476-6972), or write to the Sony Customer Information Service Center, One Sony Drive, Park Ridge,

NJ 07656. If the equipment is causing harm to the telephone network, the telephone company may request that you disconnect the equipment until the problem is resolved.

Repair of this equipment should be made only by a Sony Service Center or Sony authorized agent. For a Sony Service Center near you, call 1-888-4-SONY-PC (1-888-476-6972).

Connection to party line service is subject to state tariffs. Contact the state public utility commission, public service commission, or corporation commission for information.

If your home has specially wired alarm equipment connected to the telephone line, ensure the installation of this equipment does not disable your alarm equipment. If you have questions about what will disable alarm equipment, consult your telephone company or a qualified installer.

Use a surge arrestor to protect against electrical surges.

FCC Radio Frequency Exposure (United States)

(Applies to wireless LAN models only) This equipment complies with FCC radiation exposure limits set forth for an uncontrolled environment. This equipment should be installed and operated with minimum distance of 8 inches (20 cm) between the radiator and body (excluding extremities: hands, wrists, and feet).

This device and its antenna(s) must not be co-located or operating with any other antenna or transmitter. Users are not permitted to modify this transmitter device. Any unauthorized change made to this device could void your authority to operate this device.

IC RSS-210 (Canada)

(Applies to wireless LAN models only)
Operation is subject to the following two conditions: (1) this device may not cause interference, and (2) this device must accept any interference, including interference that may cause undesired operation of the device.

To prevent radio interference to the licensed service, this device is intended to be operated indoors and away from windows to provide maximum shielding. Equipment (or its transmit antenna) that is installed outdoors is subject to licensing.

The term "IC:" before the certification / registration number only signifies that the Industry Canada technical specifications were met.

(S'applique aux modèles sans fil de LAN seulement) L'utilisation de ce dispositif est autorisée seulement aux conditions suivantes: (1) il ne doit pas produire de brouillage et (2) l'utilisateur du dispositif doit être prêt à accepter tout brouillage radioélectrique reçu, même si ce brouillage est susceptible de compromettre le fonctionnement du dispositif.

Pour empêcher que cet appareil cause du brouillage au service faisant l'objet d'une licence, il doit être utilisé à l'intérieur et devrait être placé loin des fenêtres afin de fournir un écran de blindage maximal. Si le matériel (ou son antenne d'émission) est installé à l'extérieur, il doit faire l'objet d'une licence.

L'expression "IC:" avant le numéro d'homologation / enregistrement signifie seulement que les spécifications techniques d'Industrie Canada ont été respectées.

Telephone Consumer Protection Act of 1991 (United States)

The Telephone Consumer Protection Act of 1991 makes it unlawful for any person to use a computer or other electronic device, including FAX machines, to send any message unless such message clearly contains in a margin at the top or bottom of each transmitted page or on the first page of the transmission, the date and time it is sent and an identification of the business or other entity, or other individual sending the message, and the telephone number of the sending machine or such business, other entity, or individual. (The telephone number provided may not be a 900 number or any other number

for which charges exceed local or long-distance transmission charges.)

In order to program this information into your facsimile machine, see your fax software documentation.

Telephone Consumer Guidelines (Canada)

Please refer to your telephone directory under 'Privacy Issues' and/or 'Terms of Service.' For more detailed information, please contact:

CRTC
Terrasses de la Chaudière, Tour centrale
1 promenade du Portage, 5 étage Hull
PQ K1A 0N2.

This Class B digital apparatus complies with Canadian ICES-003.

Cet appareil numérique de la classe B est conforme à la norme NMB-003 du Canada.

RECYCLING LITHIUM ION BATTERIES

RECYCLING
LITHIUM-ION
BATTERIES

Lithium-Ion
batteries are
recyclable.

You can help
preserve our
environment by
returning your used
rechargeable
batteries to the
collection and
recycling location
nearest you.

For more information regarding recycling of
rechargeable batteries, call toll free 1-800-
822-8837, or visit <http://www.rbrc.org/>.

Caution: Do not handle damaged or leaking
Lithium-Ion batteries.



RECYCLAGE DES ACCUMULATEURS AUX IONS DE LITHIUM

RECYCLAGE DES
ACCUMULATEURS
AUX IONS DE
LITHIUM

Les accumulateurs
aux ions de lithium
sont recyclables.

Vous pouvez
contribuer à
préserver
l'environnement en
rapportant les piles
usées dans un point
de collection et
recyclage le plus
proche.

Pour plus d'informations sur le recyclage
des accumulateurs, téléphonez le numéro
gratuit 1-800-822-8837 (Etats-Unis et
Canada uniquement), ou visitez
<http://www.rbrc.org/>.

Avertissement: Ne pas utiliser des
accumulateurs aux ions de lithium qui sont
endommagés ou qui fuient.



Do not handle damaged or leaking
lithium ion batteries.

Danger of explosion if battery is
incorrectly replaced. Replace
only with the same or equivalent
type recommended by the
manufacturer. Discard used
batteries according to the
manufacturer's instructions.

The battery pack used in this
device may present a fire or
chemical burn hazard if
mistreated. Do not disassemble,
heat above 140°F (60°C) or
incinerate. Dispose of used
battery promptly. Keep away from
children.

Ne pas utiliser des batteries au
lithium ionisé qui sont
endommagées ou qui fuient.

Une batterie non conforme
présente un danger d'explosion.
La remplacer seulement par une
batterie identique ou de type
équivalent recommandé par le
fabricant. Évacuer les batteries
usées selon les directives du
fabricant.

La manutention incorrecte du
module de batterie de cet
appareil présente un risque
d'incendie ou de brûlures
chimiques. Ne pas démonter,
incinérer ou exposer à une
température de plus de 60°C.
Évacuer promptement la batterie
usée. Garder hors de portée des
enfants.

INDUSTRY CANADA NOTICE

NOTICE: This equipment meets the applicable Industry Canada Terminal Equipment Technical Specifications.

The Ringer Equivalence Number (REN) for this terminal equipment is 0.2. The REN assigned to each terminal equipment provides an indication of the maximum number of terminals allowed to be connected to a telephone interface. The termination on an interface may consist of any combination of devices subject only to the requirement that the sum of the Ringer Equivalence Numbers of all the devices does not exceed five.

AVIS D'INDUSTRIE CANADA

REMARQUE: Cet équipement est conforme aux Spécifications Techniques des Équipements Terminaux d'Industrie Canada en vigueur.

Le Nombre Équivalent de Sonneries (REN) de cet équipement terminal est 0,2. Le REN attribué à chaque équipement terminal indique le nombre maximum de terminaux que l'on peut connecter à une interface téléphonique. Il est possible de raccorder à une interface plusieurs combinaisons d'appareils, mais la somme des Nombres Équivalents de Sonneries de tous ces appareils ne doit pas dépasser cinq.

Setting Up

Congratulations on your purchase of the Sony VAIO® computer. Sony has combined leading-edge technology in audio, video, computing, and communications to provide state-of-the-art personal computing.

Unpacking Your Computer

Carton Contents

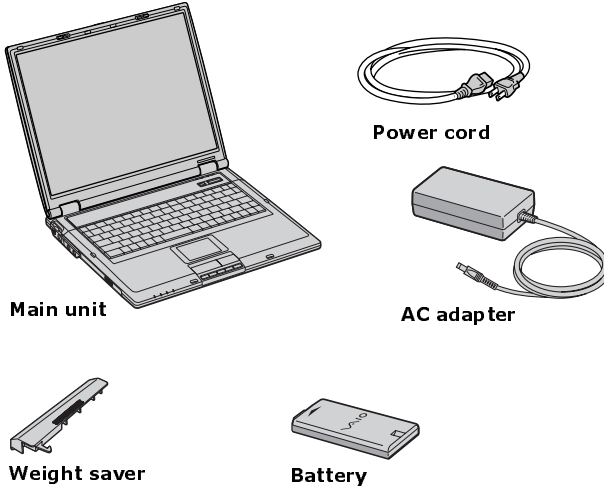

These hardware components are included.

VAIO Computer Documents

- ❑ **VAIO® Computer User Guide** — A searchable on-screen help file that contains detailed information on how to use your new computer. See “Locating Your VAIO Computer User Guide” on page 33 for more information.
- ❑ **VAIO® Computer Quick Start** — Contains information on unpacking and setting up your computer for immediate use.
- ❑ **VAIO® Computer Specifications (Windows® XP)** — An on-screen file that details the hardware specifications and lists the installed programs on your computer. See “Locating Your VAIO Computer User Guide” on page 33 for more information.
- ❑ **VAIO® Computer Specifications (Windows® 2000)** — A printed sheet that details your computer's hardware specifications.

Software CDs

Depending on the model you purchased, additional program CDs may be included with your computer.

Recovery CDs

Only computers equipped with the Microsoft® Windows® 2000 Professional operating system come with Recovery CDs. Computers with the Microsoft® Windows® XP operating system feature a Hard Disk Drive recovery process that eliminates the need for Recovery CDs.

 For more information on Hard Disk Drive recovery for models with Windows® XP, see “VAIO Recovery Options” on page 39.

- ❑ **Application Recovery CDs** — Enables you to reinstall individual programs and device drivers.
- ❑ **System Recovery CDs** — Enables you to restore the operating system and programs that shipped with your computer. This CD restores your computer to its original factory settings, so user data and programs installed since you started using your computer will be lost.

Applying Ergonomics

Your computer is a portable device and can be used in a variety of environments. Whenever possible, you should apply the following ergonomic considerations:

- ❑ **Position of your computer** — Place the computer directly in front of you as you work. Keep your forearms horizontal, with your wrists in a neutral, comfortable position while using the keyboard, touch pad, or external mouse. Let your upper arms hang naturally at your sides. Take breaks during sessions with your computer. Excessive use of the computer may strain muscles or tendons.
- ❑ **Furniture and posture** — Sit in a chair with good back support and armrests. Adjust the level of the chair so your feet are flat on the floor. A footrest may make you more comfortable. Sit in a relaxed, upright posture and avoid slouching forward or leaning far backward.
- ❑ **Viewing angle of the computer's display** — Tilt the display to find the best viewing angle. Also try adjusting the brightness setting of the display. Following these suggestions can reduce eye strain and muscle fatigue.
- ❑ **Lighting** — Choose a location where windows and lights do not create glare or reflection on the display. Use indirect lighting to avoid bright spots on the display. You can purchase accessories for your display that help reduce glare. Proper lighting adds to your comfort and work effectiveness.
- ❑ **Placement of an external display** — When using an external display, set the display at a comfortable viewing distance. Make sure the display screen is at eye level or slightly lower when you are sitting in front of the monitor.

Locating Controls and Ports

Front

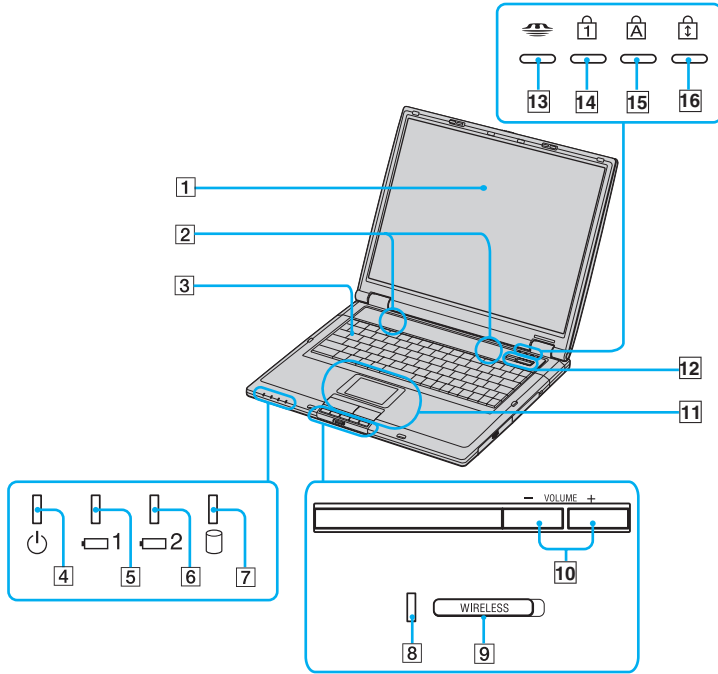

1	LCD screen	9	Wireless LAN switch*
2	Speakers	10	Volume Up/Down buttons
3	Keyboard	11	Touch pad, Left / right buttons
4	Power indicator	12	Power button, Magnify button
5	Battery indicator	13	Memory Stick® media indicator
6	Battery 2 indicator	14	Num lock indicator
7	Hard disk drive indicator	15	Caps lock indicator
8	Wireless LAN indicator*	16	Scroll lock indicator

* Wireless LAN functionality available on selected models only.

Back

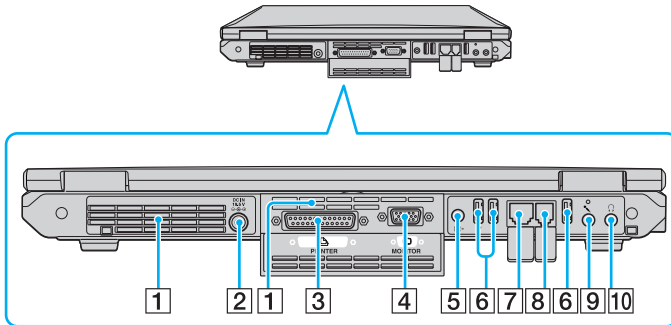

1	Air vent	6	Ⓜ USB 2.0 ports
2	Ⓜ DC IN port	7	Ⓜ Network (Ethernet) port
3	Printer port	8	Modem jack
4	□ Monitor (VGA) port	9	🎤 Microphone jack
5	Video Out port	10	🎧 Headphone jack



Only connect 10BASE-T or 100BASE-TX cables to the  Network (Ethernet) port. Do not connect any other type of network cable or any telephone line to this port. Connecting cables other than those listed above may result in an electric current overload and could cause a malfunction, excessive heat, or fire in the port. To connect the unit to a network, refer to your on-screen VAIO® Computer User Guide or contact your network administrator. See “Locating Your VAIO Computer User Guide” for more information.

Left

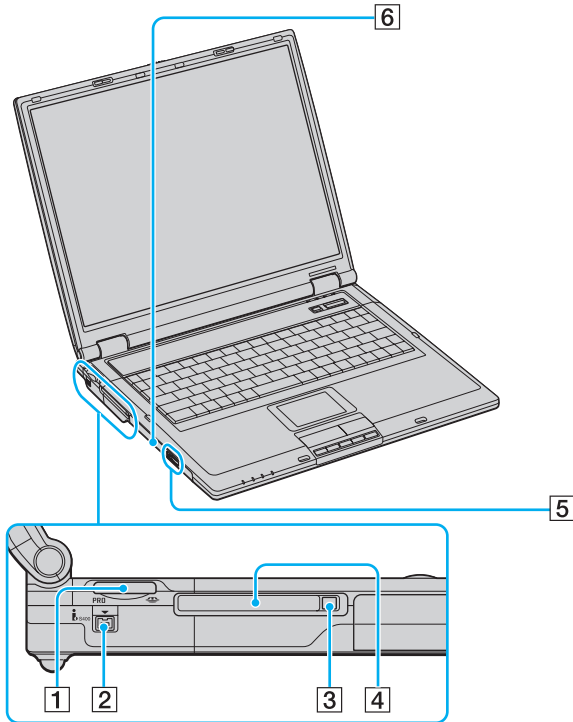

1	Memory Stick® media slot	4	PC Card slots (Two slots)
2	i.LINK® (IEEE 1394) S400 port	5	Optical drive eject button
3	PC Card eject button	6	Optical drive

Right

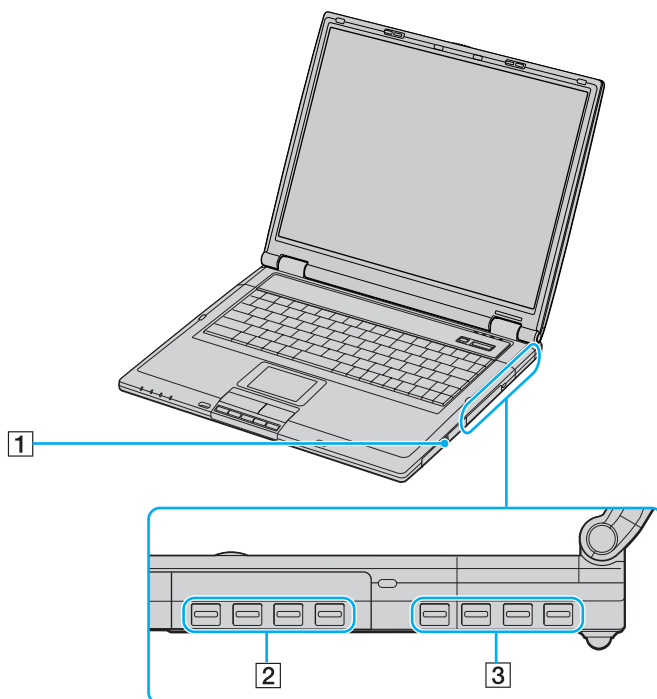

1 Battery bay

3 Air vent

2 Hard disk drive

Bottom

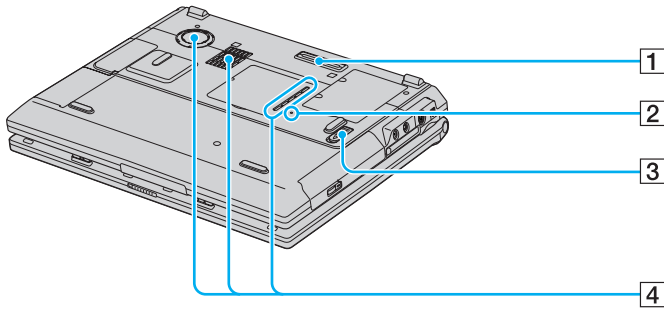

1	Port replicator connector	3	Release switch
2	Reset button	4	Air vent

Getting Started

This section helps you get your computer running and registered, so you can take advantage of Sony's many support options. You'll also learn how to locate your on-screen VAIO® Computer User Guide, which contains step-by-step instructions for operating your computer.

Turning On Your Computer

To use your computer immediately, use the supplied AC adapter as a power source. Your supplied battery is not charged when you unpack it, however, you can begin charging it when you use your AC adapter. See “Powering Your Computer” in your on-screen VAIO® Computer User Guide for more information about using batteries. See also “Locating Your VAIO Computer User Guide” on page 33.

To charge the battery

- 1 Open the computer lid.
- 2 Push the battery bay cover down to open it. The battery bay cover swings out but does not detach from the computer.

Opening the Battery Bay

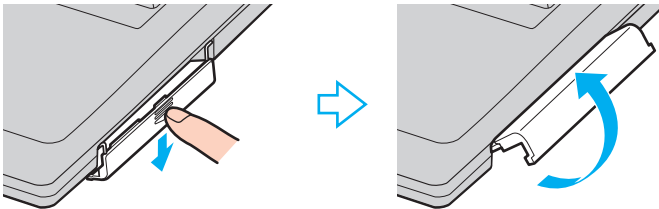

- 3 Slide the battery (with the logo facing up) into the battery bay. If the computer is on, it automatically detects the battery.

Inserting the Battery

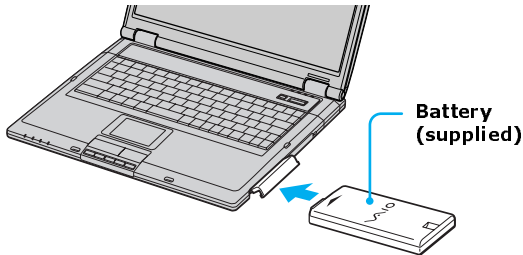

- 4 Push the battery bay cover up until it clicks into place.
- 5 Connect the AC adapter to the computer. See “To connect the AC adapter.”

Once you connect the AC adapter to the computer, the battery begins to charge whether the computer is on or off. The battery indicator shows the battery status. The indicator blinks as the battery charges. See “Powering Your Computer” in your on-screen VAIO® Computer User Guide for more information.

To connect the AC adapter

- 1 Plug the AC adapter cable into the DC IN port.

Connecting the AC Adapter to the Computer

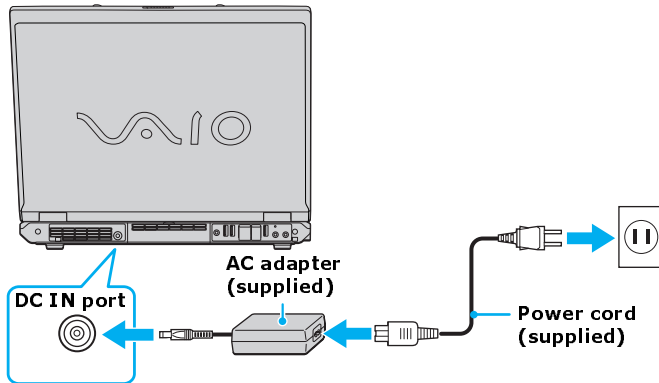

- 2 Plug the power cord into the AC adapter and an AC outlet.

 Use only the supplied AC adapter with your computer.

To open and turn on the computer

- 1 Slide the release latch to the right and lift the cover while holding the bottom of the computer firmly.

Opening the Computer

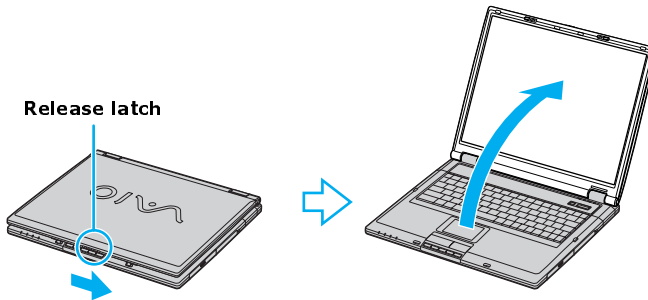

- 2 Press the power button until the green power indicator lights up.

Turning on the Computer

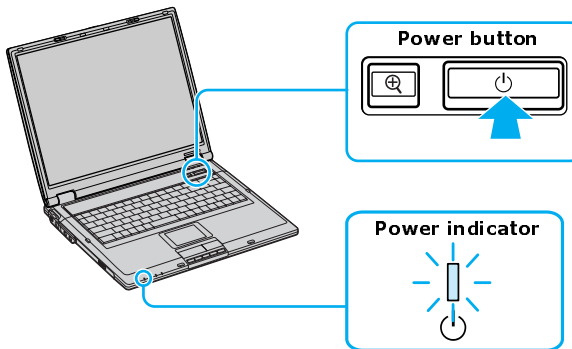

 If you hold down the power button, the computer turns off.

- 3 If necessary, adjust the brightness controls for the LCD display as follows:
- ❑ To increase brightness, press the **Fn+F5** keys, and then press the **Up Arrow** key **↑** or **Right Arrow** key **→**.
 - ❑ To decrease brightness, press the **Fn+F5** keys, and then press the **Down Arrow** key **↓** or **Left Arrow** key **←**.

Using the Touch Pad

The computer contains a pointing device called a touch pad. You can point to, select, drag, and scroll objects on the screen using the built-in touch pad.

Describing the touch pad

Locating the Touch Pad

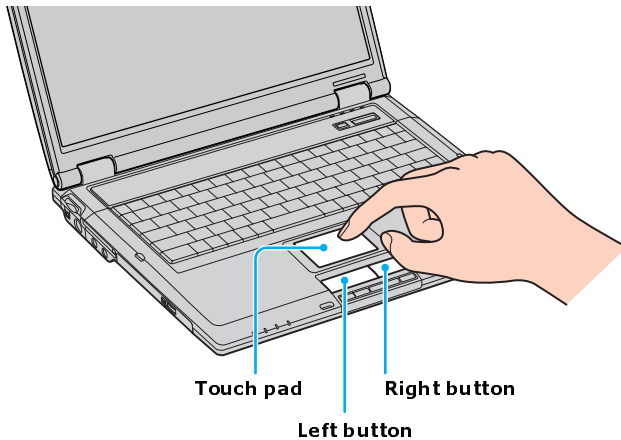

<i>Touch Pad Action</i>	<i>Description</i>
Sliding one finger	Equivalent to using a mouse to place the pointer on an item.
Tapping once	Equivalent to pressing the left button once.
Tapping twice	Equivalent to pressing the left button twice.

Touch Pad Action	Description
-------------------------	--------------------

Sliding one finger while pressing the left button	Equivalent to using the mouse to drag an item.
---	--

Moving your finger along the right edge of the touch pad	Equivalent to scrolling vertically. (The scroll function is available only with programs that support a touch pad scroll feature.)
--	--

Moving your finger along the bottom to scroll horizontally	Equivalent to scrolling horizontally. (The scroll function is available only with programs that support a touch pad scroll feature.)
--	--

Registering Your Computer

 You are prompted to register your computer the first time you turn on the unit. Follow the on-screen instructions to complete the registration process. If you are not able to register your computer during the first session, you are provided with additional registration opportunities later.

Take advantage of Sony's commitment to quality customer support and receive these benefits by registering your computer:

- ❑ Sony Customer Support — Talk to a support representative to troubleshoot problems you may have with your computer.
- ❑ Limited Warranty Extension — Protect your investment. See the Warranty Card for more details.
- ❑ Product Information Notification — By giving Sony your contact information, you will enable Sony to reach you regarding performance updates and upgrades.

Locating Your VAIO Computer User Guide

The on-screen VAIO® Computer User Guide is a searchable help file that contains detailed information on how to use your new computer. Some of the topics in your on-screen VAIO® Computer User Guide include the following:

- Batteries
- Internet and Networking
- CDs and DVDs
- Printing
- Features
- Mice and Keyboards
- PC Cards and Floppy Disks
- Optical Drives
- Port Replicators (if applicable)
- Audio/Video
- Memory

To open the user guide (Windows XP)

- 1 Click **Start** on the Windows® taskbar, and then click **Help and Support**. The **Help and Support Center** window appears, displaying information about your VAIO® computer and Microsoft® Windows® operating system.

Locating the VAIO User Guide (Windows XP)

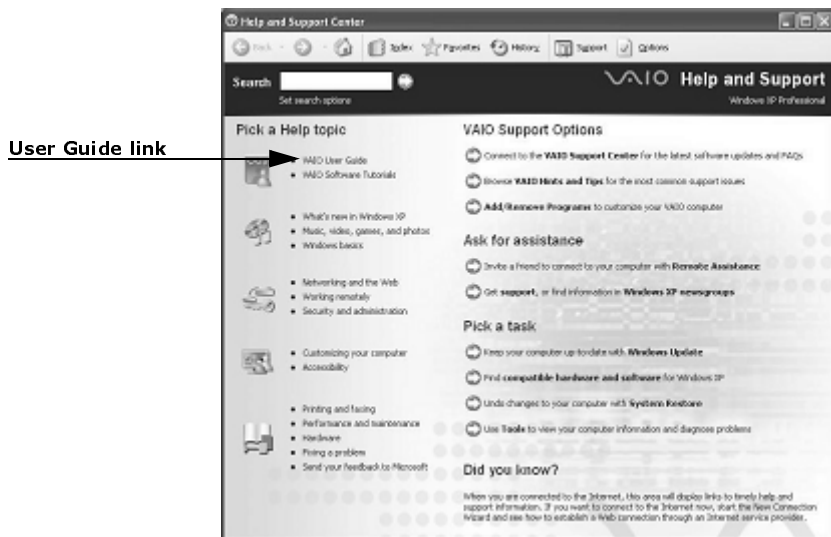

- 2 Click **VAIO User Guide** in the **Pick a Help topic** column. A second **Help and Support Center** window appears, which offers information about your computer.

VAIO User Guide Window (Windows XP)

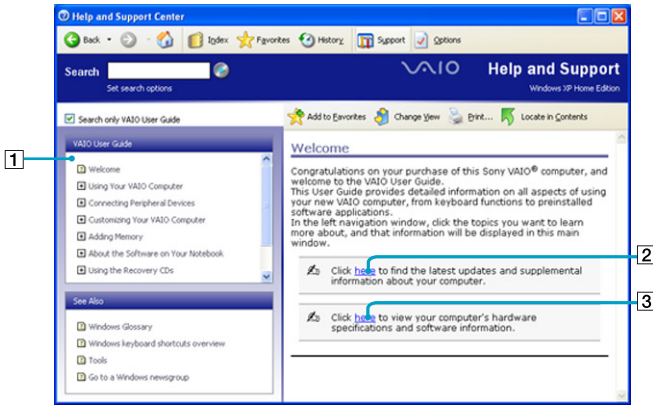

1	User guide table of contents	List of computer help topics
2	Link to Electronic Flyer	List of updates and supplemental information
3	Link to VAIO Computer Specifications	List of specifications and programs.

To open the user guide (Windows 2000)

- ❑ Click **Start** on the Windows® taskbar, point to **VAIO Help Center** and click **VAIO User Guide**. The **VAIO User Guide** appears.

VAIO User Guide (Windows 2000)

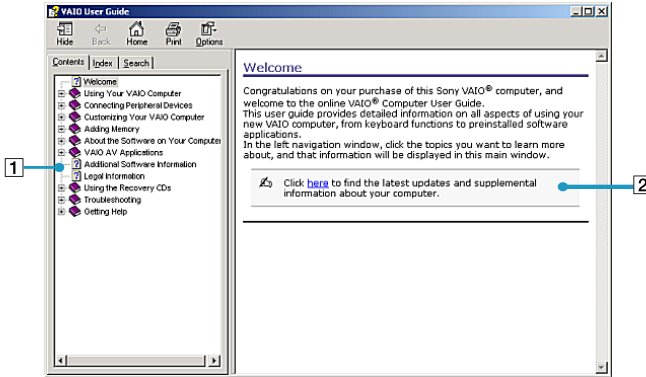

1	User guide table of contents	List of computer help topics
2	Link to Electronic Flyer	List of updates and supplemental information

Setting Up A Dial-Up Connection

This section describes the basic steps for setting up your dial-up connection. The Connection Wizard guides you through the process of choosing an Internet Service Provider (ISP) or setting up an existing account, and connecting to the Internet.

To set up a dial-up connection (Windows XP)

- 1 Connect a telephone cable to your computer. See “Setting up a dial-up Internet connection” in the Internet and Network Connections chapter of your on-screen VAIO® Computer User Guide.
- 2 Click **Start**, point to **All Programs, Accessories, Communications**, and then click **New Connection Wizard**. The **New Connection Wizard** appears.

New Connection Wizard



- 3 Click **Next**.
- 4 If it is not already selected, click **Connect to the Internet**.
- 5 Click **Next**.
- 6 Follow the on-screen instructions.

To set up a dial-up connection (Windows 2000)

- 1 Click **Start**, point to **Programs, Accessories, Communications**, and then click **Internet Connection Wizard**. The **Internet Connection Wizard** window appears.

Internet Connection Wizard

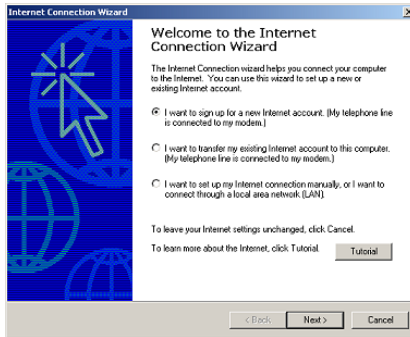

- 2 Follow the on-screen instructions to finish setting up your Internet connection.

Turning Off Your Computer

Using the power button to turn off your computer may result in loss of data. Follow the steps below to properly turn off your computer and avoid losing data.

To turn off your computer

- 1 Close all operations.
- 2 Click **Start** on the Windows® taskbar.
- 3 (Windows XP) Click **Turn Off Computer** at the bottom of the **Start** menu to display the **Turn off computer** window, and select **Turn Off**.
(Windows 2000) Click **Shut Down** at the bottom of the **Start** menu to display the **Shut Down Windows** window, and select **Shut Down**.

 Respond to any prompts warning you to save documents.

- 4 Wait for your computer to turn off automatically. The computer is off when the power indicator turns off.

 During a period of inactivity, you can conserve battery life by using power saving modes. See “Conserving Battery Power” in the VAIO® Computer User Guide for more information.

 If you are unable to turn off the computer, press the power button and hold it. This operation may result in data loss.

Expanding Your Computing Power

This section helps you get started upgrading computer memory and locating information about preinstalled programs.

Upgrading Memory

Depending on the configuration you purchased, your computer may accept additional memory modules. For information about installation procedures, refer to the on-screen VAIO® Computer User Guide and print those relevant steps. See “Locating Your VAIO Computer User Guide” on page 33.

The specifications supplied with your computer (either on-screen for Windows XP or printed for Windows 2000) list the amount of installed memory and required memory modules for upgrades.

Locating Preinstalled Programs

Your computer comes with a variety of preinstalled audio/video programs. The following sources offer a list of preinstalled programs, descriptions, and information:

- ❑ **VAIO® Computer Specifications (Windows XP)** — The on-screen file details your computer’s hardware specifications and lists preinstalled programs, descriptions, and support information. See “Locating Your VAIO Computer User Guide” on page 33 for more information.
- ❑ **All Programs (Windows XP)** — The All Programs menu, which you can access from the Start menu, contains a list of all the preinstalled programs on your computer.
- ❑ **Programs (Windows 2000)** — The Programs menu, which you can access from the Start menu, contains a list of all the preinstalled programs on your computer.

Caring for Your Computer

This section provides information on how to safely use your Sony computer.

Storing Your Computer

- ❑ Do not use or store your computer in a location subject to:
 - ❑ Heat sources, such as radiators or air ducts
 - ❑ Direct sunlight
 - ❑ Excessive dust
 - ❑ Moisture or rain
 - ❑ Mechanical vibration or shock
 - ❑ Strong magnets or speakers that are not magnetically shielded
 - ❑ Ambient temperature higher than 95°F (35°C) or less than 40°F (5°C)
 - ❑ High humidity
- ❑ Do not place electronic equipment near your computer. When running, the computer's electromagnetic field may cause other electronic equipment in close proximity to malfunction.
- ❑ Provide adequate air circulation to prevent internal heat buildup. Do not place your computer on porous surfaces such as rugs or blankets, or near materials such as curtains or draperies that may block ventilation. Leave a space of at least 8 inches (20 cm) behind the back of the computer.
- ❑ If the computer is brought directly from a cold location to a warm one, moisture may condense inside your computer. In this case, allow at least one hour before turning on your computer. If any problems occur, unplug your computer, and contact your Sony Service Center.
- ❑ The computer uses high-frequency radio signals and may interfere with radio or TV reception. Should this occur, move the computer a suitable distance away from the radio or TV.
- ❑ Do not drop the computer or place heavy objects on top of the computer.

Using Cables and Connections

- ❑ Use only specified peripheral equipment and interface cables.
- ❑ Do not use cut or damaged connection cables.
- ❑ If the telephone company makes a service call to your home or office and determines that your computer is responsible for a problem, the telephone company may bill you for the service call. Also, if you do not disconnect your computer when it is adversely affecting a telephone line, the telephone

company has the right to disconnect your service until you correct the problem.

Cleaning Your Computer

- ❑ Clean the computer with a soft, dry cloth or a soft cloth lightly moistened with a mild detergent solution. Do not use any type of abrasive pad, scouring powder, or solvent such as alcohol or benzine, as these may damage the finish of your computer. You can use canned compressed air specifically for computers to remove dust.
- ❑ If a solid object falls onto the computer or a liquid leaks into the computer, immediately turn off and unplug the computer. It is best to have the computer checked by qualified personnel before you use it again.
- ❑ Avoid rubbing the LCD screen as this can damage the screen. Use a soft, dry cloth to wipe the LCD screen or canned compressed air.
- ❑ Always disconnect the power cord before cleaning the computer.

Handling the LCD Screen

- ❑ Direct sunlight can damage the LCD. Be careful when using the computer near a window.
- ❑ Do not scratch the LCD or exert pressure on it. This can cause a malfunction.
- ❑ Using the computer in low temperature conditions may produce a residual image on the screen. This is not a malfunction. When the computer returns to normal temperature, the screen returns to normal.
- ❑ The screen becomes warm during operation. This is normal and does not indicate a malfunction.
- ❑ The LCD is manufactured using high-precision technology. You may, however, see tiny black points and/or bright points (red, blue, or green) that continuously appear on the LCD. This is a normal result of the manufacturing process and does not indicate a malfunction.

VAIO Recovery Options

The VAIO® Recovery Wizard enables you to recover preinstalled software programs and the operating system on your computer. You can also use this utility to create a Recovery Media Kit. The Recovery Media Kit enables you to reclaim hard drive space and return your computer to normal operation.

 This program repairs or replaces software. For any hardware problems, contact a Sony authorized repair facility.

- About Recovery Options*
- About the Recovery Media Kit*
- Using the VAIO Recovery Wizard*

About Recovery Options

You have several options when recovering software or your computer's operating system.



When you recover drive C, drive D, or perform a complete recovery, the VAIO Recovery Wizard deletes and replaces all the files on the selected drives.

Sony recommends backing up your personal data to storage media or to another computer before proceeding with system recovery.

Accessing the VAIO Recovery Wizard

You can start the VAIO Recovery Wizard utility from the Microsoft® Windows® XP Start menu, from the Recovery Media Kit, or from using the F10 key¹ on notebook computers. Depending on how you access the VAIO Recovery Wizard, you have different system and software recovery options.

System and software recovery options

❑ Create the Recovery Media Kit

You can create a Recovery Media Kit, consisting of CDs and DVDs, which enable you to recover your computer at a later date if the software stops working properly. You can start the VAIO Recovery Wizard from the Windows XP Start menu, and create a Recovery Media Kit.

❑ Windows® System Restore

Return your computer's operating system to a previous working state by performing a System Restore. You can access this recovery option by starting the VAIO Recovery Wizard, or by using the Windows XP System Restore Wizard.

❑ Recover drive C

Returns the drive C to its original factory-installed settings. All previous data and settings on drive C are deleted. You can preserve data on other partitions, such as drive D. To recover drive C, access the VAIO Recovery Wizard from the Windows XP Start menu, the Recovery Media Kit, or by using the F10 key on notebook computers.

❑ Recover drives C and D

Return drives C and D to their original factory-installed settings. With this

¹ This feature is available for VAIO® notebook computers only.

option, you lose all data and settings on both drives. To recover drives C and D, start the VAIO Recovery Wizard from the Windows XP Start menu, the Recovery Media Kit, or by using the F10 key on notebook computers.

 Recovering drives C and D with the Recovery Media Kit is the only way to restore the hidden recovery drive.

❑ **Recover software programs**

Recover specific factory-installed software. To recover the original software programs, start the VAIO Recovery Wizard from the Windows XP Start menu or from the Recovery Media Kit. You can access this option by using **Disc 1** from your Recovery Media Kit.

❑ **Perform a complete hard disk drive recovery**

Completely recover your computer's hard disk drive. This option recovers drives C and D, and the hidden recovery drive. To perform a complete hard disk drive recovery, start the VAIO Recovery Wizard from your Recovery Media Kit.

About the Recovery Media Kit

The Recovery Media Kit is created using your own CDs and/or DVDs. You can create the Recovery Media Kit, or purchase it from Sony.

Recovery Media Kit overview

Confirm that you have sufficient CD and/or DVD recordable media available before you begin creating the Recovery Media Kit. You should also have a permanent marking pen ready, to label each CD and/or DVD media. You can create your kit using a single type of media or by combining media types, as follows:

- ❑ One recordable CD (CD-R) and up to two recordable DVDs (DVD-R or DVD+R)
(Your VAIO® computer must be equipped with a DVD-RW¹ or DVD±RW drive.)
- ❑ Up to 12 recordable CDs (CD-R)
(Your VAIO computer must be equipped with a CD-RW drive.)

Before you begin creating the Recovery Media Kit, prepare your computer for the process, as follows:

- ❑ Close all open programs.
- ❑ Disconnect all network connections.
- ❑ Disconnect all peripheral devices.
- ❑ Do not interrupt the power.
- ❑ Disable any virus protection software.
- ❑ Disable your screen saver.

Creating the Recovery Media Kit

The Recovery Media Kit can be used to start the VAIO Recovery Wizard, in the event your system is unable to start normally. You can reclaim the portion of your hard drive that is allocated to system recovery using the Recovery Media Kit.

¹ A DVD-RW drive supports DVD-R media only.

To create the Recovery Media Kit

- 1 Click **Start** in the Windows® taskbar, point to **All Programs**, and then click the **VAIO® Recovery Wizard**.

The VAIO Recovery Wizard appears.

 You can start the VAIO Recovery Wizard by double-clicking the VAIO Recovery Wizard icon in the Windows taskbar notification area.

VAIO Recovery Wizard

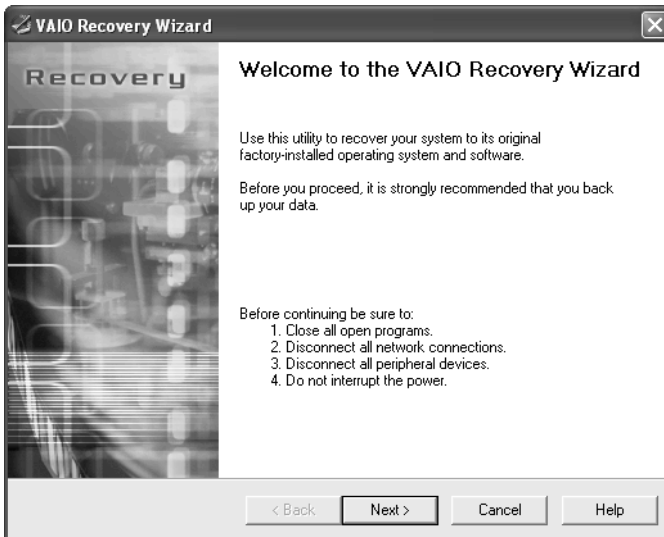

- 2 Read the on-screen information. Click **Next**.
- 3 Select **Create Recovery Media Kit (Strongly Recommended)**, and click **Next**.

VAIO Recovery Wizard — Selecting Create Recovery Media Kit



- 4 Select the Recovery Media Kit that you want to create.

You can create your kit using a single type of media or by combining media types, as follows:

- One recordable CD (CD-R) and up to two recordable DVDs (DVD-R or DVD+R)
(Your VAIO® computer must be equipped with a DVD-RW¹ or DVD±RW drive.)
- Up to 12 recordable CDs (CD-R)
(Your VAIO computer must be equipped with a CD-RW drive.)

- 5 Click **Next**. Your computer's optical drive tray opens automatically.

- 6 Insert a blank disc into the drive and close the drive. Click **Next**.

The CD creation process begins. A window with a progress bar appears.

¹ A DVD-RW drive supports DVD-R media only.

 The time required to create each CD or DVD may vary, depending on your optical drive's recording speed.

- 7 When prompted, eject the disc. Label the top of the disc with a permanent marker according to the on-screen instructions.
- 8 Repeat steps step 6 through step 7 for each CD or DVD.
- 9 When the text, **The Recovery Media Kit is complete** appears, click **OK**.
- 10 Click **Finish**. Store the Recovery Media Kit in a safe location.

To order the Recovery Media Kit

- 1 Go to the Sony Direct Accessories and Parts Center Web site at <http://servicesales.sel.sony.com>.
- 2 Enter your computer's model number (for example, PCV-XXX), and click **List Parts and accessories**.
- 3 Follow the online instructions to order the Recovery Media Kit.

 If you are not able to access the Sony Direct Accessories and Parts Center Web site, contact a customer service representative at 1-800-488-7669.

Using the VAIO Recovery Wizard

The VAIO® Recovery Wizard provides recovery options for your computer. You can access this tool from Windows® XP Start menu, your Recovery Media Kit, or by pressing the F10 key¹ on your notebook computer.

Starting the VAIO Recovery Wizard

To access the VAIO Recovery Wizard from Windows XP

- 1 Click **Start** in the Windows® taskbar, point to **All Programs**, and click **VAIO Recovery Wizard**.

 Using the VAIO Recovery Wizard may require you to restart your computer, even if you cancel and exit the wizard.

- 2 From the **Welcome** window, click **Next**.
- 3 Choose one of the available menu options.

To access the VAIO Recovery Wizard from the Recovery Media Kit

- 1 Press the power switch on the computer to turn on the power.
- 2 Open the optical drive, and place the **Startup Recovery Disc** in the optical drive.
- 3 Close the drive.
- 4 Turn off your computer.
- 5 Wait for approximately 30 seconds, and then turn on the computer.
- 6 When prompted, insert the **Recovery Disk 1** into the optical drive, and then click **OK**.

The VAIO Recovery Wizard appears.

- 7 Click **Next**.
- 8 Choose one of the available menu options.

¹ This feature is available for VAIO® notebook computers only.

To start the VAIO Recovery Wizard using the F10 Key (for notebook computers only)

- 1 Turn off your notebook computer.
- 2 Press the power switch on the computer to turn on the power.
- 3 When you see the VAIO logo appear on the computer's screen, briefly press the **F10** key.
- 4 Click **Next**.
- 5 Choose one of the available menu options.

Using the VAIO Recovery Wizard

To use Windows System Restore from the VAIO Recovery Wizard

- 1 Start the VAIO® Recovery Wizard, and click **Next**.
- 2 Select **Proceed with System Recovery**, and click **Next**.
- 3 Select **Windows® System Restore**, and click **Next**.
- 4 Follow the on-screen instructions.

VAIO Recovery Wizard — Selecting Windows System Restore



To recover drive C

- 1 Start the VAIO Recovery Wizard, and click **Next**.
- 2 Select **Proceed with System Recovery**, and click **Next**.
If using the Recovery Media Kit, skip this step.
- 3 Select **C Drive Recovery**, and click **Next**.

VAIO Recovery Wizard — Selecting C Drive Recovery



- 4 Read the on-screen information. Click **Next**.
- 5 The wizard begins the drive C recovery. When it is finished, click **Next**.
- 6 Click **Finish**. Your computer restarts.

To recover drives C and D (and reclaim all space on the hard disk drive)

- 1 Start the VAIO® Recovery Wizard, and click **Next**.
- 2 Select **Proceed with System Recovery**, and click **Next**.
(If you are using the Recovery Media Kit, skip step 2.)
- 3 Select **Custom Recovery (for Advanced Users)**, and click **Next**.
- 4 Select **C and D Drive Recovery**, and click **Next**.

If you are using the Recovery Media Kit, you have two choices for this recovery option:

- Keep the Recovery Drive (Recommended)**

- ❑ **Remove the Recovery Drive.**

VAIO Recovery Wizard — Selecting the C and D Drive Recovery option



- 5 Choose the size of drive C. Any remaining disk space is allocated to drive D (minus the space allocated for the recovery drive). Click **Next**.

 Computers that come equipped with Giga Pocket software do not allow you to set the drive D to zero.

- 6 The wizard starts implementing recovery. When it is finished, click **Next**.
- 7 Click **Finish**, and the computer restarts.

To recover software applications

- 1 Start the VAIO® Recovery Wizard, and click **Next**.
- 2 Select **Proceed with System Recovery**, and click **Next**.

If using the Recovery Media Kit, skip this step.

- 3 Select **Custom Recovery (for Advanced Users)**, and click **Next**.

 If you select the Application Recovery option, you cannot return to the system recovery portion of the VAIO® Recovery Wizard without restarting your computer.

- 4 Select **Application Recovery**, and click **Next**.

VAIO Recovery Wizard — Selecting Application Recovery



- 5 Click to select the check box for each software program you want to recover. Click **Next**.

You may need to use the scrollbar to view all available software programs.

VAIO Recovery Wizard — Selecting applications

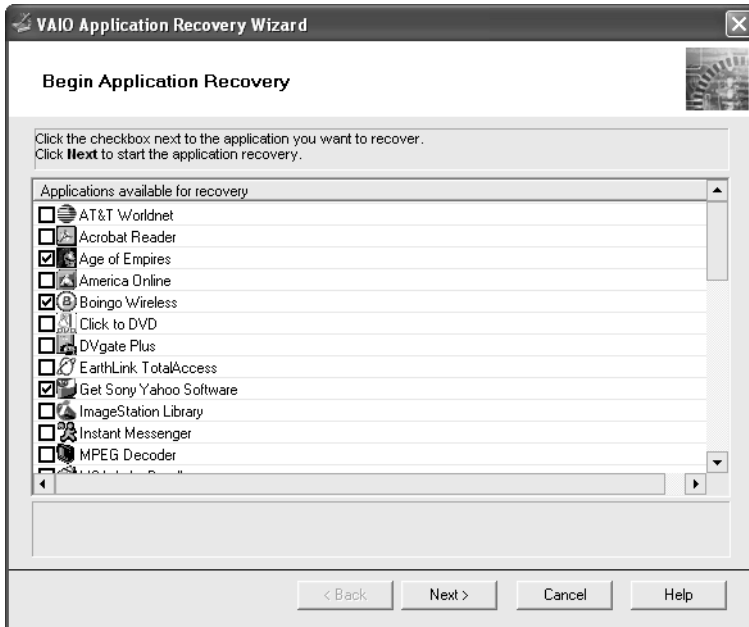

- 6 As your computer prepares to install each application, a status indicator appears. You may see installation wizards, messages, and prompts. Follow the instructions provided in each wizard, and respond to each prompt or message.

When the selected software has been recovered, the **Application Recovery Complete** window appears.

- 7 If you want to recover additional software, click **Back**. The **Application Recovery** window appears with a listing of the available software titles.
- 8 Click **Finish**. Your computer restarts.

 If the recovered software does not function properly or you see an installation error message, try recovering the software again.

To perform a complete hard disk drive recovery

You must use the Recovery Media Kit to perform a complete hard disk drive recovery.

- 1 Press the power switch on the computer to turn on the power.
- 2 Open the optical drive, and place the **Startup Recovery Disc** in the optical drive.
- 3 Close the drive.
- 4 Turn off your computer.
- 5 Wait for approximately 30 seconds, and then turn on the computer.
- 6 When prompted, insert the **Recovery Disk 1** into the optical drive, and then click **OK**.

The VAIO Recovery Wizard appears.

- 7 Click **Next**.
- 8 Select **Custom Recovery (for Advanced Users)**, and click **Next**.
- 9 Select **Complete Recovery**, and click **Next**.
- 10 You may see installation wizards, messages, and prompts. Follow the instructions provided in each wizard, and respond to each prompt or message. Your computer may restart.
- 11 When the optical drive ejects, remove the disc. Close the drive, and click **Next**. Your computer may restart several times.

Additional Information

- ❑ Certain software, such as DVgate™ Plus software, automatically saves data to drive D. If you choose not to have a drive D partition, you must change the software settings to enable file saving to drive C.
- ❑ Resizing your hard disk drive partitions with third-party software programs can result in the loss of the VAIO® Recovery Wizard.
- ❑ Giga Pocket™ software requires a drive D in order to operate. For VAIO® computers with Giga Pocket software preinstalled, you cannot set the drive D size to zero.

Using the Application Recovery and System Recovery CDs

(For Windows® 2000 models only) You can restore your system, individual programs, or drivers, using the Application Recovery and System Recovery CDs.

Application and System Recovery CDs

Your computer comes with the following Application Recovery and System Recovery CDs. You will need an optical drive to use these recovery CDs. If your computer does not come with an optical drive, use an external optical drive.

Application Recovery CDs

Sony Electronics Inc.

These CDs enable you to reinstall individual programs and device drivers if they become corrupted or are erased.

System Recovery CDs

Sony Electronics Inc.

These CDs enable you to restore the operating system and programs that shipped with your computer if they become corrupted or are erased. These CDs restore your computer to its original factory settings, so user data and programs installed since you started using your computer will be lost.

Using Your Recovery CDs

The following sections describe how to use the Application Recovery and System Recovery utilities.

Using the Application Recovery CDs

The Application Recovery CDs enable you to reinstall individual programs and device drivers, and to repair programs if they become corrupted or are erased. Reinstalling an individual program or device driver may correct a problem you are experiencing with your computer, peripheral hardware, or software. You may not need to reinstall the entire contents of your hard disk. To reinstall all the programs that shipped with your computer, use the System Recovery CDs. See “Using the System Recovery CDs” for more information.



Your computer must have a Microsoft® Windows® operating system to run the Application Recovery CD utility.

To reinstall programs with the Application Recovery CDs

 Your system may include one or more Application Recovery CDs. If you have more than one Application Recovery CD, insert the first CD (CD No. 1) to run the Application Recovery program. You may be prompted to insert the next CD, depending on the application you wish to restore.

- 1 Turn on your computer. If your computer is already on, close all open programs.
- 2 Logon to the Microsoft® Windows® desktop.
- 3 Insert Sony Application Recovery CD No. 1 into your computer's optical drive. The Application Recovery utility starts automatically.
- 4 Click **OK** in the VAIO welcome window. The **Sony Application Recovery Program** window appears.
- 5 Double-click the **Software** folder. Icons representing the original, preinstalled programs are displayed.
- 6 Double-click the application you want to restore. The program's installation wizard begins.
- 7 Follow the on-screen instructions to complete the recovery process.

To reinstall device drivers using Windows XP operating system

(For Windows® XP systems only) The Microsoft® Windows® XP operating system is capable of reinstalling the original factory-installed device drivers, without using the Application Recovery CD(s).

- 1 Click **Start** in the Windows taskbar, then right-click **My Computer**. A shortcut menu appears.
- 2 Click **Properties**. The System Properties dialog box appears.
- 3 From the **Hardware** tab, click the **Device Manager** button.
- 4 Right-click to select the unknown device* or the device that requires the driver installation and click **Update Driver** from the shortcut menu. The Hardware Update Wizard appears.

* Unknown devices are identified by a yellow question mark. A device that has a driver problem is identified by a yellow exclamation mark.

- 5 Follow the on-screen instructions to locate and reinstall the appropriate device driver.

 If Windows® XP does not reinstall the device driver(s), follow the steps in the next section to reinstall the device driver(s) using the Application Recovery CD(s).

To reinstall device drivers with the Application Recovery CDs

 Your system includes one or more Application Recovery CDs. Insert Application Recovery CD No. 1 to start the application or driver recovery process. You are prompted to insert the next CD(s), depending on the application or driver you want to restore.

- 1 Logon to the Microsoft® Windows® desktop.
- 2 Insert Application Recovery CD No. 1 into your computer's optical drive. The VAIO welcome window appears. Click **OK**, then click **Quit** to close the Sony Application Recovery utility. (Leave the CD in the optical drive.)
- 3 Click **Start** on the Windows® taskbar, and right-click **My Computer**. A shortcut menu appears.
- 4 Click **Properties**. The **System Properties** dialog box appears.
- 5 Click the **Hardware** tab, and click **Device Manager**.
- 6 Right-click the unknown device* or the device that requires the driver installation, and click **Update Driver** from the shortcut menu. The Hardware Update Wizard appears.
- 7 In the **Hardware Update Wizard**, click to select **Install from a list or specific location (Advanced)**.
- 8 Click **Next**.
- 9 Click to cancel the **Search removable media (floppy, CD-ROM...)** option.
- 10 Click to select the **Include this location in the search** check box.
- 11 Click **Browse**. The **Browse For Folder** dialog box appears.

* Unknown devices are identified by a yellow question mark. A device that has a driver problem is identified by a yellow exclamation mark.

- 12 Navigate to the optical drive, and click to select the Application Recovery CD. The CD contents are displayed.
- 13 Click the folder name of the device in which you want to reinstall, and click **OK**. The **Hardware Update Wizard** appears.
- 14 Click **Next**, and select the device folder. The Microsoft® Windows® operating system automatically reinstalls the device driver(s) from the Application Recovery CD.
- 15 Click **Finish**, and remove the Application Recovery CD from the optical drive.
- 16 Turn off your computer by clicking **Start**, and then **Turn off computer**.
- 17 Wait 30 seconds, and turn on your computer.

If you have any questions about using the Application Recovery CD(s), visit <http://www.sony.com/pcsupport>.

Using the System Recovery CDs

The System Recovery CDs enable you to format your hard disk drive and restore the operating system and all original, preinstalled programs. If the operating system or programs become corrupted or are erased, you can restore your computer to the original factory settings.



The System Recovery process removes all programs that you may have installed since you started using your computer. Reinstall any program that was not included with the computer when you purchased it.

You may not need to reinstall the entire contents of your hard drive. If you experience a problem with your computer, reinstalling an individual device driver or program may correct the problem. Use the Application Recovery CDs to reinstall individual programs and device drivers. See “Using the Application Recovery CDs” for more information.

The System Recovery CDs contain a backup copy of all the programs originally installed on your hard disk. It can be used only to recover the hard disk of the Sony computer you purchased.

When you successfully complete your system recovery, you are prompted to complete the Windows® registration process.

System Recovery options

- ❑ **Default System Drive Recovery** — All data on Drive C is deleted. The factory default settings and programs are restored on this drive only.
- ❑ **Change Partition Size and Recover** — All partitions, custom installations, and changes are removed from the hard drive. You can set the partition sizes for both Drive C and Drive D. The original, preinstalled operating system and programs are restored.
- ❑ **Factory Default Settings Recovery** — All data and partitions are removed from the hard drive. All original factory settings, the operating system, and preinstalled programs are restored.



The System Recovery utility does not back up your system's data. If you wish to retain your system data, perform a backup to an external media.

To use the System Recovery CDs

Your system may take a few minutes to load necessary files. A blue screen may appear during the downloading process.

Your system may include one or more System Recovery CDs. If you have more than one System Recovery CD, insert the first CD (CD No. 1) to run the System Recovery program. You will be prompted to insert the next CD(s) once the information from the first CD has been installed.

- 1 Press the disc eject button to open the optical disc drive and extend the disc tray.
- 2 Insert the Sony System Recovery CD No. 1 into the optical drive, and close the drive. The first CD must be in the drive before you restart your computer.
- 3 (Windows XP) Turn off your computer by clicking **Start, Turn off computer**, and selecting **Turn Off**.
(Windows 2000) Turn off your computer by clicking **Start, Shut Down**, and selecting **Shut Down**.
- 4 Wait at least 30 seconds, and turn on your computer. The System Recovery utility restarts from the optical drive. Your screen displays the downloading progress, "Starting VAIO Recovery Utility."
- 5 When the **VAIO System Recovery Utility** wizard appears, click **Next**.
- 6 The Notes on Use window appears. Click **Next**.

- 7 On the Main Menu - Product Recovery window, select the appropriate option to recover your system.
- 8 Follow the on-screen instructions to complete the recovery process.

 The recovery process takes approximately 30 to 60 minutes to complete.

After recovering your system using the System Recovery CD(s), you may be prompted to insert your Application Recovery CD(s) after restarting Windows. Use the Application Recovery CD(s) to complete full restoration of your system.

If your computer does not start from the Recovery CD

- 1 Press the power button and hold it for more than four seconds to turn off the computer.
- 2 Turn on the computer. When the Sony logo is displayed, press the **F2** key. The **BIOS Setup Utility** appears.
- 3 Press the right arrow key **→** to select the **Exit** menu.
- 4 Press the down arrow key **↓** to select **Get Default Values**, and press **Enter**. The **Setup Confirmation** window appears.
- 5 Press **Enter** again to select **Yes**.
- 6 Make sure **Exit (Save Changes)** is selected, and then press **Enter**. The **Setup Confirmation** window appears again.
- 7 Make sure **Yes** is selected, and press **Enter**. The computer restarts from the Recovery CD.

 If you have more than one System Recovery CD, insert the first CD to run the System Recovery program. You are prompted to insert the second CD once the information from the first CD has been installed.

The recovery process takes 30 to 60 minutes to complete.

After recovering your system using the System Recovery CDs, you may be prompted to insert your Application Recovery CDs after restarting the Windows operating system. Insert the Application Recovery CD to automatically complete recovery of your system.

Troubleshooting

Computer

What do I do if my computer won't start?

- ❑ Make sure the computer is securely plugged into a power source and turned on. Make sure the power indicator shows the power is on.
 - ❑ Make sure the battery is inserted properly and charged.
 - ❑ Make sure the floppy disk drive (if applicable) is empty.
 - ❑ If the computer is plugged into a power strip or uninterruptible power supply (UPS), make sure the power strip or UPS is turned on and working.
 - ❑ If you are using an external display, make sure it is plugged into a power source and turned on. Make sure the brightness and contrast controls are adjusted correctly. See the guide that came with your display for details.
 - ❑ Disconnect the AC adapter and remove the battery. Wait one minute. Reattach the AC adapter and reinsert the battery. Turn on the power.
 - ❑ Condensation may cause the computer to malfunction. If this occurs, do not use the computer for at least one hour.
 - ❑ If the computer still does not turn on, follow these steps:
 - 1 Unplug the power cord and remove the battery.
 - 2 Use a thin, straight object (such as a paper clip) to press the reset button.
-  See "Locating Controls and Ports" on page 19 to locate the reset button.
- 3 Reinsert the power cord and the battery.
 - 4 Turn on the computer.

What do I do if a BIOS error appears when my computer starts?

If the message “Press <F1> to resume, <F2> to setup” appears at the bottom of the screen, follow these steps:

- 1 Press the **F2** key. The **BIOS Setup** menu appears.
- 2 Set the date (month/day/year). Press **Enter**.
- 3 Press the **Down Arrow** key **↓** to select **System Time**, and then set the time (hour: minute: second). Press **Enter**.
- 4 Press the **Right Arrow** key **→** to select the **Exit** tab, and then press the **Down Arrow** key **↓** to select **Get Default Values**. The message **Load default values for all SETUP items** appears.
- 5 Press **Enter**. The **Setup Confirmation** window appears.
- 6 Select **Yes**, and press **Enter**.
- 7 Select **Exit (Save Changes)**, and press **Enter**. The **Setup Confirmation** window appears again.
- 8 Select **Yes**, and press **Enter**. The computer restarts.

 If this occurs on a regular basis, contact Sony Computing Support (<http://www.sony.com/pcsupport>).

What do I do if the message “Operating system not found” appears when my computer starts, and why won’t Windows start?

- Make sure the computer does not have a “non-bootable” floppy disk in the floppy disk drive (if applicable).
- If a non-bootable floppy disk is in the drive:
 - 1 Remove the floppy disk.
 - 2 Restart the computer and confirm that the Microsoft® Windows® operating system starts properly.
- If Windows still does not start, follow these steps to initialize the BIOS:
 - 1 If there is a disk in the floppy disk drive, then remove it.

- 2 Turn off the computer.
- 3 Remove any peripheral devices connected to the computer.
- 4 Restart the computer.
- 5 Press the **F2** key when the Sony logo appears. The **BIOS Setup** window appears.
- 6 Press the **Right Arrow** key → to select the **Exit** menu.
- 7 Press the **Down Arrow** key ↓ to select **Get Default Values**. The message **Load default values for all SETUP items** appears.
- 8 Press **Enter**. The **Setup Confirmation** window appears.
- 9 Select **Yes**, and press **Enter**.
- 10 Select **Exit (Save Changes)**, and press **Enter**. The **Setup Confirmation** window appears again.
- 11 Select **Yes**, and press **Enter**. The computer restarts.

Why does my computer stop responding? Why can't I turn off my computer?

It is best to turn off your computer using the Turn Off Computer option on the Microsoft® Windows® Start menu, located on the taskbar. Using other methods, including those listed below, may result in loss of unsaved data.

- Click **Start** on the Windows® taskbar, select **Turn Off Computer**, and then click **Turn Off**.
- If your computer does not turn off, press the **Ctrl+Alt+Delete** keys simultaneously. When the **Windows Task Manager** dialog box appears, click **Turn Off** from the **Shut Down** menu.
- If your computer still does not turn off, press and hold the power button or slide and hold the power switch until the computer turns off.
- If your computer stops responding while playing a CD or DVD, press the **Ctrl+Alt+Delete** keys simultaneously. You can turn off the computer from the **Windows Task Manager**.



 Pressing the **Ctrl+Alt+Delete** keys simultaneously or turning off the computer with the power button or switch may cause loss of data.

- Remove the AC adapter and battery.

Why won't my computer enter Standby or Hibernate mode?

Your computer may become unstable if the operating mode is changed before the computer completely enters Standby or Hibernate.

To restore the computer to normal operating stability:



- 1 Close all open programs.
- 2 Restart the computer. Follow these steps:
 - 1 Press the **Windows** key .
 - 2 Press **U**.
 - 3 Press **R** to select restart.
- 3 If the computer does not restart, follow these steps:
 - 1 Press the **Ctrl+Alt+Delete** keys simultaneously. The **Windows Task Manager** window appears.
 - 2 Press and release **Alt** to highlight the menu bar, and press the **Right Arrow**  key to select **Shut Down**.
 - 3 Press **Enter**.
 - 4 Press **R** to select restart.
- 4 If this procedure does not work, press and hold the power button or slide and hold the power switch until the computer turns off.

Why is the sound of my computer's fan so loud?

The computer's fan may be running at a high speed to cool the CPU. By lowering the CPU speed, you also lower the speed and noise level of the computer's fan. If your computer comes with the PowerPanel™ utility *, use it to lower the CPU speed. If your computer does not come with the PowerPanel utility, use the power schemes to lower the CPU speed.

* Available on selected models.

To lower the CPU fan speed using the PowerPanel utility:

- 1 On the Windows® taskbar, right-click the **CPU icon**  or **Profile icon** , depending on the model you purchased.
- 2 Select **Edit/Create Profiles**. The **AC Power - Profile Editor** window appears.
- 3 Double-click **System** to open the **System** submenu if it is not already open.
- 4 Double-click **CPU Fan Control**, and select **Level 1 Quiet**.
- 5 Restart your computer.

 See PowerPanel Help for more information.

To lower the CPU speed using the power schemes:

- 1 Click **Start** on the Windows® taskbar, and click **Control Panel**.
- 2 Click **Performance and Maintenance**, and click **Power Options**. The **Power Options Properties** window appears.
- 3 Select **Portable/Laptop** in the **Power schemes** box.
- 4 Click **Apply**.
- 5 Click **OK**.

Why does the System Properties dialog box display a slower CPU speed than the maximum?

This is normal. Because your computer's CPU utilizes a type of CPU speed controlling technology for power conservation purposes, System Properties may display the CPU's current speed instead of the maximum speed.

Why don't my changes appear on the computer screen (LCD)?

You may need to refresh the computer screen. Press and hold the **Windows** key , and press **D** twice.

Support Options

If you have questions about your computer or the preinstalled programs, refer to the following sources for answers in the sequence listed below.

1 VAIO® Computer User Guide

The on-screen VAIO® Computer User Guide and the printed VAIO® Computer Quick Start provide information on how to maximize your computer capabilities and solve common problems.

2 Program Guides and Help Files

The preinstalled programs on your computer may come with individual help guides. These guides are stored on the hard disk as on-screen Help files. You can find the Help files from the Help menu under the specific program.

3 Operating System Online Support

Your computer comes preinstalled with a Microsoft® Windows® operating system. For operating system support, you can visit Microsoft® customer support at: <http://support.microsoft.com/directory/>.

4 Sony Computing Support

This service provides instant access to information on commonly encountered problems. Type a description of the problem and the Knowledge Database searches for the corresponding solutions online. You can visit Sony Computing Support at: <http://www.sony.com/pcsupport>.

Index

A

- AC adapter 26
 - connecting 28
- Application Recovery CD 62
- applications
 - software programs 56

B

- battery
 - charging 26
 - indicator 19
- brightness control 30
- buttons
 - left 19
 - power 19
 - right 19

C

- caps lock 19
- complete recovery 59
- computer
 - cables 42
 - care 41
 - cleaning 43
 - controls and connectors 19
 - LCD screen 43
 - online support 74
 - specifications 16
 - specifications (online) 34
 - storage 42
 - troubleshooting 69
 - turning off 38
 - turning on 26

- unpacking 16
- updates 34, 35
- connecting
 - dial-up 36
- controls 19
 - brightness 30
- creating
 - Recovery Media Kit 49

D

- DC IN port 20
- dial-up connection 36

E

- Electronic Flyer 34, 35
- Energy Star 5
- Ethernet port 20

F

- F10
 - recovery 53
- faxes
 - laws governing 11

H

- handling the LCD screen 43
- hard disk drive
 - indicator 19
- hard drive recovery 45
- headphone jack 20
- help 33

I

- i.LINK port 21
- indicators
 - battery 19

- caps lock 19
- hard disk drive 19
- Memory Stick media 19
- num lock 19
- power 19
- scroll lock 19

- input devices 9
- interference 9
- internal speaker 19
- Internet connection 36

J

- jacks
 - headphone 20
 - microphone 20
 - modem jack 20

K

- keyboard 19

L

- LCD screen
 - handling 43

M

- maintenance 43
- manual 33
- Memory Stick media
 - indicator 19
 - slot 21
- microphone jack 20
- modem
 - laws governing 11
- modem jack 20
- Monitor (VGA) port 20
- Monitor port 20

N

- network connector 20
- num lock 19

O

- online support 74
- online user guide 33

- ordering
 - Recovery Media Kit 51
- output devices 9

P

- partition
 - recovery 55
- PC Card slot 21
- phone
 - laws governing 11
- ports
 - DC IN 20
 - i.LINK 21
 - USB 20
 - VGA (monitor) 20
- power

- indicator light 19

- power button 29

- power source 26

- programs
 - locating 40
 - recovering 56

R

- radio interference 9
- recovering 56
 - applications 56
 - complete system 59
 - drive C 54
 - drive C and D 55
 - recovery partition 55
 - software programs 56
 - Windows System Restore 53
- Recovery CDs 62
- Recovery Media Kit 45
 - CDs 48
 - creating 49
 - DVDs 48
 - ordering 51
- recovery partition 55

Recovery Wizard
starting 52
regulatory information 8
reset button 23
restoring data 62

S

scroll lock indicator 19
shutting down computer 38
software
locating 40
recovering 56
software programs 56
applications 56
specifications 16
specifications (online) 34
starting
Recovery Wizard 52
starting computer 26
startup problems 38
System Recovery CD 65

T

telephone line jack 20
touch pad
using 31
touchpad 19
troubleshooting 69
startup 38
turning off computer 38
turning on computer 26
TV
interference 9

U

unpacking the computer 16
updates 34, 35
USB port 20
user guide 33

W

Windows System Restore 53

<http://www.sony.com/vaio>

Free Manuals Download Website

<http://myh66.com>

<http://usermanuals.us>

<http://www.somanuals.com>

<http://www.4manuals.cc>

<http://www.manual-lib.com>

<http://www.404manual.com>

<http://www.luxmanual.com>

<http://aubethermostatmanual.com>

Golf course search by state

<http://golfingnear.com>

Email search by domain

<http://emailbydomain.com>

Auto manuals search

<http://auto.somanuals.com>

TV manuals search

<http://tv.somanuals.com>