

# VPCZ1 Series

## SERVICE MANUAL

Ver 6-2012B

### Revision History

Area	Model	Lineup	Area	Model	Lineup
Japanese	Japanese	VPCZ139FJ/S	Asian/Oceania/ South Africa	International	VPCZ135GG/BI
		VPCZ13ADZ/S			VPCZ136GF/B
		VPCZ13AFJ*			VPCZ136GG/B
		VPCZ13AGJ*			VPCZ137GG/B
		VPCZ13AHJ*			VPCZ138GG/XQ
		VPCZ13BDZ/S		VPCZ139GG/XQ	
		VPCZ13ZHJ*		Korean	VPCZ138GK/XQ
		VPCZ14AFJ*			VPCZ136GK/B
		VPCZ14AGJ*			VPCZ135GK/BI
		VPCZ14AHJ*		Chinese	VPCZ1300C*
VPCZ14ZHJ*	VPCZ135FC/B				
American	US/Canadian	VPCZ133GM/B	VPCZ135FC/R		
		VPCZ133GM/S	VPCZ137FC/B		
		VPCZ133GX/B	VPCZ138GC/B		
		VPCZ133GX/S	VPCZ139GC/X		
		VPCZ134GX/B	Taiwan	VPCZ135GW/BI	
		VPCZ134GX/S		VPCZ136GW/B	
		VPCZ135GX/B		VPCZ138GW/XQ	
		VPCZ135GX/S	Thai	VPCZ136GH/B	
		VPCZ137GX/B		UAE	VPCZ135GA/BI
		VPCZ137GX/S	VPCZ136GA/B		
VPCZ1390X*	VPCZ138GA/XQ				
VPCZ13JGX/B	VPCZ139GA/XQ				
European	AEP/UK	VPCZ130GB/BI	*: CTO Model		
		VPCZ130GL/BI			
		VPCZ1390L*			
		VPCZ1390S*			
		VPCZ13C5E*			
		VPCZ13M9E/B			
		VPCZ13S9R/B			
		VPCZ13V9E/X			
		VPCZ13V9R/X			
		VPCZ13X9R/B			
VPCZ13Z9E/X					
VPCZ13Z9R/XQ					

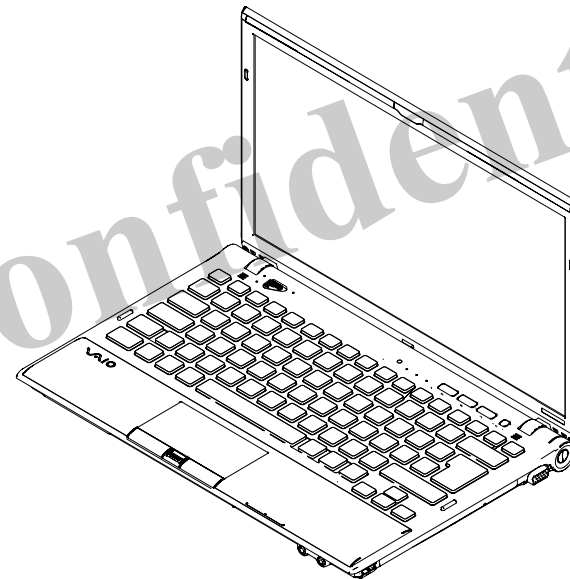

- Design and specifications are subject to change without notice.
- 本機の仕様および外観は、改良のため予告なく変更することがありますが、ご了承ください。

PERSONAL COMPUTER

**SONY**<sup>®</sup>

Information in this document is subject to change without notice.

Sony, VAIO and CLIE are trademarks or registered trademarks of Sony. Microsoft, Windows, Windows Media, Outlook, Bookshelf and other Microsoft products are trademarks or registered trademarks of Microsoft Corporation in the United States and other countries. The word Bluetooth and the Bluetooth logo are trademarks of Bluetooth SIG, Inc. AMD, the AMD logo, other AMD product names and combinations thereof are trademarks of Advanced Micro Devices, Inc. Intel Inside logo, Pentium, Celeron and Core are trademarks or registered trademarks of Intel Corporation. Transmeta, the Transmeta logo, Crusoe Processor, the Crusoe logo and combinations thereof are trademarks of Transmeta Corporation in the USA and other countries. Graffiti, HotSync, PalmModem, and Palm OS are registered trademarks, and the Hotsync logo and Palm are trademarks of Palm, Inc. or its subsidiaries. (M) and Motrola are trademarks of Motorola, Inc. Other Motrola products and services with (R) mark like Dragonball are the trademarks of Motorola, Inc.

All other names of systems, products and services in this manual are trademarks or registered trademarks of their respective owners. In this manual, the (TM) or (R) mark are not specified.

**CAUTION – CLASS 3B VISIBLE AND INVISIBLE LASER RADIATION WHEN OPEN. AVOID EXPOSURE TO THE BEAM.**

The components identified by mark  contain confidential information. Strictly follow the instructions whenever the components are repaired and/or replaced.

Caution Markings for Lithium/Ion Battery - The following or similar texts shall be provided on battery pack of equipment or in both the operating and the service instructions.

CAUTION: Danger of explosion if battery is incorrectly replaced. Replace only with the same or equivalent type recommended by the manufacturer. Discard used batteries according to the manufacturer's instructions.

CAUTION: The battery pack used in this device may present a fire or chemical burn hazard if mistreated. Do not disassemble, heat above 60°C (140°F) or incinerate. Dispose of used battery promptly. Keep away from children.

- CAUTION: Changing the back up battery.
- Overcharging, short circuiting, reverse charging, mutilation or incineration of the cells must be avoided to prevent one or more of the following occurrences; release of toxic materials, release of hydrogen and/or oxygen gas, rise in surface temperature.
  - If a cell has leaked or vented, it should be replaced immediately while avoiding to touch it without any protection.

## Service and Inspection Precautions

### 1. Obey precautionary markings and instructions

Labels and stamps on the cabinet, chassis, and components identify areas requiring special precautions. Be sure to observe these precautions, as well as all precautions listed in the operating manual and other associated documents.

### 2. Use designated parts only

The set's components possess important safety characteristics, such as noncombustibility and the ability to tolerate large voltages. Be sure that replacement parts possess the same safety characteristics as the originals. Also remember that the  mark, which appears in circuit diagrams and parts lists, denotes components that have particularly important safety functions; be extra sure to use only the designated components.

### 3. Always follow the original design when mounting parts and routing wires

The original layout includes various safety features, such as inclusion of insulating materials (tubes and tape) and the mounting of parts above the printer board. In addition, internal wiring has been routed and clamped so as to keep it away from hot or high-voltage parts. When mounting parts or routing wires, therefore, be sure to duplicate the original layout.

### 4. Inspect after completing service

After servicing, inspect to make sure that all screws, components, and wiring have been returned to their original condition. Also check the area around the repair location to ensure that repair work has caused no damage, and confirm safety.

### 5. When replacing chip components...

Never reuse components. Also remember that the negative side of tantalum capacitors is easily damaged by heat.

### 6. When handling flexible print boards...

- The temperature of the soldering-iron tip should be about 270°C.
- Do not apply the tip more than three times to the same pattern.
- Handle patterns with care; never apply force.

Caution: Remember that hard disk drives are easily damaged by vibration. Always handle with care.

### ATTENTION AU COMPOSANT AYANT RAPPORT À LA SÉCURITÉ!

LES COMPOSANTS IDENTIFIÉS PAR UNE MARQUE  SUR LES DIAGRAMMES SCHÉMATIQUES ET LA LISTE DES PIÈCES SONT CRITIQUES POUR LA SÉCURITÉ DE FONCTIONNEMENT. NE REMPLACER CES COMPOSANTS QUE PAR DES PIÈCES SONY DONT LES NUMÉROS SONT DONNÉS DANS CE MANUEL OU DANS LES SUPPLÉMENTS PUBLIÉS PAR SONY.

**Sony Confidential**

VPCZ1 Series (9-890-814-XX)

## TABLE OF CONTENTS

<u>Section</u>	<u>Title</u>	<u>Page</u>	<u>Section</u>	<u>Title</u>	<u>Page</u>
<b>CHAPTER 1. BLOCK DIAGRAM</b>		1-1	<b>CHAPTER 4. OTHERS</b>		
		(to 1-1)	4-1. Precautions for Handling the Drive		4-1
<b>CHAPTER 2. FRAME HARNESS DIAGRAM</b>		2-1	4-2. Note for WAN Board Replacement		4-2
		(to 2-1)	4-3. Note for WiMAX Board Replacement		4-3
<b>CHAPTER 3. EXPLODED VIEWS AND PARTS LIST</b>					(to 4-3)
Note		3-2			
Palmrest					
P-1		3-3			
Main Board					
M-1		3-4			
Bottom					
B-1		3-5			
LCD					
L-1		3-6			
Accessories					
A-1		3-7			
		(to 3-7)			

- SPECIFICATIONS are listed on Page 3-1 of "CHAPTER 3. EXPLODED VIEWS AND PARTS LIST".
- History of the changes is shown as the "Revision History" at the end of this data.

- SPECIFICATIONSは、“CHAPTER 3. EXPLODED VIEWS AND PARTS LIST”の3-1ページに掲載されています。
- 変更履歴は、“ Revision History ”として、本データ末に記載してあります。



# CHAPTER 2. FRAME HARNESS DIAGRAM

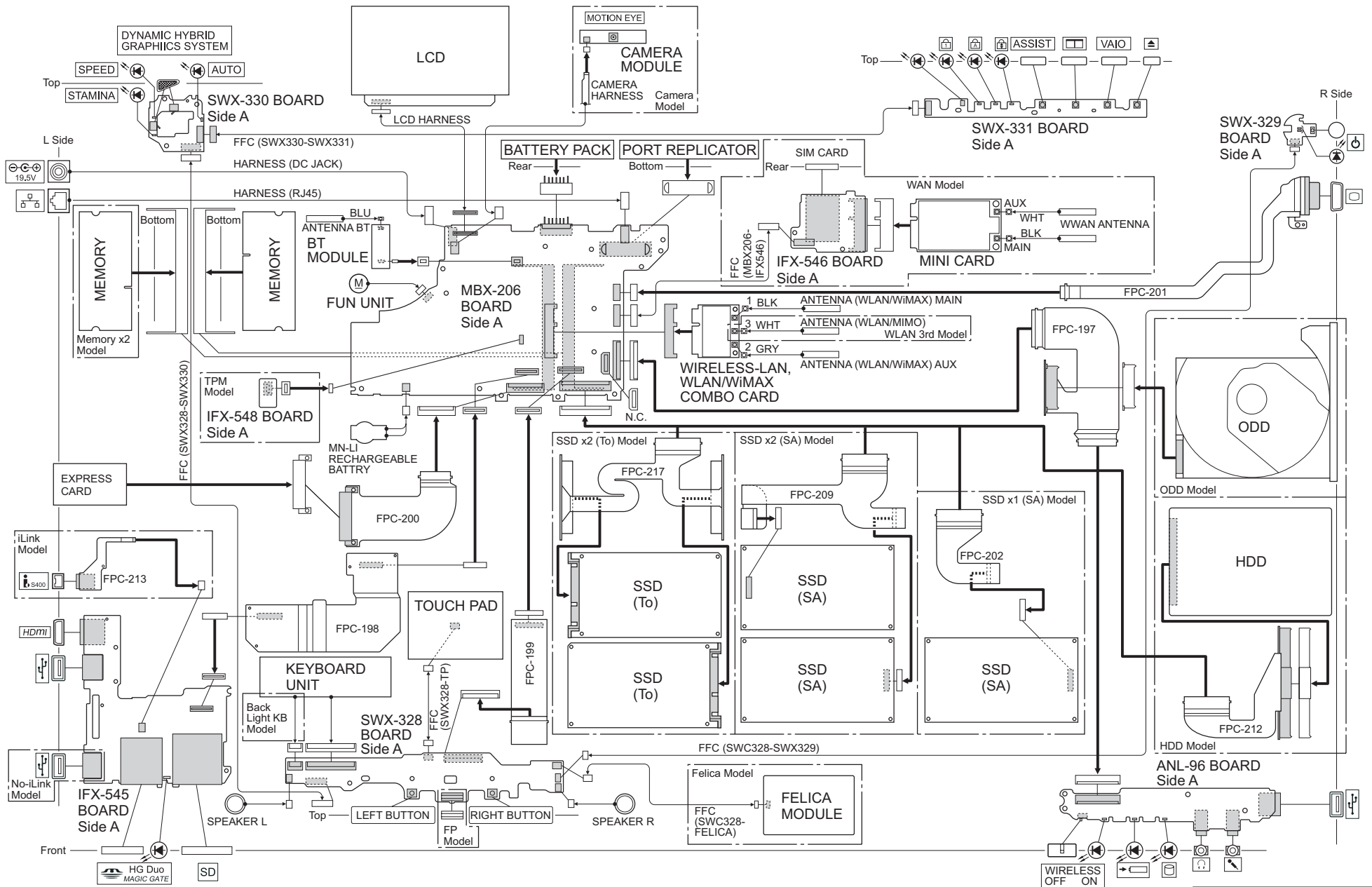

- ➔ From board to connector (direct connection)
- ↔ Harness (connector at both end)
- |— Harness (soldered at one end)

- ➔ 基板からコネクタへ (ダイレクト接続)
- ↔ ハーネス (両端がコネクタ付き)
- |— ハーネス (一方が半田付け)

# CHAPTER 3. EXPLODED VIEWS AND PARTS LIST

• The exploded views and parts list are compiled by blocks.  
The sections are different depending on the model.  
Please refer to list of contents shown.

• 分解図と部品表は、ブロックごとに分かれています。  
機種によってセクションが異なりますので、詳細は一覧表を参照してください。

Section	Page
<b>Note</b> .....	3-2
<b>Palmrest</b>	
P-1 .....	3-3
<b>Main Board</b>	
M-1 .....	3-4
<b>Bottom</b>	
B-1 .....	3-5
<b>LCD</b>	
L-1 .....	3-6
<b>Accessories</b>	
A-1 .....	3-7

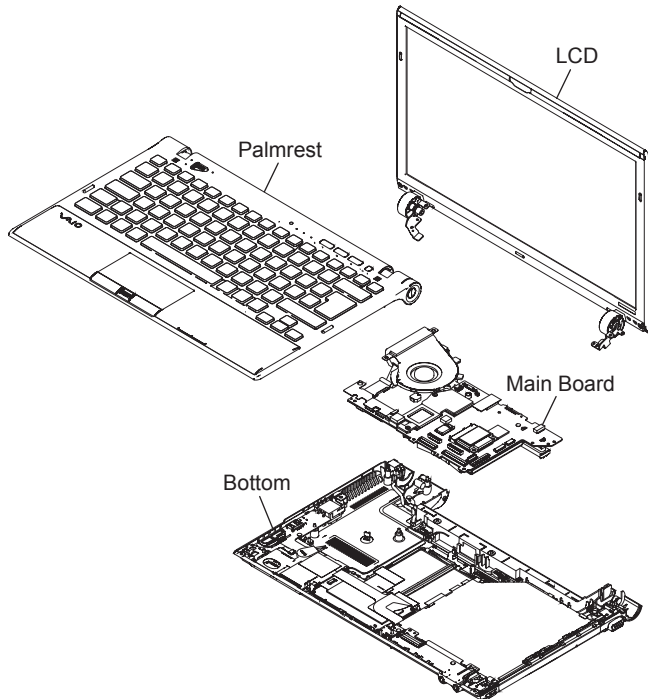

- Double-click on the paper clip mark in the Spec column to open the specifications list.
- Spec欄のクリップマークをダブルクリックすると、スペック表が開きます。
- To open the specifications list, Microsoft office Excel or Excel viewer is required.
- スペック表を開くためには Microsoft Office Excel または Excel ビューワーが必要になります。

	Palmrest	Main Board	Bottom	LCD	Accessories	Spec
J	Z139FJ/S	P-1	M-1	B-1	L-1	A-1
	Z13ADZ/S	P-1	M-1	B-1	L-1	A-1
	Z13BDZ/S	P-1	M-1	B-1	L-1	A-1
	Z13AFJ*	P-1	M-1	B-1	L-1	A-1
	Z14AFJ*	P-1	M-1	B-1	L-1	A-1
	Z13AGJ*	P-1	M-1	B-1	L-1	A-1
	Z14AGJ*	P-1	M-1	B-1	L-1	A-1
	Z13AHJ*	P-1	M-1	B-1	L-1	A-1
	Z13ZHJ*	P-1	M-1	B-1	L-1	A-1
	Z14AHJ*	P-1	M-1	B-1	L-1	A-1
AM	Z137GX/B	P-1	M-1	B-1	L-1	A-1
	Z137GX/S	P-1	M-1	B-1	L-1	A-1
	Z135GX/B	P-1	M-1	B-1	L-1	A-1
	Z135GX/S	P-1	M-1	B-1	L-1	A-1
	Z134GX/B	P-1	M-1	B-1	L-1	A-1
	Z134GX/S	P-1	M-1	B-1	L-1	A-1
	Z133GX/B	P-1	M-1	B-1	L-1	A-1
	Z133GX/S	P-1	M-1	B-1	L-1	A-1
	Z133GM/B	P-1	M-1	B-1	L-1	A-1
	Z133GM/S	P-1	M-1	B-1	L-1	A-1
	Z13JGX/B	P-1	M-1	B-1	L-1	A-1
	Z1390X*	P-1	M-1	B-1	L-1	A-1
	Z130GL/BI	P-1	M-1	B-1	L-1	A-1
	Z130GB/BI	P-1	M-1	B-1	L-1	A-1
	Z1390L*	P-1	M-1	B-1	L-1	A-1
Z1390S*	P-1	M-1	B-1	L-1	A-1	
EU	Z13Z9E/X	P-1	M-1	B-1	L-1	A-1
	Z13V9E/X	P-1	M-1	B-1	L-1	A-1
	Z13M9E/B	P-1	M-1	B-1	L-1	A-1
	Z13Z9R/XQ	P-1	M-1	B-1	L-1	A-1
	Z13V9R/X	P-1	M-1	B-1	L-1	A-1
	Z13X9R/B	P-1	M-1	B-1	L-1	A-1
	Z13S9R/B	P-1	M-1	B-1	L-1	A-1
Z13C5E*	P-1	M-1	B-1	L-1	A-1	

	Palmrest	Main Board	Bottom	LCD	Accessories	Spec
AO	Z139GG/XQ	P-1	M-1	B-1	L-1	A-1
	Z139GA/XQ	P-1	M-1	B-1	L-1	A-1
	Z138GG/XQ	P-1	M-1	B-1	L-1	A-1
	Z138GA/XQ	P-1	M-1	B-1	L-1	A-1
	Z138GW/XQ	P-1	M-1	B-1	L-1	A-1
	Z138GK/XQ	P-1	M-1	B-1	L-1	A-1
	Z137GG/B	P-1	M-1	B-1	L-1	A-1
	Z136GG/B	P-1	M-1	B-1	L-1	A-1
	Z136GH/B	P-1	M-1	B-1	L-1	A-1
	Z136GF/B	P-1	M-1	B-1	L-1	A-1
	Z136GA/B	P-1	M-1	B-1	L-1	A-1
	Z136GW/B	P-1	M-1	B-1	L-1	A-1
	Z136GK/B	P-1	M-1	B-1	L-1	A-1
	Z135GG/BI	P-1	M-1	B-1	L-1	A-1
	Z135GA/BI	P-1	M-1	B-1	L-1	A-1
	Z135GW/BI	P-1	M-1	B-1	L-1	A-1
	Z135GK/BI	P-1	M-1	B-1	L-1	A-1
	Z139GC/X	P-1	M-1	B-1	L-1	A-1
	Z138GC/B	P-1	M-1	B-1	L-1	A-1
	Z137FC/B	P-1	M-1	B-1	L-1	A-1
Z135FC/B	P-1	M-1	B-1	L-1	A-1	
Z135FC/R	P-1	M-1	B-1	L-1	A-1	
Z1300C*	P-1	M-1	B-1	L-1	A-1	

\*: CTO Model

**Sony Confidential**

VPCZ1 Series (9-890-814-XX)

## Note

- Parts List is attached on the upper right portion of each EXPLODED VIEW.
- Items marked “ \* ” are not stocked since they are seldom required for routine service. Some delay should be anticipated when ordering these items.
- The parts marked “ \$ ” are the Reuse Parts.
- The parts marked with “&” indicates specific parts handling for Japan region. Disregard “&” marking for other than Japan region.
- Color after discription in [ ] shows color variation name of the main body.
- The model that is accompanied asterisk (\*) is the CTO model.
- Description of [\*\*\*MBx2], [\*\*\*MB], [\*\*\*GBx2], [\*\*\*GB]...indicates the following.  
\*\*\*MB/\*\*\*GB: size of the part  
x2: installed quantity at original production
- Be sure to use the parts marked with ●x/□x together with the parts with the same number.
- When replacing the HDD of RAID setting, please exchange to the same HDD that was installed.

Basically, the parts marked “●” should be used for service.  
The parts marked “□” in the parts list are substitution parts.  
If the part marked “●” is not available, you can order the parts marked “□”, but it may not be stocked.

The components identified by mark ! or dotted line with mark ! are critical for safety. Replace only with part number specified.

Les composants identifiés par une marque ! sont critiques pour la sécurité. Ne les remplacer que par une pièce portant le numéro spécifié.

The components identified by mark Ⓔ contain confidential information. Strictly follow the instructions whenever the components are repaired and/or replaced.

- 部品表は、各分解図の右上部に添付されています。
- \*印の部品は常備在庫しておりません。
- 部品名称の前に\$印のついた部品は、Reuse Partsです。
- 部品名称の前に&印のついた部品は、お客様でも交換可能なCustomer Replacable Parts (CRP)であり、販売可能です。  
特に&印のついた部品は、使い分けが必要な部品ですので、必ず分解図で対象部品をご確認ください。
- 部品名称の後に[ ]で色が示されている場合、Bodyのカラーバリエーション名称を表わしています。
- 機種名に(\*)がつくものはCTOモデルです。
- 部品名の[\*\*\*MBx2], [\*\*\*MB], [\*\*\*GBx2], [\*\*\*GB] 等々は以下を表わしています。  
\*\*\*MB/\*\*\*GB: この部品の容量  
x2: 出荷時に搭載されている員数
- x/□xになっている部品は、同じ数字どうしで必ず一緒に使用してください。
- RAID設定のHDDを交換する際は、搭載されていたHDDと同じものに交換してください。

部品表中“□”のついた部品は、代替部品です。基本は●印の部品を使用してください。  
●印の部品が無い場合は、□印の部品をオーダーすることも可能ですが、在庫されていない場合があります。

!印の部品、または!印付きの点線で囲まれた部品は、安全性を維持するために重要な部品です。従って交換時は、必ず指定の部品を使用してください。

Ⓔ印の部品には、秘密情報が含まれています。修理の際は、指示に従った対応を行なってください。

- If there is the Remarks column in the parts list, the features of applicable models are indicated in it for the parts that are different depending on each model. For the abbreviations used in the remarks column, please refer to the <table 1>.
- 部品表にRemarks欄がある場合、使い分けが生じる部品について、判別の目安となる対応モデルの特徴を示しています。  
記述の省略方法については<table 1>を参照ください。

<table 1>

Full-Name	Short-Name
Bluetooth	BT
Felica	Felica
Wireless WAN	WAN
Wireless LAN	WLAN
1seg Tuner	1seg
Finger Print Sensor	FP
Security Chip	TPM
Flash Memory	SSD
Camera	Camera

- If "No-" is described on the left side of the Short-Name, it means 'not equipped'.  
Example: "No-BT" "No-Felica" etc.
- When several descriptions are listed, each description is separated with “, (comma)” or “ or”. “Comma” means plus.  
Example.1: The parts for the model equipped with BT and Felica and WLAN → BT, Felica, WLAN  
Example.2: The parts for the model equipped with BT or Felica → BT or Felica
- If the color is in the remarks column, it indicates the color of parts itself.
- 「無し」を表現する場合には、Short-Nameの左に「No-」とつけます。  
例)「No-BT」「No-Felica」など
- 注記を複数記載する際には、「(カンマ)」又は「or」で区切ります。「, (カンマ)」はプラスという意味として使います。  
例1) BTとFelicaとWLANが搭載されたモデルにつく部品 → BT, Felica, WLAN  
例2) BT搭載モデル又はFelica搭載モデルにつく部品 → BT or Felica
- 色表記の場合、該当の部品自体の色を示します。

**Sony Confidential**

VPCZ1 Series (9-890-814-XX)

# P-1. Palmrest

## Parts List

- Double-click on the paper clip mark to open the parts list.
- クリップマークをダブルクリックすると、部品表が開きます。
- To open the parts list, Microsoft office Excel or Excel viewer is required.
- 部品表を開くためには Microsoft Office Excel または Excel ビューワーが必要です。

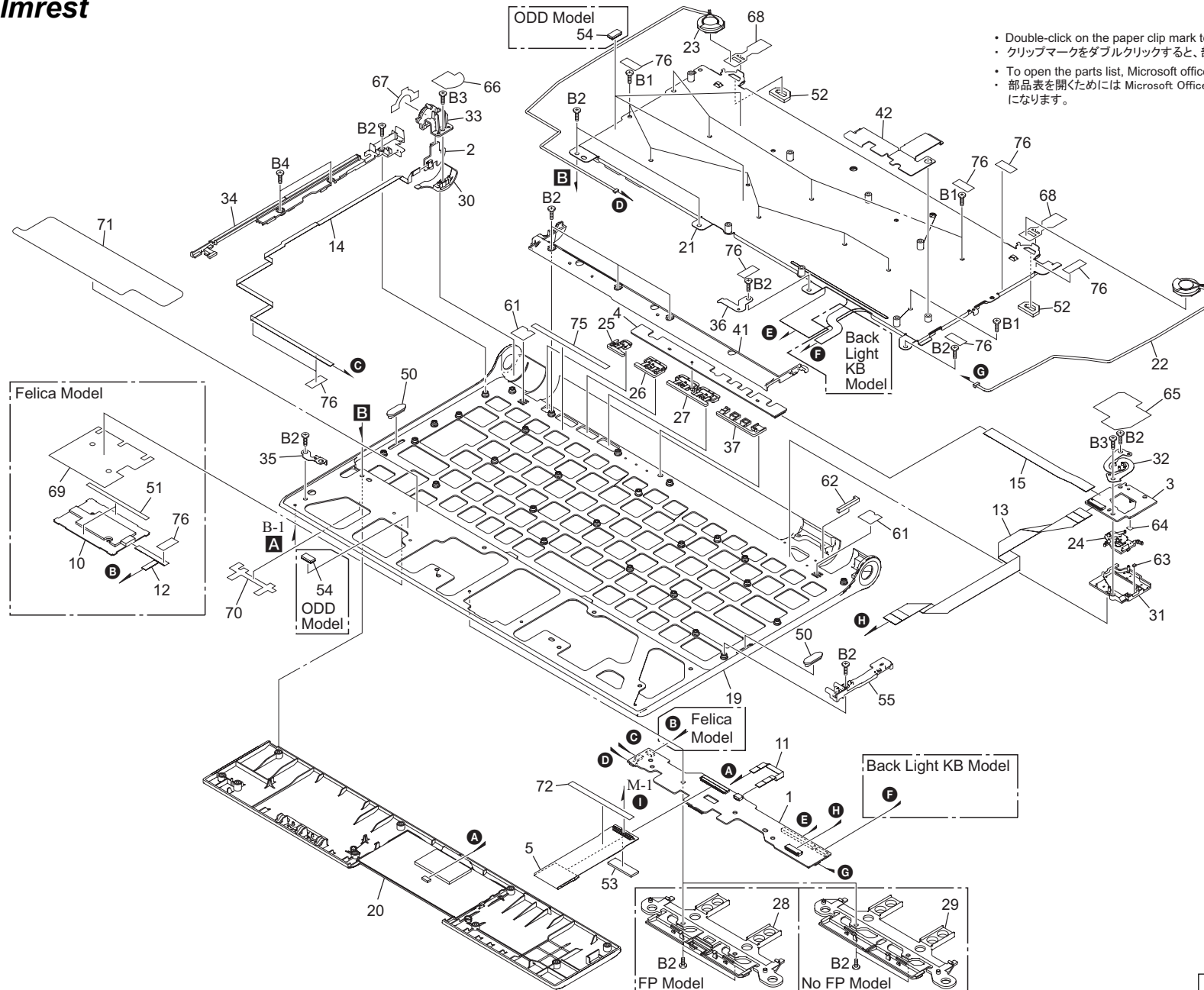



# M-1. Main Board

## Parts List

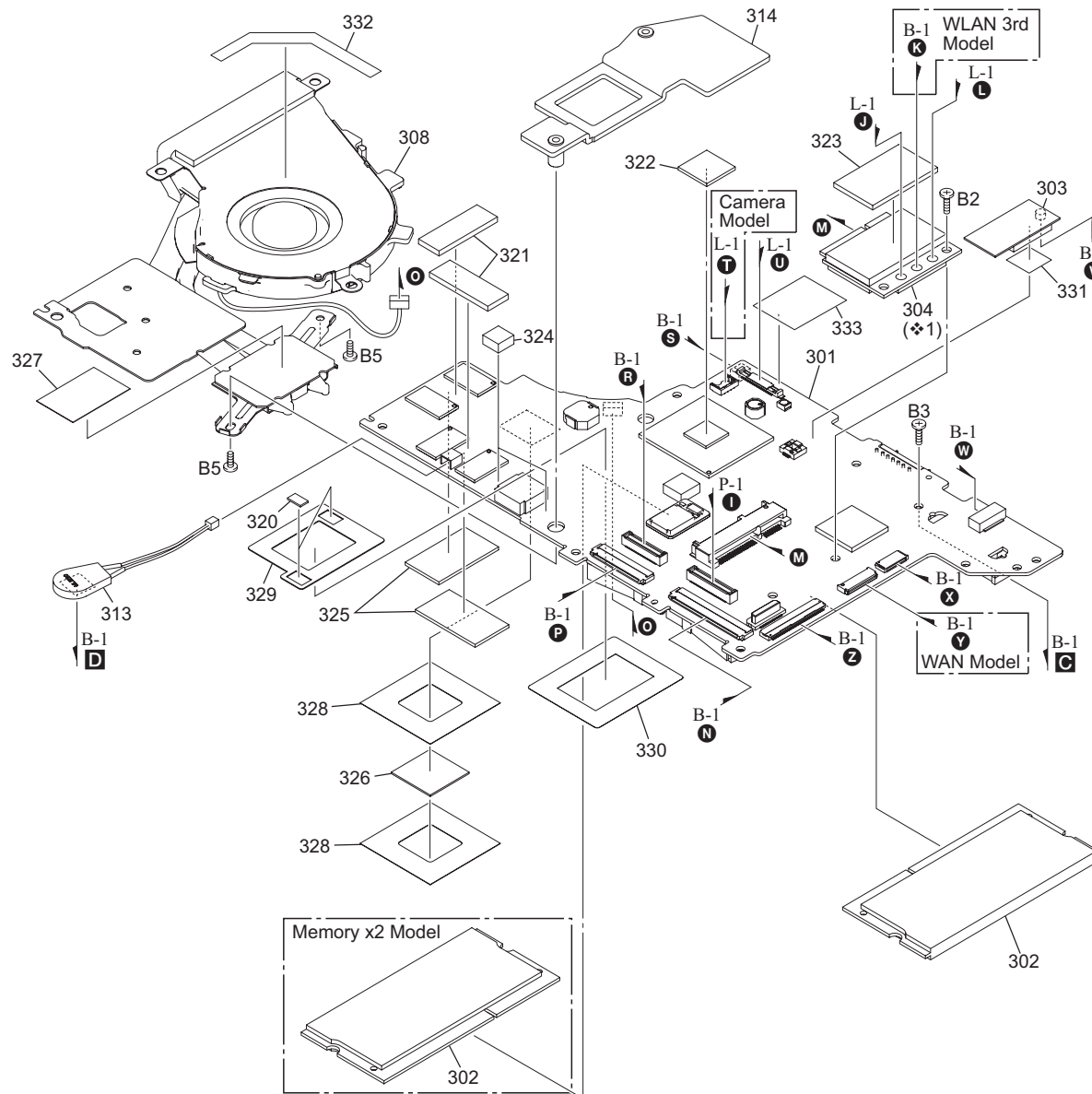

- Double-click on the paper clip mark to open the parts list.
- クリップマークをダブルクリックすると、部品表が開きます。
- To open the parts list, Microsoft office Excel or Excel viewer is required.
- 部品表を開くためには Microsoft Office Excel または Excel ビューワーが必要になります。

- ❖1) When replacing the WiMAX board (Ref. 304), be sure to refer to "4-3. Note for WAN Board Replacement".
- ❖1) WiMAX基板(Ref. 304)を交換する際には、必ず「4-3. WiMAX 基板交換時の注意」を参照してください。

**Sony Confidential**

VPCZ1 Series (9-890-814-XX)

# B-1. Bottom

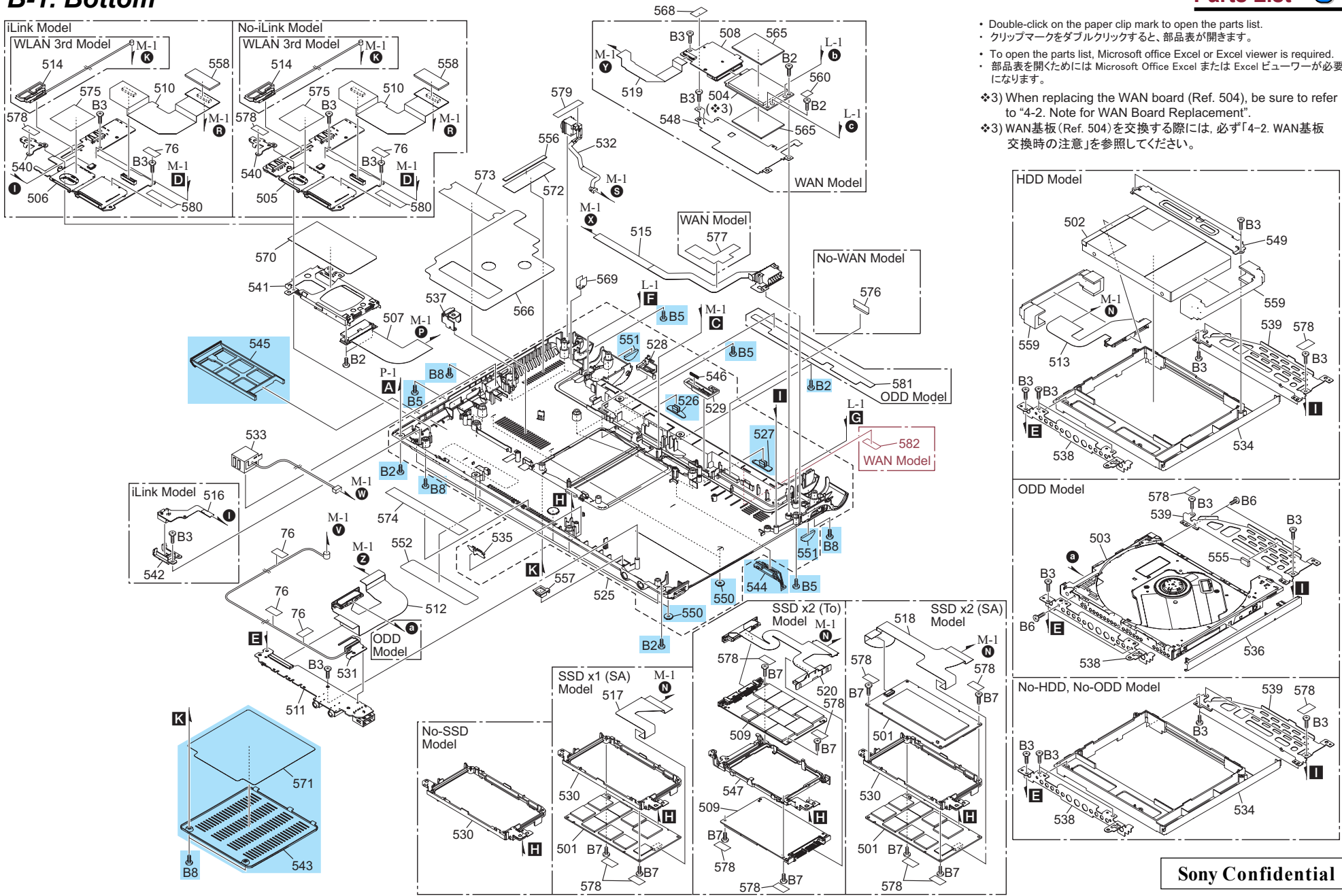

- Double-click on the paper clip mark to open the parts list.
  - クリップマークをダブルクリックすると、部品表が開きます。
  - To open the parts list, Microsoft office Excel or Excel viewer is required.
  - 部品表を開くためには Microsoft Office Excel または Excel ビューワーが必要になります。
- ❖3) When replacing the WAN board (Ref. 504), be sure to refer to "4-2. Note for WAN Board Replacement".
- ❖3) WAN基板 (Ref. 504) を交換する際には、必ず「4-2. WAN基板交換時の注意」を参照してください。

# L-1. LCD

## Parts List

- Double-click on the paper clip mark to open the parts list.
- クリップマークをダブルクリックすると、部品表が開きます。
- To open the parts list, Microsoft office Excel or Excel viewer is required.
- 部品表を開くためには Microsoft Office Excel または Excel ビューワーが必要です。

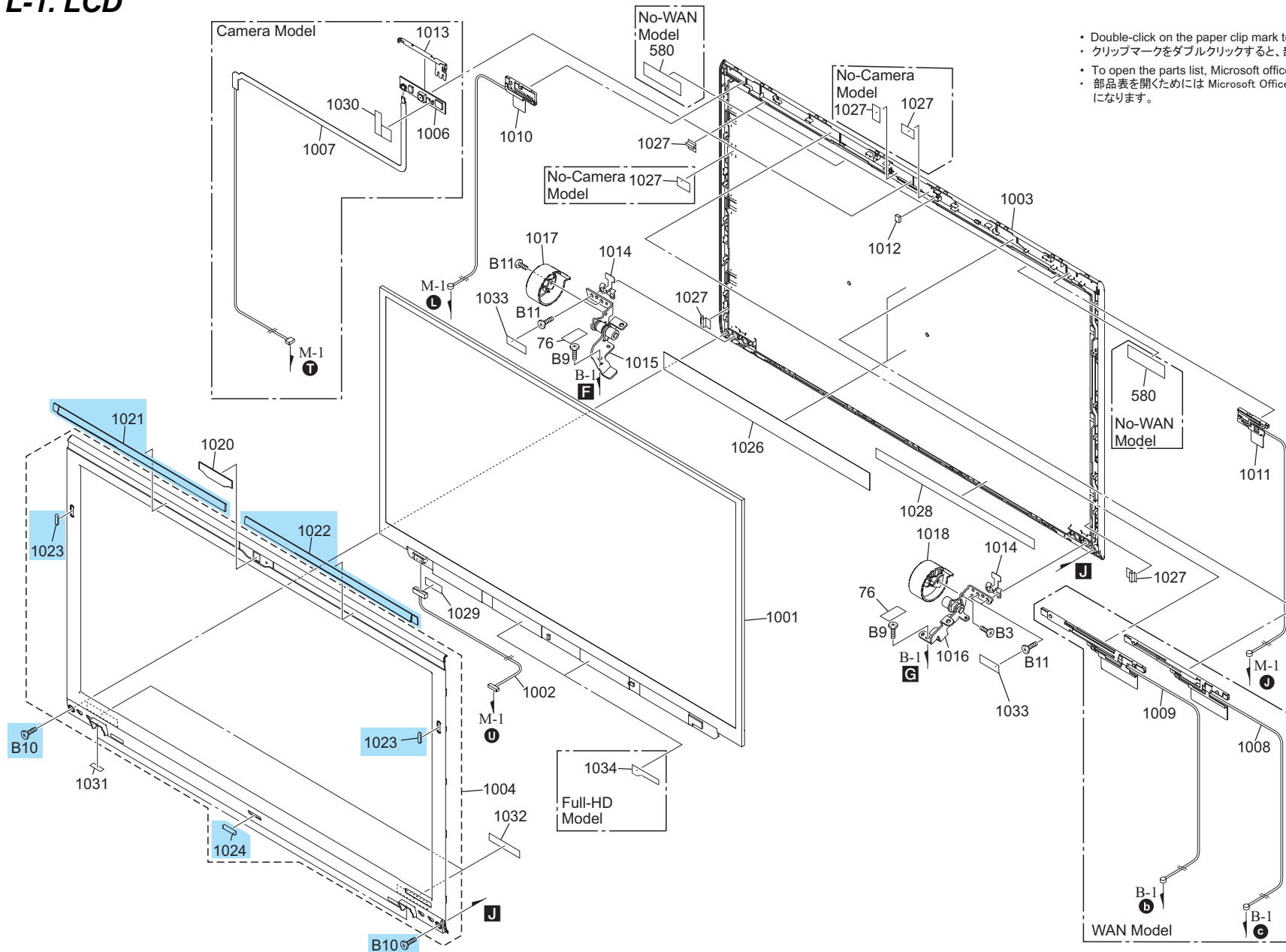

**Sony Confidential**

VPCZ1 Series (9-890-814-XX)

# A-1. Accessories

## Parts List

- Double-click on the paper clip mark to open the parts list.
- クリップマークをダブルクリックすると、部品表が開きます。
- To open the parts list, Microsoft office Excel or Excel viewer is required.
- 部品表を開くためには Microsoft Office Excel または Excel ビューワーが必要になります。

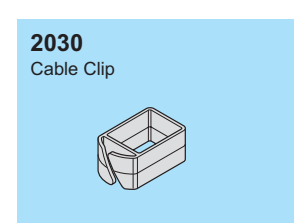
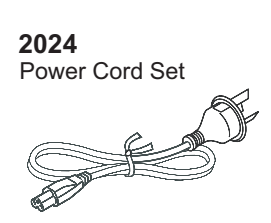
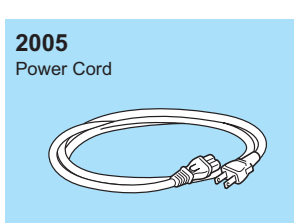
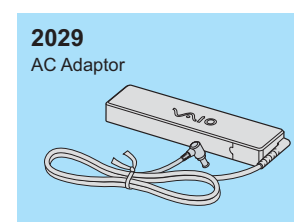
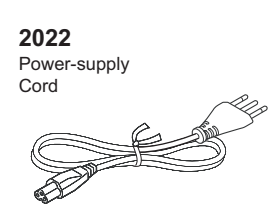
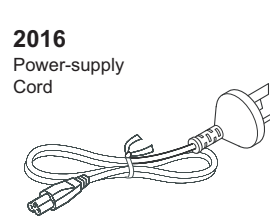
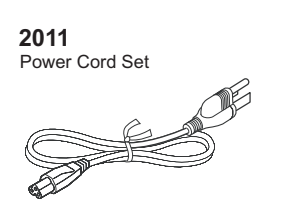
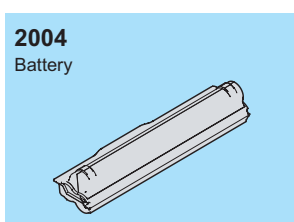
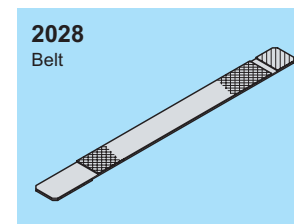
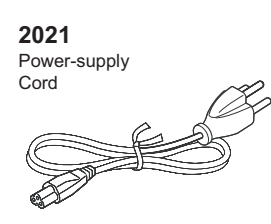
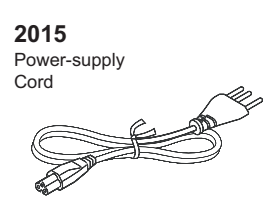
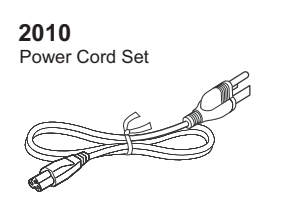
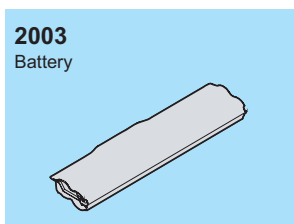
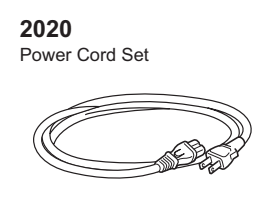
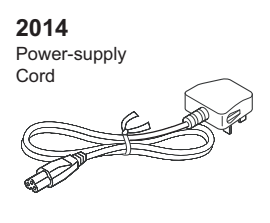
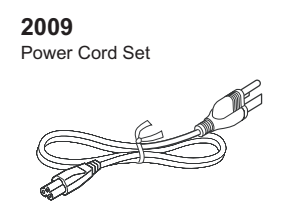
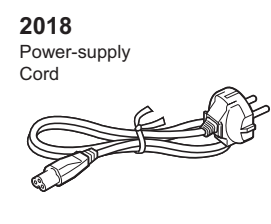
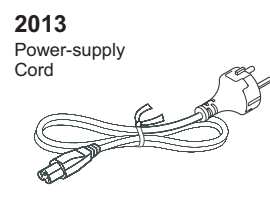
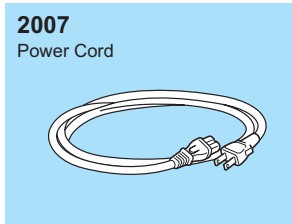
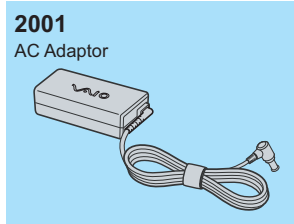

3-7  
(END)

## CHAPTER 4. OTHERS

### 4-1. Precautions for Handling the Drive

In performing a repair, observe the following precautions.

修理の際には以下の注意事項を厳守してください。

- ① Do not turn the power switch on until the palmrest and the keyboard are installed completely.
- ① パームレストやキーボードを完全に取り付けるまでは電源を入れないでください。

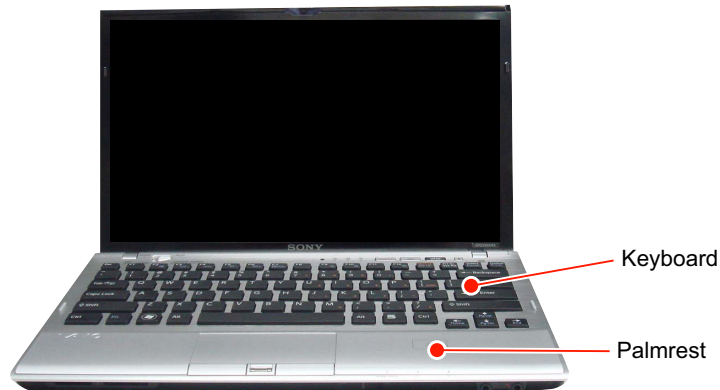

- ② If the power switch is to be turned on with the set in disassembled state, be sure to load a dummy disc in the drive.
- ② 分解した状態で電源を入れる必要がある場合には“必ず” ダミーのディスクをドライブにセットしておいてください。



- ③ If the power switch is to be turned on with the set in disassembled state for checking the drive condition, be sure to turn the power switch on with the tray drawn out.
- ③ 分解した状態で電源を入れ、ドライブの状態を確認する必要がある場合には“必ず” トレーを引き出した状態で電源を入れてください。

Tray drawn-out state  
トレイが引き出された状態



**Sony Confidential**

VPCZ1 Series (9-890-814-XX)

## 4-2. Note for WAN Board Replacement

### 4-2. WAN 基板交換時の注意

When replacing the WAN Board (Ref. 504 1-458-165-23, 1-458-205-23), change the barcode label on the bottom.

WAN 基板 (Ref. 504 1-458-165-23, 1-458-205-23) を交換した際には、ボトムのパールコードラベルの貼り替え作業を行ってください。

① Peel off the barcode label which is attached to the bottom. (Refer to the figure below.)

① ボトムに貼られているパールコードラベルをはがします。(下図参照)

Ref. 504

1-458-165-23, 1-458-205-23 FOX MINI CARD



IMEI : XXXXXXXXXXXXXXXXX

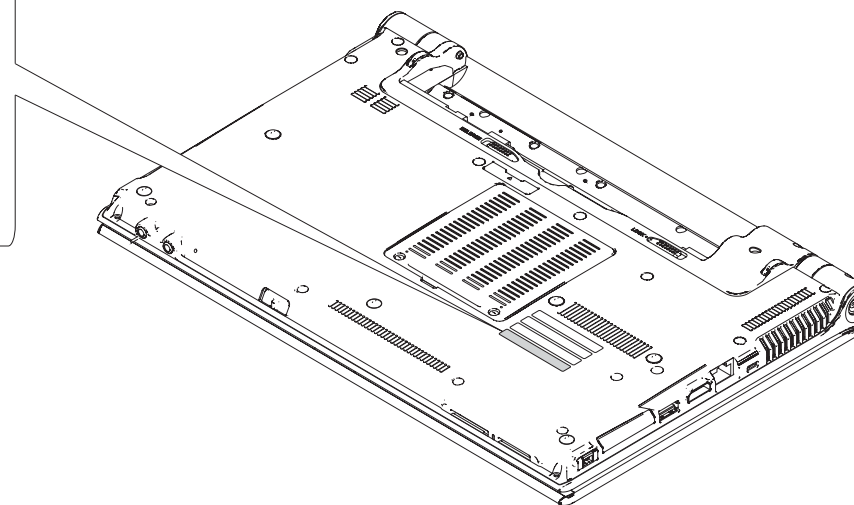

② Attach the barcode label which is included with the WAN Board to the position where you peeled off the label in the step ①.

② WAN 基板に同梱されているパールコードラベルを①ではがした位置に貼ってください。

**Sony Confidential**

VPCZ1 Series (9-890-814-XX)

## 4-3. Note for WiMAX Board Replacement

### 4-3. WiMAX基板交換時の注意

When replacing the WiMAX Board (Ref. 304 A-1769-477-A, A-1769-478-A, A-1793-236-A, A-1808-157-A) change the barcode label on the bottom.

WiMAX基板 (Ref. 304 A-1769-477-A, A-1769-478-A, A-1793-236-A, A-1808-157-A) を交換した際には、ボトムのパターンラベルの貼り替え作業を行ってください。

- ① Peel off the barcode label which is attached to the bottom. (Refer to the figure below.)
- ① ボトムに貼られているパターンラベルをはがします。(下図参照)

Ref. 304  
A-1769-477-A, A-1769-478-A, A-1793-236-A, A-1808-157-A  
WLAN/WiMAX COMBO CARD

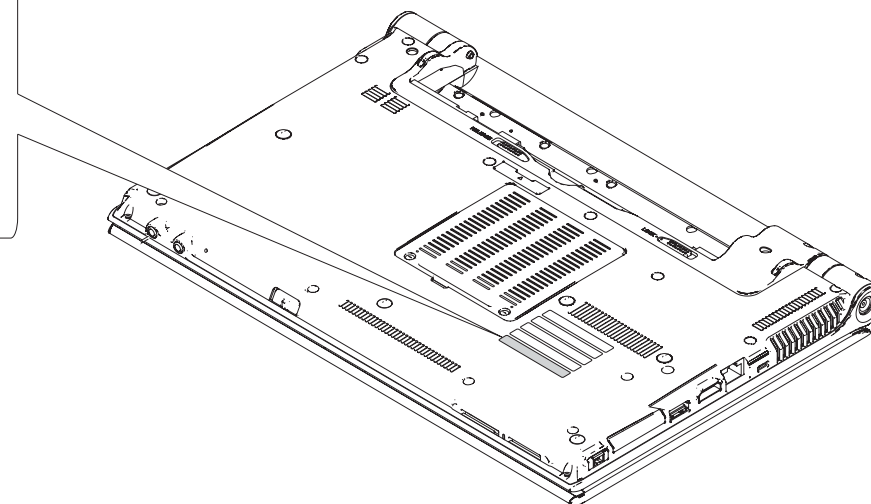
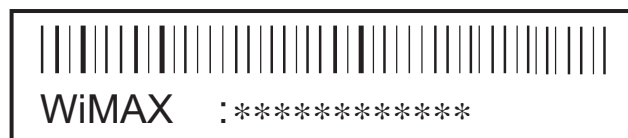

- ② Attach the barcode label which is included with the WiMAX Board to the position where you peeled off the label in the step ①.
- ② WiMAX 基板に同梱されているパターンラベルを①ではがした位置に貼ってください。

This manual and the constituent data may not be replicated, copied nor reprinted in whole or in part without prior written authorization of Sony Corporation.

本マニュアルの一部、または全部について、無断でデータの複製、複写、転載することを禁じます。



## Revision History

Suffix	Ver.	Date	Contents	QM No.
-01	Ver. 1	2010.09.08	First Edition	-
-02	Ver. 2	2010.10.01	[MA] Front Page, Page 2-1, Page 3-1, Page 3-3, Page 3-4, Page 3-5, Page 3-6, Page 3-7, Page 4-3, Back Cover	-
-03	Ver. 3	2010.10.22	[MA] Front Page, Page 3-1, Page 3-3, Page 3-4, Page 3-5, Page 3-6, Page 3-7, Page 4-2	-
			[DEL] Page 3-5	-
-04	Ver. 4	2010.11.22	[MA] Front Page, Page 3-1, Page 3-3, Page 3-4, Page 3-5, Page 3-6, Page 3-7	-
			Page 3-6	N2010_048CK
			[ADD] Page 3-6	-
-05	Ver. 5	2010.12.20	[MA] Front Page, Page 3-1, Page 3-3, Page 3-4, Page 3-5, Page 3-6, Page 3-7, Page 4-3	-
			[ADD] [CHG] [DEL] Page 3-4, Page 3-5	-
-06	Ver. 6	2012.02.17	Page 3-5	N2011_003CK
			Page 3-6	N2011_019CK
			Page 3-6	N2011_033CK
<Remarks>				

## Free Manuals Download Website

<http://myh66.com>

<http://usermanuals.us>

<http://www.somanuals.com>

<http://www.4manuals.cc>

<http://www.manual-lib.com>

<http://www.404manual.com>

<http://www.luxmanual.com>

<http://aubethermostatmanual.com>

Golf course search by state

<http://golfingnear.com>

Email search by domain

<http://emailbydomain.com>

Auto manuals search

<http://auto.somanuals.com>

TV manuals search

<http://tv.somanuals.com>