

Precautions

On safety

- As the laser beam used in the CD player section is harmful to the eyes, do not attempt to disassemble the casing. Refer servicing to qualified personnel only.
- Should any solid object or liquid fall into the player, unplug the player, and have it checked by qualified personnel before operating it any further.
- Discs with non-standard shapes (e.g., heart, square, star) cannot be played on this player. Attempting to do so may damage the player. Do not use such discs.

Cleaning the cabinet

- Clean the cabinet, panel and controls with a soft cloth slightly moistened with a mild detergent solution. Do not use any type of abrasive pad, scouring powder, or solvent, such as alcohol or benzine.

On power sources

- For AC operation, check that the player’s operating voltage is identical with your local power supply (see “Specifications”) and use the supplied mains lead; do not use any other type. The voltage selector is located at the bottom of the player (Saudi Arabian model only).
- The player is not disconnected from the AC power source (mains) as long as it is connected to the wall outlet, even if the player itself has been turned off.
- For battery operation, use six R20 (size D) batteries.
- When the batteries are not to be used, remove them to avoid damage that can be caused by battery leakage or corrosion.
- The nameplate indicating operating voltage, power consumption, etc. is located at the bottom.

On placement

- Do not leave the player in a location near heat sources, or in a place subject to direct sunlight, excessive dust or mechanical shock.
- Do not place the player on an inclined or unstable place.
- Do not place anything within 10 mm of the side of the cabinet. The ventilation holes must be unobstructed for the player to operate properly and prolong the life of its components.
- If the player is left in a car parked in the sun, be sure to choose a location in the car where the player will not be subjected to the direct rays of the sun.
- Since a strong magnet is used for the speakers, keep personal credit cards using magnetic coding or spring-wound watches away from the player to prevent possible damage from the magnet.

On operation

- If the player is brought directly from a cold to a warm location, or is placed in a very damp room, moisture may condense on the lenses inside the CD player section. Should this occur, the player will not operate properly. In this case, remove the CD and wait about an hour for the moisture to evaporate.
- If the player has not been used for a long time, set it in the playback mode to warm it up for a few minutes before inserting a cassette.

Notes on cassettes

- Break off the cassette tab from side A or B to prevent accidental recording. If you want to reuse the tape for recording, cover the broken tab with adhesive tape.

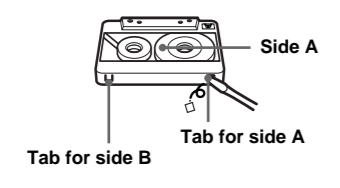

- The use of a cassette with more than 90 minutes of play time is not recommended except for long, continuous recording or playback.

Notes on CDs

- Before playing, clean the CD with a cleaning cloth. Wipe the CD from the center out.

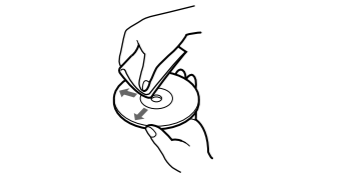

- Do not use solvents such as benzine, thinner, commercially available cleaners or anti-static spray intended for vinyl LPs.
- Do not expose the CD to direct sunlight or heat sources such as hot air ducts, nor leave it in a car parked in direct sunlight as there can be a considerable rise in temperature inside the car.
- Do not stick paper or sticker on the CD, nor scratch the surface of the CD.
- After playing, store the CD in its case. If there is a scratch, dirt or fingerprints on the CD, it may cause tracking error.

About CD-Rs/CD-RWs

This player can play CD-Rs/CD-RWs recorded in the CD-DA format*, but playback capability may vary depending on the quality of the disc and the condition of the recording device.

* CD-DA is the abbreviation for Compact Disc Digital Audio. It is a recording standard used for Audio CDs.

Music discs encoded with copyright protection technologies

This product is designed to play back discs that conform to the Compact Disc (CD) standard. Recently, various music discs encoded with copyright protection technologies are marketed by some record companies. Please be aware that among those discs, there are some that do not conform to the CD standard and may not be playable by this product.

If you have any questions or problems concerning your player, please consult your nearest Sony dealer.

Troubleshooting

General

The power does not come on.

- Make sure the batteries are inserted correctly.
- Replace all the batteries with new ones if they are weak.
- You cannot turn on the player with the remote when you operate the player on batteries.

The power is not on, and “bAttErY” and “Error” are displayed alternately.

- Make sure the batteries are inserted correctly.
- Replace all the batteries with new ones if they are weak.

There is no audio.

- Adjust the volume.
- Unplug the headphones when listening through speakers.

Noise is heard.

- Someone is using a portable telephone or other equipment that emits radio waves near the player. →Move the portable telephone, etc., away from the player.

CD Player

The CD does not play or “no DISC” lights in the display even when a CD is in place.

- Place the CD with the label surface up.
- Clean the CD.
- Take out the CD and leave the CD compartment open for about an hour to dry moisture condensation.
- The CD-R/CD-RW was not finalized. Finalize the CD-R/CD-RW with the recording device.
- There is a problem with the quality of the CD-R/CD-RW, recording device or application software.
- Replace all the batteries with new ones if they are weak.

The sound drops out.

- Reduce the volume.
- Clean the CD, or replace it if the CD is badly damaged.
- Place the player in a location free from vibration.
- Clean the lens with a commercially available blower.
- The sound may drop out or noise may be heard when using poor quality CD-Rs/CD-RWs or if there is a problem with the recording device or application software.

Radio

Reception is poor.

- Reorient the aerial to improve FM reception.



- Reorient the player itself to improve AM or MW/LW reception.

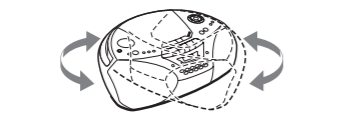

The audio is weak or has poor quality.

- Replace all the batteries with new ones if they are weak.
- Move the player away from the TV.

The picture of your TV becomes unstable.

- If you are listening to an FM programme near the TV with an indoor aerial, move the player away from the TV.

Tape Player

The tape does not move when you press an operation button.

- Close the cassette compartment securely.

The REC button does not function or the tape does not play or record.

- Make sure the safety tab on the cassette is in place.

Poor or distorted playback, recording or erasing quality.

- Clean the heads, pinch roller and capstan with a cleaning swab slightly moistened with cleaning fluid or alcohol.
- Replace all the batteries with new ones if they are weak.
- TYPE II (high position) or TYPE IV (metal) tape is being used. Use TYPE I (normal) tape only.
- Demagnetize the heads using a commercially available tape head demagnetizer.

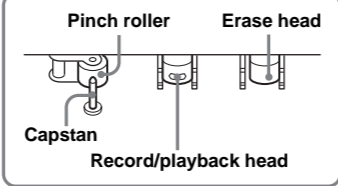
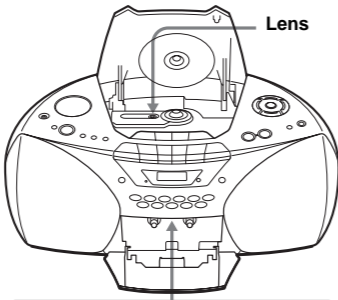

Remote

The remote does not function.

- Replace all the batteries in the remote with new ones if they are weak.
- Make sure that you are pointing the remote at the remote sensor on the player.
- Remove any obstacles in the path of the remote and the player.
- Make sure the remote sensor is not exposed to strong light such as direct sunlight or fluorescent lamp light.
- Move closer to the player when using the remote.

After trying the above remedies, if you still have problems, unplug the mains lead and remove all the batteries. After all the indications in the display disappear, plug the mains lead and insert the batteries again. If the problem persists, please consult your nearest Sony dealer.

Specifications

CD player section

System
Compact disc digital audio system
Laser diode properties
Material: GaAlAs
Wave length: 780 nm
Emission duration: Continuous
Laser output: Less than 44.6 μW
(This output is the value measured at a distance of about 300 mm from the objective lens surface on the optical pick-up block with 7 mm aperture.)

Spindle speed

200 r/min (rpm) to 500 r/min (rpm) (CLV)

Number of channels

2

Frequency response

20 - 20 000 Hz +1/−2 dB

Wow and flutter

Below measurable limit

Radio section

Frequency range

CFD-S550

FM 87.5 - 108 MHz

AM 531 - 1 611 kHz (9 kHz step)
530 - 1 610 kHz (10 kHz step)

CFD-S550L

FM 87.5 - 108 MHz

MW 531 - 1 611 kHz (9 kHz step)
530 - 1 610 kHz (10 kHz step)

LW 153 - 279 kHz

IF

FM: 10.7 MHz
AM/MW/LW: 450 kHz

Aerials

FM: Telescopic aerials
AM/MW/LW: Built-in ferrite bar aerials

Cassette-corder section

Recording system

4-track 2 channel stereo

Fast winding time

Approx. 120 s (sec.) with Sony cassette C-60

Frequency response

TYPE I (normal): 80 - 10 000 Hz

General

Speaker

Full range: 10 cm dia., 3.2 Ω, cone type (2)

Input

LINE IN jack (stereo minijack) (CFD-S550L only):
Minimum input level 330 mV

Outputs

Headphones jack (stereo minijack):

For 16 - 68 Ω impedance headphones
OPTICAL DIGITAL OUT (CD) (Optical output connector) (CFD-S550L only):

Wavelength: 630 - 690 nm

Maximum Power output

5.2 W

Power requirements

For CD radio cassette-corder:

Korean model:

220V AC, 60 Hz

Saudi Arabian model:

110 - 127V, 220 - 240V AC selectable, 50/60 Hz

Other models:

230V AC, 50 Hz

9 V DC, 6 R20 (size D) batteries

For remote control:

3 V DC, 2 R6 (size AA) batteries

Power consumption

AC 20 W

Battery life

For CD radio cassette-corder:

FM recording

Sony R20P: approx. 13.5 h

Sony alkaline LR20: approx. 20 h

Tape playback

Sony R20P: approx. 7.5 h

Sony alkaline LR20: approx. 15 h

CD playback

Sony R20P: approx. 2.5 h

Sony alkaline LR20: approx. 7 h

Dimensions

Approx. 386 × 173 × 269 mm (w/h/d)

(15 ½ × 6 ¾ × 10 ¾ inches) (incl. projecting parts)

Mass

Approx. 3.5 kg (7 lb. 11 oz) (incl. batteries)

Supplied accessory

Mains lead (1)

Remote control (1)

Design and specifications are subject to change without notice.

Optional accessories

Sony MDR headphone series

SONY

CD Radio Cassette-Corder

Operating Instructions

English

WARNING

To prevent fire or shock hazard, do not expose the player to rain or moisture.

To avoid electrical shock, do not open the cabinet. Refer servicing to qualified personnel only.

WARNING

Do not install the appliance in a confined space, such as a bookcase or built-in cabinet.

To prevent fire or shock hazard, do not place objects filled with liquids, such as vases, on the appliance.

Notice for customers in the United Kingdom

A moulded plug complying with BS 1363 is fitted to this equipment for your safety and convenience.

Should the fuse in the plug supplied need to be replaced, same rating fuse approved by ASTA or BSI to BS 1362, (i.e. marked with ⚡ or ⚡ mark) must be used.

If the plug supplied with this equipment has a detachable fuse cover, be sure to attach the fuse cover after you change the fuse. Never use the plug without the fuse cover. If you should lose the fuse cover, please contact your nearest Sony service station.

Sony Corporation ©2002

3-249-673-41 (1)

Power Sources

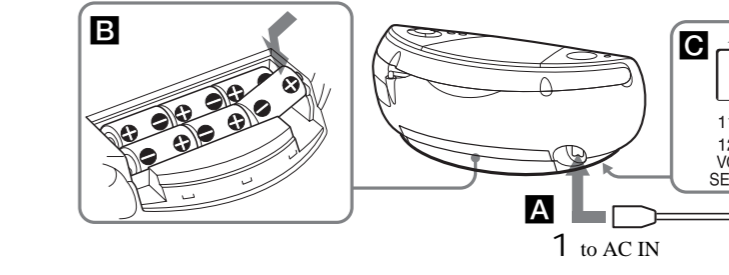

Connect the mains lead **A** or insert six R20 (size D) batteries (not supplied) into the battery compartment **B**.

Notes

- Replace the batteries when the OPR/BATT indicator dims or when the player stops operating. Replace all the batteries with new ones. Before you replace the batteries, be sure to take out the CD from the player.
- To use the player on batteries, disconnect the mains lead from the player.
- When you operate the player on batteries, you cannot turn on the player using the remote.

Saudi Arabian model only: Adjusting the voltage **C**

Be sure to set the VOLTAGE SELECTOR (at the bottom) to your local power supply.

Tip

Only for the customers supplied with an AC plug adaptor:

Use the supplied AC plug adaptor if the plug of the mains lead does not match your outlet.

Preparing the remote **D**

Insert two R6 (size AA) batteries (not supplied).

Replacing battery

With normal use, the batteries should last for about six months. When the remote no longer operates the player, replace all the batteries with new ones.

http://www.sony.net/



Location of controls

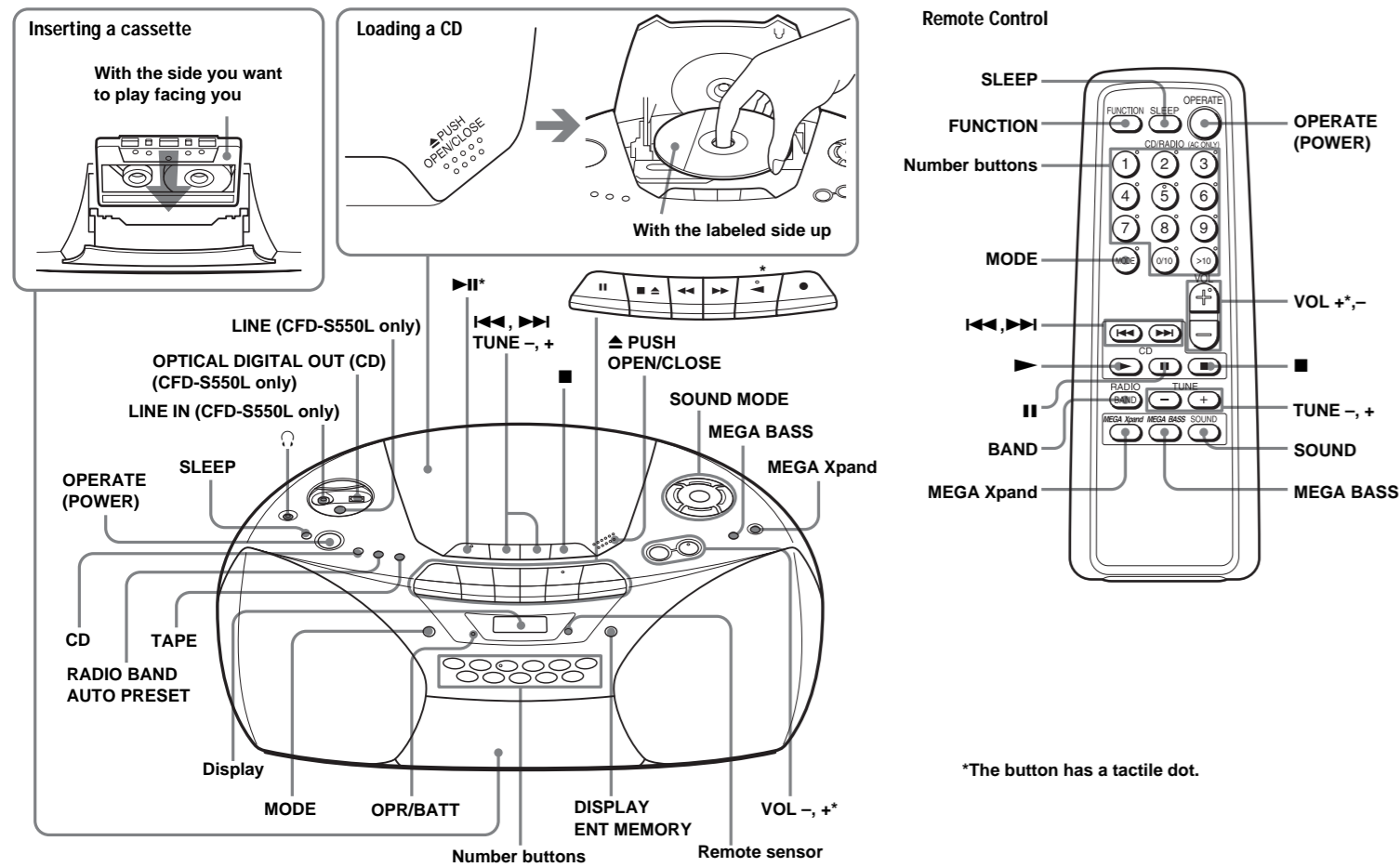

To turn on/off the power

CFD-S550L: Press OPERATE.
CFD-S550: Press POWER.

To adjust the volume

Press VOL +, -.

To listen through headphones

Connect the headphones to the (headphones) jack.

Adjusting the sound emphasis

To Select the sound characteristic

Press one of the SOUND MODE buttons to select the audio emphasis you want.
(On the remote, press SOUND repeatedly.)

Press	To get
ROCK	powerful, clean sounds, emphasizing low and high range audio
POP	light, bright sounds emphasizing high and middle range audio
JAZZ	percussive sounds, emphasizing bass audio
VOCAL	the presence of vocals, stressing middle range audio
FLAT	the whole dynamic range for music such as classical music

To reinforce the bass sound

Press MEGA BASS.

"MEGA BASS" appears in the display.

To return to normal sound, press the button again.

To get the MEGA Xpand effect

Press MEGA Xpand.

"MEGA Xpand" appears in the display.

You can get the effect of expansion of the sound field.

To return to normal sound, press the button again.

Playing a CD

- Press CD (direct power-on).
(On the remote, press OPERATE (or POWER) and then press FUNCTION repeatedly until "Cd" appears in the display.)
- Load a CD in the CD compartment.
- Press to close the CD compartment.
- Press on the remote).
The player plays all the tracks once.

To	Press
stop playback	
pause playback	(on the remote) Press the button again to resume play after pause.
go to the next track	
go back to the previous track	
remove the CD	
locate a specific track directly*	a number button of the track
locate a point while listening to the sound	(forward) or (backward) while playing until you find the point
locate a point while observing the display	(forward) or (backward) in pause until you find the point

* You cannot locate a specific track if "SHUF" or "PGM" is lit in the display. Turn off the indication by pressing .

Tip

To locate a track numbered over 10, press >10 first, then the corresponding number buttons.
Example: To play track number 23, press >10 first, then 2 and 3.

Using the display

To check the total track number and playing time

Press DISPLAY•ENT•MEMORY in stop mode (see fig.).

To check the remaining time

Press DISPLAY•ENT•MEMORY repeatedly while playing a CD. The display changes as follows:

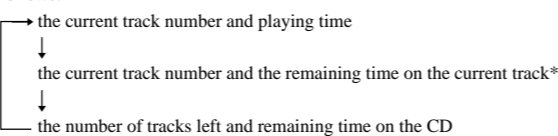

* For a track whose number is more than 20, the remaining time appears as "-:--" in the display.

Selecting the play mode

Press MODE until "REP 1" "REP ALL" "SHUF" "SHUF REP" "PGM" "PGM REP" appears in the display. Then proceed as follows:

To	Select	Then do this
repeat a single track	"REP 1"	Press the number button for the track you want to repeat.
repeat all tracks	"REP ALL"	Press .
shuffle play	"SHUF"	Press .
repeat tracks in random order	"SHUF REP"	Press .
programme play	"PGM"	Press the number buttons for the tracks you want to programme in the order you want up to 20 tracks (see fig.). Then press .
repeat programmed tracks	"PGM REP"	Press the number buttons for the tracks you want to programme in the order you want up to 20 tracks. Then Press .

To cancel selected play mode

Press MODE until the selected mode disappears from the display.

To check the programmed track and playing order in the display

To check the order of tracks before play, press DISPLAY•ENT•MEMORY.

Every time you press the button, the track number appears in the programmed order.

To change the current programme

Press once if the CD is stopped and twice if the CD is playing. The current programme will be erased. Then create a new programme following the programming procedure.

Tip

You can record your own programme. After you've created the programme, insert a blank tape and press to start recording.

Listening to the radio

- Press RADIO BAND•AUTO PRESET until the band you want appears in the display (direct power-on).
Each time you press the button, the indication changes as follows:
CFD-S550: "FM" → "AM"
CFD-S550L: "FM" → "MW" → "LW"
- Hold down TUNE + or - until the frequency digits begin to change in the display.

The player automatically scans the radio frequencies and stops when it finds a clear station.

If you can't tune in a station, press the button repeatedly to change the frequency step by step.

Tip

If the FM broadcast is noisy, press MODE until "Mono" appears in the display and the radio will play in monaural.

Changing the AM/MW tuning interval

The AM/MW tuning interval is preset to 9 kHz at the factory.

If you need to change the AM/MW tuning interval, do the following:

- While keeping the RADIO BAND•AUTO PRESET button and button pressed, disconnect the mains lead from the mains.
- While keeping the RADIO BAND•AUTO PRESET button and button pressed, reconnect the mains lead to the mains. The tuning interval is changed and "AM 9" "MW 9" or "AM 10" "MW 10" appears in the display for 2 seconds.

After changing the tuning interval, you need to reset your preset radio stations.

Presetting radio stations

You can store radio stations into the player's memory. You can preset up to 30 radio stations (CFD-S550), 20 for FM and 10 for AM in any order, or 40 radio stations (CFD-S550L), 20 for FM and 10 for MW and LW in any order.

- Press RADIO BAND•AUTO PRESET to select the band.
- Hold down RADIO BAND•AUTO PRESET for 2 seconds until "AUTO" flashes in the display.
- Press DISPLAY•ENT•MEMORY.
The stations are stored in memory from the lower frequencies to the higher ones.

If a station cannot be preset automatically

You need to preset a station with a weak signal manually.

- Press RADIO BAND•AUTO PRESET to select the band.
- Tune in a station you want.
- Hold down the number buttons that you want to preset the new station on for about 2 seconds.
To select the preset number over 10, press >10 first, then the corresponding number buttons. You need to hold down the last number button to enter for about 2 seconds.
(Example: To select 12, press >10 and 1 first, then hold down 2 for about 2 seconds.)

Tip

The preset radio stations remain in memory even if you unplug the mains lead or remove the batteries.

Playing preset radio stations

- Press RADIO BAND•AUTO PRESET to select the band.
- Press the number buttons to tune in the stored station.
To tune in a preset station over 10, press >10 first, then corresponding number buttons.
(Example: To tune in a preset station 12, press >10 and 1 first, and then press 2.)

Connecting optional components (CFD-S550L only)

You can record a CD on a MiniDisc and enjoy the sound from other components, such as portable MD, CD player and TV, VCR through the speakers of this player.

Be sure to turn off the power of each component before making connections. For details, refer to the instructions of the component to be connected.

Recording a CD on a MiniDisc recorder or DAT recorder

- Connect the OPTICAL DIGITAL OUT (CD) jack of this player with the digital input jack of MiniDisc and DAT using the digital connecting cable* (not supplied).

* Select a connecting cable depending on the type of the digital input jack of the recorder to be connected. For details, refer to the instruction manual of the component to be connected. The OPTICAL DIGITAL OUT (CD) jack of this player is square-shaped jack.

The type of the jack of the component to be connected	Model number of the connecting cable
Optical miniplug (MiniDisc recorder, etc.)	POC-5AB
L-type 7-pin connector (DAT recorder, etc.)	POC-DA12P
Square-shaped optical connector (MiniDisc recorder, DAT recorder, etc.)	POC-10A

- Turn on the power of this player and the connected component.
- Make the connected component ready for recording.
- Press to start playing a CD.

Listening to the sound from the connected component

- Connect the LINE IN jack of this player with the line output jack or headphones jack of other component using the audio connecting cable* (not supplied).
* For MiniDisc recorder: a cable with a stereo-mini plug on both ends.
* For TV, VCR: a cable with a stereo-mini plug on one end and two phono plugs on the other end.
- Press LINE to display "LnE".
- Play the optional component connected to the LINE IN jack of the player.

Tip

You can record the sound from the connected component. Insert a blank tape into the tape compartment, and press .

Notes

- Connect the cords firmly to avoid any malfunction.
- When other components are not connected, close the cover for the OPTICAL DIGITAL OUT (CD) and LINE IN jacks to keep out dust.

Free Manuals Download Website

<http://myh66.com>

<http://usermanuals.us>

<http://www.somanuals.com>

<http://www.4manuals.cc>

<http://www.manual-lib.com>

<http://www.404manual.com>

<http://www.luxmanual.com>

<http://aubethermostatmanual.com>

Golf course search by state

<http://golfingnear.com>

Email search by domain

<http://emailbydomain.com>

Auto manuals search

<http://auto.somanuals.com>

TV manuals search

<http://tv.somanuals.com>