

Portable CD Player

Operating Instructions

Owner's Record

The model number is located at the rear and the serial number is located inside the lid of the CD player. Record the serial number in the space provided below. Refer to these numbers whenever you call upon your Sony dealer regarding this product.

Model No. D-NE900

Serial No. _____



Atrac3plus

“WALKMAN” is a registered trademark of Sony Corporation to represent Headphone Stereo products.  is a trademark of Sony Corporation.

D-NE900

WARNING

To prevent fire or shock hazard, do not expose the unit to rain or moisture.

Do not install the appliance in a confined space, such as a bookcase or built-in cabinet.

To prevent fire, do not cover the ventilation of the apparatus with newspapers, tablecloths, curtains, etc. And don't place lighted candles on the apparatus.

To prevent fire or shock hazard, do not place objects filled with liquids, such as vases, on the apparatus.

CAUTION

The use of optical instruments with this product will increase eye hazard.

Certain countries may regulate disposal of the battery used to power this product. Please consult with your local authority.

CAUTION

- INVISIBLE LASER RADIATION WHEN OPEN
- DO NOT STARE INTO BEAM OR VIEW DIRECTLY WITH OPTICAL INSTRUMENTS
- CLASS 1M INVISIBLE LASER RADIATION WHEN OPEN
- DO NOT VIEW DIRECTLY WITH OPTICAL INSTRUMENTS

The validity of the CE marking is restricted to only those countries where it is legally enforced, mainly in the countries EEA (European Economic Area).

ATRAC3plus and ATRAC3 are trademarks of Sony Corporation.

For the customers in the USA and Canada

RECYCLING NICKEL METAL HYDRIDE BATTERIES

Nickel Metal Hydride batteries are recyclable.

You can help preserve our environment by returning your used rechargeable batteries to the collection and recycling location nearest you.



For more information regarding recycling of rechargeable batteries, call toll free 1-800-822-8837, or visit <http://www.rbrc.org/>.

Caution: Do not handle damaged or leaking Nickel Metal Hydride batteries.

For the customers in the USA

This equipment has been tested and found to comply with the limits for a Class B digital device, pursuant to Part 15 of the FCC Rules. These limits are designed to provide reasonable protection against harmful interference in a residential installation. This equipment generates, uses, and can radiate radio frequency energy and, if not installed and used in accordance with the instructions, may cause harmful interference to radio communications. However, there is no guarantee that interference will not occur in a particular installation. If this equipment does cause harmful interference to radio or television reception, which can be determined by turning the equipment off and on, the user is encouraged to try to correct the interference by one or more of the following measures:

- Reorient or relocate the receiving antenna.
- Increase the separation between the equipment and receiver.
- Connect the equipment into an outlet on a circuit different from that to which the receiver is connected.
- Consult the dealer or an experienced radio/TV technician for help.

You are cautioned that any changes or modifications not expressly approved in this manual could void your authority to operate this equipment.

Product registration

For customers who purchased this product in the USA

Please register this product on line at www.sony.com/walkmanreg
<<http://www.sony.com/walkmanreg>>

Proper registration will enable us to send you periodic mailings about software upgrades, new products, services and other important announcements. Thank you.

If you have any questions about this product, contact:

www.sony.com/walkmansupport

**Sony Network Portable Audio Support Line
1-(866)-456-7669**

**Sony Customer Information Services Center
12451 Gateway Blvd., Ft. Myers, FL 33913**

Table of Contents

Enjoy your ATRAC CD Walkman!

Music sources playable on this CD player ..	6
ATRAC3plus and ATRAC3	7
MP3	7
The structure of ATRAC3plus/ATRAC3 and MP3 files	8

Getting started

Checking the supplied accessories	10
Locating the controls	11

Playing a CD

1. Insert a CD.	15
2. Connect your CD player.	15
3. Play a CD.	16

Playback options

Playing tracks repeatedly (Repeat play)	19
Playing all files in a selected group (Group play) (ATRAC CD/MP3 CD only)	19
Playing a single track (Single play)	20
Playing tracks in random order (Shuffle play)	20
Playing all files in a selected group in random order (Group shuffle play) (ATRAC CD/MP3 CD only)	20
Playing your favorite play lists (m3u play list play) (MP3 CD only)	20
Playing your favorite tracks by adding Bookmarks (Bookmark track play)	21
Playing the 10 tracks you have played most frequently (Auto ranking play)	22

Playing tracks you have played most frequently in random order (Auto ranking shuffle play)	22
Playing tracks in your favorite order (PGM play)	23
Searching for groups or tracks/files	24

Available features

Adjusting sound quality (Parametric equalizer)	25
The G-PROTECTION function	26
Protecting your hearing (AVLS)	27
Stopping playback automatically (OFF TIMER)	27
Locking the controls (HOLD)	28
Turning off the beep sound	28
Saving power	29
Playing tracks continuously (SEAMLESS) (ATRAC CD only)	30

Connecting your CD player

Connecting a stereo system	31
----------------------------------	----

Connecting to a power source

Using the rechargeable battery	33
Using the dry battery	35
Notes on the power source	36

Additional information

List of menus	37
Precautions	38
Maintenance	38
Troubleshooting	39
Specifications	42
Optional accessories	43

Enjoy your ATRAC CD Walkman!

Thank you for purchasing the D-NE900. This CD Walkman is called an “ATRAC CD Walkman,” because you can enjoy “ATRAC CDs” on it.

You can make your own ATRAC CD easily.

Step 1 Install

Install the supplied
“SonicStage Simple Burner”
software.



Step 2 Burn

Create a disc image and burn it on
a CD-R/RW using your PC.

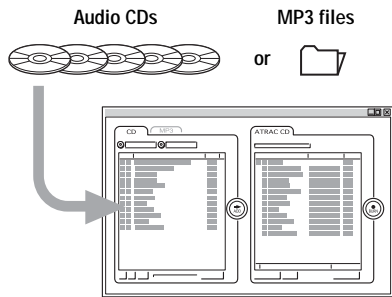

Audio data is converted to the ATRAC3plus/
ATRAC3 format by the SonicStage Simple
Burner.

How to use the SonicStage Simple Burner

Refer to the supplied booklet “SonicStage Simple Burner.”

What is an ATRAC CD?

An ATRAC CD is a CD-R/RW on which audio data compressed in the ATRAC3plus/ATRAC3 format has been recorded. About 30 audio CDs can be recorded on a CD-R/RW.* You can also record MP3 files by converting the files to the ATRAC3plus/ATRAC3 format.

* When total playing time of one CD (album) is estimated at 60 minutes and you are recording on a 700 MB CD-R/RW at 48 kbps in ATRAC3plus format.

ATRAC CD

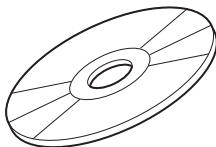

Step 3 Listen

You can enjoy listening to your own ATRAC CDs on your ATRAC CD Walkman.



You can also enjoy audio CDs on your CD Walkman.

What is the ATRAC3plus/ATRAC3 format?

Refer to pages 6 - 9 of this manual.

Music sources playable on this CD player

You can play the following 3 music sources on this CD player:

- Audio CDs (CDDA format)
- CDs with ATRAC3plus/ATRAC3 format files (ATRAC CD)
- CDs with MP3 format files (MP3 CD)

Usable disc formats

You can use ISO 9660 Level 1/2 and Joliet extension format discs only.

About CD-Rs/RWs

This CD player can play CD-Rs/RWs recorded in the ATRAC3plus/ATRAC3, MP3 or CDDA* format, but playback capability may vary depending on the quality of the disc and the condition of the recording device.

* CDDA is the abbreviation for Compact Disc Digital Audio. It is a recording standard used for the Audio CDs.

Music discs encoded with copyright protection technologies

This product is designed to play back discs that conform to the Compact Disc (CD) standard. Recently, various music discs encoded with copyright protection technologies are marketed by some record companies. Please be aware that among those discs, there are some that do not conform to the CD standard and may not be playable by this product.

Notes

- This CD player cannot record music content on recordable media, such as CD-Rs/RWs.
- CD-Rs/RWs recorded in the ATRAC3plus/ATRAC3 format cannot be played on your computer.

ATRAC3plus and ATRAC3

“ATRAC3plus,” which stands for “Adaptive Transform Acoustic Coding3plus” is audio compression technology, developed from the ATRAC3 format. Though the ATRAC3plus format can compress music content to about 1/20 of its original size at 64 kbps, you can still enjoy high quality sound. The available transfer bit rates are 256 kbps, 64 kbps and 48 kbps.

“ATRAC3,” which stands for “Adaptive Transform Acoustic Coding3” is audio compression technology that satisfies the demand for high sound quality and high compression rates. The ATRAC3 format can compress music content to about 1/10 of their original size, which contributes to reduction of the media volume. The available transfer bit rates are 132 kbps, 105 kbps and 66 kbps.

The usable number of groups and files

- Maximum number of groups: 255
- Maximum number of files: 999

For details, refer to the supplied booklet “SonicStage Simple Burner.”

Note on saving files on the media

Do not save files in other formats (except MP3 files) and do not make unnecessary folders on a disc that has ATRAC3plus/ATRAC3 files.

MP3

MP3, which stands for MPEG-1 Audio Layer3, a standard for audio files compression supported by the Motion Picture Experts Group, an ISO (International Organization for Standardization) working group, enables compression of audio files to about 1/10 of the data size of a standard compact disc.

The major specifications of the acceptable disc format are:

- Maximum directory levels: 8
- Acceptable characters: A - Z, a - z, 0 - 9, _ (underscore)

Notes

- When naming files, be sure to add the file extension “mp3” to the file name.
- If you add the extension “mp3” to a file other than an MP3 file, the player will not be able to recognize the file properly.

(Continued)

The usable number of groups and files

- Maximum number of groups: 255
- Maximum number of files: 999

Settings for compression and writing software

- This CD player is able to play MP3 files with the following specifications: Bit rate: 16 - 320 kbps, and sampling frequencies: 32/44.1/ 48 kHz. Variable Bit Rate (VBR) file can also be played.
To compress a source for an MP3 file, we recommend setting the compression software to “44.1 kHz,” “128 kbps,” and “Constant Bit Rate.”
- To record up to the maximum capacity, set to “halting of writing.”
- To record at one time up to the maximum capacity on media that has nothing recorded on it, set to “Disc at Once.”

Notes on saving files on the media

- Do not save files in other formats (except MP3/ATRAC3plus/ATRAC3 format files) or unnecessary folders on a disc that has MP3 files.
- When a disc is inserted, the CD player reads all the information of folders and files on that disc. If there are many folders on the disc, it may take a long time for play to begin or for the next file to start playback.

The structure of ATRAC3plus/ATRAC3 and MP3 files

Groups and folders

The ATRAC3plus/ATRAC3 format has a very simple structure. It consists of “files” and “groups.” A “file” is equivalent to a “track” of an audio CD. A “group” is a bundle of files and is equivalent to an “album.” A “group” has no directory-type structure (a new group cannot be made within an existing group).

When referring to MP3 CDs, a “file” is equivalent to a “track” and a “group” is equivalent to an “album.” This CD player is designed to recognize an MP3 folder as a “group” so that it can play CD-Rs/RWs recorded in both the ATRAC3plus/ATRAC3 format and those recorded in the MP3 format with the same operation.

ATRAC3plus/ATRAC3/MP3 file structure and playing order

•ATRAC3plus/ATRAC3

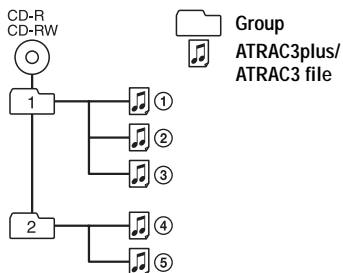

•MP3

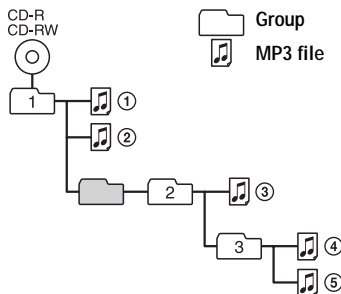
**Notes**

- A group that does not include an MP3 file is skipped.
- If ATRAC3plus/ATRAC3 files and MP3 files are recorded on the same CD, this CD player plays the ATRAC3plus/ATRAC3 files first.
- Depending on the method used to record MP3 files on the disc, the playing order may be different from the one shown above.

Getting started

Checking the supplied accessories

AC power adaptor (1)

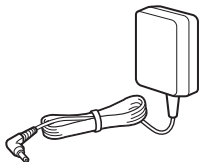

Rechargeable battery (1)

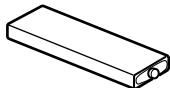

Battery carrying case (1)

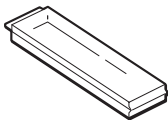

Headphones (1) (for USA model)



Earphones (1) (for other models)



Remote control (1)

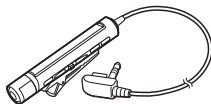

Charging stand (1)



Carrying pouch (1)



External battery case (1)

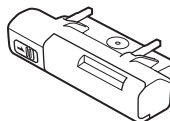

CD-ROM* (SonicStage Simple Burner) (1)

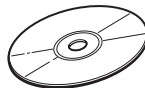

*Do not play a CD-ROM on an audio CD player.

User's guide for SonicStage Simple Burner (1)
AC plug adaptor (1) (Supplied with tourist model only)

For US customers

The AC power adaptor supplied is not intended to be serviced. Should the AC power adaptor cease to function in its intended manner, during the warranty period, the adaptor should be returned to your nearest Sony Service Center or Sony Authorized Repair Center for replacement, or after warranty period, it should be discarded.

Locating the controls

CD player

For details, see the pages in parentheses.

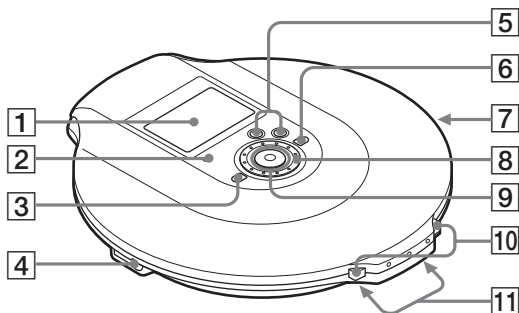

- 1** Display (12, 17, 19, 24, 37)
- 2** OPERATION lamp (15, 28, 29, 34)
Color of the lamp changes according to the type of music source being played.
Red: Audio CD, Green: ATRAC3plus/ATRAC3 file, Orange: MP3 file
For some time after the CD is inserted, the lamp lights up in red, orange and green in turn.
This lamp also functions as the HOLD lamp and the CHG (charge) lamp.
- 3** (group) – button (16, 23, 24, 26, 28, 37)
- 4** (headphones)/LINE OUT (OPTICAL) jack (15, 31)
Switch the function of the jack, using the menu.
- 5** VOL (volume) +*/- buttons (16)
- 6** (group) + button (16, 23, 24)
- 7** HOLD switch (rear) (28)
Slide the switch in the direction of the arrow to disable the buttons on the CD player.
- 8** Jog dial (19 - 31, 37)
Use to select a file, play mode, etc. The search direction changes according to the direction in which the jog dial is turned.

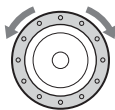

- 9** 5-way control key (15, 16, 19 - 31, 34, 37)

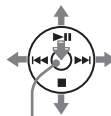

DISPLAY/
MENU

- ▶▶: play/pause
◀◀: AMS^{*2}/rewind
▶▶: AMS/fast forward
■/CHG: stop/charge
DISPLAY/MENU: Use to select menu items and enter the selection.

Push the control key toward ▶▶, ▶▶, ◀◀ or ■/CHG with your finger on DISPLAY/MENU.

- 10** OPEN switch (15, 33)
Squeeze the switch from both sides.
- 11** Terminals for the charging stand/external battery case (15, 34, 35)

*1 The button has a tactile dot.



*2 Automatic Music Sensor

(Continued)

Display (CD player)

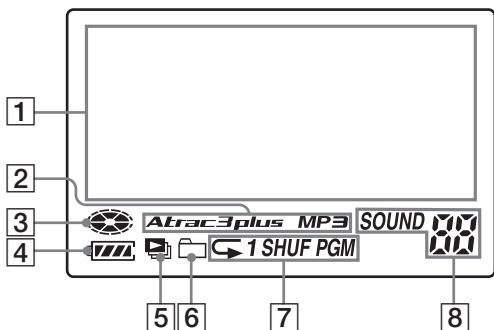
For details, see the pages in parentheses.



- 1** Character information display (17)
While playing an audio CD, disc name, track name, etc. appear in 4 lines, if recorded on the CD.
While playing an ATRAC CD/MP3 CD, group name, file name, etc. appear in 4 lines, if recorded on the CD.
Menu items also appear in this display.
- 2** Atrac3plus/MP3 indication
- 3** Disc indication
Lights up while the CD player is playing.
- 4** Battery indication (33)
Roughly shows the remaining power of the battery. If “” flashes, the battery is depleted.
- 5** Play list indication (21)
For MP3 CD only
- 6** Group indication (19, 20)
For ATRAC CD/MP3 CD only
- 7** Play mode indication (19 - 23)
Shows various playmodes such as shuffle play and program play. “” shows repeat play.
- 8** SOUND indication (25, 26)
Shows the SOUND setting which has been selected on the menu.

Remote control

For details, see the pages in parentheses.

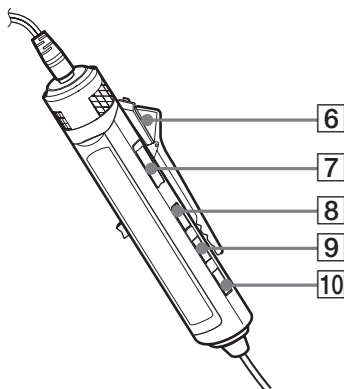
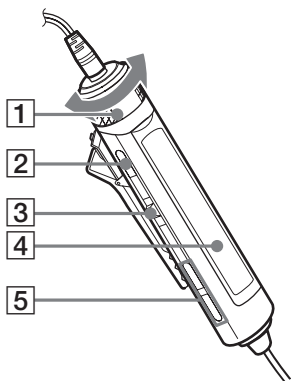

- 1** VOL (volume) +/- control (16, 26, 28)
Turn to adjust the volume.
- 2** ■ (stop) button (16, 26, 28, 37)
- 3** Jog lever (◀◀ ▶▶/ENT ▶▶) (16, 21 - 23, 25 - 31)
▶▶ (play/pause)/ENT (enter):
Press during stop to start play, and press during play to pause play. When selecting menu items, press to enter the selection.
Flick toward ◀◀ or ▶▶: AMS, rewind, fast forward
- 4** Display (14, 17)
- 5** (group) +/- buttons (16, 23, 24)

- 6** Clip (14)
- 7** HOLD switch (28)
Slide the switch in the direction of the arrow (a yellow mark appears) to disable the buttons on the remote control.
- 8** DISPLAY button (23, 26 - 31, 37)
- 9** P MODE/▶ button (19 - 23)
- 10** SOUND button (25, 37)

Note

Use only the supplied remote control. You cannot operate this CD player with the remote control supplied with other CD players.

(Continued)

Display (remote control)

For details, see the pages in parentheses.

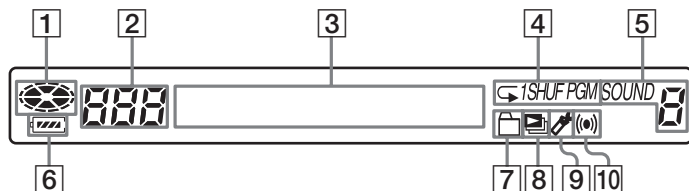

- | | |
|---------------------------------------------|------------------------------------------------------------------------------------------------|
| 1 Disc indication | 8 Play list indication (21) |
| 2 Track number indication (23) | 9 Bookmark indication (21)
During play, the indication shows a track has a Bookmark. |
| 3 Character information display (17) | 10 Timer indication (27)
Shows the OFF TIMER setting has been selected on the menu. |
| 4 Play mode indication (19 - 23) | |
| 5 SOUND indication (25, 26) | |
| 6 Battery indication (33) | |
| 7 Group indication (19, 20) | |

To use the clip on the remote control

You can remove the clip from the remote control and change the direction of the clip.

To remove

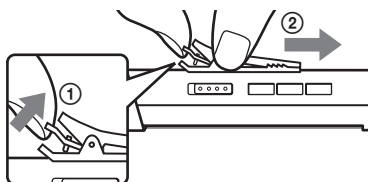

To attach in the reverse direction

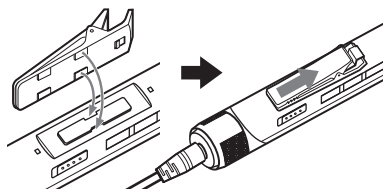

You can pass the cord of the remote control through this clip.

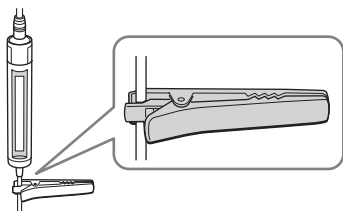

Playing a CD

1. Insert a CD.

- 1 Squeeze OPEN from both sides to open the CD player lid.

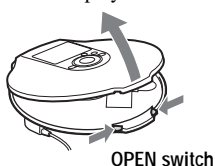

- 2 Place the CD on the tray and close the lid.

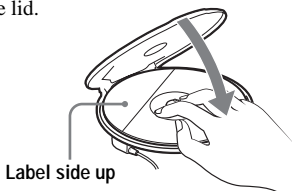

2. Connect your CD player.

You can use the following power sources:

- Rechargeable battery (page 33)
- LR6 (size AA) alkaline battery (external battery case) (page 35)
- AC power adaptor

We explain how to use your CD player on house current on this page. Connect the plugs and terminals securely.

- 1 Connect the AC power adaptor to the charging stand.
- 2 Connect the headphones/earphones with the remote control to the CD player.
- 3 Place the CD player on the charging stand.

Make sure that the OPERATION lamp flashes.

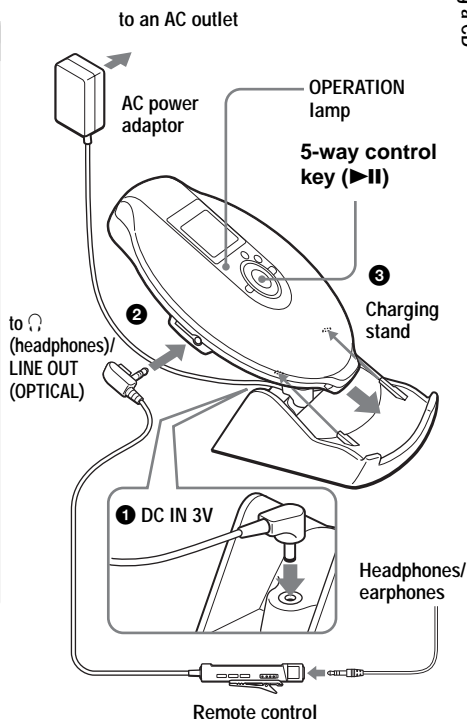

(Continued)

3. Play a CD.

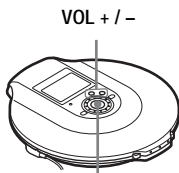

5-way control key (▶||)

- ❶ Push the control key toward ▶||.
- ❷ Adjust the volume by pressing VOL + or -.

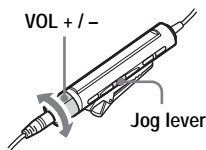

- ❶ Press the jog lever.
- ❷ Adjust the volume by turning VOL +/-.

To	CD player	Remote control
Play (from a point where you stopped previously)	Push the control key toward ▶ . Playback starts from the point where you stopped.	Press the jog lever. Playback starts from the point where you stopped.
Play (from the first track)	While the CD player is stopped, push and hold the control key toward ▶ until the play of the first track starts.	While the CD player is stopped, press and hold the jog lever until the play of the first track starts.
Pause/resume play after pause	Push toward ▶ .	Press the jog lever.
Stop*2	Push toward ■/CHG.	Press ■.
Find the beginning of the current track (AMS*1)*2	Push toward ◀◀.	Flick the jog lever toward ◀◀ once.
Find the beginning of previous tracks (AMS)*3	Push toward ◀◀ repeatedly.	Flick the jog lever toward ◀◀ repeatedly.
Find the beginning of the next track (AMS)*2, *3	Push toward ▶▶.	Flick the jog lever toward ▶▶ once.
Find the beginning of succeeding tracks (AMS)*3	Push toward ▶▶ repeatedly.	Flick the jog lever toward ▶▶ repeatedly.
Go backwards quickly*2, *5	Push and hold toward ◀◀.	Hold the jog lever toward ◀◀.
Go forward quickly*2, *5	Push and hold toward ▶▶.	Hold the jog lever toward ▶▶.
Jump to succeeding groups*4	Press ◻ + repeatedly.	Press ◻ + repeatedly.
Jump to previous groups*4	Press ◻ - repeatedly.	Press ◻ - repeatedly.

*1 Automatic Music Sensor

*2 These operations can be carried out during both play and pause.

*3 After you have played the last track, you can return to the beginning of the first track by flicking the jog lever toward ▶▶ (by pushing the control key toward ▶▶ on the CD player). Similarly, if you are at the first track, you can locate the last track by flicking the jog lever toward ◀◀ (by pushing the control key toward ◀◀ on the CD player).

*4 Only when you play an ATRAC CD/MP3 CD

*5 These operations cannot be carried out when using an MP3 file recorded on a CD-R/RW in a packet write format.

Checking CD information on the display

You can check CD information by repeatedly pressing DISPLAY/MENU on the CD player or DISPLAY on the remote control.

When you are playing a CD containing text information such as CD-TEXT, “track name,” “album name,” “artist name,” etc. are displayed as shown in parentheses in the following table. When you are playing an ATRAC CD, information you input using the SonicStage Simple Burner software is displayed. When you are playing an MP3 CD containing MP3 files with an ID3 tag*1, ID3 tag information is displayed.

CD player

Each time you press DISPLAY/MENU, the display changes as follows:

Audio CD	ATRAC CD/MP3 CD
Track number, elapsed playing time (Track name, artist name, album name)	File name*3, artist name*3, group name, file number, elapsed playing time
Track number, remaining time of the current track (Track name, artist name)	File name, CODEC information*4, file number, remaining time of the current file
The total number of tracks on the CD, the total playing time of the CD, the number of tracks left*2, the time remaining on the CD*2	Total number of files, total number of groups, file number, elapsed playing time
List of track names	List of group names/file names

Remote control

Each time you press DISPLAY, the display changes as follows:

Audio CD	ATRAC CD/MP3 CD
Track number, elapsed playing time, (Track name)	File number, file name, elapsed playing time
Track number, remaining time of the current track (Track name, artist name)	File number, artist name, CODEC information*4, remaining time of the current file
The number of tracks left*2, the time remaining on the CD*2 (Album name, artist name)	Group name, total number of files
Animation screen	

*1 An ID3 tag is a format for adding certain information (track name, album name, artist name, etc.) to MP3 files. This CD player conforms to Version 1.1/2.2/2.3 of the ID3 tag format (for MP3 files only).

*2 Not displayed during Single play, Shuffle play, Bookmark track play, Auto ranking play, Auto ranking shuffle play, or PGM play.

*3 During play, “artist name” is not displayed if the disc does not have ID3 tag information. When the list of group names/file names appears in the display, “artist name” is not displayed.

*4 Bit rate and sampling frequencies. While an MP3 file made at VBR (variable bit rate) is being played, “VBR” appears on the display instead of a bit rate. In some cases, “VBR” appears halfway through playback, not from the beginning.

(Continued)

Notes

- The characters A - Z, a - z, 0 - 9, and _ can be displayed on this CD player.
- Before playing a file, the CD player reads all file and group (or folder) information on the CD. "READING" is displayed. Depending on the content of the CD, it may take some time to accomplish this reading.
- If the group does not have a group name, "ROOT" appears in the display.
- If the file does not have ID3 tag information, "- - -" appears in the display.

Removing the CD

Remove the CD while pressing the pivot in the center of the tray.



► Playback options

You can enjoy the following playback options using the P MODE/◀ button on the remote control or the menu function on the CD player.

- **Playing tracks repeatedly (Repeat play)**
- **Playing all files in a selected group (Group play)**
- **Playing a single track (Single play)**
- **Playing tracks in random order (Shuffle play)**
- **Playing files in a selected group in random order (Group shuffle play)**
- **Playing your favorite play lists (m3u play list play)**
- **Playing your favorite tracks by adding Bookmarks (Bookmark track play)**
- **Playing the 10 tracks you have played most frequently (Auto ranking play)**
- **Playing tracks you have played most frequently in random order (Auto ranking shuffle play)**
- **Playing tracks in your favorite order (PGM play)**

Selecting playback options on the CD player

Enter the PLAY MODE menu using the following procedures, then select each playback option.

- 1 Press DISPLAY/MENU until the MENU screen appears.
- 2 Turn the jog dial to select "PLAY MODE," then press DISPLAY/MENU.
- 3 Turn the jog dial to select the playback option you want.
The default setting is "ALL" (normal play).

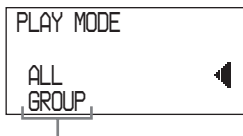

Playback options appear.

Selecting playback options using the remote control

Press P MODE/◀ repeatedly to select the playback option you want.

Playing tracks repeatedly (Repeat play)

You can repeat various playback options.

Using the remote control

During play, press and hold P MODE/◀ until "◀" appears.

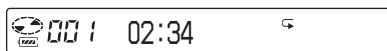

On the CD player

- 1 Press DISPLAY/MENU until the MENU screen appears.
- 2 Turn the jog dial to select "REPEAT," then press DISPLAY/MENU.
- 3 Turn the jog dial to select "ON," then press DISPLAY/MENU to enter the selection.

Playing all files in a selected group (Group play) (ATRAC CD/MP3 CD only)

During play, press P MODE/◀ repeatedly until "◻" appears. (CD player: Perform steps 1 and 2 of "Selecting playback options on the CD player" (this page), turn the jog dial to select "GROUP," then press DISPLAY/MENU to enter the selection.)



Playing a single track (Single play)

During play, press P MODE/↵ repeatedly until “1” appears. (CD player: Perform steps 1 and 2 of “Selecting playback options on the CD player” (page 19), turn the jog dial to select “1,” then press DISPLAY/MENU to enter the selection.)

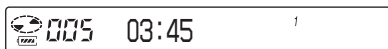

Playing tracks in random order (Shuffle play)

During play, press P MODE/↵ repeatedly until “SHUF” appears. (CD player: Perform steps 1 and 2 of “Selecting playback options on the CD player” (page 19), turn the jog dial to select “SHUFFLE,” then press DISPLAY/MENU to enter the selection.)

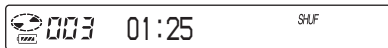

Playing all files in a selected group in random order (Group shuffle play) (ATRAC CD/MP3 CD only)

During play, press P MODE/↵ repeatedly until “SHUF” appears. (CD player: Perform steps 1 and 2 of “Selecting playback options on the CD player” (page 19), turn the jog dial to select “GROUP SHUFFLE,” then press DISPLAY/MENU to enter the selection.)



Playing your favorite play lists (m3u play list play) (MP3 CD only)

You can play your favorite m3u play lists.*
* An “m3u play list” is a file for which an MP3 file playing order has been encoded. To use the play list function, record MP3 files on a CD-R/RW using encoding software that supports the m3u format.

1 During play, press P MODE/↵ repeatedly until “” (play list) appears. (CD player: Perform steps 1 and 2 of “Selecting playback options on the CD player” (page 19), turn the jog dial to select “PLAY LIST,” then press DISPLAY/MENU to enter the selection.)



Play list

- 2 Flick the jog lever toward **◀◀** or **▶▶** to select a play list you want. (CD player: Turn the jog dial to select a play list.)



- 3 Press the jog lever. (CD player: Push the 5-way control key toward **▶▶**.)





Playing your favorite tracks by adding Bookmarks (Bookmark track play)

While the CD player is playing, you can add Bookmarks to the tracks you want and play them only.



- Audio CD: up to 99 tracks for each CD (up to 10 CDs)
- ATRAC CD: up to 999 tracks for each CD (up to 5 CDs)
- MP3 CD: up to 999 tracks for each CD (up to 5 CDs)

Adding Bookmarks



- 1 During play of the track to where you want to add a Bookmark, press and hold the jog lever until “” flashes. (CD player: Push and hold the 5-way control key toward **▶▶** until “” flashes.) When the Bookmark has been added successfully, “” flashes slower.

- 2 Flick the jog lever toward **◀◀** or **▶▶** (CD player: Push the 5-way control key toward **◀◀** or **▶▶**) to select the track to where you want to add a Bookmark, then repeat step 1 to add Bookmarks to the tracks you want.

Playing the tracks with Bookmarks

- 1 Press P MODE/ repeatedly until “” (Bookmark) flashes frequently. (CD player: Perform steps 1 and 2 of “Selecting playback options on the CD player” (page 19), turn the jog dial to select “BOOK MARK,” then press DISPLAY/MENU. The play of the tracks with the Bookmarks starts.)
- 2 Press the jog lever to light up “.” The play of the tracks with the Bookmarks starts.

To remove the Bookmarks

During play of the track with a Bookmark, press and hold the jog lever until “” disappears from the display. (CD player: Push the 5-way control key toward **▶▶** until “” disappears from the display.)

To check the tracks with Bookmarks

During playback of the tracks with Bookmarks, “” flashes slowly in the display.

Notes

- During play of tracks with Bookmarks, tracks are played in order of track number, and not in the order you added the Bookmarks.
- If you try to add Bookmarks to the tracks on the 11th CD (on a 6th CD when playing ATRAC CDs/MP3 CDs), the Bookmarks of the CD you played first will be erased.
- All Bookmarks stored in memory will be erased:
 - if you remove all the power sources, or
 - if you continue playing the CD player on the rechargeable batteries without charging the batteries even though “Lobatt” is displayed.

Playing the 10 tracks you have played most frequently (Auto ranking play)

The CD player automatically memorizes up to 10 tracks you have played most frequently from the CD being played, and plays them from the 10th to the top.

During play, press P MODE/ **repeatedly to select “a00 (auto ranking)” and press the jog lever to enter the selection. (CD player: Perform steps 1 and 2 of “Selecting playback options on the CD player” (page 19), turn the jog dial to select “AUTO RANKING,” then press DISPLAY/MENU to enter the selection.)**

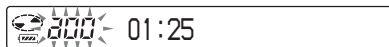

Playing tracks you have played most frequently in random order (Auto ranking shuffle play)

The CD player plays up to 32 tracks which the player has automatically memorized as the most frequently played ones. In Auto ranking shuffle play, these tracks are played in random order.

During play, press P MODE/ **repeatedly to select “a00 (auto ranking) SHUF” and press the jog lever to enter the selection. (CD player: Perform steps 1 and 2 of “Selecting playback options on the CD player” (page 19), turn the jog dial to select “RANKING SHUF,” then press DISPLAY/MENU to enter the selection.)**



Note

The CD player memorizes the tracks you have played from up to 10 CDs, whether you have changed the CDs or not. If the CD player tries to memorize tracks from an 11th CD, the data memorized first will be erased.

Playing tracks in your favorite order (PGM play)

You can program the CD player to play up to 64 tracks in your favorite order.

- 1** While play is stopped, press **P MODE/↵** repeatedly until “PGM” (program) appears. (CD player: While play is stopped, perform steps 1 and 2 of “Selecting playback options on the CD player” (page 19), turn the jog dial to select “PROGRAM,” then press **DISPLAY/MENU** to enter the selection.)

Audio CD/CD-TEXT



Track number Playing order

ATRAC CD/MP3 CD

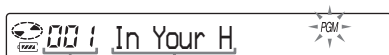

Playing order File name

- 2** Flick the jog lever toward **◀◀** or **▶▶** to select the track you want, then press and hold the jog lever until the display changes to enter the selection. (CD player: Push the 5-way control key toward **◀◀** or **▶▶** to select the track and press **DISPLAY/MENU** to enter the selection.)

The track has been stored in memory. When playing an ATRAC CD/MP3 CD, you can also select a group using **□ +** or **□ -**.

Audio CD/CD-TEXT

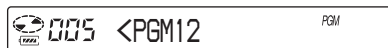

When playing an ATRAC CD/MP3 CD, a playing order and a file name are displayed.

- 3** Repeat step 2 to select the tracks in your favorite order.
- 4** Press the jog lever to start PGM play. (CD player: Push the 5-way control key toward **▶▶**.)

Checking the program

While programming:

Press and hold the jog lever repeatedly before step 4. (CD player: Push and hold the 5-way control key toward **▶▶** repeatedly, or press **DISPLAY/MENU** repeatedly.)

While play is stopped:

Press **DISPLAY**. While the indications are displayed, press **P MODE/↵** repeatedly until “PGM” flashes, then press the jog lever until the display changes. (CD player: Press **DISPLAY/MENU** repeatedly until the list of the tracks programmed appears. To display tracks from the third track on, push the 5-way control key toward **▶▶**.)

Notes

- When you finish entering the 64th track in step 3, the first selected track number (audio CD) or the first selected file name (ATRAC CD/MP3 CD) appears on the display.
- If you select 65 tracks or more, the first selected tracks are erased.

Searching for groups or tracks/files

While the CD player is playing, you can search for and play the group (ATrac CD only) or track/file you want quickly using the jog dial on the CD player.

-
- 1 During play, turn the jog dial until the search screen appears.**

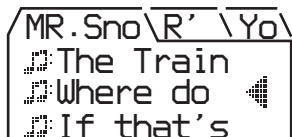

-
- 2 Press $\square +$ or $\square -$ to select the group you want, then push the 5-way control key toward \blacktriangleright .**

The CD player starts playing from the first file in the group you selected.

Selecting the track/file you want

- Perform step 1 above, then press $\square +$ or $\square -$ to select the group you want.
- Turn the jog dial to select the track/file you want, then push the 5-way control key toward \blacktriangleright .

The CD player starts playing from the track/ file you selected.

To exit the search mode

Push the 5-way control key toward \blacksquare /CHG. If about 40 seconds at most have passed without any operation being performed, the screen returns to the previous one.

Note

If you try to operate the CD player using the remote control during a search, "MENU" appears and you cannot perform any operation.

Adjusting sound quality (Parametric equalizer)

You can enjoy your favorite sounds by adjusting sound quality in the following two ways:

- Selecting a preset sound pattern →
“Selecting the sound quality you want”
- Adjusting sound quality by yourself →
“Customizing sound quality”

Selecting the sound quality you want

Indication	Sound quality
SOFT/ SOUND S	For vocals, stressing middle range audio
ACTIVE/ SOUND A	Lively sounds, emphasizing high and low range audio
HEAVY/ SOUND H	Powerful sounds, further emphasizing high and low ranges compared with ACTIVE sound
CUSTOM/ SOUND C	Customized sound

Using the remote control

Press SOUND repeatedly to select the sound quality you want.

On the CD player

- 1 Press DISPLAY/MENU until the MENU screen appears.
- 2 Turn the jog dial to select “SOUND,” then press DISPLAY/MENU.
- 3 Turn the jog dial to select the sound quality you want, then press DISPLAY/MENU to enter the selection.

Customizing sound quality

You can customize sound quality by adjusting the sound volume in the 3 frequency ranges “LOW” (low range audio), “MID” (middle range audio) and “HIGH” (high range audio). For each frequency range, you can select the wave pattern from among 3 patterns, and can also adjust the sound volume in 7 levels for the pattern you select.

Adjust sound quality by checking the shape of the wave on the display.

- 1 Press SOUND repeatedly to select “SOUND C”, then press SOUND until the display changes. (CD player: Perform steps 1 - 3 of “Selecting the sound quality you want” and select “CUSTOM.”)

- 2 Flick and hold the jog lever toward ◀◀ or ▶▶ until the frequency range you want appears. (CD player: Push the 5-way control key toward ◀◀ or ▶▶ for 2 seconds or more to select the frequency range.)

“LOW” is displayed first. (CD player: “LOW” flashes.)



(Continued)

Adjusting sound quality

- 3** Flick the jog lever toward **◀◀** or **▶▶** repeatedly to select the shape of the wave from the 3 shapes stored in memory for each frequency range, then turn the VOL +/- repeatedly to select the sound volume. (CD player: Push the 5-way control key toward **◀◀** or **▶▶** repeatedly to select the shape of the wave, then turn the jog dial to select the sound volume.)

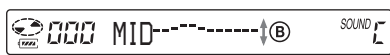

- (A): Frequency range
(B): Sound volume (To turn up the volume, use VOL -. To turn it down, use VOL +.)



- 4** Repeat steps 2 and 3 to make adjustment for the remaining 2 frequency ranges.

- 5** Press the jog lever to enter the selection. (CD player: Press DISPLAY/MENU to enter the selection.)

To return to the previous screen

Press **◀** on the CD player.

To cancel the adjustment operation

Press **■** for 2 seconds or more. (CD player: Push the 5-way control key toward **■**/CHG.)

Notes

- When you select CUSTOM sound, sound may be distorted depending on your sound settings when you turn up the volume. If this happens, turn the volume down.

- You may feel a difference in sound volume between the CUSTOM sound setting and other sound settings. Adjust the volume for your preference.

The G-PROTECTION function

The G-PROTECTION function has been developed to provide excellent protection against sound skipping during many active uses.

- 1** While play is stopped, press **DISPLAY** until the display changes. (CD player: While play is stopped, press **DISPLAY/MENU** until the MENU screen appears. Turn the jog dial to select "OPTION," then press **DISPLAY/MENU**.)
- 2** Flick the jog lever toward **◀◀** or **▶▶** to select "G-PRO," then press the jog lever to enter the selection. (CD player: Turn the jog dial to select "G-PROTECTION," then press **DISPLAY/MENU** to enter the selection.)

- 3** Flick the jog lever toward **◀◀** or **▶▶** to select "G-PRO 1" or "G-PRO 2," then press the jog lever to enter the selection. (CD player: Turn the jog dial to select "G-PRO 1" or "G-PRO 2," then press **DISPLAY/MENU** to enter the selection.)

If you select "G-PRO 2," the G-PROTECTION function will be enhanced compared to "G-PRO 1." To enjoy high quality CD sound, select "G-PRO 1."

Note

Sound may skip:

- if the CD player receives stronger continuous shock than expected,
- if a dirty or scratched CD is played, or
- when using poor-quality CD-Rs/RWs or if there is a problem with the original recording device or application software.

Protecting your hearing (AVLS)

The AVLS (Automatic Volume Limiter System) function keeps the maximum volume down to protect your hearing.

- 1 Press DISPLAY until the display changes. (CD player: Press DISPLAY/MENU until the MENU screen appears. Turn the jog dial to select "OPTION," then press DISPLAY/MENU.)**
- 2 Flick the jog lever toward \lll or \ggg to select "AVLS," then press the jog lever to enter the selection. (CD player: Turn the jog dial to select "AVLS," then press DISPLAY/MENU to enter the selection.)**
- 3 Flick the jog lever toward \lll or \ggg to select "ON," then press the jog lever to enter the selection. (CD player: Turn the jog dial to select "ON," then press DISPLAY/MENU to enter the selection.)**

To cancel the AVLS function

Perform steps 1 - 3, changing the AVLS setting to "OFF."

Stopping playback automatically (OFF TIMER)

You can set the CD player to stop playback automatically within a range of 1 to 99 minutes. While the timer function is working, the following indications appear:

- CD player: "⏸" appears at about 5-second intervals.
- Remote control: "⏸" is displayed.

- 1 Press DISPLAY until the display changes. (CD player: Press DISPLAY/MENU until the MENU screen appears. Turn the jog dial to select "OPTION," then press DISPLAY/MENU.)**
- 2 Flick the jog lever toward \lll or \ggg to select "TIMER," then press the jog lever to enter the selection. (CD player: Turn the jog dial to select "TIMER," then press DISPLAY/MENU to enter the selection.)**
- 3 Flick the jog lever toward \lll or \ggg to select "10 min*." (CD player: Turn the jog dial to select "10 min," then press DISPLAY/MENU.)**

* Default setting. If you have changed the setting, the length of time already set appears.

(Continued)

4 Turn VOL +/- to select the length of time you want to set, then press the jog lever to enter the selection. (CD player: Turn the jog dial to select the length of time you want to set, then press DISPLAY/MENU to enter the selection.)

- To increase/decrease by 5 minutes (remote control only):
Turn VOL +/- repeatedly.
 - To increase/decrease by 1 minute:
Keep turning VOL +/- . (CD player: Keep turning the jog dial.)
-

To return to the previous screen

Press ■. (CD player: Press □ -.)

To cancel the setting operation

Press DISPLAY or ■ for 2 seconds or more. (CD player: Push the 5-way control key toward ■/CHG.)

To check the length of time before the CD player stops playback

During play, perform steps 1 - 3.

To cancel the OFF TIMER function

Perform steps 1 - 3, changing the OFF TIMER setting to "OFF."

Locking the controls (HOLD)

You can lock the controls on your CD player to prevent accidental button presses. The OPERATION lamp flashes if you press any button when the HOLD function is activated.

Slide HOLD in the direction of the arrow.

You can use the HOLD function with both the CD player and the remote control. You can still operate your CD player using the remote control when HOLD on the remote control is set to off.

To unlock the controls

Slide HOLD in the direction opposite to that of the arrow.

Note

Even if the HOLD function is working, "HOLD" will not appear in the display of the remote control.

Turning off the beep sound

You can turn off the beep sound that is heard from your headphones/earphones when you operate your CD player.

1 Press DISPLAY until the display changes. (CD player: Press DISPLAY/MENU until the MENU screen appears. Turn the jog dial to select "OPTION," then press DISPLAY/MENU.)

2 Flick the jog lever toward **◀◀** or **▶▶** to select “BEEP,” then press the jog lever to enter the selection. (CD player: Turn the jog dial to select “BEEP,” then press **DISPLAY/MENU** to enter the selection.)

3 Flick the jog lever toward **◀◀** or **▶▶** to select “OFF,” then press the jog lever to enter the selection. (CD player: Turn the jog dial to select “OFF,” then press **DISPLAY/MENU** to enter the selection.)

To turn on the beep sound

Perform steps 1 - 3, changing the BEEP setting to “ON.”

Saving power

You can select lighting options for the LCD backlight on the remote control and the OPERATION lamp on the CD player so that you can save battery power.

1 Press **DISPLAY** until the display changes. (CD player: Press **DISPLAY/MENU** until the MENU screen appears. Turn the jog dial to select “OPTION,” then press **DISPLAY/MENU**.)

2 Flick the jog lever toward **◀◀** or **▶▶** to select “LIGHT,” then press the jog lever to enter the selection. (CD player: Turn the jog dial to select “LIGHT,” then press **DISPLAY/MENU** to enter the selection.)

3 Flick the jog lever toward **◀◀** or **▶▶** to select “LIGHT OFF” or “LIGHT 2,” then press the jog lever to enter the selection. (CD player: Turn the jog dial to select “LIGHT OFF” or “LIGHT 2,” then press **DISPLAY/MENU** to enter the selection.)

About the LIGHT setting

Setting	OPERATION lamp on the CD player	LCD backlight on the remote control
LIGHT OFF	Turned off	Turned off
LIGHT 1	Lights up fully during play or during operation	Lights up for about 5 seconds when you press a button and also lights up between tracks
LIGHT 2*	Lights up with less brightness during play or during operation	Lights up for about 5 seconds when you press a button

* You can save power by selecting “LIGHT 2” rather than “LIGHT 1.”

The LCD backlight on the remote control

The LCD backlight is always turned on when you are using the AC power adaptor.

Playing tracks continuously (SEAMLESS) (ATRAC CD only)

You can play live concert music, etc. without space between the tracks.

- 1** While play is stopped, press **DISPLAY** until the display changes. (CD player: While play is stopped, press **DISPLAY/MENU** until the **MENU** screen appears. Turn the jog dial to select “**OPTION**,” then press **DISPLAY/MENU**.)
 - 2** Flick the jog lever toward **I◀◀** or **▶▶I** to select “**SEAMLESS**,” then press the jog lever to enter the selection. (CD player: Turn the jog dial to select “**SEAMLESS**,” then press **DISPLAY/MENU** to enter the selection.)
 - 3** Flick the jog lever toward **I◀◀** or **▶▶I** to select “**ON**,” then press the jog lever to enter the selection. (CD player: Turn the jog dial to select “**ON**,” then press **DISPLAY/MENU** to enter the selection.)
-

Note

The tracks may not play continuously depending on how the source music was recorded.

Connecting a stereo system

You can listen to CDs through a stereo system and record CDs on a cassette tape or a MiniDisc. For details, see the instruction manual that comes with the device you want to connect.

Be sure to turn off all devices before making connections.

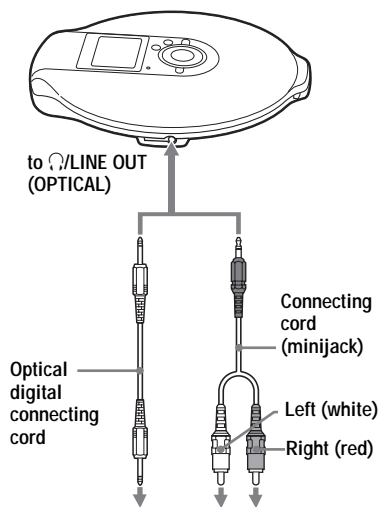

MiniDisc recorder, DAT deck, etc.

Stereo system, cassette recorder, radio cassette recorder, etc.

1 While play is stopped, press **DISPLAY** until the display changes. (CD player: While play is stopped, press **DISPLAY/MENU** until the **MENU** screen appears. Turn the jog dial to select “**OPTION**,” then press **DISPLAY/MENU**.)

2 Flick the jog lever toward **◀◀** or **▶▶** to select “**AUDIO OUT**,” then press the jog lever to enter the selection. (CD player: Turn the jog dial to select “**AUDIO OUT**,” then press **DISPLAY/MENU** to enter the selection.)

3 Flick the jog lever toward **◀◀** or **▶▶** to select the setting appropriate for the connected device, then press the jog lever to enter the selection. (CD player: Turn the jog dial to select the setting, then press **DISPLAY/MENU** to enter the selection.)

Connected device*	Setting
Headphones	“HP”
Device connected using the connecting cord	“LINE”

* When you connect the device using the optical digital connecting cord, you do not have to choose the setting. The setting will be switched to that for an optical connection automatically.

(Continued)

Connecting a stereo system

Notes

- Before you play a CD, turn down the volume of the connected device to avoid damaging the connected speakers.
- Use the AC power adaptor for recording. If you use the rechargeable battery or dry battery as a power source, the battery may become completely depleted during recording.
- Adjust the volume properly on the connected device so that the sound will not be distorted.
- This CD player uses the Serial Copy Management System, which allows only first-generation digital copies to be made.
- When recording or playing an ATRAC CD/MP3 CD using a connected device, use only the analog connecting cord.
- If you change the connected device, make sure to change the "AUDIO OUT" setting.

When the headphones or other devices are connected to the /LINE OUT (OPTICAL) jack

When an optical digital connecting cord is connected, the output is automatically switched to an optical digital output.

When a remote control or a connecting cord is connected, the current AUDIO OUT setting ("HP" or "LINE") flashes for about 5 seconds.

If you connect another device to the /LINE OUT (OPTICAL) jack, first remove the device and connect the headphones again, then switch the AUDIO OUT setting to "HP".

When AUDIO OUT is set to "LINE"

You cannot adjust the volume using VOL +/- on the CD player or the remote control.

When using an optical digital connecting cord

To record a CD on a MiniDisc, DAT, etc., make sure that the CD player is paused before starting the recording procedures.

About the G-PROTECTION and equalizer functions when using the connecting cord or the optical digital connecting cord

- To record high quality CD sound, set the G-PROTECTION setting to "G-PRO 1" on the menu.
- If the AUDIO OUT setting is set to "LINE," the parametric equalizer function does not work.

► Connecting to a power source

You can check the remaining power of the battery in the display.





Lobatt*

* Beep sounds.

When the battery is depleted, charge the rechargeable battery or replace the dry battery with new one.

- Using the rechargeable battery (this page)
- Using the dry battery (page 35)

Notes

- The indicator sections of  roughly show the remaining battery power. One section does not always indicate one-fourth of the battery power.
- Depending on operating conditions, the indicator sections of  may increase or decrease.
- When using the rechargeable battery and dry battery together to extend power, use a fully charged rechargeable battery and new dry battery.

For the battery life and charging time of the rechargeable battery, see "Specifications."

Using the rechargeable battery

Charge the rechargeable battery before using it for the first time. To keep the original battery capacity for a long time, charge the battery only when it is completely depleted. You can use only the following rechargeable battery for your CD player.

- NH-14WM (supplied)

- 1 Squeeze OPEN from both sides to open the lid of your CD player, then open the battery compartment lid inside the player.**

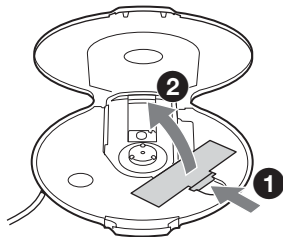

- 2 Insert the rechargeable battery by matching the ⊕ to the diagram in the battery compartment and close the lid until it clicks into place.**

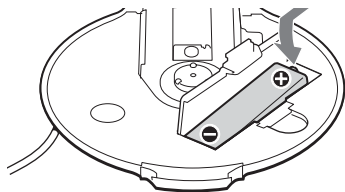

Insert the ⊖ end first.

(Continued)

3 Connect the AC power adaptor to the DC IN 3 V jack of the supplied charging stand and an AC outlet. Then place the CD player on the supplied charging stand (page 15).

Charging of the battery starts.

In the display of the remote control, "Charging" indication flashes and the indicator sections of  light up in succession. The OPERATION lamp lights up on the CD player.

When the battery is completely charged, all indications on the display disappear and the OPERATION lamp goes off.

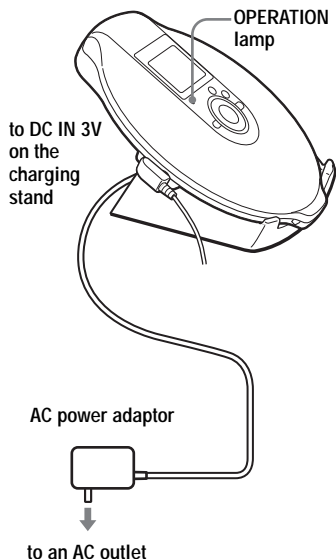

Notes on the supplied charging stand

- The supplied charging stand can be used only with this CD player. No other model can be charged using this stand.

- When using the supplied charging stand, charge the rechargeable battery only. Do not charge any other battery.
- During charging, the CD player and the rechargeable battery become hot. This poses no danger.
- Do not place coins or other metallic objects on the charging stand. If the terminal on the charging stand is accidentally brought into contact with a metallic object, it may short-circuit and begin to heat up.

To charge the rechargeable battery without using the supplied charging stand

- 1 Perform steps 1 and 2 of "Using the dry battery" (page 35) to attach the external battery case to the CD player.
- 2 While keeping sliding the switch on the external battery case in the direction of the arrow, connect the AC power adaptor.
- 3 Push the 5-way control key toward /CHG. Charging starts.

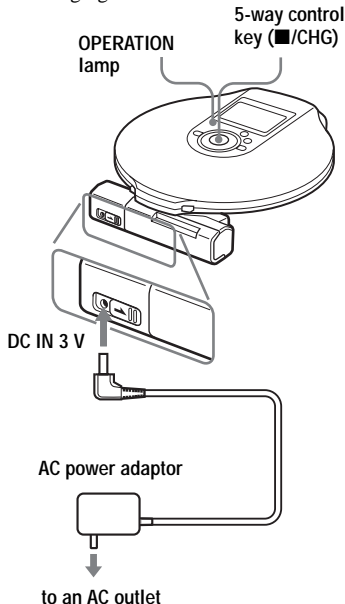

Notes

- During charging, the CD player and the rechargeable battery become hot. This poses no danger.
- If you push the 5-way control key toward ►|| during charging, charging stops and playback of the CD starts.
- If you place the CD player on the charging stand during play, play stops and charging starts.
- Place the CD player on the charging stand securely. Make sure that the OPERATION lamp on the CD player lights up. Wrong placement interrupts charging or play.

To remove the rechargeable battery

Push ⊖ end to remove the battery.

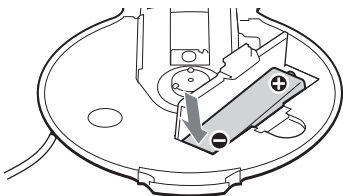

When to replace the rechargeable battery

If the battery life becomes shorter by about half, replace the battery with new rechargeable battery.

Note on the rechargeable battery

If the battery is new or has not been used for a long time, it may not be charged completely. In that case, charge it until the OPERATION lamp goes off and then use the CD player until the battery is depleted completely ("Lobatt" appears in the display). Repeat this procedure several times.

Note on carrying the rechargeable battery

Use the supplied battery carrying case to prevent unexpected heat. If the rechargeable battery and the metallic objects are contacted, heat or fire may occur due to a short circuit.

Using the dry battery

You can extend power by inserting a rechargeable battery in the CD player and attaching the external battery case.

- 1** Insert the LR6 (size AA) alkaline battery (not supplied) by matching the ⊕ to the diagram inside the battery case and close the battery case lid.

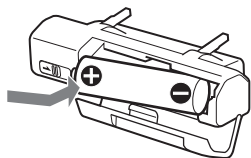

- 2** Attach the battery case to the CD player securely and fasten the screw in the direction of LOCK.

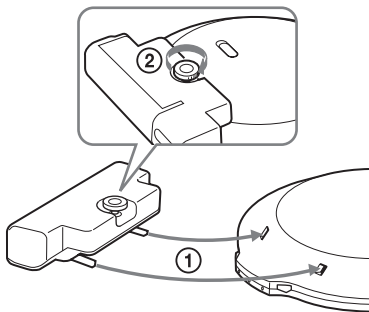

Notes

- If the switch on the external battery case is slid in the direction of the arrow during play, play may stop.
- When the battery is depleted, replace the battery with new one.
- The battery in the CD player and that in the external battery case are discharged simultaneously.

Notes on the power source

Disconnect all power sources when the CD player is not used for a long time.

On AC power adaptor

- Use only the AC power adaptor supplied. If your CD player is not supplied with the one, use the AC-E30HG AC power adaptor. Do not use any other AC power adaptor. It may cause a malfunction.

Polarity of the plug



- Do not touch the AC power adaptor with wet hands.
- Connect the AC power adaptor to an easily accessible AC outlet. Should you notice an abnormality in the AC power adaptor, disconnect it from the AC outlet immediately.

On rechargeable batteries and dry batteries

- Do not charge the dry batteries.
- Do not throw the batteries into fire.
- Do not carry the batteries with coins or other metallic objects. It can generate heat if the positive and negative terminals of the battery are accidentally contacted by a metallic object.
- Do not mix rechargeable batteries with dry batteries.
- Do not mix new batteries with old ones.
- Do not use different types of batteries together.
- When the batteries are not to be used for a long time, remove them.
- If battery leakage occurs, wipe off any deposit in the battery compartment, and install new batteries. In case the deposit adheres to you, wash it off thoroughly.

List of menus

On the CD player, press DISPLAY/MENU until the MENU screen appears, then turn the jog dial to select the menu you want.

On the remote control, press SOUND (for the sound setting) or DISPLAY (for other settings) repeatedly.

CD player

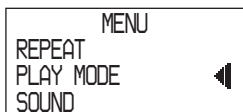

Remote control



To return to the previous screen, press ■ (CD player: press -*1).

To cancel the setting operation, press DISPLAY (for OPTION menu only) or ■ for 2 seconds or more (CD player: push the 5-way control key toward ■/CHG).

Items marked ● are default settings.

Setting sound (page)	Menu 1 →	Menu 2 →	Menu 3
Adjusting sound quality (25)	SOUND*2	● OFF SOFT ACTIVE HEAVY CUSTOM	—
Setting various functions (page)	Menu 1 →	Menu 2 →	Menu 3
Protecting against sound skipping (26)	OPTION	G-PROTECTION*4	● G-PRO 1 G-PRO 2
Protecting your hearing (27)	OPTION	AVLS	ON ● OFF
Stopping playback automatically (27)	OPTION	TIMER	10 min*3 ● OFF
Connecting a stereo system (31)	OPTION	AUDIO OUT*4	● HP LINE
Turning off the beep sound (28)	OPTION	BEEP	● ON OFF
Saving power (29)	OPTION	LIGHT	LIGHT OFF ● LIGHT 1 LIGHT 2
Playing tracks continuously (30)	OPTION	SEAMLESS*4, *5	ON ● OFF

*1 When "PGM" is not displayed.

*2 Displayed on the CD player only.

*3 Default setting. If you have changed the setting, the length of time already set appears.

*4 You can make these settings while play is stopped.

*5 For ATRAC CD only

Precautions

On safety

- Should any solid objects or liquid fall into the CD player, unplug it and have it checked by qualified personnel before operating it any further.
- Do not put any foreign objects in the DC IN 3 V (external power input) jack.

On the CD player

- Keep the lens on the CD player clean and do not touch it. If you do so, the lens may be damaged and the CD player will not operate properly.
- Do not put any heavy object on top of the CD player. The CD player and the CD may be damaged.
- Do not leave the CD player in a location near heat sources, or in a place subject to direct sunlight, excessive dust or sand, moisture, rain, mechanical shock, unlevelled surface, or in a car with its windows closed.
- If the CD player causes interference to the radio or television reception, turn off the CD player or move it away from the radio or television.
- Discs with non-standard shapes (e.g., heart, square, star) cannot be played on this CD player. Attempting to do so may damage the CD player. Do not use such discs.

On handling CDs

- To keep the CD clean, handle it by its edge. Do not touch the surface.
- Do not stick paper or tape onto the CD.
- Do not expose the CD to direct sunlight or heat sources such as hot air ducts. Do not leave the CD in a car parked under direct sunlight.

On headphones/earphones

Road safety

Do not use headphones/earphones while driving, cycling, or operating any motorized vehicle. It may create a traffic hazard and is illegal in some areas. It can also be potentially dangerous to play your headsets at high volume while walking, especially at pedestrian crossings. You should exercise extreme caution or discontinue use in potentially hazardous situations.

Preventing hearing damage

Avoid using headphones/earphones at high volume. Hearing experts advise against continuous, loud and extended play. If you experience a ringing in your ears, reduce volume or discontinue use.

Consideration for others

Keep the volume at a moderate level. This will allow you to hear outside sounds and to be considerate to the people around you.

Maintenance

To clean the casing

Use a soft cloth slightly moistened in water or a mild detergent solution. Do not use alcohol, benzine or thinner.

To clean the terminals

If the terminals on the charging stand become dirty, the battery may not be charged properly. Clean the terminals with a cotton swab or a dry cloth periodically as illustrated below.

Terminals

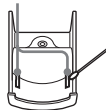

Troubleshooting

Should any problem persist after you have checked these symptoms, consult your nearest Sony dealer.

Symptom	Cause and/or corrective action
The volume does not increase even if you turn VOL +/- in the + direction repeatedly (even if you press VOL + repeatedly on the CD player).	<ul style="list-style-type: none">→ AVLS is set to "ON." Set it to "OFF." (page 27)→ AUDIO OUT is set to "LINE." Set it to "HP." (page 31)
No sound, or noise is heard.	<ul style="list-style-type: none">→ Connect the headphones/earphones plugs firmly. (page 15)→ Plugs are dirty. Clean the headphones/earphones plugs with a dry soft cloth periodically.
Certain files cannot be played.	<ul style="list-style-type: none">→ You tried to play files saved in a format that is not compatible with this CD player. (page 6)
The playing time is too short when powered with the dry battery.	<ul style="list-style-type: none">→ Check that you are using an alkaline battery and not manganese battery. (page 35)→ Replace the battery with a new LR6 (size AA) alkaline battery. (page 35)
The playing time is too short when powered with the rechargeable battery.	<ul style="list-style-type: none">→ Charge and discharge the rechargeable battery several times. (pages 33 - 35)
"Lobatt" appears in the display. The CD does not play.	<ul style="list-style-type: none">→ The rechargeable battery is used up completely. Charge the battery. (pages 33 - 35)→ Replace the battery with a new LR6 (size AA) alkaline battery. (page 35)
"HI dc In" appears in the display.	<ul style="list-style-type: none">→ An AC power adaptor which is rated higher than the one supplied or recommended is being used. Use only the supplied AC power adaptor or the car battery cord recommended in "Optional accessories." (page 43)

(Continued)

Symptom	Cause and/or corrective action
The CD does not play or "No disc" appears in the display when a CD is placed in the CD player.	<ul style="list-style-type: none"> → The CD is dirty or defective. → Check that the CD is inserted with the label side up. (page 15) → Moisture condensation has occurred. Leave the CD player aside for several hours until the moisture evaporates. → Close the lid of the battery compartment firmly. (page 33) → Make sure the battery is inserted correctly. (pages 33, 35) → Connect the AC power adaptor to an AC outlet securely. (page 15) → Press the jog lever (CD player: Push the 5-way control key toward ►) after one second or more has passed since the AC power adaptor was connected. → The CD-R/RW is blank. → There is a problem with the quality of the CD-R/RW, recording device, or application software.
OPERATION lamp flashes on the CD player when you press a button, and the CD does not play.	<ul style="list-style-type: none"> → The buttons are locked. Slide the HOLD switch back. (page 28)
Cannot adjust the volume.	<ul style="list-style-type: none"> → AUDIO OUT is set to "LINE." Adjust the volume using the volume control on the connected device. (page 31) → Set AUDIO OUT to "HP." Adjust the volume using VOL +/- on the CD player. (page 31)
During recording with optical digital connection, the track number cannot be recorded correctly.	<ul style="list-style-type: none"> → Record the track number again using a MiniDisc recorder, DAT recorder, etc. (page 31) → See the instruction manual that comes with the recording device. (page 31)
The rechargeable battery cannot be charged.	<ul style="list-style-type: none"> → The rechargeable battery is not inserted in the battery compartment. → The terminals of the charging stand are dirty. Wipe them with a soft, dry cloth. (page 38) → The CD is playing. Turn it off. → The CD player is not placed correctly on the charging stand. Place the player on the stand securely and make sure that the OPERATION lamp lights up. (page 34)
Playback starts from the point you stopped. (resume function)	<ul style="list-style-type: none"> → The resume function is working. To start play from the first track, press the jog lever during stop (CD player: push and hold the 5-way control key toward ►) until the first track starts playing, or open the lid of the CD player. Or remove all power sources, then insert the battery or connect the AC power adaptor again. (pages 15, 16, 33, 35)
Rustling noise is heard from the CD.	<ul style="list-style-type: none"> → Close the lid of the battery compartment firmly. (page 33)
When using with a connected stereo system, the sound is distorted or noisy.	<ul style="list-style-type: none"> → AUDIO OUT is set to "LINE." Adjust the volume of the connected device. (page 31) → AUDIO OUT is set to "HP." Adjust the volume using VOL +/- on the CD player. (page 31)

Symptom	Cause and/or corrective action
During playback of an ATRAC CD or MP3 CD, the CD does not rotate but you can hear the sound normally.	→ The CD player is designed to stop the rotation of an ATRAC CD or MP3 CD during playback to reduce the power consumption. The player is not malfunctioning.
"NO FILE" appears on the display after you press the jog lever (CD player: after you push the 5-way control key toward ►) or when the lid of the CD player is closed.	<ul style="list-style-type: none"> → There are no ATRAC3plus/ATRAC3/MP3 files in the CD. → A CD-R/RW from which the data has been erased is being used. → The CD is dirty.
When closing the lid of the CD player, the CD starts to rotate.	→ The CD player is reading the information on the CD. The player is not malfunctioning.
The LCD display becomes hard to see or slows down.	→ You are using your CD player at high temperatures (above 40°C/104°F) or at low temperatures (below 0°C/32°F). At room temperature, the display will return to its normal operating condition.
"⚡" is flashing quickly on the display of the remote control, and you cannot locate the beginning of the track or a specific point in the track.	→ The CD player has entered the preparation stage of Bookmark track play. Change the PLAY MODE setting to "ALL."
You cannot operate the CD player properly using the remote control.	→ The buttons on the CD player are kept pressed by mistake.
Play stopped abruptly.	→ OFF TIMER has been set. Change the setting to "OFF."

Specifications

System

Compact disc digital audio system

Laser diode properties

Material: GaAlAs

Wavelength: $\lambda = 770 - 800 \text{ nm}$

Emission duration: Continuous

Laser output: Less than $44.6 \mu\text{W}$

(This output is the value measured at a distance of 200 mm from the objective lens surface on the optical pick-up block with 7 mm aperture.)

D-A conversion

1-bit quartz time-axis control

Frequency response

20 - 20 000 Hz ± 1 dB (measured by JEITA)

Output (at 3 V input level)

Line output (stereo minijack)

Output level 0.7 V rms at 47 k Ω

Recommended load impedance over 10 k Ω

Headphones (stereo minijack)

Approx. 5 mW + Approx. 5 mW at 16 Ω

(Approx. 1.5 mW + Approx. 1.5 mW at 16 Ω)*

*For the customers in Europe

Optical digital output (optical output connector)

Output level: -21 - -15 dBm

Wavelength: 630 - 690 nm at peak level

Power requirements

- Sony NH-14WM rechargeable battery: 1.2 V DC \times 1
- LR6 (size AA) battery: 1.5 V DC \times 1
- AC power adaptor (DC IN 3 V jack):
220 V, 50 Hz (Model for China)
120 V, 60 Hz (Model for Mexico)

Battery life*1 (approx. hours)

When you use the CD player on a flat and stable surface.

When LIGHT mode and SOUND mode are set to "OFF."

Playing time varies depending on how the CD player is used.

When using one NH-14WM (charged for about 5 hours*2)

	G-PROTECTION	
	"G-PRO 1"	"G-PRO 2"
Audio CD	20	20
ATRAC CD*3	35	35
MP3 CD*4	28	28

When using external battery case (one alkaline battery*5)

	G-PROTECTION	
	"G-PRO 1"	"G-PRO 2"
Audio CD	30	30
ATRAC CD*3	50	50
MP3 CD*4	40	40

When using one NH-14WM and external battery case (one alkaline battery*5)

	G-PROTECTION	
	"G-PRO 1"	"G-PRO 2"
Audio CD	50	50
ATRAC CD*3	85	85
MP3 CD*4	70	70

*1 Measured value by the standard of JEITA (Japan Electronics and Information Technology Industries Association)

*2 Charging time varies depending on how the rechargeable battery is used.

*3 Recorded at 48 kbps

*4 Recorded at 128 kbps

*5 When using Sony alkaline battery LR6 (SG) (produced in Japan)

Operating temperature

5°C - 35°C (41°F - 95°F)

Dimensions (w/h/d) (excluding projecting parts and controls)

Approx. 127 × 21.8 × 139.4 mm

(5 × 7/8 × 5 1/2 in.)

Mass (excluding accessories)

Approx. 168 g (6.0 oz.)

US and foreign patents licensed from Dolby Laboratories.

Design and specifications are subject to change without notice.

Optional accessories

AC power adaptor*	AC-E30HG
Active speaker system	SRS-Z1 SRS-Z30
Car battery cord	DCC-E345
Car battery cord with car connecting pack	DCC-E34CP
Car connecting pack	CPA-9C
Connecting cord	RK-G129 RK-G136
Earphones (except for the customers in France)	MDR-EX71SL MDR-Q55SL
Earphones (for the customers in France)	MDR-E808SP

* Specifications for AC power adaptors vary for each area. Check your local voltage and the shape of the plug before purchasing.

Your dealer may not handle some of the accessories listed above. Please ask the dealer for detailed information about the accessories in your country/region.

This warranty is valid only in the United States.

SONY[®]

Portable Memory Stick Audio Player/
Portable MiniDisc Recorder/
Portable CD Player

Portable Audio

LIMITED WARRANTY

Sony Electronics Inc. ("Sony") warrants this Product (including any accessories) against defects in material or workmanship as follows:

1. **LABOR:** For a period of 90 days from the date of purchase, if this Product is determined to be defective, Sony will repair or replace the Product, at its option, at no charge, or pay the labor charges to any Sony authorized service facility. After the Warranty Period, you must pay for all labor charges.

2. **PARTS:** In addition, Sony will supply, at no charge, new or rebuilt replacements in exchange for defective parts for a period of one (1) year. After 90 days from the date of purchase, labor for removal and installation is available from Sony authorized service facilities or a Sony Service Center at your expense.

To obtain warranty service, you must take the Product, or deliver the Product freight prepaid, in either its original packaging or packaging affording an equal degree of protection, to any authorized Sony service facility.

This warranty does not cover customer instruction, installation, set up adjustments or signal reception problems.

This warranty does not cover cosmetic damage or damage due to acts of God, accident, misuse, abuse, negligence, commercial use, or modification of, or to any part of the Product, including the antenna. This warranty does not cover damage due to improper operation or maintenance, connection to improper voltage supply, or attempted repair by anyone other than a facility authorized by Sony to service the Product. This warranty does not cover Products sold AS IS or WITH ALL FAULTS, or consumables (such as fuses or batteries). This warranty is valid only in the United States.

Proof of purchase in the form of a bill of sale or receipted invoice which is evidence that the unit is within the Warranty period must be presented to obtain warranty service.

This warranty is invalid if the factory applied serial number has been altered or removed from the Product.

REPAIR OR REPLACEMENT AS PROVIDED UNDER THIS WARRANTY IS THE EXCLUSIVE REMEDY OF THE CONSUMER. SONY SHALL NOT BE LIABLE FOR ANY INCIDENTAL OR CONSEQUENTIAL DAMAGES FOR BREACH OF ANY EXPRESS OR IMPLIED WARRANTY ON THIS PRODUCT. EXCEPT TO THE EXTENT PROHIBITED BY APPLICABLE LAW, ANY IMPLIED WARRANTY OF MERCHANTABILITY OR FITNESS FOR A PARTICULAR PURPOSE ON THIS PRODUCT IS LIMITED IN DURATION TO THE DURATION OF THIS WARRANTY.

Some states do not allow the exclusion or limitation of incidental or consequential damages, or allow limitations on how long an implied warranty lasts, so the above limitations or exclusions may not apply to you. In addition, if you enter into a service contract with the Sony Partnership within 90 days of the date of sale, the limitation on how long an implied warranty lasts does not apply to you. This warranty gives you specific legal rights, and you may have other rights which vary from state to state.

For your convenience, Sony Electronics Inc. has established telephone numbers for frequently asked questions:

To locate the servicer or dealer nearest you, or for service assistance or resolution of a service problem, or for product information or operation, contact:

www.sony.com/walkmansupport

Sony Network Portable Audio Support Line
1-866-456-7669

For an accessory or part not available from your authorized dealer, call:

1-800-488-SONY (7669)

D 324343303

<http://www.sony.net/>



Sony Corporation Printed in Malaysia

* 3 2 5 8 4 0 5 1 3 * (1)

Download from Www.Somanuals.com. All Manuals Search And Download.

Free Manuals Download Website

<http://myh66.com>

<http://usermanuals.us>

<http://www.somanuals.com>

<http://www.4manuals.cc>

<http://www.manual-lib.com>

<http://www.404manual.com>

<http://www.luxmanual.com>

<http://aubethermostatmanual.com>

Golf course search by state

<http://golfingnear.com>

Email search by domain

<http://emailbydomain.com>

Auto manuals search

<http://auto.somanuals.com>

TV manuals search

<http://tv.somanuals.com>