

SONY[®]



Operation Guide

NW-S202F / S203F / S205F / S202

About the Manuals

Included with the player are the Quick Start Guide and this PDF-format Operation Guide. Additionally, after installing SonicStage software from the supplied CD-ROM, you can refer to the Help within SonicStage.

- The Quick Start Guide explains set up and the basic operations, enabling you to import songs to a computer, to transfer them to the player, and to play them back.
- This Operation Guide explains standard and advanced features, enabling you to make full use of the player and troubleshoot problems.
- The SonicStage Help explains details about using SonicStage software (🔍 page 3).

Browsing the Operation Guide

To use the buttons in the Operation Guide

Click the buttons located in the upper right of this manual to jump to “Table of Contents,” “Home Menu List,” or “Index.”

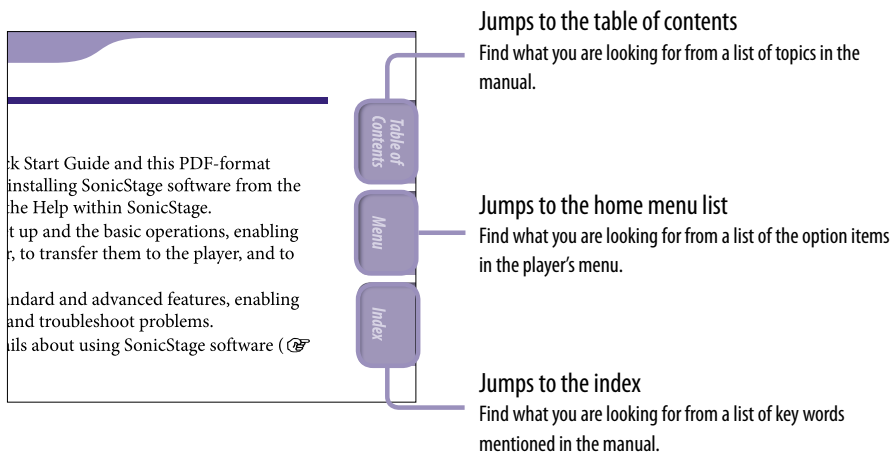

💡 Hints

- You can jump to the indicated page by clicking a page number in the table of contents, in the home menu list, or in the index.
- You can jump to the indicated page by clicking a page reference indication (e.g. 🔍 page 3) on each page.
- To search for a reference page by keyword, click the “Edit” menu, select “Search” of the Adobe Reader to display the navigation frame, type the keyword into the Search text box, and click “Search.”
- You can jump to the previous or next page by clicking the ⏪ and ⏩ buttons located at bottom of the Adobe Reader screen.

Continued ↓

To change the page layout

The buttons at the bottom of the Adobe Reader screen enable you to select how pages are displayed.



Single Page

Pages are displayed one at a time. When you scroll, the display changes to a previous or succeeding page.

Continuous

Pages are displayed as a continuous roll of pages. When you scroll, the previous and next pages scroll up or down continuously.

Continuous - Facing

Two pages are displayed side by side with each pair part of a continuous roll of pages. When you scroll, the previous and next pairs of pages scroll up or down continuously.

Facing

Two pages are displayed side by side. When you scroll, the display changes to previous or succeeding pairs of pages.

Using SonicStage Help

Refer to SonicStage Help for details about using SonicStage, such as importing songs to your computer and transferring songs to the player.

- 1 **Click “Help” – “SonicStage Help” while SonicStage is running.**
Help appears.

Note

- In SonicStage Help, the player is referred to as “ATRAC Audio Device.”

Table of Contents

Supplied Accessories	6
Home Menu List.....	8
Parts and Controls	9

Playing Songs

Playing Songs (ALL SONGS)	13
Playing Lists of Songs (PLAYLIST)	14
Searching for Songs (SEARCH).....	15
Searching for songs by song name (Song).....	15
Searching for songs by artist (Artist).....	16
Searching for songs by album (Album).....	17
Changing the Play Mode (Play Mode)	18
Changing the play mode by shaking the player 3 times (Shuffle Shake)	20

Playing songs during exercise

Playing songs to a set target (Set Target).....	21
Playing songs in automatic selection mode depending on your exercise pace (Music Pacer).....	23
Changing the playlists of the automatic song selection (Set Playlist).....	25
Using the stop watch function (STOPWATCH)	26

Settings

Changing the Display Mode	27
Changing the Song Order (Sort).....	29
Setting the Volume Using the Preset Volume Function (Volume Mode)	30
Setting a volume level for preset mode (Preset)	30
Switching to manual mode (Manual).....	32
Customizing Sound Quality (Equalizer).....	33
Registering a Desired Sound Quality (Preset Custom).....	34
Adjusting the Volume Level (Dynamic Normalizer)	35
Limiting the Volume (AVLS).....	36
Turning Off the Beep Sound (Beep).....	37
Setting the information for calorie- count and distance (Height/Weight)	38

Setting the G Sensor (G Sensor)	40
Displaying step count history (Count History).....	42
Setting the reset method of the step count (Counter Reset)	43
Adjusting the Current Time Setting (Set Date-Time).....	44
Setting the Date Format (Date Disp Type)	46
Setting the Time Format (Time Disp Type)	47
Displaying the Player Information (Information)	48
Resetting to Factory Settings (Reset All Setting)	49
Formatting Memory (Format).....	50
Changing the USB Connection Setting (USB Power)	52
Setting the Display's Left/Right Orientation (Disp. Rotation)	53
Saving Power Consumption (Power Save)	54

Listening to FM Radio (NW-S202F/S203F/S205F only)

Enjoy Listening to FM Radio	55
1 Switching to the FM tuner	55
2 Presetting broadcast stations automatically (FM Auto Preset).....	56
3 Selecting broadcast stations	57
Presetting Desired Broadcast Stations	59
To delete preset broadcast stations	59
Setting the Reception (Scan Sens).....	60
Changing the Monaural/Stereo (Mono/Auto)	61

Continued ↓

Advanced Features

Recharging the Player	62
Maximizing Battery Life	63
What are Format and Bit Rate?.....	64
Playing Songs Without Pauses.....	65
How is Song Information Imported to the Player?.....	66
Storing Data Other Than Audio Files	67
Upgrading the Player's Firmware	68

Troubleshooting

Troubleshooting.....	69
Messages.....	76
Uninstalling SonicStage.....	80

Additional Information

Precautions	84
On Copyrights	88
Specifications	89
Index	92

Note

- Depending on the country/region in which you have purchased the player, some models may not be available.

Supplied Accessories

Please check the accessories in the package.

- Headphones (1)
- USB cable (1)
- Arm band* (1)
- Clip* (1)

This is used to clip onto your clothes when carrying the player.

- CD-ROM** (1)
 - SonicStage software
 - Operation Guide (PDF file)
- Quick Start Guide (1)

* The supplied items may differ depending on the country/region in which you have purchased the player.

** Do not attempt to play this CD-ROM in an audio CD player.

Attaching the player with the arm band

Attach the player with the arm band following the procedure below.

- 1 Open the touch fastener, put your arm through the arm band, and then close the touch fastener temporarily.**
- 2 Slide the player (display facing up) into the holder of the arm band.**
Insert the player until it clicks.

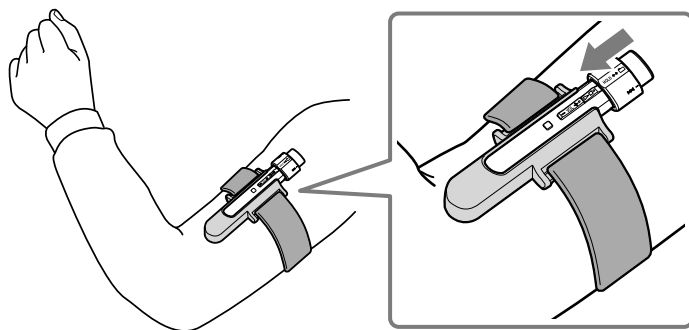

- 3 Adjust the display for best viewing angle, and fasten the belt with the touch fastener securely, so it was not fall off.**

Continued ↓

To remove the player from the arm band

Pull the tab on the undersurface of the arm band's holder in the direction of the arrow ① to detach the player, then release the player from the arm band's holder ②.

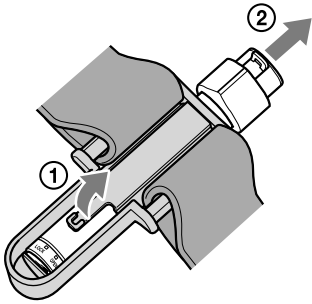

Attaching the player with the clip

Slide the player (display facing up) on the clip. Insert the player until it clicks.

To remove the player from the clip

Flex open the bottom position of the clip slightly in the direction of ∇ to detach the player ①, then release the player from the clip ②.

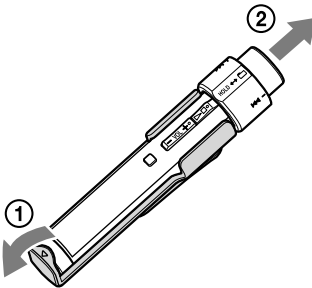

About the serial number

The serial number provided for this player is required for the customer registration. The number is on the rear of the player.

You can also check the serial number on this player. See  page 48 for details.

Home Menu List

You can display the HOME screen by pressing and holding the DISP/HOME button of the player.

The HOME screen is the starting point to play audio, search for songs, and change settings such as follows.

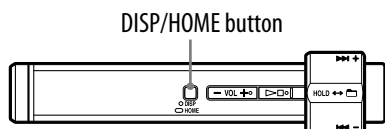

HOME screen*



* 5 of the 7 icons appear in the display with the current selection in the centre. The current icon changes depending on the function you use. By rotating the shuttle switch, you can select an icon and press the **▶■** button to confirm.

🔍 (SEARCH)

- Song.....15
- Artist.....16
- Album.....17

🏃 (SPORTS MODE)

- Start.....21
- Set Target.....21
- Set Playlist.....25
- Music Pacer.....23

🕒 (STOPWATCH)..... 26

🎵 (ALL SONGS)..... 13

📻 (FM)* 55

📁 (PLAYLIST) 14

🛠️ (SETTINGS)

- Play Mode.....18
- Sort.....29
- Scan Sens*60
- Mono/Auto*61
- FM Auto Preset*56
- Advanced Menu
 - Sound
 - Volume Mode.....30
 - Preset Custom34
 - AVLS.....36
 - Beep37
 - D.Normalizer.....35
 - Height/Weight.....38
 - G Sensor40
 - Date-Time
 - Set Date-Time44
 - Date Disp Type.....46
 - Time Disp Type.....47
 - Information.....48
 - Initialize
 - Reset All Setting.....49
 - Format50
 - USB Power52
 - Disp. Rotation.....53
 - Power Save54
 - Count History.....42
 - Counter Reset.....43
 - Equalizer.....33

* NW-S202F/S203F/S205F only

Parts and Controls

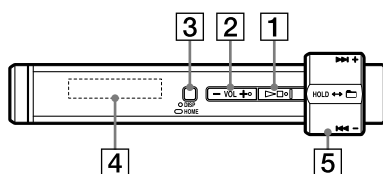

1 ▶■* button

Starts song playback. When starting playback, ▶ appears at the bottom left of the display, and if the ▶■ button is pressed again, ■ appears and playback stops.

When you press the ▶■ button, just after purchasing the player or after disconnecting the supplied USB cable from the computer, playback starts from the first song on the player.

When a menu appears on the display use this button to confirm the item of the menu.

3 DISP/HOME button

When you press this button while the player is in play or stop mode, you can change the display (🔗 page 27).

Press and hold this button to display the HOME screen.

While menus of the HOME screen appear, when this button is pressed again, the previous screen returns and when pressing and holding, the screen returns to the HOME screen.

4 Display

See 🔗 page 12.

💡 Hint

- There is no power button on the player. When you stop song playback or FM reception (NW-S202F/S203F/S205F only) by pressing the ▶■ button, after about a few seconds, the display goes off automatically and the player enters Sleep status. When the G Sensor menu is deactivated in Sleep status, the player consumes very little battery power.

2 VOL +*/- button

Adjusts the volume.

- * There are tactile dots. Use them to help with button operation.

Continued ↓

5 Shuttle switch

By rotating the shuttle switch, you can select a menu item, skip to the beginning of the song, or fast-forward /fast-rewind.

You can also set to the Folder control mode, Normal mode or HOLD by sliding the shuttle switch.

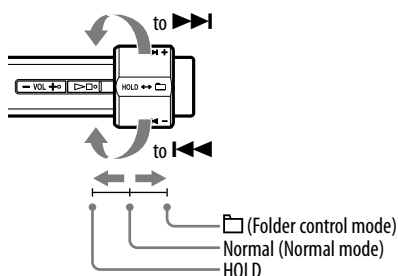

HOLD function

You can protect the player against accidental operation by using the HOLD function when carrying it. By sliding the shuttle switch to the HOLD position, all operation buttons are disabled. If you press buttons or rotate the shuttle switch while the HOLD function is activated, the current time, “HOLD” and ██████ (remaining battery indication) appear in the display. If you slide the shuttle switch back to the Folder control or Normal mode, the HOLD function is released.

To operate the player with the shuttle switch

Normal mode	
To	Operation
In play mode	
Skip to the beginning of the next song.	Rotate the shuttle switch to ▶▶▶ briefly.
Skip to the beginning of the current song.	Rotate the shuttle switch to ◀◀◀ briefly.
Fast-forwards the current song.	Rotate the shuttle switch to ▶▶▶ and release it at the desired point.
Fast-rewinds the current song.	Rotate the shuttle switch to ◀◀◀ and release it at the desired point.
In stop mode	
Skip to the beginning of the next song, and if held longer, continues to skip through the next song(s).	Rotate and hold the shuttle switch to ▶▶▶.
Skip to the beginning of the current song, and if held longer, continues to skip through the previous song(s).	Rotate and hold the shuttle switch to ◀◀◀.

Folder control mode	
To	Operation
In play mode	
Skip to the beginning of the next album/artist.	Rotate the shuttle switch to ▶▶▶ briefly.
Skip to the beginning of the current album/artist.	Rotate the shuttle switch to ◀◀◀ briefly.
In stop mode	
Skip to the beginning of the next album/artist, and if held longer, continues to skip through the next album/artist(s).	Rotate and hold the shuttle switch to ▶▶▶.
Skip to the beginning of the current album/artist, and if held longer, continues to skip through the previous album/artist(s).	Rotate and hold the shuttle switch to ◀◀◀.

Continued ↓

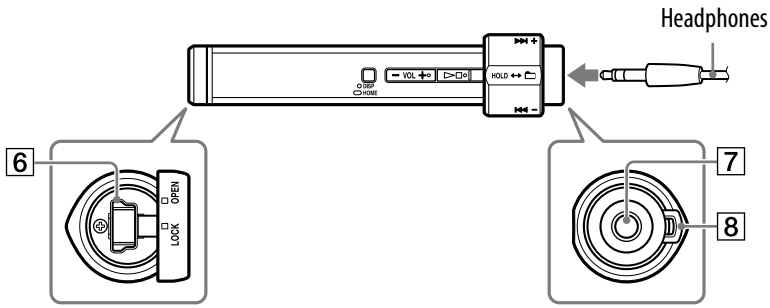

6 USB jack

Rotate the lid to the left to set the OPEN position, and then open. Connect the player to the small connector of the supplied USB cable. To close the lid, rotate it to set the OPEN position and close, then rotate it to the right to set the LOCK position.

7 Headphone jack

For connecting the headphones. Connect until it clicks into place. If the headphones do not connect properly, it may not sound right.

8 Strap hole



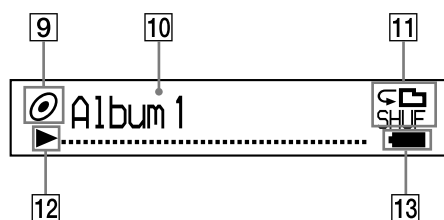

This is used to attach a strap (sold separately).

Continued ↓

Display



9 Sorting status indication (Sort) /

During playback operation, the  icon or the current song order icon ( (Artist order),  (Album order) or  (Albums by artist order)) appears.

In Normal mode, the  icon appears, and in Folder control mode, the song order icon appears.

10 Text/graphic information display

Displays album title, artist name, song name, current date and time, messages and menu.

During playback operation in Normal mode, “song title/artist name, album name” appears.







During playback operation in Folder control mode, “album title/artist name/playlist name” appears.

To change the display mode, press the DISP/HOME button ( page 27). Switch the display to Power Save mode when you do not operate the unit for a while.

11 Play mode indication (Play Mode)

Displays the current play mode icon ( page 18). If the play mode is set to “Normal,” no icon appears.

12 Playing status indication

Displays the current playback mode (: playback, : stop,  (): fast-rewinds (fast-forwards),  (): skips to the beginning of the current (or next) song).

13 Remaining battery indication

Displays the remaining battery power.

Hint

- For information on the FM tuner display (NW-S202F/S203F/S205F only), see “Enjoy Listening to FM Radio” ( page 55).

Playing Songs (ALL SONGS)

The songs on the player are played back.

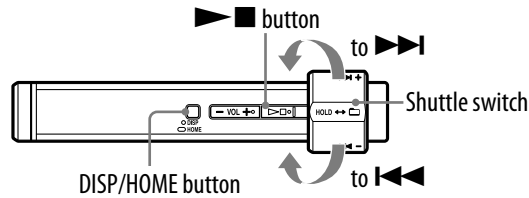

- 1 Press and hold the **DISP/HOME** button until the **HOME** screen appears.

- 2 Rotate the shuttle switch to select **♪ (ALL SONGS)** and press the **▶■** button to confirm.

All songs on the player appear and playback starts from the last song you listened to. If you did not play any song, playback starts from the beginning.

Playback continues in order through the last song and then stops.

To skip to the beginning of the song

By rotating the shuttle switch to **◀◀ (▶▶)** briefly while in play or stop mode, the player skips to the beginning of the current (or next) song.

If the shuttle switch is set to the folder position, and then rotated to **◀◀ (▶▶)** briefly while in play or stop mode, the player skips to the beginning of the current (or next) album/artist.

💡 Hints

- You can change the playing mode to random, repeat, etc., in the Play Mode menu (🔍 page 18).
- The songs appear in the order that you set in the Sort menu (🔍 page 29). The songs appear in the album order at the factory setting.

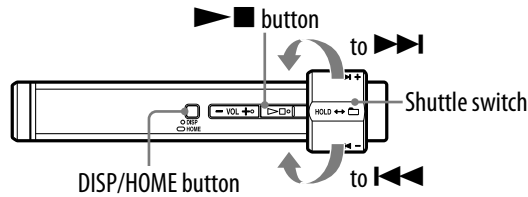

Playing Lists of Songs (PLAYLIST)

You can play lists of songs (Playlist) created in SonicStage. If you change a name in SonicStage, the changed name appears on the player. See the SonicStage Help for details.



Note

- When  (PLAYLIST) is selected,  (SEARCH) does not appear in the HOME screen.

- 1 **Press and hold the DISP/HOME button until the HOME screen appears.**
- 2 **Rotate the shuttle switch to select  (PLAYLIST) and press the  to confirm.**

The last song you listened to starts playback. If you did not play any song, playback starts from the first song of the first playlist. Playback continues in order through the last song and then stops.

To skip to the beginning of the song

By rotating the shuttle switch to  briefly while in play or stop mode, the player skips to the beginning of the current (or next) song.

If the shuttle switch is set to the folder position, and then rotated to  briefly while in play or stop mode, the player skips to the beginning of the current (or next) playlist.

Hint



- You can change the playing mode to random, repeat, etc., in the Play Mode menu ( page 18).

Searching for Songs (SEARCH)

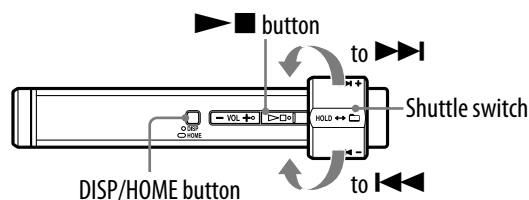
You can search for songs by “Song name,” “Artist name,” or “Album name.”



Searching for songs by song name (Song)

- 1 Press and hold the DISP/HOME button until the HOME screen appears.
- 2 Rotate the shuttle switch to select  (SEARCH) and press the .
- 3 Rotate the shuttle switch to select “Song>” and press the  button to confirm.

A list of songs appears on the player.

- 4 Rotate the shuttle switch to select a song and press the  button to confirm.



The song you selected starts playback. Playback continues in the order through the last song and then stops.

Hint

- The play mode set in the Play Mode menu ( page 18) does not change when a SEARCH is activated.

Continued 

Searching for songs by artist (Artist)

- 1 Press and hold the DISP/HOME button until the HOME screen appears.**
- 2 Rotate the shuttle switch to select  (SEARCH) and press the  button to confirm.**
- 3 Rotate the shuttle switch to select "Artist>" and press the  button to confirm.**

The artist lists appear.
- 4 Rotate the shuttle switch to select the desired artist and press the  button to confirm.**

The album lists for the selected artist appear.
- 5 Rotate the shuttle switch to select the desired album and press the  button to confirm.**

The song lists for the selected album appear.
- 6 Rotate the shuttle switch to select a song and press the  button to confirm.**





The song you selected starts playback. Playback continues in the order through the last song and then stops.

Hint

- The play mode set in the Play Mode menu ( page 18) does not change when a SEARCH is activated.

Continued 

Searching for songs by album (Album)

- 1 Press and hold the DISP/HOME button until the HOME screen appears.**
- 2 Rotate the shuttle switch to select  (SEARCH) and press the  button to confirm.**
- 3 Rotate the shuttle switch to select "Album>" and press the  button to confirm.**
The album lists appear.
- 4 Rotate the shuttle switch to select the desired album and press the  button to confirm.**
The song lists for the selected album appear.
- 5 Rotate the shuttle switch to select a song and press the  button to confirm.**
The song you selected starts playback. Playback continues in the order through the last song and then stops.

Hint





- The play mode set in the Play Mode menu ( page 18) does not change when a SEARCH is activated.

Changing the Play Mode (Play Mode)

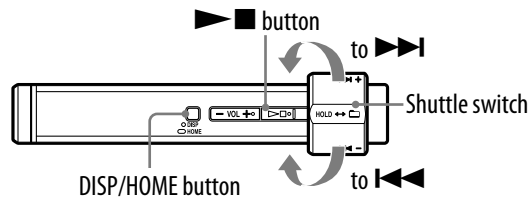
The player offers a variety of play modes, including random play and selected repeat play.

You can change the play mode by shaking the player 3 times (☞ page 20) after activating the G Sensor menu (☞ page 40).



- 1 Press and hold the DISP/HOME button until the HOME screen appears.
- 2 Rotate the shuttle switch to select  (SETTINGS) and press the  button to confirm.
- 3 Rotate the shuttle switch to select "Play Mode>" and press the  button to confirm.
- 4 Rotate the shuttle switch to select a play mode (☞ page 19) and press the  button to confirm.

To return to the previous menu

Press the DISP/HOME button.

Continued ↓

List of play modes

Play mode type/Icon	Description
Normal/No icon	All songs from the current song are played once, and then playback stops. (Default setting)
Folder/📁	All songs of an album (or artist)*, including the current song are played once, and then playback stops.
Repeat All (all repeat)/🔄	All songs from the current song are played repeatedly.
Repeat Folder (folder repeat)/🔄📁	All songs of an album (or artist)*, including the current song are played repeatedly.
Repeat 1 Song (one song repeat)/🔄1	The current song is played repeatedly.
Repeat Shuffle All (all song shuffle repeat)/ 🔄SHUF	The current song is played, and then all the songs are played in random order.
Repeat Shuffle Folder (folder shuffle repeat)/ 🔄📁SHUF	The current song is played, and then all songs of the album (or artist)* including the current song are played in random order.

- * If you set “Album” or “Artist/Album” in the Sort menu (🔍 page 29), the play range is an album. If you set “Artist” in the Sort menu, the play range is an artist.

Continued ↓

Changing the play mode by shaking the player 3 times (Shuffle Shake)

You can change the play mode (shuffle activated or deactivated) by shaking the player 3 times during playback.

Holding the player as illustrated below (display facing up), shake the player up and down 3 times in rhythm within two seconds. A sound effect is heard when shaking to change play mode.

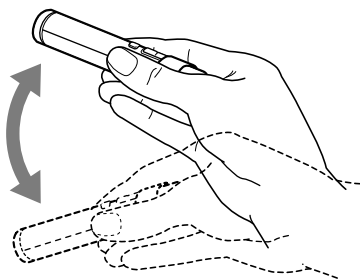

When the player is shaken 3 times again, the play mode returns to the previous mode.

List of play modes when shaking the player 3 times

Play mode type	Changes to
Normal	Repeat Shuffle All (all song shuffle repeat)
Folder	Repeat Shuffle Folder (folder shuffle repeat)
Repeat All (all repeat)	Repeat Shuffle All (all song shuffle repeat)
Repeat Folder (folder repeat)	Repeat Shuffle Folder (folder shuffle repeat)
Repeat 1 Song (one song repeat)	No change
Repeat Shuffle All (all song shuffle repeat)	Repeat All (all repeat)
Repeat Shuffle Folder (folder shuffle repeat)	Repeat Folder (folder repeat)

Notes

- When the G sensor menu (☞ page 40) is set to “OFF” this function is not available.
- You cannot use this function when:
 - the automatic song selection function (☞ page 23) is activated in the Music Pacer menu
 - you are using the FM tuner (NW-S202F/S203F/S205F only)
 - the HOME screen appears or you are setting a SETTINGS menu item
- When shaking the player, make sure not to bump the player into other objects or drop it.
- When you change the play mode by shaking the player 3 times, a step count error may occur.
- If you shake the player 3 times in rhythm within two seconds, the play mode changes but nothing happens after shaking it for two seconds.

Playing songs to a set target (Set Target)

You can set the target items such as playback time, calories, or distance during playback and exercise listening to music until the target items are achieved.

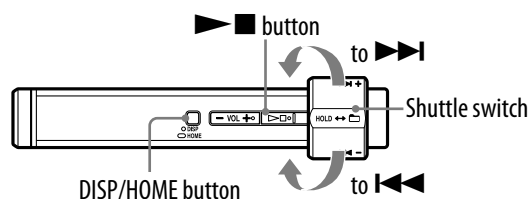

- 1 Press and hold the **DISP/HOME button** until the **HOME** screen appears.
- 2 Rotate the shuttle switch to select **SPORTS MODE** and press the **▶■ button** to confirm.
- 3 Rotate the shuttle switch to select **“Set Target>”** and press the **▶■ button** to confirm.
- 4 Rotate the shuttle switch to select the target item (☞ page 22) and press the **▶■ button** to confirm.
“Time” is set by default.
- 5 Rotate the shuttle switch to select the setting value (☞ page 22) of the target item selected in step 4 and press the **▶■ button** to confirm.
- 6 Rotate the shuttle switch to select **“Start”** and press the **▶■ button** to confirm.
Songs are played back by the set mode and the target value starts count down.
When the target value is achieved, playback stops.

To return to normal play

During count down, perform steps 1 to 2, and then select “OFF.”

Continued ↓



List of target setting

Target item	Setting value
Time	Sets target time. You can set the time from 1 to 99 minutes by 1 minute increments. "10min" is set by default.
Calorie	Sets target calorie. You can set the calorie from 10 to 990 kcal by 10 kcal increments. "100kcal" is set by default.
DIST_km (distance (km))	Sets target distance. You can set the distance from 0.5 to 99.5 km by 0.5 km increments. "1.0km" is set by default.
DIST_mile (distance (mile))	Sets target distance. You can set the distance from 0.5 to 99.5 mile by 0.5 mile increments. "1.0mile" is set by default.

Hints

- When there is a previous target not yet achieved can start count down after selecting "Start" in step ③.
- You can play songs in automatic song selection mode according to your exercise pace ( page 23) instead of setting a target.

Notes

- We recommend using the supplied clip or arm band ( page 6) when using the player. However the player may not be able to count steps properly depending on how the player is attached, or the following cases.
 - If you use the player with a strap (sold separately) around your neck, waist, bag, etc.
 - If you use the player inside a bag swinging randomly.
 - If you use the player during up and down movement or swaying from side to side in a vehicle.
 - If you use the player during active sports requiring up and down movement or subject the player to excessive shock.
- The player calculates the distance and calorie-count based on the step count and height/weight/step length you set ( page 38). Inaccuracies may occur depending on how the player is attached, age, or gender. Use this function as a guide.

Playing songs in automatic selection mode depending on your exercise pace (Music Pacer)

In SPORTS MODE, you can play songs using the automatic selection function in which the player changes the playlist automatically depending on your pace of movement, like walking or jogging.

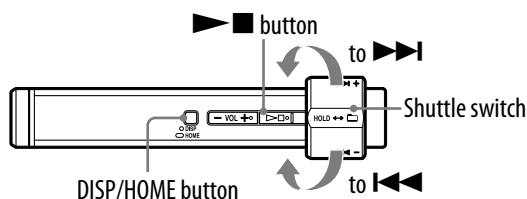

- 1 Press and hold the DISP/HOME button until the HOME screen appears.
- 2 Rotate the shuttle switch to select **SPORTS MODE** and press the **▶■** button to confirm.
- 3 Rotate the shuttle switch to select **"Music Pacer>"** and press the **▶■** button to confirm.
- 4 Rotate the shuttle switch to select **"ON"** or **"OFF"** and press the **▶■** button to confirm.
 - ON: Activates automatic song selection. The "Walk Music" or "Run Music" playlist is played back in shuffle mode, depending on the pace of the movement. (Default setting)
 - OFF: Automatic song selection is not activated. Plays back songs in the status before you selected "SPORTS MODE."
- 5 Rotate the shuttle switch to select **"Start"** and press the **▶■** button to confirm.

Playback starts in the pace set in step 4 and the set target value starts count down. When the target value is achieved, playback stops.

Continued ↓

 **Hints**

- Playlists of “Walk” and “Run” are included on the player by default. Furthermore, you can add songs to the playlists of “Walk” and “Run” using the SonicStage software.
- You can change the playlist depending on your exercise pace (🔗 page 25).
- When switching the playlist from “Walk” to “Run” or vice versa, audio guidance is provided.

Notes

- If there is not any playlist on the player, the Music Pacer menu does not appear.
- We recommend using the supplied clip or arm band (🔗 page 6) when using the player. However the player may not be able to recognize pace of movement properly depending on how the player is attached, or the following cases.
 - If you use the player with a strap (sold separately) around your neck, waist, bag, etc.
 - If you use the player inside a bag swinging randomly.
 - If you use the player during up and down movement or swaying from side to side in a vehicle.
 - If you use the player during active sports requiring up and down movement or subject the player to excessive shock.





Continued ↓

Changing the playlists of the automatic song selection (Set Playlist)

You can change the playlists of the automatic song selection.

Note

- To activate the automatic song selection, select “ON” on the Music Pacer (🔊 page 23).

- 1 Press and hold the DISP/HOME button until the HOME screen appears.**
- 2 Rotate the shuttle switch to select  (SPORTS MODE) and press the  button to confirm.**
- 3 Rotate the shuttle switch to select “Set Playlist>” and press the  button to confirm.**
“SET WALK P.LIST” appears.
- 4 Rotate the shuttle switch to select the playlist for slow pace and press the  button to confirm.**
“SET RUN P.LIST” appears.
- 5 Rotate the shuttle switch to select the playlist for fast pace and press the  button to confirm.**

Note

- If you format the player, all playlists including the default playlist are deleted.

Using the stop watch function (STOPWATCH)

You can use the player as a stop watch. You can time up to 9 hours 59 minutes 59 seconds by 1 second increments.

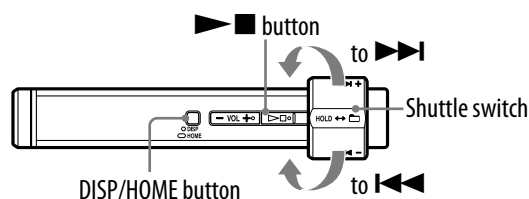

- 1 Press and hold the **DISP/HOME** button until the **HOME** screen appears.
- 2 Rotate the shuttle switch to select **⌚** (STOPWATCH) and press the **▶■** button to confirm.
- 3 Press the **DISP/HOME** button to start measuring time.
- 4 Press the **DISP/HOME** button again to stop measuring time.
If you press the **DISP/HOME** button again while measuring time stops, stop watch is reset.

Hint

- The stop watch function can be used during playback. However while using the stop watch function, the screen for measurement of time appears.

To stop the stop watch function

Press and hold the **DISP/HOME** button until the **HOME** screen appears, and then select **🎵** (ALL SONGS), **📁** (PLAYLIST) or **FM** (FM) (NW-S202F/S203F/S205F only) from the menu screen and press the **▶■** button to confirm.

Changing the Display Mode

You can change the desired display for playback or stop mode.

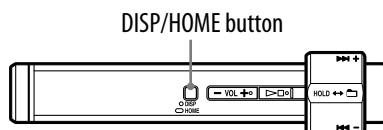

Each time the DISP/HOME button is pressed, the screen changes as follows.

- **Basic:** Displays the basic screen. (Default setting)
- **Property:** Displays song information.
Displays the current song number (or current album/artist number)/total song number (or total album/artist number) of the play range, elapsed time, codec (compression type), bit rate, and current sound quality setting (Equalizer).

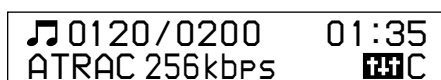

- **Step:** Displays step count.
Displays step count, distance covered and G Sensor setting (G Sensor).
At the default setting, step count during playback or FM reception (NW-S202F/S203F/S205F only), or distance covered appears (☞ page 40) and step count is reset automatically (☞ page 43) when the player's clock you set shows 0:00.
- **Calorie:** Displays calorie-count.
Displays calories consumed and G Sensor setting (G Sensor).
At the default setting, consumed calories during playback or FM reception (NW-S202F/S203F/S205F only) appear (☞ page 40).
🍌, 🍌, 🍌, 🍌 appear in this order depending on the calories consumed. 5 🍌 icons appear when maximum calorific value is reached.
- **Clock:** Displays the day of the week, month, date, and current time. For information on setting the time, see "Adjusting the Current Time Setting (Set Date-Time)" (☞ page 44).
- **DISP:** Displays animations.

Continued ↓

 **Hint**

- Set the power save setting (🔌 page 54) to “OFF” to show the screen constantly.





Notes

- When the sound quality setting (Equalizer) (🔌 page 33) is set to “OFF” it does not appear on the “Property” screen.
- We recommend using the supplied clip or arm band (🔌 page 6) when using the player. However the player may not be able to count steps properly depending on how the player is attached, or the following cases.
 - If you use the player with a strap (sold separately) around your neck, waist, bag, etc.
 - If you use the player inside a bag swinging randomly.
 - If you use the player during up and down movement or swaying from side to side in a vehicle.
 - If you use the player during active sports requiring up and down movement or subject the player to excessive shock.
- The player calculates the distance and calorie-count based on the step count and height/weight/step length you set (🔌 page 38). Inaccuracies may occur depending on how the player is attached, age, or gender. Use this function as a guide.

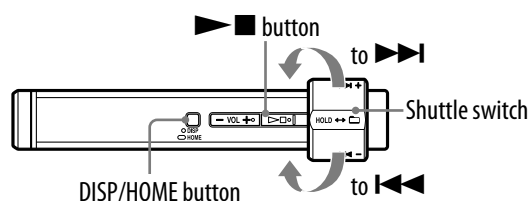
Changing the Song Order (Sort)

You can set the song order by album order, albums by artist order, or artist name order.



- 1 Press and hold the DISP/HOME button until the HOME screen appears.
- 2 Rotate the shuttle switch to select  (SETTINGS) and press the  button to confirm.
- 3 Rotate the shuttle switch to select "Sort>" and press the  button to confirm.
- 4 Rotate the shuttle switch to select a song order and press the  button to confirm.

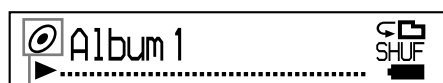



Sorting status indication

To return to the previous menu

Press the DISP/HOME button.

List of song order

Setting item/Icon	Description
Album (Album order)/ 	Songs appear in album order. In the album, songs appear in song number order. In Folder control mode, songs are skipped by album. (Default setting)
Artist/Album (Albums by artist order)/ 	Songs appear in album order by artist. In the album, songs appear in song number order. In Folder control mode, songs are skipped by album.
Artist (Artist order)/ 	Songs appear in artist order. The same artist's songs appear in song name order. In Folder control mode, songs are skipped by artist.

Setting the Volume Using the Preset Volume Function (Volume Mode)

There are 2 modes to adjust the volume level.

Manual (Manual Volume):

Press the VOL +/- button to adjust the volume level from 0 to 30.

Preset (Preset Volume):

Press the VOL +/- button to select the volume level to any of 3 preset levels: "Low," "Mid," or "Hi."

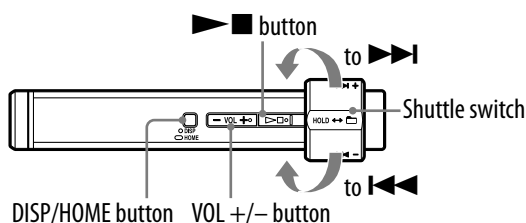

Setting a volume level for preset mode (Preset)

- 1 Press and hold the DISP/HOME button until the HOME screen appears.
- 2 Rotate the shuttle switch to select  (SETTINGS) and press the ▶■ button to confirm.
- 3 Rotate the shuttle switch to select "Advanced Menu>" and press the ▶■ button to confirm.
- 4 Rotate the shuttle switch to select "Sound>" and press the ▶■ button to confirm.
- 5 Rotate the shuttle switch to select "Volume Mode>" and press the ▶■ button to confirm.

Continued ↓

-
- 6 Rotate the shuttle switch to select “Preset” and press the ►■ button to confirm.**

A line appears above and below “Low.”

-
- 7 Rotate the shuttle switch to set the volume for each preset level, and press the ►■ button to confirm.**

Preset level appears in order, “Low,” “Mid” and “Hi.”

With this setting, you can select the volume level (“Low,” “Mid,” or “Hi”) by pressing the VOL +/- button.

To return to the previous menu







Press the DISP/HOME button.

Note

- If AVLS (🔍 page 36) is set, the actual volume may be lower than the settings. Releasing AVLS returns the volume to the preset level.

Continued ↓

Switching to manual mode (Manual)

- 1 Press and hold the DISP/HOME button until the HOME screen appears.
- 2 Rotate the shuttle switch to select  (SETTINGS) and press the  button to confirm.
- 3 Rotate the shuttle switch to select "Advanced Menu>" and press the  button to confirm.
- 4 Rotate the shuttle switch to select "Sound>" and press the  button to confirm.
- 5 Rotate the shuttle switch to select "Volume Mode>" and press the  button to confirm.
- 6 Rotate the shuttle switch to select "Manual" and press the  button to confirm.

With this setting, you can adjust the volume level (from 0 to 30) by pressing the VOL +/- button.

To return to the previous menu

Press the DISP/HOME button.



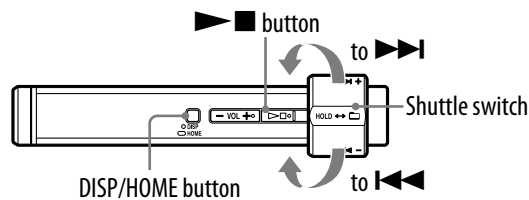

Customizing Sound Quality (Equalizer)

You can customize the sound quality to match the genre of music.



Note

- You cannot customize the sound quality while using the FM tuner (NW-S202F/S203F/S205F only).

- Press and hold the DISP/HOME button until the HOME screen appears.
- Rotate the shuttle switch to select  (SETTINGS) and press the  button to confirm.
- Rotate the shuttle switch to select "Equalizer>" and press the  button to confirm.
- Rotate the shuttle switch to select the sound quality setting and press the  button to confirm.

To return to the previous menu

Press the DISP/HOME button.

List of sound quality settings

Setting item	Description
OFF	Sound quality setting is not activated. (Default setting)
Heavy	Emphasizes high and low ranges for a powerful sound.
Pop	Stresses the middle range audio, ideal for vocals.
Jazz	Emphasizes high and low ranges for a lively sound.
Custom	User-customizable sound settings. See  page 34 for setting.

Notes

- If the sound quality setting you choose is distorted when you turn up the volume, turn it down.
- If your personal settings saved as "Custom" seem to produce a different volume level than the other settings, you may have to adjust the volume manually to compensate.





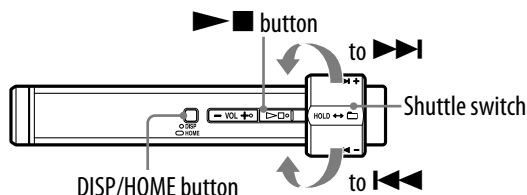

Registering a Desired Sound Quality (Preset Custom)

You can set 7 levels for each 5 bands and register a desired sound quality. And you can select the registered setting on “Custom” in “Customizing Sound Quality (Equalizer)” (☞ page 33).



Note

- You cannot register the sound quality while using the FM tuner (NW-S202F/S203F/S205F only).

- 1 Press and hold the DISP/HOME button until the HOME screen appears.
- 2 Rotate the shuttle switch to select  (SETTINGS) and press the  button to confirm.
- 3 Rotate the shuttle switch to select “Advanced Menu>” and press the  button to confirm.
- 4 Rotate the shuttle switch to select “Sound>” and press the  button to confirm.
- 5 Rotate the shuttle switch to select “Preset Custom>” and press the  button to confirm.
A line appears above and below the lowest band.
- 6 Rotate the shuttle switch to set the level for each band, and press the  button to confirm.
Sound quality order is set from low band (bass) to high band (treble).

To return to the previous menu

Press the DISP/HOME button.

Adjusting the Volume Level (Dynamic Normalizer)

You can set to reduce the volume level between songs. With this setting, when listening to album songs in shuffle play mode, the volume level between songs is moderated to minimize the difference in their recording levels.

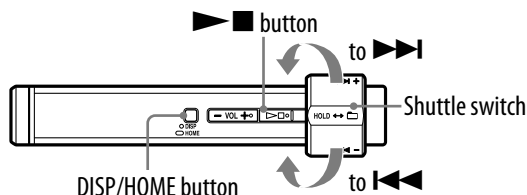

Note

- You cannot set to reduce the volume level between songs while using the FM tuner (NW-S202F/S203F/S205F only).

- 1 Press and hold the DISP/HOME button until the HOME screen appears.
- 2 Rotate the shuttle switch to select  (SETTINGS) and press the ▶■ button to confirm.
- 3 Rotate the shuttle switch to select "Advanced Menu>" and press the ▶■ button to confirm.
- 4 Rotate the shuttle switch to select "Sound>" and press the ▶■ button to confirm.
- 5 Rotate the shuttle switch to select "D.Normalizer>" and press the ▶■ button to confirm.
- 6 Rotate the shuttle switch to select "ON" and press the ▶■ button to confirm.

To set to off

Select "OFF" in step 6.

To return to the previous menu

Press the DISP/HOME button.

Limiting the Volume (AVLS)

You can set AVLS (Automatic Volume Limiter System) to limit the maximum volume to prevent auditory disturbance or distraction. With AVLS, you can listen to music at a comfortable volume level.

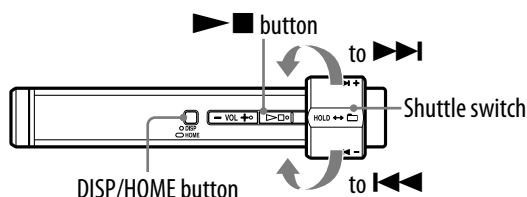

- 1 Press and hold the DISP/HOME button until the HOME screen appears.
- 2 Rotate the shuttle switch to select  (SETTINGS) and press the ▶■ button to confirm.
- 3 Rotate the shuttle switch to select "Advanced Menu>" and press the ▶■ button to confirm.
- 4 Rotate the shuttle switch to select "Sound>" and press the ▶■ button to confirm.
- 5 Rotate the shuttle switch to select "AVLS>" and press the ▶■ button to confirm.
- 6 Rotate the shuttle switch to select "ON" and press the ▶■ button to confirm.

The volume is kept at a moderate level.

To set to off

Select "OFF" in step 6.

To return to the previous menu

Press the DISP/HOME button.





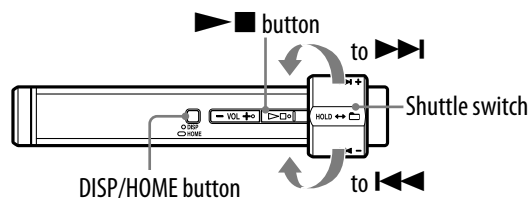

Hint

- "AVLS" appears by pressing the VOL +/- button if AVLS is set to "ON."

Turning Off the Beep Sound (Beep)

You can turn off the beep sounds of the player.



- 1 Press and hold the DISP/HOME button until the HOME screen appears.
- 2 Rotate the shuttle switch to select  (SETTINGS) and press the  button to confirm.
- 3 Rotate the shuttle switch to select "Advanced Menu>" and press the  button to confirm.
- 4 Rotate the shuttle switch to select "Sound>" and press the  button to confirm.
- 5 Rotate the shuttle switch to select "Beep>" and press the  button to confirm.
- 6 Rotate the shuttle switch to select "OFF" and press the  button to confirm.

To change the setting to on

Select "ON" in step 6.

To return to the previous menu

Press the DISP/HOME button.

Setting the information for calorie-count and distance (Height/Weight)

You can set the information (height/weight/step length) to measure for calorie-count and distance when playing back songs in SPORTS MODE (🎧 page 21).

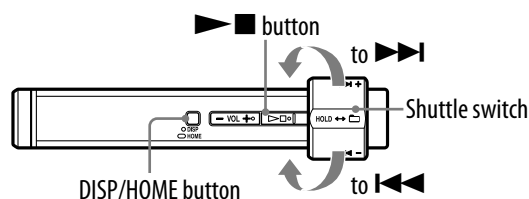

- 1 Press and hold the DISP/HOME button until the HOME screen appears.
- 2 Rotate the shuttle switch to select  (SETTINGS) and press the ▶■ button to confirm.
- 3 Rotate the shuttle switch to select "Advanced Menu>" and press the ▶■ button to confirm.
- 4 Rotate the shuttle switch to select "Height/Weight>" and press the ▶■ button to confirm.
- 5 Rotate the shuttle switch to select the value for "inch/lb" or "cm/kg" and press the ▶■ button to confirm.
- 6 Rotate the shuttle switch to select weight and press the ▶■ button to confirm.
"132lb (or 60kg)" is set by default.
- 7 Rotate the shuttle switch to select height and press the ▶■ button to confirm.
"67inch (or 170cm)" is set by default.

Continued ↓

- 8** After pressing the **▶■** button to decide “Walk Stride>,” rotate the shuttle switch to set step length for when walking, and then press the **▶■** button to confirm.

Step length is calculated by the height value (set in step **7**) $\times 0.5$.

- 9** After pressing the **▶■** button to decide “Run Stride>,” rotate the shuttle switch to set step length for when running, and then press the **▶■** button to confirm.

Step length is calculated by the height value (set in step **7**) $\times 0.7$.



To return to the previous menu

Press the DISP/HOME button.

Hint

- You can set the height from 80 to 250 cm (31 to 99 inch), the weigh from 10 to 300 kg (22 to 660 lb). In case of other values, you can set from “Less” (minimum value) or “More” (maximum value). Select the approximate value.





Notes

- We recommend using the supplied clip or arm band ( page 6) when using the player. However the player may not be able to count steps properly depending on how the player is attached, or the following cases.
 - If you use the player with a strap (sold separately) around your neck, waist, bag, etc.
 - If you use the player inside a bag swinging randomly.
 - If you use the player during up and down movement or swaying from side to side in a vehicle.
 - If you use the player during active sports requiring up and down movement or subject the player to excessive shock.
- The player calculates the distance and calorie-count based on the step count and height/weight/step length you set ( page 38). Inaccuracies may occur depending on how the player is attached, age, or gender. Use this function as a guide.
- When you measure calories, the G Sensor menu ( page 40) needs to be activated.
- The information you set for “Height/Weight” is used only for the purpose of measuring the distance of movement and calories consumed. This information is not output via the USB connection.
- If you change the value of the height (step **7**) after setting the step length steps in **8** and **9**, the step length is also changed to be calculated again.

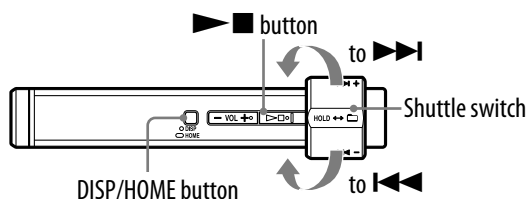
Setting the G Sensor (G Sensor)

The player's built-in G Sensor recognizes speed variation and provides functions such as step count, distance covered and consumed calorie calculations, or play mode change by shaking the player 3 times (📄 page 20). You can also deactivate the G Sensor.



- 1 Press and hold the DISP/HOME button until the HOME screen appears.
- 2 Rotate the shuttle switch to select  (SETTINGS) and press the  button to confirm.
- 3 Rotate the shuttle switch to select "Advanced Menu>" and press the  button to confirm.
- 4 Rotate the shuttle switch to select "G Sensor>" and press the  button to confirm.
- 5 Rotate the shuttle switch to select the following G Sensor setting and press the  button to confirm.
 - ON-MusicPB: Activates the G Sensor during playback or FM reception (NW-S202F/S203F/S205F only). (Default setting) Recommended to listen to songs during sports.
 - ON-Anytime: Activates G Sensor always. Recommended to know step count or consumed calories throughout the day. However, even if you do not use the player, the G Sensor remains activate and consumes battery power.
 - OFF: The G Sensor is not activated. Recommended to save power and prolong use of the player.

Continued ↓

 **Hint**

- When the G Sensor menu is set to “ON-MusicPB” or “ON-Anytime,” “G” appears on the screen of “Step” or “Calorie” (☞ page 27).

Note

- We recommend using the supplied clip or arm band (☞ page 6) when using the player. However the player may not be able to activate the G Sensor function properly depending on how the player is attached, or the following cases.
 - If you use the player with a strap (sold separately) around your neck, waist, bag, etc.
 - If you use the player inside a bag swinging randomly.
 - If you use the player during up and down movement or swaying from side to side in a vehicle.
 - If you use the player during active sports requiring up and down movement or subject the player to excessive shock.

To return to the previous menu

Press the DISP/HOME button.

Displaying step count history (Count History)

Step count history is recorded when counting steps while the G Sensor menu is set to “ON” (☞ page 40). You can display up to 7 histories from the latest history.

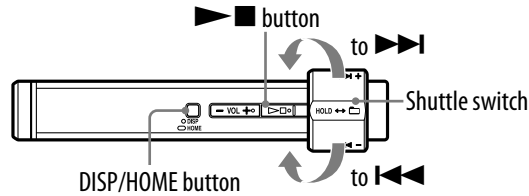

- 1 Press and hold the DISP/HOME button until the HOME screen appears.
- 2 Rotate the shuttle switch to select  (SETTINGS) and press the ▶ button to confirm.
- 3 Rotate the shuttle switch to select “Count History>” and press the ▶ button to confirm.

The date, step count, distance and calorie-count appear on the screen from the left, in this order. By rotating the shuttle switch you can select the previous or next step count history.

Hint

- The latest step count history always appears on the top.
- If you set the Counter Reset menu (☞ page 43) to “Daily,” the daily history remains on the player.
- By activating the Reset All Setting menu (☞ page 49), you can delete the step count history.



To return to the previous menu

Press the DISP/HOME button.

Setting the reset method of the step count (Counter Reset)

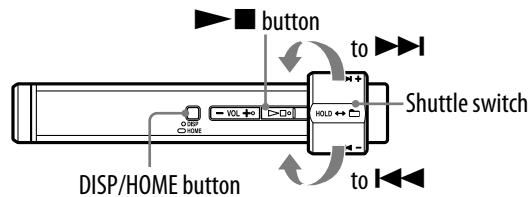
You can reset the accumulated step count. “Daily” is set by default.



- 1 Press and hold the DISP/HOME button until the HOME screen appears.
- 2 Rotate the shuttle switch to select  (SETTINGS) and press the ► button to confirm.
- 3 Rotate the shuttle switch to select “Counter Reset>” and press the ► button to confirm.
- 4 Rotate the shuttle switch to select the following resetting method and press the ► button to confirm.
 - Now: Resets the accumulated step count now.
 - Daily: Resets the accumulated step count when the player’s clock you set ( page 44) shows 0:00.
 - OFF: Resetting is not activated.

If you want to select “Now,” select “OK” and press the ► button to confirm. If you select “Cancel” and press the ► button to confirm, the resetting method menu returns.

To return to the previous menu





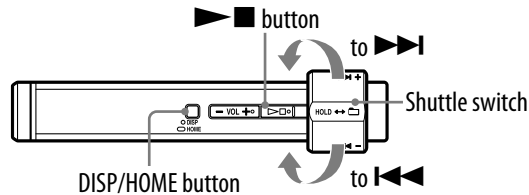

Press the DISP/HOME button.

Adjusting the Current Time Setting (Set Date-Time)

You can set and display the current time.

You can set the date and time of the player to either synchronize with your computer automatically, or manually by the player.



- 1 Press and hold the DISP/HOME button until the HOME screen appears.
- 2 Rotate the shuttle switch to select  (SETTINGS) and press the  button to confirm.
- 3 Rotate the shuttle switch to select "Advanced Menu>" and press the  button to confirm.
- 4 Rotate the shuttle switch to select "Date-Time>" and press the  button to confirm.
- 5 Rotate the shuttle switch to select "Set Date-Time>" and press the  button to confirm.
- 6 Rotate the shuttle switch to select "Automatic" or "Manual" and press the  button to confirm.
 - Automatic: Synchronizes the date and time with your computer when connecting the player to your computer and starts the SonicStage software.
 - Manual: To set the date and time manually.



If you select "Automatic," the SETTINGS menu closes.
 If you select "Manual," a line appears above and below the year digit.
 Continue with steps **7** to **8**.

Continued 

-
- 7 Rotate the shuttle switch to adjust the year setting and press the   button to confirm.**

A line appears above and below the month digit.

-
- 8 As you did in step 7, adjust the settings for month, date, hour, and minute.**

After rotating the shuttle switch to adjust the date and time setting, press the   button to confirm.

To return to the previous menu



Press the DISP/HOME button.

To display the current time

Follow either procedure below.

- Set “Clock” on “Changing the Display Mode” ( page 27).
- Press any button while the HOLD function is activated.

Hint

- You can select the date format from either “month/day,” or “day/month.” Furthermore, you can select the time format from either a 12 or 24 hour display. See “Setting the Date Format (Date Disp Type)” ( page 46), or “Setting the Time Format (Time Disp Type)” ( page 47).





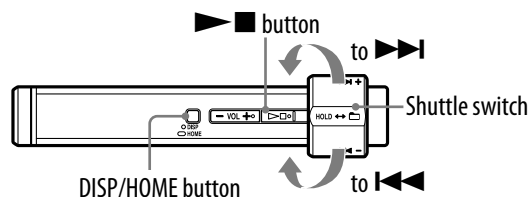

Notes

- If the player is not used for a long time, your settings for date and time may need to be reset.
- If the current time is not set and the display is set to “Clock” ( page 27), “---” appears.

Setting the Date Format (Date Disp Type)

You can select the date format you set (☞ page 44) from either “month/day,” or “day/month.”



- 1 Press and hold the DISP/HOME button until the HOME screen appears.
- 2 Rotate the shuttle switch to select  (SETTINGS) and press the  button to confirm.
- 3 Rotate the shuttle switch to select “Advanced Menu>” and press the  button to confirm.
- 4 Rotate the shuttle switch to select “Date-Time>” and press the  button to confirm.
- 5 Rotate the shuttle switch to select “Date Disp Type>” and press the  button to confirm.
- 6 Rotate the shuttle switch to select the date format and press the  button to confirm.
 - mm/dd: The date format appears “month/day.” (Default setting)
 - dd/mm: The date format appears “day/month.”





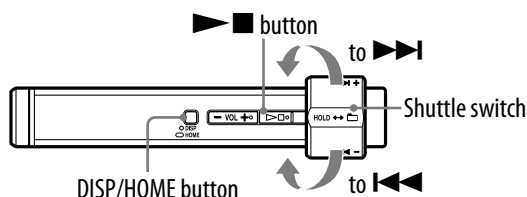

To return to the previous menu

Press the DISP/HOME button.

Setting the Time Format (Time Disp Type)

You can select the time format you set (☞ page 44) from either a 12 or 24 hour display. "24h" is set by default.



- 1 Press and hold the DISP/HOME button until the HOME screen appears.
- 2 Rotate the shuttle switch to select  (SETTINGS) and press the  button to confirm.
- 3 Rotate the shuttle switch to select "Advanced Menu>" and press the  button to confirm.
- 4 Rotate the shuttle switch to select "Date-Time>" and press the  button to confirm.
- 5 Rotate the shuttle switch to select "Time Disp Type>" and press the  button to confirm.
- 6 Rotate the shuttle switch to select "12h" or "24h" and press the  button to confirm.





To return to the previous menu

Press the DISP/HOME button.

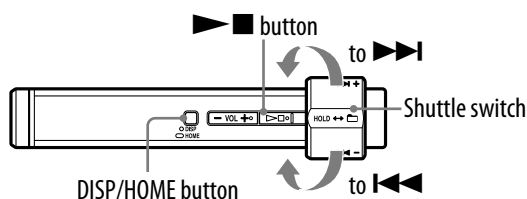
Displaying the Player Information (Information)

Information such as product name, built-in flash memory capacity, serial number and firmware version can be shown.



- 1 Press and hold the DISP/HOME button until the HOME screen appears.
- 2 Rotate the shuttle switch to select  (SETTINGS) and press the  button to confirm.
- 3 Rotate the shuttle switch to select "Advanced Menu>" and press the  button to confirm.
- 4 Rotate the shuttle switch to select "Information>" and press the  button to confirm.
Rotate the shuttle switch to show the following information.
 - 1: product name
 - 2: built-in flash memory capacity
 - 3: serial number
 - 4: version information for the player's firmware
- 5 Press and hold the DISP/HOME button until the display changes.

To return to the previous menu

Press the DISP/HOME button.

Resetting to Factory Settings (Reset All Setting)

You can reset the player to the factory settings. Resetting the player does not delete the music songs you have transferred to the player.

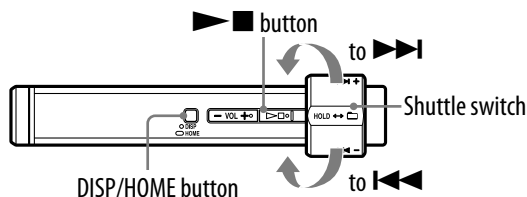

Note

- Only available when using the ALL SONGS function in stop mode.

- 1 Press and hold the DISP/HOME button in stop mode until the HOME screen appears.
- 2 Rotate the shuttle switch to select  (SETTINGS) and press the ▶■ button to confirm.
- 3 Rotate the shuttle switch to select "Advanced Menu>" and press the ▶■ button to confirm.
- 4 Rotate the shuttle switch to select "Initialize>" and press the ▶■ button to confirm.
- 5 Rotate the shuttle switch to select "Reset All Setting>" and press the ▶■ button to confirm.
- 6 Rotate the shuttle switch to select "OK" and press the ▶■ button to confirm.

When resetting is completed, "COMPLETE" appears.

To return to the previous menu

Press the DISP/HOME button.

To cancel restoration of factory settings

Select "Cancel" in step 6 and press the ▶■ button to confirm.

Formatting Memory (Format)





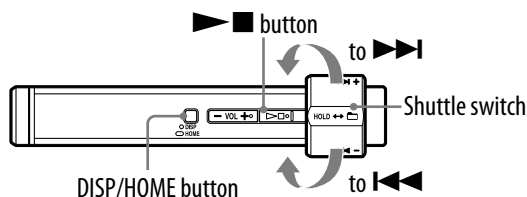

You can format the built-in flash memory of the player.

If the memory's formatted, all the music data and the other data stored will be erased. Be sure to verify the data stored in the memory prior to formatting.



Note

- Only available when using the ALL SONGS function in stop mode.

- 1 Press and hold the DISP/HOME button in stop mode until the HOME screen appears.
- 2 Rotate the shuttle switch to select  (SETTINGS) and press the  button to confirm.
- 3 Rotate the shuttle switch to select "Advanced Menu>" and press the  button to confirm.
- 4 Rotate the shuttle switch to select "Initialize>" and press the  button to confirm.
- 5 Rotate the shuttle switch to select "Format>" and press the  button to confirm.
- 6 Rotate the shuttle switch to select "OK" and press the  button to confirm.

"FORMATTING..." appears and formatting starts.

When formatting is complete, "COMPLETE" appears.

Continued 

To return to the previous menu

Press the DISP/HOME button.

To cancel formatting

Select “Cancel” in step ⑥ and press the  button to confirm.

Note

- Do not format the built-in flash memory of the player using Windows Explorer.



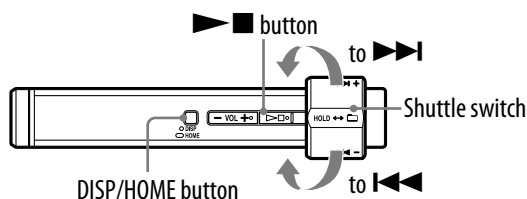

Changing the USB Connection Setting (USB Power)

Depending on how you are using the computer, if the power supply (USB Bus Powered) is insufficient, incomplete data transfer may occur from the computer to the player. In this case, setting the USB connection (USB Power) to “100mA” may improve data transfer. “500mA” is set by default.



Note

- You cannot set this during the USB connection.

- 1 Press and hold the DISP/HOME button until the HOME screen appears.
- 2 Rotate the shuttle switch to select  (SETTINGS) and press the  button to confirm.
- 3 Rotate the shuttle switch to select “Advanced Menu>” and press the  button to confirm.
- 4 Rotate the shuttle switch to select “USB Power>” and press the  button to confirm.
- 5 Rotate the shuttle switch to select “100mA” or “500mA” and press the  button to confirm.

To return to the previous menu

Press the DISP/HOME button.





Hints

- When you connect the player to a laptop computer, we recommend to connect the laptop computer to a power supply.
- The charging time will be longer if the “USB Power” is set to “100mA.”

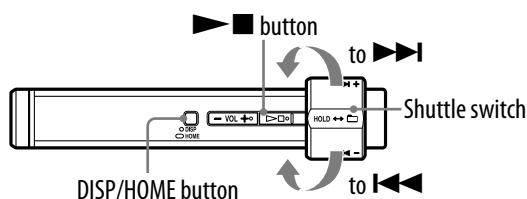
Setting the Display's Left/Right Orientation (Disp. Rotation)

You can change the display's orientation to operate easily, for example, when attaching the player using the supplied clip or arm band.





- 1 Press and hold the DISP/HOME button until the HOME screen appears.
- 2 Rotate the shuttle switch to select  (SETTINGS) and press the  button to confirm.
- 3 Rotate the shuttle switch to select "Advanced Menu>" and press the  button to confirm.
- 4 Rotate the shuttle switch to select "Disp. Rotation>" and press the  button to confirm.
- 5 Rotate the shuttle switch to select "ON" or "OFF" and press the  button to confirm.
"OFF" is set by default.



To return to the previous menu

Press the DISP/HOME button.

Hint

- Even if you change the display's orientation, the shuttle switch function ( ) or VOL +/-) is not be changed.





Note

- Even if you change the display's orientation according to the above procedure, Power Save display ( page 54) orientation for ALL SONGS ( page 13) or PLAYLIST ( page 14) cannot be changed.

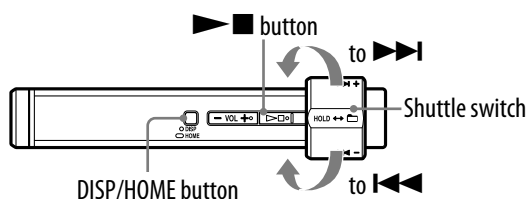
Saving Power Consumption (Power Save)

The screen changes to the power save screen when the player is not operated for about 15 seconds.



- 1 Press and hold the DISP/HOME button until the HOME screen appears.
- 2 Rotate the shuttle switch to select  (SETTINGS) and press the  button to confirm.
- 3 Rotate the shuttle switch to select "Advanced Menu>" and press the  button to confirm.
- 4 Rotate the shuttle switch to select "Power Save>" and press the  button to confirm.
- 5 Rotate the shuttle switch to select the power save setting and press the  button to confirm.

To return to the previous menu

Press the DISP/HOME button.

Lists of the power save setting

Setting item	Description
ON-Normal	The power save screen appears in the display when no operation is performed for about 15 seconds. (Default setting)
ON-Super	Nothing appears in the display. This setting uses the least battery consumption.
OFF	The icon(s) or letter(s) appears in the display constantly during playback or FM reception (NW-S202F/S203F/S205F only).

Enjoy Listening to FM Radio

You can listen to FM radio. Charge the built-in rechargeable battery before using the player (🔋 page 62), and connect the headphones to the headphone jack.

1 Switching to the FM tuner

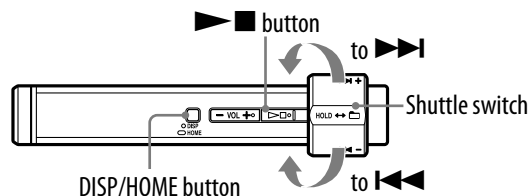

- 1 Press and hold the DISP/HOME button until the HOME screen appears.
- 2 Rotate the shuttle switch to select **FM** (FM) and press the **▶** button to confirm.

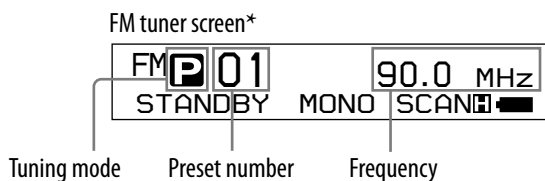

The FM tuner screen appears.



* The illustrated FM tuner screen may be different from your model.



Continued ↓

To stop the FM tuner and return to the audio player





Press and hold the DISP/HOME button until the HOME screen appears, and then select  (ALL SONGS) or  (PLAYLIST) from the menu screen and press the  button to confirm.

If there are no songs in the playlist, select  (ALL SONGS).

To turn off the volume of the FM tuner briefly

By pressing the  button, FM tuner sound is not output. The FM tuner enters Sleep status after about 5 seconds and the display goes off. By pressing the  button, the FM tuner sound is output again.

Notes

- If you rotate the shuttle switch to  () in Sleep status, the previous (or next) preset number or frequency is selected. At that time, the sound is not output, regardless of the VOL +/- button.
- During FM reception,  (SPORTS MODE) and  (STOPWATCH) do not appear on the HOME screen.
- During FM reception, you cannot change the display by pressing the DISP/HOME button.



2 Presetting broadcast stations automatically (FM Auto Preset)

You can preset receivable broadcast stations (up to 30 stations) in your area automatically by selecting “FM Auto Preset.” This is convenient when you use the FM tuner for the first time or when you change to a new area.

Note

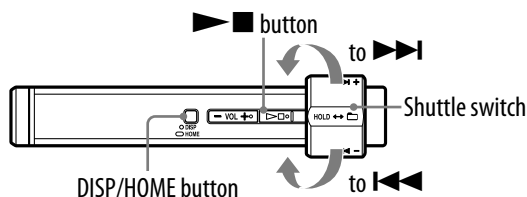
- The “FM Auto Preset” operation will delete already preset broadcast stations.



- 1 Press and hold the DISP/HOME button until the HOME screen appears.
- 2 Rotate the shuttle switch to select  (SETTINGS) and press the  button to confirm.

Continued ↓

- 3 Rotate the shuttle switch to select "FM Auto Preset>" and press the ►■ button to confirm.

- 4 Rotate the shuttle switch to select "OK" and press the ►■ button to confirm.

The receivable broadcast stations will be preset in order from low to high frequency.

"COMPLETE" appears when presetting is complete, then the first preset station is received.

To stop the presetting

Select "Cancel" in step 4 and press the ►■ button.

To return to the previous menu

Press the DISP/HOME button.

If several unnecessary stations are received

If interference is prevalent or reception is too sensitive, change the reception setting (☞ page 60) to "Low."

3 Selecting broadcast stations

There are 2 ways (manual or preset tuning) to select broadcast stations.

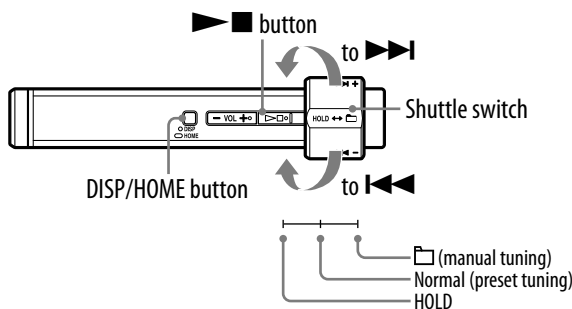

Slide the shuttle switch to the folder position to enter manual tuning mode.

Slide the shuttle switch to the Normal position to enter preset tuning mode.

- **Manual Tuning:** In manual tuning mode, you can select broadcast stations by frequency.
- **Preset Tuning:** In preset tuning mode, you can select broadcast stations by preset number.

Continued ↓

Manual Tuning

M, frequency, and preset number appear on the FM tuner screen, in order.

To	Operation
Select the previous frequency	Rotate the shuttle switch to ◀◀ briefly.
Select the next frequency	Rotate the shuttle switch to ▶▶ briefly.
Select the previous receivable broadcast station*	Rotate and hold the shuttle switch to ◀◀ .
Select the next receivable broadcast station*	Rotate and hold the shuttle switch to ▶▶ .

* By rotating and holding the shuttle switch to **◀◀** (**▶▶**) during FM reception, the previous (or next) broadcast station is found. If the broadcast station is receivable, the reception is accepted.

If interference is prevalent or reception is too sensitive, change the reception setting (🔊 page 60) to “Low.”

If you rotate the shuttle switch to **◀◀** (**▶▶**) in Sleep status, the frequency decreases (or increases), and the previous (or next) broadcast station is not found and sound is not output.

Preset Tuning

P, preset number, and frequency appear on the FM tuner screen, in order.

To	Operation
Select the previous preset number	Rotate the shuttle switch to ◀◀ briefly.
Select the next preset number	Rotate the shuttle switch to ▶▶ briefly.

Note

- You cannot select broadcast stations if no preset stations are entered. Preset the receivable stations using “FM Auto Preset” (🔊 page 56).

💡 Improving the reception

- The headphones cord serves as the antenna, so extend it as far as possible.

Presetting Desired Broadcast Stations

You can preset broadcast stations that “FM Auto Preset” misses (👉 page 56).

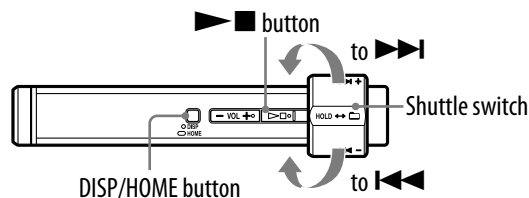

1 Select the desired frequency by manual tuning mode (👉 page 57).

2 Press and hold the ▶■ button.

The frequency you select in step **1** is preset and the preset number appears.

Hint

- You can preset up to 30 stations (P01 to P30).

Note

- The preset number is always sorted from low to high frequency order.

To delete preset broadcast stations

1 Select the desired frequency's preset number.

2 Press and hold the ▶■ button.

3 Rotate the shuttle switch to select “OK” and press the ▶■ button to confirm.

The preset broadcast station is deleted and the next one appears.

To cancel deletion of the preset broadcast station

Select “Cancel” in step **3** and press the ▶■ button.

Setting the Reception (Scan Sens)

When you set the “FM Auto Preset” (🔍 page 56) or “Manual Tuning” (🔍 page 57), it may receive many unnecessary broadcast stations because reception is too sensitive. In this case, set to “Low.” “High” is set by default.

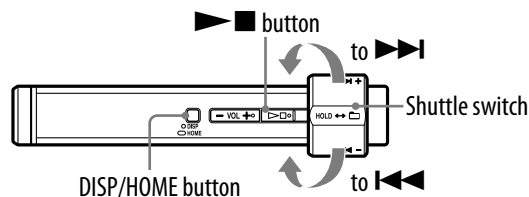

- 1 Press and hold the DISP/HOME button until the HOME screen appears.
- 2 Rotate the shuttle switch to select  (SETTINGS) and press the ▶■ button to confirm.
- 3 Rotate the shuttle switch to select “Scan Sens>” and press the ▶■ button to confirm.
- 4 Rotate the shuttle switch to select “Low” and press the ▶■ button to confirm.

To set back the reception

Select “High” in step 4 and press the ▶■ button to confirm.





To return to the previous menu

Press the DISP/HOME button.

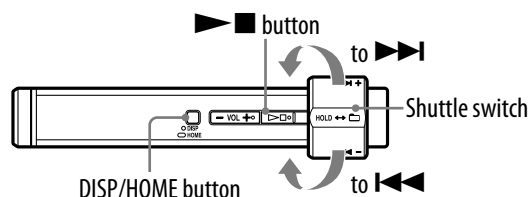
Changing the Monaural/Stereo (Mono/Auto)

If noise occurs during FM reception, set to “Mono” for monaural. If you set to “Auto,” stereo/monaural reception is automatically set, depending on reception conditions. “Auto” is set by default.



- 1 Press and hold the DISP/HOME button until the HOME screen appears.
- 2 Rotate the shuttle switch to select  (SETTINGS) and press the  button to confirm.
- 3 Rotate the shuttle switch to select “Mono/Auto>” and press the  button to confirm.
- 4 Rotate the shuttle switch to select “Mono” and press the  button to confirm.

To return to the automatic setting

Select “Auto” in step 4 and press the  button to confirm.

To return to the previous menu

Press the DISP/HOME button.

Recharging the Player

The player is rechargeable when connected to a computer.



When you connect the player to your computer, use the supplied USB cable.

When the remaining battery indication of the display shows: **FULL** , charging is complete (charging time is approx. 45 minutes*).

When you use the player for the first time, or if you have not used the player for a long time, recharge it fully (to **FULL**  in the remaining battery indication of the display).

* This is the approximate charging time when the battery power is low and the “USB Power” setting ( page 52) is “500mA” under room temperature. The charging time will vary depending on remaining battery power and battery condition. If the battery is charged in a low-temperature environment, the charging time will be longer. It will also be longer if you transfer audio file(s) to the player while charging.

On the remaining battery indication

The battery icon in the display ( page 12) changes as shown below. See  page 90 on battery duration.



The battery power gets low as shown in the battery icon. If “LOW BATTERY” appears, you cannot play back with the player. In this case, charge the battery by connecting to your computer.

Notes

- Charge the battery in an ambient temperature of between 5 to 35°C (67 to 95°F).
- “DATA ACCESS” appears in the display while the player accesses the computer. Do not disconnect the player while “DATA ACCESS” appears or the data being transferred may be destroyed.
- Some USB devices connected to the computer may interfere with the proper operation of the player.
- The control buttons on the player are all disabled while it is connected to a computer.

Maximizing Battery Life

By following a few simple guidelines, you can extend the playing time available from a battery charge.

Screen display auto-off

Setting the display to turn off after a certain period of time of not using the player (approx. 15 seconds), can help to save battery power.

See “Saving Power Consumption (Power Save)” (🔍 page 54) for the setting method.

Adjust song format and bit rate

The playing time varies, as battery charge can be affected by the format and bit rate of the audio songs that are played.

For example, a full battery charge offers about 18 hours of playing time for songs in ATRAC format at 48 kbps, but only about 15 hours for songs in WMA format at 128 kbps. The exact playing time available from a full charge varies with the operating conditions and environment of the player.

To deactivate the G Sensor

The player's built-in G Sensor recognizes speed variation and provides various functions. However, with the G Sensor active, battery consumption is higher when G Sensor active than when not. In order to save power and prolong use of the player, it is recommended to deactivate the G Sensor (🔍 page 40).

To make the player enter Sleep status

When you stop song playback or FM reception (NW-S202F/S203F/S205F only) by pressing the ▶■ button, after about a few seconds, the display goes off automatically and the player enters Sleep status.

When the G Sensor menu is deactivated in Sleep status, the player consumes very little battery power.

Note

- Do not leave the player connected for extended periods to a laptop computer that is not connected to AC power, because the player may discharge the computer's battery.

What are Format and Bit Rate?

What is format?

The format of a song refers to the method used by SonicStage to store the song's audio information when songs are imported to SonicStage from the Internet or audio CDs.

Common formats include MP3, WMA and ATRAC, etc.

MP3: MP3 (MPEG-1 Audio Layer3) is a common audio compression technology developed by the MPEG working group of the ISO (International Organization for Standardization).

MP3 can compress audio files to about 1/10 the size of standard CD audio songs.

WMA: WMA (Windows Media Audio) is a common audio compression technology developed by Microsoft Corporation. The WMA format produces the same sound quality as that of the MP3 format with smaller file size.

ATRAC: ATRAC (Adaptive Transform Acoustic Coding) is a general term used to refer to ATRAC3 and ATRAC3plus formats. ATRAC is an audio compression technology that satisfies the demand for both high sound quality and high compression rates. ATRAC3 can compress audio files to about 1/10 the size of standard CD audio songs. ATRAC3plus, a more advanced version of ATRAC3, can compress audio files to about 1/20 the size of standard CD audio songs.

AAC: AAC (Advanced Audio Coding) is a common audio compression technology developed by the MPEG working group of the ISO (International Organization for Standardization). The AAC format produces the same sound quality as that of the MP3 format, with a smaller file size.

What is bit rate?

Bit rate refers to the amount of data used to store each second of audio.

Generally, higher bit rates provide better sound quality, but require more storage space for the same length of audio.

What is the relationship between bit rate, sound quality, and storage size?

Generally, higher bit rates provide better sound quality, but require more storage space for the same length of audio, so you can store fewer songs on the player.

Lower bit rates enable you to store more songs, but at a lower sound quality.

For details on supported audio formats and bite rate, see  page 90.

Note

- If you import a song from a CD to SonicStage at a low bit rate, you cannot improve the song's sound quality by selecting a high bit rate when transferring the song from SonicStage to the player.

Playing Songs Without Pauses

If you import songs to SonicStage in ATRAC format and transfer them to the player, you can play them on the player continuously, without pauses between the songs.

For example, an album that includes a long recording of a live performance with no pauses between songs can be played continuously without pauses after the songs are imported to SonicStage in ATRAC format and then transferred to the player.

Note

- For songs to be played without pauses, you must import all the songs on a single album without pauses at one time to the SonicStage software in the same ATRAC format.

How is Song Information Imported to the Player?

When you import CD songs into SonicStage, SonicStage automatically retrieves information about the songs (such as album title, artist name, and song name) from a CD database service (CDDB, the Gracenote CD DataBase) on the Internet at no charge. When songs are transferred to the player, this song information is transferred along with the songs.

Having this information attached to your songs makes possible various advanced searching features of the player.

Note

- Song information of some CDs may not be able to retrieved from the Internet. For songs that are not in the Internet database, you can manually enter and edit song information in SonicStage. For details on editing song information, refer to SonicStage Help.

Storing Data Other Than Audio Files

You can store computer data into the built-in flash memory of the player by transferring it from your computer with Windows Explorer. If the player is connected to the computer, the built-in flash memory appears in Windows Explorer as a removable storage drive.

Notes

- Do not use SonicStage while using Windows Explorer to interact with the built-in flash memory of the player.
- Always use SonicStage to transfer audio files that you want to play to the player. Audio files transferred with Windows Explorer cannot be played by the player.
- Do not disconnect the supplied USB cable while transferring data between a computer and the player because the data being transferred could be damaged.
- Do not format the built-in flash memory using Windows Explorer. If you format the built-in flash memory, format it using the “Format” menu of the player (🔗 page 50).

Upgrading the Player's Firmware

You can update the player's firmware, ensuring you to add new features for the player by installing the latest player's firmware to the player. For details about the latest firmware information and how to install it, visit the following web site:

For customers in the USA: <http://www.sony.com/walkmansupport>

For customers in Canada: <http://www.sony.ca/ElectronicsSupport/>

For customers in Europe: <http://www.support-nwwalkman.com>

For customers in Latin America: <http://www.sony-latin.com/pa/info/>

For customers in other countries/regions: <http://www.css.ap.sony.com>

For customers who purchased the overseas models: <http://www.sony.co.jp/overseas/support/>

-
- 1 Download the update program to your computer from the web site.**
 - 2 Connect the player to your computer, and then start up the update program.**
 - 3 Follow the on-screen instructions to update the player's firmware.**
Firmware update is complete.
-

Troubleshooting

If the player does not function as expected, try the following steps to resolve the issue.

1 Press the DISP/HOME button and ►■ button at the same time for more about 7 seconds to reset the player.

All the songs and settings stored on the player will not be erased even when you reset it.

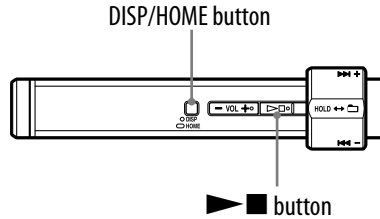

2 Find the symptoms of the issue in the following troubleshooting tables, and try any corrective actions listed.

3 Check for information about the issue in SonicStage Help.

4 Look for information about the issue on one of the support Web sites.

For customers in the USA, visit: <http://www.sony.com/walkmansupport>

For customers in Canada, visit: <http://www.sony.ca/ElectronicsSupport/>

For customers in Europe, visit: <http://www.support-nwwalkman.com>

For customers in Latin America, visit: <http://www.sony-latin.com/pa/info/>

For customers in other countries/regions, visit: <http://www.css.ap.sony.com>

For customers who purchased the overseas models, visit:

<http://www.sony.co.jp/overseas/support/>

5 If the approaches listed above fail to resolve the issue, consult your nearest Sony dealer.

Operation

Symptom	Cause/Remedy
There is no sound.	<ul style="list-style-type: none"> ● The volume level is set to zero. <ul style="list-style-type: none"> → Turn the volume up (☞ page 9). ● The headphone jack is not connected properly. <ul style="list-style-type: none"> → Connect the headphone jack properly (☞ page 11). ● The headphone plug is dirty. <ul style="list-style-type: none"> → Clean the headphone plug with a soft dry cloth. ● No audio files are stored in the built-in flash memory. <ul style="list-style-type: none"> → If “NO DATA” appears, transfer audio file(s) from the computer.

Continued ↓

Operation (continued)

Symptom	Cause/Remedy
Noise is generated.	<ul style="list-style-type: none"> • An apparatus emitting radio signals, such as a mobile phone is being used near the player. <ul style="list-style-type: none"> → When using such apparatus as mobile phones, keep them away from the player.
Buttons do not work.	<ul style="list-style-type: none"> • The shuttle switch is set to the HOLD position. <ul style="list-style-type: none"> → Slide the shuttle switch to the Normal (centre) position (☞ page 10). • The player contains moisture condensation. <ul style="list-style-type: none"> → Wait a few hours to let the player dry. • The remaining battery is low or insufficient. <ul style="list-style-type: none"> → Charge the battery connecting to the computer (☞ page 62). → Even if charging the battery and nothing is changed, press the DISP/HOME button and ►■ button at the same time for more about 7 seconds to reset the player (☞ page 69).
The player does not work.	<ul style="list-style-type: none"> • The remaining battery is insufficient. <ul style="list-style-type: none"> → Charge the battery connecting to the computer (☞ page 62). → Even if charging the battery and nothing is changed, press the DISP/HOME button and ►■ button at the same time for more about 7 seconds to reset the player (☞ page 69).
The transferred songs cannot be found.	<ul style="list-style-type: none"> • The built-in flash memory of the player was formatted using Windows Explorer. <ul style="list-style-type: none"> → Format the built-in flash memory using the “Format” menu of the player (☞ page 50). • The supplied USB cable is disconnected from the player while data is being transferred. <ul style="list-style-type: none"> → Transfer usable files back to your computer and format the built-in flash memory using the “Format” menu of the player (☞ page 50).
The volume is not loud enough.	<ul style="list-style-type: none"> • AVLS is enabled. <ul style="list-style-type: none"> → Disable AVLS (☞ page 36).
There is no sound from right channel of the headphones.	<ul style="list-style-type: none"> • The headphone jack is not fully inserted. <ul style="list-style-type: none"> → If the headphones are not connected correctly, sound will not be output properly. Connect the headphones into the jack until it clicks (☞ page 11).
Playback has stopped suddenly.	<ul style="list-style-type: none"> • The remaining battery is insufficient. <ul style="list-style-type: none"> → Charge the battery connecting to the computer (☞ page 62).

Continued ↓

Operation (continued)

Symptom	Cause/Remedy
Even if you use the Music Pacer function (🔊 page 23), the playlist is not changed.	<ul style="list-style-type: none"> • The player cannot recognize pace of movement properly. <ul style="list-style-type: none"> ➔ We recommend using the supplied clip or arm band (🔊 page 6) when using the player. However the player may not be able to recognize pace of movement properly depending on how the player is attached, or the following cases. <ul style="list-style-type: none"> – If you use the player with a strap (sold separately) around your neck, waist, bag, etc. – If you use the player inside a bag swinging randomly. – If you use the player during up and down movement or swaying from side to side in a vehicle. – If you use the player during active sports requiring up and down movement or subject the player to excessive shock.
Even if you shake the player 3 times, play mode is not changed.	<ul style="list-style-type: none"> • Shaking method of the player is not correct. <ul style="list-style-type: none"> ➔ As illustration page 20, hold the player with display facing up and shake the player up and down 3 times in rhythm within two seconds. • The G Sensor menu is set to “OFF.” <ul style="list-style-type: none"> ➔ When the G Sensor menu (🔊 page 40) is set to “OFF,” this function is not available. Set to “ON” and then shake the player.

Display

Symptom	Cause/Remedy
“□” appears for a title.	<ul style="list-style-type: none"> • Characters that cannot appear on the player are involved. <ul style="list-style-type: none"> ➔ Use the supplied SonicStage to rename the title with appropriate characters.

Continued ↓

Charging the battery

Symptom	Cause/Remedy
Battery life is short.	<ul style="list-style-type: none"> ● The operating temperature is below 5°C (67°F). → Battery life becomes shorter due to the battery characteristics. This is not malfunction. ● Battery charging time is not enough. → Charge the battery longer if the USB connection (USB Power) is set to “100mA” (☞ page 52). ● The G Sensor menu is set to “ON.” → The battery consumes more power than when the G Sensor menu (☞ page 40) is set to “OFF.” ● You can save the battery power by changing the settings and careful management of your battery usage (☞ page 63). ● The battery is required to be replaced. → Consult your near Sony dealer.
The player cannot charge the battery.	<ul style="list-style-type: none"> ● The USB cable is not connected to a USB port on your computer properly. → Disconnect the USB cable, and then reconnect it. → Use the supplied USB cable.

Connection with the computer/SonicStage

Symptom	Cause/Remedy
The SonicStage software cannot be installed.	<ul style="list-style-type: none"> ● The computer's operating system software is not compatible with SonicStage. → Refer to the system requirements (☞ page 91). ● All Windows applications are not closed. → If you start the installation while other programs are running, an error may occur. This is especially true for programs that require significant system resources, such as virus-protection software. ● There is not enough free space on the hard disk of your computer. → You need 200 MB or more of free space. Delete any unnecessary files on your computer. ● You are not logged on as an “Administrator.” → If you are not logged on as an “Administrator,” the installation of SonicStage might fail. Make sure that you are logged on using an account with “Administrator” privileges.
When installing the SonicStage software, the progress bar on the display of your computer is not moving. The access lamp of your computer has not lit for a few minutes.	<ul style="list-style-type: none"> ● The installation is progressing normally. Please wait. The installation may take 30 minutes or more, depending on your system environment.

Continued ↓

Connection with the computer/SonicStage (continued)

Symptom	Cause/Remedy
SonicStage does not start up.	<ul style="list-style-type: none"> ● Your computer's system environment has changed, perhaps due to an update of the Windows operating system.
"USB CONNECT" does not appear when connected to the computer with the supplied USB cable.	<ul style="list-style-type: none"> ● The USB cable is not connected to a USB port on your computer properly. <ul style="list-style-type: none"> → Disconnect the USB cable, and then reconnect it. → Use the supplied USB cable. ● A USB hub is being used. <ul style="list-style-type: none"> → Connecting the player via a USB hub may not work. Connect the player directly to the computer. ● Please wait for the authentication of the SonicStage software. ● Another application is running on the computer. <ul style="list-style-type: none"> → Disconnect the USB cable, wait a few minutes, and reconnect it. If the problem persists, disconnect the USB cable, restart the computer, and then reconnect the USB cable. ● The player's USB connection (USB Power) is set to "500mA." <ul style="list-style-type: none"> → Set the "USB Power" to "100mA" (ⓘ page 52). ● The installation of the SonicStage software was not successful. <ul style="list-style-type: none"> → Disconnect the player from your computer, and reinstall the software using the supplied CD-ROM (ⓘ "Quick Start Guide"). Audio songs registered with the earlier installation will be available with the new SonicStage installation.
The player is not recognized by the computer when it is connected to the computer.	<ul style="list-style-type: none"> ● The USB cable is not connected to a USB port on your computer properly. <ul style="list-style-type: none"> → Disconnect the USB cable, and then reconnect it. ● A USB hub is being used. <ul style="list-style-type: none"> → Connecting the player via a USB hub may not work. Connect the player directly to the computer.

Continued ↓

Connection with the computer/SonicStage (continued)

Symptom	Cause/Remedy
Audio data cannot be transferred to the player from your computer.	<ul style="list-style-type: none"> • The USB cable is not connected to a USB port on your computer properly. <ul style="list-style-type: none"> → Disconnect the USB cable, and then reconnect it. • There is not enough free space in the built-in flash memory. <ul style="list-style-type: none"> → Transfer any unnecessary songs back to your computer to increase free space. • You have already transferred over 65,535 songs or over 8,192 playlists to the built-in flash memory, or you are trying to transfer a playlist that contains over 999 songs. • Songs with a limited playing period or playing count may not be transferred due to restrictions set by copyright holders. For details on the settings of each audio file, contact the distributor.
Only a small number of songs can be transferred to the player. (Available recording time is short.)	<ul style="list-style-type: none"> • There is not enough free space in the built-in flash memory. <ul style="list-style-type: none"> → Transfer any unnecessary songs back to your computer to increase free space. • Non-audio data is stored in the built-in flash memory. <ul style="list-style-type: none"> → Move non-audio data to the computer to increase free space.
Audio data cannot be transferred back to your computer from the player.	<ul style="list-style-type: none"> • The computer you are trying to transfer songs to is not the same computer from which the songs were originally transferred. <ul style="list-style-type: none"> → Songs can be transferred only to the computer that they originally came from. If songs cannot be transferred back to the computer and you want to delete songs on the player, select songs on the SonicStage software and click  to delete them. • The audio data has been deleted from the computer you used to transfer to the player. <ul style="list-style-type: none"> → The audio data cannot be transferred back to your computer if the song is deleted from the computer used to transfer to the player.
The player becomes unstable while it is connected to the computer.	<ul style="list-style-type: none"> • A USB hub or USB extension cable is being used. <ul style="list-style-type: none"> → Connecting the player via a USB hub or extension cable may not work. Connect the supplied USB cable directly to the computer.

Continued ↓

FM Tuner (NW-S202F/S203F/S205F only)

Symptom	Cause/Remedy
You cannot hear the FM broadcast well.	<ul style="list-style-type: none"> • The receiving frequency is not fully tuned in. <ul style="list-style-type: none"> → Select the frequency manually to improve reception (☞ page 57).
Reception is weak and sound quality is poor.	<ul style="list-style-type: none"> • The radio signal is weak. <ul style="list-style-type: none"> → Listen to the FM broadcast near a window since the signal may be weak inside buildings or vehicles. • The headphone cord does not extend enough. <ul style="list-style-type: none"> → The headphone cord functions as an antenna. Extend the headphone cord as far as possible.
The FM broadcast is affected by interference.	<ul style="list-style-type: none"> • An apparatus emitting radio signals, such as a mobile phone is being used near the player. <ul style="list-style-type: none"> → When using such apparatus as mobile phones, keep them away from the player.

Other

Symptom	Cause/Remedy
There is no beep sound when the player is operated.	<ul style="list-style-type: none"> • Beep is set to “OFF” <ul style="list-style-type: none"> → Set “ON” in the “Beep” menu (☞ page 37).
The player gets warm.	<ul style="list-style-type: none"> • While charging, the player may become slightly warm.

Messages

Follow the instructions below if a message appears in the display.

Message	Meaning	Remedy
ACCESS	This message appears after disconnecting the USB cable from the computer, or resetting the player (🔗 page 69).	This is not an error message. Wait until the message disappears.
AVLS (blinks)	The volume level exceeds the rated value while AVLS is enabled.	Turn the volume down or disable AVLS (🔗 page 36).
CANNOT PLAY	<ul style="list-style-type: none"> • The player cannot play certain files because of incompatible formats. • Transferring has been interrupted forcefully. 	If the song which cannot be played is unnecessary, you can erase it from the built-in flash memory. For details, refer to “To delete abnormal data from the built-in flash memory” (🔗 page 79).
CHARGE ERROR	The power supply is abnormal.	Try using another computer.
DATA ACCESS	Accessing the built-in flash memory.	Please wait for access to complete. This message appears while the built-in flash memory is being accessed.
DRM ERROR	An unauthorized distribution file is detected for copyright protection.	Transfer the normal audio file back to the computer and then format the player. For details, refer to “To delete abnormal data from the built-in flash memory” (🔗 page 79).
EXPIRED	You are trying to play a song that has a playback time restriction.	If the song which cannot be played is unnecessary, you can erase it from the built-in flash memory. For details, refer to “To delete abnormal data from the built-in flash memory” (🔗 page 79).

Continued ↓

Message	Meaning	Remedy
FILE ERROR	<ul style="list-style-type: none"> • The file cannot be read. • The file is not normal. 	Transfer the normal audio file back to the computer and then format the player. For details, refer to “To delete abnormal data from the built-in flash memory” (🔗 page 79).
FORMAT ERROR	The built-in flash memory was formatted on a computer.	Format the player using the “Format” menu. For details, refer to “To delete abnormal data from the built-in flash memory” (🔗 page 79).
HOLD	The player cannot be operated because the shuttle switch is set to the HOLD position.	To operate the player, slide the shuttle switch to the Normal (centre) position (🔗 page 10).
LOW BATTERY	The battery is low.	You must charge the battery (🔗 page 62).
MEMORY ERROR	There is a problem with the built-in flash memory.	Format the player using the “Format” menu. For details, refer to “To delete abnormal data from the built-in flash memory” (🔗 page 79). If this message still appears, consult your nearest Sony dealer.
NO DATA	There are no audio files in the built-in flash memory.	If there are no audio files in the built-in flash memory, use SonicStage to transfer audio files.
NO DATABASE	The player is disconnected from the computer while transferring audio files.	Transfer the normal audio file back to the computer and then format the player. For details, refer to “To delete abnormal data from the built-in flash memory” (🔗 page 79).

Continued ↓

Message	Meaning	Remedy
NO ITEM	No song exists in the selected item.	Use SonicStage to transfer audio files.
PRESET FULL	30 broadcast stations are already preset.	You can preset up to 30 broadcast stations. If you want to preset more stations, delete unnecessary stations first (🔗 page 59), then preset the stations you want.
SET RUN P.LIST	Appears when changing the playlist in the Set Playlist (automatic song selection) menu of "SPORTS MODE."	Select the playlist to listen to songs at fast pace (🔗 page 25).
SET WALK P.LIST	Appears when changing the playlist in the Set Playlist (automatic song selection) menu of "SPORTS MODE."	Select the playlist to listen to songs at slow pace (🔗 page 25).
SYSTEM ERROR	There is a problem with the hardware.	Consult your nearest Sony dealer.
UPDATE ERROR	When the player fails to update the firmware.	Follow the on-screen instructions on the computer and update again.
USB CONNECT	The player is connected to a computer.	This is not a malfunction. You can operate the player using SonicStage, but you cannot operate the controls on the player.

Continued ↓

To delete abnormal data from the built-in flash memory

If “CANNOT PLAY,” “DRM ERROR,” “EXPIRED,” “FILE ERROR,” “FORMAT ERROR,” “MEMORY ERROR,” or “NO DATABASE” appears, there is a problem with all or part of the data stored in the built-in flash memory. Please follow the procedure below to erase data you cannot play.

- 1 Connect the player to the computer, and start SonicStage.**
- 2 If you have already specified the data with problems, erase the data using SonicStage.**
- 3 If the problem persists, transfer all data without problems back to the computer using SonicStage while the player is connected to the computer.**
- 4 Disconnect the player from the computer and then format the built-in flash memory using the “Format” menu (🔧 page 50).**

Uninstalling SonicStage

To uninstall the supplied software from your computer, follow the procedure below.

-
- 1 Click **“Start” – “Control Panel.”**¹⁾
 - 2 Double-click **“Add or Remove Programs.”**
 - 3 Click **“SonicStage X.X” in the “Currently Installed Programs” list, and then click “Remove.”**²⁾

Follow the displayed instruction and restart your computer.

The uninstallation is completed when the computer has restarted.

¹⁾ “Settings” – “Control Panel” in the case of Windows 2000 Professional.

²⁾ “Change/Remove” in the case of Windows 2000 Professional.

Note

- When you install SonicStage, OpenMG Secure Module is installed at the same time. Do not delete OpenMG Secure Module since it may be used by other software.

Owner's Record

The model and serial numbers are located on the rear of the player. Record the serial number in the space provided below. Refer to these numbers whenever you call upon your Sony dealer regarding this product.

Model No. _____

Serial No. _____

For Customers in the USA

NOTE:

This equipment has been tested and found to comply with the limits for a Class B digital device, pursuant to Part 15 of the FCC Rules. These limits are designed to provide reasonable protection against harmful interference in a residential installation. This equipment generates, uses, and can radiate radio frequency energy and, if not installed and used in accordance with the instructions, may cause harmful interference to radio communications.

However, there is no guarantee that interference will not occur in a particular installation. If this equipment does cause harmful interference to radio or television reception, which can be determined by turning the equipment off and on, the user is encouraged to try to correct the interference by one or more of the following measures:

- Reorient or relocate the receiving antenna.
- Increase the separation between the equipment and receiver.
- Connect the equipment into an outlet on a circuit different from that to which the receiver is connected.
- Consult the dealer or an experienced radio/TV technician for help.

You are cautioned that any changes or modifications not expressly approved in this manual could void your authority to operate this equipment.

Continued ↓

If you have any questions about this product:**Visit:**

www.sony.com/walkmansupport

Contact:

Sony Customer Information Service Center at 1-(866)-456-7669

Write:

Sony Customer Information Services Center
12451 Gateway Blvd.,
Fort Myers, FL 33913

Declaration of Conformity

Trade Name: SONY
Model No.: NW-S203F/S205F
Responsible Party: Sony Electronics Inc.
Address: 16530 Via Esprillo,
San Diego CA 92127 U.S.A.
Telephone Number: 858-942-2230

This device complies with Part 15 of the FCC Rules. Operation is subject to the following two conditions: (1) This device may not cause harmful interference, and (2) this device must accept any interference received, including interference that may cause undesired operation.

Continued ↓

Disposal of Old Electrical & Electronic Equipment (Applicable in the European Union and other European countries with separate collection systems)



This symbol on the product or on its packaging indicates that this product shall not be treated as household waste. Instead it shall be handed over to the applicable collection point for the recycling of electrical and electronic equipment. By ensuring this product is disposed of correctly, you will help prevent potential negative consequences for the environment and human health, which could otherwise be caused by inappropriate waste handling of this product. The recycling of materials will help to conserve natural resources. For more detailed information about recycling of this product, please contact your local Civic Office, your household waste disposal service or the shop where you purchased the product.

Applicable accessories: Headphones

For Customers in Russia

Произведено в Малайзия

Изготовитель: Сони Корпорейшн

Адрес: 6-7-35 Киташинагава, Шинагава-ку,

Токио 141-0001, Япония

Precautions

On safety

- Be sure not to short-circuit the terminals of the player with other metallic objects.
- Do not touch the rechargeable battery with bare hands if it is leaking. Since battery liquid may remain in the player, consult your nearest Sony dealer if the battery has leaked. If the liquid gets into your eyes, do not rub your eyes as it may lead to blindness. Wash out your eyes with clean water, and consult a doctor.

Also, if the liquid gets on to your body or clothes, wash it off immediately. If you do not, it may cause burns or injury. If you get burned or injured by the liquid from the battery, consult a doctor.

- Do not pour water or put any foreign object in the player. Doing so may cause fire or electric shock.
If this occurs, turn off the player immediately, disconnect the USB cable from the player, and consult your nearest Sony dealer or Sony Service Center.
- Do not put the player into the fire.
- Do not take apart or remodel the player. Doing so can result in electric shock. Consult your nearest Sony dealer or Sony Service Center for exchange of rechargeable batteries, internal checks or repair.

On installation

- Do not put any heavy object on top of the player or apply a strong shock to the player. It may cause a player to malfunction or damage.
- Never use the player where it will be subjected to extremes of light, temperature, moisture or vibration.
- Never leave the player exposed to high temperature, such as in a car parked in the sun or under direct sunlight.
The player may become discolored or deformed, or this may cause a malfunction.
- Do not leave the player in a place subject to excessive dust.
- Do not leave the player on an unstable surface or in an inclined position.
- If the player causes interference to radio or television reception, turn the player off and move it away from the radio or television.

Continued ↓

- When using the player, remember to follow the precautions below in order to avoid warping the cabinet or causing the player to malfunction.
 - Make sure not to sit down with the player in your back pocket.



- Make sure not to put the player into a bag with the headphones/earphones cord wrapped around it and then subject the bag to strong impact.

On heat build-up

Heat may build up in the player while charging if it is used for an extended period of time.

On the headphones

Road safety

Do not use headphones while driving, cycling, or operating any motorized vehicle. Doing so may create a traffic hazard and is illegal in many areas. It can also be potentially dangerous to play the player at a high volume while walking, especially at pedestrian crossings. You should exercise extreme caution or discontinue use in potentially hazardous situations. Also, when using the player while you are walking, watch out for traffic and road surface conditions.

Preventing hearing damage

Avoid using the headphones at a high volume. Hearing experts advise against continuous, loud and extended play. If you experience a ringing in your ears, reduce the volume or discontinue use.

Do not turn the volume up high all at once, especially when using headphones. Turn up the volume gradually so that loud sound will not hurt your ears.

Caring for others

Keep the volume at a moderate level. This will allow you to hear outside sounds and to be considerate to the people around you.

Warning

If there is lightning when you are using the player, take off the headphones immediately.

If you experience an allergic reaction to the supplied headphones, stop using them at once and contact a doctor.

Continued ↓

On the use

- When using a strap (sold separately), be careful to avoid hooking it on objects you pass by.
- Do not use the player on an aircraft.
- The player (except headphones) is designed to be splash-resistant, but pay attention to the following conditions:
 - Do not splash a large amount of water on the player.
 - Do not drop or immerse the player in water.
 - Rotate the lid to close it tightly to prevent objects from entering the player through the USB jack (Ⓜ page 11).
- The player's shuttle switch works on a magnetic principle. In normal use, the player should not interfere with other devices, however, care should be taken to avoid close contact with magnetically-encoded items, such as credit cards, etc. Furthermore, avoid use on a beach or near sand, which may cause damage to the player's shuttle switch, etc.
- When using the supplied arm band, avoid over tightening it as blood circulatory problems may result.

On cleaning

- Clean the player's case with a soft cloth, such as cleaning cloth for eyeglasses.
- If the player's case becomes very dirty, clean it with a soft cloth slightly moistened with water or a mild detergent solution.
- Do not use any type of abrasive pad, scouring powder, or solvent, such as alcohol or benzene, as it may mar the finish of the case.
- Be careful not to let water get into the player from the opening near the connector.
- Clean the headphone plug periodically.

If you have any questions or problems concerning the player, please consult your nearest Sony dealer.

On software

- Copyright laws prohibit reproducing the software or the manual accompanying it in whole or in part, or renting the software without the permission of the copyright holder.
- In no event will SONY be liable for any financial damage, or loss of profits, including claims made by third parties, arising out of the use of the software supplied with this player.
- In the event a problem occurs with this software as a result of defective manufacturing, SONY will replace it. However, SONY bears no other responsibility.

Continued ↓

- The software provided with this player cannot be used with equipment other than that which is so designated.
- Please note that, due to continued efforts to improve quality, the software specifications may be changed without notice.
- Operation of this player with software other than that provided is not covered by the warranty.
- The ability to display the languages on your SonicStage will depend on the installed OS on your PC. For better results, please ensure that the installed OS is compatible with the desired language you want to display.
 - We do not guarantee all the languages will be able to be displayed properly on your SonicStage.
 - User-created characters and some special characters may not be displayed.
- The explanations in this manual assume that you are familiar with the basic operations of Windows.

For details on the use of your computer and operating system, please refer to the respective manuals.

On sample audio data

The player is pre-installed with sample audio data so that you can try it out right away. To delete this audio data, delete it using SonicStage.

- The recorded music is limited to private use only. Use of the music beyond this limit requires permission of the copyright holders.
- Sony is not responsible for incomplete recording/downloading or damaged data due to problems of the player or computer.
- Depending on the types of the text and characters, the text shown on the player may not be displayed properly on device. This is due to:
 - The capacity of the connected player.
 - The player is not functioning normally.
 - The ID3 TAG information for the song is written in the language or the character that is not supported by the player.

About the customer support Web site

If you have any questions about or issue with this product, visit the following web sites.

For customers in the USA: <http://www.sony.com/walkmansupport>

For customers in Canada: <http://www.sony.ca/ElectronicsSupport/>

For customers in Europe: <http://www.support-nwwalkman.com>

For customers in Latin America: <http://www.sony-latin.com/pa/info/>

For customers in other countries/regions: <http://www.css.ap.sony.com>

For customers who purchased the overseas models:

<http://www.sony.co.jp/overseas/support/>

On Copyrights

- SonicStage and the SonicStage logo are trademarks or registered trademarks of Sony Corporation.
- OpenMG, ATRAC, ATRAC3, ATRAC3plus and their logos are trademarks of Sony Corporation.
- “WALKMAN” and “WALKMAN” logo are registered trademarks of Sony Corporation.
- Microsoft, Windows, Windows NT and Windows Media are trademarks or registered trademarks of Microsoft Corporation in the United States and/or other countries.
- Adobe and Adobe Reader are trademarks or registered trademarks of Adobe Systems Incorporated in the United States and/or other countries.
- MPEG Layer-3 audio coding technology and patents licensed from Fraunhofer IIS and Thomson.
- IBM and PC/AT are registered trademarks of International Business Machines Corporation.
- Macintosh is a trademark of Apple Computer, Inc.
- Pentium is a trademark or a registered trademark of Intel Corporation.
- CD and music-related data from Gracenote, Inc., copyright © 2000-2004 Gracenote.

Gracenote CDDB[®] Client Software, copyright 2000-2004 Gracenote. This product and service may practice one or more of the following U.S. Patents: #5,987,525; #6,061,680; #6,154,773, #6,161,132, #6,230,192, #6,230,207, #6,240,459, #6,330,593, and other patents issued or pending. Services supplied and/or device manufactured under license for following Open Globe, Inc. United States Patent 6,304,523. Gracenote and CDDB are registered trademarks of Gracenote.

The Gracenote logo and logotype, and the “Powered by Gracenote” logo are trademarks of Gracenote.

- All other trademarks and registered trademarks are trademarks or registered trademarks of their respective holders. In this manual, [™] and [®] marks are not specified.

Program ©2006 Sony Corporation

Documentation ©2006 Sony Corporation

Specifications

Audio compression technology

- MPEG-1 Audio Layer-3 (MP3)
- Windows Media Audio (WMA)*
- Adaptive Transform Acoustic Coding (ATRAC)
- Advanced Audio Coding (AAC)*

* WMA/AAC format audio files that are copyright-protected cannot be played back.

Maximum recordable number of songs and time (Approx.)*

* The approximate times are based on a transferred 4-minute ATRAC or MP3 format song. Other playable audio file formats may be different from ATRAC or MP3 format.

	NW-S202F/S202		NW-S203F	
Bit rate	Songs	Time	Songs	Time
48 kbps	340	22 hr. 40 min.	685	45 hr. 00 min.
64 kbps	255	17 hr. 00 min.	515	34 hr. 20 min.
96 kbps	170	11 hr. 20 min.	345	23 hr. 00 min.
128 kbps	125	8 hr. 20 min.	260	17 hr. 20 min.
132 kbps	120	8 hr. 00 min.	250	16 hr. 40 min.
160 kbps	100	6 hr. 40 min.	205	13 hr. 40 min.
192 kbps	85	5 hr. 40 min.	170	11 hr. 20 min.
256 kbps	64	4 hr. 10 min.	130	8 hr. 40 min.
320 kbps	51	3 hr. 20 min.	100	6 hr. 40 min.
352 kbps	46	3 hr. 00 min.	94	6 hr. 10 min.

	NW-S205F	
Bit rate	Songs	Time
48 kbps	1,350	90 hr. 00 min.
64 kbps	1,000	66 hr. 40 min.
96 kbps	690	46 hr. 00 min.
128 kbps	520	34 hr. 40 min.
132 kbps	500	33 hr. 20 min.
160 kbps	415	27 hr. 40 min.
192 kbps	345	23 hr. 00 min.
256 kbps	260	17 hr. 20 min.
320 kbps	205	13 hr. 40 min.
352 kbps	185	12 hr. 20 min.

Capacity (User available capacity)*

NW-S202F/S202: 512 MB (Approx. 482 MB = 505,724,928 bytes)

NW-S203F: 1 GB (Approx. 968 MB = 1,015,726,080 bytes)

NW-S205F: 2 GB (Approx. 1.89 GB = 2,035,974,144 bytes)

* Available storage capacity of the player may vary.
A portion of the memory is used for data management functions.

Continued ↓

Supported bit rates

MP3: 32 to 320 kbps variable bit rate-compliant

WMA: 32 to 192 kbps variable bit rate-compliant

ATRAC: 48/64/66 (ATRAC3)*/96/105 (ATRAC3)*/128/132 (ATRAC3)/160/192/256/320/352 kbps

* CD recording cannot be done using SonicStage software in ATRAC3 at 66/105 kbps.

AAC: 16 to 320 kbps variable bit rate-compliant*

* Nonstandard bit rates or non-guaranteed bit rates are included depending on the sampling frequency.

Sampling frequency*

MP3: 32, 44.1, 48 kHz

WMA: 44.1 kHz

ATRAC: 44.1 kHz

AAC: 11.025, 12, 16, 22.05, 24, 32, 44.1, 48 kHz

* Sampling frequency may not correspond to all encoders.

Frequency response

20 to 20,000 Hz (single signal measurement)

FM Frequency range (NW-S202F/S203F/S205F only)

87.5 to 108.0 MHz

IF (FM) (NW-S202F/S203F/S205F only)

375 kHz

Antenna

Headphone cord antenna

Interface

Headphone: Stereo mini

Hi-speed USB (USB 2.0 compliant)

Operating temperature

5°C to 35°C (67°F to 95°F)

Power source

- Built-in rechargeable lithium-ion battery
- USB power (from a computer through supplied USB cable)

Battery life (continuous playback)*

ATRAC format: Approximately 18 hours (Playback at 132 kbps)

ATRAC format: Approximately 17 hours (Playback at 128 kbps)

ATRAC format: Approximately 18 hours (Playback at 48 kbps)

MP3 format: Approximately 17 hours (Playback at 128 kbps)

WMA format: Approximately 15 hours (Playback at 128 kbps)

AAC format: Approximately 18 hours (Playback at 128 kbps)

FM radio reception (NW-S202F/S203F/S205F only): Approximately 5 hours

* This is when power save setting is "ON-Super" (☞ page 54), the sound quality setting (Equalizer) is "OFF" (☞ page 33), and G Sensor setting is "OFF" (☞ page 40). The battery duration will vary depending on temperature and usage.

Dimension (w/h/d)

15.0 × 96.5 × 15.0 mm (0.6 × 3.8 × 0.6 inches)

(w/h/d, projecting parts not included)

Mass

Approx. 26 g (Approx. 0.9 oz)

Continued ↓

Minimum System Requirements (for the player)

- Computer
 - IBM PC/AT or compatible computer preinstalled with the following Windows operating systems:
 - Windows 2000 Professional (Service Pack 3 or later)
 - Windows XP Home Edition
 - Windows XP Professional
 - Windows XP Media Center Edition
 - Windows XP Media Center Edition 2004
 - Windows XP Media Center Edition 2005
 - OSs other than those indicated above are not supported.
- CPU: Pentium III 450 MHz or higher
- RAM: 128 MB or more
- Hard Disk drive: 200 MB or more of available space (1.5 GB or more is recommended)
 - More space may be required, depending on the version of the operating system. Additional space is required for storing music data.
- Display:
 - Screen Resolution: 800 × 600 pixels (or higher) (recommended 1,024 × 768 or higher)
 - Colors: High Color (16 bit) (or higher) (SonicStage may not operate properly at color settings at or below 256 colors.)
- CD-ROM drive (supporting Digital Music CD playback capabilities using WDM)
 - To create original CDs or to back up audio CDs, a CD-R/RW drive is required.
- Sound board
- USB port (Hi-Speed USB is recommended)
- Internet Explorer 5.5 or later needs to be installed.
- Internet connection is required to use the CD Data Base (CDDb) or Electronic Music Distribution (EMD).

We do not guarantee operation for all computers even if they meet the above System Requirements.

Not supported by the following environments:









- Personally constructed PCs or operating systems
- An environment that is an upgrade of the original manufacturer-installed operating system
- Multi-boot environment
- Multi-monitor environment
- Macintosh

Design and specifications are subject to change without notice.

US and foreign patents licensed from Dolby Laboratories.

Index

Symbols

 (Album).....	29
 (Artist)	29
 (Artist/Album)	29
 (Folder)	19
 1 (Repeat 1 Song).....	19
 (Repeat All)	19
 (Repeat Folder)	19
 SHUF (Repeat Shuffle All)	19
 SHUF (Repeat Shuffle Folder)	19

A

AAC.....	64
Accessories	6
Adobe Reader.....	3
Album	17
ALL SONGS	13
Artist	16
ATRAC.....	64, 65, 89
AVLS (Limiting the volume).....	36

B

Battery.....	62, 63
Beep (Beep sound)	37
Bit rate.....	64

C

Calorie.....	21, 38
Charge the battery	62
Clock.....	27
Computer.....	3, 91
Counter Reset	43
Count History	42

D

D.Normalizer	35
Date-Time	44, 46, 47
Date Disp Type	46
Disp. Rotation	53
DISP button.....	9
Display	12
Dynamic Normalizer	35

E

Equalizer	33
Explorer	67

F

Fast-forward.....	10
Fast-rewind.....	10
FM	55
FM Auto Preset.....	56
Folder (control mode).....	10, 29
Format (Formatting).....	50

G

G Sensor.....	40
---------------	----

H

Headphones.....	6, 11, 85
HOLD	10
HOME button	9
HOME screen	8

I

Information	48
Initialize	49, 50

Continued ↓

K

km..... 22

M

Manual (Volume) 32

Manual tuning 57

Messages 76

miles 22

Mono/Auto 61

MP3 64, 89

Music Pacer 23

P

Playback..... 9

Playlist..... 14

Play Mode..... 18

Play Range 19

Power Save..... 54

Preset Custom 34

Preset (Volume) 30

Preset tuning 57

R

Radio 55

Recharging..... 62

Repeat..... 19

Reset (the players) 69

Reset All Setting..... 49

S

Scan Sens 60

SEARCH 15

 by album 17

 by artist..... 16

 by song name..... 15

Searching for Songs..... 15

Serial Number 48

Set Date-Time 44

Set Playlist..... 25

Set Target 21

Set the current time..... 44

SETTINGS..... 8

Shuffle 19

Shuttle switch 10

Skip to the beginning of a song 10

Song Information 66

Song order 29

SonicStage..... 3, 80

Sort 29

Sound 33, 34, 35, 36, 37

Sound quality 33, 34

SPORTS MODE..... 21, 23, 38

STOPWATCH..... 26

T

Time Disp Type 47

Transferring..... 3

Troubleshooting..... 69

Tuner 55

U

Uninstalling..... 80

USB Power
 (USB connection setting) 52

V

Volume..... 9, 30, 33

Volume Mode..... 30

VOL +/- button..... 9

W

Windows Explorer..... 67

WMA 64, 89

Free Manuals Download Website

<http://myh66.com>

<http://usermanuals.us>

<http://www.somanuals.com>

<http://www.4manuals.cc>

<http://www.manual-lib.com>

<http://www.404manual.com>

<http://www.luxmanual.com>

<http://aubethermostatmanual.com>

Golf course search by state

<http://golfingnear.com>

Email search by domain

<http://emailbydomain.com>

Auto manuals search

<http://auto.somanuals.com>

TV manuals search

<http://tv.somanuals.com>