

Portable CD/DVD Player

Operating Instructions

 To find out useful hints, tips and information about Sony products and services please visit:
www.sony-europe.com/myproduct



DVP-FX850

WARNING

To reduce the risk of fire or electric shock, do not expose this apparatus to rain or moisture.

To avoid electrical shock, do not open the cabinet. Refer servicing to qualified personnel only.

The mains lead must be changed only at a qualified service shop.

Batteries or batteries installed apparatus shall not be exposed to excessive heat such as sunshine, fire or the like.



This label is located on the bottom of the unit.

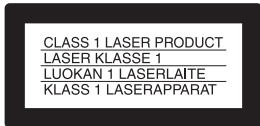

This appliance is classified as a CLASS 1 LASER product. The CLASS 1 LASER PRODUCT MARKING is located on the bottom of the unit.

CAUTION

- The use of optical instruments with this product will increase eye hazard. As the laser beam used in this CD/DVD player is harmful to eyes, do not attempt to disassemble the cabinet. Refer servicing to qualified personnel only.
- Danger of explosion if battery is incorrectly replaced. Replace only with the same or equivalent type recommended by the manufacturer. Discard used batteries according to the manufacturer's instructions.

Notice for customers in the United Kingdom and Republic of Ireland

A moulded plug complying with BS1363 is fitted to this equipment for your safety and convenience. Should the fuse in the plug supplied need to be replaced, a 5AMP fuse approved by ASTA or BSI to BS1362, (i.e., marked with ⚡ or ⚡ mark) must be used. If the plug supplied with this

equipment has a detachable fuse cover, be sure to attach the fuse cover after you change the fuse. Never use the plug without the fuse cover. If you should lose the fuse cover, please contact your nearest Sony service station.



Disposal of Old Electrical & Electronic Equipment (Applicable in the European Union and other European countries with separate collection systems)

This symbol on the product or on its packaging indicates that this product shall not be treated as household waste. Instead it shall be handed over to the applicable collection point for the recycling of electrical and electronic equipment. By ensuring this product is disposed of correctly, you will help prevent potential negative consequences for the environment and human health, which could otherwise be caused by inappropriate waste handling of this product. The recycling of materials will help to conserve natural resources. For more detailed information about recycling of this product, please contact your local Civic Office, your household waste disposal service or the shop where you purchased the product.



Disposal of waste batteries (applicable in the European Union and other European countries with separate collection systems)

This symbol on the battery or on the packaging indicates that the battery provided with this product shall not be treated as household waste.

By ensuring these batteries are disposed of correctly, you will help prevent potentially negative consequences for the environment and human health which could otherwise be caused by inappropriate waste handling of the battery. The recycling of the materials will help to conserve natural resources.

In case of products that for safety, performance or data integrity reasons require a permanent connection with an incorporated battery, this battery should be replaced by qualified service staff only.

To ensure that the battery will be treated properly, hand over the product at end-of-life to the applicable collection point for the recycling of electrical and electronic equipment.

For all other batteries, please view the section on how to remove the battery from the product safely. Hand the battery over to the applicable collection point for the recycling of waste batteries.

For more detailed information about recycling of this product or battery, please contact your local Civic Office, your household waste disposal service or the shop where you purchased the product.

Precautions Safety

- The power requirements of this unit are indicated on the AC adapter. Check that the unit's operating voltage is identical with your local power supply.
- To prevent fire or shock hazard, do not place objects filled with liquids, such as vases, on the apparatus.

Installing

- Do not install the unit in an inclined position. It is designed to be operated in a horizontal position only.
- Keep the unit and discs away from equipment with strong magnet, such as microwave ovens, or large loudspeakers.
- Do not place heavy objects on the unit.

Notes About the Discs

- To keep the disc clean, handle the disc by its edge. Do not touch the surface.



- Do not expose the disc to direct sunlight or heat sources such as hot air ducts, or leave it in a car parked in direct sunlight as the temperature may rise considerably inside the car.
- After playing, store the disc in its case.
- Clean the disc with a cleaning cloth. Wipe the disc from the centre out.



- Do not use solvents such as benzene, thinner, disc/lens cleaners, or anti-static spray intended for vinyl LPs.
- If you have printed the disc's label, dry the label before playing.

Precautions

Road safety

Do not use the monitor unit and headphones while driving, cycling, or operating any motorized vehicle. Doing so may create a traffic hazard and is illegal in some areas. It can also be potentially dangerous to play your headsets at high volume while walking, especially at pedestrian crossings. You should exercise extreme caution or discontinue use in potentially hazardous situations.

On safety

Should any solid object or liquid fall into the cabinet, unplug the player and have it checked by qualified personnel before operating it any further.

On power sources

- The player is not disconnected from the AC power source (mains) as long as it is connected to the wall outlet, even if the player itself has been turned off.
- If you are not going to use the player for a long time, be sure to disconnect the player from the wall outlet. To disconnect the AC power cord (mains lead), grasp the plug itself; never pull the cord.
- Do not touch the mains lead or the AC adaptor with wet hands. Doing so may cause shock hazard.

On temperature increases

Heat may build up inside the player during charging or if it is being used for a long time. This is not a malfunction.

On placement

- Place the player in a location with adequate ventilation to prevent heat build-up in the player.
- Do not place the player on a soft surface such as a rug that might block the ventilation holes.
- Do not place the player in a confined space such as a bookshelf or similar unit.
- To reduce the risk of fire, do not cover the ventilation of the apparatus with newspapers, tablecloths, curtains, etc.

- Do not place the player in a location near heat sources, or in a place subject to direct sunlight, excessive dust, sand, moisture, rain, or mechanical shock, or in a car with its windows closed.

On operation

- If the player is brought directly from a cold to a warm location, or is placed in a very damp room, moisture may condense on the lenses inside the player. Should this occur, the player may not operate properly. In this case, remove the disc and leave the player turned on for about half an hour until the moisture evaporates.
- When you move the player, take out any discs. If you do not, the disc may be damaged.
- Keep the lens on the player clean and do not touch it. Touching the lens may damage the lens and cause the player to malfunction. Leave the disc lid closed except when you insert or remove discs.

On Liquid Crystal Display

- Although manufactured with high precision technology, the LCD may occasionally display dots of various colours. That is not a malfunction.
- Do not wipe the LCD surface with wet cloth. If water enters, a malfunction may result.
- Do not place or drop any object onto the LCD surface. Also, do not apply pressure from hands or elbows.
- If the player is brought directly from a cold to a warm location, moisture may condense over the LCD surface. In which case, wipe out the moisture with tissue paper, etc., before use. However, moisture condensation will continue if the LCD surface is cold. Wait until the surface warms to room temperature.

On AC adaptor

Install this system so that the mains lead can be unplugged from the wall socket immediately in the event of trouble.

- Use the supplied AC adaptor for this player, as other adaptors may cause a malfunction.
- Do not confine the AC adaptor in a closed place such as a bookshelf or an AV cabinet.

- Do not connect the AC adaptor to a traveler's electric transformer, which may generate heat and cause a malfunction.

On battery pack

- Certain countries may regulate disposal of the battery used to power this product. Please consult with your local authority.
- Because of the battery's limited life, its capacity gradually deteriorates over time and repeated use. Purchase a new one when the battery holds about only half the normal period.
- The battery may not be charged to its fullest capacity when charged for the first time, or when it has not been used for a long time. The capacity recovers after being charged and discharged several times.
- Do not leave the battery pack in a car or direct sunlight, where temperature goes up above 60 °C.
- Do not expose to water.
- Avoid short-circuiting the battery connecting jacks (A) located on the bottom of the player and the connecting jacks (C) on the battery pack with metal objects such as a necklace.
- Make sure dust or sand does not enter the battery connecting jacks (A) and the guide holes (B) located on the bottom of the player, and the connecting jacks (C) and the guide holes (D) on the battery pack.

Bottom of the player

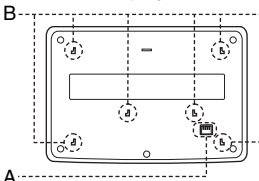

Battery pack

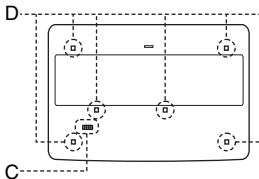

On car adaptor

- Use the supplied car adaptor for this player, as other adaptors may cause a malfunction.
- Do not disassemble or reverse-engineer.
- Do not drop or apply shock.
- Do not touch the metal parts, as it may cause a short and damage the car adaptor, especially if touched by other metal objects.
- Do not place the car adaptor in a location near heat sources, or in a place subject to direct sunlight or mechanical shock, or in a car with its windows closed.

On adjusting volume

Do not turn up the volume while listening to a section with very low level inputs or no audio signals. If you do, the speakers may be damaged when a peak level section is played.

On headphones

- **Preventing hearing damage**
Avoid using headphones at high volumes. Hearing experts advice against continuous, loud, and extended play. If you experience a ringing in your ears, reduce the volume or discontinue use.
- **Showing consideration for others**
Keep the volume at a moderate level. This will allow you to hear outside sounds and still be considerate to the people around you.

On cleaning

Clean the cabinet, panel, and controls with a soft cloth slightly moistened with a mild detergent solution. Do not use any type of abrasive pad, scouring powder or solvent such as alcohol or benzine.

On cleaning discs, disc/lens cleaners

Do not use cleaning discs or disc/lens cleaners (including wet or spray types). These may cause the apparatus to malfunction.

IMPORTANT NOTICE

Caution: This player is capable of holding a still video image or on-screen display image on your television screen indefinitely. If you leave the still video image or on-screen display image displayed on your TV for an extended period of time you risk permanent damage to your television screen. Plasma display panel televisions and projection televisions are susceptible to this.







If you have any questions or problems concerning your player, please consult your nearest Sony dealer.

Table of Contents

| | |
|--|-----------|
| WARNING | 2 |
| Notes About the Discs | 3 |
| Precautions | 3 |
| About This Manual | 6 |
| This Player Can Play the Following Discs | 7 |
| <hr/> | |
| Preparations | 9 |
| Checking the Accessories | 9 |
| Using the Remote | 9 |
| Using the LCD Panel | 10 |
| Connecting the AC Adapter | 11 |
| Using with Battery Pack | 12 |
| Using With the Car Battery Adaptor | 14 |
| <hr/> | |
| Playing Discs | 15 |
| Playing Discs | 15 |
| Using the Playback Settings Display | 21 |
| Searching for a Particular Point on a Disc (Search, Scan, Slow Play, Repeat Play, Random Play) | 23 |
| Playing MP3 Audio Tracks or JPEG Image Files | 25 |
| Adjusting the Picture Size and Quality | 28 |
| <hr/> | |
| Enjoying DivX[®] Videos | 30 |
| Playing DivX Video Files | 30 |
| About DivX Video Files | 31 |
| <hr/> | |
| Settings and Adjustments | 33 |
| Using the Setup Display | 33 |
| Settings for the Display (General Setup) | 34 |
| Settings for the Sound (Audio Setup) | 35 |
| Setting the Display or Sound Track Language (Language Setup) | 36 |
| Parental Control Settings (Parental Control) | 37 |
| <hr/> | |
| Hookups | 39 |
| Connecting to another device | 39 |
| <hr/> | |
| Additional Information | 42 |
| Troubleshooting | 42 |
| About MP3 Audio Tracks and JPEG Image Files | 44 |
| Specifications | 46 |
| Index to Parts and Controls | 47 |
| Index | 50 |

About This Manual

- Instructions in this manual describe the controls on the remote. You can also use the controls on the player if they have the same or similar names as those on the remote.
- “DVD” may be used as a general term for DVD VIDEOS, DVD+RWs/DVD+Rs (+VR mode) and DVD-RWs/DVD-Rs (VR mode, video mode).
- The meaning of the icons used in this manual is described below:

| Icons | Meaning |
|---|--|
|  | Functions available for DVD VIDEOS and DVD+RWs/DVD+Rs in +VR mode or DVD-RWs/DVD-Rs in video mode |
|  | Functions available for DVD-RWs/DVD-Rs in VR (Video Recording) mode |
|  | Functions available for VIDEO CDs (including Super VCDs or CD-Rs/CD-RWs in video CD format or Super VCD format) |
|  | Functions available for music CDs or CD-Rs/CD-RWs in music CD format |
|  | Functions available for DATA CDs (CD-ROMs/CD-Rs/CD-RWs containing MP3 ^{*1} audio tracks, JPEG image files, and DivX ^{*2*3} video files) |
|  | Functions available for DATA DVDs (DVD-ROMs/DVD+RWs/DVD+Rs/DVD-RWs/DVD-Rs containing MP3 ^{*1} audio tracks, JPEG image files, and DivX ^{*2*3} video files) |
|  | Functions available for USB devices containing MP3 ^{*1} audio tracks, and JPEG image files |

*1 MP3 (MPEG-1 Audio Layer III) is a standard format defined by ISO (International Organization for Standardization)/IEC (International Electrotechnical Commission) MPEG which compresses audio data.

*2 DivX[®] is a video file compression technology, developed by DivX, Inc.

*3 DivX, DivX Certified, and associated logos are trademarks of DivX, Inc. and are used under licence.

This Player Can Play the Following Discs

| Format of discs | |
|----------------------------|--|
| DVD VIDEO |  |
| DVD-RW/-R (finalized disc) |  |
| DVD+RW/+R (finalized disc) |   |
| VIDEO CD/ Music CD |  |
| CD-RW/-R |  |

“DVD+RW,” “DVD-RW,” “DVD+R,” “DVD-R,” “DVD VIDEO,” and “CD” logos are trademarks.

Note about CDs/DVDs

The player can play CD-ROMs/CD-Rs/CD-RWs recorded in the following formats:

- music CD format
 - video CD format
 - MP3 audio tracks, JPEG image files, and DivX video files of format conforming to ISO 9660* Level 1, or its extended format, Joliet
 - KODAK Picture CD format
- * A logical format of files and folders on CD-ROMs, defined by ISO (International Organization for Standardization).

The player can play DVD-ROMs/ DVD+RWs/DVD-RWs/DVD+Rs/DVD-Rs recorded in the following format:

- MP3 audio tracks, JPEG image files, and DivX video files of format conforming to UDF (Universal Disk Format).

Example of discs that the player cannot play

The player cannot play the following discs:

- Blu-ray discs.
- Discs recorded in AVCHD format.
- HD DVDs.
- DVD-RAMs.
- CD-ROMs/CD-Rs/CD-RWs other than those recorded in the formats listed on this page.
- CD-ROMs recorded in PHOTO CD format.
- Data part of CD-Extras.
- DVD Audio discs.
- DATA DVDs that do not contain MP3 audio tracks, JPEG image files, or DivX video files.
- HD layer on Super Audio CDs.

Also, the player cannot play the following discs:

- A DVD VIDEO with a different region code.
- A disc that has a non-standard shape (e.g., card, heart).
- A disc with paper or stickers on it.
- A disc that has the adhesive of cellophane tape or a sticker still left on it.

Notes

- **Notes about DVD+RWs/DVD+Rs, DVD-RWs/ DVD-Rs or CD-Rs/CD-RWs**
Some DVD+RWs/DVD+Rs, DVD-RWs/DVD-Rs, or CD-Rs/CD-RWs cannot be played on this player due to the recording quality or physical condition of the disc, or the characteristics of the recording device and authoring software.
The disc will not play if it has not been correctly finalized. For more information, refer to the operating instructions for the recording device. Note that some playback functions may not work with some DVD+RWs/DVD+Rs, even if they have been correctly finalized. In this case, view the disc by normal playback. Also some DATA CDs/DATA DVDs created in Packet Write format or multiple sessions cannot be played.
- **Notes about DVD+R DLs/DVD-R DLs**
MP3 and JPEG files recorded on the second layer of a DVD+R DL/-R DL (double layered) cannot be played.
DVD-R DL discs recorded in VR mode cannot be played.

- **Music discs encoded with copyright protection technologies**

This product is designed to playback discs that conform to the Compact Disc (CD) standard. Recently, various music discs encoded with copyright protection technologies are marketed by some record companies. Please be aware that among those discs, there are some that do not conform to the CD standard and may not be playable by this product.

- **Note on DualDiscs**

A DualDisc is a two sided disc product which mates DVD recorded material on one side with digital audio material on the other side. However, since the audio material side does not conform to the Compact Disc (CD) standard, playback on this product is not guaranteed.

Region code

It is the system that is used to protect copyrights. The region code is shown on the DVD VIDEO packages according to the region of sale. DVD VIDEOS labelled "ALL" or "2" will play on this player.



Note on playback operations of DVDs and VIDEO CDs

Some playback operations of DVDs and VIDEO CDs may be intentionally set by software producers. Since this player plays DVDs and VIDEO CDs according to the disc contents the software producers designed, some playback features may not be available. Also, refer to the instructions supplied with the DVDs or VIDEO CDs.

Copyrights

This product incorporates copyright protection technology that is protected by U.S. patents and other intellectual property rights. Use of this copyright protection technology must be authorized by Macrovision, and is intended for home and other limited viewing uses only unless otherwise authorized by Macrovision. Reverse engineering or disassembly is prohibited.

Trademarks

- Manufactured under license from Dolby Laboratories. "Dolby," "Pro Logic," and the double-D symbol are trademarks of Dolby Laboratories.
- "DTS" and "DTS Digital Out" are registered trademarks of DTS, Inc.

Preparations

Checking the Accessories

Check that you have the following items:

- Audio/video cord (mini plug × 2 ↔ phono plug × 3) (1)
- Mains lead (1)
- AC adaptor (1)
- Car battery adaptor (1)
- Battery pack (NP-FX110) (1)
- Remote (with battery) (1)
- Carry case (1)

Using the Remote

When operating, point it at the remote sensor  on the player.

To replace the remote control battery

Insert a lithium battery CR2025 matching the ⊕ and ⊖ ends of the battery.

- 1** Pull out the battery holder (②) while pressing the lock lever (①).

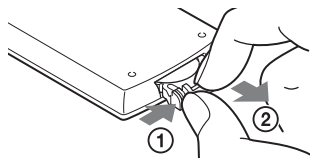

- 3** Insert the new battery in the battery holder with the ⊕ side up and then push the holder fully.

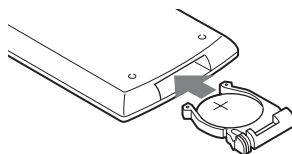

- 2** Remove the old battery.

Notes

- Do not expose the remote sensor  to direct sunlight or a lighting apparatus. Doing so may cause a malfunction.
- No button operation can be made, when the battery drains. If the remote does not work at all, change the battery and check the status.
- When disposing the used batteries, follow the battery maker's instructions.

Using the LCD Panel

The LCD panel of the player can rotate a maximum of 180 degrees clockwise and still be used. After rotation of the LCD panel, it can be folded down on the main body of the player and still function.

Rotating the LCD panel

- 1** Place the player on a table or other flat stable surface.
- 2** Push the LCD panel up with your thumbs until it is open to the vertical position.

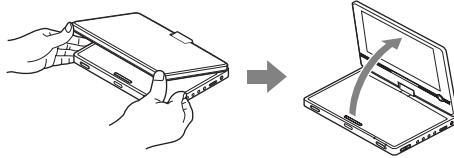

- 3** Slowly rotate the LCD panel 180 degrees in the direction indicated by the arrow (clockwise).

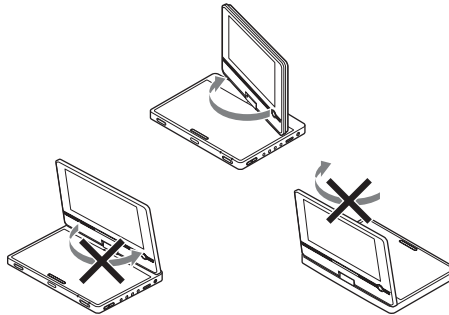

Rotating and folding down the LCD panel

After rotating the LCD panel 180 degrees clockwise push the LCD panel down onto the main body of the player. In this position the panel is facing up.

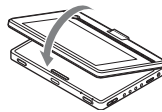

To return the LCD panel to its original position

Open the LCD panel to the vertical position and rotate the LCD panel counter-clockwise slowly.

Notes

- Do not rotate the LCD panel over 180 degrees. In addition, do not rotate in the opposite direction. Doing so will break the LCD panel.
- If the LCD panel does not fully open, do not further rotate it. The LCD panel may become damaged.
- Return the LCD panel to its original positions after use. The LCD screen can be damaged by sudden shocks or similar treatment.

Connecting the AC Adapter

Connect the AC adaptor (supplied) in the order of ① to ③ below.
To disconnect, follow the steps in reverse order.
See also “On AC adaptor” in “Precautions” (page 3).

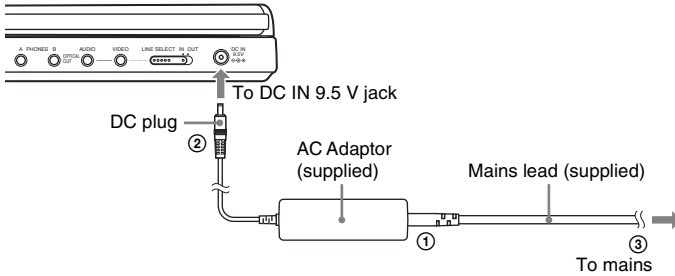

Note

Stop playback before disconnecting the mains lead. Failure to do so may cause a malfunction.

Using with Battery Pack

When a mains connection is not available, the player can be enjoyed with the battery pack (supplied) installed.

Please charge the battery pack before using it.

See also “On battery pack” in “Precautions” (page 4).

Installing the battery pack

- 1** Aligning the battery pack with the lines on the player’s bottom, engage the hooks of the battery pack in the holes on the bottom of the player.
- 2** Slide the battery pack in the direction of the arrow until it clicks into place.

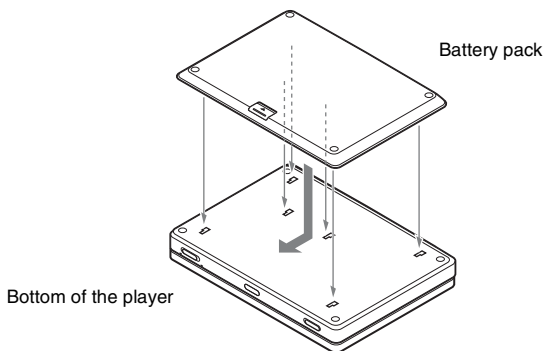

To remove the battery pack

Push the release knob and slide the battery pack in the direction of the arrow.

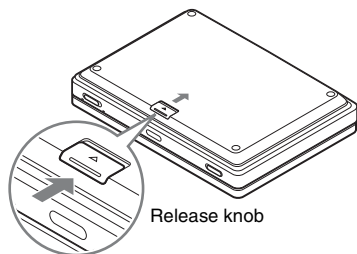

Notes

- Turn the player off before installing the battery pack.
- Do not remove the battery pack during playback.
- Do not touch the connecting points of the player and the battery pack. Doing so may cause a malfunction.
- Be careful not to drop the battery pack when installing and removing it.

Charging the battery pack

- 1 Attach the battery pack to the player (page 12).
- 2 Connect the AC adaptor to the player, and then connect the mains lead into a mains (page 11).

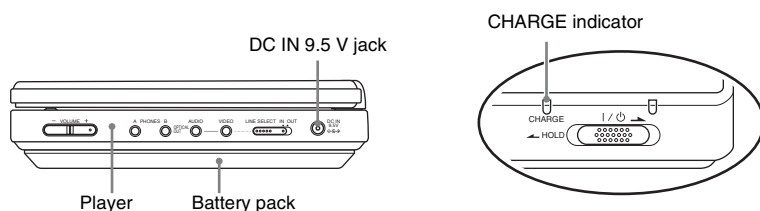

When charging begins, the CHARGE indicator turns on.
When charging ends, the CHARGE indicator turns off.

- 3 After charging is finished, disconnect the mains lead from the mains and remove the AC adaptor.

To check the battery level

When the player is stopped, a battery indicator is displayed on the screen. Recharge the battery, when  is displayed or the CHARGE indicator flashes.



The battery indicator is not displayed when a DVD, VIDEO CD or JPEG file are being played. Stop the player and check the battery level.

Charging time and maximum playing time

Charging time (with the player turned off) Playing time (with the display turned on)

| | |
|--------------------|---------------------|
| Approx. 6 hours | Approx. 6 hours* |
|--------------------|---------------------|

* This is the indication of the longest continuous playback on the following conditions.

- normal temperature (20°C)
- Headphone Use
- Set Backlight Adjustment to the Minimum
- Set “Digital Output” to “Off” in “Audio Setup.”

Battery condition may reduce operating time.

Notes

- The battery indicator does not appear on the screen when the AC adaptor is used or when inputting from external sources.
- Charging times may differ from that indicated above due to conditions of use, environment, and other factors. The recommended charge up surrounding temperature is in the 10-30°C range.

Using With the Car Battery Adaptor

Use the car battery adaptor (supplied) to supply power from the cigarette lighter socket to the player. The adaptor is for a 12V car battery. Do not use it with a 24V car battery. The adaptor is also for use with negatively grounded cars. Do not use it with cars grounded positively.

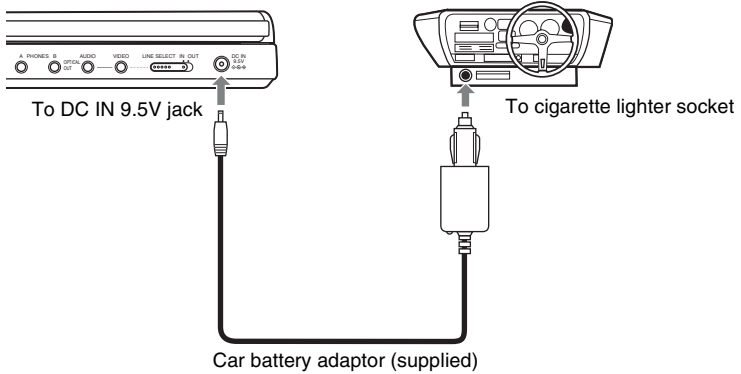

Hint

If the car adaptor interferes with car operation, use a commercial cigarette lighter extension cord.

Notes

- Do not use the car adaptor if it has been dropped or damaged.
- Arrange the cord so as not to interfere with the driver. Also, do not place the LCD panel where the driver can watch.
- If the picture is not clear, keep the player away from the car battery adaptor.
- Use the car battery adaptor with the car engine running. If it is used with the car engine off, the car battery may become unusable.
- If the cigarette lighter socket is dirty with ash, etc, a bad connection may cause the plug to heat up. Always clean well before use.
- The car battery adaptor may heat up while charging or after a long period of use. That is not a malfunction.

After using the car battery adaptor

After turning the player off, disconnect the car battery adaptor from the cigarette lighter socket.

Notes

- Do not turn off the car engine while the player is turned on. Doing so stops the power supply and may cause damage to the player.
- Disconnect the car battery adaptor after use. Since some cars supply power to the cigarette lighter socket even when the engine is turned off, the car battery may discharge over time.
- When disconnecting the car battery adaptor, hold the plug to pull it out.
- When listening to the car radio, disconnect the car battery adaptor from the cigarette lighter socket to avoid noise.

Playing Discs

- DVD**Video **DVD**VR **VCD** **CD**
- DATA CD** **DATA DVD** **USB**

Depending on the DVD or VIDEO CD, some operations may be different or restricted. Refer to the operating instructions supplied with the disc.
 Connect the AC adaptor or install the battery pack.

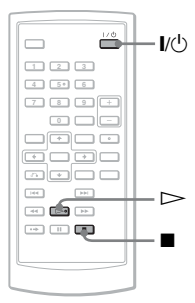
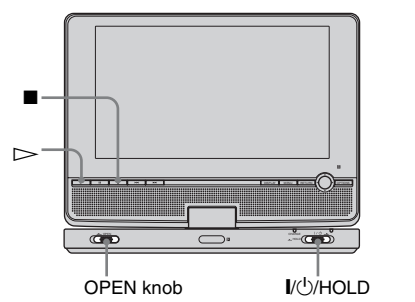

1 Open the player's LCD panel.

Set the LINE SELECT switch on the player's right side to "OUT" and set the CD/DVD USB switch on the player's left side to "CD/DVD."

2 Press I/POWER on the remote or slide the I/POWER/HOLD switch of the player to the right.

The player turns on and the power indicator lights up in green.

3 Slide the OPEN knob to the left and open the disc lid.

4 Insert the disc to be played.

Push with the playback side down until it clicks.

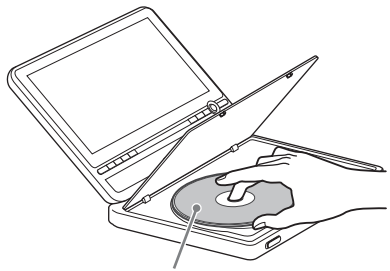

Playback side facing down

5 Push the PUSH CLOSE on the player to shut the disc lid.

6 Press ▷.

Playback starts.

- Some discs may start playing automatically after the disc lid is shut.
- Depending on the disc, a menu may appear on the screen. For DVD VIDEOS, see page 17. For VIDEO CDs, see page 20.
- After all titles have been played, the player will stop itself and the display will return to the menu screen.

Notes



- If the disc is inserted with playback side up, a "No Disc" or "Cannot play this disc." message appears.
- Discs created on DVD recorders must be correctly finalized to play on this player. For more information about finalizing, refer to the operating instructions supplied with the DVD recorder.

- The disc may be still spinning when the disc lid is opened. Wait until the spinning stops before removing the disc.
- During operation, “” may appear on the screen. This symbol indicates that a function explained in this operating instruction is not available on the current DVD VIDEO.
- Some DVD-RWs/DVD-Rs (VR mode) may take time before starting playback because of the recorded content.



To stop playback

Press .

Pressing  again will start playback from the point you stopped (Resume Play). See page 17 for details.

To play from the beginning, press  twice, then press .

To turn off the power

Press the remote's  button or slide the player's /HOLD switch to the right.

To avoid accidental button operation on the player

Set the player's /HOLD switch to “HOLD.” All the buttons on the player are locked, while the button on the remote remains operable.

To play DTS sound tracks on a DVD VIDEO

- The player's speaker does not output DTS sound. When you play DTS sound tracks on a DVD VIDEO, connect the player to an AV amplifier (receiver) (page 40) and set up “DTS” in “Audio Setup” (page 36).
- If you connect the player to audio equipment such as an AV amplifier (receiver) without a DTS decoder, do not set “DTS” to “On” in “Audio Setup” (page 36). A loud noise may come out from the speakers, which may affect your ears or cause speaker damage.

Notes





- A screen saver image appears when you leave the player in pause or stop without operation for more than 15 minutes. The image disappears when you press . See page 35 for details.
- The player turns off, 15 minutes after starting the screen saver function (Auto Power Off).

Additional playback operations

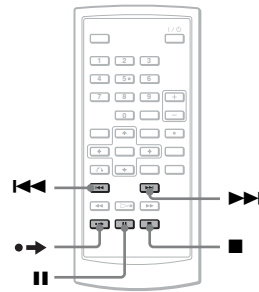
DVDVideo **DVDVR** **VCD** **CD** **DATA CD** **DATA DVD**

USB



| To | Operation |
|--|--|
| Stop | Press  |
| Pause | Press  |
| Go to the next chapter, track, or scene in continuous play mode | Press  |
| Go back to the previous chapter, track, or scene in continuous play mode | Press  |
| Briefly fast forward the current scene* | Press  during playback. |

* DVD VIDEOS, DVD-RWs/DVD-Rs (VR mode) only.

The above functions may not be used for some scenes.

Resuming playback from the point where you stopped the disc (Resume Play)

DVDVideo DVDVn VCD

CD

When you stop playback, the player remembers the stop point and displays a message on the screen. You can resume from the same point by pressing \triangleright again. Resume Play works even after the player is turned off, as long as the disc lid is kept closed.

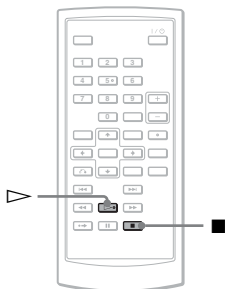

1 While playing a disc, press \blacksquare to stop playback.

A message appears.

2 Press \triangleright .

The player starts playback from the point you stopped in step 1.

Hints

- To play from the beginning of the disc, press \blacksquare twice, then press \triangleright .
- When turning power on again after power off, resume play starts automatically.

Notes

- Depending on the stop point, Resume play may not start from exactly the same point.
- The point where you stopped playing is cleared when:
 - you turn off the player while playing a DVD-RW/DVD-R (VR mode).
 - you open the disc lid.
 - you disconnect the battery pack and the AC adaptor.
 - you change the CD/DVD USB or LINE SELECT switch setting.

Using the DVD's menu

DVDVideo

A DVD is divided into long sections of a picture or a music feature called "titles." When you play a DVD containing several titles, you can select the title you want using the TOP MENU button.

When you play DVDs that allow you to select items such as language for the sound and subtitles, select these items using the MENU button.

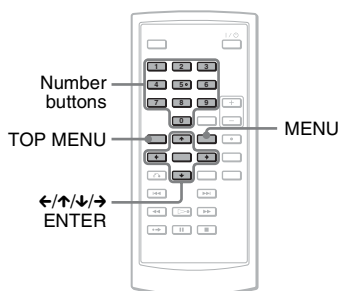

1 Press TOP MENU or MENU.

The disc's menu appears on the screen. The contents of the menu vary from disc to disc.

2 Press $\leftarrow/\rightarrow/\uparrow/\downarrow$ or the number buttons to select the item you want to play or change.

3 Press ENTER.

Note

Depending on the disc, you may not be able to use \leftarrow/\rightarrow of the player for the disc menu. In this case, use \leftarrow/\rightarrow on the remote.

Changing the sound

DVDvideo DVDvr VCD CD

When playing a DVD VIDEO recorded in multiple audio formats (PCM, Dolby Digital, or DTS), you can change the audio format. If the DVD VIDEO is recorded with multilingual tracks, you can also change the language.

With CDs or VIDEO CDs, you can select the sound from either the right or left channel and listen to the sound of the selected channel through both the right and left speakers. For example, when playing a disc containing a song with the vocals on the right channel and the instruments on the left channel, you can hear the instruments from both speakers by selecting the left channel.

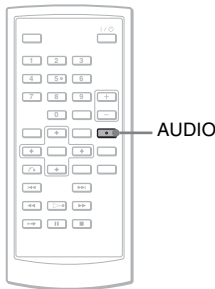

1 Press **AUDIO** repeatedly to select the desired audio signal.

The default setting is underlined.

◆ When playing a DVD VIDEO

Depending on the DVD VIDEO, the choice of language varies.

When the same language is displayed two or more times, the DVD VIDEO is recorded in multiple audio formats.

◆ When playing a DVD-VR mode disc

The types of sound tracks recorded on a disc are displayed.

Example:

- 1.Main (main sound)
- 1.Sub (sub sound)
- 1.Main+Sub (main and sub sound)

◆ When playing a CD/VIDEO CD

- Stereo: the standard stereo sound
- Left: the sound of the left channel (monaural)
- Right: the sound of the right channel (monaural)

◆ When playing a Super VCD

- Stereo: the stereo sound of the audio track 1
- Left: the sound of the left channel of the audio track 1 (monaural)
- Right: the sound of the right channel of the audio track 1 (monaural)
- Stereo 1: the stereo sound of the audio track 2
- Left 1: the sound of the left channel of the audio track 2 (monaural)
- Right 1: the sound of the right channel of the audio track 2 (monaural)

🔧 Hints

- You can check of the current audio format (Dolby Digital, DTS, PCM, etc.) by pressing AUDIO repeatedly while playing a DVD VIDEO.
- You can switch the sound in the Playback Settings Display while playing a DVD (page 21).

Notes

- Depending on the disc, you may not be able to change the audio format, even if it is recorded in multiple audio formats.
- When playing a Super VCD that does not contain audio track 2, no sound will come out if you select "Stereo 1," "Left 1," or "Right 1."
- When playing soundtracks on DVD-RW/DVD-R (VR mode) with audio equipment such as an AV amplifier (receiver) connected via the OPTICAL OUT jack, set "Dolby Digital" in "Audio Setup" to "Downmix PCM" (page 36).
- If "DTS" in "Audio Setup" is set to "Off" (page 36), the player does not output the DTS signal from the OPTICAL OUT jack even when the disc contains a DTS track.

Displaying the subtitles DVDVideo

DVD

If subtitles are recorded on the disc, you can change the subtitles or turn them on and off whenever you want while playing a DVD.

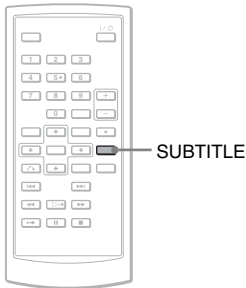

1 Press SUBTITLE repeatedly to select a setting.

Depending on the disc, the choice of language varies.

Changing the angles DVDVideo

If various angles (multi-angles) for a scene are recorded on the DVD VIDEO, "⏏" appears on the screen. This means that you can change the viewing angle.

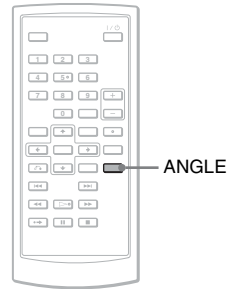

1 Press ANGLE repeatedly to select an angle number.

The scene changes to the selected angle.

To turn off the subtitles

Select "Subtitle Off" in step 1.

Hint

You can switch the subtitles in the Playback Settings Display while playing a DVD (page 21).

Notes

- Depending on the DVD VIDEO, you may not be able to change the subtitles even if multilingual subtitles are recorded on it. You also may not be able to turn them off.
- While you play a disc with subtitles, the subtitle may disappear when you press **▶▶**.

Notes

- Some DVD VIDEOS prohibit changing angles even when multi-angles are recorded.
- You cannot change angles during Slow Play or Scan Play.
- "⏏" (angle mark) does not appear when "Angle Mark" in "General Setup" is set to "Off" (page 35).

Selecting “Original” or “Play List” on a DVD-RW/DVD-R DVD VR

Some DVD-RWs/DVD-Rs in VR (Video Recording) mode have two types of title for playback: originally recorded titles (Original), and titles that can be created on recordable DVD players for editing (Play List). You can select the type of title to be played.

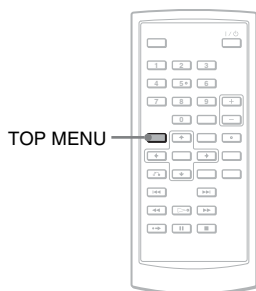

1 Press TOP MENU when the player is in stop mode.

The current mode appears. The TOP MENU button does not work when Resume Play is activated. Cancel the Resume Play status first by pressing **■** twice, and then press TOP MENU.

2 Switch the mode by pressing TOP MENU repeatedly.

Hint

You can check the current mode by pressing DISPLAY during playback. On the Playback Settings Display (page 21), “PL” or “ORG” will be displayed next to the title number.

Notes

- When a disc containing a Playlist title is inserted, the player automatically starts playing the Playlist title.
- When no Playlist title is recorded, “ORG” appears in step 1. When you press TOP MENU once more, “” appears.

Playing VIDEO CDs With PBC Functions (PBC Playback) VCD

Some VIDEO CDs have Playback Control (PBC) functions allowing for interactive search or playback options.

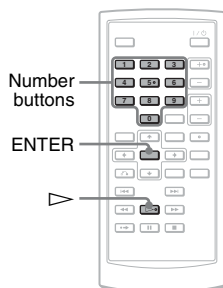

1 Start playing a VIDEO CD with PBC functions.

The menu appears for your selection.

2 Press the number buttons to select the item number you want and press ENTER.

3 Follow the instructions on screen for interactive operations.

Refer to the instructions supplied with the disc, as the operating procedure may differ depending on the VIDEO CD.

Hint

To cancel the PBC function, set “PBC” to “Off” in “General Setup” (page 35) and then, open and close the disc lid.

Note

Depending on the VIDEO CD, “Press ENTER” in step 2 may appear as “Press SELECT.” In this case, press .

Using the Playback Settings Display

DVDVideo DVDVR

While playing a DVD, you can check the current playback settings on the screen. The Playback Settings Display also allows you to change sound, subtitle, and angle or search for a title or track by inputting numbers.

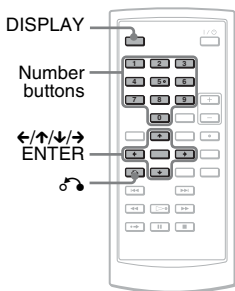

1 Press DISPLAY while playing a DVD.

The Playback Settings Display appears. Example: When playing a DVD VIDEO

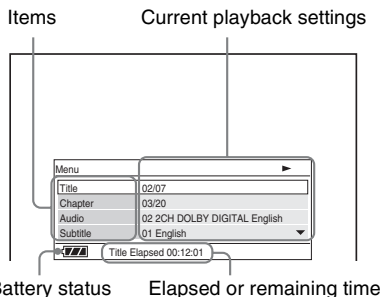

The corresponding icon for Play, Pause, Search, or Slow Play is displayed in the upper right corner of the screen.

When a DVD-RW/DVD-R (VR mode) is played, "PL" or "ORG" is displayed next to the title number.

2 Press ↑/↓ to select the desired item and press ENTER.

- Title
- Chapter

- Audio
- Subtitle
- Angle
- T.Time
- C.Time
- Repeat
- Time Disp.

3 Press ↑/↓ to select the setting, and press ENTER.

To enter numbers, use the number buttons or ↑/↓.

Note

Depending on the disc, you may not be able to set some options.

To turn off the display

Press DISPLAY or RETURN.

Searching for a title/chapter, etc. DVDVideo DVDVR

By entering the number or the time code, you can search a DVD by title or chapter.

1 Press ↑/↓ to select the search method on the Playback Settings Display, and press ENTER.

- Title
- Chapter
- T.Time*
- C.Time*

* You can search the title or chapter of a DVD VIDEO by entering the time code.

2 Press the number buttons or ↑/↓ to select the title or chapter number, and press ENTER.

The player starts playback from the selected number.

When you select "T.Time" or "C.Time" in step 1, "00:00:00" will appear on the screen. Enter the desired time code using the number buttons, and press ENTER. Playback starts from the entered time code. Elapsed or remaining time appears on the footer of the Playback Settings Display.

Hints

- You can use direct search without displaying the control menu. See page 23 for details.

- See page 23 for details about using direct search for a CD or VIDEO CD.

Notes

- The displayed title/chapter number is the same as the number recorded on the disc.
- Chapter times are not displayed when a DVD-RW/DVD-R (VR mode) is played. Chapter time will be displayed as "--:--:--."
- Depending on the disc, you may not be able to use the time code.

Playing a DVD VIDEO repeatedly (Repeat Play) DVDVideo

You can play all of the titles on a DVD VIDEO, or a single title or chapter repeatedly.

- 1 Select "Repeat" on the Playback Settings Display, and press ENTER.**
- 2 Press \uparrow/\downarrow to select the setting, and press ENTER.**
 - \leftarrow Chapter: repeats the current chapter.
 - \rightarrow Title: repeats the current title.
 - \leftarrow All: repeats all of the titles.

To return to normal play

Select "Off" in step 2.

Hint

When playing a VCD or CD repeatedly, use OPTIONS (page 24).

Note

Depending on the disc, the Repeat function may not be available.

Checking the playing time and remaining time DVDVideo DVDVR

You can check the playing time and remaining time of the current title or chapter.

- 1 Select "Time Disp." on the Playback Settings Display, and press ENTER.**

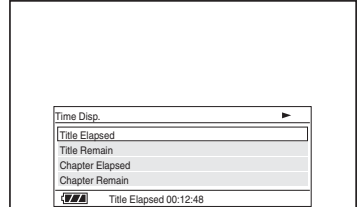

- 2 Press \uparrow/\downarrow to select the time information setting, and press ENTER.**
 - Title Elapsed
 - Title Remain
 - Chapter Elapsed
 - Chapter Remain

Hint

See page 25 for details about displaying the elapsed time of a CD or VIDEO CD.

Notes

- In the case of DVD-RWs/DVD-Rs (VR mode), the playing time and remaining time of the chapter is not displayed.
- The default setting for "Time Disp." is "Title Elapsed." After selecting an other option of "Time Disp." and exiting from the Playback Settings Display, the "Title Elapsed" appears when the Playback Settings Display is re-entered.

Searching for a Particular Point on a Disc (Search, Scan, Slow Play, Repeat Play, Random Play)

You can quickly locate a particular point on a disc by monitoring the picture or playing back slowly.

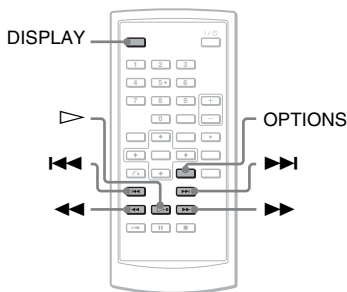

Notes

- Depending on the disc, you may not be able to perform some of the operations described.
- For DATA CDs/DATA DVDs, you can search for a particular point only on an MP3 audio track.

Locating a point quickly using the **PREV (previous)/NEXT** buttons (Search)

DVDVideo DVDVr VCD CD DATA CD DATA DVD
USB

During playback, press **▶▶▶** or **◀◀◀** to go to the next or previous chapter/track/scene.

Hints

When you know the title or chapter number, you can search directly by entering these numbers using the number buttons.

- While playing a DVD VIDEO, you can search for a title or chapter using the number buttons and ENTER. Press **↔** to switch between title and chapter.
- While playing CDs/VIDEO CDs, you can search for a track using the number buttons and ENTER.

Locating a point quickly by playing a disc in fast forward or fast reverse (Scan)

DVDVideo DVDVr VCD CD DATA CD DATA DVD
USB

Press **◀◀** or **▶▶** to fast reverse or fast forward during playback. To return to normal play, press **▷**.

Each time you press **◀◀** or **▶▶** during scan, the scan speed changes.

With each press the indication changes as shown below.

◆ Playback direction

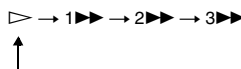

◆ Opposite direction

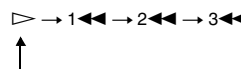

The “3▶▶▶”/“3◀◀◀” playback speed is faster than “2▶▶▶”/“2◀◀◀” and the “2▶▶▶”/“2◀◀◀” playback speed is faster than “1▶▶▶”/“1◀◀◀.”

💡 Hint

↔ on the player works the same as **◀◀/▶▶** on the remote, and ENTER on the player works the same as **▷** on the remote. This function is effective when you play back a DVD.

Notes

- No sound is output during Scan play for a DVD or VIDEO CD.
- Scan speed differs depending on the disc type.

Watching frame by frame (Slow Play)

DVDVideo DVDVr VCD

Press ◀◀ or ▶▶ when the player is in pause mode. To return to normal speed, press ▷. Each time you press ◀◀ or ▶▶ during Slow Play, the playback speed changes. With each press the indication changes as follows:

◆ Playback direction

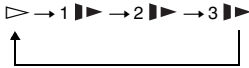

◆ Opposite direction (DVD only)

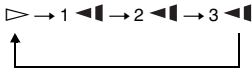

The “3▶▶”/“3◀◀” playback speed is slower than “2▶▶”/“2◀◀” and the “2▶▶”/“2◀◀” playback speed is slower than “1▶▶”/“1◀◀.”

Note

Slow speed differs depending on the disc type.

Playing CD/VIDEO CD repeatedly or in random order (Repeat Play, Random Play) VCD CD

You can play all of the tracks on a disc, or a single track repeatedly (Repeat Play). Also, you can play the tracks in random order, too (Random Play).

1 Press **OPTIONS** repeatedly during playback to select the playback mode.

- Track: repeats the current track.
- All: repeats all tracks on the disc.
- Random: plays all tracks on the disc randomly.

To return to normal play

Select “ Off” in step 1.

Hint

During Random Play, you can start playing other randomly selected track by pressing ▶▶.

Notes

- You cannot use Repeat Play and Random Play with VIDEO CDs or Super VCDs with PBC playback.
- Depending on the disc, Random Play may not be available.
- The same track may be repeated several times in Random Play.

Checking the play information of the disc

DVDVideo **DVDVr** **VCD** **CD**

When playing a DVD

Press DISPLAY while playing a DVD, and then use the Playback Settings Display (page 21).

When playing a CD

Press DISPLAY.

The playing track number/the total number of tracks and the elapsed time of the current track appear. Press DISPLAY repeatedly to switch the time information as below.

- Track Elapsed
- Track Remain
- Disc Elapsed
- Disc Remain

When playing a VIDEO CD

Press DISPLAY.

The player displays "PBC On" (when you set "PBC" to "Off," the player displays the playing track number/the total number of tracks), the elapsed time, and the audio mode on the screen.

Note

The player does not display "Disc Elapsed" or "Disc Remain" on the screen when playing a CD in Random Play.

Playing MP3 Audio Tracks or JPEG Image Files

DATA CD **DATA DVD** **USB**

You can play MP3 audio tracks and JPEG image files on DATA CDs (CD-ROMs/CD-Rs/CD-RWs) or DATA DVDs (DVD-ROMs/DVD+RWs/DVD+Rs/DVD-RWs/DVD-Rs) or USB devices.

For playable MP3 audio files and JPEG image files, see page 44.

When you insert DATA CDs and DATA DVDs, the list of albums appears.

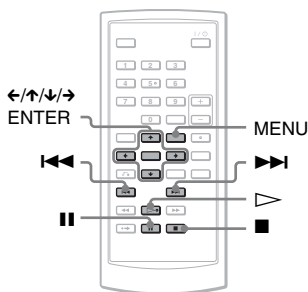

To play back data on a USB device

- 1 Set the CD/DVD USB switch on the player's left side to "USB."
- 2 Connect the USB device to the USB jack on the player's left side.

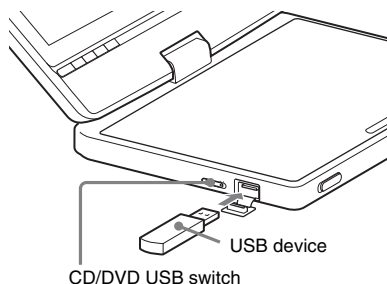

To disconnect a USB device

- 1 Set the CD/DVD USB switch to "CD/DVD."
- 2 Disconnect a USB device.

Compatible Sony USB devices

JPEG and MP3 file playback via USB port is confirmed with Sony's USB Memory Stick Reader/Writer and USB Flash drive "Pocket Bit." (Confirmed device: MSAC-US40, USM-EX series, USM-J series, USM-JX series, USM-H series)

Notes

- Do not disconnect the USB device while its access indicator is flashing. Doing so may cause data corruption or loss of data.
- The access indicator on some USB devices may keep flashing even after the data is transferred.
- USB devices which can connect to the player are flash memory and multiple card reader. Other devices (digital still camera, USB hub, etc.) cannot be connected. When an incompatible device is connected, "Cannot recognise the connected device." appears indicating that the device is unrecognizable.
- DATA CDs recorded in KODAK Picture CD format automatically start playing when inserted.

Playing an MP3 audio track

- 1 Press \uparrow/\downarrow to select an album on the list, and press ENTER.**

The list of tracks in the album appears.

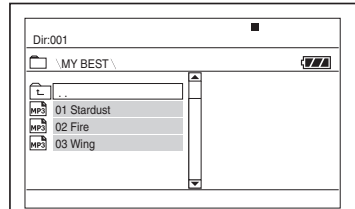

- To go to the next or previous page, press $\blacktriangleright\blacktriangleright$ or $\blacktriangleleft\blacktriangleleft$.
- To return to the list of albums, press \uparrow/\downarrow to select \square and press ENTER.

- 2 Press \uparrow/\downarrow to select the track you want to play, and press ENTER.**

Playback starts from the selected track.

To go to the next or previous MP3 audio track

Press $\blacktriangleright\blacktriangleright$ or $\blacktriangleleft\blacktriangleleft$.

To stop playback

Press \blacksquare .

Notes

- The total albums and files the player can recognize is about 648.
- The number of albums in a disc the player can recognize is about 299.

Playing a JPEG image file

1 Press \uparrow/\downarrow to select an album on the list, and press ENTER.

The list of files in the album appears.

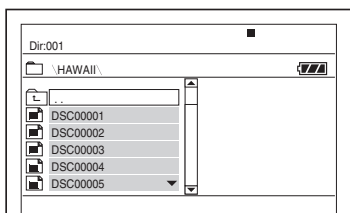

- To go to the next or previous page, press \blacktriangleright or \blacktriangleleft .
- To return to the list of albums, press \uparrow/\downarrow to select \square and press ENTER.

2 Press \uparrow/\downarrow to select the image you want to view, and press ENTER.

The selected image appears.

Example:

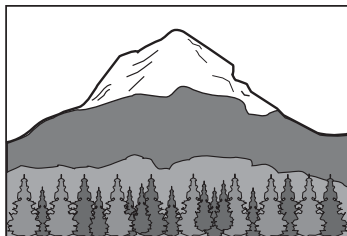

To display the list of thumbnails

Press MENU when a file is displayed on the screen.

The image files in the album appear in 12 subscreens with the displayed file in the lead.

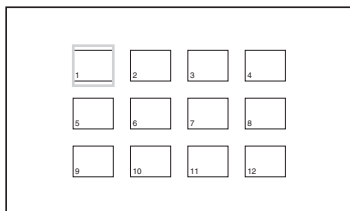

- To move to the previous or next page of the thumbnail list display, select “◀Prev” or “Next▶” under the screen.

- To exit the list of thumbnails, press MENU.

To go to the next or previous JPEG image file

Press \blacktriangleright or \blacktriangleleft .

To rotate a JPEG image

Press $\leftarrow/\uparrow/\downarrow/\rightarrow$ while viewing the image.

- \uparrow : Reverses the image vertically (up and down).
- \downarrow : Reverses the image horizontally (left and right).
- \rightarrow : Rotates the image 90 degrees clockwise.
- \leftarrow : Rotates the image 90 degrees counter clockwise.

Note that the view also returns to normal if you press $\blacktriangleleft/\blacktriangleright$ to go to the next or previous image.

Example: when \leftarrow is pressed once.

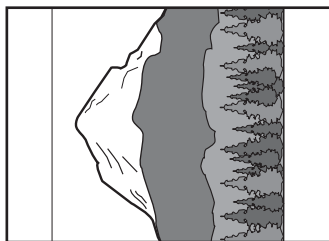

To stop viewing the JPEG image

Press \blacksquare .

The display returns to the list of files.

Notes

- Images may take time to appear due to the number of recorded files or the size of the folders. If no image appears after a few minutes, some of the files included may be too large.
- Some JPEG files, especially progressive JPEG files or JPEG files of 3,000,000 pixels or more, may take longer to display than others.
- The player cannot play the JPEG image file that is larger than 3078 (width) x 2048 (height) in normal mode, or more than 3,300,000 pixels in progressive JPEG. (Some progressive JPEG files cannot be displayed even if the size is within this specified capacity.)
- The total albums and files the player can recognize is about 648.
- The number of albums in a disc the player can recognize is about 299.

Enjoying JPEG Images as a Slide Show

You can play JPEG image files on a DATA CD or DATA DVD successively as a slide show.

1 While displaying the file you want to start a slideshow, press MENU.

The list of thumbnails appears.

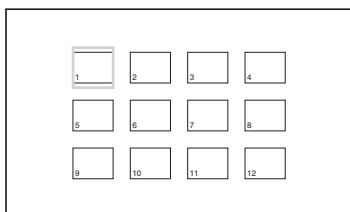

2 Press ←/↑/↓/→ to select “Slide Show” at the bottom of the screen, and press ENTER.

A slideshow starts from the displayed file.

To pause slideshow

Press ■. By pressing ■ again or ▷, you can return to slideshow.

To stop slideshow

Press ■ or MENU.

Adjusting the Picture Size and Quality

DVD Video DVD VR VCD DATA CD

DATA DVD USB

You can adjust the picture displayed on the LCD screen. See “General Setup” (page 34), when outputting the video signal to TV, etc.

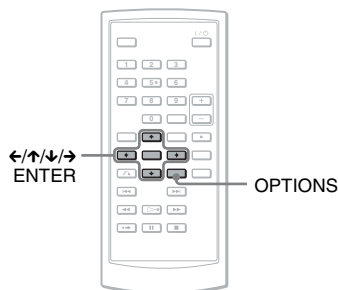

1 Press OPTIONS.

The Option Menu appears.

2 Press ↑/↓ to select “LCD Mode” and press ENTER.

The items for “LCD Mode” appear.

3 Press ↑/↓ to select items and press ENTER.

- LCD Aspect: Change the picture size. Select “Normal” or “Full” by pressing ↑/↓*.
- Backlight: Adjust the brightness of the LCD screen by pressing ←/→.
- Contrast: Adjust the difference between light and dark areas by pressing ←/→.
- Hue: Adjust the red and green colour balance by pressing ←/→.
- Color: Adjust the richness of colours by pressing ←/→.
- Default: Returns all settings to the factory defaults.

* In “Normal,” the pictures are displayed in the original configuration, retaining the aspect ratio. For example, a 4:3 picture will have black bands on both sides, and the letterbox pictures recorded either in 16:9 or 4:3 will have black bands on all

sides. In "Full," a 16:9 picture will be adjusted to fill the entire screen.

To turn off the Option Menu

Press **OPTIONS** or  **RETURN**.

Hints

- The screen turns off automatically when the LCD panel is closed.
- You can see the settings for the display in "General Setup" (page 34).

Notes

- The screen size you can select differs depending on the DVD.
- You cannot select "Normal" for a DVD recorded in "16:9."
- You cannot adjust the picture size and quality when playing a VIDEO CD with "PBC" set to "Off."

Playing DivX Video Files

DATA CD DATA DVD

You can play DivX video files on DATA CDs (CD-ROMs/CD-Rs/CD-RWs) and DATA DVDs (DVD-ROMs/DVD+RWs/DVD+Rs/DVD-RWs/DVD-Rs).

When you insert DATA CDs and DATA DVDs, the list of albums appears.

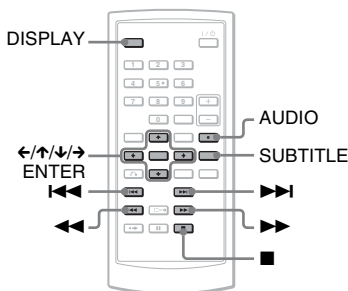

Notes

- When the selected file is not supported, “Data Error (DivX)” displays on the screen and the file will not be played.
- Depending on the DivX video file, the picture may pause or be unclear. In which case, it is recommended that you create the file at a lower bit rate. If the sound is still noisy, MP3 is the recommended audio format. Note, however, this player does not conform to WMA (Windows Media Audio) format.
- Because of the compression technology used for DivX video files, it may take some time after you press ▷ (play) for the picture to appear.
- Depending on the DivX video file, the sound may not match the pictures on the screen.
- The player’s speaker does not output DTS sound. When you play DTS sound tracks on a DivX video file, connect the player to an AV amplifier (receiver) (page 40) and set up “DTS” in “Audio Setup” (page 36).
- Depending on the DivX video file, you may not be able to perform some operations.

Playing a DivX video file

- 1 Press ↑/↓ to select an album on the list, and press ENTER.

A list of files in the album appears.

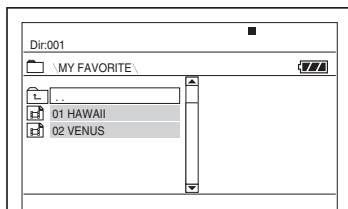

- To go to the next or previous page, press ►► or ◀◀.
- To return to the list of albums, press ↑/↓ to select ◀ and press ENTER.

- 2 Press ↑/↓ to select the file you want to play, and press ENTER.

Playback starts from the selected file.

To go to the next or previous DivX video file

Press ►► or ◀◀.

To locate a point quickly by playing DivX video files in fast forward or fast reverse (Scan)

Press ►►/◀◀ repeatedly to select the required speed for the search mode during playback.

To watch frame by frame (Slow Play)

Press ►► repeatedly in pause mode to select the required slow motion speed.

To display the playback information

Press DISPLAY repeatedly.

The playback information changes as follow order, “Title Elapsed,” “Title Remain,” “Display Off,” and “Subtitle.”

To change the sound

Press AUDIO repeatedly during playback to select the desired audio signal. If “No Audio” appears, the player does not support the audio signal format contained in the disc.

To change the subtitles

Press SUBTITLE during playback.
Press **↑/↓**, and ENTER during displaying the subtitle information.

To stop playback

Press **■**.

Hint

If the number of viewing times is preset, you can play the DivX video files as many times as the preset number. The following occurrences are counted:

- when the player is turned off. This includes when the player is automatically turned off by the Auto Power Off function. Press **||** instead of **■** to stop viewing.
- when the disc lid is opened.
- when another file is played.

Note

The slow reverse function is prohibited.

About DivX Video Files

DivX[®] is a video file compression technology, developed by DivX, Inc. This product is an official DivX[®] Certified product.

You can play DATA CDs and DATA DVDs that contain DivX video files.

DATA CDs and DATA DVDs that the player can play

This player only plays DATA CDs whose logical format is ISO 9660 Level 1 or Joliet, and DATA DVDs of Universal Disk Format (UDF).

Refer to the instructions supplied with the disc drives and the recording software (not supplied) for details on the recording format.

Note

The player may not be able to play some DATA CDs/DATA DVDs created in the Packet Write format or multiple sessions.

DivX video files that the player can play

The player can play data that is recorded in DivX format, and which has the extension “.AVI,” or “.DIVX.” The player will not play files with the extension “.AVI” or “.DIVX” if they do not contain a DivX video.

Notes

- The player may not play a DivX video file when the file consists of two or more DivX video files combined.
- The player cannot play a DivX video file of size more than 720 (width) × 576 (height)/2 GB.
- Depending on the DivX video file, the picture may be unclear or the sound may skip.
- The player cannot play some DivX video files that are longer than 3 hours.
- The player can display a file name up to 14 characters. Any characters after the 14th character do not appear on the screen.
- Characters that are not displayable appear as “*.”
- Depending on the disc, a file name that is not displayable appears as “*.”
- You cannot display correctly the CD-R/CD-RW file names written in the UDF file system.

About playback order of DivX video files

Note that the playback order may not be applicable, depending on the software used for creating the DivX video file, or if there are more than 299 albums and 648 DivX video files in each album. See “About playback order of albums, tracks, and files” (page 45).

Using the Setup Display

By using the Setup Display, you can make various adjustments to items such as picture and sound. You can also set a language for the subtitles and the Setup Display, among other things.

For details on each Setup Display item, see pages from 34 to 38.

Note

Playback settings stored in the disc take priority over the Setup Display settings, and not all of the functions described may work.

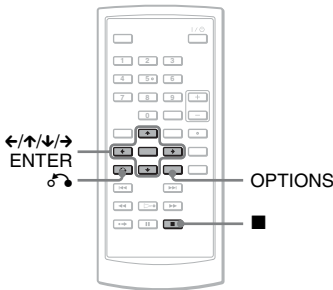

1 Press **OPTIONS** when the player is in stop mode.

The Option Menu appears.

The Setup Display does not appear if Resume Play is activated. Cancel the Resume Play status first by pressing ■ twice, and then press **OPTIONS**.

2 Press **↑/↓** to select “Setup,” then press **ENTER**.

The items for “Setup” appear.

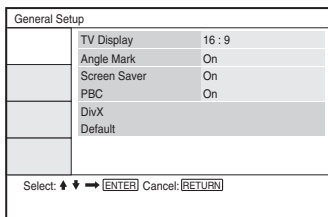

3 Press **↑/↓** to select the desired Setup item from: “General Setup,” “Audio Setup,” “Language Setup,” or “Parental Control,” then press **ENTER**.

The Setup item is selected.

Example: “General Setup”

Selected item

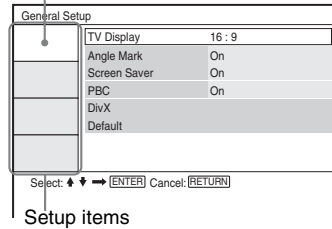

4 Press **↑/↓** to select an item, then press **ENTER**.

The settings for the selected item appear.

Example: “TV Display”

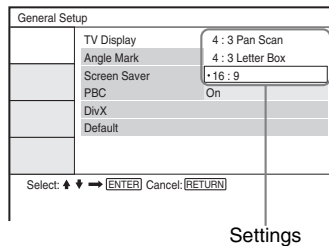

5 Press **↑/↓** to select a setting, then press **ENTER**.

The setting is selected and setup is complete.

Example: “4:3 Pan Scan”

Selected setting

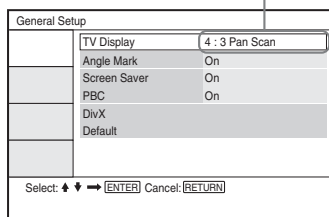

To turn off the Setup Display

Press **OPTIONS** or **RETURN** twice.

Settings for the Display

(General Setup)

Choose playback display options and settings according to the TV to be connected.

Select “General Setup” in the Setup Display. To use the display, see “Using the Setup Display” (page 33).

The default settings are underlined.

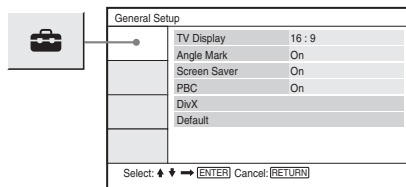

◆ TV Display (DVD only)

Selects the aspect ratio of the connected TV (4:3 standard or wide).

| | |
|-------------------|---|
| 4:3 Pan Scan | Select this when you connect a 4:3 screen TV. Automatically displays a wide picture on the entire screen and cuts off the portions that do not fit. |
| 4:3 Letter Box | Select this when you connect a 4:3 screen TV. Displays a wide picture with bands on the upper and lower portions of the screen. |
| <u>16:9</u> | Select this when you connect a wide-screen TV or a TV with a wide mode function. |

4:3 Pan Scan



4:3 Letter Box



16:9

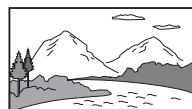

Note

Depending on the DVD, “4:3 Letter Box” may be selected automatically instead of “4:3 Pan Scan” or vice versa.

◆ Angle Mark

Displays the angle mark when you can change the viewing angles during playback of DVDs recorded with multi-angles.

| | |
|-----------|-------------------------|
| <u>On</u> | Display the angle mark. |
| Off | Hide the angle mark. |

◆ Screen Saver

The screen saver image appears when you leave the player in pause or stop mode for 15 minutes. The screen saver will help prevent your display device from becoming damaged (ghosting). Press \blacktriangleright to turn off the screen saver.

| | |
|-----------|--|
| <u>On</u> | Activates the screen saver function. |
| Off | Deactivates the screen saver function. |

◆ PBC

By using the PBC (Playback Control) function, you can enjoy playing interactive programmes and programmes with search functions (page 20). This set up is effective when you play back VIDEO CDs with the PBC function. Set up becomes available by opening and closing the disc lid after setting.

| | |
|-----------|---|
| <u>On</u> | By the PBC function, you can play back VIDEO CDs via the menu screen. |
| Off | Turn off the PBC function. |

◆ DivX

Displays the registration code for this player. For more information, go to <http://www.divx.com> on the Internet.

◆ Default

Each function returns to its original factory settings. Note that all of your settings will be lost.

Settings for the Sound

(Audio Setup)

“Audio Setup” allows you to set the sound according to the playback and connection conditions.

Select “Audio Setup” in the Setup Display. To use the display, see “Using the Setup Display” (page 33). The default settings are underlined.

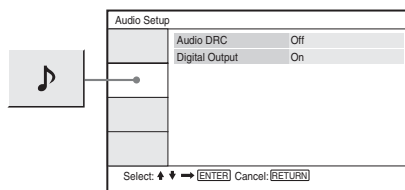

◆ Audio DRC (Dynamic Range Control) (DVD only)

Makes the sound clear when the volume is turned down when playing a DVD that conforms to “Audio DRC.”

This function affects the output from the following jacks:

- AUDIO jack
- OPTICAL OUT jack only when “Dolby Digital” is set to “Downmix PCM” (page 36).

| | |
|-----------|--|
| <u>On</u> | Makes low sounds clear even if you turn the volume down. |
| Off | Normally select this position. |

◆ Digital Output

Selects if audio signals are output via the OPTICAL OUT jack.

| | |
|-----------|--|
| <u>On</u> | Normally select this position. When you select “On,” see “Setting the digital output signal” for further settings. |
| Off | The influence of the digital circuit upon the analog circuit is minimal. |

Setting the digital output signal

Switches the method of outputting audio signals when you connect an audio equipment such as an AV amplifier (receiver) with the OPTICAL OUT jack.

For connection details, see page 39.

After setting "Digital Output" to "On," select "Dolby Digital" and "DTS."

If you connect a component that is incompatible with the selected audio signal, a loud noise (or no sound) may be heard from the speakers, damaging your ears or speakers.

◆ Dolby Digital (DVD only)

Selects the type of Dolby Digital signal.

| | |
|-----------------------|--|
| <u>Downmix</u> PCM | Select this when the player is connected to an audio component without a built-in Dolby Digital decoder. |
| Dolby Digital | Select this when the player is connected to an audio component with a built-in Dolby Digital decoder. |

◆ MPEG (DVD only)

Selects the type of MPEG audio signal.

| | |
|------------|--|
| <u>PCM</u> | Select this when the player is connected to an audio component without a built-in MPEG decoder. If you play multi-channel MPEG audio sound tracks, only the Front (L) and Front (R) signals will be output from your two front speakers. |
| MPEG | Select this when the player is connected to an audio component with a built-in MPEG decoder. |

◆ DTS

Selects whether or not to output DTS signals.

| | |
|------------|--|
| <u>On</u> | Select this when the player is connected to an audio component with a built-in DTS decoder. |
| <u>Off</u> | Select this when the player is connected to an audio component without a built-in DTS decoder. |

Setting the Display or Sound Track Language

(Language Setup)

"Language Setup" allows you to set various languages for the on-screen display or sound track.

Select "Language Setup" in the Setup Display. To use the display, see "Using the Setup Display" (page 33).

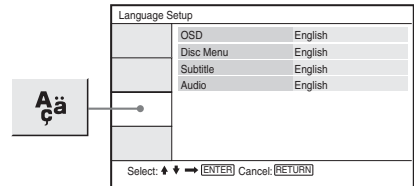

◆ OSD (On-Screen Display)

Switches the display language on the screen.

◆ Disc Menu (DVD VIDEO only)

Switches the language for the disc's menu.

When you select "Original," the language given priority in the disc is selected.

◆ Subtitle (DVD VIDEO only)

Switches the subtitle language.

When you select "Off," no subtitle is displayed.

◆ Audio (DVD VIDEO only)

Switches the language of the sound track.

When you select "Original," the language given priority in the disc is selected.

Note

If you select a language in "Disc Menu," "Subtitle," or "Audio" that is not recorded on the DVD VIDEO, one of the recorded languages will be automatically selected.

Parental Control Settings (Parental Control)

Playback of some DVD VIDEOS can be limited, by the parental control function.

Select "Parental Control" in the Setup Display. To use the display, see "Using the Setup Display" (page 33).

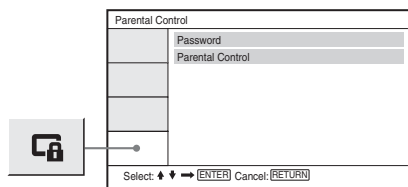

◆ Password

Enter or change a password. By setting a password, you can limit playback of a DVD that has the parental control function. When the Password option is first accessed, enter a new password (you do not need to enter the old password.).

◆ Parental Control

The lower the setting value, the stricter the limitation.

To set the parental control, you need the selected password in "Password," therefore first set the password in the set up.

Changing the password

- 1 Press **↑/↓** to select "Password" in the Parental Control setting display, and press **ENTER**.
- 2 Select "Change," and press **ENTER**. The display for entering the password appears.
- 3 Enter your current 6-digit password in the "Old Password" box.
- 4 Enter your new 6-digit password in the "New Password" box.
- 5 Enter your new 6-digit password once again in the "Verify Password" box, then press **ENTER** to confirm.

If you make a mistake entering your password

Press **CLEAR**, or press **←** to return one by one before pressing **ENTER** in step 5, and then re-enter the password.

Setting the parental control (limited playback) DVDVideo

- 1 Press **↑/↓** to select "Parental Control" in the Parental Control setting display, and press **ENTER**. The display for setting the playback limitation level appears.

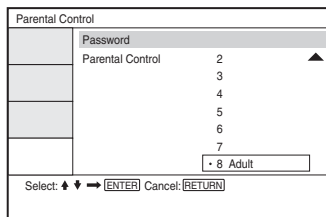

2 Press \uparrow/\downarrow to select the limitation level (1-8), and press ENTER.

The lower the value, the stricter the limitation.

The display for entering the password appears.

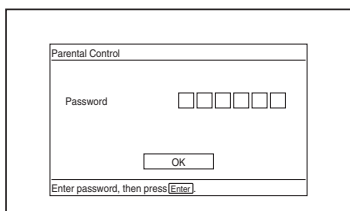

3 Enter or re-enter your 6-digit password using the number buttons, then press ENTER.

Parental Control setting is complete.

To play a disc for which Parental Control is set

- 1 Insert the disc and press \triangleright .
The display for entering your password appears.
- 2 Enter your 6-digit password using the number buttons, then press ENTER.
The player starts playback.

If you forget your password

Remove the disc and repeat the steps outlined in “Changing the password” (page 37). Enter “136900” in the “Old Password” box, and then enter your new 6-digit password in the “New Password” box and “Verify Password” box.

Notes

- When you play discs which do not have the Parental Control function, playback cannot be limited on this player.
- Depending on the disc, you may be asked to change the parental control level while playing the disc. In this case, enter your password, then change the level. If the Resume Play mode is cancelled, the level returns to the previous level.

Connecting to another device

To switch LINE SELECT (IN/OUT) switch

LINE SELECT IN: Input images or audio from an exterior device. The “Line in” message will be displayed on the LCD screen until the signal from the exterior device is received.

LINE SELECT OUT: Sends the playback signal from this player to a TV.

Notes

- Plug cords securely to prevent noise.
- Refer to the instructions supplied with the components to be connected.
- You cannot connect this player to a TV that does not have a video input jack.
- Be sure to disconnect the mains lead of each component before connecting.
- Connect the player to the TV directly. Image quality may suffer when the video output from the player is passed through a video deck on to a TV.

Connecting to TV monitor

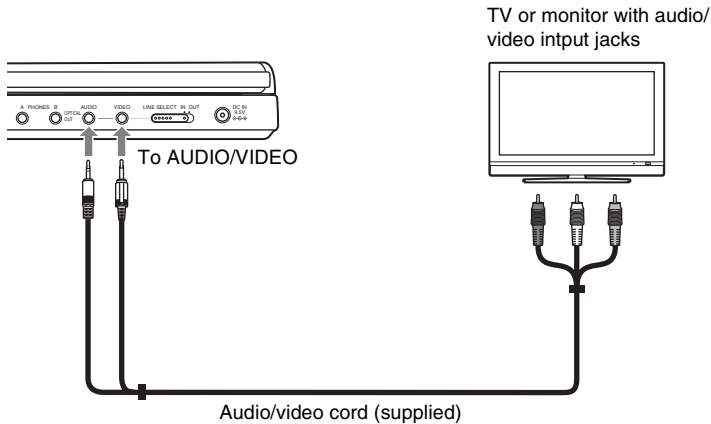

To send the playback signal to a TV or a monitor

- 1 Set the LINE SELECT switch on the player's right side to "OUT."

Connecting to an AV amplifier (receiver)

Example 1

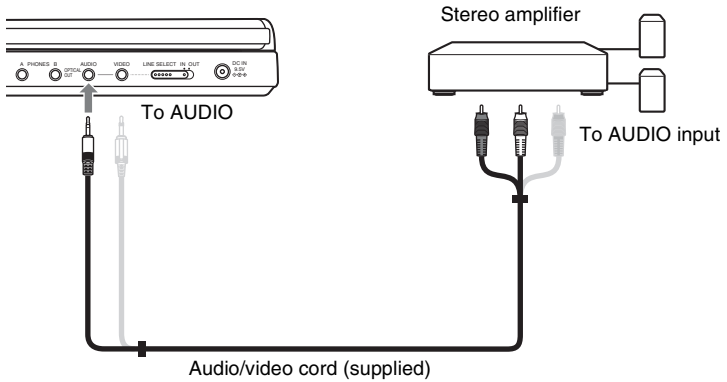

To send the playback signal to an AV amplifier (receiver)

1 Set the LINE SELECT switch on the player's right side to "OUT."

* The yellow plug is used for video signals (page 39).

Example 2

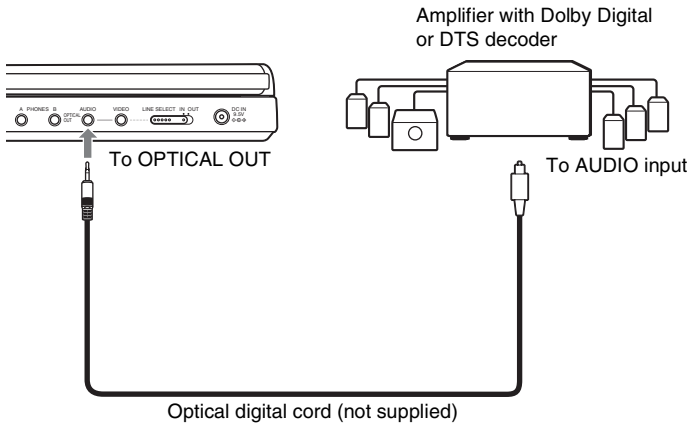

To send the playback signal to an AV amplifier (receiver)

1 Set the LINE SELECT switch on the player's right side to "OUT."

2 Set "Digital Output" to "On" in "Audio Setup" (page 35).

Connecting to Video Player or Camcorder

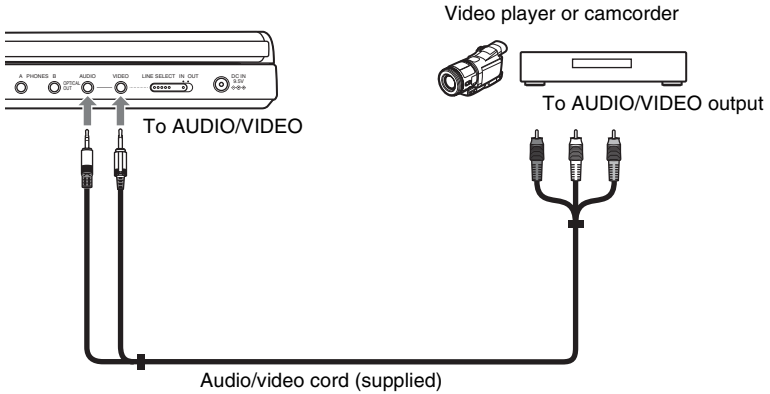

To receive the playback signal from a Video Player or Camcorder

- 1 Set the LINE SELECT switch on the player's right side to "IN."

Note

Set the LINE SELECT switch to "OUT" after use. You cannot play back on the player if the switch is set to "IN."

Troubleshooting

If you experience any of the following difficulties while using the player, use this troubleshooting guide to help remedy the problem before requesting repairs. Should any problem persist, consult your nearest Sony dealer.

Power

The power is not turned on.

- ➔ Check that the mains lead is connected securely.
- ➔ When using with the battery pack, check that the battery pack is sufficiently charged.

Picture

There is no picture/picture noise appears.

- ➔ The disc is dirty or flawed.
- ➔ The brightness is set at minimum. Set the brightness in "LCD Mode" (page 28).
- ➔ When you play discs, set the LINE SELECT switch to "OUT." When you send the playback signal to other device, set the LINE SELECT switch to "OUT." When you receive the playback signal from other device, set the LINE SELECT switch to "IN" (page 39).
- ➔ Re-connect the connecting cord securely.
- ➔ The connecting cords are damaged.
- ➔ Check the connection to your TV (page 39) and switch the input selector on your TV so that the signal from the player appears on the TV screen.
- ➔ The player is connected to the COMPONENT VIDEO IN (Y, Pb, Pr) jacks of high-vision TV.
- ➔ If the picture output from your player goes through your video deck to get to your TV or if you are connected to a combination TV/VIDEO player, the copy-protection signal applied to some DVD programmes could affect picture quality.

The picture does not fill the screen, even though the aspect ratio is set in "TV Display" under "General Setup."

- ➔ The aspect ratio of the disc is fixed on your DVD.

The black points appear and the red, blue, green points remain on the LCD.

- ➔ This is a structural property of the LCD and not malfunction.

Sound

There is no sound.

- ➔ The player is in pause mode or in Slow Play mode.
- ➔ The player is in fast forward or fast reverse mode.
- ➔ While playing a Super VCD on which the audio track 2 is not recorded, no sound will come out when you select "Stereo 1," "Left 1," or "Right 1."
- ➔ Re-connect the connecting cord securely.
- ➔ The connecting cord is damaged.
- ➔ The player is connected to the wrong input jack on the amplifier (receiver) (page 40).
- ➔ The amplifier (receiver) input is not correctly set.
- ➔ If the audio signal does not come through the OPTICAL OUT jack, check the audio settings (page 36).

The sound volume is low.

- ➔ The sound volume is low on some DVDs. The sound volume may improve if you set "Audio DRC" in "Audio Setup" to "On" (page 35).

Operation

The remote does not function.

- ➔ The batteries in the remote are weak.
- ➔ There are obstacles between the remote and the player.
- ➔ The distance between the remote and the player is too far.
- ➔ The remote is not pointed at the remote sensor on the player.
- ➔ Direct sunlight or strong illumination is striking the remote sensor.

Nothing happens when buttons are pressed.

- ➔ The player's I/O /HOLD switch is set on "HOLD" (page 16).

The disc does not play.

- ➔ The disc is turned over.
Insert the disc with the playback side facing down.
- ➔ The disc is not set correctly.
- ➔ The player cannot play certain discs (page 7).
- ➔ The region code on the DVD does not match the player (page 8).
- ➔ Moisture has condensed inside the player (page 3).
- ➔ The player cannot play a recorded disc that is not correctly finalized (page 7).
- ➔ Parental Control has been set. Change the setting.
- ➔ The CD/DVD USB switch on the player's left side is set to "USB."
- ➔ The LINE SELECT switch on the player's right side is set to "IN."

The player starts playing the disc automatically.

- ➔ The disc features an auto playback function.

Playback stops automatically.

- ➔ While playing discs with an auto pause signal, the player stops playback at the auto pause signal.

Some functions such as Stop, Search, Scan, Slow Play, Repeat Play, or Random Play cannot be performed.

- ➔ Depending on the disc, you may not be able to do some of the operations above. Refer to the operating instructions supplied with the disc.

The language for the sound track cannot be changed.

- ➔ Try using the DVD's menu instead of the direct selection button on the remote (page 17).
- ➔ Multilingual tracks are not recorded on the DVD being played.
- ➔ The DVD prohibits the changing of the language for the sound track.

The subtitle language cannot be changed or turned off.

- ➔ Try using the DVD's menu instead of the direct selection button on the remote (page 17).
- ➔ Multilingual subtitles are not recorded on the DVD being played.
- ➔ The DVD prohibits the changing of subtitles.

The angles cannot be changed.

- ➔ Try using the DVD's menu instead of the direct selection button on the remote (page 17).
- ➔ Multi-angles are not recorded on the DVD being played.
- ➔ The angle can only be changed when the "⏏" indicator lights up on the screen (page 19).
- ➔ The DVD prohibits changing of the angles.

The MP3 audio track cannot be played (page 44).

- ➔ The DATA CD is not recorded in an MP3 format that conforms to ISO 9660 Level 1 or Joliet.
- ➔ The DATA DVD is not recorded in MP3 format that conforms to UDF (Universal Disk Format).
- ➔ The MP3 audio track does not have the extension ".MP3."
- ➔ The data is not formatted in MP3 even though it has the extension ".MP3."
- ➔ The data is not MPEG-1 Audio Layer III data.
- ➔ The player cannot play audio tracks in mp3PRO format.
- ➔ The MP3 audio track is damaged.

The JPEG image file cannot be played (page 44).

- ➔ The DATA CD is not recorded in a JPEG format that conforms to ISO 9660 Level 1 or Joliet.
- ➔ The DATA DVD is not recorded in JPEG format that conforms to UDF (Universal Disk Format).
- ➔ The JPEG image file does not have the extension “.JPEG.”
- ➔ The data is not formatted in JPEG even though it has the extension “.JPEG.”
- ➔ The JPEG image file format does not conform to DCF (page 44).
- ➔ The image is larger than 3078 (width) × 2048 (height) in normal mode, or more than 3,300,000 pixels in progressive JPEG. (Some progressive JPEG files cannot be displayed even if the file size is within this specified capacity.)
- ➔ The JPEG image file is damaged.

The DivX video file cannot be played.

- ➔ The file is not created in DivX format.
- ➔ The file has an extension other than “.AVI” or “.DIVX.”
- ➔ The DATA CD (DivX video)/DATA DVD (DivX video) is not created in a DivX format that conforms to ISO 9660 Level 1 or Joliet/UDF.
- ➔ The DivX video file is larger than 720 (width) × 576 (height).

The album/track/file names are not displayed correctly.

- ➔ The player can only display numbers and alphabet. Other characters are displayed as “*.”

The disc does not start playing from the beginning.

- ➔ Repeat Play or Random Play is selected (pages 22 and 24).
- ➔ Resume play has taken effect (page 17).

The player does not operate properly.

- ➔ When static electricity, etc., causes the player to operate abnormally, unplug the player.

About MP3 Audio Tracks and JPEG Image Files

MP3 is audio compression technology that satisfies the ISO/IEC MPEG regulations. JPEG is image compression technology. You can play DATA CDs/DATA DVDs that contain MP3 audio tracks or JPEG image files.

DATA CDs/DATA DVDs that the player can play

You can play back DATA CDs (CD-ROMs/CD-Rs/CD-RWs) or DATA DVDs (DVD-ROMs/DVD+RWs/DVD+Rs/DVD-RWs/DVD-Rs) recorded in MP3 (MPEG-1 Audio Layer III) and JPEG format.

However, this player only plays DATA CDs whose logical format is ISO 9660 Level 1 or Joliet, and DATA DVDs of Universal Disk Format (UDF).

Refer to the instructions supplied with the disc drives and the recording software (not supplied) for details on the recording format.

Note

The player may not be able to play some DATA CDs/DATA DVDs created in the Packet Write format or multiple sessions.

MP3 audio track or JPEG image file that the player can play

The player can play the following tracks and files:

- MP3 audio tracks with the extension “.MP3.”
- JPEG image files with the extension “.JPEG” or “.JPG.”
- JPEG image files that conform to the DCF* image file format.

* “Design rule for Camera File system”: Image standards for digital cameras regulated by JEITA (Japan Electronics and Information Technology Industries Association).

Notes

- Change the extension to “.JPG,” for files with “.JPE” or “.JPEG” extension.
- The player will play any data with the extension “.MP3,” “.JPG,” or “.JPEG,” even if they are not in MP3 or JPEG format. Playing this data may generate a loud noise which could damage your speaker system.
- The player does not conform to audio tracks in mp3PRO format.
- Some JPEG files cannot be played.
- The player can display a file or track name up to 14 characters. Any characters after the 14th character do not appear on the screen.
- Characters that are not displayable appear as “*.”
- Depending on the disc, a file or track name that is not displayable appears as “*.”
- You cannot display correctly the CD-R/CD-RW file names written in the UDF file system.
- When playing an MP3 audio track recorded in VBR mode, you cannot display the bit rate correctly.

About playback order of albums, tracks, and files

Tracks and files within an album play in the order of the recorded media (CD-R etc.).

Hint

Since a disc with many trees takes longer to start playback, it is recommended that you create albums with no more than two trees.

Notes

- The player can recognize up to 299 albums (including albums that do not contain MP3 audio tracks and JPEG image files). The player will not play any albums beyond the 299th album.
- The player can recognize a combined total of up to 648 files, tracks, and albums. The player will not play beyond the 648th file, track or album.
- Depending on the writing condition of the disc, the total number of files, tracks, and albums recognizable may be fewer than 648.
- The Album List displays only the currently playing album name. Any album located on the upper layer is displayed as “\.\.”

Specifications

System

Laser: Semiconductor laser

Signal format system: PAL (NTSC)

Audio characteristics

Frequency response: DVD VIDEO (PCM

48 kHz): 20 Hz to 22 kHz/
CD: 20 Hz to 20 kHz

Harmonic distortion: 0.01 %

Dynamic range: DVD VIDEO: 90 dB/
CD: 90 dB

Wow and flutter: Less than detected value
($\pm 0.001\%$ W PEAK)

Inputs/Outputs

VIDEO (video input/output):

Minijack (1)

Output 1.0 V_{p-p}/75 ohms

AUDIO (audio input/output)/OPTICAL

OUT (optical output):

Stereo minijack/optical minijack
combined (1)

Output 2.0 V_{rms}/47 kilohms

Recommended load impedance over
47 kilohms

PHONES (headphones) A/B:

Stereo minijack (2)

Liquid Crystal Display

Panel size: 8 inches wide (diagonal)

Driving system: TFT active matrix

Resolution: 800 × 480 (effective pixel rate:
more than 99.99%)

General

Power requirements:

DC 9.5 V (AC Adaptor/Car battery
adaptor)

DC 7.4 V (Battery pack)

Power consumption (DVD VIDEO

Playback):

23 W (when used with a battery pack)

8.5 W (when used without a battery pack,
with a headphone)

Dimensions (approx.):

226.2 × 32.3 × 165.3 mm (width/height/
depth) incl. projecting parts

Mass (approx.): 1.045 kg

Operating temperature: 5 °C to 35 °C

Operating humidity: 25 % to 80 %

AC Adaptor: 100-240 V AC, 50/60 Hz

Car Battery Adaptor: 12 V DC

Supplied accessories

See page 9.

Specifications and design are subject to
change without notice.

The manufacturer of this product is Sony Corporation, 1-7-1 Konan Minato-ku Tokyo, 108-0075 Japan. The Authorized Representative for EMC and product safety is Sony Deutschland GmbH, Hedelfinger Strasse 61, 70327 Stuttgart, Germany. For any service or guarantee matters please refer to the addresses given in separate service or guarantee documents.

Index to Parts and Controls

For more information, see the pages indicated in parentheses.

Upper view

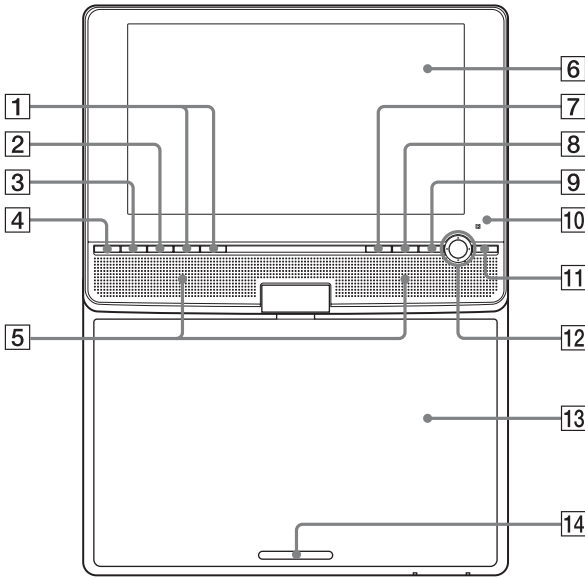

1 ◀◀/▶▶ (previous/next) buttons (16)

2 ■ (stop) button (16)

3 || (pause) button (16)

4 ▷ (play) button (15)

5 Speaker (16)

6 LCD panel (10)

7 DISPLAY button (21)

8 MENU button (17)

9 RETURN button (21)

10 (remote sensor) (9)

11 OPTIONS button (24)

12 ◀/↑/↓/▶ buttons, ENTER button (17)

13 Disc lid (15)

14 PUSH CLOSE (15)

Front view

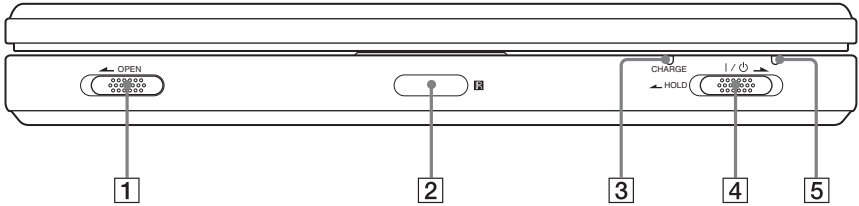

- 1 OPEN knob (15)
- 2 (remote sensor) (9)
- 3 CHARGE indicator (13)
- 4 (on/standby)/HOLD switch (15)
- 5 Power indicator (15)

Left view

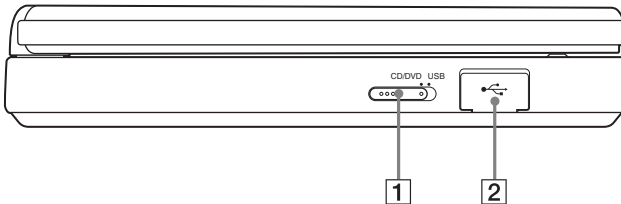

- 1 CD/DVD USB switch (15)
- 2 USB jack (25)

Right view

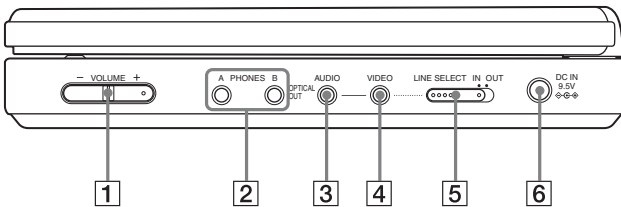

- 1 VOLUME +/- (sound volume) button
- 2 PHONES (headphone) jack A, B
- 3 AUDIO (input/output) jack/OPTICAL OUT (optical output) jack (39, 40)
- 4 VIDEO (input/output) jack (39)
- 5 LINE SELECT (IN/OUT) switch (15)
- 6 DC IN 9.5V (AC adaptor input) jack (11)

Remote

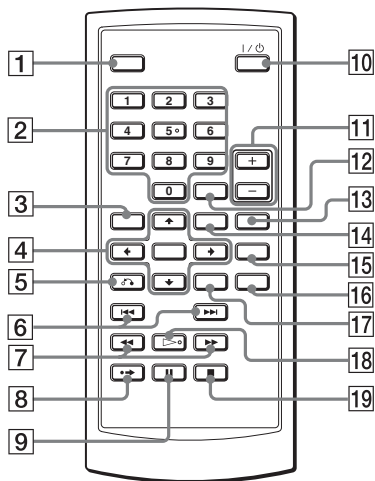

- 1 DISPLAY button (21)
- 2 Number buttons (17)*
- 3 TOP MENU button (17)
- 4 ←/↑/↓/→ buttons, ENTER button (17)
- 5 ↻ RETURN button (21)
- 6 ◀◀/▶▶ PREV (previous)/NEXT buttons (16)
- 7 ◀◀/▶▶ (scan/slow) buttons (23)
- 8 ●→ ADVANCE button (16)
- 9 || PAUSE button (16)
- 10 I/⏻ (on/standby) button (15)
- 11 VOL (sound volume) +/- buttons
- 12 CLEAR button (37)
- 13 AUDIO button (18)*
- 14 MENU button (17)
- 15 SUBTITLE button (19)
- 16 ANGLE button (19)
- 17 OPTIONS button (24)
- 18 ▷ PLAY button (15)*
- 19 ■ STOP button (16)

* Use the tactile dot as a reference when operating the player. The number 5 button has a tactile dot.

Index

Numerics

- 16:9 34
- 4:3 Letter Box 34
- 4:3 Pan Scan 34

A

- Album 45
- Angle 19
- Audio 18, 36
- Audio DRC 35
- Audio Setup 35

B

- Batteries 9

C

- CD 7, 15
- Connecting 39

D

- DATA CD 6, 31, 44
- DATA DVD 6, 31, 44
- Digital output 35
- Disc Menu 36
- Display
 - Playback Settings Display 21
 - Setup Display 33
- DivX® 30, 31
- Dolby Digital 18, 36
- DTS 18, 36
- DVD 6, 15
- DVD+RW 6
- DVD's menu 17
- DVD-RW 6, 20

F

- Fast forward 23
- Fast reverse 23

G

- General Setup 34

H

- Handling discs 3

J

- JPEG 6, 44

L

- Language Setup 36

M

- MP3 6, 44

O

- OPTICAL OUT 35
- Original 20
- OSD (On-Screen Display) 36

P

- PBC Playback 20
- Play List 20

R

- Remote 9, 49
- Repeat
 - CD/VIDEO CD 24
 - DVD 22
- Repeat Play 22, 24
- Resume Play 17

S

- Scan 23
- Screen Saver 35
- Search 23
- Setup 33
- Setup Display 33
- Slide Show 28
- Slow Play 24
- Subtitle 36

T

- Top Menu 17
- Troubleshooting 42
- TV Display 34

U

- Usable discs 7

V

- VIDEO CD 6, 8, 15

3-100-247-11(2)



* I - 3 1 0 0 2 4 7 1 1 U *

Free Manuals Download Website

<http://myh66.com>

<http://usermanuals.us>

<http://www.somanuals.com>

<http://www.4manuals.cc>

<http://www.manual-lib.com>

<http://www.404manual.com>

<http://www.luxmanual.com>

<http://aubethermostatmanual.com>

Golf course search by state

<http://golfingnear.com>

Email search by domain

<http://emailbydomain.com>

Auto manuals search

<http://auto.somanuals.com>

TV manuals search

<http://tv.somanuals.com>