

SONY®

2-632-913-43(1)

LCD Projection TV



Operating Instructions

△ Before operating the TV, please read the "Safety Information" section of this manual.
Retain this manual for future reference.

DVB[®]
Digital Video
Broadcasting

KDF-E50A12U
KDF-E42A12U

BRAVIA

<http://www.sony.net/>

KDF-E50A12U
KDF-E42A12U



263291343

2-632-913-43(1)



Printed in Spain

© 2005 Sony Corporation

Download from [Www.Somanuals.com](http://www.Somanuals.com). All Manuals Search And Download.

NOTICE FOR CUSTOMERS

A moulded plug complying with BS1363 is fitted to this equipment for your safety and convenience.

Should the fuse in the plug supplied need to be replaced, a 5 AMP fuse approved by ASTA or BSI to BS 1362 (i.e., marked with  or ) must be used.

When an alternative type of plug is used it should be fitted with a 5 AMP FUSE, otherwise the circuit should be protected by a 5 AMP FUSE at the distribution board.

If the plug supplied with this equipment has a detachable fuse cover, be sure to attach the fuse cover after you change the fuse. Never use the plug without the fuse cover. If you should lose the fuse cover, please contact your nearest Sony service station.

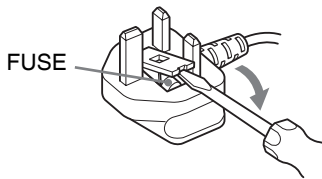

How to replace the fuse

Open the fuse compartment with a blade screwdriver, and replace the fuse.

WARNING

- To prevent the risk of electric shock, do not insert the plug cut off from the mains lead into a socket outlet. This plug cannot be used and should be destroyed.
- To prevent the risk of fire or electric shock, do not expose the TV set to rain or moisture.
- Dangerously high voltages are present inside the TV set. Do not open the cabinet. Refer servicing to qualified personnel only.

Introduction

Thank you for choosing this Sony product. Before operating the TV, please read this manual thoroughly and retain it for future reference.

Trademark information

- **DVB** is a registered trademark of the DVB project.
- “PlayStation” is a trademark of Sony Computer Entertainment, Inc.
- Licensed by BBE Sound, Inc. under USP4638258, 4482866. “BBE” and BBE symbol are trademarks of BBE Sound, Inc.
- Manufactured under license from Dolby Laboratories. “Dolby” and the double-D symbol  are trademarks of Dolby Laboratories.
- **HDMI** This TV incorporates High-Definition Multimedia Interface (HDMI™) technology. HDMI, the HDMI logo and High-Definition Multimedia Interface are trademarks or registered trademarks of HDMI Licensing LLC.

Table of Contents

Safety information	4
Precautions	7
Overview of the remote	8
Overview of the TV buttons and indicators.....	9

Getting Started

1: Checking the accessories	10
2: Inserting batteries into the remote.....	10
3: Connecting an aerial/VCR.....	11
4: Preventing the TV from toppling over....	12
5: Switching on the TV	12
6: Auto-tuning the TV	13

Watching TV **DVB** : for digital channels only

Watching TV	14
Checking the Digital Electronic Programme Guide (EPG) DVB	16
Using the Favourite list DVB	18
Viewing pictures from connected equipment	19

Using the Menu

Navigating through menus	19
Overview of the menus.....	20
Picture Adjustment menu	21
Picture Mode	21
Contrast/Brightness/Colour/Hue/Sharpness/ Iris	21
Colour Tone.....	22
Reset	22
Noise Reduction	22
Sound Adjustment menu	23
Sound Effect	23
Treble/Bass/Balance	23
Reset	23
Dual Sound.....	24
Auto Volume	24
Screen menu	25
Auto Format.....	25
Screen Format.....	25
RGB Center	25

Features menu	26
AV2 Output.....	26
TV Speakers.....	26
PC Adjustment	27
Timer menu	28
Sleep Timer.....	28
Clock Set.....	28
Timer	28
Set Up menu.....	29
Auto Start Up.....	29
Auto Tuning (Analogue mode only).....	29
Programme Sorting (Analogue mode only).....	29
Programme Labels (Analogue mode only).....	30
AV Preset	30
Manual Programme Preset (Analogue mode only)	30
Digital Set Up DVB	32

Using Optional Equipment

Connecting optional equipment	35
-------------------------------------	----

Additional Information

Optimum Viewing area	38
Replacing the lamp.....	39
Specifications	42
Troubleshooting.....	44
Index.....	46

Safety information

Mains lead

- Unplug the mains lead when moving the TV set. Do not move the TV set with the mains lead plugged in. It may damage the mains lead and result in fire or electric shock.
- If you damage the mains lead, it may result in fire or electric shock.
 - Do not pinch, bend, or twist the mains lead excessively. The core conductors may be exposed or broken, causing a short-circuit, which may cause fire or electric shock.
 - Do not modify or damage the mains lead.
 - Do not put anything heavy on the mains lead. Do not pull the mains lead.
 - Keep the mains lead away from heat sources.
 - Be sure to grasp the plug when disconnecting the mains lead.
- If the mains lead is damaged, stop using it and ask your dealer or Sony service centre to exchange it.
- Use only an original Sony mains lead, not other brands.

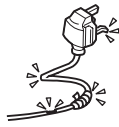
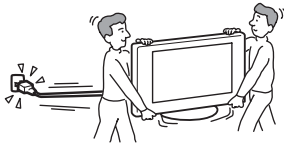

Mains lead/cable protection

Pull out the mains lead/cable by the plug. Do not pull on the mains lead/cable itself.

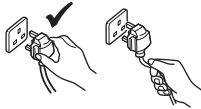

Mains

Do not use a poor fitting mains socket. Insert the plug fully into the mains socket. A poor fit may cause arcing and result in fire. Contact your electrician to have the mains socket changed.



Optional accessories

Observe the following when installing the TV set using a stand. If you do not do so, the TV set may fall and cause serious injury.

- Use the specified stand.
- Secure the TV set properly, following the instructions supplied with your stand when installing the TV set.
- Be sure to attach the brackets supplied with your stand.

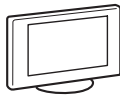

Medical institutions

Do not place this TV set in a place where medical equipment is in use. It may cause malfunction of medical instruments.

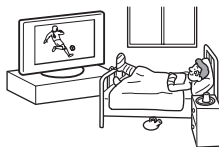

Carrying

- Before carrying the TV set, disconnect all the cables from the TV set.
- When you carry the TV set by hand, hold the TV set as illustrated on the right. If you do not do so, the TV set may fall and be damaged or cause serious injury. If the TV set has been dropped or damaged, have it checked immediately by qualified service personnel.
- When transporting it, do not subject the TV set to jolts or excessive vibration. The TV set may fall and be damaged or cause serious injury.
- When you carry the TV set in for repair or when you move it, pack it using the original carton and packing material.
- Carrying the TV set requires two people.

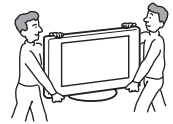

Ventilation

- Never cover the ventilation holes in the rear side. It may cause overheating and result in fire.
- Unless proper ventilation is provided, the TV set may gather dust and get dirty. For proper ventilation, observe the following:
 - Do not install the TV set turned backwards or sideways.
 - Do not install the TV set turned over or upside down.
 - Do not install the TV set on a shelf or in a closet.
 - Do not place the TV set on a rug or bed.
 - Do not cover the TV set with cloth, such as curtains, or items such as newspapers, etc.
- Leave some space around the TV set. Otherwise, air-circulation may be inadequate and cause overheating, which may cause fire or damage to the TV set.

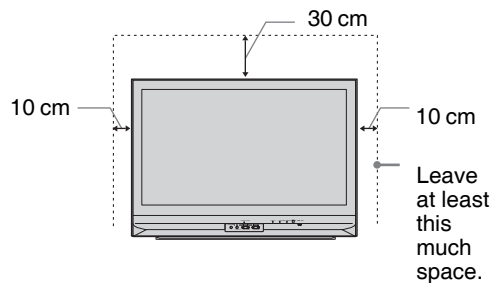

- When installing the TV set on the wall, leave at least 10 cm space from the bottom of the TV set.
- Never install the TV set as follows:

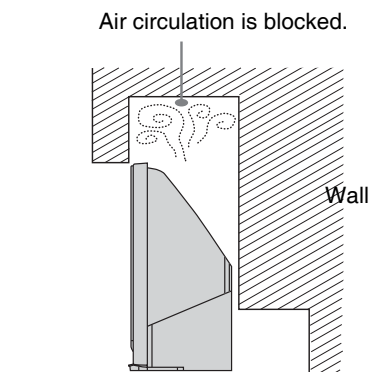

Ventilation holes

Do not insert anything in the ventilation holes. If metal or liquid is inserted in these holes, it may result in fire or electric shock.



Placement

- Never place the TV set in hot, humid or excessively dusty places.
- Do not install the TV set where insects may enter.
- Do not install the TV set where it may be exposed to mechanical vibration.
- Place the TV set on a stable, level surface. Otherwise, the TV set may fall and cause injury.
- Do not install the TV set in a location where it may protrude, such as on a behind a pillar or where you might bump your head on it. Otherwise, it may result in injury.



Water and moisture

- Do not use this TV set near water – for example, near a bathtub or shower room. Also do not expose to rain, moisture or smoke. This may result in fire or electric shock.
- Do not touch the mains lead and the TV set with set hands. Doing so may cause electric shock or damage to the TV set.



Moisture and flammable objects

- Do not let this TV set get wet. Never spill liquid of any kind on the TV set. If any liquid or solid object does fall through openings in the cabinet, do not operate the TV set. It may result in electric shock or damage to the TV set. Have it checked immediately by qualified service personnel.
- To prevent fire, keep flammable objects (candles, etc.) and electric bulbs away from the TV set.

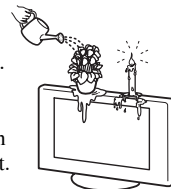

Oils

Do not install this TV set in restaurants that use oil. Dust absorbing oil may enter and damage the TV set.

Fall

Place the TV set on a secure, stable stand. Do not hang anything on the TV set. If you do, the TV set may fall from the stand, causing damage or serious injury. Do not allow children to climb on the TV set.



Vehicle or ceiling

Do not install this TV set in a vehicle. The motion of the vehicle may cause the TV set to fall down and cause injury. Do not hang this TV set from the ceiling.



Ships and other vessels

Do not install this TV set on a ship or other vessel. If the TV set is exposed to seawater, it may cause fire or damage the TV set.

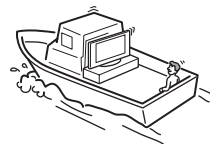

Outdoor use

- Do not expose the TV set to direct sunlight. The TV set may heat up and this may result in damage to the TV set.
- Do not install this TV set outdoors.



Wiring

- Unplug the mains lead when wiring cables. When hooking up, be sure to unplug the mains lead for your safety.
- Take care not to catch your feet on the cables. It may damage the TV set.

Cleaning

- Unplug the mains lead when cleaning the mains plug and this TV set. If you do not, it may result in electric shock.
- Clean the mains plug regularly. If the plug is covered with dust and it picks up moisture, its insulation may deteriorate and result in fire.



Lightning storms

For your own safety, do not touch any part of the TV set, mains lead, or aerial lead during lightning storms.



Continued

Damage requiring service

If the surface of the TV set cracks, do not touch it until you have unplugged the mains lead. Otherwise electric shock may result.

Servicing

Do not open the cabinet. Entrust the TV set to qualified service personnel only.



Small accessories removal and fittable

Keep accessories out of children's reach. If they are swallowed, choking or suffocation may occur. Call a doctor immediately.

When not in use

For environmental and safety reasons, it is recommended that the TV set is not left in standby when unused. Disconnect from the mains. However, some TV sets may have features which need the TV set to be left in standby to work correctly. The instructions in this manual will inform you if this applies.



Viewing the TV

- To view the TV comfortably, the recommended viewing position is from four to seven times the screen's vertical length away from the TV set.
- View the TV in moderate light, as viewing the TV in poor light strains your eyes. Watching the screen continuously for long periods of time can also strain your eyes.
- If the angle of the TV set is to be adjusted, steady the base of the stand with your hand to prevent the TV set from becoming separated from the stand. Be careful not to get your fingers caught between the TV set and the stand.

Volume adjustment

- Adjust the volume so as not to trouble your neighbours. Sound carries very easily at night time. Therefore, closing the windows or using headphones is suggested.
- When using headphones, adjust the volume so as to avoid excessive levels, as hearing damage may result.

Overloading

This TV set is designed to operate on a 220–240 V AC supply only. Take care not to connect too many appliances to the same mains socket as this could result in fire or electric shock.

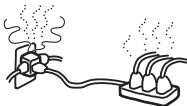

Heat

Do not touch the surface of the TV set. It remains hot, even after the TV set has been turned off for some time.

Corrosion

If you use this TV set near the seashore, salt may corrode metal parts of the TV set and cause internal damage or fire. It may also shorten the life of the TV set. Steps should be taken to reduce the humidity and moderate the temperature of the area where the TV set is located.

Precautions

LCD Panel

- Although the LCD panel is made with high-precision technology and 99.99% or more of the pixels are effective, black dots may appear or bright points of light (red, blue, or green) may appear constantly on the LCD panel. This is a structural property of the LCD panel and is not a malfunction.
- Do not expose the LCD panel surface to the sun. Doing so may damage the screen surface.
- Do not push or scratch the front filter, or place objects on top of this TV set. The image may be uneven or the LCD panel may be damaged.
- If this TV set is used in a cold place, a smear may occur in the picture or the picture may become dark. This does not indicate a failure. These phenomena disappear as the temperature rises.
- Ghosting may occur when still pictures are displayed continuously. It may disappear after a few moments.
- The screen and cabinet get warm when this TV set is in use. This is not a malfunction.
- The LCD contains a small amount of liquid crystal and mercury. The fluorescent tube used in this TV set also contains mercury. Follow your local ordinances and regulations for disposal.

Installing the TV set

- Do not install the TV set in places subject to extreme temperature, for example in direct sunlight, or near a radiator, or heating vent. If the TV set is exposed to extreme temperature, the TV set may overheat and cause deformation of the casing or cause the TV set to malfunction.
- The TV set is not disconnected from the mains when the TV set is switched off. To disconnect the TV set completely, pull the plug from the mains.
- To obtain a clear picture, do not expose the screen to direct illumination or direct sunlight. If possible, use spot lighting directed down from the ceiling.
- Do not install optional components too close to the TV set. Keep optional components at least 30 cm away from the TV set. If a VCR is installed in front of the TV set or beside the TV set, the picture may become distorted.
- Picture distortion and/or noisy sound may occur if the TV set is positioned in close proximity to any equipment emitting electromagnetic radiation.

Handling and cleaning the screen surface/cabinet of the TV set

The screen surface is finished with a special coating to prevent strong light reflections.

To avoid material degradation or screen coating degradation, observe the following precautions.

- Do not push on the screen, scratch it with a hard object, or throw anything at it. The screen may be damaged.
- Do not touch the display panel after operating the TV set continuously for a long period as the display panel becomes hot.
- We recommend that the screen surface be touched as little as possible.
- To remove dust from the screen surface/cabinet, wipe gently with a soft cloth. If dust is persistent, wipe with a soft cloth slightly moistened with a diluted mild detergent solution. You can wash and repeatedly use the soft cloth.
- Never use any type of abrasive pad, alkaline/acid cleaner, scouring powder, or volatile solvent, such as alcohol, benzene, thinner or insecticide. Using such materials or maintaining prolonged contact with rubber or vinyl materials may result in damage to the screen surface and cabinet material.
- The ventilation holes can accumulate dust over time. To ensure proper ventilation, we recommend removing the dust periodically (once a month) using a vacuum cleaner.

Disposal of the TV set

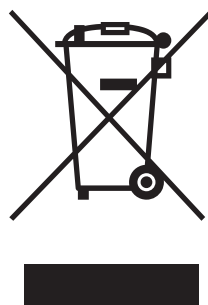

Disposal of Old Electrical & Electronic Equipment (Applicable in the European Union and other European countries with separate collection systems)

This symbol on the product or on its packaging indicates that this product shall not be treated as household waste. Instead it shall be handed over to the applicable collection point for the recycling of electrical and electronic equipment. By ensuring this product is disposed of correctly, you will help prevent potential negative consequences for the environment and human health, which could otherwise be caused by inappropriate waste handling of this product. The recycling of materials will help to conserve natural resources. For more detailed information about recycling of this product, please contact your local city office, your household waste disposal service or the shop where you purchased the product.

Overview of the remote

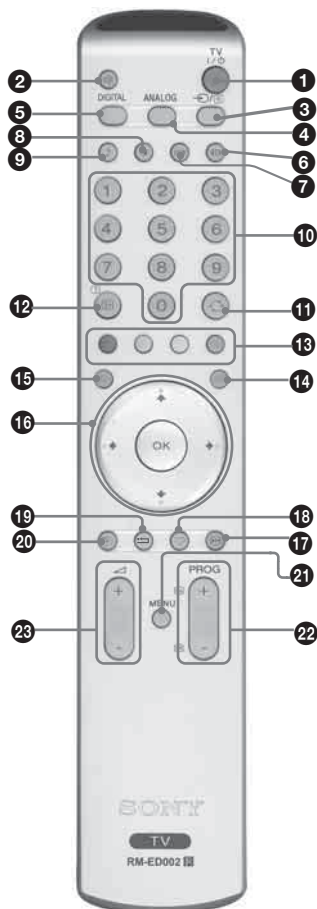

- 1 TV I/⏻ – TV standby**
Switches off the TV temporarily. The ⏻ (standby) indicator on the front of the TV lights up. Press again to switch on the TV from the standby mode.
- 2** – Mute (page 14)
- 3** – Input select / Text hold
 - In TV mode (page 19): Selects the input source from equipment connected to the TV sockets.
 - In Analogue Text mode (page 15): Holds the current page.
- 4 ANALOG – Analogue mode**
- 5 DIGITAL – digital mode**
Switches to digital mode. In digital mode, removes any interactive prompts from the screen.
- 6** – Screen mode (page 15)
- 7 This button is not supported on this set.**
- 8** – Picture mode (page 21)
- 9** – Sound effect (page 23)
- 10 Number buttons**
 - In TV mode: Selects channels. For channel numbers 10 and above, enter the second digit within two seconds.
 - In Analogue Text mode: Enters the three digit page number to select the page.
- 11** Previous channel
Returns to the previous channel watched (for more than five seconds).
- 12** – Info / Text reveal
 - In digital mode: Displays brief details of the programme currently being watched.
 - In analogue mode: Displays information such as current channel number and screen mode.
 - In Analogue Text mode (page 15): Reveals hidden information (e.g., answers to a quiz).

- 13 Coloured buttons**
 - In digital mode (page 16, 18): Selects the options at the bottom of the screen in the Favourite and EPG digital menus.
 - In Analogue Text mode (page 15): Used for Fastext.
- 14** – Text (page 15)
- 15** – EPG (Digital Electronic Programme Guide) (page 16)
- 16** (page 19)
- 17 Picture Freeze (page 15)**
Freezes the TV picture.
- 18** – Favourite (page 18)
- 19** – Digital Text off (page 15)
- 20 Sleep Timer (page 28)**
Sets the TV to standby mode after a specified time period.
- 21 MENU (page 19)**
- 22 PROG +/- (page 14)**
 - In TV mode: Selects the next (+) or previous (-) channel.
 - In Analogue Text mode: Selects the next (+) or previous (-) page.
- 23** +/- – Volume

Tip

The ///, PROG+, and number 5 buttons have tactile dots. Use the tactile dots as references when operating the TV.

Overview of the TV buttons and indicators

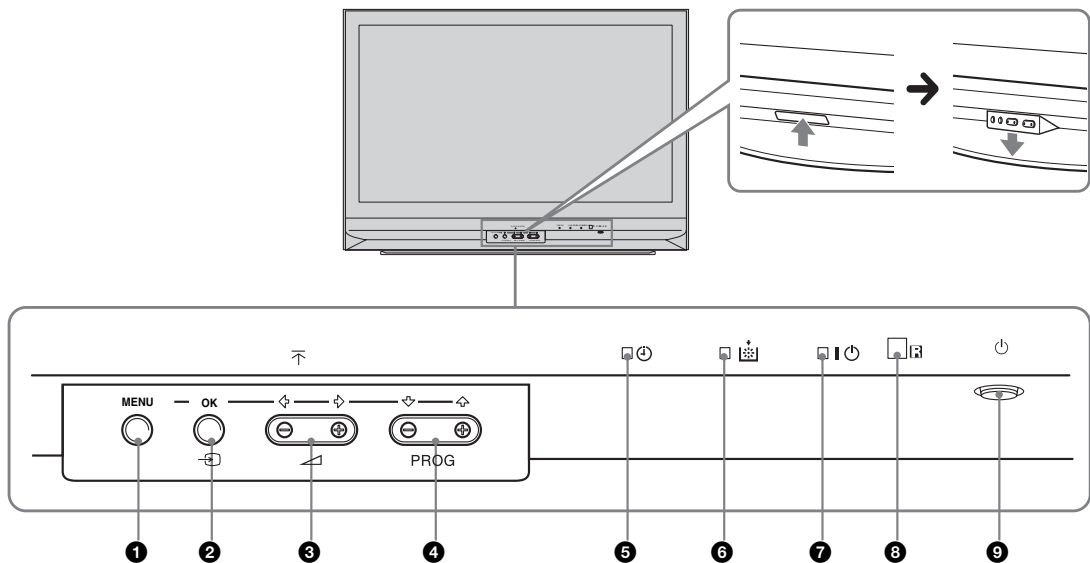

1 **MENU** (page 19)

2 **OK** / **→** – Input select (page 15)

- In TV mode: Selects the input source from equipment connected to the TV sockets.
- In TV menu: OK

3 **+/-** **←/→**

- Increases (+) or decreases (-) the volume.
- In TV menu: Moves through the options left (**←**) or right (**→**).

4 **PROG +/-** **↑/↓**

- In TV mode: Selects the next (+) or previous (-) channel.
- In TV menu: Moves through the options up (**↑**) or down (**↓**).

5 **⌚** – Sleep Timer (page 28)

- Lights up in amber when the “Sleep Timer” is set or when a digital event is programmed.
- Lights up in amber when digital REC starts.

6 **Lamp Indicator.**

Lights up in red when the lamp for the light source has burned out (page 39)

7 **I** – Power indicator / **⏻** – Standby indicator

- Lights up in green when the TV is switched on.
- Lights up in red when the TV is in standby mode.

8 **Remote control sensor**

9 **⏻** – Power

Switches the TV on or off.

1: Checking the accessories

Remote RM-ED002 (1)

Size AA batteries (R6 type) (2)

Coaxial cable (1)

2: Inserting batteries into the remote

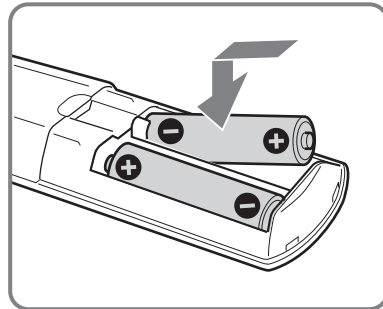
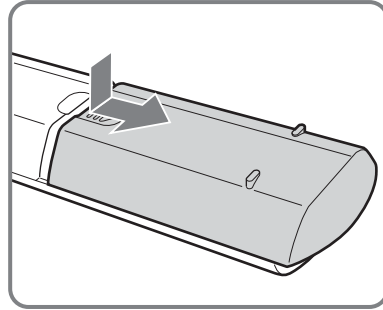

Notes

- Observe the correct polarity when inserting batteries.
- Dispose of batteries in an environmentally friendly way. Certain regions may regulate disposal of the battery. Please consult your local authority.
- Do not use different types of batteries together or mix old and new batteries.
- Handle the remote with care. Do not drop or step on it, or spill liquid of any kind onto it.
- Do not place the remote in a location near a heat source, or in a place subject to direct sunlight, or in a damp room.

3: Connecting an aerial/VCR

A

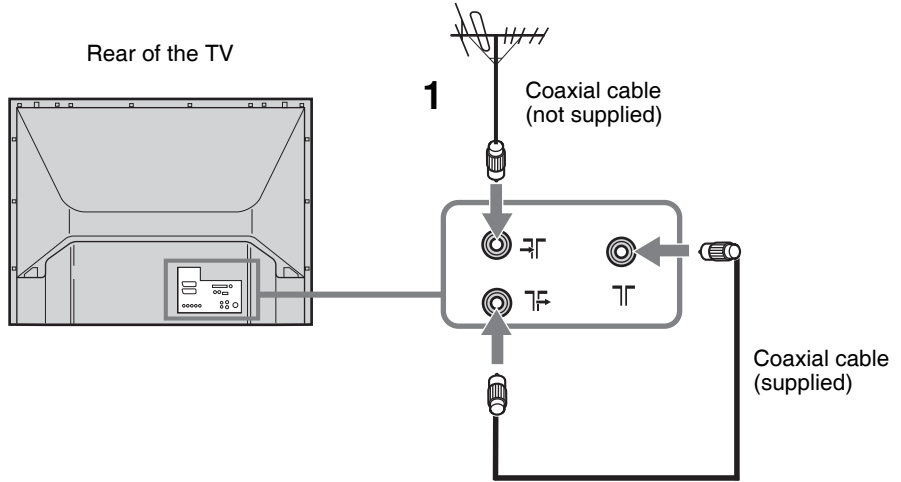

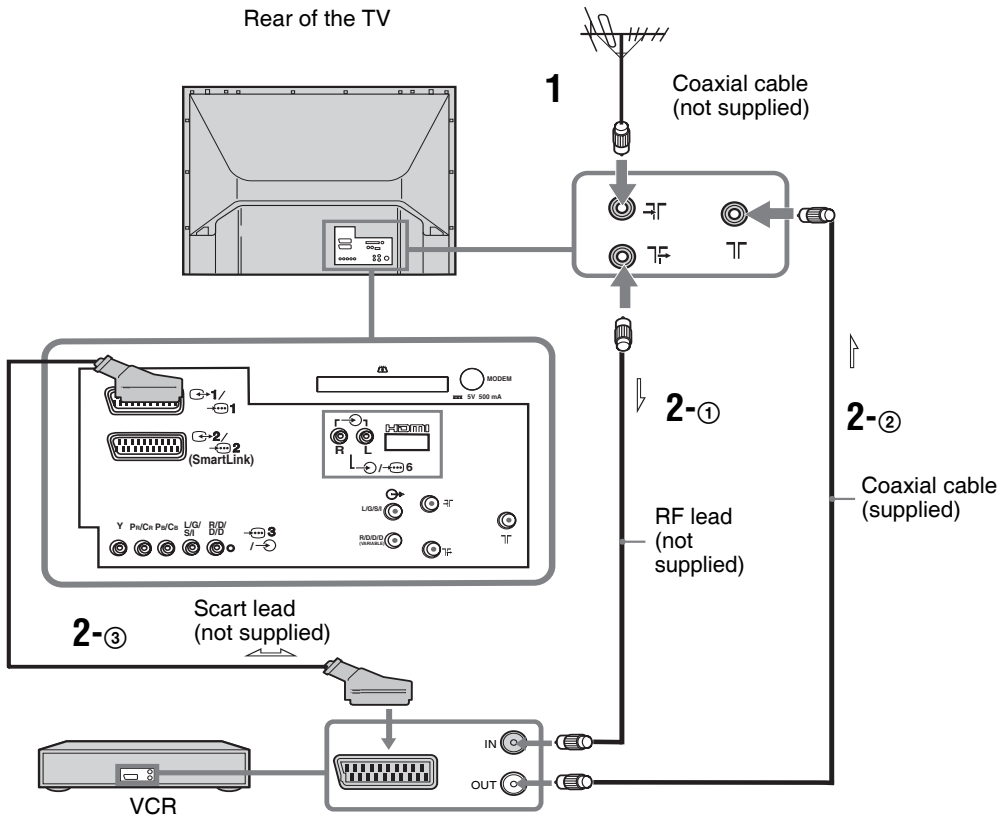

B



- 1** Connect your aerial to the  socket on the rear of the TV.

If connecting to an aerial only (A)

Connect the  socket to the  socket on the rear of the TV with the supplied coaxial cable.

Go to step 3.

If connecting to a VCR with an aerial (B)

Go to step 2.

- 2** Connect your VCR.

① Connect the  socket on the rear of the TV to the input socket on your VCR with the RF lead.

② Connect the output socket on your VCR to the  socket on the rear of the TV with the supplied coaxial cable.

③ Connect the scart socket on your VCR to the  scart socket on the rear of the TV with a scart lead.

Note

Do not connect the mains lead to your mains socket until all connections are complete.

- 3** Bundle the cable.

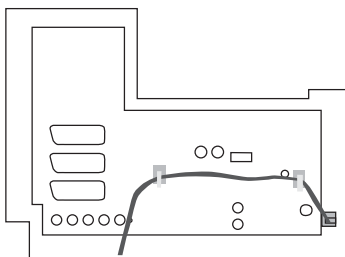

4: Preventing the TV from toppling over

Sony strongly recommends using the TV stand SU-RG11S (for KDF-E42A12U)/SU-RG11M (for KDF-E50A12U) with a support belt designed for your TV.

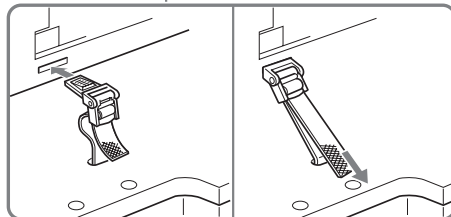
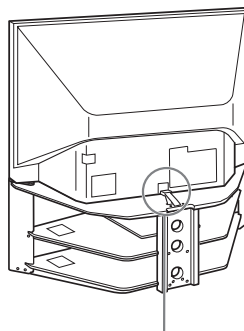

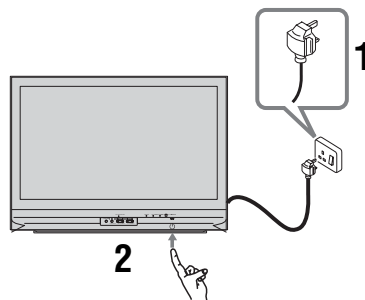

5: Switching on the TV



- 1** Connect the TV to your mains socket (220-240V AC, 50Hz).

- 2** Press  on the TV (front side).

When you switch on the TV for the first time, the message confirming the TV start auto-tuning appears on the screen.

When the TV is in standby mode (the  (standby) indicator on the front of the TV is red), press TV  on the remote to switch on the TV, then go to page 13.

6: Auto-tuning the TV

When you switch on the TV for the first time, the message confirming the TV start auto-tuning appears on the screen.

You must tune the TV to receive channels (TV broadcasts). Do the following to search and store all available channels.

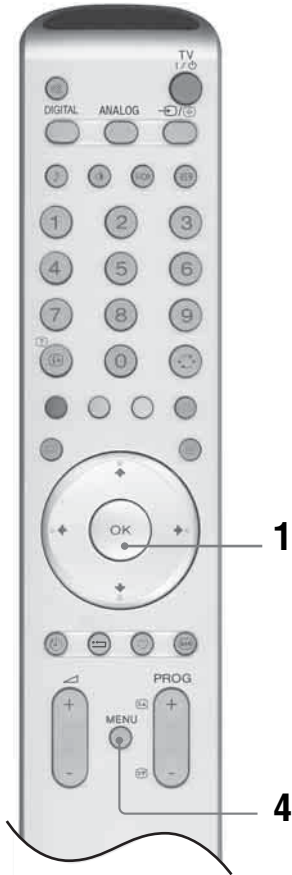

- 1 Press OK to select "Yes".

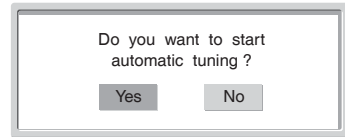

Digital auto-tune display

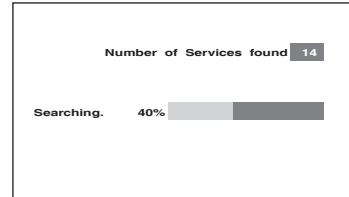

Analogue auto-tune display

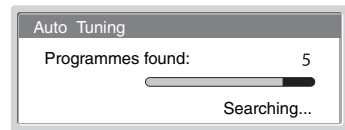

The TV starts searching for all available digital channels followed by all available analogue channels. This may take some time, please be patient and do not press any buttons on the TV or remote.

Once all available digital and analogue channels have been stored, the TV returns to normal operation, displaying the digital channel stored on channel number 1. If no digital channels are found, the analogue channel stored on channel 1 is displayed.

When a message appears for you to confirm the aerial connections

No digital or analogue channels are found. Check all the aerial connections and press OK twice to start auto-tuning again.

- 2 The Programme Sorting menu appears on the screen.

Note

If some digital channel is found, this step will not appear



- 3 To change the order in which the channels are stored on the TV. See page 29.

- 4 Press MENU to exit.

The TV has now tuned in all the available channels.

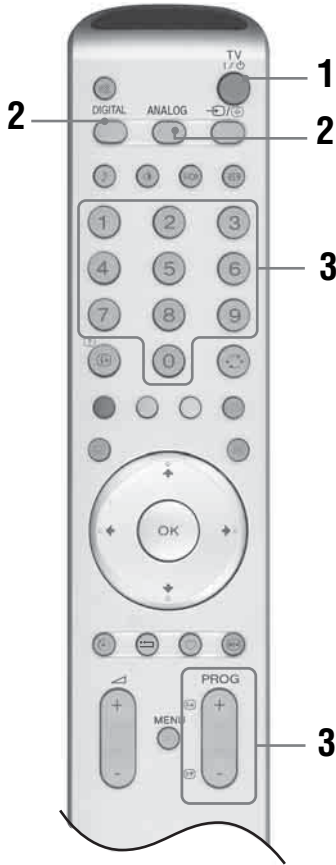
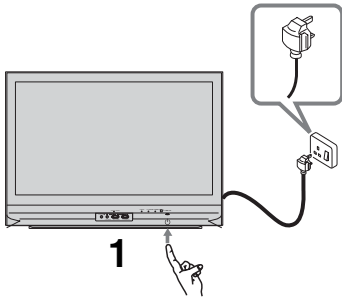
Watching TV



- 1** Press  on the TV (Front side) to switch on the TV.
When the TV is in standby mode (the  (standby) indicator on the front of the TV is red), press TV  on the remote to switch on the TV.

- 2** Press DIGITAL to switch to digital mode or  to switch to analogue mode.

The channels available vary depending on the mode.











- 3** Press the number buttons or PROG +/- to select a TV channel.

To select channel numbers 10 and above using the number buttons, enter the second and third digits within two seconds.







To select a digital channel using the Digital Electronic Programme Guide (EPG), see page 16.





In digital mode

An information banner appears briefly. The following icons may be indicated on the banner.

- : Interactive service is available (MHEG Digital Text)
- : Interactive service (MHEG Digital Text) is currently disabled
- : Radio service
- : Scrambled/Subscription service
- : Multiple audio languages available
- : Subtitles available
- : Subtitles available for the hearing impaired
- : Recommended minimum age for current programme (from 4 to 18 years)
- : Parental Lock
- : Current programme is being recorded

Additional operations

To	Do this
Turn off the TV temporarily (Standby mode)	Press TV  .
Turn on the TV from Standby mode without sound	Press  . Press  to set the volume level
Turn off the TV completely	Press  on the front side of the TV.
Adjust the volume	Press  + (increase) /- (decrease).
Mute the sound	Press  . Press again to restore.
Switch to digital mode	Press DIGITAL.
Hide interactive prompts from the screen (in digital mode only)	
Switch to analogue mode	Press  .

To	Do this
Return to the previous channel watched (for more than five seconds)	Press  .
Access the Programme index table (in analogue mode only)	Press OK. To select a channel, press  , then press OK.
To access the Input signal index table	Press OK. Press  to select the desired input signal, press  , then press OK.

To access Digital Text





Many broadcasters provide a Digital Text service. Digital Text offers graphically rich contents, compared to Analogue Text.

Select a digital channel which provides Digital Text, then press .

When a broadcaster provides a dedicated Digital Text channel, select this channel to access Digital Text.

To navigate through Digital Text, follow the instructions on the screen.



To exit Digital Text, press .

To move around, press , , , or .

To select items, press OK and the number buttons.



To access shortcuts, press the coloured buttons.

To access Analogue Text

In analogue mode, press . Each time you press , the display changes cyclically as follows:

Text → Text over the TV picture (mix mode) → No Text (exit the Text service)

To select a page, press the number buttons or PROG +/-.

To hold a page, press / .

To reveal hidden information, press / .

Return to normal TV mode .



Tips

- Ensure that the TV is receiving a good signal, or some text errors may occur.
- Most TV channels broadcast a Text service. For information on the use of the service, select the index page (usually page 100).

When four coloured items appear at the bottom of the Text page, Fastext is available. Fastext allows you to access pages quickly and easily. Press the corresponding coloured button to access the page.

Picture Freeze

Freezes the TV picture (e.g. to make a note of a telephone number or recipe).

- 1 Press  on the remote control.
- 2 Press  again to return to normal TV mode.

To change the screen mode manually to suit the broadcast

Press  repeatedly to select Wide, Smart, 4:3, 14:9, or Zoom.

Wide

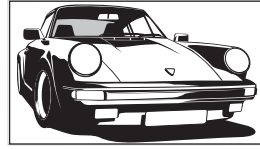

Displays wide screen (16:9) broadcasts in the correct proportions.

Smart*

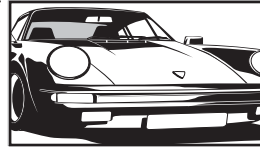

Displays conventional 4:3 broadcasts with an imitation wide screen effect. The 4:3 picture is stretched to fill the screen.

4:3

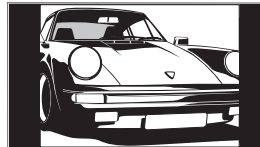

Displays conventional 4:3 broadcasts (e.g., non-wide screen TV) in the correct proportions.

As a result, black border areas are visible on the screen.

14:9*

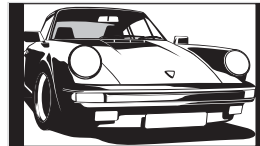

Displays 14:9 broadcasts in the correct proportions.

As a result, black border areas are visible on the screen.

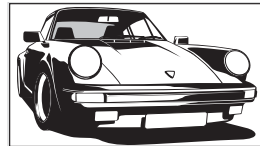

Zoom*



Displays cinemascopic (letter box format) broadcasts in the correct proportions.

* Parts of the top and bottom of the picture may be cut off.

Tips

- Alternatively, you can set "Auto Format" to "On". If the broadcaster sends format information the TV will automatically select the best mode to suit the broadcast (page 25).
- You can adjust the position of the picture when selecting Smart, 14:9, or Zoom. Press /  to move up or down (e.g., to read subtitles).

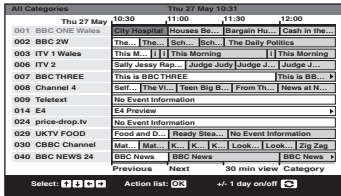

Checking the Digital Electronic Programme Guide (EPG) DV3



Digital Electronic Programme Guide (EPG)

- 1 In digital mode, press to display the Digital Electronic Programme Guide (EPG).
- 2 Perform the desired operation in following table.

To	Do this
Turn off the EPG	Press .
Move through the EPG	Press ///.
Display the previous or next six channels	Press the red (previous) or green (next) button.
Watch a current programme	Press OK while the current programme is selected.
Sort the programme information by category – Category list	<ol style="list-style-type: none"> 1 Press the blue button. 2 Press /// to select a category. The category name is displayed on the side. The categories available include: Favourite Contains all the channels that have been stored in the Favourite list (page 18). All categories Contains all available channels. News Contains all news channels. 3 Press OK. The Digital Electronic Programme Guide (EPG) now only displays the current programmes from the category selected.
Set a programme to be recorded – Timer REC	<ol style="list-style-type: none"> 1 Press /// to select the future programme you want to record. 2 Press OK. 3 Press / to select “Timer REC”. 4 Press OK to set the TV and your VCR timers. A symbol appears by that programme’s information.
Notes <ul style="list-style-type: none"> • You can set VCR timer recording on the TV only for Smartlink compatible VCRs. If your VCR is not Smartlink compatible, a message will be displayed to remind you to set your VCR timer. • Once a recording has begun, you can switch the TV to standby mode, but do not switch off the TV completely or the recording may be cancelled. 	

To	Do this
Set a programme to be displayed automatically on the screen when it starts – Reminder	<ol style="list-style-type: none"> 1 Press ↓/↑/←/→ to select the future programme you want to display. 2 Press OK. 3 Press ↓/↑ to select “Reminder”. 4 Press OK to automatically display the selected programme when the programme starts. A  symbol appears by that programme’s information. <p>Note If you switch the TV to standby mode, it will automatically turn itself on when the programme is about to start.</p>
Set the time and date of a programme you want to record – Manual Timer REC	<ol style="list-style-type: none"> 1 Press OK. 2 Press ↓/↑ to select “Manual Timer REC”. 3 Press ↓/↑ to select the date, then press →. 4 Set the start and stop time in the same way as in step 3. 5 Press ↓/↑ to select the channel, then press OK to set the TV and your VCR timers. A  symbol appears by that programme’s information. <p>Notes</p> <ul style="list-style-type: none"> • You can set VCR timer recording on the TV only for Smartlink compatible VCRs. If your VCR is not Smartlink compatible, a message will be displayed to remind you to set your VCR timer. • Once a recording has begun, you can switch the TV to standby mode, but do not switch off the TV completely or the recording may be cancelled.
Cancel a recording/reminder – Timer list	<ol style="list-style-type: none"> 1 Press OK. 2 Press ↓/↑ to select “Timer list”. 3 Press ↓/↑ to select the programme you want to cancel, then press OK. A display appears to confirm that you want to cancel the programme. 4 Press ← to select “Yes”, then press OK to confirm.

Using the Favourite list

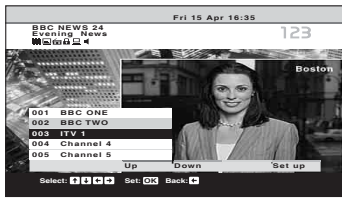













Favourite list

- 1 In digital mode, press  to display the Favourite list.

A message appears asking if you want to add channels to the Favourite list when the Favourite list is blank.

- 2 Perform the desired operation in following table.

To	Do this
Create your Favourite list for the first time	<p>A message appears asking if you want to add channels to the Favourite list when you press  for the first time.</p> <ol style="list-style-type: none"> 1 Press OK to select "Yes". 2 Press / to select the channel you want to add, then press OK. <p>If there are more than five channels in the list, press the green button for the next five channels or press the red button for the previous five channels. If you know the channel number, you can use the number buttons to directly select a channel.</p> <ol style="list-style-type: none"> 3 Press OK. <p>Channels that are stored in the Favourite list are indicated by a  symbol.</p>
Turn off the Favourite list	Press  .
Move through in the Favourite list	Press  /  .
Display the previous or next five channels	Press the red (previous) or green (next) button.
See brief details on current programmes	Press  while selecting a channel. Press again to cancel.
Watch a channel	Press OK while selecting a channel.
Add or remove channels in the Favourite list	<ol style="list-style-type: none"> 1 Press the blue button. <p>Channels that are stored in the Favourite list are indicated by a  symbol.</p> <ol style="list-style-type: none"> 2 Press / to select the channel you want to add or remove. <p>If there are more than five channels in the list, press the green button for the next five channels or press the red button for the previous five channels. If you know the channel number, you can use the number buttons to directly select a channel.</p> <ol style="list-style-type: none"> 3 Press OK. 4 Press the blue button to return to the Favourite list.
Remove all channels from the Favourite list	<ol style="list-style-type: none"> 1 Press the blue button. 2 Press the yellow button. <p>A display appears to confirm that you want to delete all channels from the Favourite list.</p> <ol style="list-style-type: none"> 3 Press  to select "Yes", then press OK to confirm.

Viewing pictures from connected equipment

Switch on the connected equipment, then perform one of the following operation.

For equipment connected to the scart sockets using a fully-wired 21-pin scart lead

Start playback on the connected equipment. The picture from the connected equipment appears on the screen.

For an auto-tuned VCR page 11

Press PROG +/-, or the number buttons, to select the video channel. You can also press \leftarrow / \rightarrow repeatedly until the correct input symbol (see below) appears on the screen.

For other connected equipment

Press \leftarrow / \rightarrow repeatedly until the correct input symbol (see below) appears on the screen or press OK to access the Input signal index table. Press \rightarrow to select an input source, press \downarrow / \uparrow , then press OK.

\leftarrow 1 / \rightarrow 1, \leftarrow 2 / \rightarrow 2:

Audio/video or RGB input signal through the scart socket \leftarrow / \rightarrow 1 or 2. \rightarrow appears only if an RGB source has been connected.

\leftarrow 3:

Component input signal through the Y, Pb/Cb, Pr/Cr sockets \leftarrow / \rightarrow 3, and audio input signal through the L/G/S/I, R/D/D/D sockets \leftarrow / \rightarrow 3.

\leftarrow 4/S / \rightarrow 4:

Video input signal through the video socket \leftarrow 4, and audio input signal through the audio socket L/G/S/I (MONO), R/D/D/D sockets \leftarrow 4. S \rightarrow appears only if the equipment is connected to the S video socket S \rightarrow 4 instead of the video socket \leftarrow 4, and S video input signal is input through the S video socket S \rightarrow 4.

\leftarrow 5:

RGB input signal through the PC connectors \leftarrow 5, and audio input signal through the socket \leftarrow 5.

\leftarrow 6:

Digital audio/video signal is input through the HDMI IN 6 socket. Audio input signal is analogue only if the equipment has been connected using the DVI and audio out socket.

Additional operations

To	Do this
Return to the normal TV operation	Press DIGITAL or \square .
Access the Input signal index table	Press OK. Press \rightarrow to select an input source, press \downarrow / \uparrow , then press OK.

Using the Menu

Navigating through menus

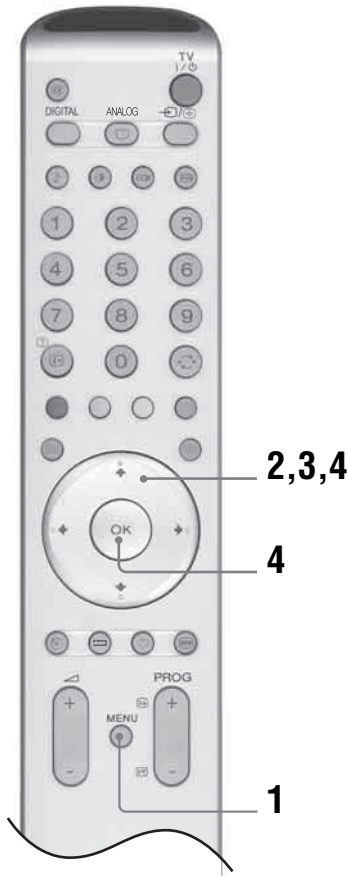

- 1 Press MENU to display the menu.
- 2 Press \uparrow / \downarrow to select a menu icon, press \rightarrow .
- 3 Press \uparrow / \downarrow / \leftarrow / \rightarrow to select an option.
- 4 Press \uparrow / \downarrow / \leftarrow / \rightarrow to change/set the setting, then press OK.
To exit the menu, press MENU.
To return to the last display, press \leftarrow .

Continued

Overview of the menus

The following options are available in each menu. For details on navigating through menus, see (page 19). Also, see page in parentheses for details of each menu.

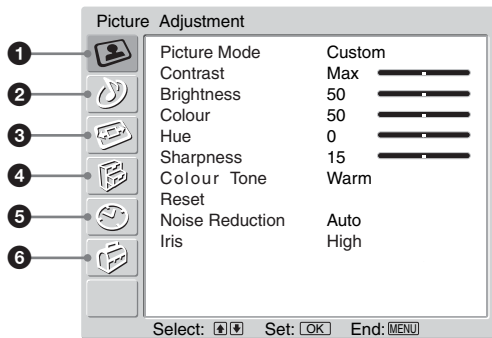

1 Picture Adjustment

- Picture Mode (21)
- Contrast/Brightness/Colour/Hue/Sharpness (21)
- Colour Tone (21)
- Reset (22)
- Noise Reduction (22)
- Iris (22)

2 Sound Adjustment

- Sound Effect (23)
- Treble/Bass/Balance (23)
- Reset (23)
- Dual Sound (24)
- Auto Volume (24)

3 Screen

- Auto Format (25)
- Screen Format (25)
- RGB Center (25)

4 Features

- AV2 Output (26)
- TV Speakers (26)
- PC Adjustment (27)

5 Timer

- Sleep Timer (28)
- Clock Set (28)
- Timer (28)

6 Set Up

- Auto Start Up (29)
- Auto Tuning (29)
- Programme Sorting (29)
- Programme Labels (30)
- AV Preset (30)
 - Label/Skip
- Manual Programme Preset (30)
 - Programme/Channel/Label/AFT/Audio Filter/Skip/ATT/Confirm
- Digital Set Up (32)
 - Digital Tuning/Digital Set-up

Picture Adjustment menu

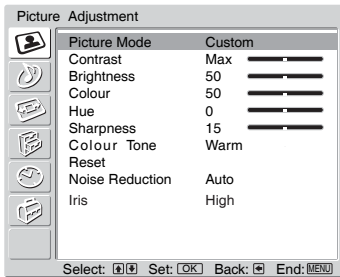

You can select the options listed below on the Picture Adjustment menu. To select options, see “Navigating through menus” (page 19).

Tip

When you set the “Picture Mode” option to “Vivid” or “Standard,” you can adjust only “Contrast,” and “Reset.”

Picture Mode

Selects the picture mode.

- 1 Press OK to select “Picture Mode”.
- 2 Press ↓/↑ to select one of the following picture modes, then press OK.
 - Vivid: For big lighted spaces.
 - Standard: Optimal picture for home use.
 - Custom: Allows you to store your own preferred settings.

Tip

You can change the picture mode by pressing  repeatedly.

Contrast/Brightness/Colour/Hue/Sharpness

- 1 Press OK to select the option.
- 2 Press ←/→ to set the level, then press OK.

Tip

“Hue” can only be adjusted for an NTSC colour signal (e.g., U.S.A. video tapes).

“Brightness”, “Colour”, “Hue” and “Sharpness” only appear and can be adjusted if “Picture Mode” is set to “Custom”.

Colour Tone

- 1 Press OK to select “Colour Tone”.
- 2 Press ↓/↑ to select one of the following, then press OK.

- Cool: Gives the white colours a blue tint.
- Neutral: Gives the white colours a neutral tint.
- Warm: Gives the white colours a red tint.

Tip

“Warm” only appears and can be adjusted if “Picture Mode” is set to “Custom”.

Continued

Reset

Reset all the picture settings to the factory settings.

- 1 Press OK to select "Reset".
- 2 Press ↓/↑ to select "OK," then press OK.

Noise Reduction

Reduces the picture noise (snowy picture) in a weak broadcast signal.

- 1 Press OK to select "Noise Reduction".
- 2 Press ↓/↑ to select "Auto", then press OK.

Tip

This option cannot be used for an input signal from the Y, PB/CB, PR/CR sockets of 3.

Iris

Enhances the contrast for dark scenes.

- 1 Press OK to select "Iris".
- 2 Press ↓/↑ to select "High", "Mid", "Low" or "Off" then press OK.

Sound Adjustment menu

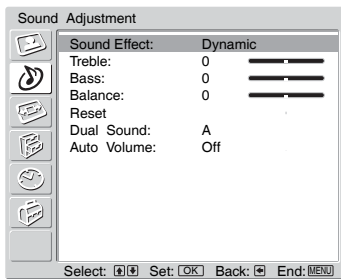

You can select the options listed below on the Sound Adjustment menu. To select options, see “Navigating through menus” (page 19).

Sound Effect

- 1 Press OK to select “Sound Effect”.
- 2 Press ↓/↑ to select one of the following sound effects, then press OK.
 - Natural: Enhances clarity, detail, and sound presence by using “BBE High definition Sound System^{*1}.”
 - Dynamic: Intensifies clarity and sound presence for better intelligibility and musical realism by using the “BBE High definition Sound System.”
 - Dolby Virtual^{*2}: Uses the TV speakers to simulate the surround effect produced by a multi channel system.
 - Off: Flat response.

Tips

- You can change sound effect by pressing ♪ repeatedly.
- If you set “Auto Volume” to “On”, “Sound Effect” changes to “Natural”.

^{*1} Licensed by BBE Sound, Inc. under USP4638258, 4482866. “BBE” and BBE symbol are trademarks of BBE Sound, Inc.

^{*2} Manufactured under license from Dolby Laboratories. “Dolby” and the double-D symbol **DD** are trademarks of Dolby Laboratories.

Treble/Bass/Balance

Adjusts higher-pitched sounds (Treble), adjusts lower-pitched sounds (Bass), and emphasizes left or right speaker balance (Balance).

- 1 Press OK to select the option.
- 2 Press ←/→ to set the level, then press OK.

Reset

Resets the “Treble,” “Bass” and “Balance” settings to the factory settings.

- 1 Press OK to select “Reset”.
- 2 Press ↓/↑ to select “OK,” then press OK.

Continued

Dual Sound

Selects the sound from the speaker for a stereo or bilingual broadcast.

1 Press OK to select “Dual Sound”.

2 Press ↓/↑ to select one of the following, then press OK.

- Stereo/Mono: For a stereo broadcast.
- A/B/Mono: For a bilingual broadcast, select “A” for sound channel 1, “B” for sound channel 2, or “Mono” for a mono channel, if available.

Tip

If you select other equipment connected to the TV, set “Dual Sound” to “Stereo,” “A” or “B.”

Auto Volume

Keeps a constant volume level even when volume level gaps occur (e.g., adverts tend to be louder than programmes).

1 Press OK to select “Auto Volume”.

2 Press ↓/↑ to select “On,” then press OK.

Tip

If you set “Sound Effect” to “Dolby Virtual”, “Auto Volume” will automatically be switched to “Off”.

Screen menu

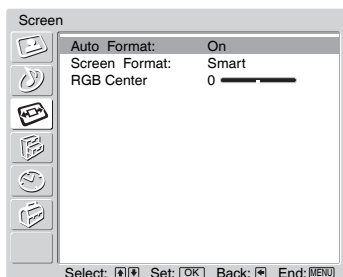

You can select the options listed below on the Screen Control menu. To select options, see “Navigating through menus” (page 19).

Auto Format

Automatically changes the screen format according to the broadcast signal.

- 1 Press OK to select “Auto Format”.
- 2 Press ↓/↑ to select “On,” then press OK.

Tips

- Even if you have selected “On” or “Off” in “Auto Format”, you can always modify the format of the screen by pressing  repeatedly.
- “Auto Format” is available for PAL and SECAM signals only.

Screen Format

For details about the screen format, see (15).



- 1 Press OK to select “Screen Format”.
- 2 Press ↓/↑ to select “Wide,” “Smart,” “4:3,” “14:9” or “Zoom” (see (15) for details), then press OK.

RGB Center

Adjusts the horizontal picture position so that the picture is in the middle of the screen.

- 1 Press OK to select “RGB Center”.
- 2 Press ←/→ to adjust the centre of the picture between -5 and +5, then press OK.

Tip



This option is only available if an RGB source has been connected to the Scarts connectors  1 or  2 on the rear of the TV.

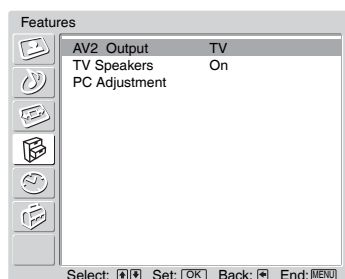



Features menu



You can select the options listed below on the Features menu. To select options, see “Navigating through menus” (page 19).



AV2 Output

Sets a signal to be output through the socket labelled  on the rear of the TV. If you connect a VCR to the  socket, you can then record from the equipment connected to other sockets of the TV.

- 1 Press OK to select “AV2 Output”.
- 2 Press / to select one of the following, then press OK.
 - D-TV: Outputs a digital broadcast.
 - A-TV: Outputs an analogue broadcast.
 - AV1: Outputs signals from equipment connected to the  socket.
 - AV4: Outputs signals from equipment connected to the  socket.
 - Auto: Outputs whatever is being viewed on the screen.

TV Speakers

Turns off the TV speakers e.g. to listen to the sound through external audio equipment connected to the TV.

- 1 Press OK to select “TV Speakers”.
- 2 Press / to select one of the following, then press OK.
 - On: the sound is output from the TV speakers.
 - One Time Off: the TV speakers are temporarily turned off allowing you to listen to the sound from external audio equipment.

Tip

The “TV speakers” option automatically returns to “On” when the TV set is switched off.

- Permanent Off: the TV speakers are permanently turned off allowing you to listen to the sound from external audio equipment.

Tip

To turn on the TV speakers again, change to on.

PC Adjustment

Customizes the TV screen as a PC monitor.

1 Press OK to select “PC Adjustment”.

2 Press ↓/↑ to select one of the following, then press OK.

- Phase: Adjust the screen when a part of a displayed text or image is not clear.
- Pitch: Enlarges or shrinks the screen size horizontally.
- H Center: Moves the screen to the left or to the right.
- V Center: Moves the screen up or down.
- Power saving: Turns to standby mode if no PC signal is received.
- Reset: Resets to the factory settings.

Tip

This option is only available if you are in PC Mode.

Timer menu

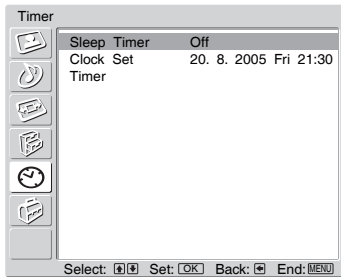

You can select the options listed below on the Timer menu. To select options, see “Navigating through menus” (page 19).

Sleep Timer

Sets a period of time after which the TV automatically switches itself into the standby mode.

- 1 Press OK to select “Sleep Timer”.
- 2 Press ↓/↑ to select the desired time period (“30min”/“60min”/“90min”/“120min”), then press OK.

The Ⓛ indicator on the TV (front) lights up in amber.

Tips

- If you switch off the TV and switch it on again, “Sleep Timer” is reset to “Off.”
- “Sleep timer will end soon. Power will be turned off.” appears on the screen one minute before the TV switches to the standby mode.
- If you press (Ⓛ)/(?), the remaining time in minutes before the TV switches to the standby mode is displayed on the screen.

Clock Set

- 1 Press OK to select “Clock set”.
- 2 Press ↓/↑ to select the day, then press →.
- 3 Set the month, year, and hour in the same way as in step 2.
- 4 Press ↓/↑ to select the minute, then press OK. ←/→

The clock starts.

Timer

Sets a predefined period of time after which the TV automatically switches on/off.

- 1 Press OK to select “Timer”.
- 2 Press ↓/↑ to select “Set”, then press OK.
- 3 Press → to select the desired period (“One Day”, “Daily”, “Mon-Fri” or “Weekly”), then press OK.
- 4 Press ↓/↑ to select “On Time” or “Off Time”, then press OK.
- 5 Press ↓/↑ to active. Press →, then press ↓/↑/←/→ to set time you wish to switch on/off the TV. Press OK to confirm.

Set Up menu

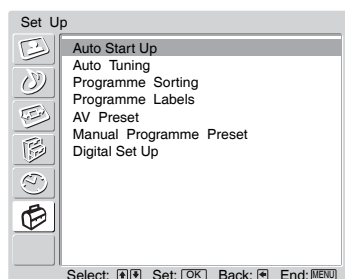

You can select the options listed below on the Set Up menu. To select options, see “Navigating through menus” (page 19).

Auto Start Up

Starts the “first time operation menu” to tune in all the available digital and analogue channels. Usually you do not need to do this operation because the channels are already tuned when the TV was first installed ((page 13)). However, this option allows you to repeat the process (e.g., to retune the TV after moving house, or to search for new channels that have been launched by broadcasters).

- 1 Press OK to select “Auto Start Up”.
- 2 Press OK to select “Yes.”
The auto-tune display appears on the screen.
- 3 Follow steps 1 to 4 of “Auto-tuning the TV” (13).

Auto Tuning (Analogue mode only)

Tunes in all the available analogue channels. Usually you do not need to do this operation because the channels are already tuned when the TV was first installed (13). However, this option allows you to repeat the process (e.g., to retune the TV after moving house, or to search for a new channels that have been launched by broadcasters).

- 1 Press OK to select “Auto Tuning”.
- 2 Follow step 1 and 2 of “Auto-tuning the TV” (13).
When all available analogue channels have been tuned, the TV returns to normal operation.

Programme Sorting (Analogue mode only)

Changes the order in which the analogue channels are stored on the TV.

- 1 Press OK to select “Programme Sorting”.
- 2 Press \uparrow/\downarrow to select the channel you want to move to a new position, then press OK.
- 3 Press \uparrow/\downarrow to select the new position for your channel, then press OK.
Repeat the procedure in steps 2 and 3 to move other channels if required.

Continued

Programme Labels (Analogue mode only)

Assigns a channel name of your choice up to five letters or numbers. The name will be displayed briefly on the screen when the channel is selected. (Names for channels are usually taken automatically from Analogue Text (if available).)

- 1 Press OK to select "Programme Labels".
- 2 Press **↑/↓** to select the channel you want to name, then press OK.
- 3 Press **↑/↓/←/→** to select the desired letter or number ("□" for a blank space), then press OK.
If you input a wrong character
Press **↑/↓/←/→** to select **☒/☒** and press OK repeatedly until the wrong character is selected. Then, press **↑/↓/←/→** to select the correct character and press OK.
- 4 Repeat the procedure in step 3 until the name is complete.
- 5 Press **↑/↓/←/→** to select "End," then press OK.

AV Preset

Do the following options.

- 1 Press OK to select "AV Preset".
- 2 Press **↑/↓** to select the desired input source, then press OK.
- 3 Press OK. Then press **↑/↓** to select the desired option below, then press OK.

Option	Description
Label	<p>Assigns a name to any equipment connected to the side and rear sockets. The name will be displayed briefly on the screen when the equipment is selected.</p> <p>Press ↑/↓ to select one of the following, then press OK. AV1 (or AV2/AV3/AV4/PC/HDMI) VIDEO/DVD/CABLE/ GAME/CAM/SAT: Uses one of these preset labels.</p> <p>Edit: Creates your own label. Follow steps 3 through 5 of Programme Labels (page 30).</p> <p>Skip: Skips an input source that is not connected to any equipment when you press ↑/↓ to select the input source. After selecting this option, press OK.</p> <p>Sound Offset: Sets an independent volume level to each equipment connected to the TV. Press → to select "Sound Offset", then press OK. Press ↑/↓ to select the desired volume level.</p>

Manual Programme Preset (Analogue mode only)

Before selecting "Label"/"AFT"/"Audio Filter"/"Skip"/"ATT", press PROG +/- to select the programme number with the channel. You cannot select a programme number that is set to skip (page 32).

- 1 Press OK to select "Manual Programme Preset".
- 2 Press **↑/↓** to select one of the following options, then press OK.

Option	Description
Programme	Presets programme channels manually.
Channel	<p>1 Press ↑/↓ to select “Programme”, then press OK.</p> <p>2 Press ↑/↓ to select the programme number you want to manually tune (if tuning a VCR, select channel 0), then press ←.</p> <p>3 Press ↑/↓ to select “Channel”, then press OK.</p> <p>4 Tune the channels as follows:</p> <p>If you do not know the channel number (frequency) Press ↑/↓ to search for the next available channel. When a channel has been found, the search will stop. To continue searching, press ↑/↓.</p> <p>If you know the channel number (frequency) Press the number buttons to enter the channel number of the broadcast you want or your VCR channel number.</p> <p>5 Press OK.</p> <p>6 Press OK to select “Confirm”, then press OK.</p> <p>Repeat the procedure above to preset other channels manually.</p>
Label	<p>Assigns a name of your choice, up to five letters or numbers, to the selected channel. This name will be displayed briefly on the screen when the channel is selected.</p> <p>1 Follow steps 3 to 5 of “Programme Labels” (page 30).</p> <p>2 Press OK to select “Confirm”, then press OK.</p>
AFT	<p>Fine-tunes the selected programme number manually if you feel that a slight tuning adjustment will improve the picture quality. (Normally, fine tuning is performed automatically.)</p> <p>1 Press ↑/↓ to adjust the fine tuning over a range of -15 to +15, then press OK.</p> <p>2 Press “OK” twice.</p> <p>To restore automatic fine tuning, select “On” in step 1.</p>
Audio Filter	<p>Improves the sound for individual channels in the case of distortion in mono broadcasts. Sometimes a non-standard broadcast signal can cause sound distortion or intermittent sound muting when watching mono programmes.</p> <p>1 Press ↓/↑ to select “Low” or “High”, then press OK. If you do not experience any sound distortion, we recommend that you leave this option set to the factory setting “Off”.</p> <p>2 Press OK to select “Confirm”, then press OK.</p> <p>Note You cannot receive stereo or dual sound when “Low” or “High” is selected.</p>

Continued

Option	Description
Skip	Skips unused analogue channels when you press PROG +/- to select channels. (You can still select a skipped channel using the number buttons.) 1 Press ↑/↓ to select “Yes”, then press OK. 2 Press OK to select “Confirm”, then press OK. To restore a skipped channel, select “No” in step 1.
ATT	Attenuates the RF signal. In case of a strong RF signal, some video interference may be displayed. 1 Press ↓/↑ to select “On”, then press OK. 2 Press OK to select “Confirm”, then press OK. Tip This option cannot be used if “AV2 Output” is set to “D-TV” (page 26).

Digital Set Up

Displays the “Digital Set Up” menu. You can change/set the digital settings using this menu.

- 1 Press OK to select “Digital Set Up”.
- 2 Press **↓/↑** to select the desired icon below, then press OK.

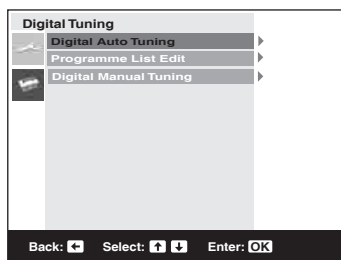

Digital Tuning menu

- 3 Press **↓/↑** to select one of the following options, then press OK.

Option	Description
Digital Tuning	Tunes in all the available digital channels.
Digital Auto Tuning	Usually you do not need to do this operation because the channels are already tuned when the TV was first installed (page 13). However, this option allows you to repeat the process (e.g., to retune the TV after moving house, or to search for new channels that have been launched by broadcasters). 1 Press OK to start digital auto-tuning. When all available digital channels have been tuned, a message stating that the auto-tuning process is finished appears. 2 Press ← .

Option	Description
Programme List Edit	<p>Removes any unwanted digital channels stored on the TV, and changes the order of the digital channels stored on the TV.</p> <ol style="list-style-type: none"> Press ↓/↑ to select the channel you want to remove or move to a new position. <p>If you know the channel number (frequency) Press the number buttons to enter the three-digit programme number of the broadcast you want.</p> <p>To display the previous or next five channels Press the red button (previous) or the green button (next).</p> Remove or change the order of the digital channels as follows: <p>To remove the digital channel Press OK. A message that confirms whether the selected digital channel is to be deleted appears. Press ← to select “Yes”, then press OK.</p> <p>To change the order of the digital channels Press →, then press ↓/↑ to select the new position for the channel and press OK. Repeat the procedure in step 2 to move other channels if required.</p> Press ←.
Digital Manual Tuning	<p>Tunes the digital channels manually.</p> <ol style="list-style-type: none"> Press the number button to select the channel number you want to manually tune, then press ↓/↑ to tune the channel. When the available channels are found, press ↓/↑ to select the channel you want to store, then press OK. <p>To display the previous or next five channels Press the red button (previous) or the green button (next).</p> Press ↓/↑ to select the programme number where you want to store the new channel, then press OK. <p>Repeat the procedure above to tune other channels manually.</p>
Digital Set-up	<p>Displays digital subtitles on the screen.</p>
Subtitle Setting	<p>Press ↓/↑ to select “Off”, “Basic”, or “For Hard of Hearing”, then press OK.</p> <p>When “For hard of hearing” is selected, some visual aids may also be displayed with the subtitles (if TV channels broadcast such information).</p>
Subtitle Language	<p>Selects which language subtitles are displayed in.</p> <p>Press ↓/↑ to select the language, then press OK.</p>
Audio Language	<p>Selects the language used for a programme. Some digital channels may broadcast several audio languages for a programme.</p> <p>Press ↓/↑ to select the audio language, then press OK.</p>
Audio Type	<p>Increases the sound level (only for Hard of Hearing).</p> <p>Press ↓/↑ to select “Basic” or “For Hard of Hearing”, then press OK.</p>

Continued

Option	Description
Parental Lock	<p>Sets an age restriction for programmes. Any programme that exceeds the age restriction can only be watched after a PIN Code is entered correctly.</p> <ol style="list-style-type: none"> Press the number buttons to enter your existing PIN code. If you have not previously set a PIN, a message appears to inform you. Press OK, then follow the instruction of “PIN code” below. Press ↓/↑ to select the age restriction or “None” (for unrestricted watching), then press OK. Press ←.
PIN Code	<p>Sets a PIN code for the first time, or to change your PIN code.</p> <ol style="list-style-type: none"> Enter a PIN as follows: If you have previously set a PIN Press the number buttons to enter your existing PIN. If you have not set a PIN: Press the number buttons to enter the factory setting PIN of 9999. Press the number buttons to enter the new PIN code. When requested, press the number buttons to enter the new PIN again for confirmation. A message appears to inform you that the new PIN has been accepted. Press ←. <p>Tip PIN code 9999 is always accepted.</p>
Technical Set-up	<p>Displays the Technical Set-up menu. Do the following options.</p> <ol style="list-style-type: none"> Press ↓/↑ to select the desired option, then press OK. <ul style="list-style-type: none"> Auto Service Update: Enables the TV to detect and store new digital services as they become available. Software download: Enables the TV to automatically receive software updates, free through your existing aerial (when issued). Sony recommends that this option is set to “On” at all times. If you do not want your software to be updated, set this option to “Off”. System Information: Displays the current software version and the signal level. Instead of step 2, Press ←. Press ↓/↑ to select the “On”, then press OK.
CA Module Set-up	<p>This option will allow you to access a Pay Per View service once you obtain a Conditional Access Module (CAM) and a view card. See page 36 for the location of the MODEM and  (PCMCIA) sockets.</p>

Connecting optional equipment

You can connect a wide range of optional equipment to your TV. Connecting cables are not supplied.

Connecting to the side of the TV

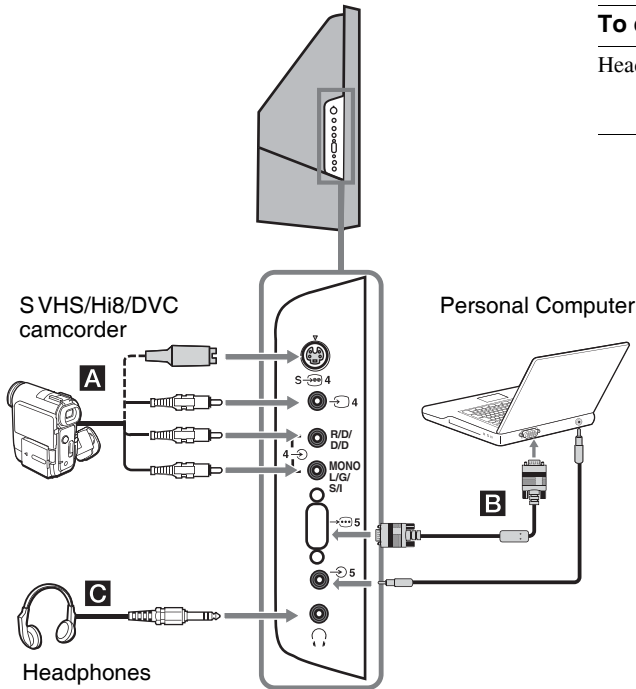





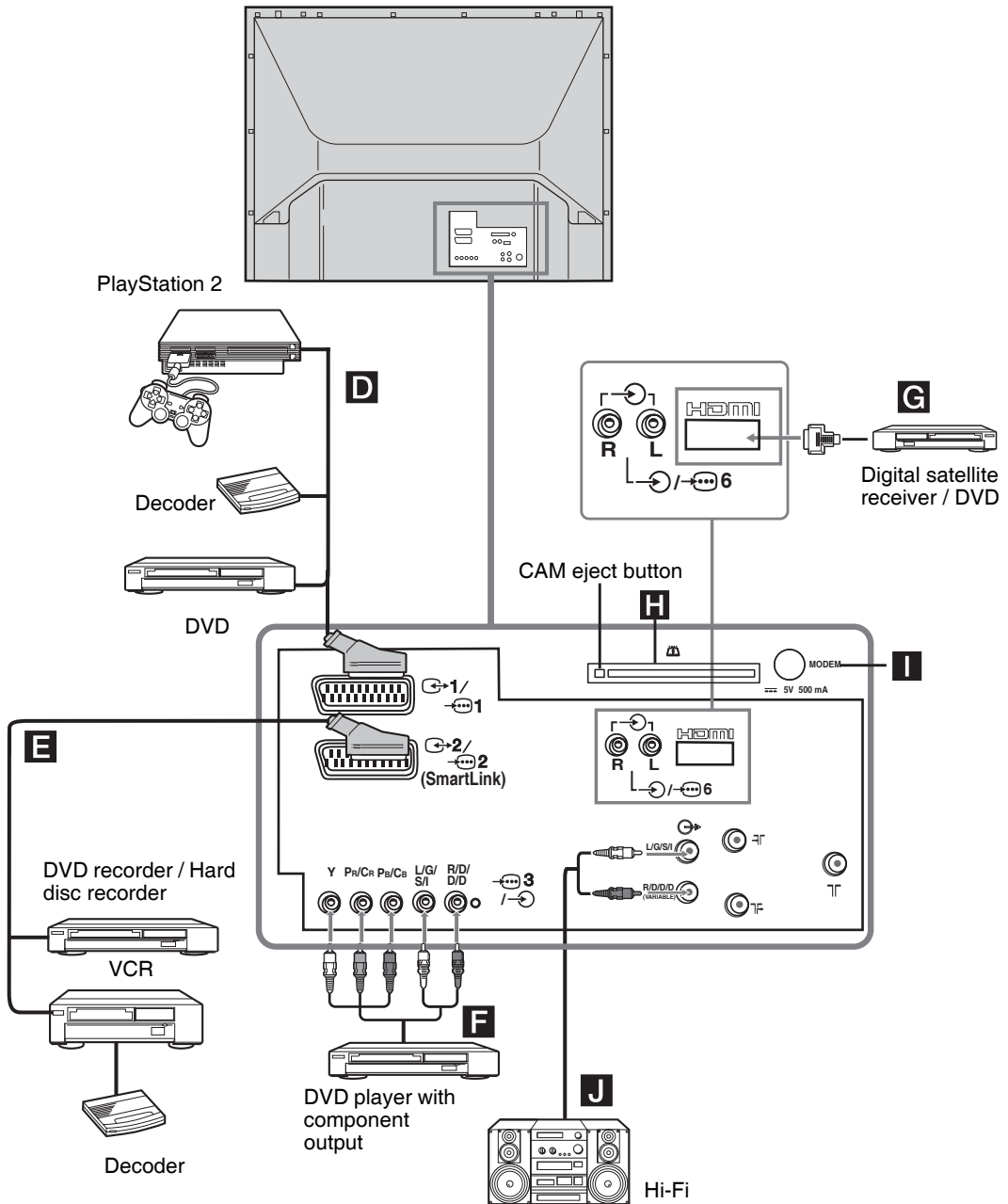

To connect	Do this
Headphones C	Connect to the socket to listen to sound from the TV on headphones.

To connect	Do this
S VHS/Hi 8/DVC camcorder A	Connect to the S video socket 4 or the video socket 4, and the audio sockets 4. To avoid picture noise, do not connect the camcorder to the video socket 4 and the S video socket 4 at the same time. If you connect mono equipment, connect to the L/G/S/I sockets 4, and set "Dual Sound" to "A" (page 24).
Personal Computer B	Connect to the PC Input socket 5 and the audio socket 5.
Note:	It is recommended to use a PC cable with ferrites.

Connecting to the rear of the TV



To connect	Do this
“PlayStation 2”, DVD player or decoder D	Connect to the scart socket   1. When you connect the decoder, the scrambled signal from the TV tuner is output to the decoder, then the unscrambled signal is output from the decoder.
DVD recorder or VCR that supports SmartLink E	Connect to the scart socket   2. SmartLink is a direct link between the TV and a VCR/DVD recorder. For more information on SmartLink, refer to the instruction manual supplied with your VCR or DVD recorder.
DVD player with component output F	Connect to the component socket  3 and the audio sockets  3. The component signal containing 576p signal format and audio signal are input from the DVD player.
Digital satellite receiver G	Connect only to the HDMI IN 6 socket. The digital video and audio signals are input from the digital satellite receiver. If the digital satellite receiver has a DVI socket and not an HDMI socket, connect the DVI socket to the HDMI IN 6 socket, and connect the audio socket to the audio sockets HDMI IN 6. The digital video and analogue audio signals are input from the digital satellite receiver.
CAM (Conditional Access Module) H For encrypted PPV (Pay per View) services.	Remove the dummy card from the CAM slot and insert the CAM. Insert the viewing card into the CAM.
Notes:	
	<ul style="list-style-type: none"> • Switch off the TV before inserting the CAM. • Keep always the dummy card into the CAM slot when you remove the CAM.
Modem connector I	For future use only.
Hi-Fi audio equipment J	Connect to the audio output sockets  to listen to the sound from the TV on Hi-Fi audio equipment. To turn off the sound of the TV speakers, set “Speaker” to “Off” (page 26).

Continued

Optimum Viewing Area

For the best picture quality, try to position the TV set so that you can view the screen from within the areas shown below.

Horizontal viewing area

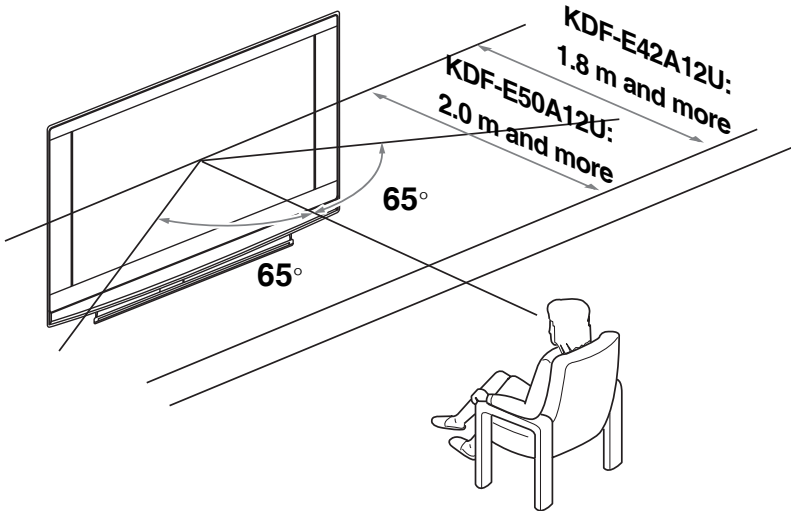

Vertical viewing area

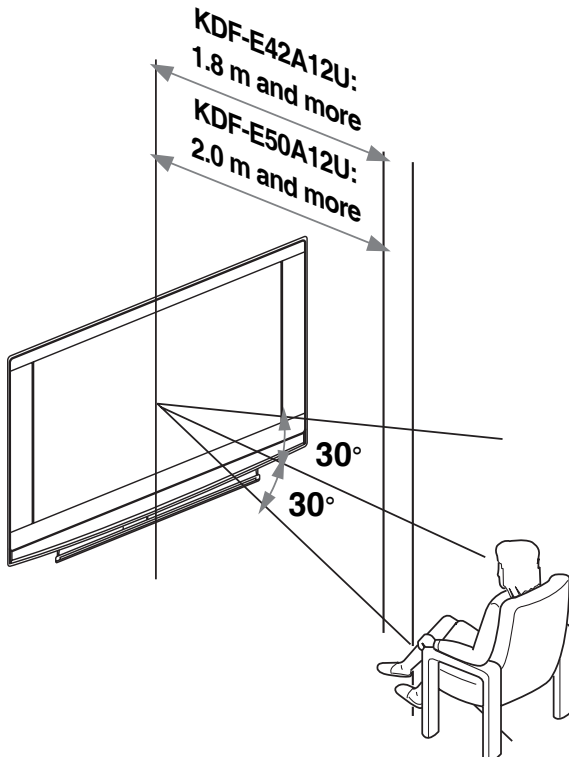

Replacing the lamp

When the lamp becomes dark or the picture colour is not normal or the lamp indicator  on the TV set flashes, replace with a new lamp.

Tips

- Only use the lamp XL-2400 for replacement. If you use another lamp, it may cause damage to the TV set.
- Do not remove the lamp except when replacing it.
- Before replacing the lamp, turn off the power and disconnect the power cord.
- Replace the lamp only after it becomes cool. The front glass of the lamp remains at least 100 °C (212 °F) even after the power has been turned off for 30 minutes.
- Do not place the old lamp in proximity to children or flammable material.
- Do not get the old lamp wet, or insert objects inside the lamp. It may cause the lamp to explode.
- Do not place the old lamp near easily flammable objects, as this may cause fire. Also, do not put your hand inside the lamp compartment, as you may be burned.
- Attach the new lamp securely. If it is not securely attached, the picture may become dark.
- Do not touch or stain the front glass of the new lamp or the glass of the lamp compartment. If the glass become dirty, the picture quality may deteriorate or the lamp life may shorten.
- Attach the lamp cover firmly. If it is not firmly attached, the power will not turn on.
- When the lamp burns out, a noise is audible. This does not indicate damage to the TV set.
- Consult your nearest Sony service center to obtain a new lamp.
- Always remember to dispose of used lamps in an environmentally friendly way.

1 Turn off the power and disconnect the power cord.

If you start changing the lamp without disconnecting the power cord, the standby indicator  on the TV set flashes. Disconnect the power cord to continue changing the lamp.

2 Replace the lamp 30 minutes or more after the power is turned off to allow it to cool.

3 Take the new lamp out of the box.

Do not touch the glass portion of the new lamp.

Tips

- Do not shake the lamp. Vibration can damage the lamp or shorten its life.
- Avoid touching the front glass of a new lamp or the glass of the lamp receptacle. This may reduce picture quality or lamp life.

4 Remove the outside lamp cover

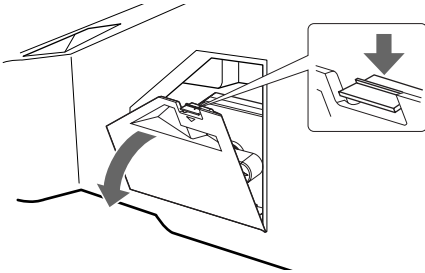

5 Remove the lamp door.

Turn the knob counterclockwise to OPEN and pull out the cover.

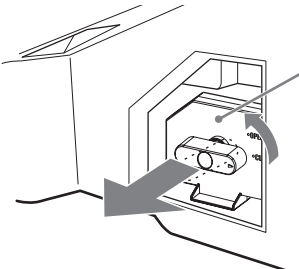

6 Pull out the lamp.

Hook a finger through the loop of the lamp handle and pull the handle upwards. Then pull the lamp straight out.

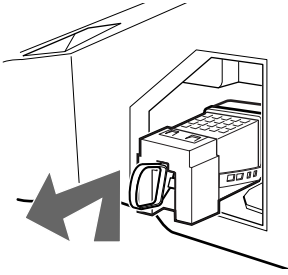

Tips

- The lamp is very hot immediately after use. Never touch the glass portion of the lamp or the surrounding parts.
- After the used lamp has cooled, place it into the empty box of the replacement lamp. Never put the used lamp into a plastic bag.

7 Put the new lamp into its place.

Mount the new lamp securely. Failure to do so may cause a fire or the screen to go dark.

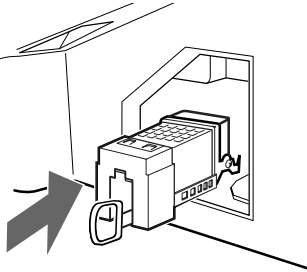

Tip

- If the lamp is not securely reattached, the self-diagnostic function may be triggered and the POWER/STANDBY indicator flashes three times (see page 9).

8 Reattach the lamp door.

Turn the knob back to CLOSE and secure the cover.

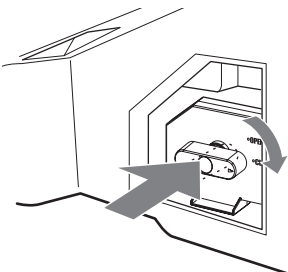

9 Put the outside lamp cover back in its place.

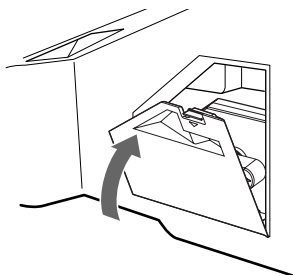

Tips

- Consult your Sony dealer for a Sony XL-2400 replacement lamp.
- Take great care when replacing the lamp or plugging in/unplugging the connecting cords. Rough handling may cause the TV to fall, damaging the TV, the TV stand and the floor.

Specifications

Display Unit

Power Requirements:

220–240 V AC, 50 Hz

Screen Size:

KDF-E50A12U: 50 inches

KDF-E42A12U: 42 inches

Display Resolution (horizontal x vertical):

1280 dots x 720 lines

Power Consumption:

180 W

Standby Power Consumption:

1 W or less

Dimensions (w × h × d):

KDF-E50A12U:

Approx. 825 x 1180 x 395 mm

KDF-E42A12U:

Approx. 720 x 1000 x 350 mm

Weight:

KDF-E50A12U:

Approx. 29.6 kg

KDF-E42A12U:

Approx. 25.1 kg

Panel System

LCD (Liquid Crystal Display) Panel

TV System

I.

Colour System

PAL, SECAM

NTSC 3.58, 4.43 (only Video In)

MPEG-2 MP@ML















Aerial

75 ohm external terminal for VHF/UHF

Channel Coverage

I: UHF B21–B69

Terminals

- AV1:  /  1
21-pin Scart connector (CENELEC standard) including audio/video input, RGB input, and TV audio/video output.
- AV2:  /  2 (SMARTLINK)
21-pin Scart connector (CENELEC standard) including audio/video input, RGB input, selectable audio/video output, and SmartLink interface
- AV3:  3
Y: 1 Vp-p, 75 ohms, 0.3V negative sync
Pb: 0.7 Vp-p, 75 ohms
Pr: 0.7 Vp-p, 75 ohms
 3 Audio input (phono jacks)
500 mVrms
Impedance: 47 kilo ohms
- AV4:  4S video input (4-pin mini DIN)
 4 Video input (phono jack)
 4 Audio input (phono jacks)
- AV5:  5
PC Input (15 Dsub) (see page 36)
G: 0.7 Vp-p, 75 ohms, non Sync on Green
B: 0.7 Vp-p, 75 ohms, non Sync on Green
R: 0.7 Vp-p, 75 ohms, non Sync on Green
HD: 1-5 Vp-p
VD: 1-5 Vp-p
 PC audio input: minijack.
-  Audio output (Left/Right) (phono jacks)
- AV6:  6
HDMI: Video: 480i, 576i, 480p, 576p, 720p, 1080i
Audio: Two channel linear PCM 32, 44.1 and 48 kHz, 16, 20 and 24 bits.
AUDIO: 500 mVrms (100% modulation)
Impedance: 47 kilohms
-  Headphones jack

Sound Output

10 W +10 W (RMS)

Supplied Accessories

- Remote RM-ED002 (1)
- Size AA batteries (R6 type) (2)
- Coaxial Cable (1)

Optional Accessories

- TV stand SU-RG11S (KDF-E42A12U)
- TV stand SU-RG11M (KDF-E50A12U)
- Lamp: XL-2400

Design and specifications are subject to change without notice.

PC Input Specifications

PC Input Timing

Input signal frequency:

Horizontal: 31,4 - 48,4 KHz.

Vertical: 59 - 61 Hz.

Maximum Resolution: 1024 dots x -768 lines.

Preset mode timing table for PC

Nº	Resolution (dots x lines)	Graphic mode	Horizontal frequency (kHz)	Vertical frequency (Hz)
1	640 x 480	VESA 60	31.469	59.940
2	800 x 600	VESA 60	37.879	60.317
3	1024 x 768	VESA 60	48.363	60.004

This TV does not support Sync on Green or Composite Sync.



If a signal other than in the above chart is input, it may not be displayed properly or may not be displayed as you set. Using the Vertical frequency (Hz) of the personal computer at 60 is recommended.

Troubleshooting

Check whether the  (standby) indicator is flashing in red.

When it is flashing





The self-diagnosis function is activated.



- 1 Measure how long the  (standby) indicator flashes and stops flashing.
For example, the indicator flashes for two seconds, stops flashing for one second, and flashes for two seconds.
- 2 Press  on the TV (Front side) to switch it off, disconnect the mains lead, and inform your dealer or Sony service centre of how the indicator flashes (duration and interval).

When it is not flashing



- 1 Check the items in the tables below.
- 2 If the problem still persists, have your TV serviced by qualified service personnel.

Picture

Problem	Cause/Remedy
No picture (screen is dark) and no sound	<ul style="list-style-type: none">• Check the aerial connection.• Connect the TV to the mains, and press  on the TV (front side).• If the  (standby) indicator lights up in red, press TV .
No picture or no menu information from equipment connected to the scart connector	<ul style="list-style-type: none">• Check that the optional equipment is on and press / repeatedly until the correct input symbol is displayed on the screen.• Check the connection between the optional equipment and the TV.
Distorted picture	<ul style="list-style-type: none">• When installing optional equipment, leave some space between the optional equipment and the TV.• When changing programmes or selecting digital/analogue Text, turn off any equipment connected to the scart connector on the rear of the TV.
Double images or ghosting	<ul style="list-style-type: none">• Check aerial/cable connections.• Check the aerial location and direction.
Only snow and noise appear on the screen	<ul style="list-style-type: none">• Check if the aerial is broken or bent.• Check if the aerial has reached the end of its serviceable life (three to five years in normal use, one to two years at the seaside).
Picture (dotted lines or stripes) noise	<ul style="list-style-type: none">• Keep the TV away from electrical noise sources such as cars, motorcycles, or hair-dryers.• Make sure that the aerial is connected using the supplied coaxial cable.• Keep the aerial cable away from other connecting cables.• Do not use a 300-ohm twin lead cable as interference may occur.
Picture noise when viewing a TV channel	<ul style="list-style-type: none">• Select “Manual Programme Preset” in the “Set Up” menu and adjust “AFT” (Automatic Fine Tuning) to obtain better picture reception (page 31).• Select “Noise Reduction” in the “Picture Adjustment” menu to reduce the noise in the picture (page 22).
Stripe noise during playback/recording of a VCR	<ul style="list-style-type: none">• Video head interference. Keep your VCR away from the TV.• Leave a space of 30 cm between your VCR and the TV to avoid noise.• Avoid installing your VCR in front of the TV or beside the TV.
Some tiny black points and/or bright points on the screen	<ul style="list-style-type: none">• The picture of a display unit is composed of pixels. Tiny black points and/or bright points (pixels) on the screen do not indicate a malfunction.

Problem	Cause/Remedy
No colour on programmes	<ul style="list-style-type: none"> Select “Reset” in the “Picture Adjustment” menu to return to the factory settings (page 22).
No colour or irregular colour when viewing a signal from the Y, PB/CB, PR/CR jacks of 	<ul style="list-style-type: none"> Check the connection of the Y, PB/CB, PR/CR jacks of . Make sure that the Y, PB/CB, PR/CR jacks of  are firmly seated in their respective sockets.

Sound

Problem	Cause/Remedy
No sound, but good picture	<ul style="list-style-type: none"> Press  +/- or  (Mute). Check that “TV Speakers” is set to “on” in the “Features” menu (page 26).
Noisy sound	<ul style="list-style-type: none"> See the “Picture noise” causes/remedies on page 44.

Channels

Problem	Cause/Remedy
The desired channel cannot be selected	<ul style="list-style-type: none"> Switch between digital and analogue mode and select the desired digital/analogue channel.
Some channels are blank	<ul style="list-style-type: none"> Scrambled/Subscription only channel. Subscribe to the Pay Per View service. Channel is used only for data (no picture or sound). Contact the broadcaster for transmission details.
Digital channel is not displayed	<ul style="list-style-type: none"> Check that the aerial is plugged directly into the TV (not through other equipment). Contact a local installer to find out if digital transmissions are provided in your area. Upgrade to a higher gain aerial.

General

Problem	Cause/Remedy
The TV turns off automatically (the TV enters standby mode)	<ul style="list-style-type: none"> Check if the “Timer” is activated (page 28). If no signal is received or no operation is performed in the TV mode for 10 minutes, the TV automatically switches to standby mode.
The TV turns on automatically	<ul style="list-style-type: none"> Check if the “Timer” is activated (page 28)
Some input sources cannot be selected	<ul style="list-style-type: none"> Select “AV Preset” in the “Set Up” menu and cancel “Skip” of the input source (page 30).
The remote does not function	<ul style="list-style-type: none"> Replace the batteries.
The lamp indicator  on front of the TV set is lit.	<ul style="list-style-type: none"> Turn the TV off. Turn the TV on again, if the lamp indicator is still lit then replace the internal lamp. For details refer to page 39 to 41.

Continued

Index

Numerics

0-9 buttons 8

14:9 15

4:3 15

A

Accessories supplied 10

Aerial, connecting 11

AFT 31

Analogue mode (<S0010>) button 8

ATT 32

Audio Filter 31

Audio Language 33

Audio Type 33

Auto Format 25

Auto Start Up 29

Auto Tuning

analogue and digital channels
13

analogue channels only 29

digital channel only 32

Auto Volume 24

AUX/VIDEO I/C button 8

AV Preset 30

AV2 Output 26

B

Balance 23

Bass 23

BBE 23

Brightness 21

C

CA Module Set-up 34

Category list 16

Channels

auto-tuning 13

selecting 14

Skip 32

Checking the accessories 10

Checking the accessories (Accessories
supplied) 10

Clock Set 28

Colour 21

Colour Tone 22

Coloured buttons 8

Connecting

an aerial/VCR 11

optional equipment 35

Contrast 21

D

Digital Auto Tuning 32

DIGITAL button 8

Digital Manual Tuning 33

Digital Set Up 32

Digital Set-up 33

Digital Text 15

Digital Text (□) button 8

Digital Tuning 32

Dolby Virtual 23

Dual Sound 24

E

Effect (sound effect) 23

EPG (Digital Electronic Programme
Guide) 16

F

Fastext 15

Favourite list 18

Features menu 26

H

Headphones

connecting 35

Hue 21

I

Info (i+) button 8

Input select (←→) button 8, 9

Input signal index table 19

Interactive service 14

Iris 21

L

Label 31

Lamp, replacing 39

M

Manual Programme Preset 30

Manual Timer REC 17

MENU button 8

Mute (⊘) button 8

N

Noise Reduction 22

Number buttons 8

O

OK button 8, 9

P

Parental Lock 34

PC Adjustment 27

Picture Adjustment menu 21

Picture Mode 21

Picture mode (⊙) button 8

PIN Code 34

Power (I) indicator 9

PROG +/- buttons 8, 9

Programme index table 15

Programme Labels 30

Programme List Edit 33

Programme Sorting 29

R

Reminder 17

Remote

overview 8

sensor 9

Reset

picture adjustment 22

sound adjustment 23

RGB Center 25

S

Screen Control menu 25

Screen Format 25

Screen menu 25

Screen mode 15

Screen mode (⊕) button 8

Set Up menu 28

Sharpness 21

Skip 32

Sleep Timer 28

Smart 15

Sound Adjustment menu 23

Sound Effect 23

Sound effect (J) button 8

Specifications 42

Standby (⏻) indicator 9

Subtitle Language 33

Subtitle Setting 33

T

Technical Set-up 34

Text hold (⊞) button 8

Text reveal (?) button 8

Timer list 17

Timer menu 28

Timer REC 16

Treble 23

TV Speakers 26

TV standby (I/C) button 8

V

VCR

connecting 11

recording 16

Volume (△) +/- buttons 8, 9

W

Wide 15

Z

Zoom 15

Free Manuals Download Website

<http://myh66.com>

<http://usermanuals.us>

<http://www.somanuals.com>

<http://www.4manuals.cc>

<http://www.manual-lib.com>

<http://www.404manual.com>

<http://www.luxmanual.com>

<http://aubethermostatmanual.com>

Golf course search by state

<http://golfingnear.com>

Email search by domain

<http://emailbydomain.com>

Auto manuals search

<http://auto.somanuals.com>

TV manuals search

<http://tv.somanuals.com>