

SONY

4-094-487-11

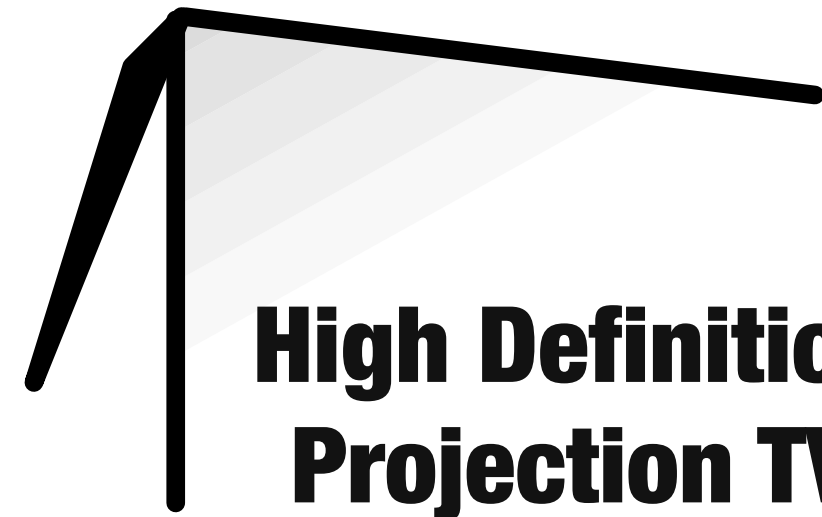

High Definition Projection TV

Operating Instructions

© 2003 Sony Corporation



**KDP-51WS550 KDP-57WS550
KDP-65WS550**

Note on Caption Vision

This television receiver provides display of television closed captioning in accordance with §15.119 of the FCC rules.

Note on Convergence Adjustment

Before you use your projection TV, make sure to adjust convergence. For details, see "Adjusting the Convergence Automatically (Flash Focus)" on page 42.

Use of this television receiver for other than private viewing of programs broadcast on UHF or VHF or transmitted by cable companies for the use of the general public may require authorization from the broadcaster/cable company and/or program owner.

NOTIFICATION

This equipment has been tested and found to comply with the limits for a Class B digital device, pursuant to Part 15 of the FCC Rules. These limits are designed to provide reasonable protection against harmful interference in a residential installation. This equipment generates, uses, and can radiate radio frequency energy and, if not installed and used in accordance with the instructions, may cause harmful interference with radio communications. However, there is no guarantee that interference will not occur in a particular installation. If this equipment does cause harmful interference to radio or television reception, which can be determined by turning the equipment off and on, the user is encouraged to try to correct the interference by one or more of the following measures:

- Reorient or relocate the receiving antenna.
- Increase the separation between the equipment and receiver.
- Connect the equipment into an outlet on a circuit different from that to which the receiver is connected.
- Consult the dealer or an experienced radio/TV technician for help.

You are cautioned that any changes or modifications not expressly approved in this manual could void your authority to operate this equipment.

Safety

- Operate the projection TV only on 120 V AC.
- The plug is designed, for safety purposes, to fit into the wall outlet only one way. If you are unable to insert the plug fully into the outlet, contact your dealer.
- If any liquid or solid object should fall inside the cabinet, unplug the projection TV immediately and have it checked by qualified service personnel before operating it further.
- If you will not be using the projection TV for several days, disconnect the power by pulling the plug itself. Never pull on the cord.
- For details concerning safety precautions, see "Important Safety Instructions" on page 3.

Installing

- To prevent internal heat buildup, do not block the ventilation openings.
- Do not install the projection TV in a hot or humid place, or in a place subject to excessive dust or mechanical vibration.
- Avoid operating the projection TV at temperatures below 5°C (41°F).
- If the projection TV is transported directly from a cold to a warm location, or if the room temperature changes suddenly, the picture may be blurred or show poor color due to moisture condensation. In this case, please wait a few hours to let the moisture evaporate before turning on the projection TV.

- To obtain the best picture, do not expose the screen to direct illumination or direct sunlight. It is recommended to use spot lighting directed down from the ceiling or to cover the windows that face the screen with opaque drapery. It is desirable to install the projection TV in a room where the floor and walls are not of a reflective material.



Trademark Information

TruSurround and the  symbol are trademarks of SRS Labs, Inc. TruSurround technology is incorporated under license from SRS Labs, Inc.

BBE and BBE Symbol are trademarks of BBE Sound, Inc. and are licensed by BBE Sound, Inc. under U.S. Patent No. 4,638,258 and 4,482,866.

Steady Sound, Digital Reality Creation, Caption Vision, CineMotion, Memory Stick, and Twin View are registered trademarks of Sony Corporation. ClearEdge VM, HD Detailer, and Uniform Brightness Screen are trademarks of Sony Corporation. i.LINK is a trademark of Sony Corporation and used only to designate that a product contains an IEEE 1394 connector. All products with an i.LINK connector may not communicate with each other.

For Safety

Be careful when moving the projection TV

When you place the projection TV in position, be careful not to drop it on your foot or fingers.

Watch your footing while installing the projection TV.

Carry the projection TV in the specified manner

If you carry the projection TV in a manner other than the specified manner and without the specified number of persons, it may drop and a serious injury may be caused. Be sure to follow the instructions mentioned below.

- Carry the projection TV with the specified number of persons (see "Carrying Your Projection TV" on page 12).
- Do not carry the projection TV holding the speaker grill.
- Hold the projection TV tightly when carrying it.

The projection TV includes handles that you can use to carry the unit (KDP-65WS550 only).

Important Safety Instructions

- 1 Read these instructions.
- 2 Keep these instructions.
- 3 Heed all warnings.
- 4 Follow all instructions.
- 5 Do not use this apparatus near water.
- 6 Clean only with dry cloth.
- 7 Do not block any ventilation openings. Install in accordance with the manufacturer's instructions.
- 8 Do not install near any heat sources such as radiators, heat registers, stoves, or other apparatus (including amplifiers) that produce heat.
- 9 Do not defeat the safety purpose of the polarized or grounding-type plug. A polarized plug has two blades with one wider than the other. A grounding type plug has two blades and a third grounding prong. The wide blade or the third prong are provided for your safety. If the provided plug does not fit into your outlet, consult an electrician for replacement of the obsolete outlet.
- 10 Protect the power cord from being walked on or pinched particularly at plugs, convenience receptacles, and the point where they exit from the apparatus.
- 11 Only use attachments/accessories specified by the manufacturer.
- 12 Use only with the cart, stand, tripod, bracket, or table specified by the manufacturer, or sold with the apparatus. When a cart is used, use caution when moving the cart/apparatus combination to avoid injury from tip-over.
- 13 Unplug this apparatus during lightning storms or when unused for long periods of time.
- 14 Refer all servicing to qualified service personnel. Servicing is required when the apparatus has been damaged in any way, such as power-supply cord or plug is damaged, liquid has been spilled or objects have fallen into the apparatus, the apparatus has been exposed to rain or moisture, does not operate normally, or has been dropped.



Additional Cleaning Instructions

Clean the cabinet of the projection TV with a dry, soft cloth. To clean the screen of your projection TV, please use only a clean, soft cloth lightly dampened with water. Stubborn stains such as fingerprints can be removed with a clean, soft cloth lightly dampened with a solution of mild soap and warm water. Never use alcohol or strong solvents (such as thinner, benzene, ammonia, or alcohol-based), or abrasive cleaning solutions to clean your TV screen.

If the picture becomes dark after using the projection TV for a long period of time, it may be necessary to clean the inside of the projection TV. Consult qualified service personnel.

Contents

Introducing the Digital Projection TV

<i>Welcome</i>	9
Package Contents	9
Features	9

Setting Up the Digital Projection TV

<i>Overview</i>	11
<i>Carrying Your Projection TV</i>	12
<i>Installing the TV</i>	12
<i>TV Controls and Connectors</i>	13
Front Video Controls	13
Front Panel	14
Rear Panel	16
<i>Basic Connections: Connecting a Cable or Antenna</i>	18
Cable or Antenna Only	19
Cable and Antenna Only	20
Cable Box and Cable Only	21
Cable Box Only	22
<i>Connecting Optional Equipment</i>	23
About Using S VIDEO	23
VCR and Cable	24
VCR and Cable Box	26
Two VCRs for Tape Editing	28
Satellite Receiver	30
Satellite Receiver and VCR	32
DVD Player with Component Video Connectors	34
DVD Player with S VIDEO and Audio Connectors	36
Camcorder	37
Audio Receiver	38
<i>Connecting a Device with an Optical IN Connector</i>	39
<i>Using the CONTROL S Feature</i>	40
<i>Setting Up the Channel List</i>	41
Using Auto Program	41
<i>Adjusting the Convergence Automatically (Flash Focus)</i>	42
Notes on Flash Focus	42
<i>Adjusting the Convergence Manually</i>	43
Notes on Adjusting the Convergence Manually	44

Using the Remote Control

Overview	45
Inserting Batteries.....	45
Button Descriptions	46
Outside Panel	46
Inside Panel	48
Programming the Remote Control	49
Using Other Equipment with Your TV Remote Control	51
All Equipment.....	51
Operating a VCR	51
Operating a Satellite Receiver	51
Operating a Cable Box.....	52
Operating a DVD Player	52
Operating an MDP (Laserdisc Player)	52

Using the Features

Overview	53
Watching TV	54
Using the Scrolling Index	55
Factors Affecting Scrolling Index	55
Using Wide Mode	56
Using Twin View	57
Displaying Twin Pictures	57
Factors Affecting Twin View	57
Activating the Picture	58
Changing the Picture Size	59
Using Favorite Channels	60
Creating a List of Favorite Channels	60
Displaying a List of Favorite Channels	60
Using the Freeze Function	61

Using the Digital Program Guide

Displaying the Digital Program Guide.....	63
Navigating the Digital Program Menus.....	64
Using the Guide Menu	64
Using the Program Options Menu.....	64
Using the Caption Vision Menu	65
Using the Digital Setup Menu	65
Customizing Caption Vision.....	66

Using the Memory Stick Viewer

About Memory Stick	67
Features	67
Memory Stick Compatibility.....	68
File Compatibility.....	68
Trademark Information.....	68
Inserting and Removing a Memory Stick	69
Inserting a Memory Stick	69
Inserting the Memory Stick Duo.....	70
Removing a Memory Stick	71
Using the Memory Stick Index	72
Using the Memory Stick Index	73
Viewing Photos	74
Photo Controls	74
Photo Menu Bar Options	75
Using Zoom and Pan	76
Using Rotate.....	76
Playing Movies	77
Movie Controls.....	77
Movie Menu Bar Options.....	78
Memory Stick Index Menu Bar Options	79
Slide Show Menu Options	79
Folder Menu Options.....	80
Memory Stick Menu	80
Notes on Using Memory Stick Media	81
About DCF File Names.....	81
Memory Stick Precautions.....	82

Using i.LINK

About i.LINK	83
Using i.LINK Cables.....	83
Connecting i.LINK Devices	84
Selecting an i.LINK Device	86
Using the i.LINK Control Panel	87
Notes About Controlling i.LINK Devices	88
i.LINK Setup	89
Notes on i.LINK.....	89

Using the Menus

Overview	91
Navigating Through Menus	91
Using the Video Menu	92
Using the Audio Menu	94
Using the Screen Menu	96
Using the Channel Menu	98
Using the Parent Menu	100
Using the Setup Menu	103

Other Information

Overview	107
Glossary	108
Contacting Sony	109
Troubleshooting	109
Twin View	109
Remote Control	110
Channels	110
Memory Stick	111
Audio	112
Video	113
General	114
Specifications	115
Optional Accessories	116
Index	117

Introducing the Digital Projection TV

Welcome

This chapter describes the contents of the package in which the TV is shipped and provides an overview of the features of your Digital Projection TV.

Package Contents

Along with your new projection TV, the package contains a remote control and two AA batteries. No additional cables are included. These items are all you need to set up and operate the projection TV in its basic configuration.

Most components (VCRs, DVD players, etc.) come with the necessary cables to connect them. If you want to set up a complex system, you may need to buy extra cables, connectors, etc. Be sure to have these on hand before you start to connect your system.

Features

Some of the features that you will enjoy with your new TV include:

- ❑ **Built-in Digital Television Receiver:** You can watch digital television programs and enjoy the improved audio/video quality offered by these programs.
- ❑ **Wide Screen Mode:** Watch conventional 4:3 aspect ratio broadcasts in wide screen (16:9) mode.
- ❑ **High Definition Signal Reception:** Watch TV signals broadcast in HDTV for the clearest possible broadcast picture.
- ❑ **DRC® (Digital Reality Creation) Multifunction V1:** Unlike conventional line doublers, the DRC Multifunction feature replaces the signal's NTSC waveform with the near-HD equivalent, while doubling the number of vertical and horizontal lines. This results in four times the density for quality sources, such as DVD, satellite, and digital camcorders. The Video Menu allows you to select interlaced, progressive, or CineMotion™ output. The DRC Palette option lets you customize the level of detail (Reality) and smoothness (Clarity) to create up to three custom palettes.
- ❑ **Scrolling Index:** Lets you select programs from a series of preview windows that scroll along the right side of the screen.
- ❑ **Favorite Channels:** Allows you to preview and select from sixteen of your favorite channels.

- ❑ **Twin View™**: Using the Multi-Image Driver (MIDX), Twin View allows you to watch two programs side by side, with the ability to zoom in one picture. You can watch pictures from two different sources (1080i, 720p, 480p, and 480i) simultaneously. (Only the left Twin View window can display 1080i, 720p, and 480p sources.)
- ❑ **ClearEdge VM™ Velocity Modulation**: Sharpens picture definition by enhancing vertical lines.
- ❑ **Steady Sound®**: Equalizes volume levels so there is consistent output between programs and commercials.
- ❑ **Memory Stick® Viewer**: Lets you watch digital photo (JPEG) and movie (MPEG1) files that are stored on Memory Stick media.
- ❑ **Component Video Inputs**: Offers the best video quality for DVD (480p, 480i), and digital set-top box (HD1080i, 720p) connections.
- ❑ **HD Detailer™**: Wideband video amplifier has a high bandwidth frequency rating, which allows it to send more video information to the screen, resulting in finer picture quality, especially for HD sources.
- ❑ **CineMotion™**: Reverse 3-2 pulldown processing provides optimal picture quality for film-based sources (media originally shot in 24 frames-per-second format).
- ❑ **Parental Control**: V-Chip technology allows parents to block unsuitable programming from younger viewers.
- ❑ **Digital Visual Interface (DVI)**: Can accommodate a copy-protected digital connection (HDCP*) to other devices (such as digital set-top boxes) that have compatible interfaces. The DVI-HDTV input terminal is compliant with the EIA-861 standard and is not intended for use with personal computers.
- ❑ **i.LINK**: Provides a secure digital interface to other digital home entertainment devices. i.LINK allows for the secure transfer of copyright-protected high-definition content between these devices and your digital projection television.

*High-bandwidth Digital Content Protection

Setting Up the Digital Projection TV

Overview

This chapter includes illustrated instructions for setting up your TV.

<i>Topic</i>	<i>Page(s)</i>
Carrying Your Projection TV	12
Installing the TV	12
TV Controls and Connectors	13-17
Basic Connections: Connecting a Cable or Antenna	18-22
Connecting Optional Equipment	
VCR and Cable	24
VCR and Cable Box	26
Two VCRs for Tape Editing	28
Satellite Receiver	30
Satellite Receiver and VCR	32
DVD Player with Component Video Connectors	34
DVD Player with S VIDEO and Audio Connectors	36
Camcorder	37
Audio Receiver	38
Connecting a Device with an Optical IN Connector	39
Using the CONTROL S Feature	40
Setting Up the Channel List	41
Adjusting the Convergence Automatically (Flash Focus)	42
Adjusting the Convergence Manually (Manual Convergence)	43

Carrying Your Projection TV

Carrying the TV requires four or more people. The TV is equipped with casters for easy movement on a hard surface. Be sure to move your projection TV using the casters. The TV includes handles that you can use to carry the unit (KDP-65WS550 only).

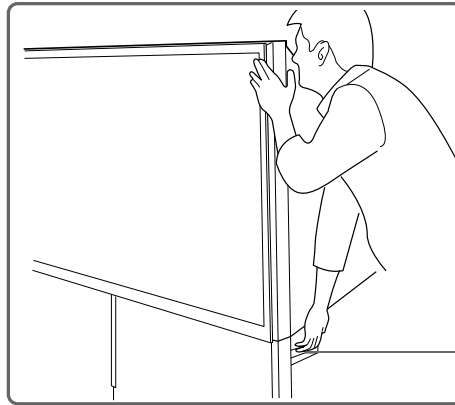

Handle (one on each side)
(KDP-65WS550 only)

Installing the TV

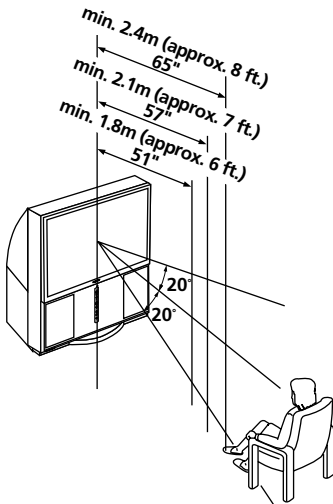

Recommended Vertical Viewing Angle

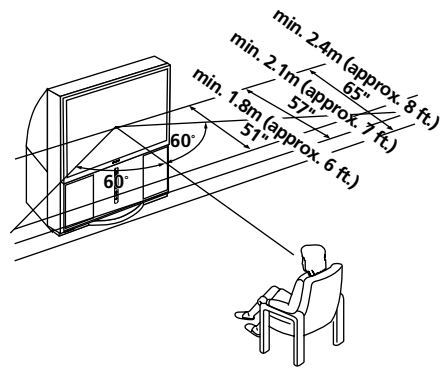

Recommended Horizontal Viewing Angle

TV Controls and Connectors

To access the front video panel, push up and then release. The panel drops down automatically.

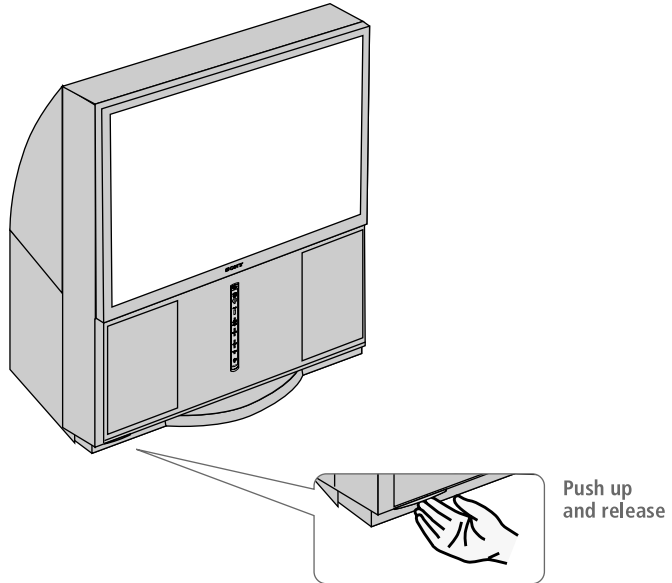

Front Video Controls

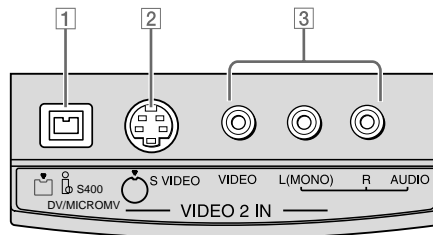

- | | |
|---|---|
| 1 i.LINK | Connects to the i.LINK jack on your i.LINK-compatible portable device. Provides a secure digital connection between your TV and your i.LINK-compatible portable device. |
| 2 S VIDEO
VIDEO 2 INPUT | Connects to the S VIDEO OUT jack on your camcorder or other video equipment that has S VIDEO. Provides better picture quality than composite video (3). |
| 3 VIDEO/L(MONO)-
AUDIO-R
VIDEO 2 INPUT | Connects to the composite A/V output jacks on your camcorder or other video equipment. |

Front Panel

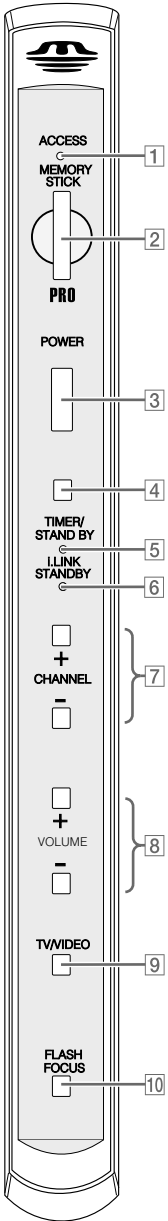

<i>Item</i>	<i>Description</i>
1 MEMORY STICK ACCESS LED	When lit, indicates that the Memory Stick is being read. (Do not remove the Memory Stick when the indicator is lit.)
2 MEMORY STICK	Memory Stick insertion slot. For details, see "Inserting and Removing a Memory Stick" on page 69.
3 POWER	Press to turn on and off the TV.
4 Infrared Receiver (IR)	Receives IR signals from the TV's remote control.
5 TIMER/STAND BY LED	When lit, indicates one of the timers is set. When the timer is set, this LED will remain lit even if the TV is turned off. For details, see page 104.
6 i.LINK STANDBY LED	When lit in orange, indicates that i.LINK Standby is on. For details, see page 105.
7 -CHANNEL+	Press to scan through channels. To scan quickly through channels, press and hold down either CHANNEL button.
8 -VOLUME +	Press to adjust the volume.
9 TV/VIDEO	Press repeatedly to cycle through the video equipment connected to the TV's video inputs.
10 FLASH FOCUS	Press to adjust the convergence (see page 42).

Rear Panel

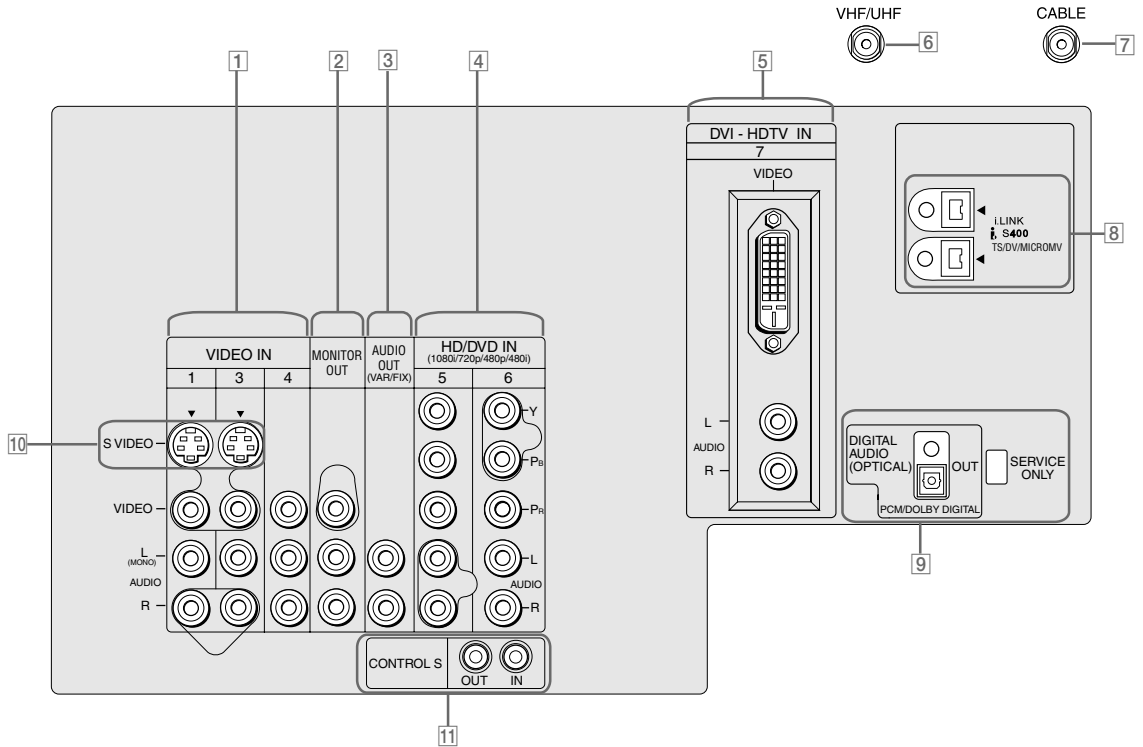

Jack	Description
1 VIDEO IN 1/3/4 VIDEO/L(MONO) -AUDIO-R	Connect to the composite A/V output jacks on your VCR or other video component. A fourth component A/V input jack (VIDEO 2) is located on the front panel of the TV. These video connections provide better picture quality than the VHF/UHF (6) connections.
2 MONITOR OUT	Lets you record the program you are watching to a VCR. When two VCRs are connected, you can use the TV as a monitor for tape-to-tape editing (not available with 480p, 720p, or 1080i when the input is set to VIDEO 5-7).
3 AUDIO OUT (VAR/FIX) L (MONO)/R	Connects to the left and right audio input jacks of your audio or video equipment. You can use these outputs to listen to your TV's audio through your stereo system.
4 HD/DVD IN 5/6 (1080i/720p/480p/480i)	Connect to your DVD player's or digital set-top box's component video (Y, PB, PR) and audio (L/R) jacks. Component video provides better picture quality than 1 , 6 , or 10).
5 DVI-HDTV VIDEO AUDIO R/L (VIDEO 7 IN)	Can accommodate a copy-protected digital connection (HDCP*) to other devices (such as digital set-top boxes) that have compatible interfaces. The DVI-HDTV input terminal is compliant with the EIA-861 standard and is not intended for use with personal computers. See the instruction manual that came with your equipment for details about connecting and using it with the TV.
6 VHF/UHF	RF input that connects to your VHF/UHF antenna or cable box.
7 Cable	RF input that connects to your cable signal.
8 i.LINK	Used for connecting i.LINK-equipped devices.
9 DIGITAL AUDIO OPTICAL OUTPUT (DOLBY DIGITAL PCM)	Connect to the optical audio input of an audio component that is Dolby Digital and PCM compatible.
10 S VIDEO IN 1/3	Connects to the S VIDEO OUT jack of your VCR or other video equipment that has S VIDEO. S VIDEO provides better picture quality than either composite video (1) or VHF/UHF (6) connections.
11 CONTROL S IN/OUT	Allows the TV to receive (IN) and send (OUT) remote control signals to other Sony infrared-controlled audio or video equipment that has the CONTROL S function.

*High-bandwidth Digital Content Protection

Basic Connections: Connecting a Cable or Antenna

The way in which you will connect your TV varies, depending on how your home receives a signal (cable, cable box, antenna) and whether or not you plan to connect a VCR.

<i>If You Are Connecting</i>	<i>See Page</i>
Cable or Antenna Only	19
<input type="checkbox"/> No cable box or VCR	
Cable and Antenna Only	20
<input type="checkbox"/> No cable box or VCR	
Cable Box and Cable Only	21
<input type="checkbox"/> Cable box unscrambles only some channels (usually premium channels)	
<input type="checkbox"/> No VCR	
Cable Box Only	22
<input type="checkbox"/> Cable box unscrambles all channels	
<input type="checkbox"/> No VCR	

If you are connecting a VCR

- See the connections described on pages 24 and 26.

Cable or Antenna Only

For best results, use one of the following connections if you are connecting a cable or an antenna and you:

- ❑ Do not need a cable box to unscramble channels. (If you have a cable box, see pages 21-22.)
- ❑ Do not intend to connect a VCR. (If you have a VCR, see pages 24 and 26.)

The connection you choose depends on the cable type you have in your home, as described below.

75-ohm coaxial cable (usually found in newer homes)

Cable Type

Connect As Shown

VHF Only or
combined
VHF/UHF



Cable

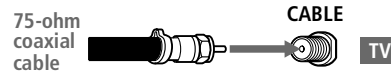

300-ohm twin lead cable (usually found in older homes)

Cable Type

Connect As Shown

VHF Only or
UHF Only or
combined
VHF/UHF

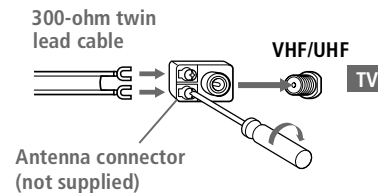

75-ohm coaxial and 300-ohm twin lead cable (found in some homes)

Cable Type

Connect As Shown

VHF and UHF

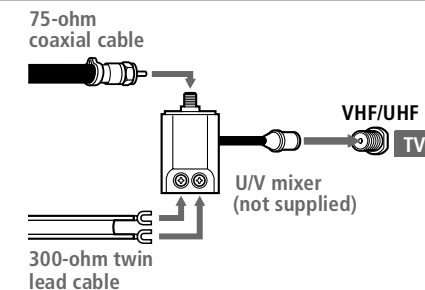

Cable and Antenna Only

For best results, use this connection if you:

- Have a cable and an antenna.
(This is convenient if you are using a separate rooftop antenna to receive additional channels, such as HDTV channels, that are not provided by your cable company.)
- Do not have a cable box or VCR. (if you have a cable box, see pages 21 to 22. If you have a VCR, see pages 24 and 26.)

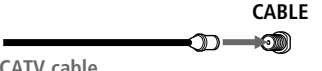
Cable Type	Connect As Shown
Cable TV (CATV) and Antenna	 <p>VHF/UHF</p>
	 <p>CABLE</p> <p>CATV cable</p>

Notes on Using This Connection

To Do This ...	Do This ...
Switch the TV's input between the cable and antenna	Press ANT to switch back and forth between the TV's VHF/UHF and CABLE inputs.

Cable Box and Cable Only

For best results, use this connection if:

- ❑ Your cable company scrambles some channels, such as premium channels (which requires you to use a cable box), but does not scramble all channels.
- ❑ You do not have a VCR. (If you have a VCR, see pages 24 and 26.)

With this connection you can:

- ❑ Use the TV remote control to change channels coming through the cable box to the TV's VHF/UHF input jack. (You must first program the remote control for your specific cable box; see "Programming the Remote Control" on page 49.)
- ❑ Use the TV remote control to change channels coming directly into the TV's CABLE input. (The TV's tuner provides a better signal than the cable box.)

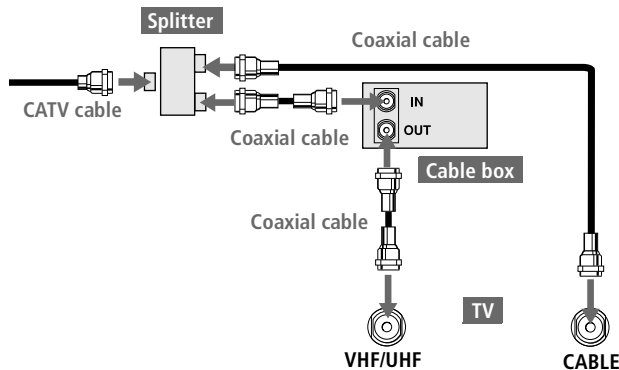

About Using This Connection with Dual Picture (Twin View, etc.) Features

With this connection, you can use all the dual picture features for unscrambled channels coming directly into the TV's CABLE input jack.

Notes on Using This Connection

To Do This ...	Do This ...
Use the cable box	Tune the TV to the channel the cable box is set to (usually channel 3 or 4) and then use the cable box to switch channels.
Set up the TV remote control to operate the cable box	Program the remote control. See "Programming the Remote Control" on pages 49-50.
Activate the remote control to operate the cable box	Press SAT/CABLE FUNCTION.
Prevent the accidental switching of TV channels	When using the cable box, you need the TV to stay on the channel the cable box is set to (usually channel 3 or 4). You can use the TV's Channel Fix feature to lock in a specific channel. For details, see "Using the Channel Menu" on page 98.
Switch the TV's input between the cable box and cable	Press ANT to switch back and forth between the TV's VHF/UHF (scrambled channels) and CABLE (unscrambled) inputs.

Cable Box Only

For best results, use this connection if:

- ❑ Your cable company scrambles all channels, which requires you to use a cable box.
- ❑ You do not have a VCR. (If you have a VCR, see pages 24 and 26.)

With this connection you can:

- ❑ Use the TV remote control to change channels coming through the cable box to the TV's VHF/UHF jack. (You must first program the remote control for your specific cable box.)

About Using This Connection with Dual Picture (Twin View, etc.) Features

With this connection, all channels come into the TV through your cable box and only one unscrambled signal is sent to the TV, so you cannot use the dual picture features. If some of your channels are scrambled, but others are not, consider using the "Cable Box and Cable" connection on page 21 instead.

To connect the cable box

- 1 Connect the CATV cable to the cable box's input jack.
- 2 Use a coaxial cable to connect the cable box's output jack to the TV's VHF/UHF jack.
- 3 Run the Auto Setup program, as described in "Setting Up the Channel List" on page 41.

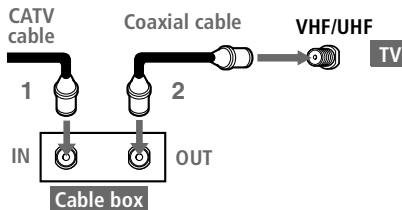

Notes on Using This Connection

To Do This ...	Do This ...
Use the cable box	Tune the TV to the channel the cable box is set to (usually channel 3 or 4) and then use the cable box to switch channels.
Set up the TV remote control to operate the cable box	Program the remote control. See "Programming the Remote Control" on pages 49-50.
Activate the remote control to operate the cable box	Press SAT/CABLE FUNCTION.
Prevent the accidental switching of TV channels	When using the cable box, you need the TV to stay on the channel the cable box is set to (usually channel 3 or 4). You can use the TV's Channel Fix feature to lock in a specific channel. For details, see "Using the Channel Menu" on page 98.

Connecting Optional Equipment

Use the directions in this section to connect the following optional equipment:

<i>If You Are Connecting</i>	<i>See Page</i>
VCR and Cable	24
VCR and Cable Box	26
Two VCRs for Tape Editing	28
Satellite Receiver	30
Satellite Receiver and VCR	32
DVD Player with Component Video Connectors	34
DVD Player with S VIDEO and Audio Connectors	36
Camcorder	37
Audio Receiver	38
Connecting a Device with an Optical IN Connector	39
Using the CONTROL S Feature	40

 **If you want to connect an i.LINK device, see “Connecting i.LINK Devices” on page 84.**

About Using S VIDEO



If the optional equipment you are connecting has an S VIDEO jack (shown at left), you can use an S VIDEO cable for improved picture quality (compared to an A/V cable). Because S VIDEO carries only the video signal, you also need to connect audio cables for sound, as shown below.

Example of an S VIDEO Connection

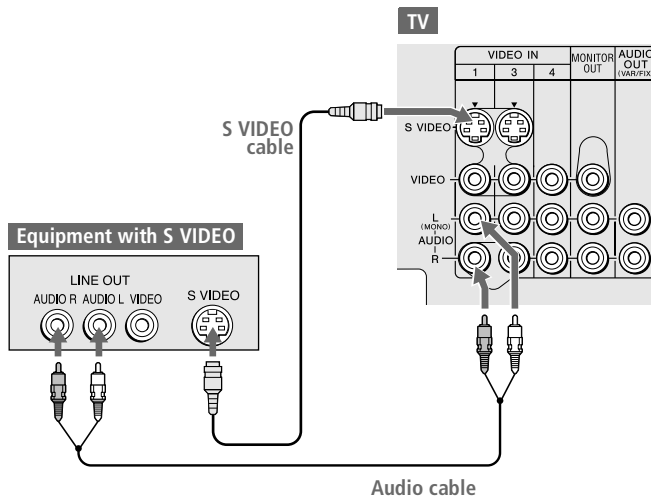

Cables are often color-coded to connectors. Connect red to red, white to white, etc.

VCR and Cable

For best results, use this connection if:

- Your cable company does not require you to use a cable box.

About Using This Connection with Dual Picture (Twin View, etc.) Features

With this connection, you can use all the dual picture features.

To connect the VCR and cable

- 1 Connect the CATV cable to the VCR's VHF/UHF input jack.
- 2 Use a coaxial cable to connect the VCR's VHF/UHF output jack to the TV's CABLE jack.
- 3 Use an A/V cable to connect the VCR's A/V output jacks to the TV's A/V input jacks.
- 4 Run the Auto Setup program, as described in "Setting Up the Channel List" on page 41.



Using
S VIDEO jacks?
See page 23.



Notes on Using This Connection

<i>To Do This ...</i>	<i>Do This ...</i>
Watch the VCR	Press TV/VIDEO repeatedly to select the VCR input (VIDEO 1 in the illustration).
Watch cable channels	Press TV/VIDEO repeatedly to select the cable input (CABLE in the illustration).
Set up the TV remote control to operate the VCR	If you have a non-Sony VCR, you must program the remote control. See "Programming the Remote Control" on pages 49-50.
Activate the TV remote control to operate the VCR	Open the outside cover, as shown on page 48. Then set the A/V slide switch to the position you programmed for the VCR.
Control VCR functions with the TV remote control	See "Operating a VCR" on page 51.
Label video inputs to easily identify equipment connected to the TV	See the instructions for setting up Video Labels on pages 103-104.

VCR and Cable Box

For best results, use this connection if:

- ❑ Your cable company scrambles some channels, such as premium channels (which requires you to use a cable box), but does not scramble all channels.

About Using This Connection with Dual Picture (Twin View, etc.) Features

With this connection, you can use all the dual picture features.

With this connection you can:

- ❑ Use the TV remote control to change channels coming through the cable box. (You must first program the remote control for your specific cable box; see "Programming the Remote Control" on page 49.)
- ❑ Use the TV remote control to change channels coming directly into the TV's CABLE jack. (The TV's tuner provides a better signal than the cable box.)
- ❑ Record channels coming through the cable box and channels coming directly into the TV.

To connect a VCR and cable box, you need:

- ❑ A splitter, which is a small, inexpensive device that you can purchase at your local electronics store.
- ❑ Three coaxial cables.
- ❑ One A/V cable or one S VIDEO cable with audio cables.

To connect the VCR and cable box

- 1 Connect the CATV cable to the single (input) jack of the splitter.
- 2 Use a coaxial cable to connect one of the splitter's two output jacks to the TV's CABLE jack.
- 3 Use a coaxial cable to connect the splitter's other output jack to the cable box's input jack.
- 4 Use a coaxial cable to connect the cable box's output jack to the VCR's RF input jack.
- 5 Use an A/V cable to connect the VCR's A/V output jacks to the TV's A/V input jacks.
- 6 Use a coaxial cable to connect the VCR's RF output jack to the TV's VHF/UHF jack.
- 7 Run the Auto Setup program, as described in "Setting Up the Channel List" on page 41.



Using
S VIDEO jacks?
See page 23.

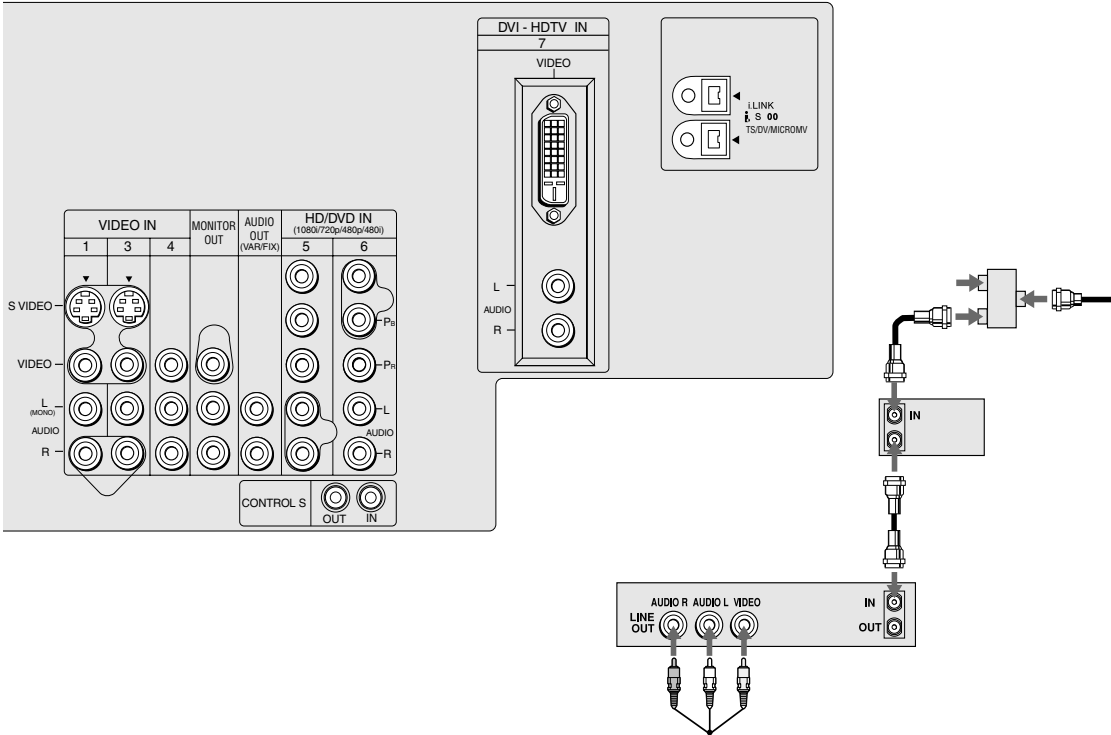

Notes on Using This Connection

To Do This ...	Do This ...
Watch cable (unscrambled) channels	Press TV/VIDEO repeatedly to select the cable input (CABLE in the illustration).
Watch cable box (scrambled) channels	Turn on the VCR and tune it to the channel the cable box is set to (usually channel 3 or 4). Press TV/VIDEO repeatedly to select the VCR input (VIDEO 1 in the illustration). Use the cable box to change channels.
Watch the VCR	Press TV/VIDEO repeatedly to select the VCR input (VIDEO 1 in the illustration).
Set up the TV remote control to operate the cable box or VCR	If you have a non-Sony VCR, you must program the remote control. See "Programming the Remote Control" on pages 49-50.
Activate the remote control to operate the cable box or VCR	For the cable box, press SAT/CABLE FUNCTION. For the VCR, open the outside cover, as shown on page 48. Then set the A/V slide switch to the position you programmed for the VCR.
Control specific cable box and VCR functions with the TV remote control	See "Operating a Cable Box" on page 52 and "Operating a VCR" on page 51.
Label video inputs to easily identify equipment connected to the TV	See the instructions for setting up Video Labels on pages 103-104.

Two VCRs for Tape Editing



Using
S VIDEO jacks?
See page 23.

Connecting two VCRs lets you record from one VCR to the other. By connecting them as shown below, you can view (monitor) what is being recorded.

To connect two VCRs for tape editing

- 1 Use an A/V cable to connect the playback VCR's A/V output jacks to the TV's A/V input jacks.
- 2 Use an A/V cable to connect the recording VCR's A/V input jacks to the TV's MONITOR OUT jacks.

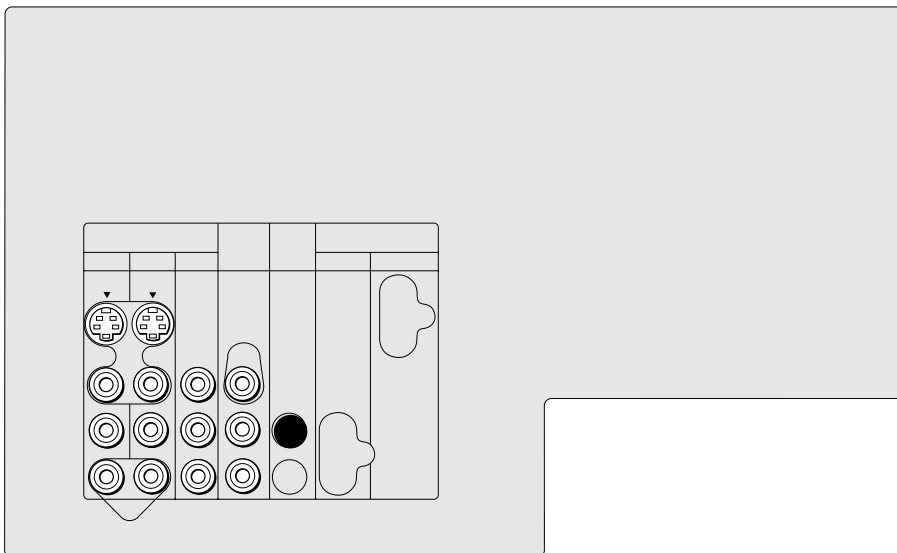

Notes on Using This Connection

<i>To Do This ...</i>	<i>Do This ...</i>
View (monitor) what is being recorded	Press TV/VIDEO repeatedly to select the VCR input (VIDEO 1 in the illustration above).
Set up the TV remote control to operate the VCR(s)	If you have a non-Sony VCR, you must program the remote control. See "Programming the Remote Control" on pages 49-50.
Activate the TV remote control to operate the VCR(s)	Open the outside cover, as shown on page 48. Then set the A/V slide switch to the position you programmed for the VCR.
Control VCR functions with the TV remote control	See "Operating a VCR" on page 51.
Label video inputs to easily identify equipment connected to the TV	See the instructions for setting up Video Labels on pages 103-104.

Satellite Receiver

To connect a satellite receiver

- 1 Connect the satellite antenna cable to the satellite receiver's satellite input jack.
- 2 Use an A/V cable to connect the satellite receiver's A/V output jacks to the TV's A/V input jacks.
- 3 Connect a cable from your cable or antenna to the TV's CABLE or VHF/UHF jack.
- 4 Run the Auto Setup program, as described in "Setting Up the Channel List"

Notes on Using This Connection

<i>To Do This ...</i>	<i>Do This ...</i>
Watch the satellite receiver	Press TV/VIDEO repeatedly to select the satellite receiver input (VIDEO 1 in the illustration).
Set up the TV remote control to operate the satellite receiver	If you have a non-Sony satellite receiver, you must program the remote control. See "Programming the Remote Control" on pages 49-50.
Activate the TV remote control to operate the satellite receiver	Press SAT/CABLE FUNCTION.
Control satellite receiver functions with the TV remote control	See "Operating a Satellite Receiver" on page 51.
Label video inputs to easily identify equipment connected to the TV	See the instructions for setting up Video Labels on pages 103-104.

Satellite Receiver and VCR



Using
S VIDEO jacks?
See page 23.

To connect a satellite receiver and VCR

- 1 Connect the satellite antenna cable to the satellite receiver's satellite input jack.
- 2 Connect the CATV cable to the VCR's VHF/UHF input jack.
- 3 Use a coaxial cable to connect the VCR's VHF/UHF output jack to the TV's CABLE jack.
- 4 Use an A/V cable to connect the satellite receiver's A/V output jacks to the VCR's A/V input jacks.
- 5 Use an A/V cable to connect the VCR's A/V output jacks to the TV's A/V input jacks.
- 6 Run the Auto Setup program, as described in "Setting Up the Channel List" on page 41.

Notes on Using This Connection

To Do This ...	Do This ...
Watch the satellite receiver	Press TV/VIDEO repeatedly to select the VCR input (VIDEO 1 in the illustration). The VCR may need to be turned on and set to the satellite receiver input.
Watch the VCR	Press TV/VIDEO repeatedly to select the input to which the VCR is connected (VIDEO 1 in the illustration).
Set up the TV remote control to operate the satellite receiver or VCR	If you have a non-Sony VCR or satellite receiver, you must program the remote control. See "Programming the Remote Control" on pages 49-50.
Activate the TV remote control to operate the satellite receiver or VCR	For the satellite receiver, press SAT/CABLE FUNCTION. For the VCR, open the outside cover, as shown on page 48. Then set the A/V slide switch to the position you programmed for the VCR.
Control satellite receiver and VCR functions with the TV remote control	See "Operating a Satellite Receiver" on page 51 and "Operating a VCR" on page 51.
Label video inputs to easily identify equipment connected to the TV	See the instructions for setting up Video Labels on pages 103-104.

TV

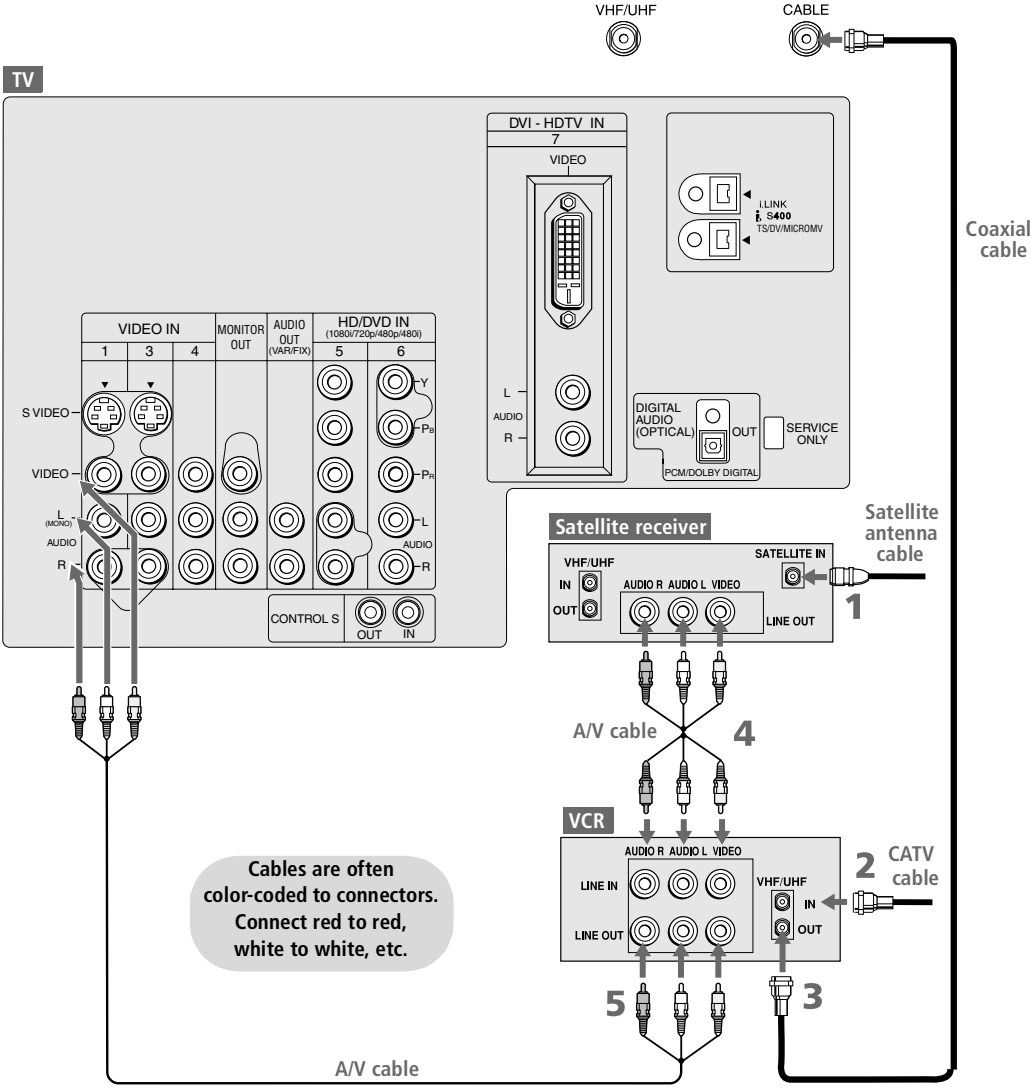

DVD Player with Component Video Connectors

For best results, use this connection if your DVD player has component video (Y, P_B, P_R) jacks.

To connect a DVD player with component video connectors

- 1 Use a component video cable, or three composite video cables, to connect the DVD player's Y, P_B and P_R jacks to the Y, P_B and P_R jacks (VIDEO 5) on the TV.

 The Y, P_B and P_R jacks on your DVD player are sometimes labeled Y, C_B and C_R, or Y, B-Y and R-Y. If so, connect the cables to like colors.

- 2 Use an audio cable to connect the DVD player's audio output jacks to the TV's VIDEO 5 audio input jacks.

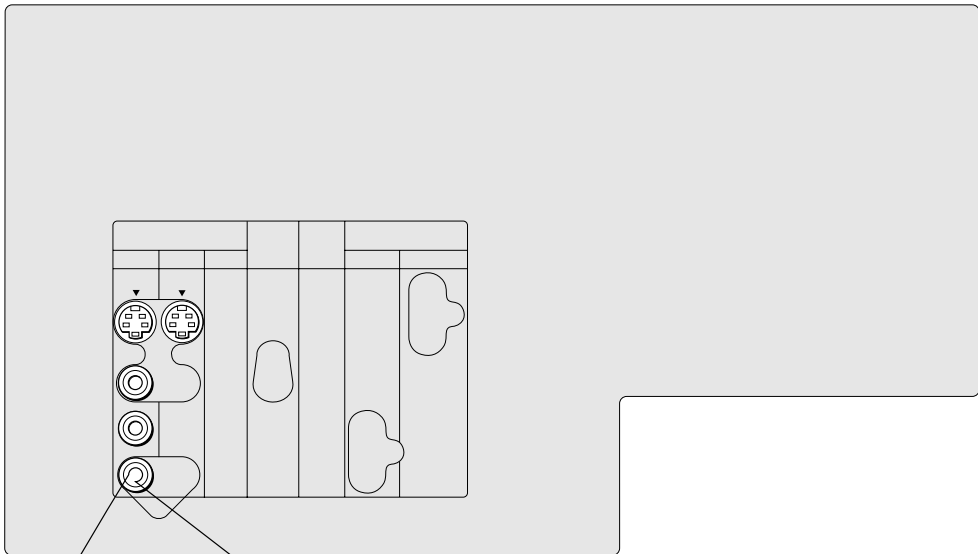

Notes on Using This Connection

<i>To Do This ...</i>	<i>Do This ...</i>
Watch the DVD player	Press TV/VIDEO repeatedly to select the DVD input (VIDEO 5 in the illustration).
Set up the TV remote control to operate the DVD player	If you have a non-Sony DVD player, you must program the remote control. See "Programming the Remote Control" on pages 49-50.
Activate the TV remote control to operate the DVD player	Open the outside cover, as shown on page 48. Then set the A/V slide switch to the position you programmed for the DVD player.
Control DVD functions with the TV remote control	See "Operating a DVD Player" on page 52.
Label video inputs to easily identify equipment connected to the TV	See the instructions for setting up Video Labels on pages 103-104.

 **You cannot record the signal from any equipment connected into the Y, PB, PR jacks.**

DVD Player with S VIDEO and Audio Connectors

Use this connection if your DVD player does not have component video (Y, PB, PR) jacks.

To connect a DVD player with A/V connectors

- 1 Use an audio cable to connect the DVD player's audio output jacks to the TV's audio input jacks.
- 2 Use an S VIDEO cable to connect the DVD player's S VIDEO jack to the TV's S VIDEO jack.



in the

program the remote control.

pages 49-50.

page 48. Then set the A/V slide switch

for the DVD player.

"DVD Player" on page 52.

the instructions for setting up Video Labels on pages 103-104.

ted

Camcorder



Using
S VIDEO jacks?
See page 23.

For easy connection of a camcorder, the TV has front A/V input jacks. If you prefer, however, you can connect the camcorder to the TV's rear A/V input jacks.

 **If your camcorder is equipped with an i.LINK jack, see "Using i.LINK" on page 83.**

To connect a camcorder

- 1 Open the front video panel, as shown on page 13.
- 2 Use A/V cables to connect the camcorder's A/V output jacks to the TV's A/V input jacks.

TV Front Video Panel

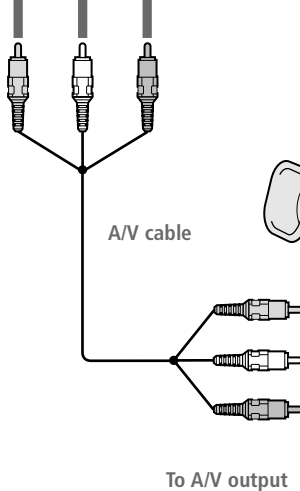
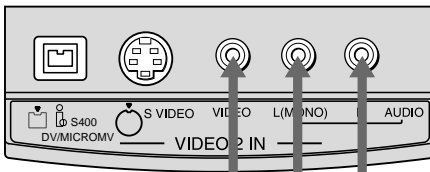

Cables are often color-coded to connectors. Connect red to red, white to white, etc.

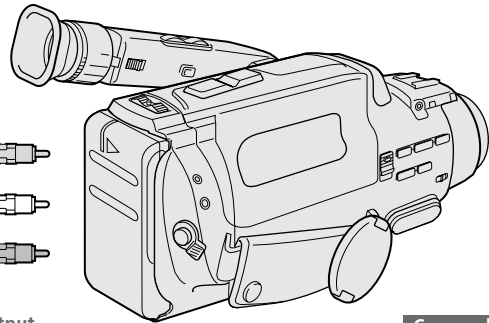

Camcorder

If you have a mono camcorder, connect its audio output jack to the TV's L MONO audio jack.

Notes on Using This Connection

To Do This ...

Watch the camcorder

Label video inputs to easily identify equipment connected to the TV

Do This ...

Press TV/VIDEO repeatedly to select the camcorder input (VIDEO 2 in the illustration).

See the instructions for setting up Video Labels on pages 103-104.

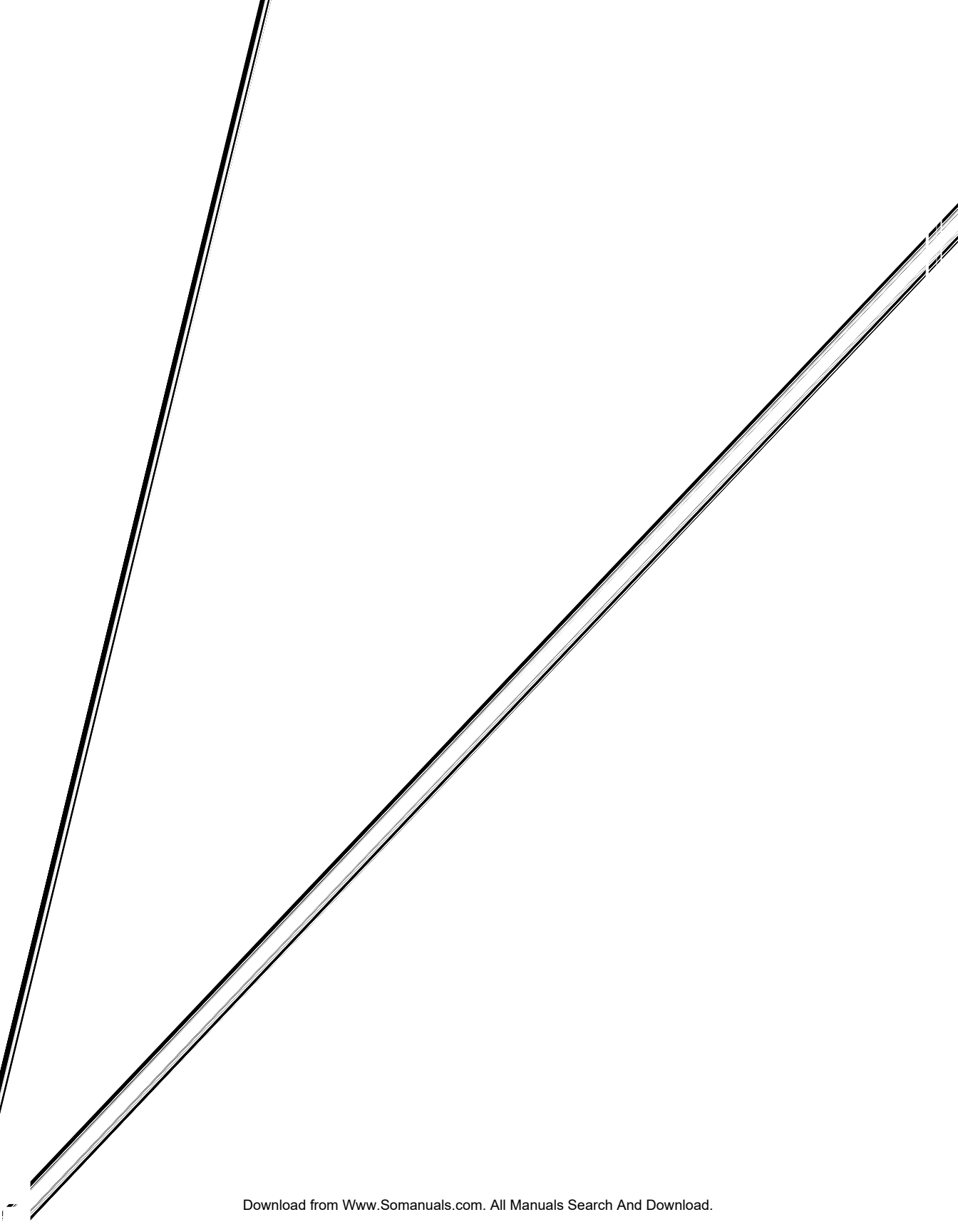

Using the CONTR

Se
e
c
fe
in
hid
Use
Use

g yo
T
migh
ment.

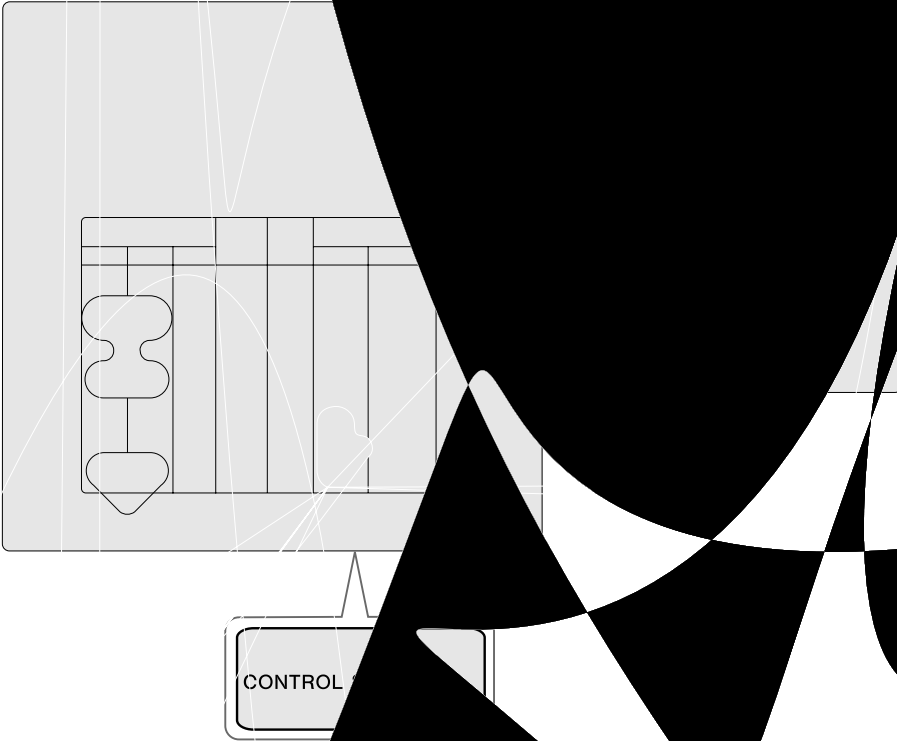

Setting Up the Channel List

After you finish connecting the TV, you need to run the Auto Program feature, which automatically creates a list of available analog and digital channels. The Auto Program screens appear when you turn on your TV for the first time after hooking it up.

Using Auto Program

To run Auto Program the first time you turn on your TV

- 1 Press POWER to turn on the TV.
The Initial Setup screen appears.
- 2 Using the joystick on the remote control, move the highlight to the desired language, then press \oplus to select that language.
- 3 When prompted to start Auto Program, press \oplus to select Yes.
Auto Program takes several minutes to complete. A progress bar is displayed while the channel list is being created.

To run Auto Program again at a later time

- Use the Auto Program feature as described on page 98.

To add individual digital channels

- Use the Digital Channel feature as described on page 98.

To reset the TV to factory settings

- 1 Press POWER to turn on the TV.
- 2 Hold down RESET on the remote control.
- 3 Press TV POWER on the TV. (The TV will turn itself off, then back on.)
- 4 Release RESET.

Adjusting the Convergence Automatically (Flash Focus)

The projection tube image appears on the screen in three colors (red, green and blue). If they do not converge, the color is poor and the picture blurs. Before you use your TV, be sure to adjust the convergence. The Flash Focus feature allows you to adjust the convergence automatically.

 **It is recommended that you perform Flash Focus about 30 minutes after the TV is first turned on.**

 You can also access Flash Focus in the Setup menu. For details, see page 103.

- 1 Tune to a TV or cable TV program.
- 2 Press the FLASH FOCUS button on the front panel of the TV (see page 15).

The cross pattern appears and Flash Focus begins to work.

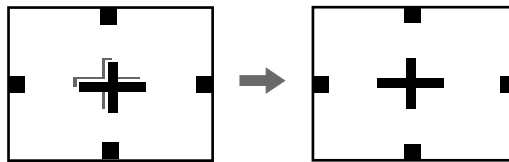

The adjustment is completed when the TV picture returns.

To Perform Additional Fine Manual Adjustments

Use the Manual Convergence feature, described on page 43.

Notes on Flash Focus

- You cannot perform any other functions until Flash Focus has completed its cycle. If you perform any other operation while Flash Focus is in progress, the Flash Focus operation is canceled.
- Flash Focus will not set the TV's convergence to the factory setting. To do this, press RESET while in Manual Convergence mode.

Adjusting the Convergence Manually

The Convergence feature gives you more control over the picture's convergence than the Flash Focus feature, allowing you to fine-tune the convergence.

- 1 Press MENU to display the Menu.
- 2 Move the joystick ← or → to highlight the Setup icon and press .
- 3 Move the joystick to highlight Convergence and press .

A pattern of white crosses appears, with a yellow cross around one of the crosses. Aligned crosses (which do not need adjustment) look white and have little or no red or blue showing. Crosses that are not aligned show red or blue shades beyond their edges.

You can scroll up and down through the 9 x 7 field of crosses to manually converge all portions of the screen.

- 4 Using the joystick, move the joystick to surround a cross that you want to adjust. Press . The cross changes to red.
- 5 If the cross that you selected has red edges, move the joystick until the red image is replaced with a white cross. Once you have finished this (or the cross does not have red edges), press . The cross changes to blue.
- 6 If the cross you selected has blue edges, move the joystick until the blue image is replaced with a white cross. Once you have finished this, press . The cross changes to yellow again.

7

Notes on Adjusting the Convergence Manually

- ❑ Allow the TV to warm up for about 30 minutes before you adjust the convergence.
- ❑ For best results, stand about 3 to 5 feet back from the picture when adjusting the convergence. Begin with the crosses in the center area of the screen and, once those are adjusted, move to the crosses on the edges of the screen.
- ❑ You can make separate adjustments to each wide mode: Full/Normal, Zoom, Wide Zoom, and Memory Stick/1080i high-definition input. (These features share a common convergence mode.) The cross pattern looks different in each of these, but the adjustment procedure is the same. Press the **WIDE MODE** button on the remote to toggle through the wide mode screens.
- ❑ To optimize the conditions for convergence adjustment, in the Video Menu, set *Mode* to *Pro* or *Movie* and lower the *Picture* level settings (see page 92). You can reset the adjustments by pressing the **RESET** button on the remote control.

Using the Remote Control

Overview

This chapter describes how to set up, program, and use the TV's remote control.

Topic	Page
Inserting Batteries	45
Button Descriptions	
Outside Panel	46
Inside Panel	48
Programming the Remote Control	49

Inserting Batteries

- 1 Remove the battery cover from the remote control.
- 2 Insert two size AA (R6) batteries (supplied) by matching the **+** and **-** terminals on the batteries to the diagram inside the battery compartment.
- 3 Replace the battery cover.

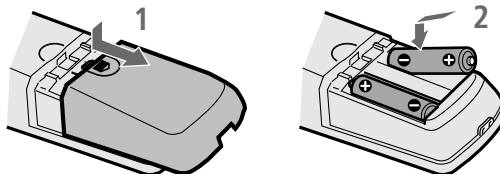

 Remove the batteries to avoid damage from possible battery leakage whenever you anticipate that the remote control will not be used for an extended period.



Handle the remote control with care.

Avoid dropping it, getting it wet, placing it in direct sunlight, near a heater, or where the humidity is high.

Button Description

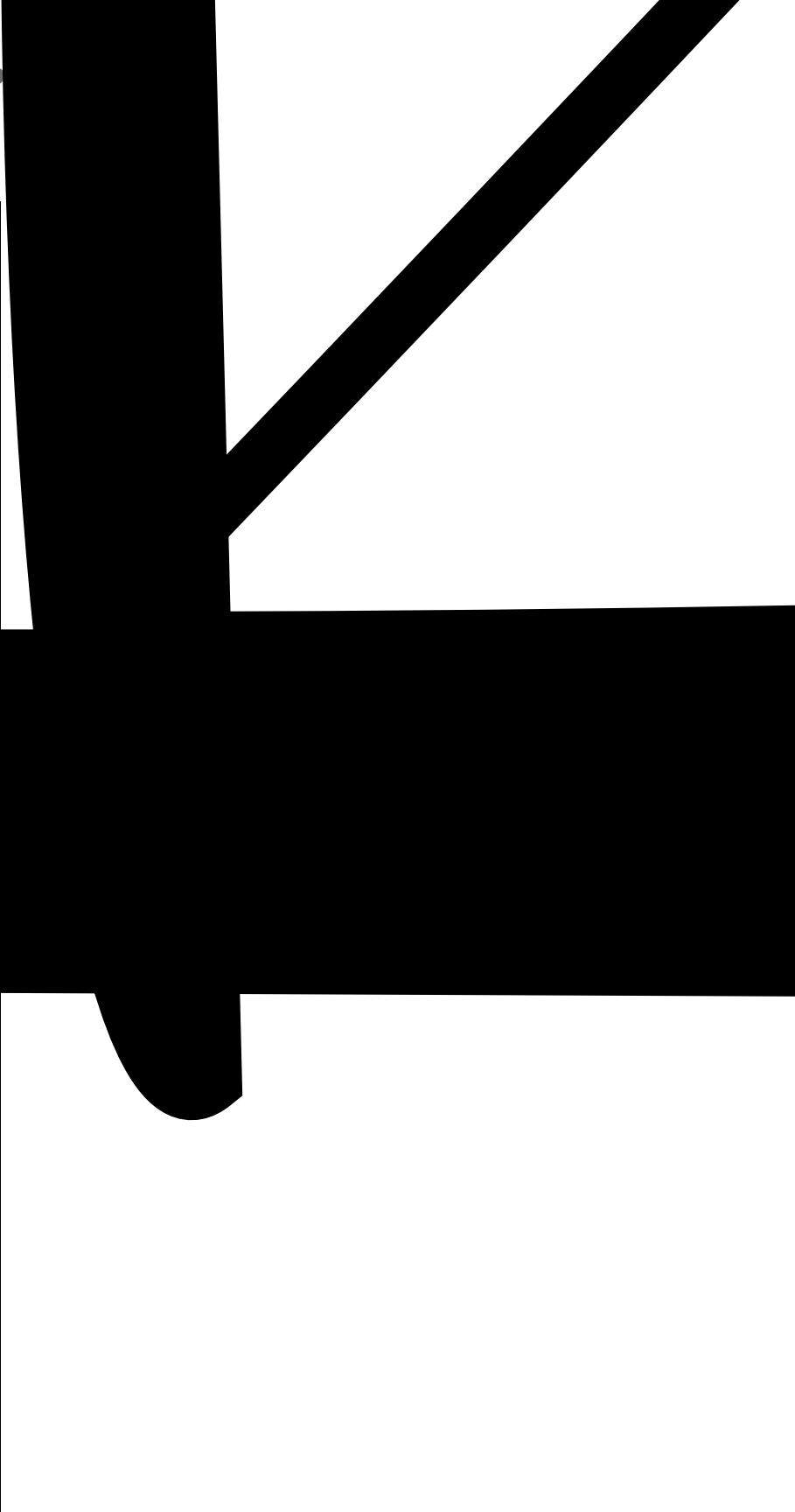
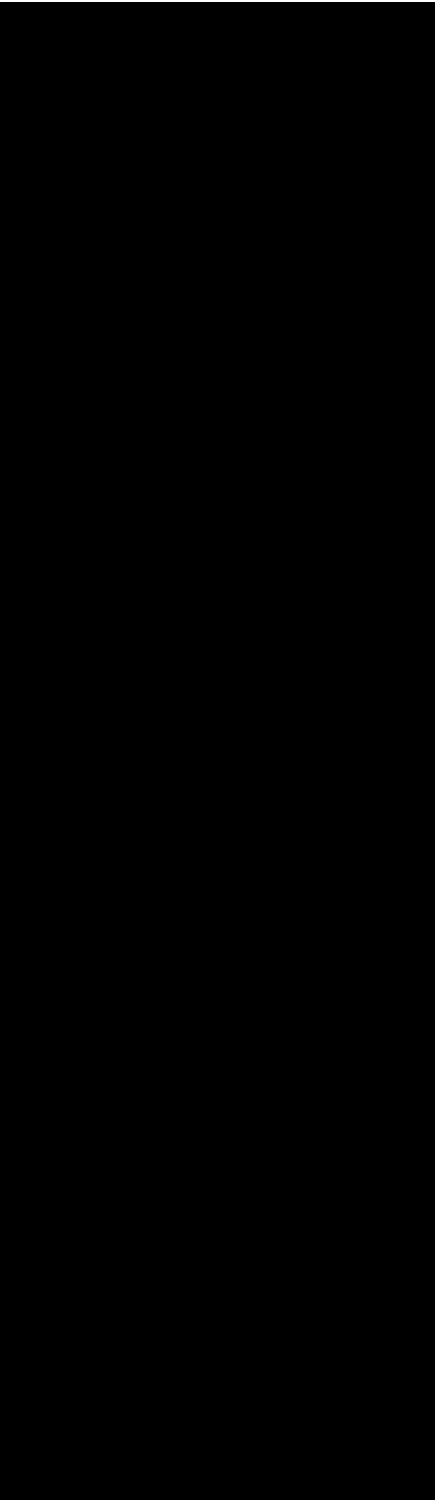
Outside Panel



Button	Description
16 POWER Buttons	SAT/CABLE: Press to turn on and off the satellite receiver or cable box. TV: Press to turn on and off the TV.
17 FUNCTION Buttons	The indicator lights up momentarily when pressed to show which equipment the remote control is operating: SAT/CABLE: Press to have the remote control operate the satellite receiver or cable box. TV: Press to have the remote control operate the TV.
18 PIC MODE	Press repeatedly to cycle through the available video picture modes: Vivid, Standard, Movie, Pro. Also available in the Video Menu. For details, see "Selecting Video Options" on page 92.
19 0 - 9 ENTER	Press 0 - 9 to select a channel; the channel changes after 3 seconds. Press ENTER to change channels immediately.
20 TWIN VIEW 	Press to turn on and off Twin View. For details, see pages 57-59.
21 CH +/-	Press to scan through channels. To scan quickly through channels, press and hold down either CH button.
22 MEMORY STICK 	Press to display the Memory Stick Menu. For details, see "Using the Memory Stick Viewer" on page 67.
23 DRC PALETTE	Press repeatedly to cycle through the three Custom DRC Palette options. Also available in the Video Menu. For details, see "Selecting Video Options" on pages 92-93.
24 DISPLAY	Press once to display the current channel number, current time, and program information banner (if set). Press again to turn Display off.
25 GUIDE	Press to display the digital program guide. For details, see page 63.
26 JUMP	Press to jump back and forth between two channels. The TV alternates between the current channel and the last channel that was selected.
27 EXIT	Press to exit the on-screen menu or display and return to normal viewing.
28 FREEZE	Press to freeze the window picture. Press again to restore the picture. For details see page 61.

Programming the Remote Control

The remote control is preset to operate Sony brand video equipment.

Sony Equipment	Switch Position on Remote Control	Programmable Code Number
i.LINK	i.LINK/AV1	901
8 mm VCR	AV2	302
VHS VCR	AV3	301
DVD player	DVD	751

If you have video equipment other than Sony brand that you want to control with the TV's remote control, use the following procedure to program the remote control.

 **The equipment must have infrared (IR) remote capability in order to be used with the remote control.**

- 1 Turn to the list of "Manufacturer's Codes" on page 50, and find the three-digit code number for the manufacturer of your equipment. (If more than one code number is listed, use the number listed first.)
- 2 Open the remote control and set the A/V slide switch to i.LINK/AV1, AV2, AV3, or DVD. Then close the remote control.

 **If the device that you wish to program is connected through i.LINK, you must set the slide switch to AV1.**

- 3 Press CODE SET.
- 4 Enter the three-digit manufacturer's code number.
- 5 Press ENTER.

 **You must do step 5 within 10 seconds of step 4, or you must redo steps 3 through 5.**

- 6 To check if the code number works, aim the TV's remote control at the equipment and press the POWER button that corresponds with that equipment. If it responds, you are done. If not, try using another code listed for that manufacturer.

Notes

- If more than one code number is listed, try entering them one by one until you come to the correct code for your equipment.
- If you enter a new code number, the code number you previously entered at that setting is erased.
- In some cases, you may not be able to operate your equipment with the supplied remote control. In such cases, use the equipment's own remote control unit.
- Whenever you remove the batteries to replace them, the code numbers may revert to the factory setting and must be reset.

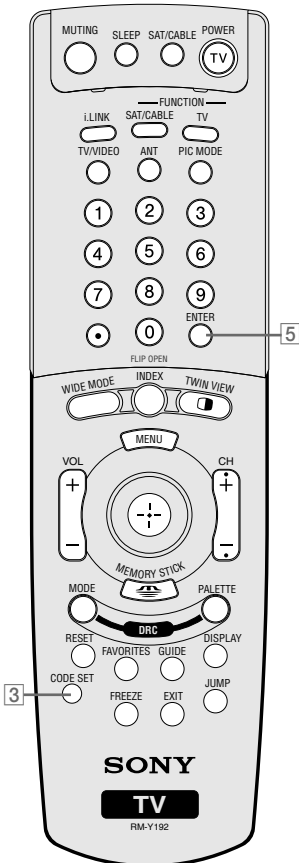
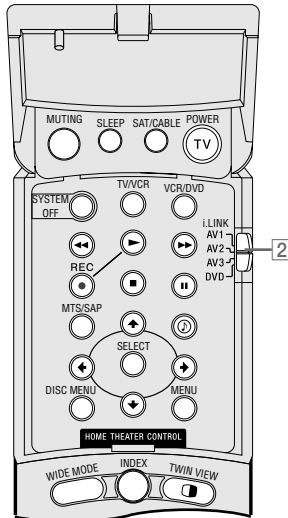

Manufacturer's Codes

VCRs

Manufacturer	Code
Sony	301, 302, 303
Admiral (M. Ward)	327
Aiwa	338, 344
Audio	314, 337
Dynamic	
Broksonic	319, 317
Canon	309, 308
Citizen	332
Craig	302, 332
Criterion	315
Curtis Mathes	304, 338, 309
Daewoo	341, 312, 309
DBX	314, 336, 337
Dimensia	304
Emerson	319, 320, 316, 317, 318, 341
Fisher	330, 335
Funai	338
General Electric	329, 304, 309
Go Video	322, 339, 340
Goldstar	332
Hitachi	306, 304, 305, 338
Instant Replay	309, 308
JC Penney	309, 305, 304, 330, 314, 336, 337
JVC	314, 336, 337, 345, 346, 347
Kenwood	314, 336, 332, 337
LXI (Sears)	332, 305, 330, 335, 338
Magnavox	308, 309, 310
Marantz	314, 336, 337
Marta	332
Memorex	309, 335
Minolta	305, 304
Mitsubishi/ MGA	323, 324, 325, 326
Multitech	325, 338, 321
NEC	314, 336, 337
Olympic	309, 308
Optimus	327

Manufacturer	Code
Orion	317
Panasonic	308, 309, 306, 307
Pentax	305, 304
Philco	308, 309
Philips	308, 309, 310
Pioneer	308
Quasar	308, 309, 306
RCA/ PROSCAN	304, 305, 308, 309, 311, 312, 313, 310, 329
Realistic	309, 330, 328, 335, 324, 338
Sansui	314
Samsung	322, 313, 321
Sanyo	330, 335
Scott	312, 313, 321, 335, 323, 324, 325, 326
Sharp	327, 328
Signature 2000 (M. Ward)	338, 327
SV2000	338
Sylvania	308, 309, 338, 310
Symphonic	338
Tashiro	332
Tatung	314, 336, 337
Teac	314, 336, 338, 337
Technics	309, 308
Toshiba	312, 311
Wards	327, 328, 335, 331, 332
Yamaha	314, 330, 336, 337
Zenith	331

Laserdisc Players

Manufacturer	Code
Sony	701
Panasonic	704, 710
Pioneer	702

i.LINK Controls

Function	Code
Rewind, Play, Fast-forward, Record, Stop, Pause	901

DVD Players

Manufacturer	Code
Sony	751
Apex	762
General Electric	755
Hitachi	758
JVC	756
Magnavox	757
Mitsubishi	761
Oritron	759
Panasonic	753
Philips	757
Pioneer	752
RCA/Proscan	755
Samsung	758
Toshiba	754
Zenith	760

Cable Boxes

Manufacturer	Code
Sony	230
Hamlin/Regal	222, 223, 224, 225, 226
Jerrold/G. I./ Motorola	201, 202, 203, 204, 205, 206, 207, 208, 218
Oak	227, 228, 229
Panasonic	219, 220, 221
Pioneer	214, 215
Scientific Atlanta	209, 210, 211
Tocom	216, 217
Zenith	212, 213

Satellite Receivers

Manufacturer	Code
Sony	801
Dish Network	810
Echostar	810
General Electric	802
Hitachi	805
Hughes	804
Mitsubishi	809
Panasonic	803
RCA/ PROSCAN	802, 808
Toshiba	806, 807

Using Other Equipment with Your TV Remote Control

All Equipment

To Do This ...	Do This ...
Switch the TV's input to the VCR, DVD player, or other connected equipment	Press TV/VIDEO repeatedly to cycle through the video equipment connected to the TV's video inputs.
Set up the TV remote control to operate non-Sony equipment	You must program the remote control the first time you use it. See "Programming the Remote Control" on pages 49 to 50.

Operating a VCR

To Do This ...	Press
Activate the remote control to operate the VCR	Open the outside cover, as shown on page 48. Then set the A/V slide switch to the position you programmed for the VCR.
Change channels	CH +/-
Record	▶ and ● simultaneously
Play	▶
Stop	■
Fast forward	▶▶
Rewind the tape	◀◀
Pause	
Search the picture forward or backward	▶▶ or ◀◀ during playback (release to resume normal playback)
Change input mode	TV/VCR

Operating a Satellite Receiver

To Do This ...	Press
Activate the remote control to operate the satellite receiver	SAT/CABLE FUNCTION
Turn on/off	SAT/CABLE POWER
Select a channel	0-9, ENTER
Change channels	CH +/-
Back to previous channel	JUMP
Display channel number	DISPLAY
Display SAT Guide	GUIDE
Display SAT Menu	MENU
Move highlight (cursor)	Move the joystick ↑ ↓ ← →
Select item	⊕

Operating a Cable Box

To Do This ...	Press
Activate the remote control to operate the cable box	SAT/CABLE FUNCTION
Turn on/off	SAT/CABLE POWER
Select a channel	0-9, ENTER
Change channels	CH +/-
Back to previous channel	JUMP

Operating a DVD Player

To Do This ...	Press
Activate the remote control to operate the DVD	Open the outside cover, as shown on page 48. Then set the A/V slide switch to the position you programmed for the DVD player.
Play	▶
Stop	■
Pause	⏸
Step through different tracks of the disc	▶▶ to step forward or ◀◀ to step backward
Step through different chapters of a video disc	CH+ to step forward or CH- to step backward
Display the DVD player Menu (Setup)	MENU (inside panel)
Display the DVD Menu	DISC MENU
Move highlight (cursor)	↑ ↓ ◀ ▶
Select item	SELECT

Operating an MDP (Laserdisc Player)

To Do This ...	Press
Activate the remote control to operate the MDP	Open the outside cover, as shown on page 48. Then set the A/V slide switch to the position you programmed for the MDP player.
Play	▶
Stop	■
Pause	⏸
Search the picture forward or backward	▶▶ or ◀◀ during playback (release to resume normal playback)
Search a chapter forward or backward	CH +/-

Using the Features



Overview

This chapter describes how to use the features of your TV.

<i>Topic</i>	<i>Page</i>
Watching TV	54
Using the Scrolling Index	55
Using Wide Mode	56
Using Twin View	57
Using Favorite Channels	60
Using the Freeze Function	61

Watching TV

 For a complete list of all the functions of the remote control, see pages 45-50.

To Do This ...	Do This ...
Activate the remote control to operate the TV	Press TV FUNCTION
Turn on/off the TV	Press TV POWER
Tune directly to a channel	To tune to analog channels, press 0-9 and then ENTER. For digital subchannels, press 0-9,  , press 0-9 again, and then ENTER. For example, to select subchannel 2.1, press 2 +  + 1, and then press ENTER.
	 You can also select digital channels using the digital program guide. See page 63 for details.
Adjust the volume	Press VOL +/-
Mute the sound	Press MUTING (press again to unmute)
Alternate back and forth between two channels	Press JUMP The TV alternates between the current channel and the last channel tuned.
Display the current channel number (and other information)	Press DISPLAY once to display the channel number, current time, and channel label (if set). Press DISPLAY again to turn Display off.
Switch the TV's input to the VCR, DVD player, or other connected equipment	Press TV/VIDEO repeatedly to cycle through the video equipment connected to the TV's video inputs.
Change video and audio options, customize the TV's setup, set parental controls, and more	Press MENU to display the Menu. For details, see "Using the Menus" on page 91.
Switch the TV's input between sources connected to the TV's VHF/UHF and CABLE inputs	Press ANT to alternate between sources connected to the TV's VHF/UHF and CABLE inputs.
Switch the TV's input to a connected i.LINK device	Press i.LINK to display a list of available i.LINK devices, and select the desired device from the list. See page 86 for details.

Using the Scrolling Index

The Scrolling Index lets you select programs from a series of preview windows that scroll along the right side of the screen.

- 1 Press INDEX.

The Scrolling Index appears, with the currently selected program in the main (left) window, and four scrolling video pictures in the right.



As each picture on the right scrolls to the live preview window, it changes briefly from a frozen video picture to a live video. The right side continues to scroll through the entire channel list.

- 2 To change the direction of the scrolling, move the joystick \uparrow or \downarrow .
- 3 To change the speed of the scrolling, move and hold the joystick \uparrow or \downarrow .
- 4 To change a frozen video picture to a live video, move the joystick \uparrow or \downarrow to highlight the picture, then press \odot .
- 5 To move the live video (from step 4) from the right to the main (left) window of the Scrolling Index, press \oplus again.

To exit the Scrolling Index

- Press INDEX.

Factors Affecting Scrolling Index

- Scrolling Index feature does not function if you use a cable box to view all channels.
- Digital sources, as well as any sources connected to the VIDEO 5, VIDEO 6, VIDEO 7 inputs, display in the left window, but not in the right windows.
- Scrolling Index does not function if parental controls are set (see page 100).

Using Wide Mode

Wide Screen mode lets you watch 4:3 normal broadcasts in several Wide Screen modes (16:9 aspect ratio).

 You can also access the Wide Mode settings in the Screen menu. For details, see page 96.

 **When viewing high-definition programs broadcast in 720p/1080i, it is not possible to change between Wide Screen modes.**

- ❑ Press WIDE MODE repeatedly to toggle through the following Wide Mode settings.

Example

Description



Wide Zoom



Normal



Full



Zoom

Wide Zoom enlarges the center portion of the 4:3 picture proportionately; however, only the left and right edges of the screen are stretched to fill the 16:9 screen. The picture has a normal appearance, as much as possible.

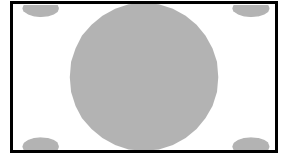

Normal returns the 4:3 picture to its original size. Black bars are visible at left and right sides to fill the 16:9 screen.

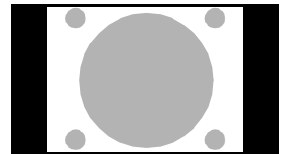

Full Mode stretches the entire 4:3 picture horizontally only, to fill the 16:9 screen. The picture has an elongated appearance.

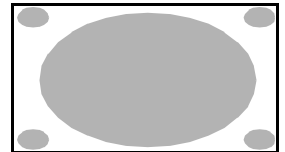

Zoom Mode enlarges the entire 4:3 picture proportionately to fill the 16:9 screen. Useful for watching Letterbox movies.

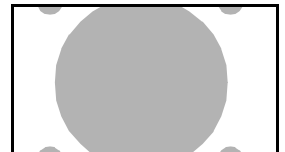

When you change channels or inputs, the Wide Mode settings revert to the 4:3 Default setting in the Screen menu. To retain the current Wide Mode setting as channels and inputs are changed, set 4:3 Default to Off. For details, see page 97.

Using Twin View

Twin View lets you see two pictures from two sources — from an antenna, VCR, DVD, etc. — on the screen at the same time. You hear the sound from only one of the sources at a time, but you can choose which source's sound is selected. You can also change the relative size of each of the pictures.

Displaying Twin Pictures

- 1 Tune the TV to a working channel.
- 2 Press **TV**.

A second picture appears. The active picture is highlighted in blue.

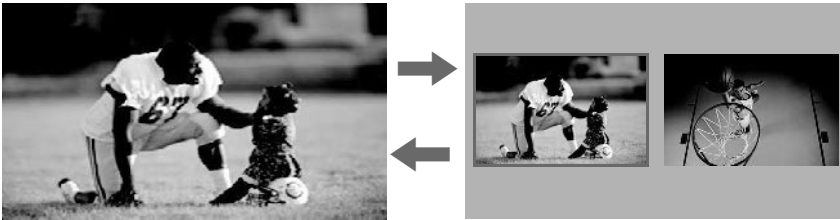

To cancel Twin View and watch the active picture

- Press **TV** or **+**.

Factors Affecting Twin View

- If you use a cable box to view all channels, the same channel appears in both windows of Twin View because the cable box unscrambles only one channel at a time.
- If you use a cable box, you can view the cable box output in one Twin View window and view a different source (such as a VCR or DVD player) in the second window by using the TV/VIDEO button. For details, see “Connecting Optional Equipment” on page 23.
- Digital sources, as well as any sources connected to the VIDEO 5, VIDEO 6, VIDEO 7 inputs, display in the left window, but not in the right.
- If you are viewing a 4:3 source and a 16:9 enhanced source (such as a DVD) side by side in Twin View, the 4:3 source appears larger.
- Twin View does not display channels that are blocked by parental settings (see page 100).

Activating the Picture

To activate the picture in the right window



- Move the joystick ➔.

To activate the picture in the left window

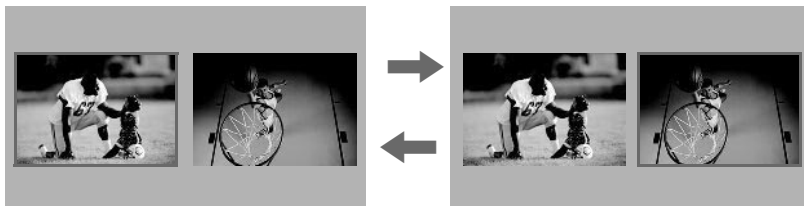
- Move the joystick ➜.



Functions Available in the Active (Highlighted) Window

To Do This ...	Do This ...
Tune directly to a channel	To tune to analog channels, press 0-9 and then ENTER or Press CH+/- For digital subchannels, press 0-9,  , press 0-9 again, and then ENTER. For example, to select subchannel 2.1, press 2 +  + 1, and then press ENTER.
Adjust the volume	Press VOL +/-
Mute the sound	Press MUTING (press again to unmute)
Switch the TV's input between sources connected to the TV's VHF/UHF and CABLE inputs	Press ANT
Switch the TV's input between sources connected to the TV's A/V inputs	Press TV/VIDEO
Change the picture size	Move the joystick ▲ or ▼. (For details, see "Changing the Picture Size" on page 59.)

Changing the Picture Size

The zoom feature lets you vary the relative size of the left and right pictures.

- 1 Move the joystick \leftarrow or \rightarrow to activate the picture that you want to resize.
- 2 Move the joystick \uparrow to enlarge the picture.
- 3 Move the joystick \downarrow to make the picture smaller.



When you adjust the picture sizes, the TV memorizes the change. The next time you use the Twin View function, the memorized sizes appear.

Using Favorite Channels

The Favorite Channels feature lets you select programs from a list of up to 16 favorite channels that you specify.

Creating a List of Favorite Channels

 For details on using the Channel Menu, see page 98.

- 1 Press **MENU** to display the Menu.
- 2 Move the joystick **←** or **→** to highlight the Channel icon and press **⊕**.
- 3 Press **⊕** to select Favorite Channels.
- 4 Move the joystick **▲** or **▼** to highlight a Favorite Channel number (1-16) and press **⊕**.
- 5 Move the joystick **▲** or **▼** to highlight a channel you want to assign to the Favorite Channel number. A preview of the highlighted channel appears in the upper right of the screen. Press **⊕** to select that channel as a Favorite Channel.

 **Digital channels are displayed as a black box in the preview window.**

- 6 To add more channels to your favorites list, repeat steps 4-5. To clear a Favorite Channel, move the joystick **▲** or **▼** to highlight the channel you want to clear. Press **⊕** and then press **RESET**.
- 7 Press **MENU** to exit the Menu.

Displaying a List of Favorite Channels

 To assign Channel Labels (e.g., ABC, HBO, MTV, etc.) to channel numbers, as shown at right, use the Channel Label feature in the Channel Menu (see page 99).

- 1 Press **FAVORITES**. The Favorite Channels list appears.



- 2 Move the joystick **▲** or **▼** to highlight the channel you want to watch. A preview of the highlighted Favorite Channel appears.
- 3 Press **⊕** to select the channel you want to watch.

Using the Freeze Function

The FREEZE button allows you to temporarily capture a program's picture. You can use this feature to write down information such as phone numbers, recipes, etc.

 **The Freeze feature is not available while you are using the Twin View.**

- 1 When the program information you want to capture is displayed, press FREEZE.
- 2 The TV switches to Twin View mode and displays the "frozen" picture on the right, while the current program continues on the left.



- 3 To cancel and return to normal viewing, press FREEZE (or just tune to another channel).

Using the Digital Program Guide

Displaying the Digital Program Guide

This TV is equipped to show digital programming, if a digital signal is present. The digital program guide and menus let you review program information, select digital channels and subchannels, set up your TV's digital programming, and enable digital closed captioning.

 **Analog channels are not available in this guide.**

To display the digital program guide:

- 1 Tune your TV to a digital channel by using the 0-9, , and ENTER buttons.
- 2 Press GUIDE on the TV's remote control. The digital program guide appears, with the currently selected program showing in the background.

 The digital program guide and menus are not available while using multipicture functions (Twin View, Freeze, Scrolling Index, i.LINK, Memory Stick, or Favorite Channels).

 **Program information in the guide is provided by the broadcasters. As a result, it may sometimes include only the channel number, without a program title or description.**

Navigating the Digital Program Menus

Four digital menus are available on the digital program guide.

Digital Program Menu	See Page
Using the Guide Menu	64
Using the Program Options Menu	64
Using the Caption Vision Menu	65
Using the Digital Setup Menu	65

To navigate to these menus and through the available options:

- 1 Move the joystick $\uparrow \downarrow \leftarrow \rightarrow$ to navigate through the options.
- 2 Press \oplus to select the desired option.

Using the Guide Menu

The Guide menu allows you to select digital channels and subchannels from a dropdown list. This list also provides information about the current program being shown on each digital channel.



 Subchannels are additional channels of programming broadcast simultaneously. For example, channel 4 might include three subchannels (4.1, 4.2, 4.3) that are showing programs at the same time.

Using the Program Options Menu

The Program Options menu allows you to customize the settings of the program on the currently tuned channel.

Option	Description
Alternate Video	Each program has a main video stream, and may have alternate video streams. This option allows you to switch among these alternate video streams.
Alternate Audio	Each program has a main audio stream (the audio that you hear when the channel is first tuned). This option allows you to switch among these alternate audio streams (e.g., for different languages).

Using the Caption Vision Menu

The Caption Vision menu allows you to turn on/off digital closed captioning, and to modify how digital closed captioning is shown on your TV. Depending on the program, digital closed captioning will be available in a number of different languages, aspect ratios, and reading levels.

- 1 Use the joystick to select from the following six services. The service description, if available, applies to the currently tuned channel.

Option	Description
Off	Turns off closed captioning for digital programs
1 XXX YYY ZZZ	XXX = language (English, Spanish, French, etc.)
2 XXX YYY ZZZ	YYY = reader level (standard*, easy)
3 XXX YYY ZZZ	ZZZ = aspect ratio (4:3, 16:9)
4 XXX YYY ZZZ	
5 XXX YYY ZZZ	* When set to this option, the option name is not shown
6 XXX YYY ZZZ	



 **The Caption Vision menu only affects digital channels. For closed captioning on analog channels, see “Using the Setup Menu” on page 103.**

Using the Digital Setup Menu

 This option is the same as the “Digital Channels” option. See “Using the Setup Menu” on page 103.

The Digital Setup menu lets you change the way your digital channels are displayed.

The following digital setup functions are available:

Option	Description
Add Digital Channels	This option allows you to add new digital channels for the currently active antenna mode (Cable or VHF/UHF).  This option is useful if the number of digital channels that your TV is able to receive has recently been increased, but you do not want your TV to perform a full Auto Setup.
Channel Show/Hide	This option allows you to remove (hide) digital channels from the Digital Program Guide’s list of channels and subchannels, as well as from channel surfing using CHANNEL +/- . Hidden channels can still be directly tuned using 0-9 and  .
Digital Signal Strength	Displays the current strength of the digital signal on VHF/UHF, to allow you to adjust your antenna for optimal reception. (Does not apply to digital cable channels.)
Digital Caption Setup	Allows you to customize digital closed captioning (see page 66 for details).

Customizing Caption Vision

You can use the Digital Caption Setup menu to customize your TV's Caption Vision.

Select from the following options to change the visual characteristics of your TV's digital closed captioning. A preview window displays a sample as you scroll through each option.

<i>Option</i>	<i>Description</i>
Character Size	Small, Standard*, Large
Character Style	Style 1-7 (Style 4*)
Character Color	None, Color 1-8 (White*)
Edge Color	Color 1-8 (Black*)
Edge Type	None*, Raised, Depressed, Outline, Left Shadow, Right Shadow
Background Color	None, Color 1-8 (Teal, Transparent*)
Window Color	None*, Color 1-8

* Indicates factory default setting

Using the Memory Stick Viewer

About Memory Stick



Memory Stick (sold separately) is a new, compact, portable, and versatile Integrated Circuit recording medium with a data capacity that exceeds that of a floppy disk. Memory Stick is specially designed for sharing digital data among Memory Stick compatible products such as digital cameras and digital video cameras. Because it is removable, Memory Stick can also be used for external data storage.

The Memory Stick Viewer on your TV allows you to view files that are stored on Memory Stick media. You can view:

- Digital photos (JPEG files)
- Movies (MPEG1 files)

You can also play slide show background music using MP3 files stored on your Memory Stick.

For more information about handling Memory Stick media, see “Notes on Using Memory Stick Media” on page 81.

Features

With the Memory Stick Viewer, you can:

- View photo (JPEG) and movie (MPEG1) files in a thumbnail index or Slide Show
- Set customized Slide Show options, including transitions and background audio
- Pan, zoom, and rotate photos
- Lock (protect) or delete files on the Memory Stick

Memory Stick Compatibility

This television is compatible with the following Memory Stick media types:

- Memory Stick Media
- Memory Stick Duo Media
- Memory Stick Media with Memory Select Function
- Memory Stick PRO Media

About Memory Stick PRO Media

Memory Stick PRO media features vary by and are dependent upon the design of host hardware devices. Memory Stick Pro in this television has been tested to support up to 1 GB media capacity and does not support high-speed transfer, MagicGate copyright protection technology, or access control security features.

File Compatibility

The Memory Stick Viewer is compatible with JPEG images taken with Sony digital still cameras and MPEG1* movies taken with Sony digital cameras and camcorders. In order to be viewable in the Memory Stick Viewer, the files must have the following file name extensions:

<i>File Type</i>	<i>Supported File Name Extensions</i>
JPEG	.jpg .jpeg
MPEG1	.mpg .mpeg

Trademark Information

Memory Stick, Memory Stick PRO, and MagicGate are trademarks of Sony Corporation.

*Some variations of MPEG1 movies may not play back correctly.

Inserting and Removing a Memory Stick

If you are using a Memory Stick Duo, see “Inserting the Memory Stick Duo” on page 70.

Inserting a Memory Stick

- 1 Locate the Memory Stick slot and insert the Memory Stick into the Memory Stick slot as illustrated below. When inserted properly, it should slide in with little resistance and click into place.

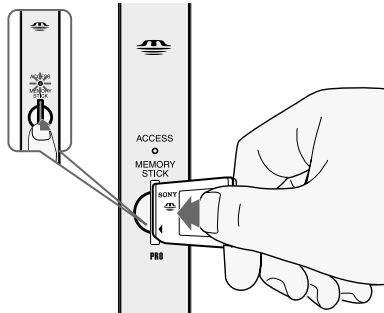

 **Be sure to insert the Memory Stick in the correct direction. If the Memory Stick is forced in the wrong way, it may become damaged.**
Insert only Memory Stick media into the Memory Stick slot. Attempting to insert other objects into the slot may damage the TV.

To remove the Memory Stick, see “Removing a Memory Stick” on page 71.

Inserting the Memory Stick Duo

Memory Stick Duo is a new, compact version of the standard-sized Memory Stick recording medium.

! CAUTION: Inserting the Memory Stick Duo incorrectly may result in permanent damage to the Memory Stick Duo and the TV.

- 1 Before inserting a Memory Stick Duo into the TV's Memory Stick slot, you must first insert the Memory Stick Duo into an adapter (sold separately).

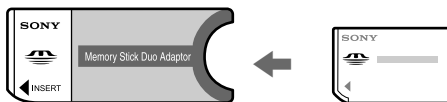

Memory Stick Duo Adapter

Memory Stick Duo

! CAUTION: Inserting the Memory Stick Duo into the Memory Stick slot without the adapter may result in permanent damage to the Memory Stick Duo and the TV.

- 2 Insert the Memory Stick Duo and adapter as shown below.

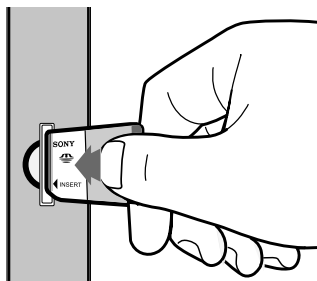

! CAUTION: Inserting the Memory Stick adapter backwards or upside down may result in permanent damage to the Memory Stick adapter and the TV.

To remove the Memory Stick Duo, see "Removing a Memory Stick" on page 71.

Removing a Memory Stick

Memory Stick
The Memory Stick indicator is off. (When the light is lit, it indicates that the TV is reading data from the Memory Stick.)

Do not remove the Memory Stick while a file is being accessed (when the MEMORY STICK ACCESS indicator on the TV's front panel is lit) as this may damage the Memory Stick contents.

Insert the Memory Stick gently into the slot, and then release it. The Memory Stick media is ejected.

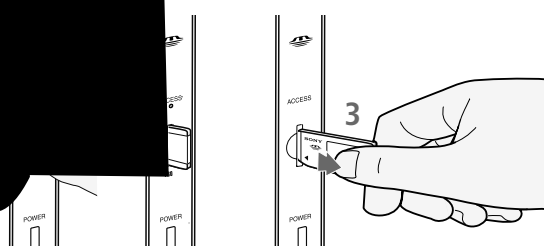

3 Pull the Memory Stick completely out of the slot.

 To protect small children from injury from Memory Stick Media, remove all Memory Stick media from the TV's Memory Stick slot and store it in a safe location when it is not in use.



Using the Memory Stick Index

Turn on the TV and insert a Memory Stick that contains the photo or movie files you want to view. For details, see page 69.

 **If the Memory Stick Index does not appear, press the MEMORY STICK button on the remote control.**

The Memory Stick Index appears, which displays thumbnail images of the files stored on the Memory Stick.



About the Lock and Movie Icons on the Thumbnail Images

 Indicates the thumbnail is a movie (MPEG1) file instead of a photo (JPEG) file.

 Indicates the thumbnail is locked. Locked files cannot be changed or deleted. For details, see "Protect" on page 80.

Using the Memory Stick Index

The following describes how to use the Memory Stick Index.

To Do This ...	Do This ...
Move the highlight to a photo or movie (Ⓜ) thumbnail	Move the joystick ↑ ↓ ← → .
Display the highlighted photo or movie file full screen	Press ⊕ . For details, see “Viewing Photos” on page 74 and “Playing Movies” on page 77.
Display the next page of thumbnails	<ol style="list-style-type: none"> 1 Move the joystick ↓ to select ▼. 2 Move the joystick ↓ to display the next page of thumbnails.
Display the previous or next page of thumbnails	<ol style="list-style-type: none"> 1 Move the joystick ↓ to select ▼. 2 Move the joystick ← to select ◀. 3 To go to the previous page, move the joystick ←. To go to the next page, move the joystick ↓.
Use the Memory Stick menu bar to access additional options	<ol style="list-style-type: none"> 1 Move the joystick ↓ to select ▼. 2 Move the joystick ← or → to select Slide Show, Folder, or Memory Stick. 3 Move the joystick ↑ or ↓ to select the option you want to change. <p>For details on these options, see “Memory Stick Index Menu Bar Options” on page 79.</p>
Move the highlight from the Memory Stick menu bar back to the thumbnails	<ol style="list-style-type: none"> 1 Move the joystick ← or → to select ▼. 2 Move the joystick ↑ to return to the currently displayed thumbnails, or ↓ to display the next page of thumbnails.
Exit Memory Stick Viewer	Press the MEMORY STICK button on the remote control.

Photo Menu Bar Options

The Photo menu bar lets you access additional photo viewing options.

To access the Photo menu bar

- 1 Move the joystick ◀ or ▶ to select Slide Show, View, or File.
- 2 Move the joystick to select the desired option.

Option	Description	
Index	Displays the Memory Stick Index, with the highlight on the thumbnail of the currently displayed photo. For details, see "Using the Memory Stick Index" on page 72.	
Slide Show	Displays the Slide Show menu. For details, see "Slide Show Menu Options" on page 79.	
View	Zoom/Pan	Allows you to magnify and pan across the photo. For details, see "Using Zoom and Pan" on page 76.
	Rotate	Allows you to rotate the photo in 90 degree increments clockwise or counterclockwise. For details, see "Using Rotate" on page 76.
File	Information	Allows you to turn on or off the display of file information. Select On or Off.
	Protect	Allows you to the protect the JPEG file from any changes. When a JPEG file is protected, it cannot be rotated or deleted. Select On or Off.
	Delete	Deletes the JPEG file from the Memory Stick. You cannot delete a JPEG file that has been protected (or if the Memory Stick is locked).



JPEG files that are protected are indicated by the Lock icon.

Using Zoom and Pan

To Zoom and Pan a photo

- 1 In the Photo menu bar, move the joystick to highlight View.
- 2 Move the joystick to highlight Zoom/Pan and press \oplus .
- 3 Specify the zoom center point by moving the joystick; then press \oplus to set the center.

The Zoom and Pan controls are displayed.

Indicates Zoom increment



To Do This ...

Zoom in (increase magnification) or out (decrease magnification)

Do This ...

Move the joystick to highlight Zoom and press \oplus . Then move the joystick \uparrow to zoom in or \downarrow to zoom out.

To stop using Zoom, press \oplus .

Pan (left, right, up, down)

(You can use Pan only when the photo is magnified using Zoom.)

Move the joystick to highlight Pan and press \oplus . Then move the joystick $\leftarrow \rightarrow \uparrow \downarrow$ to pan around the photo.

To stop using Pan, press \oplus .

Exit the Zoom/Pan controls

Move the joystick to highlight Done and press \oplus .

Exit Memory Stick Viewer

Press the MEMORY STICK button on the remote control.

Using Rotate

To Rotate a photo

- 1 In the Photo menu bar, move the joystick to highlight View.
- 2 Move the joystick to highlight Rotate.
- 3 To rotate clockwise, move the joystick to highlight Clockwise and press \oplus .
To rotate counterclockwise, move the joystick to highlight Counterclockwise and press \oplus .

The photo is rotated 90 degrees each time you press \oplus .





Movie Menu Bar Options

To access the Movie menu bar

- 1 Move the joystick to highlight Index in the Movie menu bar.
- 2 Move the joystick ← or → to select Index, Slide Show, or File.
- 3 Move the joystick to select the desired option.

Option	Description	
Index	Displays the Memory Stick Index, with the highlight on the thumbnail of the currently displayed movie.	
Slide Show	Displays the Slide Show menu. For details, see “Slide Show Menu Options” on page 79.	
File	Information	Determines whether file information is displayed. Select On or Off.
	Protect	Allows you to the protect the MPEG1 file from any changes. When an MPEG1 file is protected, it cannot be deleted. Select On or Off.
	Delete	Deletes the MPEG1 file from the Memory Stick. You cannot delete an MPEG1 file that has been protected (or if the Memory Stick is locked).

 MPEG1 files that are protected are indicated by the Lock  icon.

Memory Stick Index Menu Bar Options

Slide Show Menu Options

 The Slide Show menu is the same whether you select it from the Memory Stick Index (page 72), Photo (page 74), or Movie (page 77) menus.



 When you select Complete List, it may take a moment to display the list of all MP3 files.

 Some JPEG files may take longer to display than others, which may make it seem longer than the interval you selected for Slide Duration.

The Slide Show menu includes the following options:

Option	Description
Start	Starts the Slide Show.
Music	Allows you to select background audio to play during the Slide Show.
Off	No additional background audio is played during the Slide Show. Audio that is associated with the JPEG or MPEG1 files will play.
Play All	Plays all MP3 files on the Memory Stick. The Piano MP3 file is not played.
Piano	Plays the MP3 file stored in the TV's internal memory. (This file is indicated by a different color than the MP3 files on the Memory Stick.)
(List of MP3 Files)	Displays a list of all MP3 files found at the top level (root) of the Memory Stick. To show additional MP3 files stored in other folders on the Memory Stick, select Complete List.
Complete List	Displays a list of all available MP3 files. The list is sorted in alphabetical order, grouped by folder.
Transition Effect	Allows you to select an effect to be used when advancing to the next file in the Slide Show.
Off	Uses a quick change, or cut.
Fade	Uses a cross fade.
Wipe →	Uses a linear sweep that moves across the screen, revealing the next image while covering the previous image.
Wipe ←	
Wipe ↑	
Wipe ↓	
Random	Randomly cycles through all Transition Effects.
Slide Duration	Allows you to specify a timed slide advance after a selected time interval. Select from 3 sec, 5 sec, 10 sec, 30 sec, 1 min, 5 min.
Repeat	On Slide Show continuously loops.
	Off Slide Show plays once through all files and ends.

Folder Menu Options

 Files that are protected are indicated by the Lock  icon.

 The Rotate and Protect functions do not change the file's modification date.

The Folder menu includes the following options:

Option	Description
Select Contents	Allows you to select different folders to view in the Memory Stick Viewer.
Digital Camera Folders	Selects all folders within the directories defined by the DCF rules used by Sony digital cameras (see page 81). JPEG and MPEG1 files in those directories are recognized even if they do not conform to the DCF file naming rules.
Select a Folder	Allows you to access individual folders on the Memory Stick.
Protect	Allows you to protect files from any changes. When a file is protected, it cannot be rotated or deleted. The Protect options affect files currently shown in the Memory Stick Index.
Protect All	Protects all files.
Protect None	Unprotects all files.
File Order	Allows you to change the order in which the Memory Stick files are displayed.
Date Order	Displays files in chronological order by modification date.
Date Order Reverse	Displays files in reverse chronological order by modification date.
Alphabetical	Displays files in alphabetical order by filename.
Filter	Allows you to selectively display specific file types within the selected folder.
Show All	Displays all readable files.
Show Photos Only	Displays only photo (JPEG) files.
Show Movies Only	Displays only movie (MPEG1) files.

Memory Stick Menu

The Memory Stick menu displays the current status of the Memory Stick, including total capacity, used capacity, and free capacity.

Notes on Using Memory Stick Media

About DCF File Names

Most Sony brand digital still and video cameras automatically record still photo and movie files using DCF compliant directory and file names.

If you selected the *Digital Camera Folders* option, as described on page 80, you might want to have your digital camera's instruction manual handy in order to check how files and directories are organized for your specific model of digital camera.

DCF stands for "Design Rules for Camera File Systems," which are specifications established by the Japan Electronic Industry Development Association (JEIDA).

Memory Stick Precautions

When using Memory Stick media, follow these precautions:

- To avoid permanent damage to still image data, do not turn off the TV or remove Memory Stick media from the insertion slot while data is being read (as indicated by the Memory Stick indicator light being on).
- Avoid touching the terminal of Memory Stick media or bringing it into contact with a metal object.
- Do not drop, bend, or submit Memory Stick media to external shock.
- Do not disassemble or modify Memory Stick media.
- Avoid getting liquid on Memory Stick media.
- Apply labels only within the designated label area.

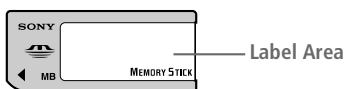

- To avoid permanent damage to still image data, do not use or store Memory Stick media in a location subject to:
 - High temperature (such as near a heater or inside a hot car)
 - High humidity
 - Direct sunlight
 - Corrosive substances
 - Magnetic fields
 - Excessive dust
 - Static electricity or electric noise
 - Electric surges
- Store and carry Memory Stick media in its original case to ensure protection of stored data.
- Save a backup of stored data.

Using i.LINK

About i.LINK

This TV is equipped with i.LINK, which provides a secure digital interface to other digital home entertainment devices, such as digital VCRs, digital camcorders, set-top boxes, and other devices that also are equipped with i.LINK. i.LINK allows for the secure transfer of copyright-protected digital content between these devices and your digital television.

i.LINK is a trademark of Sony Corporation and used only to designate that a product contains an IEEE 1394 connector.

All products with an i.LINK connector may not communicate with each other.

Using i.LINK Cables

This TV has three S400 i.LINK terminals (one in the front panel, and two in the back panel). You can use the following i.LINK cables with this TV:

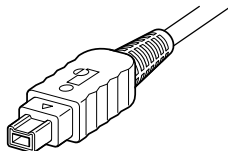

4-pin i.LINK cable

Sony Model	Length
VMC-IL4415	1.5 meters
VMC-IL4435	3.5 meters

 Do not use cables other than the ones listed above.

Connecting i.LINK Devices

 Before connecting this unit to i.LINK-compatible equipment, read the instruction manual of the i.LINK device to be connected.

To connect a digital i.LINK device (using only a digital signal)

- 1 Using an i.LINK cable (see page 83), connect the device's i.LINK jack to either of the TV's i.LINK jacks.

To connect an i.LINK device that supports an EIA-775A connection

- 1 Using an i.LINK cable (see page 83), connect the device's i.LINK jack to either of the TV's i.LINK jacks.
- 2 Using an A/V cable, connect the i.LINK device's A/V output jacks to the TV's VIDEO 3 A/V input jacks.

 Only one i.LINK cable should connect the TV and any given i.LINK device.

Notes on Using This Connection

To Do This ...	Do This ...
Set up a digital i.LINK device	For digital i.LINK devices (devices that require only the i.LINK connection), no setup is necessary. The TV automatically recognizes the device as soon as the connection is made.
Set up an i.LINK device that supports an EIA-775A analog connection	<ul style="list-style-type: none">❑ Connect analog A/V cables to the VIDEO 3 input (see page 84).❑ Use the i.LINK Control Panel to activate the analog connection to your i.LINK device (see page 89).

Notes on Connecting i.LINK Devices

To connect two or more i.LINK devices, use i.LINK cables to connect them as shown below.

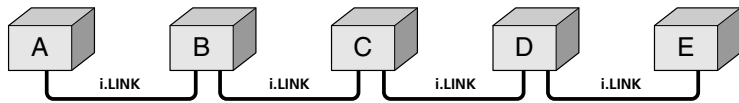

You can connect up to 63 i.LINK devices. However, the maximum number of cables in any serial route is 16.

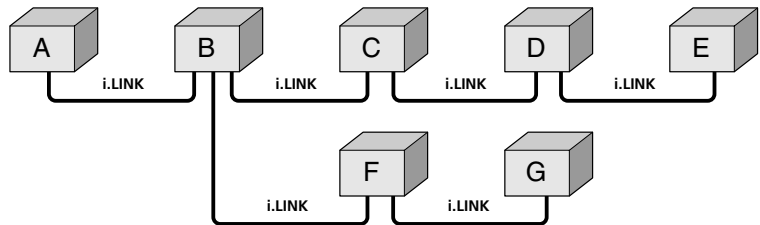

Do not connect i.LINK devices in a way that creates a loop.

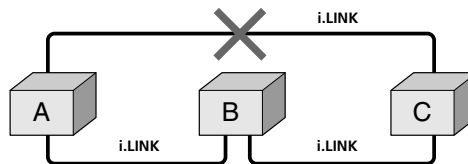

Connecting non-compatible devices, such as PCs or PC peripherals, may result in malfunctions.

Selecting an i.LINK Device

Before an i.LINK device can be viewed, it must first be selected via the i.LINK Device List.

- 1 Connect the i.LINK device that you wish to operate.



 For instructions on connecting i.LINK devices, see page 84.

- 2 Press i.LINK on the remote control.





The TV (DTV), along with all devices connected by i.LINK to the TV, appear on the Device List.

Devices that are not supported by the TV appear on the Device List as “Other Device,” but cannot be controlled using the TV’s remote control or on-screen i.LINK Control Panel. For these devices, use the remote control supplied with the device.

- 3 Move the joystick  or  to navigate among the i.LINK-connected devices.

 i.LINK devices can be connected to one another and to the TV while the TV is powered on. The Device List will automatically update to include the newly-connected device. See page 84 for more information on connecting i.LINK devices.



- 4 Press  to select the desired device and display the device's i.LINK Control Panel. Use the i.LINK Control Panel to operate the selected device. For details, see page 87.





 i.LINK functions are not available while using the following TV features: Twin View, Freeze, Scrolling Index, and Memory Stick.

Using the i.LINK Control Panel

After you select an i.LINK device using the Device List, the TV displays the i.LINK Control Panel, which allows you to use the TV's remote to control the selected i.LINK device.

- 1 If the i.LINK Control Panel is not already displayed, press i.LINK on the remote control.

 If i.LINK is pressed while the TV is displaying an analog or digital channel (not the i.LINK device), then the Device List will appear. Select the desired device from the list and press  to display the Control Panel.







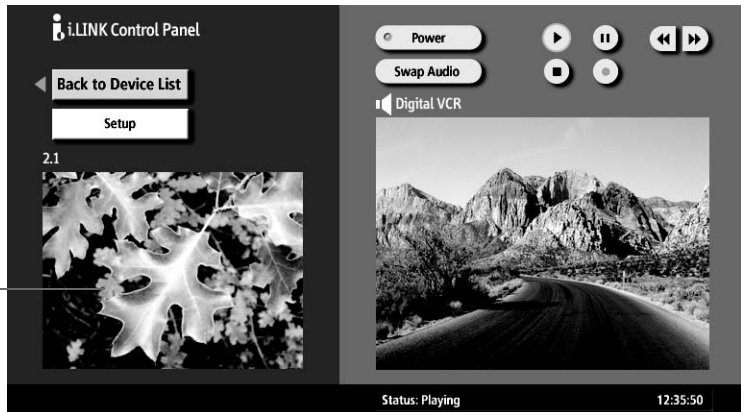







- 2 Move the remote control's joystick     to navigate through the options available in the i.LINK Control Panel.
- 3 Press  to select a desired option.
- 4 Press EXIT to exit the Control Panel and view the i.LINK device full-screen.

 To exit i.LINK mode, select DTV from the Device List or press CH+/-.

The DTV window appears only if the i.LINK menus were entered while watching a digital TV channel



The i.LINK Control Panel displays the signal from the TV to the left (if available), and the signal from the currently selected device to the right.

To Do This ...	Do This ...
Go to the Device List	Move the joystick to highlight Back to Device List and press  .
Change the audio being played from the TV to the current selected device, and vice versa	Move the joystick to highlight Swap Audio and press  . An icon appears next to the window that currently has sound.
Play a recording from the selected i.LINK camcorder or digital VCR	Move the joystick to highlight  and press  .
Fast-forward or rewind a recording from the selected i.LINK camcorder or digital VCR	Move the joystick to highlight  or  and press  .
Record from TV to the selected i.LINK digital VCR	If the  (record) button is available, move the joystick to highlight  and press  .
Stop a recording from the selected i.LINK digital VCR	Move the joystick to highlight  and press  .
Turn the selected device power on and off	Move the joystick to highlight Power and press  .
Setup the selected device	Move the joystick to highlight Setup and press  . For more details on Setup, see page 89.

Notes About Controlling i.LINK Devices

- ❑ You can control the functions of the selected i.LINK device by using the equivalent buttons on the TV's remote control. To program the remote control to operate i.LINK devices, see "Programming the Remote Control" on page 49.
- ❑ Some options on the i.LINK Control Panel may not be available, depending on the device being controlled.
- ❑ Only i.LINK-equipped digital camcorders and digital VCRs can be controlled directly through the i.LINK Control Panel.
- ❑ Not all functions are supported for all i.LINK devices.

i.LINK Setup

You can use the i.LINK Control Panel to access digital setup options, some of which are also available through the Digital Program Guide (described on page 63).

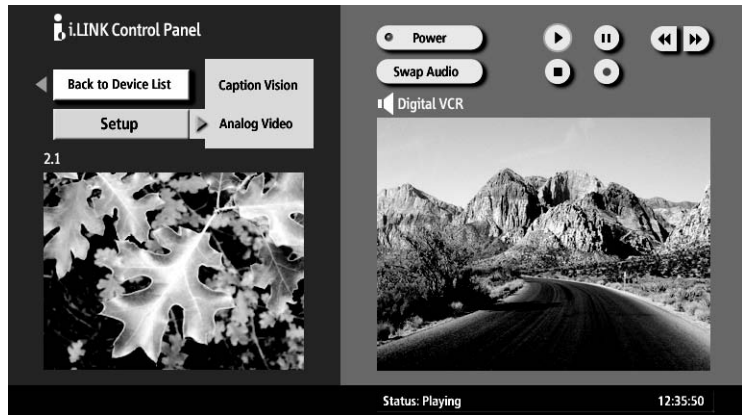

To Do This ...

Set up the selected device

Set up Caption Vision

Set up i.LINK Analog Video
(Set-Top Box)

Do This ...

Move the joystick to highlight Setup and press \oplus .

Once i.LINK Setup has been selected, move the joystick to Caption Vision, and press \oplus .

 For details about setting up Caption Vision, see "Using the Caption Vision Menu" on page 65.

The TV is able to accept an analog signal from a selected set-top box. The set-top box must be EIA-775A compliant and must be connected to the TV's VIDEO 3 input. To associate the device with the TV's analog VIDEO 3 input, move the joystick to Analog Video and press \oplus . All EIA-775A-compliant devices will be shown in the list. Select the desired device from the list and press \oplus .







Notes on i.LINK

- ❑ The TV can act as an i.LINK repeater, so that i.LINK signals can be relayed to another device even when the TV is powered off. To enable this feature, set the i.LINK Standby option to On using the Setup Menu as described on page 103.
- ❑ Parental Control settings apply to the signal from a selected device. For more details, see page 100.

Using the Menu

Overview

The Menu gives you access to the following features:

Menu Icon	Description	Page
	Allows you to make adjustments to your picture settings. It also allows you to customize the Picture Mode based on the type of program you are viewing, select Advanced Video options, and more.	92
	Offers enhanced audio options such as listening to second audio programming (SAP) or customizing the Effect of the sound on your TV.	94
	Allows you to make Wide Mode adjustments and make changes to the screen's vertical center.	96
	Allows you to set up a Favorite Channel list, run the Auto Program function, skip and label channels, and more.	98
	Lets you control the viewing of programs based on their ratings.	100
	Provides options for setting up your system, including selecting closed caption modes, setting the Timer, labeling video inputs, selecting the language of the on-screen menus, and more.	103

 Press MENU to enter and exit Menu.

Navigating Through Menus

 Menus include navigation help text that appears at the bottom of each Menu.

To Do This ...	Press
Display the Menu	MENU
Move through the Menu	← →
Move through the Menu options	↑ ↓
Select an option to change	⊕
Change an option's settings	↑ ↓ ← →
Select (confirm) changed setting	⊕ or ←
Exit the Menu	MENU



Using the Video Menu

To select the Video Menu

- 1 Press MENU.
- 2 Move the joystick ← or → to highlight the Video icon and press Ⓢ.
- 3 Move the joystick to highlight an option. Press Ⓢ to select an option.
- 4 Move the joystick ↑ ↓ ← → to change settings. Press Ⓢ to select the changed setting.
- 5 Press MENU to exit the Menu.

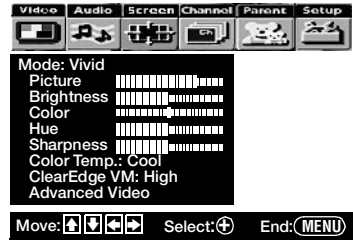

To restore the factory default settings for the Video settings (excluding Advanced Video) of the Mode (Vivid, Standard, etc.) the TV is set to:

- ❑ Press RESET on the remote control when in the Video Menu.

The Video Menu includes the following options:

Option	Description
Mode	Vivid
<i>Customized picture viewing</i>	Standard
	Movie
	Pro
Picture	Adjust to increase picture contrast and deepen the color, or decrease picture contrast and soften the color.
Brightness	Adjust to brighten or darken the picture.
Color	Adjust to increase or decrease color intensity.
Hue	Adjust to increase or decrease the green tones.
Sharpness	Adjust to sharpen or soften the picture.
Color Temp.	Cool
<i>White intensity adjustment</i>	Neutral
	Warm
ClearEdge VM	Sharpens picture definition to give every object a sharp, clean edge. Select from High, Medium, Low, Off.
<i>Velocity Modulation</i>	

Selecting Video Options





To change from one Mode to another, use the PIC MODE button on the remote control.



You can alter the Video Menu settings (Picture, Brightness, Color, etc.) for each Mode.

 To change quickly from one DRC Mode to another, use the DRC MODE button on the remote control.

 Advanced Video options are not available (grayed out) when watching 480p, 720p, and 1080i sources.

 To change quickly from one DRC Palette to another, use the DRC PALETTE button on the remote control.

 For best results, adjust the Reality by moving the joystick   until you are satisfied with the level of detail. Then adjust the Clarity by moving the joystick   until you have a smooth image.

Option	Description
Advanced Video	Select Program to choose among the DRC Mode and DRC Palette options while viewing NTSC sources.
DRC Mode	Creates a high-resolution picture with 4x density, for high quality sources (i.e., DVD player, satellite receiver).
Interlaced	Recommended for moving pictures.
Progressive	Recommended for still images and text.
CineMotion	Provides an optimized display by automatically detecting film content and applying a reverse 3-2 pulldown process. Moving pictures will appear clearer and more natural-looking.
DRC Palette	<p>Allows you to customize the level of detail (Reality) and smoothness (Clarity) for up to three input sources. For example, you can create one Custom setting to optimize your cable input's picture, and create another to optimize your DVD player's picture. You can switch among the three Custom settings using the DRC PALETTE button on the remote control.</p> <ol style="list-style-type: none"> 1 Move the joystick to highlight Custom 1, Custom 2, or Custom 3 and then press . The DRC Palette appears. 2 Move the joystick to adjust the position of the marker (●). As you move the ● higher along the Reality axis, the picture becomes more detailed. As you move the ● to the right along the Clarity axis, the picture becomes smoother. 3 To save the setting, press . <p>To return the Custom options to the default factory settings, press the RESET button.</p>

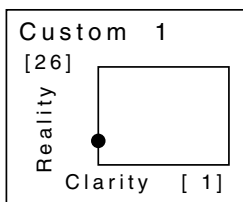



Using the Audio Menu

To select the Audio Menu

- 1 Press MENU.
- 2 Move the joystick ← or → to highlight the Audio icon and press Ⓢ.
- 3 Move the joystick to highlight an option. Press Ⓢ to select an option.
- 4 Move the joystick ↑ ↓ ← → to change settings. Press Ⓢ to select the changed setting.
- 5 Press MENU to exit the Menu.



To restore the factory default settings for Treble, Bass, and Balance

- Press RESET on the remote control when in the Audio Menu.

Selecting Audio Options

The Audio Menu includes the following options:

Option	Description
Treble	Adjust to decrease or increase higher-pitched sounds.
Bass	Adjust to decrease or increase lower-pitched sounds.
Balance	Adjust to emphasize left or right speaker balance.
Steady Sound	On Select to stabilize the volume.
	Off Select to turn off Steady Sound.
Effect	TruSurround Select for surround sound (for stereo programs only).
	Simulated Adds a surround-like effect to mono programs.
	Off Normal stereo or mono reception.
MTS <i>Enjoy stereo, bilingual and mono programs</i>	Stereo Select for stereo reception when viewing a program broadcast in stereo.
	Auto SAP Select to automatically switch the TV to second audio programs when a signal is received. (If no SAP signal is present, the TV remains in Stereo mode.)
	Mono Select for mono reception. (Use to reduce noise during weak stereo broadcasts.)
BBE	On Select to give sound more impact by compensating for phase effects in speakers.
	Off Select for normal stereo or mono reception.

 To change quickly from one Effect to another, use the Ⓢ button on the inside panel of the remote control.

<i>Option</i>	<i>Description</i>	
Speaker	On	Select to turn on the TV speakers.
	Off	Select to turn off the TV speakers and listen to the TV's sound only through your external audio system speakers.
Audio Out <i>Easy control of volume adjustments</i>	This option can be set only when the <i>Speaker</i> option is set to Off.	
	Variable	The TV's speakers are turned off, but the audio output from your audio system can still be controlled by the TV's remote control.
	Fixed	The TV's speakers are turned off and the audio output of the TV is fixed. Use your audio receiver's remote control to adjust the volume (and other audio settings) through your audio system.



Using the Screen Menu

To select the Screen Menu

- 1 Press MENU.
- 2 Move the joystick ← or → to move to the Screen icon and press ⊕.
- 3 Move the joystick ↑ or ↓ to move to an option. Press ⊕ to select an option.
- 4 Move the joystick ← → ↑ ↓ to change settings. Press ⊕ to select the changed setting.
- 5 Press MENU to exit the Menu.

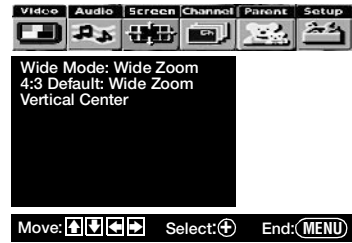

Selecting Screen Mode Options

 To change from one Wide Mode to another, use the WIDE MODE button on the remote control.

 For Wide Zoom and Zoom modes, you can adjust the vertical position of the picture. For details, see page 97.



The Screen menu includes the following options:

Option	Description
Wide Mode <i>Select a Wide Mode to use for 4:3 sources</i>	Wide Zoom Select to enlarge the 4:3 size picture, while the upper and lower parts of the picture are condensed to fit the wide screen.
Normal	Select to return the 4:3 picture to a 4:3 aspect ratio.
Full	Select to enlarge the 4:3 picture horizontally only, to fill the wide screen.
Zoom	Select to enlarge the 4:3 picture horizontally and vertically to an equal aspect ratio that fills the wide screen.

Wide Mode is unavailable while in Twin View, or when viewing HD (1080i, 720p) sources.

 **In some cases, wide-screen programs will be shown in aspect ratios that require the display of black bands at the top and bottom of your 16:9 screen. For more details, see page 113.**

 If 4:3 Default is set to anything but Off, the Wide Mode setting changes only for the current channel. When you change channels (or inputs), Wide Mode is automatically replaced with the 4:3 Default setting. To retain the current Wide Mode setting as channels and inputs are changed, set 4:3 Default to Off.

Option	Description	
4:3 Default <i>Select the default Screen Mode to use for 4:3 sources</i>	Wide Zoom	Select to enlarge the 4:3 size picture, while the upper and lower parts of the picture are condensed to fit the wide screen.
	Normal	Select to return the 4:3 picture to normal mode.
	Full	Select to enlarge the 4:3 picture horizontally only, to fill the wide screen.
	Zoom	Select to enlarge the 4:3 picture horizontally and vertically to an equal aspect ratio that fills the wide screen.
	Off	Select to continue using the current Wide Mode setting when the channel or input is changed.
Vertical Center	Allows you to move the position of the picture up and down in the window. (Available only in Wide Zoom and Zoom modes.) Move the joystick  or  and press  to choose a correction between +15 and -15 (Zoom mode), and +10 and -10 (Wide Zoom mode).	



Using the Channel Menu

To select the Channel Menu

- 1 Press MENU.
- 2 Move the joystick ← or → to highlight the Channel icon and press ⊕.
- 3 Move the joystick to highlight an option. Press ⊕ to select an option.
- 4 Move the joystick ↑ ↓ ← → to change settings. Press ⊕ to select the changed setting.
- 5 Press MENU to exit the Menu.



Selecting Channel Options

The Channel Menu includes the following options:

Option	Description
Favorite Channels	Lets you set up a list of your favorite channels. For details, see "Using Favorite Channels" on page 60.
Channel Fix	Off Turns off Channel Fix.
<i>Useful when you have a cable box or satellite receiver connected</i>	2-6 "Fix" your TV's channel setting to 2-6 and use the cable box or satellite receiver to change channels. Select one of these settings if you connected the equipment to the VHF/UHF jack.
	Cable 2-6 Same as 2-6, except you select one of these settings if you connected the equipment to the CABLE jack (see page 17).
	Video 1 Use this setting if you have connected the equipment to the A/V input jacks.
Auto Program	Automatically sets up the channel list on the TV for all receivable channels. ⚠ Auto Program may take several minutes. A progress bar will display the approximate progress of the Auto Program and Digital Channel Add sequences.
Digital Channel	Add Select to add digital channels.
Channel Skip/Add	Allows you to customize the analog channels that appear when you use the CH+/- buttons. <ol style="list-style-type: none"> 1 Move the joystick ↑ or ↓ to scroll through the channels until you find the channel you want to skip or add. Then press ⊕ to select it. 2 Move the joystick ↑ or ↓ to toggle between Add or Skip. Then press ⊕ to select. 3 To add or skip more channels, repeat steps 1 and 2. 4 Move the joystick ← to return to the Channel Menu, or press MENU to exit the Menus.

Channels that you set to be skipped can be accessed only by direct (0-9 buttons) tuning.

<i>Option</i>	<i>Description</i>
Channel Label	<p>Allows you to assign labels (such as station call letters) to channel numbers. You can label up to 40 channels.</p> <ol style="list-style-type: none">1 Move the joystick to highlight Channel and press ⊕.2 Move the joystick ↑ ↓ to scroll through the channel numbers. Then press ⊕ to select the channel number that you want to assign a label.3 Move the joystick to highlight Label and press ⊕.4 Move the joystick ↑ ↓ to scroll through the label characters (A-Z, 0-9, etc.). Then press ⊕ to select the highlighted character.5 Repeat to add up to 5 characters to the label.6 To assign labels to more channels, repeat steps 1-4.7 Move the joystick ← to return to the Channel Menu, or press MENU to exit the Menus.



Using the Parent Menu

The Parent Menu allows you to set up the TV to block programs according to their content and rating levels.



To select the Parent Menu

- 1 Press MENU.
- 2 Move the joystick \leftarrow or \rightarrow to highlight the Parent icon and press \oplus .
- 3 Use the 0-9 buttons on the remote control to enter a four-digit password.
- 4 If this is the first time you are creating this password, confirm the password by entering it again. (The Parent Menu options appear.)
- 5 Move the joystick \uparrow \downarrow \leftarrow \rightarrow to change settings. Press \oplus to select the changed setting.
- 6 Press MENU to exit the Menu.

You need your password for any future access into the Parent Menu. If you lose your password, see "Lost password" on page 114.

Selecting Parent Options

If you are not familiar with the Parental Guideline rating system, you should select Child, Youth, or Young Adult to help simplify the rating selection. To set more specific ratings, select Custom.

For descriptions of Child, Youth, and Young Adult ratings, see page 101.

The Parent Menu includes the following options:

Option	Description
Parental Lock	Off Parental lock is off. No programs are blocked from viewing.
Turn ratings on/off and select a rating system	Child Maximum ratings permitted are: <input type="checkbox"/> US: TV-Y, TV-G, G <input type="checkbox"/> Canada: C, G, TV-Y
	Youth Maximum ratings permitted are: <input type="checkbox"/> US: TV-PG, PG <input type="checkbox"/> Canada: C8+, PG, 8 ans+, TV-PG
	Y. Adult Maximum ratings permitted are: <input type="checkbox"/> US: TV-14, PG-13 <input type="checkbox"/> Canada: 14+, 13 ans+, TV-14
	Custom Select to set ratings manually. <input type="checkbox"/> US: See page 101 for details. <input type="checkbox"/> Canada: See page 102 for details.
Change Password	For changing your password.
Select Country	U.S.A. Select to use USA ratings (see page 101).
	Canada Select to use Canadian ratings (see page 102).

US Models: Selecting Custom Rating Options

 The Content-Based Ratings are linked to the level of the Age-Based Rating. For example, a program with an Age-Based Rating of TV-PG V (Violence) rating may contain moderate violence, while a TV-14 V (Violence) rating may contain more intense violence.

 To ensure maximum blocking capability, set the Age-Based Ratings.

 If you block unrated TV programs, be aware that the following types of programs may be blocked: programs broadcast from another country, emergency broadcasts, political programs, sports, news, public service announcements, religious programs and weather.

For US models, the Custom Rating Menu includes the following options. (For Canadian models, see page 102.)

Option	Description
Movie Rating	G All children and General Audience.
	PG Parental Guidance suggested.
	PG-13 Parental Guidance for children under 13.
	R Restricted viewing, parental guidance is suggested for children under 17.
	NC-17 and X No one 17 or under allowed.
TV Rating	Age-Based Ratings
<i>Block programs by their rating, content or both</i>	TV-Y All children.
	TV-Y7 Directed to children age 7 and older.
	TV-G General Audience.
	TV-PG Parental Guidance suggested.
	TV-14 Parents Strongly cautioned.
	TV-MA Mature Audience only.
	Content-Based Ratings
	FV Fantasy Violence.
	D Suggestive Dialogue.
	L Strong Language.
	S Sexual situations.
	V Violence.
Unrated <i>Block programs or movies that are broadcast without a rating</i>	Block Blocks all programs and movies that are broadcast without a rating.
	Allow Allows programs and movies that are broadcast without a rating.

Viewing Blocked Programs

You can view blocked programs by entering the password. Press the ENTER button when tuned to a blocked program, then enter the password. This temporarily switches off the Parental Lock. To reactivate the Parental Lock settings, turn off the TV. When the TV is turned on again, your Parental Lock settings are reactivated.

Canadian Models: Selecting Custom Rating Options

For Canadian models, the Custom Rating Menu includes the following options. (For US models, see page 101.)

<i>Option</i>	<i>Description</i>	
English Rating	C	All children.
	C8+	Children 8 years and older.
	G	General programming.
	PG	Parental Guidance.
	14+	Viewers 14 and older.
French Rating	18+	Adult programming.
	G	General programming.
	8 ans+	Not recommended for young children.
	13 ans+	Not recommended for ages under 13.
U.S.A. Rating	16 ans+	Not recommended for ages under 16.
	18 ans+	Programming restricted to adults.
		See "US Models" on page 101 for details.

Viewing Blocked Programs

You can view blocked programs by entering the password. Press the ENTER button when tuned to a blocked program, then enter the password. This temporarily switches off the Parental Lock. To reactivate the Parental Lock settings, turn off the TV. When the TV is turned on again, your Parental Lock settings are reactivated.



Using the Setup Menu

To select the Setup Menu

- 1 Press MENU.
- 2 Move the joystick ← or → to highlight the Setup icon and press ⊕.
- 3 Move the joystick to highlight an option. Press ⊕ to select an option.
- 4 Move the joystick ↑ ↓ ← → to change settings. Press ⊕ to select the changed setting.
- 5 Press MENU to exit the Menu.







Selecting Setup Options



















 Caption Vision options in the Setup Menu apply only to analog programs. To set up closed captioning for digital programs, see "Using the Caption Vision Menu" on page 65.







The Setup Menu includes the following options:

Option	Description
Caption Vision	Allows you to select from three closed caption modes (for programs that are broadcast with closed caption).
CC1, CC2, CC3, CC4	Displays a printed version of the dialog or sound effects of a program. (Should be set to CC1 for most programs.)
Text1, Text2, Text3, Text4	Displays network/station information presented using either half or the whole screen (if available). For closed captioning, set to CC1.
Info	Displays the program name and the time remaining in the program (if the broadcaster offers this service). Displays when the channel is changed or the DISPLAY button is pressed.
Off	Turns off Caption Vision.

 The Skip label is useful for inputs that do not have equipment connected to them.

 To go directly to programming Timer 1 or 2, press  instead of moving the joystick .

Option	Description							
Video Label	<p>Allows you to identify A/V equipment you connected to the TV, such as a VCR, DVD, etc. For example, if you have a DVD player connected to the VIDEO 5 jack, you can select the label DVD for the VIDEO 5 input. Then when you press the TV/VIDEO button to change inputs, the Video Label you assigned to that input appears on screen.</p> <ol style="list-style-type: none"> 1 Move the joystick  or  to highlight the video input (VIDEO 1-7) to which you want to assign a label. Then press . 2 Move the joystick  or  to highlight one of the displayed labels. Then press . <p>You can select from the following labels for each input:</p> <table border="1"> <tr> <td>Video 1/2/3/4</td> <td>VHS, DVD, Receiver, Satellite, Cable Box, 8mm, DTV, LD, Beta, Skip</td> </tr> <tr> <td>Video 5/6/7</td> <td>DVD, Satellite, Cable Box, DTV, HD, Skip</td> </tr> </table> <p> If you select Skip, your TV skips this input when you press the TV/VIDEO button.</p>	Video 1/2/3/4	VHS, DVD, Receiver, Satellite, Cable Box, 8mm, DTV, LD, Beta, Skip	Video 5/6/7	DVD, Satellite, Cable Box, DTV, HD, Skip			
Video 1/2/3/4	VHS, DVD, Receiver, Satellite, Cable Box, 8mm, DTV, LD, Beta, Skip							
Video 5/6/7	DVD, Satellite, Cable Box, DTV, HD, Skip							
Language	Select to display all on-screen Menus in your language of choice.							
Clock/Timers	<p>Select to set the clock and to program your TV to turn on and off at two scheduled viewing times.</p> <table border="1"> <tr> <td>Timer 1</td> <td rowspan="2">You can use the Timers to program the TV to turn on and off and tune to a specific channel at two scheduled viewing times.</td> </tr> <tr> <td>Timer 2</td> </tr> </table> <p>Timer 1 and Timer 2 are not available to be set until you set the Current Time.</p> <ol style="list-style-type: none"> 1 Move the joystick  or  to highlight Timer 1 or Timer 2. To set the timer, move the joystick . 2 Move the joystick  or  to highlight one of the following options, then press . <table border="1"> <tr> <td>Program</td> <td>Select to set the Timer by day, time, duration, and channel.</td> </tr> <tr> <td>Off</td> <td>Select to turn off the Timer. (Your previous settings are saved.)</td> </tr> </table> 3 If you selected Program in step 2, move the joystick  and  to set the day(s), hour, minute, duration, and channel number. Press  or move the joystick  to confirm each setting and move to the next setting. Move the joystick  to go back to the previous setting. 4 Press MENU to exit the Menu. An LED on the front panel will light, indicating the timer has been set. 	Timer 1	You can use the Timers to program the TV to turn on and off and tune to a specific channel at two scheduled viewing times.	Timer 2	Program	Select to set the Timer by day, time, duration, and channel.	Off	Select to turn off the Timer. (Your previous settings are saved.)
Timer 1	You can use the Timers to program the TV to turn on and off and tune to a specific channel at two scheduled viewing times.							
Timer 2								
Program	Select to set the Timer by day, time, duration, and channel.							
Off	Select to turn off the Timer. (Your previous settings are saved.)							

<i>Option</i>	<i>Description</i>	
Clock/Timers (continued)	<p>Current Time</p> <ol style="list-style-type: none"> 1 Press  to select Current Time. 2 Move the joystick  and  to set the current time (day, hour, and minute). Press  (or move the joystick ) to confirm each setting and move to the next setting. Move the joystick  to go back to the previous setting. 3 Press MENU to exit the Menu. 	
Flash Focus	Allows you to adjust the convergence automatically. For details, see page 42.	
Convergence	Allows you to fine-tune the convergence manually. For details, see page 43.	
i.LINK Standby	On	Allows the i.LINK signal to pass through to connected i.LINK devices even when the TV is turned off. The front panel i.LINK Standby LED shows orange. The TV uses more standby power than when this option is set to Off.
	Off	Does not allow the i.LINK signal to pass through to connected i.LINK devices when the TV is turned off. The front panel i.LINK Standby LED shows red. The TV uses less standby power than when this option is set to On.
Demo	Runs a demonstration of on-screen Menus.	

 You can also access Flash Focus by pressing the FLASH FOCUS button on the front panel of the TV. For details, see pages 14-15.

Other Information

Overview

This chapter includes the following topics:

<i>Topic</i>	<i>Page</i>
Glossary	108
Contacting Sony	109
Troubleshooting	109
Specifications	115
Optional Accessories	116
Index	117

Glossary

analog signal A signaling method that uses continuous changes in the amplitude or frequency of an electronic transmission to convey information.

aspect ratio Refers to the ratio between the width and height of the screen. This TV has a 16:9 (widescreen) aspect ratio, as opposed to a 4:3 aspect ratio.

4:3 aspect ratio



16:9 aspect ratio



component video



Component video is sent through three cables: two color shade (chrominance) signals and one brightness (luminance) signal. Component video achieves greater color accuracy than composite video or S VIDEO by splitting chrominance into two separate portions.

composite video



Composite video is sent through a single cable. Composite video combines the color shade (chrominance) and brightness (luminance) information into one video signal.

digital television (DTV)

A new technology for transmitting and receiving broadcast television signals. DTV provides higher resolution and improved sound quality over analog television.

National Television System Committee (NTSC)

A unit of the Federal Communications Commission, Washington, DC, that establishes television standards in the United States, such as NTSC Color, the standard used in this TV.

RF

Radio Frequency. That part of the frequency spectrum that is used to transmit TV and radio signals.

S VIDEO



S VIDEO requires a single cable, which carries the brightness (luminance) and color (chrominance) signals of the picture separately. S VIDEO provides better resolution than composite video, which carries the signals together.

VHF/UHF

VHF (Very High Frequency) is the part of the frequency spectrum from 30 to 300 megahertz. UHF (Ultra High Frequency) is the part of the frequency spectrum from 300 to 3,000 megahertz.

480i

Provides 480 lines of resolution. Displays images using interlaced scanning, which first transmits all the odd lines on the TV screen and then the even lines.

480p

Provides 480 lines of resolution. Displays images using progressive scanning, which transmits each line from top to bottom.

720p

Provides 720 lines of resolution. Displays images using progressive scanning, which transmits each line from top to bottom.

1080i

Provides 1080 lines of resolution. Displays images using interlaced scanning, which first transmits all the odd lines on the TV screen and then the even lines. 1080i is one of the formats used by HDTV (High Definition TV).

Contacting Sony

If, after reading these operating instructions, you have additional questions related to the use of your Sony television, please call our Customer Information Services Center at 1-800-222-SONY (7669) (US residents only) or (416) 499-SONY (7669) (Canadian residents only).

Before calling Sony customer support, please write down the model and serial numbers of your TV. You'll find this information on the front cover of this manual.

Troubleshooting

If you are having problems with your TV, you can reset all the TV's settings to their original factory default settings, as follows.

 **Notice:** The following procedure resets all custom settings, channel lists, etc., to the factory default settings.

- 1 Turn on the TV.
- 2 Hold down the RESET button on the remote control.
- 3 Press the POWER button on the front panel of the TV.
- 4 Release the RESET button on the remote control.

Twin View

Problem	Possible Remedies
I cannot get Twin View to work	<ul style="list-style-type: none"><input type="checkbox"/> If you are using a cable box to unscramble all channels (as shown on page 22), you cannot use the Twin View feature. This is because the cable box can unscramble only one channel at a time. But if you need the cable box to unscramble only some (usually premium) channels, you can use Twin View for unscrambled channels if you connect both a cable and cable box, as shown on page 21.<input type="checkbox"/> You can use Twin View to view a signal from a different source that is connected to the TV's A/V jacks (such as a VCR or DVD player) in the second window by pressing the TV/VIDEO button while in Twin View.<input type="checkbox"/> Sources connected to the CABLE, VIDEO 5, VIDEO 6, and VIDEO 7 inputs, as well as digital sources, display in the left Twin View window, but not the right.
There is no Twin View window, or it is just static	<ul style="list-style-type: none"><input type="checkbox"/> Be sure the Twin View window is set to a video input or channel that has a signal airing.<input type="checkbox"/> You might be tuned to a video input with nothing connected to it. Try cycling through the video inputs by pressing the TV/VIDEO button.
Twin View cannot display anything but TV channels	<ul style="list-style-type: none"><input type="checkbox"/> Try cycling through the video inputs by pressing the TV/VIDEO button. Check that the Video Label option is not set to Skip. (See the Setup Menu on page 104.)
Twin View displays the same program in both windows	<ul style="list-style-type: none"><input type="checkbox"/> Both Twin View windows might be set to the same channel. Try changing channels in either window.

Remote Control

<i>Problem</i>	<i>Possible Remedies</i>
Remote control does not operate	<ul style="list-style-type: none"><input type="checkbox"/> The batteries could be weak. Replace the batteries.<input type="checkbox"/> Check the orientation of the batteries.<input type="checkbox"/> Press the TV FUNCTION button. You may have inadvertently pressed the SAT/CABLE FUNCTION button, which changes the remote control to SAT or CABLE mode.<input type="checkbox"/> Make sure the TV's power cord is connected securely to the wall outlet.<input type="checkbox"/> Locate the TV at least 3-4 feet away from fluorescent lights.
Cannot change channels with the remote control	<ul style="list-style-type: none"><input type="checkbox"/> If you are using the TV to change channels, first press the TV FUNCTION button.<input type="checkbox"/> If you are using another device to change channels, be sure you have not inadvertently switched your TV from the channel 3 or 4 setting. Use the Channel Fix option to "fix" the channel based on the hookup you used (see page 98).<input type="checkbox"/> If you are using another device to change channels, be sure to press the FUNCTION button for that device. For example, if you are using your cable box to change channels, be sure to press the SAT/CABLE FUNCTION button.
Remote control does not operate non-Sony video equipment	<ul style="list-style-type: none"><input type="checkbox"/> If you replaced the batteries to the remote recently, the code numbers for the video equipment may need to be reset.<input type="checkbox"/> There may be more than one code for the equipment that you are attempting to operate.<input type="checkbox"/> There is a possibility that some non-Sony equipment cannot be operated by your Sony TV remote. You may need to use the equipment's original remote control.

Channels

<i>Problem</i>	<i>Possible Remedies</i>
Cannot receive upper channels (UHF) when using an antenna	<ul style="list-style-type: none"><input type="checkbox"/> Use Auto Program in the Channel Menu to add receivable channels that are not presently in the TV's memory (see page 98).
TV is fixed to one channel	<ul style="list-style-type: none"><input type="checkbox"/> Use Auto Program in the Channel Menu to add receivable channels that are not presently in the TV's memory (see page 98).<input type="checkbox"/> Check your Channel Fix settings (see page 98).
Cannot receive any channels when using cable TV	<ul style="list-style-type: none"><input type="checkbox"/> Use Auto Program in the Channel Menu to add receivable channels that are not presently in the TV's memory (see page 98).
Cannot receive or select channels	<ul style="list-style-type: none"><input type="checkbox"/> Use Auto Program in the Channel Menu to add receivable TV channels that are not presently in TV memory (see page 98).
Some digital cable channels are not being displayed	<ul style="list-style-type: none"><input type="checkbox"/> Certain cable companies have limitations on the broadcast of digital cable channels. Check with your cable company for more information.<input type="checkbox"/> The digital cable channel may be set to Hide in the Digital Setup Menu (see page 65).<input type="checkbox"/> Use the Add Digital Channels feature to search for new digital channels (see page 65).

Memory Stick

Problem	Possible Remedies
Image does not display/ Cannot see all files	<ul style="list-style-type: none"> <input type="checkbox"/> Make sure the image file is a JPEG (.jpg, .jpeg) file or an MPEG1 (.mpg, mpeg) file. <input type="checkbox"/> Make sure the Memory Stick is inserted properly (see pages 69-70). <input type="checkbox"/> Check the Filter option setting (see page 80). <input type="checkbox"/> Check the Select Contents setting (see page 80) and ensure that files are either in DCF directories if Digital Camera Folders is selected (see page 80), or in the currently selected folder if Select a Folder is selected (see page 80). <input type="checkbox"/> The maximum number of files the Memory Stick Viewer can display is 1,024. <input type="checkbox"/> If you are using a Memory Stick with the Memory Select function, try changing the position of the A/B select switch.
JPEG image displays undesirable motion or flicker in full screen	<ul style="list-style-type: none"> <input type="checkbox"/> JPEGs captured using a digital video camera may appear to display motion in full screen. This is a result of the way digital video cameras record still images, and is not a result of a malfunction with the TV.
Rotation not saved after Memory Stick is ejected or Memory Stick Viewer is closed	<ul style="list-style-type: none"> <input type="checkbox"/> The Memory Stick might be locked. Unlock the Memory Stick and try rotating the image again. <input type="checkbox"/> The file might not have information (EXIF data) that is usually generated when a digital camera records a photo. In this case, it is not possible to save the rotation. <input type="checkbox"/> There might be insufficient space on the Memory Stick to save the rotated file. Try deleting one or more files and rotating the image again.
Cannot show (or hide) file information in full screen or Slide Show	<ul style="list-style-type: none"> <input type="checkbox"/> Set the File/Information option to On or Off (see pages 75 and 78).
Cannot see menu	<ul style="list-style-type: none"> <input type="checkbox"/> Move the joystick \uparrow to display the menu again.
Cannot hear audio while using Memory Stick	<ul style="list-style-type: none"> <input type="checkbox"/> Check the TV's volume or Speaker (page 95) settings. <input type="checkbox"/> To hear JPEG voice memo, select the Digital Camera Folders option and set the Filter option to Show All. <input type="checkbox"/> Check that the Music option is not set to Off (see page 79).
Not all MP3 files on Memory Stick are included when the Music /Complete List option is selected (page 79)	<ul style="list-style-type: none"> <input type="checkbox"/> The maximum number of MP3 files the Memory Stick Viewer can display is 128. <input type="checkbox"/> Make sure that the file is named with the file extension (.mp3).
MPEG1 movie does not play back correctly	<ul style="list-style-type: none"> <input type="checkbox"/> Some variations of MPEG1 movies may not be compatible with the Memory Stick Viewer.
MPEG1 quality is poor when enlarged (page 77)	<ul style="list-style-type: none"> <input type="checkbox"/> The quality of the movie when enlarged depends on the resolution of the MPEG1 file. See your camera's instruction manual for details.
MP3 files on the Memory Stick are not listed	<ul style="list-style-type: none"> <input type="checkbox"/> Only MP3 files that are named with the file extension (.mp3) are displayed in the list.
Music files are playing in wrong order	<ul style="list-style-type: none"> <input type="checkbox"/> MP3 files are played in alphabetical order, according to the folder in which they are stored. If you want to change the playlist order, rename your files alphabetically in the order in which you want them to play.
Cannot see MP3 list to play music	<ul style="list-style-type: none"> <input type="checkbox"/> MP3 files on your Memory Stick only can be played as background music during a Slide Show (see page 79).

Problem	Possible Remedies	
and adjust the TV' Error message is displayed	<input type="checkbox"/> No Memory Stick	There is no Memory Stick in the slot.
	<input type="checkbox"/> Memory Stick Locked	The lock mechanism on the Memory Stick is engaged.
	<input type="checkbox"/> Memory Stick Error	The Memory Stick in the slot might be damaged; try a different Memory Stick.
	<input type="checkbox"/> Format Error	The Memory Stick may have been formatted using a PC or other device that is not compatible with cameras.
Error icon is displayed		The file is not a valid MPEG1 or JPEG format.
		The thumbnail is not DCF-compatible.
		The file is a JPEG or an MPEG1, but the thumbnail is unreadable.
		The file is unreadable.

Audio

Video

Problem	Possible Remedies
No picture (screen not lit), no sound	<ul style="list-style-type: none"> <input type="checkbox"/> If your TV does not turn on, and a red light keeps flashing, your TV may need service. Call your local Sony Service Center. <input type="checkbox"/> Make sure the power cord is plugged in. <input type="checkbox"/> Press the POWER button on the front of the TV. <input type="checkbox"/> Press the TV/VIDEO button to cycle through the connected video sources. <input type="checkbox"/> Try another channel; it could be station trouble.
Dark, poor or no picture (screen lit), good sound	<ul style="list-style-type: none"> <input type="checkbox"/> Adjust the Picture option in the Video Menu (see page 92). <input type="checkbox"/> Adjust the Brightness option in the Video Menu (see page 92). <input type="checkbox"/> Check the antenna/cable connections.
No color	<ul style="list-style-type: none"> <input type="checkbox"/> Adjust the Color option in the Video Menu (see page 92).
Only snow and noise appear on the screen	<ul style="list-style-type: none"> <input type="checkbox"/> Check the antenna/cable connections. <input type="checkbox"/> Try another channel; it could be station trouble. <input type="checkbox"/> Press ANT to change the input mode (see page 46).
Dotted lines or stripes	<ul style="list-style-type: none"> <input type="checkbox"/> Adjust the antenna. <input type="checkbox"/> Move the TV away from noise sources such as cars, neon signs, or hair-dryers.
Double images or ghosts	<ul style="list-style-type: none"> <input type="checkbox"/> Using a highly directional outdoor antenna or a cable may solve the problem.
"Black box" on screen	<ul style="list-style-type: none"> <input type="checkbox"/> You have selected a text option in the Setup Menu and no text is available. (See page 103 to reset Setup selections.) To turn off this feature, set the Caption Vision option to Off. If you were trying to select closed captioning, select CC1 instead of Text 1-4.
Black bands appear at the top and bottom of the screen	<ul style="list-style-type: none"> <input type="checkbox"/> Some wide-screen programs are filmed in aspect ratios that are greater than 16:9 (this is especially common with theatrical releases). Your TV will show these programs with black bands at the top and bottom of the screen. For more details, check the documentation that came with your DVD (or contact your program provider).
Certain programs on DVD or other digital sources display a loss of detail, especially during fast-motion or dark scenes	<ul style="list-style-type: none"> <input type="checkbox"/> The compression used by certain digital broadcasts and DVDs may cause your TV's screen to display less detail than usual, or cause artifacts (small blocks or dots, pixelations) to appear on your screen. This is due to your TV's large screen and ability to show very fine detail, and is normal for certain digitally recorded programs. Adjust the reality/clarity in the DRC Palette menu (see page 93) to optimize the picture while viewing these sources.

General

Problem	Possible Remedies
How to reset TV to factory settings	<input type="checkbox"/> Turn on the TV. While holding down the RESET button on the remote control, press the POWER button on the TV. (The TV will turn itself off, then back on again.) Release the RESET button.
How to restore Video settings to factory settings	<input type="checkbox"/> Press the RESET button on the remote control while in the Video Menu (see page 92).
How to restore Audio settings to factory settings	<input type="checkbox"/> Press the RESET button on the remote control while in the Audio Menu (see page 94).
Cannot cycle through the other video equipment connected to the TV	<input type="checkbox"/> Be sure the Video Label option is not set to Skip (see page 104).
Cannot operate Menu	<input type="checkbox"/> If a menu option appears in gray, this indicates that the TV is in a state in which the menu option is not available.
Lost password	<input type="checkbox"/> In the password screen (see page 100), enter the following master password: 4357. The master password clears your previous password; it cannot be used to temporarily unblock channels.
LED on front panel is lit	<input type="checkbox"/> The STAND BY LED (see page 15) blinks when the TV is turned on, then shuts off when the picture is displayed. If the LED blinks continuously, this may indicate the TV needs service. <input type="checkbox"/> The TIMER LED (see page 15) indicates that the timer is set. When the timer is set, this LED will remain lit even when the TV is turned off. <input type="checkbox"/> The i.LINK STANDBY LED blinks when the signal from an i.LINK device is being shown.
The signal from a selected i.LINK device is not being displayed	<input type="checkbox"/> If you have several i.LINK devices connected and operating at once, the TV may not be able to display the signal from the selected device. Turn the other i.LINK devices off, and reselect the desired i.LINK device.

Specifications

Projection System	3 picture tubes, 3 lenses, horizontal in-line system	
Picture Tube	7-inch high-brightness monochrome tubes (6.3 raster size), with optical coupling and liquid cooling system	
Projection Lenses	High performance, large diameter hybrid lens F1.1	
Antenna	75 ohm external terminal for VHF/UHF	
Television System	NTSC, American TV Standard	
Channel Coverage	VHF	2-13
	UHF	14-69
	DTV	1-999
	CATV	1-125
Power Requirements	120V, 60 Hz	
Inputs/Outputs		
DVI-HDTV	1 terminal, 3.3V T.M.D.S., 50 ohms The DVI-HDTV input terminal is compliant with the EIA-861 standard and is not intended for use with personal computers.	
Video (IN)	4 total (1 on front panel)	1 Vp-p, 75 ohms unbalanced, sync negative
S Video (IN)	3 total (1 on front panel)	Y: 1 Vp-p, 75 ohms unbalanced, sync negative C: 0.286 Vp-p (Burst signal), 75 ohms
Audio (IN)	7 total (1 on front panel)	500 mVrms (100% modulation) Impedance: 47 kilohm
Component Video Input	2 (Y, P _B , P _R)	Y: 1.0 Vp-p, 75 ohms unbalanced, sync negative; P _B : 0.7 Vp-p, 75 ohms P _R : 0.7 Vp-p, 75 ohms
Digital Audio Optical Output PCM/Dolby Digital	1	Optical Rectangular (1)
CONTROLS (IN/OUT)	1	
i.LINK	3 total (1 on front panel)	4-pin S400 i.LINK terminal
Variable/Fixed Audio (OUT)	1	More than 408 mVrms at the maximum volume setting (Variable) More than 408 mVrms (Fixed) Impedance (output): 2 kilohms
Supplied Accessories	Remote Control	RM-Y192
	AA (R6) Batteries	2 supplied for remote control
Screen Size (measured diagonally)	KDP-51WS550	51 inches
	KDP-57WS550	57 inches
	KDP-65WS550	65 inches
Speaker Output	20W x 2	
Dimensions (W x H x D)	KDP-51WS550	1194 x 1350 x 650 mm (47 x 53 1/8 x 25 5/8 in)
	KDP-57WS550	1326 x 1377 x 690 mm (52 1/4 x 54 3/16 x 27 1/8 in)
	KDP-65WS550	1542 x 1507 x 735 (60 3/4 x 59 1/4 x 28 15/16 in)
Mass	KDP-51WS550	79.3 Kg (174.5 lbs)
	KDP-57WS550	87.0 Kg (191.5 lbs)
	KDP-65WS550	139.5 Kg (307 lbs)
Power Consumption	In Use	295 W
	In Standby	Under 1 W
	In i.LINK Standby	Under 17 W

Design and specifications are subject to change without notice.

Optional Accessories

- ❑ A/V Cable (VMC-810/820/830 HG)
- ❑ Audio Cable (RKC-515HG)
- ❑ Component Video Cable (VMC-10/30 HG)
- ❑ Control S Cable (RK-G69HG)
- ❑ i.LINK cables: VMC-IL4415 (4-pin to 4-pin, 1.5 meters); VMC-IL4435 (4-pin to 4-pin, 3.5 meters)

Index

0-9 buttons 47, 54, 58
16:9 aspect ratio 56
4:3 aspect ratio 56
4:3 Default settings 97

A

Add Digital Channels 65
Advanced Video 93
Alternate Audio 64
Alternate Video 64
ANT button 46, 54
antenna, connecting 19
Audio Menu 91, 94
Audio Out 95
audio receiver, connecting 38
Auto Program (channel setup) 41, 98
Auto SAP, MTS setting 94

B

balance, adjusting 94
bass, adjusting 94
batteries, inserting in remote 45
BBE 94
bilingual audio 94
blocking programs. *See ratings.*
brightness, adjusting 92

C

cable
connecting 19
with VCR, connecting 24
cable box
connecting with VCR 26
Twin View issues 57
using with TV remote control 52
CABLE jack, described 17
Caption Vision 103
Caption Vision menu, for digital channels 65

carrying the TV 12
CATV. *See cable*
CH buttons 15, 47
changing picture size, in Twin View 59
Channel Menu 91, 98
Channel Show/Hide 65
Channel Skip/Add 98
channels, creating labels 99
CineMotion 10, 46, 93
ClearEdge VM 10, 92
clearing, Favorite Channels 60
closed caption modes 91, 103
CODE SET button 46
color, adjusting 92
CONTROL S 40
CONTROL S IN/OUT jacks, described 17
Convergence 15, 105
adjusting automatically 42
adjusting manually 43
convergence 105
Cool, Color Temperature 92

D

Demo, Menus 105
DIGITAL AUDIO OPTICAL jack 17
Digital Caption Setup 65
Digital Caption Setup menu 66
digital channels, adding 98
Digital Reality Creation 9
Digital Setup menu 65
Digital Signal Strength 65
digital subchannels 64
Digital Visual Interface (DVI) 10, 17
DISC MENU button 48, 52
DISPLAY button 47, 54
DRC Mode 93
DRC MODE button 46

DRC Palette 93
DRC PALETTE button 47
DRC. *See Digital Reality Creation.*
DVD player

connecting 34, 36
using with TV remote control 52

DVI. *See Digital Visual Interface.*

DVI-HDTV 17, 115

E

Effect button 48
ENTER button 47, 54, 58
error messages, Memory Stick 112
EXIT button 47

F

Fast-forward button 48
Favorite Channels
clearing 60
in Channel Menu 98
using 60
FAVORITES button 46
features 9
Fixed audio setting 95
Flash Focus 42, 105
FLASH FOCUS button 15
FREEZE button 47, 61
Freeze, using 61
Full Mode 56
Full mode, setting 96

G

GUIDE button 47, 63
Guide menu 64

H

HD Detailer 10
HD/DVD IN (1080i/720p/480p/480i) jacks, described

- 17
- hue, adjusting 92
- I**
- i.LINK 10, 13, 83–89
- i.LINK button 46
- I.LINK jack, described 17
- i.LINK Standby 15, 105
- i.LINK/AV1-3/DVD slide switch 48
- INDEX button 46, 55
- Infrared Receiver 15
- interlaced 9, 46, 93, 108
- J**
- joystick 46
- JUMP button 47, 54
- L**
- label, channels 99
- Language, setting 104
- M**
- MDP, using with TV remote control 52
- Memory Stick
 - button 47
 - Duo 70
 - features 67
 - Index 72
 - indicator (LED) 15
 - inserting 69
 - insertion slot 15
 - panning photos 76
 - photo options 75
 - playing movies 77
 - precautions 82
 - removing 71
 - rotating photos 76
 - slide show options 79
 - troubleshooting 111
 - Viewer, described 10
 - viewing photos 74
 - zooming photos 76
- MENU button 46, 48, 54, 60, 91
- Menus
 - Audio 91, 94
 - Channel 91, 98
 - Parent 91, 100
 - Setup 91, 103
 - Video 91, 92, 96
- MONITOR OUT 17
- Mono, MTS setting 94
- Movie mode 92
- MTS 94
- MTS/SAP button 48
- MUTING button 46, 54
- N**
- Neutral, Color Temperature 92
- Normal mode 56, 96
- O**
- off, turning off the TV 15
- on, turning on the TV 15
- P**
- Parent Menu 91, 100
- parental control, described 10
- password, changing 100
- Pause button 48
- PIC MODE button 47
- picture contrast, adjusting 92
- Picture in Picture. *See Twin View.*
- Play button 48
- POWER button 15
- powering on/off, the TV 15
- presetting channels 98
- Pro (Video) mode 92
- problems, troubleshooting 109–114
- Program Guide 63
- Program Options menu 64
- progressive 9, 46, 93, 108
- R**
- ratings, setting 100–102
- ratings, viewing blocked programs 101, 102
- Record buttons 48
- remote control
 - inserting batteries 45
 - programming 49–50
- removing, Favorite Channels 60
- RESET button 46, 93
- resetting, Audio options 94
- Rewind button 48
- S**
- S VIDEO jack, described 13, 17
- SAT/CABLE
 - FUNCTION button 47
 - POWER button 47
- satellite receiver, using with TV remote control 51
- Scrolling Index, using 55
- SELECT button 48
- Setup Menu 91, 103
- sharpness, adjusting 92
- Simulated, Effect 94
- sizing, picture in Twin View 59
- SLEEP button 46
- speakers
 - turning on/off 95
 - using external speakers 95
- specifications 115
- STAND BY indicator 15, 114
- Standard mode 92
- Steady Sound
 - described 10
 - setting 94
- Stereo, MTS setting 94
- Stop button 48
- surround sound 94
- SYSTEM OFF button 48
- T**
- Timer 104
- TIMER indicator 15, 114
- timers, setting 104
- transport buttons 48
- treble, adjusting 94
- troubleshooting 109–114
- TruSurround 94
- TruSurround, Effect 94
- turning on/off the TV 15
- TV FUNCTION button 47, 54
- TV POWER button 47, 54
- TV/VCR button 48

TV/VIDEO button 15, 46, 54

Twin View

button 47

described 10

using 57–59

V

Variable audio setting 95

VCR

using with TV remote
control 51

with cable box, connecting
26

with cable, connecting 24

with satellite receiver,
connecting 32

VCR/DVD button 48

Vertical Center, adjusting 97

VHF/UHF jack, described 17

VIDEO (L/R)/AUDIO jacks,
described 17

Video Menu 91, 92

Video modes, selecting 92

Vivid mode 92

VOL buttons 15, 46, 54

W

Warm, Color Temperature 92

Wide Mode 56, 96

WIDE MODE button 46, 56

Wide Screen, described 9

Wide Zoom mode 56, 96

Z

zoom feature, with Twin
View 59

Zoom Mode 56, 96

LIMITED WARRANTY

This warranty is applicable to U.S. residents only. If you are a Canadian resident, see the separately enclosed warranty for your product.

Sony Electronics Inc. ("Sony") warrants this Product (including any accessories) against defects in material or workmanship, subject to any conditions set forth as follows:

1. **LABOR:** For a period of 90 days from the date of purchase, if this Product is determined to be defective, Sony will repair or replace the Product, at its option, at no charge, or pay the labor charges to any Sony authorized service facility. After the Warranty Period, you must pay for all labor charges.
2. **PARTS:** In addition, Sony will supply, at no charge, new or rebuilt replacements in exchange for defective parts for a period of one (1) year (color picture tube- two (2) years). After 90 days from the date of purchase, labor for removal and installation is available from Sony authorized service facilities or a Sony Service Center at your expense.
3. **ACCESSORIES:** Parts and labor for all accessories are for one (1) year.

In-home diagnostic warranty service is provided during the initial 90 day period for 19" (measured diagonally), or larger screen size through a Sony authorized service facility.

To obtain warranty service, you must take the Product, or deliver the Product freight prepaid, in either its original packaging or packaging affording an equal degree of protection, to any authorized Sony service facility.

This warranty does not cover customer instruction, installation, set up adjustments or signal reception problems.

This warranty does not cover cosmetic damage or damage due to acts of God, accident, misuse, abuse, negligence, commercial use, or modification of, or to any part of the Product, including the antenna. This warranty does not cover damage due to improper operation or maintenance, connection to improper voltage supply, or attempted repair by anyone other than facility authorized by Sony to service the Product. This warranty does not cover Products sold AS IS or WITH ALL FAULTS, or consumables (such as fuses or batteries). This warranty is valid only in the United States.

Proof of purchase in the form of a bill of sale or receipted invoice which is evidence that the unit is within the Warranty period must be presented to obtain warranty service.

This warranty is invalid if the factory applied serial number has been altered or removed from the Product.

REPAIR OR REPLACEMENT AS PROVIDED UNDER THIS WARRANTY IS THE EXCLUSIVE REMEDY OF THE CONSUMER. SONY SHALL NOT BE LIABLE FOR ANY INCIDENTAL OR CONSEQUENTIAL DAMAGES FOR BREACH OF ANY EXPRESS OR IMPLIED WARRANTY ON THIS PRODUCT, EXCEPT TO THE EXTENT PROHIBITED BY APPLICABLE LAW, ANY IMPLIED WARRANTY OF MERCHANTABILITY OR FITNESS FOR A PARTICULAR PURPOSE ON THIS PRODUCT IS LIMITED IN DURATION TO THE DURATION OF THIS WARRANTY.

Some states do not allow the exclusion or limitation of incidental or consequential damages, or allows limitations on how long an implied warranty lasts, so the above limitations or exclusions may not apply to you. In addition, if you enter into a service contract with the Sony Partnership within 90 days of the date of sale, the limitation on how long an implied warranty lasts does not apply to you. This warranty gives you specific legal rights, and you may have other rights which vary from state to state.

For your convenience, Sony Electronics Inc. has established telephone numbers for frequently asked questions:

To locate the servicer or dealer nearest you, or for service assistance or resolution of a service problem, or for product information or operation, call:

Sony Customer Information Service Center

1-(800)-222-7669

Or visit the Sony Web Site:

www.sony.com

For an accessory or part not available from your authorized dealer, call:

1-(800)-488-SONY(7669)

Free Manuals Download Website

<http://myh66.com>

<http://usermanuals.us>

<http://www.somanuals.com>

<http://www.4manuals.cc>

<http://www.manual-lib.com>

<http://www.404manual.com>

<http://www.luxmanual.com>

<http://aubethermostatmanual.com>

Golf course search by state

<http://golfingnear.com>

Email search by domain

<http://emailbydomain.com>

Auto manuals search

<http://auto.somanuals.com>

TV manuals search

<http://tv.somanuals.com>