

SONY®

SONY

LCD Projection TV KF-42WE610/50WE610/60WE610

GRAND WEGA



LCD Projection TV HD-Monitor Operating Instructions

KF-42WE610
KF-50WE610
KF-60WE610



If, after reading this instruction manual, you have additional questions related to the use of your Sony projection TV, please call one of the following numbers (English only).

Customers in the continental United States
contact the Direct Response Center at:

1-800-222-SONY (7669)

Customers in Canada contact the
Customer Relations Center at:

(416) 499-SONY (7669)

<http://www.sony.net/>

Printed in U.S.A.

© 2003 Sony Corporation

WARNING

To prevent fire or shock hazard, do not expose the LCD Projection TV to rain or moisture.

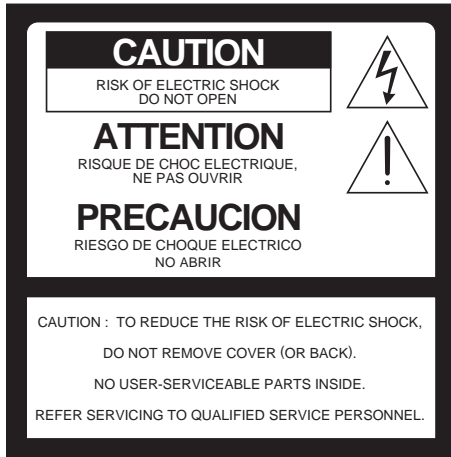

This symbol is intended to alert the user to the presence of uninsulated “dangerous voltage” within the product’s enclosure that may be of sufficient magnitude to constitute a risk of electric shock to persons.



This symbol is intended to alert the user to the presence of important operating and maintenance (servicing) instructions in the literature accompanying the appliance.

CAUTION

To prevent electric shock, do not use this polarized AC plug with an extension cord, receptacle or other outlet unless the blades can be fully inserted to prevent blade exposure.

Note on Caption Vision

This television receiver provides display of television closed captioning in accordance with §15.119 of the FCC rules.

Owner’s Record

The model and serial numbers are located at the rear of the LCD Projection TV, below the Sony logo, on the sticker, and also on the TV box (white label). Record these numbers in the spaces provided below. Refer to them whenever you call upon your Sony dealer regarding this product.

Model No. _____

Serial No. _____

Note to CATV system installer

This reminder is provided to call the CATV system installer’s attention to Article 820-40 of the NEC that provides guidelines for proper grounding and, in particular, specifies that the cable ground shall be connected to the grounding system of the building, as close to the point of cable entry as practical.

Use of this television receiver for other than private viewing of programs broadcast on UHF, VHF, transmitted by cable companies or satellite for the use of the general public may require authorization from the broadcaster/cable company and/or program owner.

NOTIFICATION

This equipment has been tested and found to comply with the limits for a Class B digital device pursuant to Part 15 of the FCC Rules. These limits are designed to provide reasonable protection against harmful interference in a residential installation. This equipment generates, uses, and can radiate radio frequency energy and, if not installed and used in accordance with the instructions, may cause harmful interference with radio communications. However, there is no guarantee that interference will not occur in a particular installation. If this equipment does cause harmful interference to radio or television reception, which can be determined by turning the equipment off and on, the user is encouraged to try to correct the interference by one or more of the following measures:

- Reorient or relocate the receiving antennas.
- Increase the separation between the equipment and receiver.
- Connect the equipment into an outlet on a circuit different from that to which the receiver is connected.
- Consult the dealer or an experienced radio/TV technician for help.

You are cautioned that any changes or modifications not expressly approved in this manual could void your warranty and your authority to operate this equipment.

This document is for the remote control RM-Y913.
MODEL: KF-42WE610, KF-50WE610, KF-60WE610
Please keep this notice with the instruction manual.

Safety

- ❑ Operate the LCD Projection TV only on 120 V AC.
- ❑ The plug is designed, for safety purposes, to fit into the wall outlet only one way. If you are unable to insert the plug fully into the outlet, contact your dealer.
- ❑ If any liquid or solid object should fall inside the cabinet, unplug the LCD Projection TV immediately and have it checked by qualified service personnel before operating it further.
- ❑ If you will not be using the LCD Projection TV for several days, disconnect the power by pulling the plug itself. Never pull on the cord.

For details concerning safety precautions, see “Important Safeguards” on page 4.

Installing

- ❑ To prevent internal heat buildup, do not block the ventilation openings.
- ❑ Do not install the LCD Projection TV in a hot or humid place, or in a place subject to excessive dust or mechanical vibration.
- ❑ Avoid operating the LCD Projection TV at temperature below 41°F (5°C).
- ❑ If the LCD Projection TV is transported directly from a cold to a warm location, or if the room temperature changes suddenly, the picture may be blurred or show poor color. In this case, please wait a few hours to let the moisture evaporate before turning on the LCD Projection TV.
- ❑ To obtain the best picture, do not expose the screen to direct illumination or direct sunlight. It is recommended to use spot lighting directed down from the ceiling or to cover the windows that face the screen with opaque drapery. It is desirable to install the LCD Projection TV in a room where the floor and walls are not of a reflective material.



As an ENERGY STAR® Partner, Sony Corporation has determined that this product meets the ENERGY STAR® guidelines for energy efficiency.

ENERGY STAR® is a U.S. registered mark.

TruSurround, SRS and the (●)® symbol are trademarks of SRS Labs, Inc.

TruSurround technology is incorporated under license from SRS Labs, Inc.

BBE and BBE Symbol are trademarks of BBE Sound, Inc. and are licensed by BBE Sound, Inc. under U.S. Patent No. 4,638,258 and 4,482,866.

Important Safety Instructions

- 1) Read these instructions.
- 2) Keep these instructions.
- 3) Heed all warnings.
- 4) Follow all instructions.
- 5) Do not use this apparatus near water.
- 6) Clean only with dry cloth.
- 7) Do not block any ventilation openings. Install in accordance with the manufacturer's instructions.
- 8) Do not install near any heat sources such as radiators, heat registers, stoves, or other apparatus (including amplifiers) that produce heat.
- 9) Do not defeat the safety purpose of the polarized or grounding-type plug. A polarized plug has two blades with one wider than the other. A grounding type plug has two blades and a third grounding prong. The wide blade or the third prong are provided for your safety. If the provided plug does not fit into your outlet, consult an electrician for replacement of the obsolete outlet.
- 10) Protect the power cord from being walked on or pinched particularly at plugs, convenience receptacles, and the point where they exit from the apparatus.
- 11) Only use attachments/accessories specified by the manufacturer.
- 12) Use only with the cart, stand, tripod, bracket, or table specified by the manufacturer, or sold with the apparatus. When a cart is used, use caution when moving the cart/apparatus combination to avoid injury from tip-over. 
- 13) Unplug this apparatus during lightning storms or when unused for long periods of time.
- 14) Refer all servicing to qualified service personnel. Servicing is required when the apparatus has been damaged in any way, such as power-supply cord or plug is damaged, liquid has been spilled or objects have fallen into the apparatus, the apparatus has been exposed to rain or moisture, does not operate normally, or has been dropped.
- 15) Apparatus shall not be exposed to dripping or splashing and no objects filled with liquids, such as vases, shall be placed on the apparatus.

Important Safeguards

For your protection, please read these instructions completely, and keep this manual for future reference.

Carefully observe and comply with all warnings, cautions and instructions placed on the set or described in the operating instructions or service manual.

WARNING

To guard against injury, the following basic safety precautions should be observed in the installation, use and servicing of the set.

Use

Power Sources

This set should be operated only from the type of power source indicated on the serial/model plate. If you are not sure of the type of electrical power supplied to your home, consult your dealer or local power company. For those sets designed to operate from battery power, refer to the operating instructions. 

Grounding or Polarization

This set is equipped with a polarized AC power cord plug (a plug having one blade wider than the other), or with a three-wire grounding type plug (a plug having a third prong for grounding). Follow the instructions below:

For the set with a polarized AC power cord plug

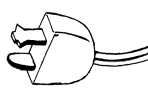
This plug will fit into the power outlet only one way. This is a safety feature. If you are unable to insert the plug fully into the outlet, try reversing the plug. If the plug still fails to fit, contact your electrician to have a suitable outlet installed. Do not defeat the safety purpose of the polarized plug by forcing it in. 

Alternate Warning for the set with a three-wire grounding type AC plug

This plug will only fit into a grounding-type power outlet. This is a safety feature. If you are unable to insert the plug into the outlet, contact your electrician to have a suitable outlet installed. Do not defeat the safety purpose of the grounding plug. 

Overloading

Do not overload wall outlets, extension cords or convenience receptacles beyond their capacity, since this can result in fire or electric shock.

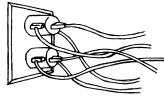

Always turn the set off when it is not being used. When the set is left unattended and unused for long periods of time, unplug it from the wall outlet as a precaution against the possibility of an internal malfunction that could create a fire hazard.



If a snapping or popping sound from a TV set is continuous or frequent while the TV is operating, unplug the TV and consult your dealer or service technician. It is normal for some TV sets to make occasional snapping or popping sounds, particularly when being turned on or off.

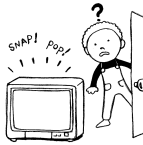

Object and Liquid Entry

Never push objects of any kind into the set through the cabinet slots as they may touch dangerous voltage points or short out parts that could result in a fire or electric shock. Never spill liquid of any kind on the set.



Attachments

Do not use attachments not recommended by the manufacturer, as they may cause hazards.

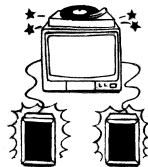

Cleaning

Clean the cabinet of the LCD Projection TV with a dry soft cloth. To remove dust from the screen, wipe it gently with a soft cloth. Stubborn stains may be removed with a cloth slightly dampened with solution of mild soap and warm water. Never use strong solvents such as thinner or benzine for cleaning.



If the picture becomes dark after using the LCD Projection TV for a long period of time, it may be necessary to clean the inside of the LCD Projection TV. Consult qualified service personnel.

On contamination on the screen surface

The screen surface has a special coating to reduce a picture displayed by reflecting. If you clean the screen surface in the wrong way, the screen may be damaged. To clean the screen, do as follows:

- ❑ Clean the screen with a soft cloth, such as the supplied cleaning cloth or a glass cleaning cloth.
- ❑ To remove hard contamination, use the supplied cleaning cloth or a glass cleaning cloth moistened with a solution of mild detergent and water.
- ❑ Do not use any type of abrasive pad, alkaline cleaner, acid cleaner, scouring powder, chemical cloth, or solvent such as alcohol, benzene or thinner, as these may scratch the screen's coating.

Installation

Water and Moisture

Do not use power-line operated sets near water — for example, near a bathtub, washbowl, kitchen sink, or laundry tub, in a wet basement, or near a swimming pool, etc.



Accessories

Do not place the set on an unstable cart, stand, table or shelf. The set may fall, causing serious injury to a child or an adult and serious damage to the set. Use only a cart or stand recommended by the manufacturer for the specific model of LCD Projection TV. An appliance and cart combination should be moved with care. Quick stops, excessive force, and uneven surfaces may cause the appliance and cart combination to overturn.



Ventilation

The slots and openings in the cabinet and in the back or bottom are provided for necessary ventilation. To ensure reliable operation of the set, and to protect it from overheating, these slots and openings must never be blocked or covered.

- ❑ Never cover the slots and openings with a cloth or other materials.



- ❑ Never block the slots and openings by placing the set on a bed, sofa, rug or other similar surface.



- ❑ Never place the set in a confined space, such as a bookcase or built-in cabinet, unless proper ventilation is provided.



- ❑ Do not place the set near or over a radiator or heat register, or where it is exposed to direct sunlight.



Power-Cord Protection

Do not allow anything to rest on or roll over the power cord, and do not place the set where the power cord is subject to wear or abuse.



Antennas

Outdoor Antenna Grounding

If an outdoor antenna is installed, follow the precautions below. An outdoor antenna system should not be located in the vicinity of overhead power lines or other electric light or power circuits, or where it can come in contact with such power lines or circuits.

WHEN INSTALLING AN OUTDOOR ANTENNA SYSTEM, EXTREME CARE SHOULD BE TAKEN TO KEEP FROM CONTACTING SUCH POWER LINES OR CIRCUITS AS CONTACT WITH THEM IS ALMOST INVARIABLY FATAL.

Be sure the antenna system is grounded so as to provide some protection against voltage surges and built-up static charges.

Section 810 of the National Electrical Code (NEC) in USA and Section 54 of the Canadian Electrical Code in Canada provides information with respect to proper grounding of the mast and supporting structure, grounding of the lead-in wire to an antenna discharge unit, size of grounding conductors, location of antenna discharge unit, connection to grounding electrodes, and requirements for the grounding electrode.

Antenna Grounding According to the NEC

Refer to section 54-300 of Canadian Electrical Code for Antenna Grounding.

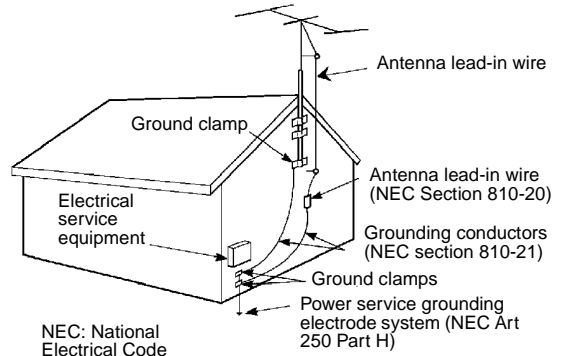





Lightning

For added protection for this television receiver during a lightning storm, or when it is left unattended and unused for long periods of time, unplug it from the wall outlet and disconnect the antenna. This will prevent damage to the receiver due to lightning and power-line surges.

Service

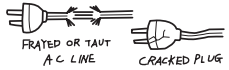
Damage Requiring Service

Unplug the set from the wall outlet and refer servicing to qualified service personnel under the following conditions:

- ❑ When the power cord or plug is damaged or frayed. 
- ❑ If liquid has been spilled into the set. 
- ❑ If the set has been exposed to rain or water.
- ❑ If the set has been subject to excessive shock by being dropped, or the cabinet has been damaged. 
- ❑ If the set does not operate normally when following the operating instructions. Adjust only those controls that are specified in the operating instructions. Improper adjustment of other controls may result in damage and will often require extensive work by a qualified technician to restore the set to normal operation. 
- ❑ When the set exhibits a distinct change in performance, it indicates a need for service. 

Servicing

Do not attempt to service the set by yourself since opening the cabinet may expose you to dangerous voltage or other hazards. Refer all servicing to qualified service personnel.



Replacement Parts

When replacement parts are required, be sure the service technician certifies in writing that he has used replacement parts specified by the manufacturer that have the same characteristics as the original parts.

Unauthorized substitutions may result in fire, electric shock or other hazards.

Safety Check

Upon completion of any service or repairs to the set, ask the service technician to perform routine safety checks (as specified by the manufacturer) to determine that the set is in safe operating condition, and to so certify. When the set reaches the end of its useful life, improper disposal could result in a picture tube implosion. Ask a qualified service technician to dispose of the set.



For Safety

Be careful when moving the LCD Projection TV

When you place the LCD Projection TV in position, be careful not to drop it on your foot or fingers.

Watch your footing while installing the LCD Projection TV.

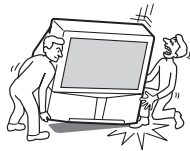

Carry the LCD Projection TV in the specified manner

If you carry the LCD Projection TV in a manner other than the specified manner and without the specified number of persons, it may drop and a serious injury may be caused. Be sure to follow the instructions mentioned below.

- ❑ Carry the LCD Projection TV with the specified number of persons (see page 18).
- ❑ Do not carry the LCD Projection TV holding the speaker grill.
- ❑ Hold the LCD Projection TV tightly when carrying it.



About the LCD Projection TV

Although the LCD projection TV is made with high-precision technology, black dots may appear or bright points of light (red, blue, or green) may appear constantly on the LCD screen. This is a structural property of the LCD panel and is not a malfunction.

Installation

- ❑ If direct sunlight or other strong illumination shines on the screen, part of the screen may appear white due to reflections from behind the screen. This is a structural property of the LCD Projection TV. Do not expose the screen to direct illumination or direct sunlight.
- ❑ The picture quality may be affected by your viewing position. If you sit too close to the TV, you may suffer from eye fatigue.
For the best picture quality, install your LCD projection TV according to the operating instructions.
Sit at least 1.8m (approx. 5.9ft.) for KF-42WE610, 2.0m (approx. 6.6ft.) for KF-50WE610 or 2.2m (approx. 7.2ft.) for KF-60WE610 away from your LCD projection TV, and within 60° of the vertical viewing area, and 130° of the horizontal viewing area.
- ❑ When installing your LCD Projection TV against a wall, keep it at least 10 cm (4 inches) from the wall.
- ❑ Avoid installing the LCD projection TV close to high temperature sources such as a heater.

Projection lamp

- ❑ Your LCD projection TV uses a projection lamp as its light source. When the projection lamp wears out after using the LCD projection TV for a long period of time, the screen image becomes dark, or no image will appear on the display. If the lamp replacement indicator of the front panel blinks in red, replace the lamp with a new one (not supplied). In some cases, the bulb bursts inside the lamp unit noisily, but the lamp unit is securely designed so that the pieces of broken glass remain inside the lamp unit. (See "Replacing the Lamp" on page 13.)

Cooling fan

- ❑ This LCD projection TV uses a cooling fan. You might hear the noise from the cooling fan, depending on the place you install the LCD projection TV.

Carrying

- ❑ Before carrying the LCD projection TV, disconnect any accessories or cables.

Remote control detection

- ❑ The remote control sensor is at the upper right side of the TV. For the best results, aim the remote control at this location.

Contents

Introducing the Sony LCD Projection TV

Presenting the Sony LCD Projection TV	9
Using This Manual.....	10
Enjoying Your LCD Projection TV	11
Replacing the Lamp	13

Installing and Connecting the LCD Projection TV

Contents	17
Inserting Batteries into the Remote Control	17
Carrying Your LCD Projection TV	18
To Prevent the LCD Projection TV from Falling Down.....	19
When Installing Your LCD Projection TV Against a Wall.....	19
Recommended Viewing Area.....	20
LCD Projection TV Connectors	21
Connector Types	24
Basic Connections (Connecting Cable TV or Antenna).....	25
Connecting a VCR and Cable.....	29
Connecting a VCR and Cable Box	30
Connecting Two VCRs for Tape Editing	32
Connecting a Satellite Receiver.....	33
Connecting a Satellite Receiver with a VCR.....	34
Connecting an Audio Receiver.....	36
Connecting a DVD Player with Component Video Connectors	37
Connecting a DVD Player with A/V Connectors ..	38
Connecting a Digital TV Receiver with component connectors	39
Connecting a Digital TV Receiver with DVI-HDTV connector.....	40
Connecting a Camcorder	41
Using the CONTROL S Feature.....	42
Setting Up the LCD projection TV Automatically	43

Using the Features

Using the Remote Control	44
Watching the TV.....	46
Watching Digital TV	48
Using Favorite Channels.....	49
Using Twin View™.....	50
Using the Freeze Function.....	53
Using Wide Screen Mode.....	54

Using the Memory Stick Viewer

About Memory Stick	55
Inserting and Removing a Memory Stick.....	57
Displaying the Memory Stick Home (Memory Stick Index).....	58
Using the Memory Stick Home	60
Viewing Still Images	62
Playing Movies	63
Memory Stick Home Menu Options.....	65

Using the Menus

Overview.....	68
Using the Video Menu.....	69
Using the Audio Menu.....	72
Using the Screen Menu.....	74
Using the Channel Menu	76
Using the Parent Menu	78
Using the Setup Menu	82

Other Information

Programming the Remote Control.....	86
Operating Other Components with Your LCD Projection TV Remote Control.....	88
Notes on Using Memory Stick, Memory Stick PRO Media	90
Notes on Using Memory Stick Duo.....	91
Contacting Sony.....	92
Troubleshooting	92
Flashing Indicators on the Front of the Monitor....	98
Specifications.....	99

Introducing the Sony LCD Projection TV

Presenting the Sony LCD Projection TV

Thank you for purchasing the Sony LCD Projection TV.
This manual is for models KF-42WE610, KF-50WE610 and KF-60WE610.

Features

Some of the features that you will enjoy with your new LCD projection TV include:

- ❑ **HD-Monitor:** Enables to display the 1080i, 720p, 480p and 480i digital TV format signals.
By using the HD/DVD IN jacks, you can connect a DTV (digital television) receiver to view DTV programs.
- ❑ **DRC[®] (Digital Reality Creation) Multifunction V1:** Unlike conventional line doublers, the DRC feature converts frames reproduced every 1/60th of a second in real time, minimizing the blur or ghost of the motion images (for 480i signals only).
- ❑ **CineMotion[™]:** Using the reverse 3-2 pull down technology, the CineMotion feature allows you to obtain a smooth picture movement when playing back movies or other video sources on film.
- ❑ **Twin View[™]:** Using Multi-Image Driver (MID-X), Twin View allows you to watch two programs side by side with the ability to zoom in on one picture and listen to the program in the selected window. You can watch pictures from two different sources (1080i, 720p, 480p or 480i) simultaneously.
- ❑ **Memory Stick[®] Picture Viewer:** Allows you to view on your LCD Projection TV screen digital images that are stored on Memory Stick media.
- ❑ **Parental Control:** V-Chip technology allows parents to block unsuitable programming for younger viewers.
- ❑ **Digital Visual Interface (DVI-HDTV):** Can accommodate a copy-protected digital connection (HDCP^{*}) to other devices (such as digital set-top boxes) that have compatible interfaces. The DVI-HDTV input terminal is compliant with the EIA-861 standard and is not intended for use with personal computers.

* High-bandwidth Digital Content Protection

(Continued)

- ❑ **Component Video Inputs:** Offers the best video quality for DVD (480p, 480i) and Digital Set-top box (1080i, 720p, 480p, 480i) connections.
- ❑ **S-VIDEO Inputs:** Provides a high-quality image for connected equipment.
- ❑ **Favorite Channel Preview:** Preview up to six-teen favorite channels without leaving the current channel.
- ❑ **Wide Screen Mode:** Allows you to watch 4:3 normal broadcasts in wide screen mode (16:9 aspect ratio).
- ❑ **Auto Wide:** Allows you to select the wide screen mode automatically.

Using This Manual

We recommend that you carefully review the contents of the following three sections in the order shown to ensure that you fully understand the operation of your new LCD projection TV.

- 1 **Installing and Connecting the LCD Projection TV**
This section guides you through your initial setup. It shows you how to install your LCD projection TV, to connect your new components and to connect the antenna and cable.
- 2 **Using the Features**
This section shows you how to begin using your new LCD projection TV. It also shows you how to use your remote control functions.
- 3 **Using the menus**
This section teaches you how to access on-screen menus and adjust your LCD projection TV settings.

Instructions in this manual are written for the remote control. Similar controls are also found on the LCD projection TV console.

Enjoying Your LCD Projection TV

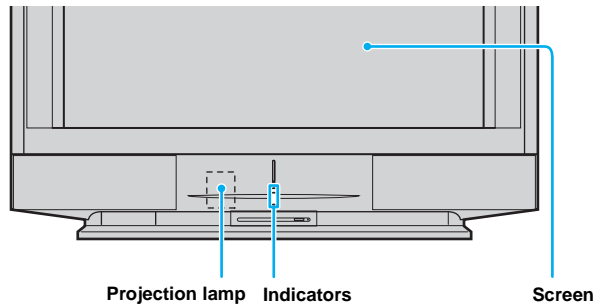

Indicators

The indicators show the current status of your LCD projection TV. If the LAMP indicator flashes, see “Flashing Indicators on the Front of the Monitor” on page 98.

Screen

To minimize screen reflection, its surface has a special coating. Read the instructions “Use of the Cleaning Cloth” on page 12 carefully before cleaning.

Inappropriate cleaning methods could damage the finishing.

Projection lamp

Your LCD projection TV uses a projection lamp as its light source. Note the following:

- ❑ After turning on your LCD projection TV, it may take a while before the picture appears (1 minute or less).
 - ❑ When the projection lamp wears out, the screen image becomes dark. Replace the lamp with a new Sony XL-2100U replacement lamp (not supplied).
- 🔧 Be sure to attach the lamp cover securely; otherwise, your LCD projection TV will not turn on. For details on lamp replacement, see “Replacing the Lamp” on page 13.
 - 🔧 The light emitted from the lamp is quite bright when your LCD projection TV is in use. To avoid eye discomfort or injury, do not look into the housing when the power is on.

Notes on the LCD Projection TV

To enjoy clear pictures

- ❑ Be sure not to allow sunlight or light from a lamp to shine directly onto the screen.
- ❑ The screen surface is easily scratched. Do not rub, touch, or tap it with a sharp or abrasive object (see “Use of the Cleaning Cloth” below).

On moisture condensation

- ❑ If your LCD projection TV is transported directly from a cold to a warm location, is placed in a humid room, or if the room temperature changes suddenly, the picture may be blurred or show poor color. This is because moisture has condensed on the lenses inside. If this happens, leave the power on and let the moisture evaporate before using your LCD projection TV.

When the LCD projection TV will not be used for a long period of time

- ❑ Turn off the main power on the front of your LCD projection TV before going to sleep or going out. Disconnect the AC plug if idle for more than 7 days.

When turning off the power

- ❑ Be sure to turn off the power switch on the main unit or on the remote control. After turning off the power, the fan will continue to blow for about two minutes. Be sure to wait for several minutes after turning the power off when unplugging from the outlet or switching the breaker off.

When carrying the LCD projection TV

- ❑ Disconnect the connections.

Use of the Cleaning Cloth

To remove dust from the front of the screen, wipe with the supplied Cleaning Cloth.

- ✎ Do not use any type of abrasive pad, alkaline cleaner, scouring powder, window cleaners or solvent such as alcohol or benzene. Otherwise, this type of contact may result in a damaged screen.
- ✎ To clean the screen, please use the supplied Cleaning Cloth lightly moistened with water diluted mild detergent solution. Do not apply heavy press when cleaning.
- ✎ The supplied Cleaning Cloth is washable with warm water and a mild detergent solution, and can be used repeatedly.

Replacing the Lamp

The projection lamp has a limited life which illuminates the picture.

If the screen becomes dark, the color looks unusual, or the LAMP indicator on the front of the LCD projection TV flashes, it is time to replace the lamp with a new one (not supplied).



WARNING

Electric appliances can cause fire or high temperature, resulting in injury or death. Be sure to follow the instructions below.

- ❑ Use a Sony XL-2100U replacement lamp (not supplied) for replacement. Failure to do so may damage the LCD projection TV.
- ❑ Do not remove the lamp for any purpose other than replacement. Failure to do so may cause fire or a skin burn.
- ❑ Before replacing the lamp, turn the power off on the main unit, then several minutes later, unplug the power cord. (The cooling fan will continue to blow for about two minutes after turning the power off.)
- ❑ Before replacing the lamp, let it cool down completely, as the surface of the lamp remains extremely hot for at least 30 minutes after the power has been turned off.
- ❑ Do not leave the removed lamp near flammable materials or within the reach of children.
- ❑ Do not pour water onto the removed lamp, or put any object inside the lamp. Doing so may cause the lamp to burst.
- ❑ Do not put flammable materials and metal objects inside the lamp receptacle of the LCD projection TV after removing the lamp. Doing so may cause fire or electrical shock. Also, be sure not to touch the receptacle, because it may cause a skin burn.
- ❑ Mount the new lamp securely, otherwise the screen may become dark, or it may cause a fire.
- ❑ Do not touch the glass with your fingers on the new lamp.

The Used Lamp

The used lamp contains Mercury, Dispose According to Local, State or Federal Laws.



Do not touch the front glass of a new lamp or the glass of the lamp receptacle. This may reduce picture quality or lamp life.

(Continued)

- 1 Turn off the power switch on the LCD projection TV and after several minutes, unplug the power cord.
(The cooling fan will continue to blow for about two minutes after turning the power off.)

 Do not touch the front glass of a new lamp or the glass of the lamp receptacle. This may reduce picture quality or lamp life.

- 2 Unplug the power cord after turning off the main power. Wait at least 30 minutes to allow the lamp to cool down before replacing it. Take the new lamp out of the box.
- 3 Loosen the screws on the rear side panel.

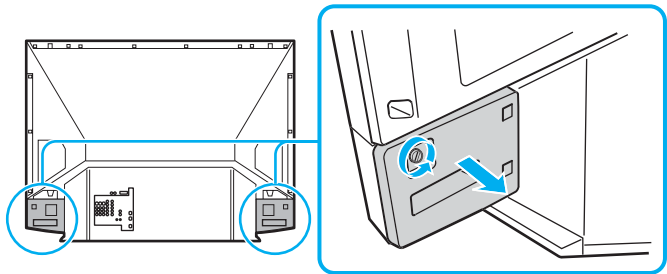

- 4 Remove the front panel.

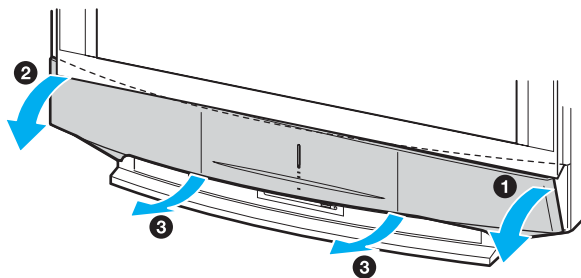

- 5 Loosen the screw with a coin or similar object to remove the lamp cover.

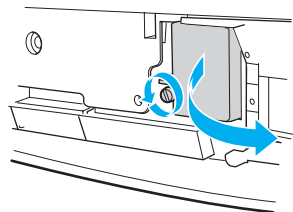

- 6 Loosen the two screws that secure the lamp, then pull out the lamp. The lamp is very hot immediately after use. Never touch the front glass of the lamp or the surrounding parts.

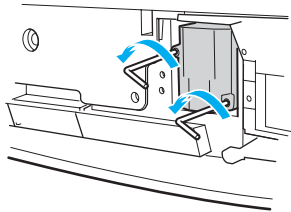

Loosen the two screws with the hex key supplied with the lamp.

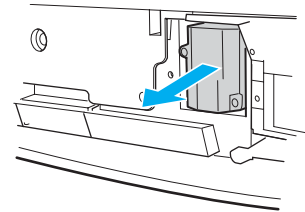

Hold the handle and pull straight out.

After it has cooled, place the removed lamp into the empty box of the replacement lamp. Never put the removed lamp into a plastic bag.

- 7 Mount the new lamp. Be sure to attach the new lamp securely.

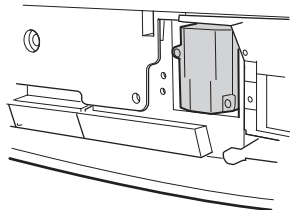

Mount the new lamp securely into the lamp receptacle.

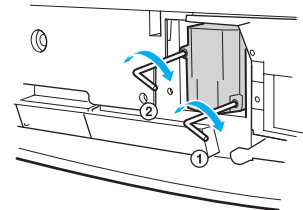

Tighten the two screws securely in the order of ① to ②, as shown in the illustration using the supplied hex key.

- 8 Mount the lamp cover and tighten the screw. Make sure that the lamp cover is mounted securely, otherwise the power will not turn on.

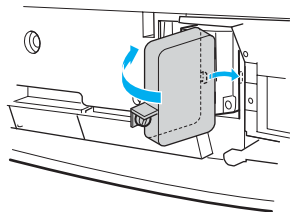

Match the projection of the right side of the lamp cover with the hole of the unit, and replace the lamp cover as it was.

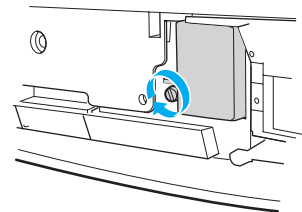

(Continued)

✎ If the lamp cover is not mounted securely, the self-diagnostic function works and the POWER/STANDBY indicator flashes for three times (See page 98).

9 Mount the front panel securely.

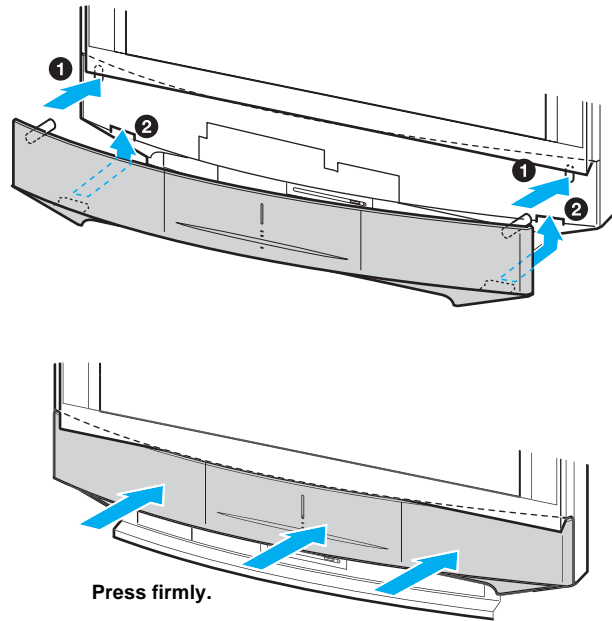

10 Mount the rear side panel and tighten the screws.

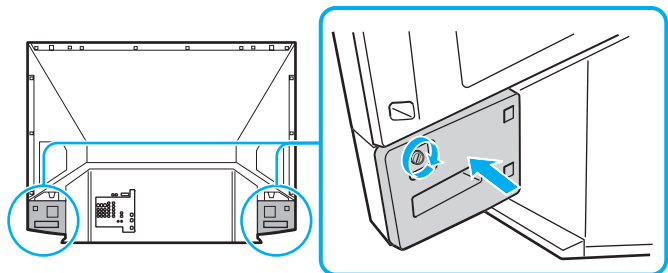

✎ Consult your Sony dealer for a Sony XL-2100U replacement lamp.
✎ Take great care when replacing the lamp or plugging in/unplugging the connecting cords. If you handle them roughly, the LCD projection TV may fall or be moved, and the TV stand or floor surfaces may be scratched.

Installing and Connecting the LCD Projection TV

Contents

The box contains your new LCD projection TV, a remote control and two AA batteries. No peripheral cables are included. If you intend to add additional equipment to your LCD projection TV, please check the hookup instructions for your desired setup before you begin. You may need to purchase cables and/or splitters to complete the hookup properly.

Inserting Batteries into the Remote Control

Insert two size AA batteries (supplied) by matching the + and – on the batteries to the diagram inside the battery compartment.

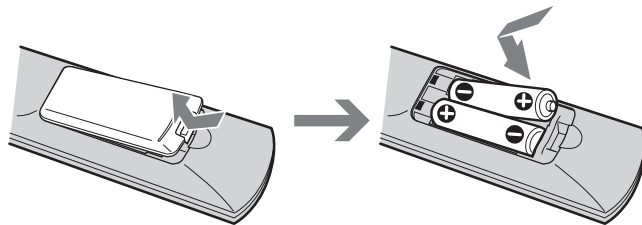

- ✎ Remove the batteries to avoid damage from possible battery leakage whenever you anticipate that the remote control will not be used for an extended period.
- ✎ Handle the remote control with care. Avoid dropping it, getting it wet, or placing it in direct sunlight, near a heater, or where the humidity is high.
- ✎ Your remote control can be programmed to operate most video equipment. (See “Programming the Remote Control” on page 86.)

Carrying Your LCD Projection TV

Carrying the LCD projection TV requires at least two people. Do not grasp the pedestal or the front panel of the LCD projection TV, otherwise these parts might break off.

When moving the LCD projection TV, support the hole on the lower portion with one hand while grasping the top part with the other hand, as shown in the illustration below.

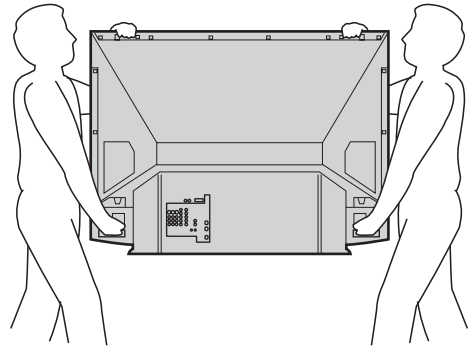
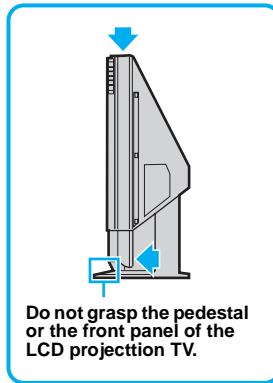

To Prevent the LCD Projection TV from Falling Down

Pay special attention to children around the LCD projection TV. If children should climb onto or push the LCD projection TV or its stand, it may fall down.

As a protective measure, secure the LCD projection TV as follows.

Using the LCD projection TV stand with support belts

- You can also use the LCD projection TV stand SU-GW1 (for KF-50/60WE610, not supplied), SU-GW2 (for KF-42WE610, not supplied) with support belts.

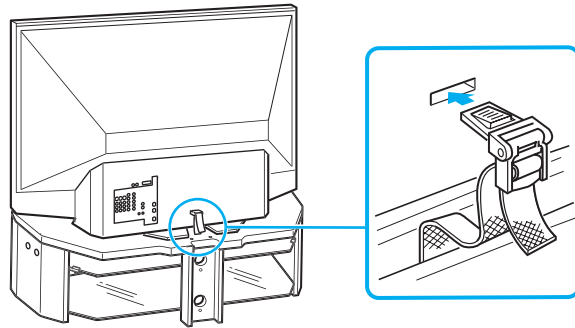

When Installing Your LCD Projection TV Against a Wall

Keep your LCD projection TV at least 10 cm (4 inches) from the wall.

Recommended Viewing Area

The picture quality may be affected by your viewing position.

For the best picture quality, install your LCD projection TV within the areas shown below.

Sit at least 1.8 m (approx. 5.9 ft) for KF-42WE610, 2.0 m (approx. 6.6 ft.) for KF-50WE610 or 2.2 m (approx. 7.2 ft.) away from your LCD projection TV, and within 60° of the vertical viewing area, and 130° of the horizontal viewing area.

Horizontal Viewing Area

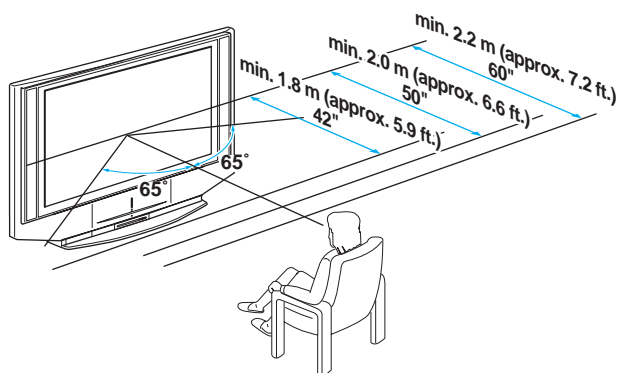

Vertical Viewing Area

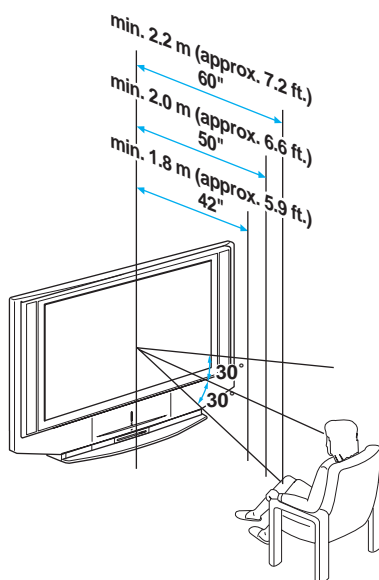

LCD Projection TV Connectors

LCD Projection TV Front and Rear Side Connectors

How to open the front panel

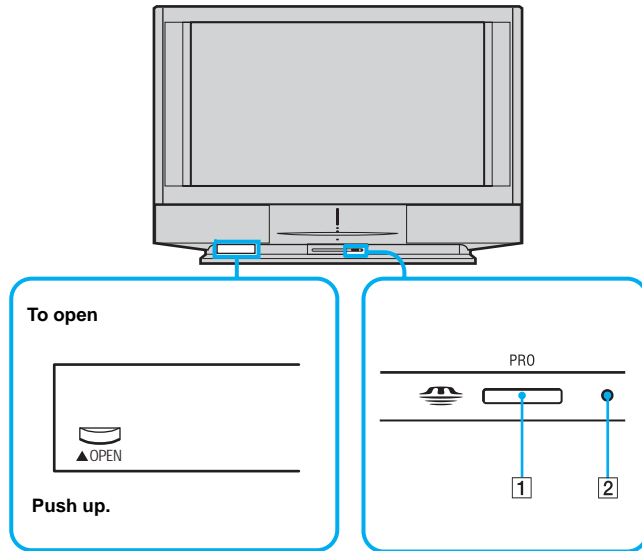

Item	Description
1 MEMORY STICK	Memory Stick insertion slot. For details, see “Inserting and Removing a Memory Stick” on page 57.
2 MEMORY STICK ACCESS LED	When lit, indicates that the Memory Stick is being read. (Do not remove the Memory Stick when the indicator is lit.)

(Continued)

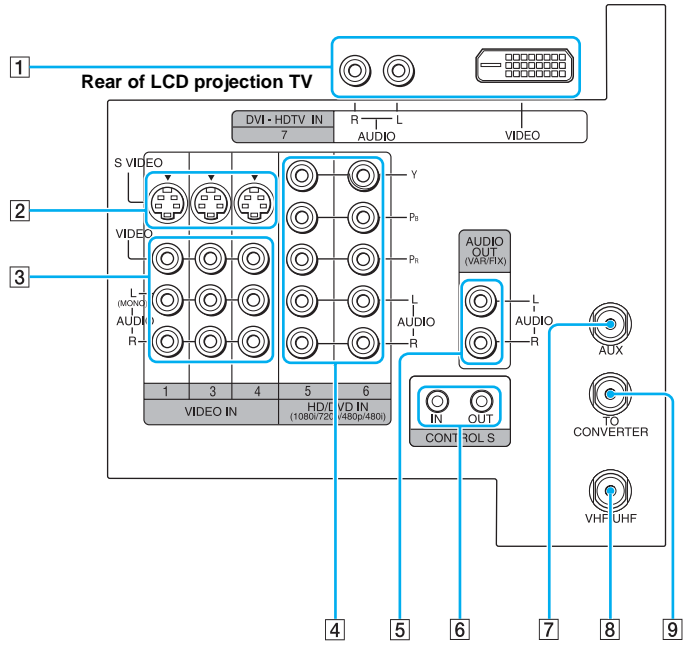

Front left side of LCD projection TV

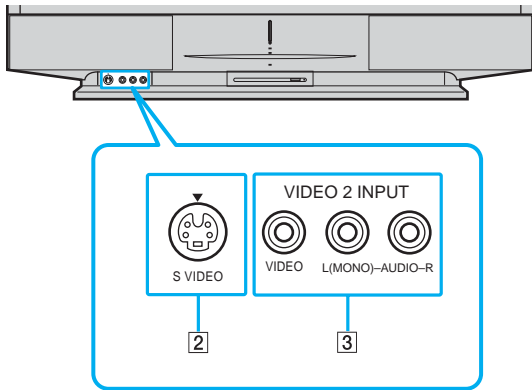

Connection	Description
1 DVI-HDTV VIDEO AUDIO R/L (VIDEO 7 IN)	Can accommodate a copy-protected digital connection (HDCP*) to other devices (such as digital set-top boxes) that have compatible interfaces. The DVI-HDTV input terminal is compliant with the EIA-861 standard and is not intended for use with personal computers. See the instruction manual that came with your equipment for details about connecting and using it with the LCD projection TV.
2 S VIDEO (Rear and front)	Connects to the S VIDEO OUT jack of your VCR or other S VIDEO-equipped video component. Provides better picture quality than the VHF/UHF jacks or the Video IN jack.
3 VIDEO/ (L/R) AUDIO (Rear and front)	Connects to the audio and video OUT jacks on your VCR or other video component. A fourth video input (VIDEO 2) is located on the side panel of the LCD projection TV.
4 HD/DVD IN (1080i, 720p, 480p, 480i)	Connects to your DVD player's or Digital Set-top box's component video (Y, PB, PR) and audio (L/R) jacks.
5 AUDIO OUT (VAR/FIX) L (MONO)/R	Connects to the left and right audio inputs of your audio or video component.
6 CONTROL S IN/OUT	To control other Sony equipment with the LCD projection TV's remote control, connect the CONTROL S IN jack of the equipment to the CONTROL S OUT jack on the LCD projection TV with the CONTROL S cable. To control the LCD projection TV with a remote control for another Sony product, connect the CONTROL S OUT jack of the equipment to the CONTROL S IN jack on the LCD projection TV with the CONTROL S cable.
7 AUX	Allows you to view local and cable channels if your cable provider does not feature local channels. You can switch between local and cable channels easily by pressing ANT on the remote control. Devices connected to the AUX input cannot be viewed in Twin View.
8 VHF/UHF (Primary RF input)	Connects to your VHF/UHF antenna or cable.
9 TO CONVERTER	This is a VHF/UHF OUT jack that lets you set up your LCD projection TV to switch between scrambled channels (through a cable box) and normal cable channels (CATV). Use this jack instead of a splitter to get better picture quality when switching between scrambled and unscrambled cable channels.

* High-bandwidth Digital Content Protection

Connector Types

You may find it necessary to use some of the following connector types during set up.

Coaxial cable

Standard TV cable and antenna cable

Plug Type



Screw-on Type



S Video cable

High quality video cable for enhanced picture quality

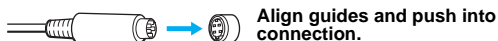

Audio/Video cable



Video - Yellow

Audio (Left) - White

Audio (Right) - Red

Some DVD Players are equipped with the following three video connectors:

Y - Green

P_B (C_B, C_b or B-Y) - Blue

P_R (C_R, C_r or R-Y) - Red

CONTROL S cable

CONTROL S connections are exclusive to Sony products and allow greater control of all Sony equipment.



Basic Connections (Connecting Cable TV or Antenna)

Connecting Directly to Cable or an Antenna

The connection you choose depends on the cable found in your home. Newer homes are equipped with standard coaxial cable (see **A**); older homes probably have 300-ohm twin lead cable (see **B**); other homes may contain both (see **C**).

A VHF Only or VHF/UHF or Cable



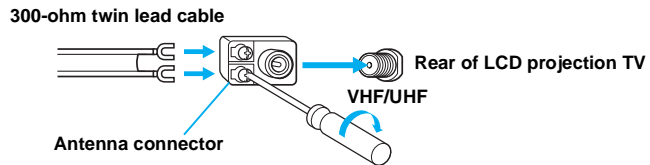

B VHF Only or UHF Only or VHF/UHF

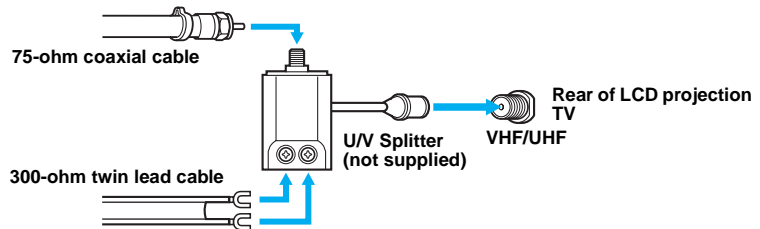

C VHF and UHF



 It is highly recommended to connect the antenna using a 75-ohm coaxial cable to get optimum picture quality. A 300-ohm twin lead cable can be easily affected by radio noise and the like, resulting in signal deterioration. If you use a 300-ohm twin lead cable, keep it away as far as possible from the LCD projection TV.

 Do not use an indoor antenna because it is especially susceptible to radio noise.

Cable and Antenna

If your cable provider does not feature local channels, you may find this set up convenient.

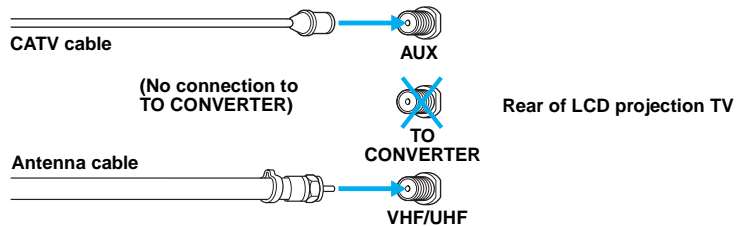

Select CABLE or antenna (ANT) mode by pressing ANT on the remote control.

 To receive channels with an antenna, you need to turn your Cable to Off (see page 76) and perform the Auto Program function (see page 76).

Cable Box Connections

Cable Box and Cable

This is the preferred basic cable TV hookup to use if:

- ❑ Your cable TV company scrambles some channels, but not all of them (pay channels vs. regular cable channels) and you need to use a cable box, and
- ❑ You want to enjoy the Twin View feature.

With this setup you can:

- ❑ Use the LCD projection TV remote control to change channels using your cable box when the signal is scrambled.
- ❑ Use the LCD projection TV remote control to change channels using your LCD projection TV when the signal is not scrambled. (Your LCD projection TV's tuner provides a better signal than the cable box.)
- ❑ Use the Twin View feature. (When all channels are routed through your cable box, only one channel is sent to the LCD projection TV, so you can not use the Twin View feature for your cable box.)

1 Connect the Cable TV cable to the LCD projection TV's VHF/UHF jack.

2 Using a coaxial cable, connect the LCD projection TV's TO CONVERTER jack to the cable box's IN jack. The LCD projection TV's internal converter allows you to switch between unscrambled signals coming straight into the LCD projection TV and scrambled signals coming in through the cable box, eliminating the need for an external splitter.

- Using a coaxial cable, connect the cable box's OUT jack to the LCD projection TV's AUX jack.

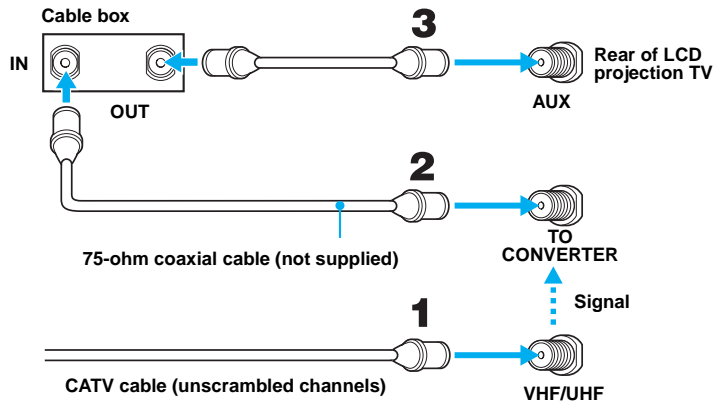

Pressing ANT on the remote control switches between the channels coming in through the cable box (scrambled) and those coming directly to the TV (unscrambled).

Cable Box Only

Use this hookup if:

- ❑ You subscribe to a cable TV system that uses scrambled or encoded signals requiring a cable box to view all channels, and
- ❑ You do not intend to hook up any other audio or video equipment to your LCD projection TV.

When all channels are routed through your cable box, only one unscrambled channel is sent to the LCD projection TV, so you cannot use the Twin View feature. If some channels are scrambled, but others are not, consider using the hookup on page 26 instead.

- 1 Connect the coaxial connector from your cable service to the cable box's IN jack.
- 2 Using a coaxial cable, connect the cable box's OUT jack to the LCD projection TV's VHF/UHF jack.

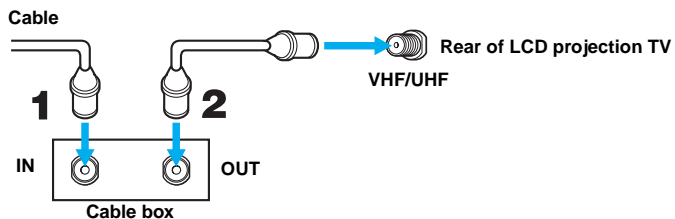

Also, set **Cable** to **On** in the Channel menu (see page 76).

- 🔧 Your Sony remote control can be programmed to operate your cable box (see "Programming the Remote Control" on page 86).
- 🔧 To change channels using the cable box, set your LCD projection TV to channel 3 or 4 depending on the cable box channel output. If you will be controlling all channel selection through your cable box, consider using the Channel Fix feature to set your LCD projection TV to channel 3 or 4 (see page 76).
- 💡 Setting the Channel Fix feature in the Channel menu (see "Using the Channel Menu" on page 76), ensures that you do not accidentally switch the channels using your LCD projection TV.

Connecting a VCR and Cable

Use this hookup if:

- You have cable TV that does not require a cable box.

Disconnect all power sources before making any connections.

- 1 Connect the cable TV cable to the VCR's IN jack.
- 2 Using a coaxial cable, connect the VCR's OUT jack to the LCD projection TV's VHF/UHF jack.
- 3 Using AUDIO and S VIDEO cables, connect the VCR's Audio and S Video OUT jacks to the LCD projection TV's AUDIO and S VIDEO IN jacks.

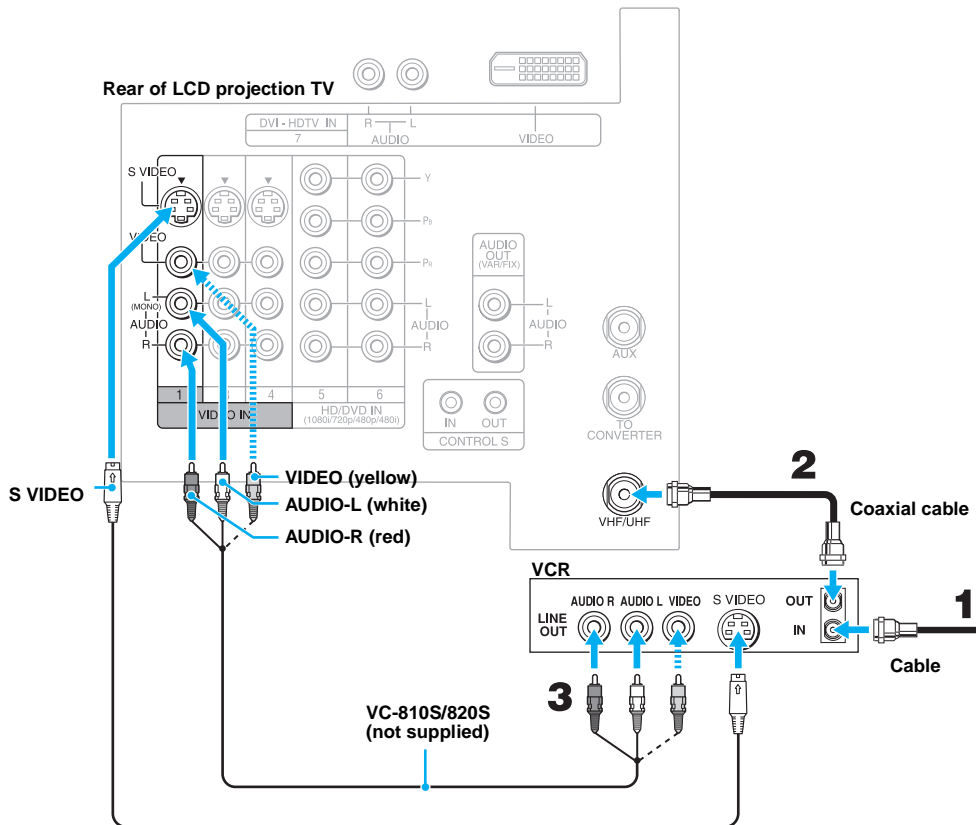

⚠ If your VCR is not equipped with S VIDEO, use a VIDEO cable (yellow) instead of the S VIDEO cable.

Connecting a VCR and Cable Box

Use this hookup if:

- ❑ Your cable TV company scrambles some channels, but not all of them (pay channels vs. regular cable channels) and you need to use a cable box, and
- ❑ You want to enjoy the Twin View feature.

With this setup you can:

- ❑ Use the LCD projection TV remote control to change channels on your cable box when the signal is scrambled. To program your Sony remote control to operate your cable box, see “Programming the Remote Control” on page 86.
- ❑ Use the LCD projection TV remote control to change channels using your LCD projection TV when the signal is not scrambled. Your LCD projection TV’s tuner provides a better signal than the cable box.
- ❑ Use the Twin View feature. (When all channels are routed through your cable box, only one signal is sent to the LCD projection TV, so you cannot use the Twin View feature.)

Disconnect all power sources before making any connections.

- 1 Connect the Cable TV cable to the LCD projection TV’s VHF/UHF jack.
- 2 Using a coaxial cable, connect the LCD projection TV’s TO CONVERTER jack to the cable box’s IN jack. The LCD projection TV’s internal converter allows you to switch between unscrambled signals coming straight into the LCD projection TV and scrambled signals coming in through the cable box, eliminating the need for an external splitter.
- 3 Using a coaxial cable, connect the cable box’s OUT jack to the VCR’s IN jack.
- 4 Using AUDIO and S VIDEO cables, connect the VCR’s AUDIO and S VIDEO OUT jacks to the LCD projection TV’s AUDIO and S VIDEO IN jacks.
- 5 Using a coaxial cable, connect the VCR’s OUT jack to the LCD projection TV’s AUX jack.

 To view scrambled channels, set your LCD projection TV to AUX 3 or 4 (depending on your cable box output). Change channels using your cable box.

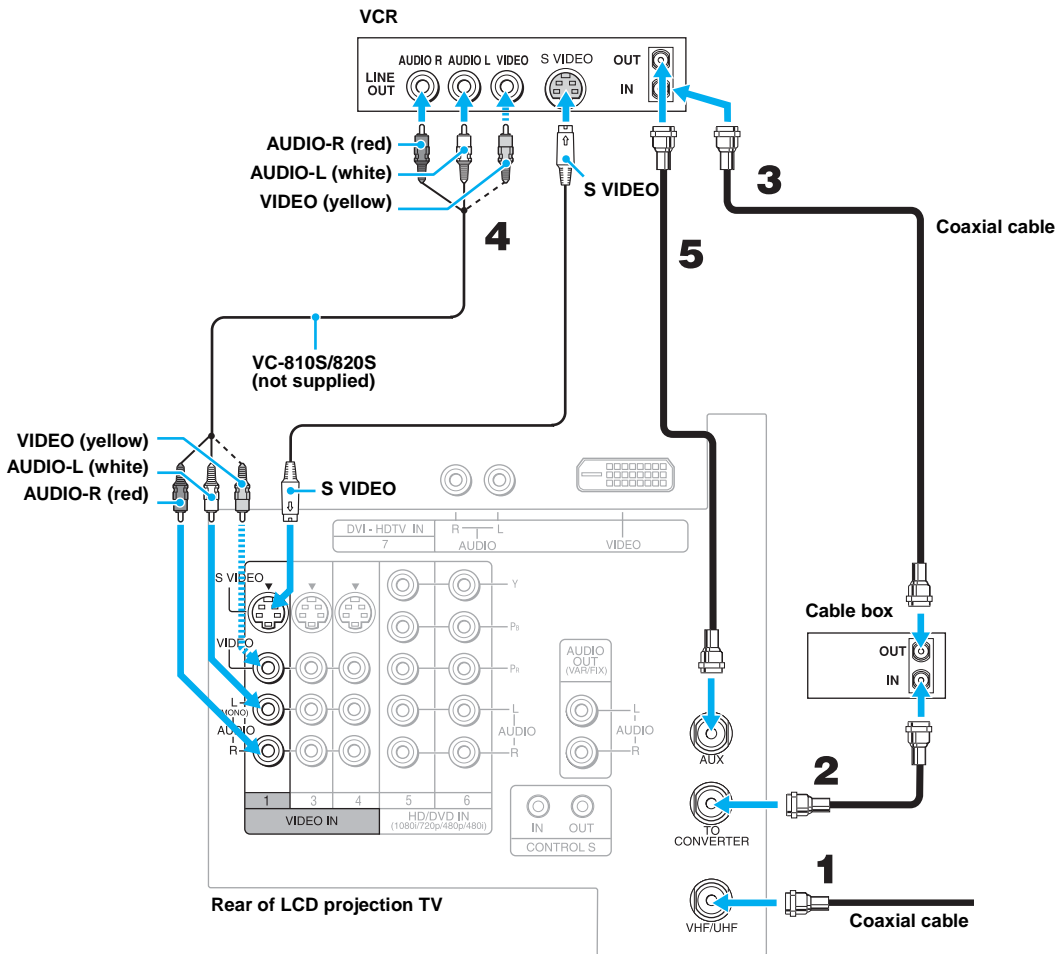

- ✎ If your VCR is not equipped with S VIDEO, use a VIDEO cable (yellow) instead of the S VIDEO cable.
- ✎ You will not be able to change channels on the VCR. Set your LCD projection TV and VCR to channel 3 or 4, depending on your cable box channel output.
- ✎ Pressing ANT on the remote control switches between the channels coming in through the cable box (scrambled) and those coming directly to the LCD projection TV (unscrambled).

Connecting Two VCRs for Tape Editing

If you connect two VCRs, you can record from one VCR to the other while using your LCD projection TV to monitor what is being recorded.

Disconnect all power sources before making any connections.

- 1 Using AUDIO and VIDEO cables, connect the playback VCR's Audio and Video OUT jacks to the recording VCR's Audio and Video IN jacks.
- 2 Using AUDIO and VIDEO cables, connect the recording VCR's AUDIO and Video OUT jacks to the LCD projection TV's AUDIO and VIDEO IN jacks.

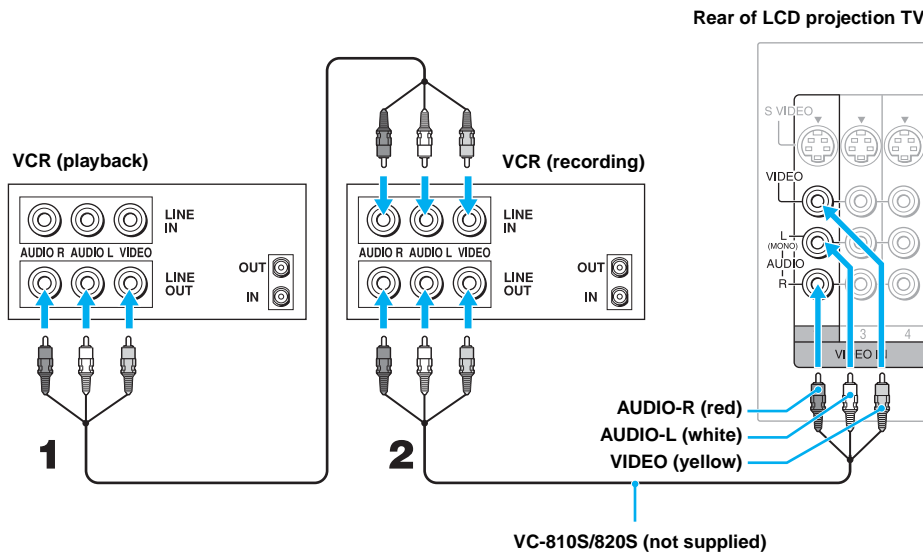

- 🔧 To perform tape editing, set the LCD projection TV to the video input intended for playback by pressing TV/VIDEO on the remote control.
- 🔧 You may need to change the video input on your VCR. Consult your VCR's operating manual for instructions.
- 🔧 If your VCRs have an S VIDEO jack: For best picture quality, use an S VIDEO connection instead of the yellow video cable on your combined A/V cable. Using an S VIDEO cable, connect the playback VCR's S VIDEO OUT jack to the recording VCR's S VIDEO IN jack. S VIDEO does not provide audio, so audio cables must be connected to provide sound.
- 🔧 You cannot record signals from equipment connected to the Y, P_B, P_R input.

Connecting a Satellite Receiver

Disconnect all power sources before making any connections.

- 1 Connect the satellite antenna cable to the satellite receiver's SATELLITE IN jack.
- 2 Using AUDIO and S VIDEO cables, connect the satellite receiver's AUDIO and S VIDEO OUT jacks to the LCD projection TV's AUDIO and S VIDEO IN jacks.
- 3 Connect a coaxial cable from your cable or antenna to the LCD projection TV's VHF/UHF jack.

 If your satellite receiver is not equipped with S VIDEO, use a VIDEO cable (yellow) instead of the S VIDEO cable.

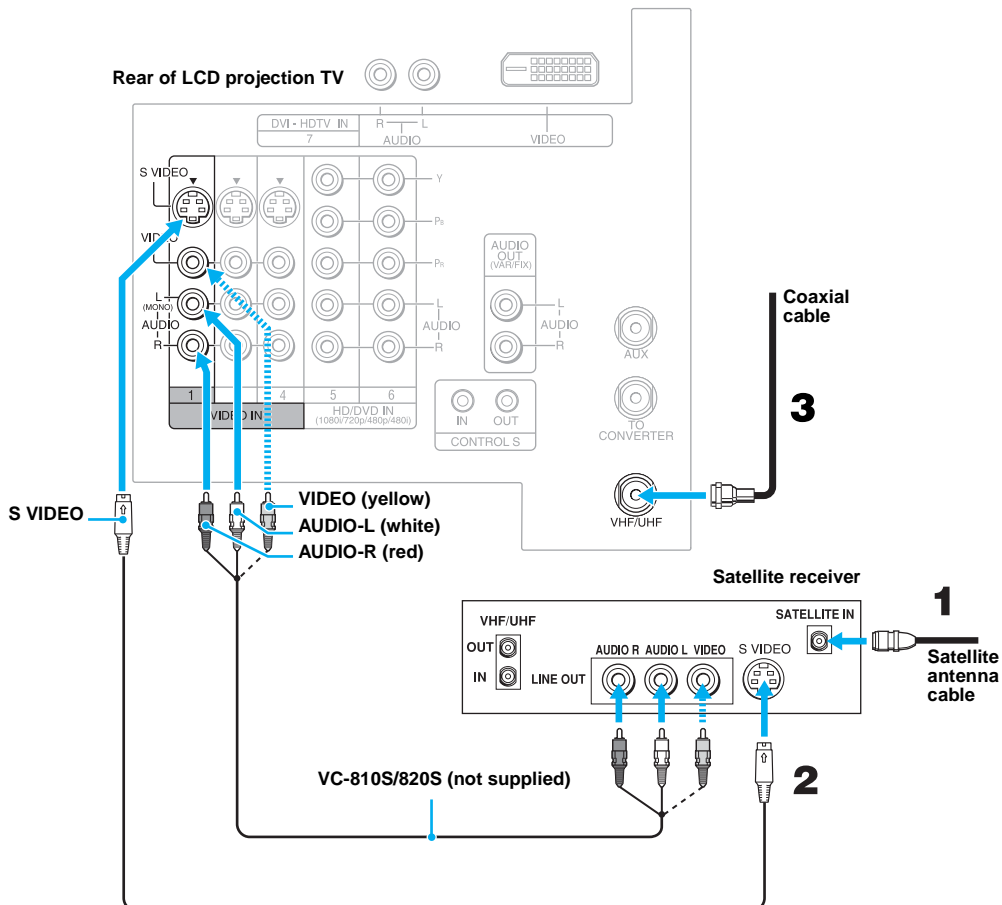

Connecting a Satellite Receiver with a VCR

Disconnect all power sources before making any connections.

- 1 Connect the satellite antenna cable to the satellite receiver's SATELLITE IN jack.
- 2 Connect the CATV cable to the VCR's VHF/UHF IN jack.
- 3 Using a coaxial cable, connect the VCR's OUT jack to the LCD projection TV's VHF/UHF jack.
- 4 Using AUDIO and S VIDEO cables, connect the satellite receiver's AUDIO and S VIDEO OUT jacks to the VCR's AUDIO and S VIDEO IN jacks.
- 5 Using AUDIO and S VIDEO cables, connect the VCR's AUDIO and S VIDEO OUT jacks to the LCD projection TV's AUDIO and S VIDEO IN jacks.

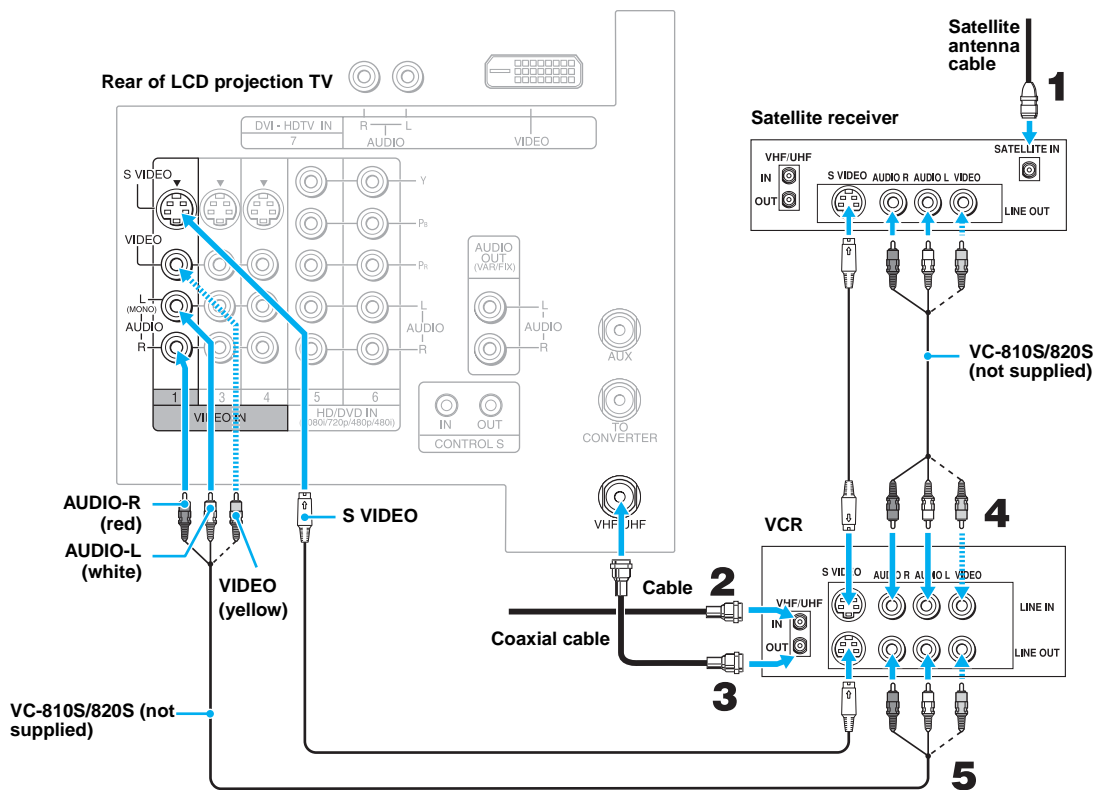

- ✎ Be sure your VCR's video input is set correctly. Consult your VCR's operating manual for instructions.
- ✎ Use TV/VIDEO to select
 - VIDEO 1 to watch satellite TV or the VCR (your VCR must be turned on).
 - VHF/UHF to watch cable TV.
- ✎ If your VCR or satellite receiver is not equipped with S VIDEO, use a VIDEO cable (yellow) instead of the S VIDEO cable.

Connecting an Audio Receiver

Disconnect all power sources before making any connections.

Using audio cables, connect the LCD projection TV's AUDIO OUT (VAR/FIX) jacks to the audio receiver's audio LINE IN jacks.

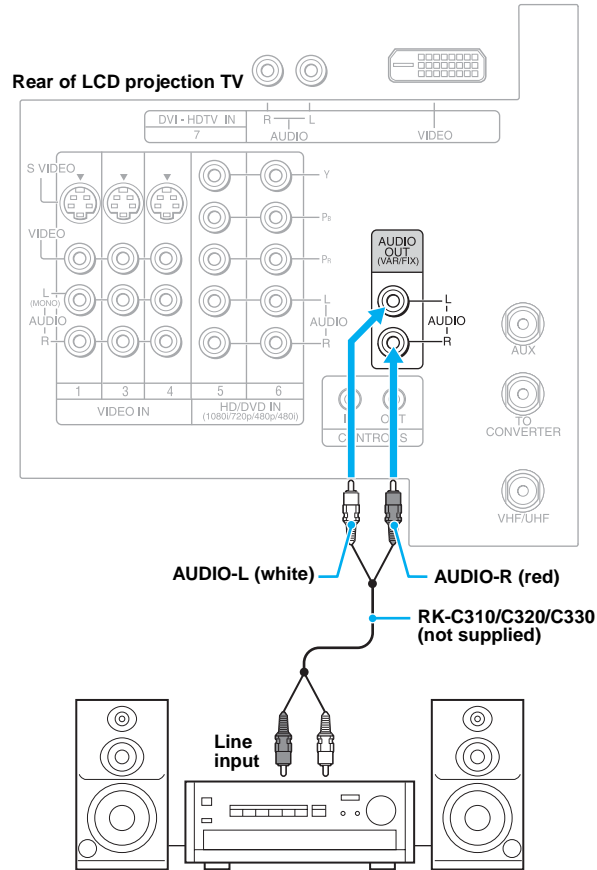

Connecting a DVD Player with Component Video Connectors

This is the preferred hookup to use if:

- Your DVD player has component (Y, B-Y, R-Y) jacks.

Disconnect all power sources before making any connections.

- 1 Using three separate component video cables, connect the DVD player's Y, B-Y and R-Y jacks to the Y, PB and PR jacks on the LCD projection TV. Use the HD/DVD IN 5 or 6 connections.

 The Y, B-Y and R-Y jacks on your DVD player are sometimes labeled Y, C_B and C_R, or Y, P_B and P_R. If so, connect the cables to like colors.

- 2 Using an audio cable, connect the DVD player's Audio OUT jacks to the LCD projection TV's AUDIO IN jacks. Be sure to use the same row of inputs that you used for the video connection (HD/DVD IN 5 or 6).

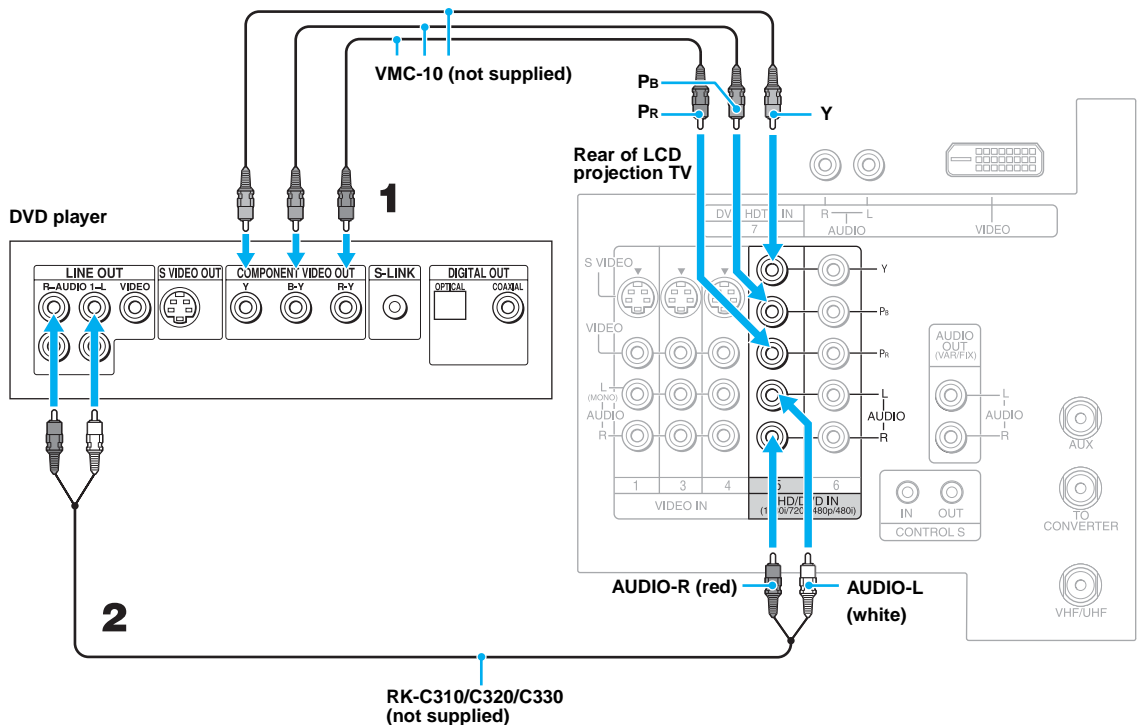

 To take advantage of the Wide Screen modes, set the TV's aspect ratio to 16:9 on your DVD player. For details, refer to the operating instructions supplied with your DVD player.

Connecting a DVD Player with A/V Connectors

Use this hookup if:

- ❑ Your DVD player does not have component (Y, PB, PR) jacks.

🔧 If your DVD player has video component output connectors: for best picture quality use the connection described on page 37.

Disconnect all power sources before making any connections.

- 1 Using audio cables, connect the DVD player's Audio OUT jacks to the LCD projection TV's AUDIO IN jacks.
- 2 Using an S VIDEO cable, connect the DVD player's S VIDEO jack to the LCD projection TV's S VIDEO jack.

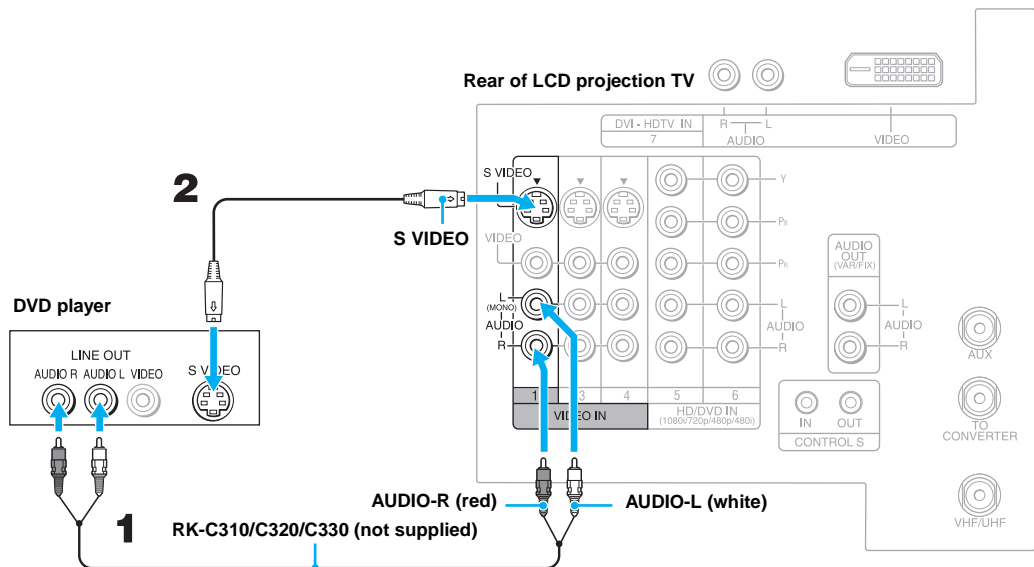

🔧 To take advantage of the Wide Screen modes, set the TV's aspect ratio to 16:9 on your DVD player. For details, refer to the operating instructions supplied with your DVD player.

🔧 Use TV/VIDEO on the remote control to switch between the VCR, DVD player and cable TV inputs.

🔧 If your VCR is not equipped with S VIDEO, use a VIDEO cable (yellow) instead of the S VIDEO cable.

Connecting a Digital TV Receiver with component connectors

Disconnect all power sources before making any connections.

 Be sure to read the Set-top box manual.

1 Using three separate component video cables, connect the Digital TV Set-top box's Y, P_B and P_R jacks to the LCD projection TV.

 The Y, P_B and P_R jacks do not provide audio, so audio cables must be connected to provide sound.

 Component video connection is necessary to view 480i, 480p, 720p, and 1080i formats. You may also use the S VIDEO or Composite Video connections, however, component video (Y, P_B, P_R) will provide the best picture quality for all format types.

2 Using an audio cable, connect the Digital TV Set-top box's Audio OUT jacks to the LCD projection TV's AUDIO IN jacks.

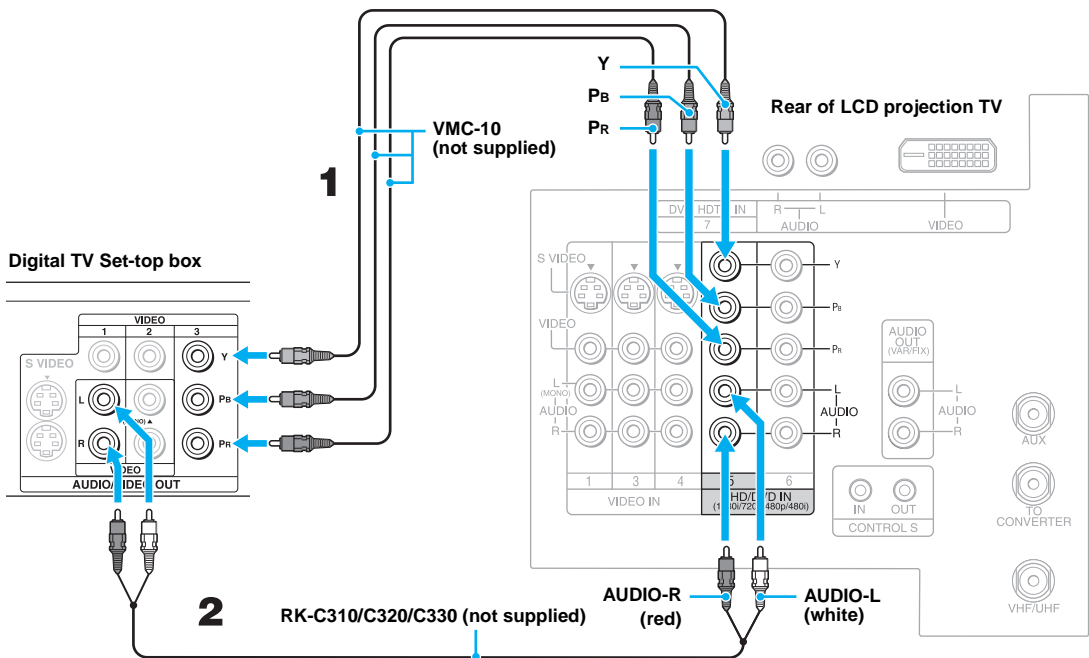

 You cannot record the signal from any equipment connected into the Y, P_B and P_R connectors.

 This LCD projection TV is not compatible with digital TV receivers configured with RGB or VGA output connectors.

Connecting a Digital TV Receiver with DVI-HDTV connector

Disconnect all power sources before making any connections.

 Be sure to read the Set-top box manual.

1 Using a DVI-D single link cable, connect the Digital TV Set-top box's DVI-HDTV connector to the LCD projection TV.

 The DVI-HDTV VIDEO connector does not provide audio, so audio cables must be connected to provide sound.

2 Using an audio cable, connect the Digital TV Set-top box's Audio OUT jacks to the LCD projection TV's DVI-HDTV AUDIO jacks.

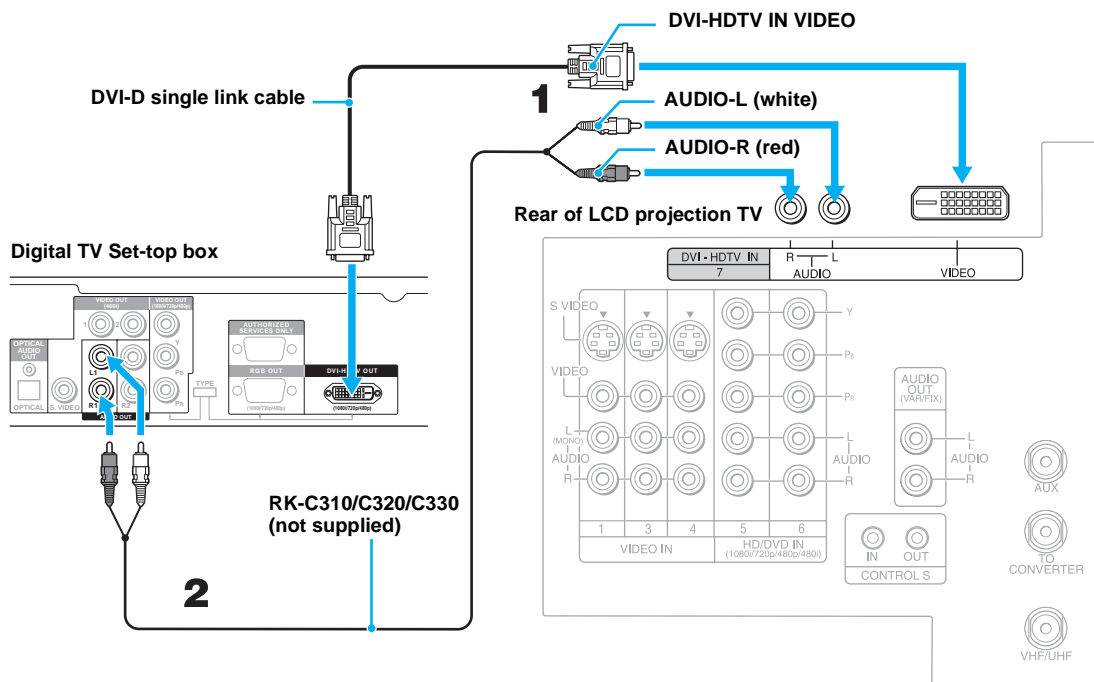

Connecting a Camcorder

For easy connection of the camcorder, the LCD projection TV has front Audio and Video inputs (shown below). However, if you prefer, you can also connect the camcorder to the LCD projection TV's rear Audio and Video IN jacks.

Using AUDIO and S VIDEO cables, connect the camcorder's Audio and S VIDEO OUT jacks to the LCD projection TV's AUDIO and S VIDEO IN jacks.

- ✎ If you have a mono camcorder, connect its left audio output to the LCD projection TV's AUDIO L (MONO) jack.
- ✎ If your camcorder is not equipped with S VIDEO, use a VIDEO cable (yellow) instead of the S VIDEO cable.

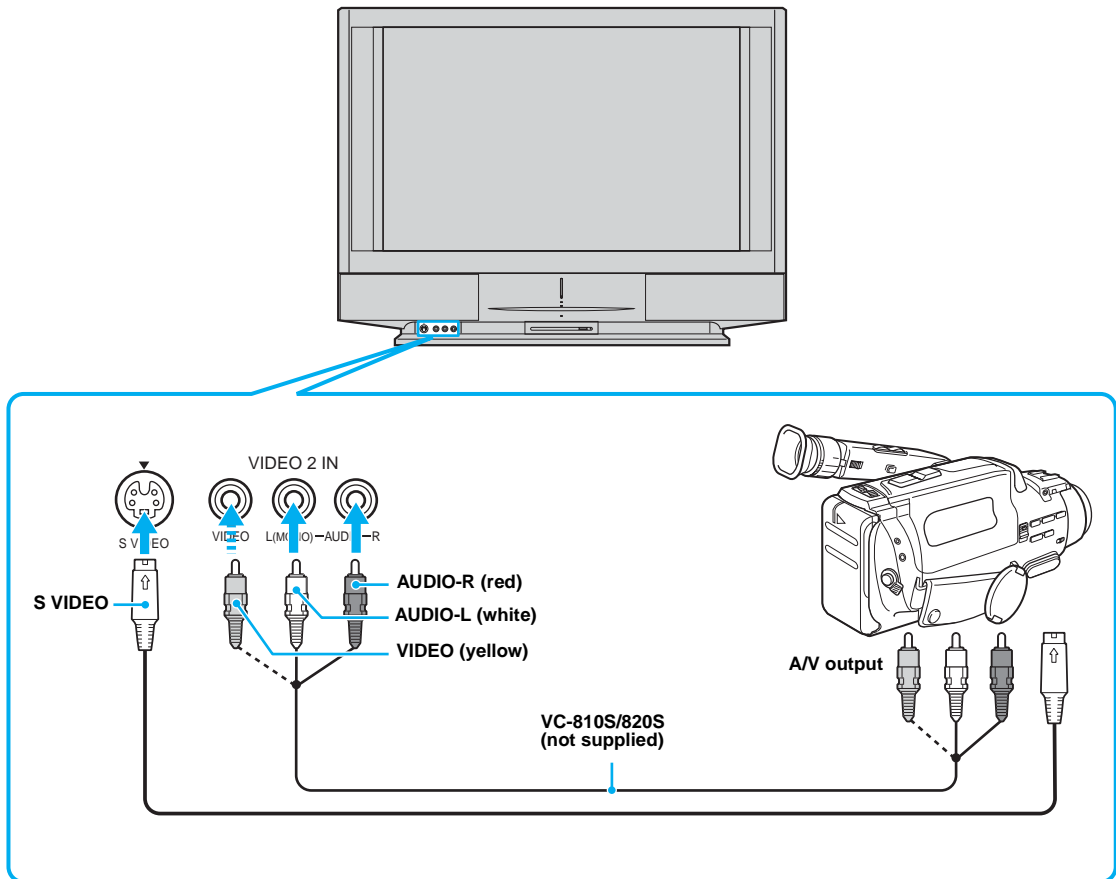

Using the CONTROL S Feature

CONTROL S allows you to control your LCD projection TV system and other Sony equipment with one remote control. In addition to allowing you to control multiple devices with one remote control, the CONTROL S feature allows you to always point your remote control at your LCD projection TV, instead of having to point it at the other equipment, which might be hidden or out of direct line of sight.

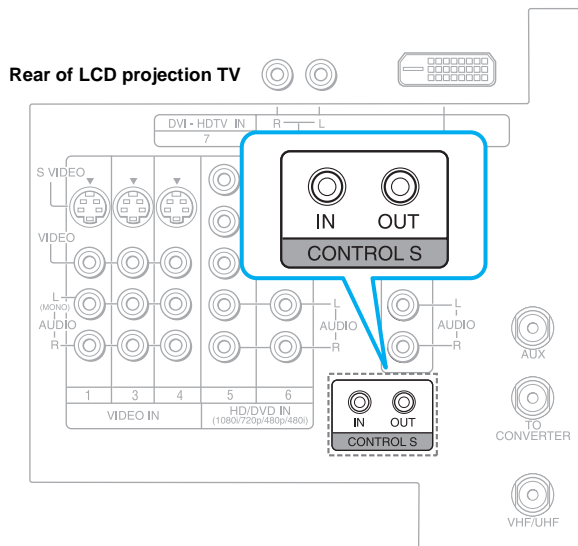

Setting Up the LCD projection TV Automatically

After you finish connecting your LCD projection TV, you can run Auto Setup to set up your channels. The Auto Setup screen appears when you turn your LCD projection TV on for the first time after installing it. If you do not want to set up the channels at this time, you can do it later by using the Auto Program feature in the Channel menu (see page 76).

 The Auto Setup feature does not apply for installations that use a cable box for all channel selection.

Using Auto Setup

- 1 Press POWER on the front panel of your LCD projection TV or on the remote control to turn on the LCD projection TV.
- 2 Press FUNCTION on the remote control until the TV indicator lights up.
- 3 Press CHANNEL+ on your LCD projection TV to run Auto Setup, or press CHANNEL– to exit. If you use the channel buttons on your remote control, be sure to use .

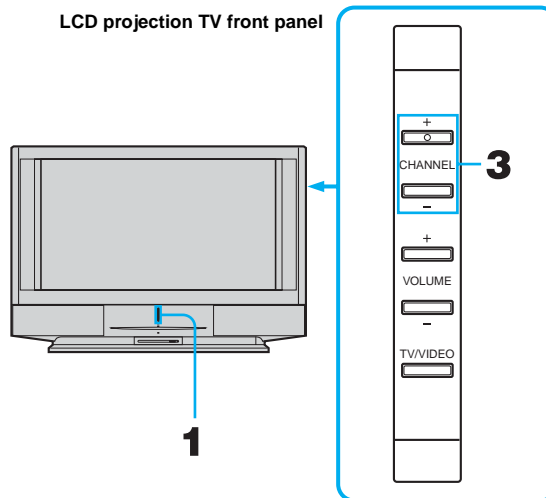

 You can run Auto Program by selecting it in the Channel menu, as described on page 76.

Using the Features

Using the Remote Control



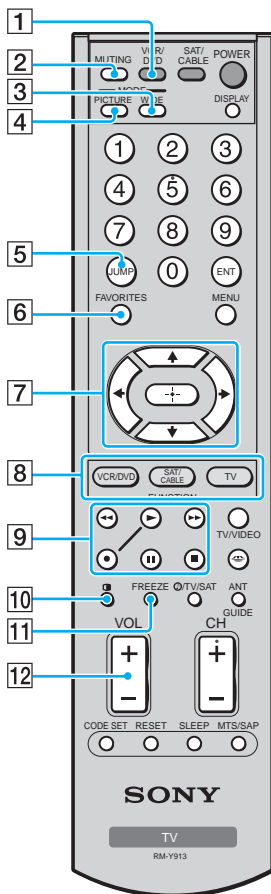

The following table describes the buttons on the remote control that are for more advanced functions.

Button Descriptions

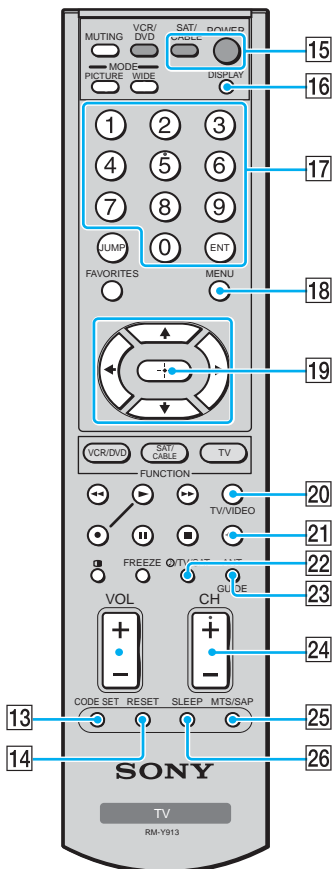

Button	Description
1	VCR/DVD Press to turn on and off the VCR or DVD player.
2	MUTING Press to mute the sound. Press again or press VOL + to restore the sound.
3	WIDE MODE Press to step through the wide screen modes: Wide Zoom, Normal, Full and Zoom. For details, see "Using Wide Screen Mode" on page 54.
4	PICTURE MODE Press repeatedly to step through the available video picture modes: Vivid, Standard and Pro Mode. Also available in the Video menu. For details, see "Selecting Video Options" on page 69.
5	JUMP Press to jump back and forth between two channels. The LCD projection TV alternates between the current channel and the last channel that was selected.
6	FAVORITES Displays the Favorite Channels list. For details, see "Using Favorite Channels" on page 49.
7	▲/▼/◀/▶ When the menu is displayed, move the on-screen cursor.
8	FUNCTION Select the equipment (TV, SAT/CABLE, VCR/DVD) that you want to operate.
9	 : Pause ■ : Stop ◀◀ : Rewind ▶▶ : Play ▶▶▶ : Fast-Forward ● : Record by pressing ● and ▶
10	TWIN VIEW Turns on/off Twin View. For details, see "Using Twin View™" on page 50.
11	FREEZE Freezes the window picture. Press again to restore the picture.
12	VOL +/- Adjusts the volume.



Button	Description
13 CODE SET	Use for programming the remote control to operate non-Sony video equipment. For details, see “Programming the Remote Control” on page 86.
14 RESET	Press when in a menu to reset the settings to the factory defaults.
15 POWER buttons (GREEN)	Turn on and off the LCD projection TV and other audio/video equipment you have programmed into the remote control. For instructions, see “Programming the Remote Control” on page 86.
16 DISPLAY	Press once to display the current time and channel label (if set) and channel number. Press again to turn Display off. See page 84 for details on setting the time.
17 0 – 9 and ENT	Press 0 - 9 to select a channel, the channel changes after 2 seconds. Press ENT to select immediately.
18 MENU	Press to display the LCD projection TV on-screen menu. Press again to exit from the menu.
19 	When the menu is displayed, select the item.
20 TV/VIDEO	Cycles through the video equipment connected to your LCD projection TV’s video inputs: TV, VIDEO 1, VIDEO 2, VIDEO 3, VIDEO 4, VIDEO 5, VIDEO 6 and VIDEO 7.
21 MEMORY STICK 	Press to display the Memory Stick Menu. For details, see “Using the Memory Stick Viewer” on page 55.
22 	Press to scroll an audio option: TruSurround, Simulated, and Off.
TV/SAT	Press to select the TV or satellite receiver.
23 ANT GUIDE	Changes between the VHF/UHF input and the AUX input. Displays the program guide of your satellite.
24 CH +/-	Scan through channels.  To scan rapidly through the channels, press and hold down CH+ or CH-.
25 MTS/SAP	Press to scroll through the Multi-channel TV Sound (MTS) options: Stereo, Auto SAP, and Mono.
26 SLEEP	Press repeatedly until the LCD projection TV displays the time in minutes (15, 30, 45, 60, or 90) that you want the LCD projection TV to remain on before shutting off automatically. To cancel Sleep timer, press SLEEP repeatedly until SLEEP OFF appears. Pressing down POWER also cancels the Sleep timer and turns off the power. While the Sleep feature is set, press once to view the remaining time.

Watching the TV

Many TV features can be accessed directly through the remote control. The following will explain the function of some of the buttons found on your remote control.

Buttons for LCD Projection TV Operations

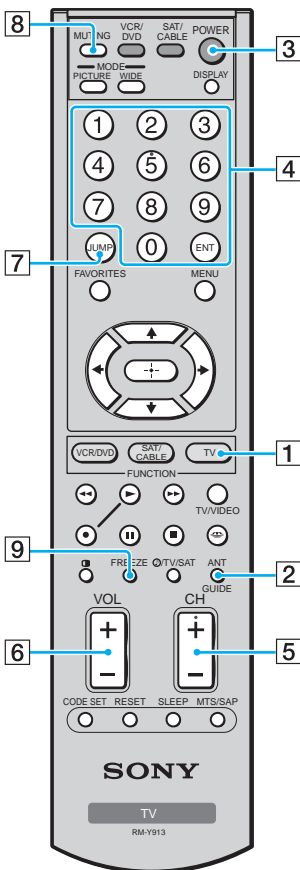

1 FUNCTION TV

Press to have the remote control operate the TV. The indicator lights up momentarily when pressed to show which equipment the remote control is operating.

2 ANT— (AUX input)

Press to change between the VHF/UHF input and the AUX input.

3 POWER

Turn the LCD projection TV on and off. If a video input indication (e.g., VIDEO 1, VIDEO 2) appears on the screen, press TV/VIDEO or CH +/– until a channel number appears.

4 0-9 and ENT

Use for direct channel selection. Press 0-9 to select a channel (for example, to select channel 10, press 1 and 0). The channel will change after 2 seconds, or you can press ENT for immediate selection.

5 CH +/-

Press to scan through the channels (+ up or – down).

6 VOL +/-

Press to adjust the volume (+ up or – down).

7 JUMP

Press to alternate or jump back and forth between two channels. The LCD projection TV will jump between the current channel and the last channel selected.

8 MUTING

Press to mute the sound. “MUTING” will appear on the screen. To restore the sound, press again or press VOL +.

9 FREEZE

This is useful when you need to copy down information that appears on the LCD projection TV’s screen (see “Using the Freeze Function” on page 53).

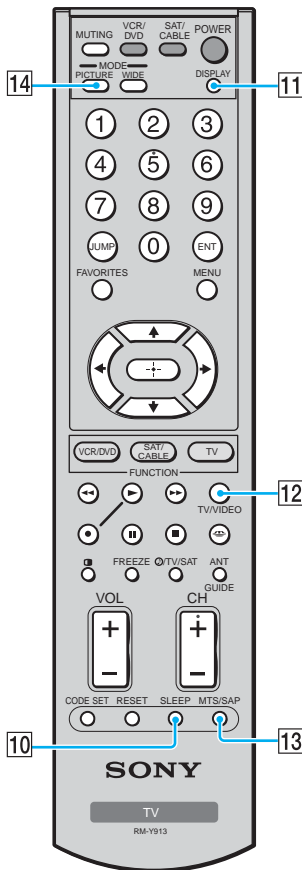
**10 SLEEP**

Press repeatedly until the LCD projection TV displays the approximate time in minutes (15, 30, 45, 60, or 90) that you want the LCD projection TV to remain on before shutting off automatically.

Cancel by pressing SLEEP until “SLEEP OFF” appears.

11 DISPLAY

Press to display the channel number, current time and channel label (if set).

To turn the display off, press DISPLAY again.

12 TV/VIDEO

Press repeatedly to scroll through available video inputs: TV, VIDEO 1, VIDEO 2, VIDEO 3, VIDEO 4, VIDEO 5, VIDEO 6 and VIDEO 7.

If you select Skip as a Video Label in the Setup menu, your LCD projection TV will skip the video input you selected (see “Video Label” on page 83).

13 MTS/SAP

Press to scroll through the Multi-channel TV Sound (MTS) options (see “MTS” on page 72).

14 PICTURE MODE

Press PICTURE MODE repeatedly to directly choose one of three different video modes that best suits the program you are watching.

Vivid: Select for enhanced picture contrast and sharpness.

Standard: Select to display a standard picture for normal viewing environments.

Pro: Select to display a picture with minimum enhancements.

When you select each mode, you can also adjust the picture quality (such as Brightness, Color, etc.) to suit your taste. For details, see “Mode” on page 69.

Watching Digital TV

When you have connected the DTV receiver, you can enjoy digital TV programs. This LCD projection TV is capable of receiving the 1080i, 720p, 480p and 480i digital TV formats.

To view a digital TV program

- 1 Connect the DTV receiver to DVI-HDTV IN 7, HD/DVD IN 5 or 6 on the LCD projection TV (for details, see page 39).
- 2 Press TV/VIDEO to select DVI-HDTV IN 7, HD/DVD IN 5 or 6.
- 3 Select a digital channel on the DTV receiver. For details, see the Operating Manual of the DTV receiver.
- 4 Adjust the volume of the LCD projection TV as necessary.

Using Favorite Channels

The Favorite Channel feature lets you select programs from a list of favorite channels that you preset.



Creating a List of Favorite Channels

- 1 Press MENU to display the Menu.
 - 2 Press ◀ or ▶ to highlight the Channel icon and press (+).
 - 3 Press (+) to select Favorite Channels.
 - 4 Press ▲ or ▼ to highlight a Favorite Channel number (1-16) and press (+).
 - 5 Press ▲ or ▼ to highlight a channel you want to assign to the Favorite Channel number. A preview of the highlighted channel appears in the upper right of the screen.
Press (+) to select that channel as a Favorite Channel.
 - 6 To add more channels to your favorites list, repeat steps 4-5.
To clear a Favorite Channel, press ▲ or ▼ to highlight the channel you want to clear. Press (+) and then press RESET.
 - 7 Press MENU to exit the Menu.
-  For details on using the Channel Menu, see page 76.

Displaying a List of Favorite Channels

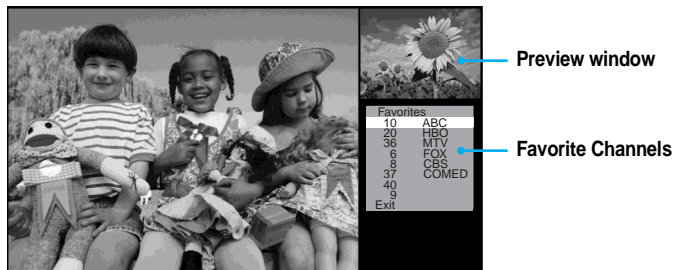
- 1 Press FAVORITES.
The Favorite Channel options appear.



- 2 Press ▲ or ▼ to highlight the channel you want to watch. The program of that channel appears in the preview window. Press (+) to select.
-  When the remote control function is set to other than TV function, you can display the Favorite Channels. However, you cannot select the channel by using ▲ or ▼.
-  To assign Channel Labels (e.g., ABC, HBO, MTV, etc.) to channel numbers, as shown at right, use the Channel Label feature in the Channel Menu (see page 77).

Using Twin View™

Twin View enables you to watch two programs at the same time. You can also change the size of both the left and right pictures.



Activating Twin Pictures

To display twin pictures



- 1 Make sure your LCD projection TV is tuned to a working channel.
- 2 Press .



To cancel twin pictures

- Press  again (or press .

Activating the Picture

Although two pictures appear on the screen at the same time, only one picture is active. Change the picture size by using the  or  button. For an active picture, you can:

- Change channels.
- Adjust the volume.
- Switch the input sources from VHF/UHF to cable by pressing ANT or TV/VIDEO to switch the video input.

To activate the right picture

- Press .

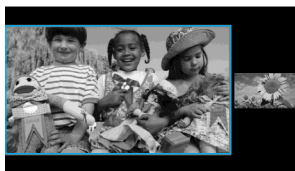

To activate the left picture

- Press .

 Hookups that affect your ability to use Twin View:

- If you are viewing all channels through the cable box, the Twin View feature will not work. The cable box only unscrambles one signal at a time, so the right picture will be the same as the left picture.
- You can watch a scrambled cable channel and another video source. Be sure your DVD player, VCR or satellite receiver are connected to one of the VIDEO IN 1-7 and AUX inputs on the rear of the LCD projection TV. Pictures from equipment connected to HD/DVD IN 5 and 6, DVI-HDTV IN 7, and AUX will only appear in the left picture, not in the right.

Factors Affecting Twin View

- ❑ If you use a cable box to view all channels, the same channel appears in both windows because the cable box unscrambles only one channel at a time.
- ❑ If you use a cable box, you can view the cable box output in one window and view a different source (such as a VCR or DVD player) in the second window by using the TV/VIDEO button.
- ❑ Sources connected to the AUX, VIDEO 5, VIDEO 6, and VIDEO 7 inputs display in the left window, but not the right.
- ❑ If you are viewing a 4:3 source and a 16:9 enhanced source (such as a DVD) side by side, the 4:3 source appears larger.
- ❑ Twin View does not display channels that are blocked by parental settings (see page 78).

Changing the Picture Size

The zoom feature lets you change the size of the left and right pictures.

To enlarge the left picture (reduce the right)

- 1 Press **←** to activate the left picture (if not already activated).
- 2 Press **↑** to enlarge the picture and **↓** to reduce the picture.

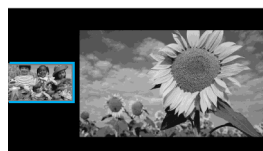
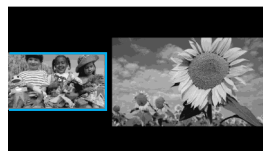
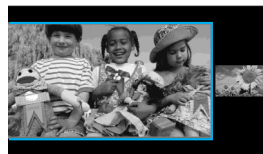

To enlarge the right picture (reduce the left)

- 1 Press **→** to activate the right picture (if not already activated).
- 2 Press **↑** to enlarge the picture and **↓** to reduce the picture.

 When you adjust the twin screen sizes, the LCD projection TV memorizes the change. The next time you use the Twin View function, the memorized sizes appear.

Using the Freeze Function

The FREEZE button allows you to temporarily capture a program's picture. You can use this feature to write down information such as phone numbers, recipes, etc.

To use the Freeze function

- 1 When the program information you want to capture is displayed, press FREEZE.
- 2 The LCD projection TV switches to Twin View mode and displays the "frozen" picture on the right, while the current program continues on the left.

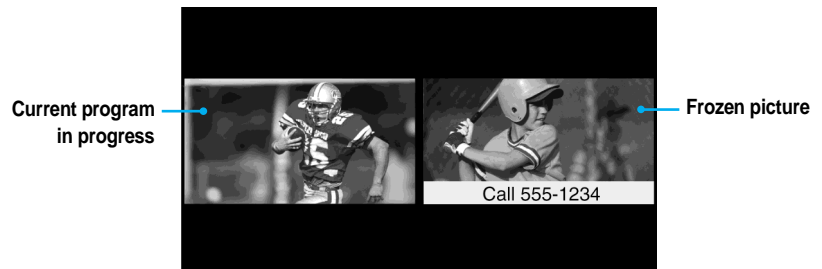

- 3 To cancel and return to normal viewing, press FREEZE.

 Freeze feature is not available if you are already in Favorite Channel (see page 49) or Twin View™ (see page 50).

Using Wide Screen Mode

Wide Screen Mode lets you watch 4:3 normal broadcasts in several Wide Screen Modes (16:9 aspect ratio).

- Press WIDE MODE repeatedly to toggle through the following Screen Mode settings.



You can also access the Screen Mode settings in the Screen menu. For details, see page 74.



Wide Zoom



Normal



Full



Zoom

Wide Zoom enlarges the 4:3 picture to fill the 16:9 screen, keeping the original image as much as possible.

Normal returns the 4:3 picture to its original size.

Full Mode stretches the 4:3 picture horizontally only, to fill the 16:9 screen.

Zoom Mode enlarges the 4:3 picture horizontally and vertically to an equal aspect ratio that fills the 16:9 screen. Useful for watching Letterbox movies.



When you change channels or inputs, the Screen Mode settings revert to Wide Zoom (or the 4:3 Default setting in the Wide menu). To retain the current Screen Mode setting as channels and inputs are changed, set 4:3 Default to Off. For details, see page 75.

Using the Memory Stick Viewer



About Memory Stick

Memory Stick (sold separately) is a new, compact, portable, and versatile Integrated Circuit recording medium with a data capacity that exceeds that of a floppy disk. Memory Stick is specially designed for exchanging and sharing digital data among Memory Stick compatible products such as digital cameras and digital video cameras. Because it is removable, Memory Stick can also be used for external data storage.



The Memory Stick Viewer on your LCD projection TV allows you to view still images (JPEG files) and movies (MPEG1 files) stored on Memory Stick media.

For more information about using Memory Stick media, see “Notes on Using Memory Stick, Memory Stick PRO Media” on page 90.

 "Memory Stick", "Memory Stick PRO", "Memory Stick Duo" and " " are registered trademarks of Sony Corporation.

Supported Image Types

This LCD projection TV's Memory Stick viewer can display still images and movies that have been recorded on Memory Stick media.

You can view;

- JPEG images taken with Sony digital cameras
- MPEG1* movies taken with digital cameras and camcorders

* Some variations of MPEG1 movies may not play back correctly.

(Continued)

- ✎ JPEG stands for “Joint Photographic Experts Group,” which is the organization that implemented this format. DCF stands for “Design Rules for Camera File Systems,” which are specifications established by the Japan Electronic Industry Development Association (JEIDA).
- ✎ MPEG1 stands for “Motion Picture Experts Group” which is the organization that implemented this format and is the typical compression format for movie files.

About Directory and File Names

Most Sony brand digital still and video cameras automatically record still images using DCF compliant directory and file names, or record movies using the directory and file names as shown in the following examples:

Still image files

Example:

Directory Name: /DCIM/100MSDCF

File Name: DSC00001.JPG

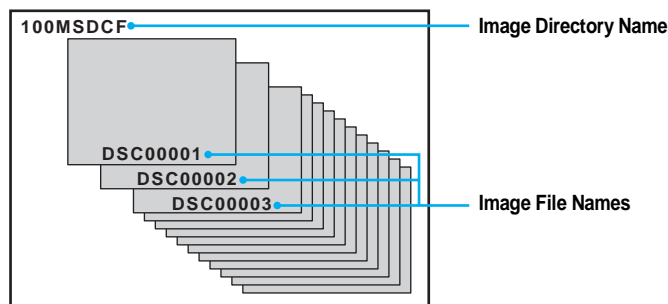

Movie files

Example:

Directory Name: /MSSONY/MOML0001

File Name: MOV00001.MPG

Unsupported Image Types

This LCD projection TV’s Memory Stick viewer cannot display any of the following:

- ❑ Images stored in TIFF or any other non-JPEG or non-MPEG compression format
- ❑ Images with less than 16 horizontal and/or vertical dots per line
- ❑ Images with more than 4096 horizontal and/or vertical dots per line
- ❑ An image processed by a computer may not be displayed correctly.

Inserting and Removing a Memory Stick

To insert a Memory Stick

- 1 Locate the Memory Stick slot (see page 21) and insert the Memory Stick into the Memory Stick slot as illustrated below. When inserted properly, it should slide in with little resistance and click into place.

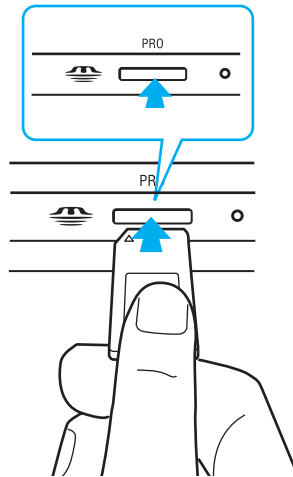

-  Be sure to insert the Memory Stick in the correct direction. If the Memory Stick is forced in the wrong way, it may become damaged. Insert only Memory Stick media into the Memory Stick slot. Attempting to insert other objects into the slot may damage the LCD projection TV. Before inserting a Memory Stick Duo into the Memory Stick slot, you must first insert the Memory Stick Duo into an adaptor (optional).

To remove a Memory Stick

- 1 Check that the Memory Stick indicator is off. (When the light is on, this indicates that the LCD projection TV is reading data from the Memory Stick.)

(Continued)

- 2 Push the Memory Stick gently into the slot, and then release it. The Memory Stick media is ejected.

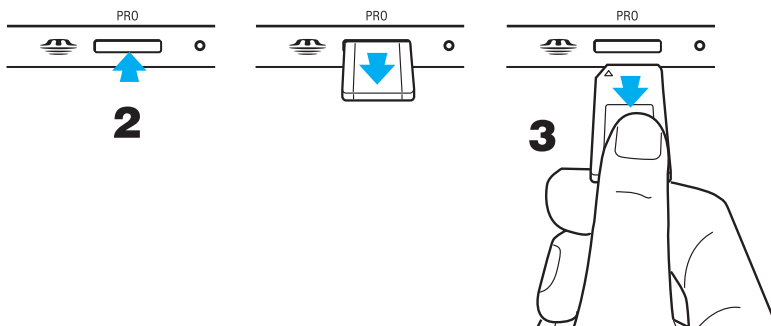

- 3 Pull the Memory Stick completely out of the slot.

 When removing the Memory Stick, do not attempt to just pull it from its slot.

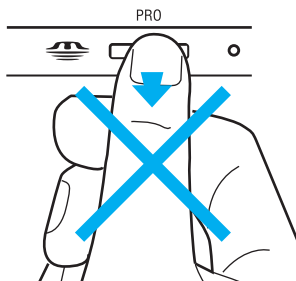

 To protect small children from injury from Memory Stick Media, remove all Memory Stick media from the LCD projection TV's Memory Stick slot and store it in a safe location when it is not in use.

Displaying the Memory Stick Home (Memory Stick Index)

Turn on the your LCD projection TV and insert a Memory Stick that contains the photo or movie files you want to view. For details on inserting a Memory Stick, see “To insert a Memory Stick” on page 57.

The Memory Stick Home appears, which displays thumbnails of still image and movie files stored on the Memory Stick.

When MEMORY STICK  on the remote control is pressed, the Memory Stick Home also appears.

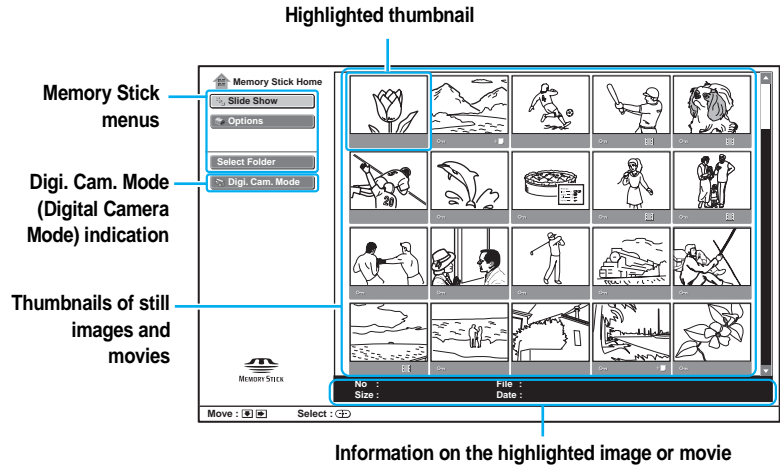

About the Icons on the Thumbnail Images

	(Movie)	Indicates the thumbnail is a movie (MPEG1) file.
	(Protect)	Indicates the thumbnail is protected. Protected files cannot be changed or deleted. For details, see “Using the Index Menu” on page 60.
	(Relative file)	Indicates another file named the same in the last four digits exists in the Memory Stick.

About the Digi. Cam. Mode (Digital Camera Mode)

Digi. Cam. Mode displays all JPEG and MPEG1 files recorded with the DCF compliant digital cameras. When you set the Digi. Cam. Mode to Off, the data of selected files or all files with the extension .jpg or .mpg can be displayed. The Memory Stick viewer of this projection TV sets Digi. Cam. Mode to On at the factory. When Digi. Cam. Mode is set to On, the maximum 2000 pieces of still images and/or movies can be displayed. When you want to display more than 2000 pieces of still images and/or movies, set Digi. Cam. Mode to Off. To set Digi. Cam. Mode to Off, see “Select Folder Menu Options” on page 66.

About caution displays

	This image data is the JPEG or MPEG1 format that is not-compatible.
	There is the thumbnail but it is not DCF-compatible.
	There is the image data but the thumbnail is broken.
	The image data is broken.

Using the Memory Stick Home

To Do This ...	Do This ...
Select the thumbnails	Press → .
Move the highlight to an image or movie thumbnail	Press ↑ ↓ ← → .
Display the previous or next page of thumbnails	<ol style="list-style-type: none"> 1 Select a file in the bottom row. 2 Press ↓. To go back to the previous page, press ↑. or <ol style="list-style-type: none"> 1 Select a file in the right-most column. 2 Press → to select a slider. 3 Press ↓. To go back to the previous page, press ↑.
Display the Index menu of the highlighted image or movie file to access additional options	Press ⊕ . For details on each Index menu, see “Using the Index Menu” on page 60.
Move the highlight to the Memory Stick Home menus to access additional options	<ol style="list-style-type: none"> 1 Press ↑ or ↓ to select Slideshow, Options or Select Folder. 2 Press ⊕. For details on these options, see “Memory Stick Home Menu Options” on page 65.
Exit Memory Stick Viewer	Press MEMORY STICK  on the remote control.

Using the Index Menu

When you select a still image or movie from the Memory Stick Home (see page 58), the Index menu appears with the following options. Press **↑** or **↓** to select the desired option.



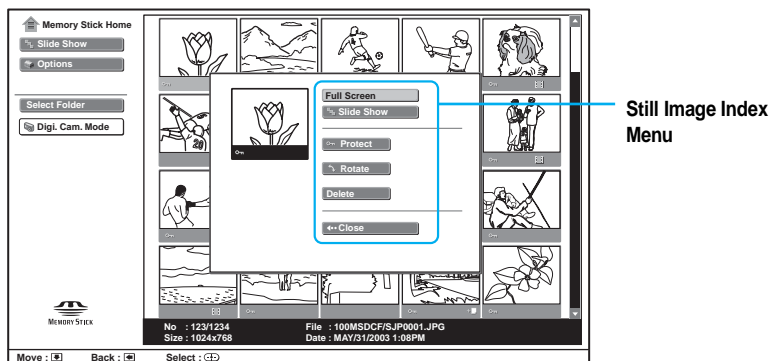

Still Image Index Menu

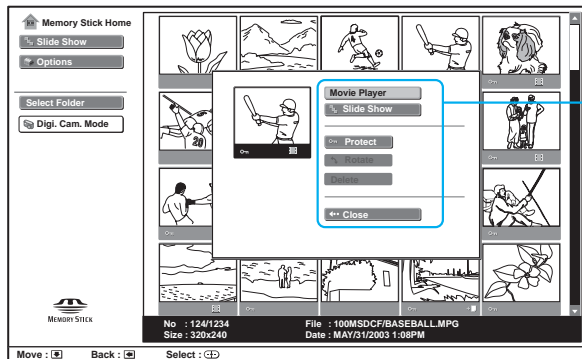

Movie Index Menu



Movie Index Menu

Option	Description
Full Screen (Still image index menu only)	Displays the highlighted image file full screen. For details, see “Viewing Still Images” on page 62.
Movie Player (Movie index menu only)	Display the Movie Player. For details, see “Playing Movies” on page 63.
Slide Show	Starts the slide show from the highlighted image or movie.
Protect	Allows you to protect the JPEG or MPEG1 file from any changes. Files that are protected are indicated by the  icon.
	On Protects the highlighted file.
	Off Unlock the protect of the highlighted file.
Rotate	Allows you to rotate a still image in 90 degree increments clockwise or counterclockwise. Select  (clockwise) or  (counterclockwise). You cannot rotate a still image that has been protected (or if the Memory Stick is locked). This option is not available for a movie file.
Delete	Deletes the JPEG or MPEG1 file from the Memory Stick. You cannot delete a file that has been protected (or if the Memory Stick is locked).
	Selected Deletes the highlighted file.
	After you select the option, the dialog appears. Select YES.
Close	Displays the Memory Stick Home. Pressing  also returns to the Memory Stick Home.

Viewing Still Images

When you select Full Screen from the Still image index menu and press **(+/-)**, it displays as shown below.

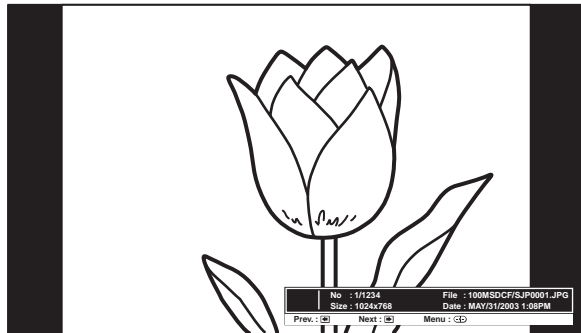

To Do This ...

Display the next or previous file on the Memory Stick

Access additional options

Exit Memory Stick Viewer

Do This ...

Press **→** to go to the next file, or **←** to go to the previous file.

Press **(+/-)**. For details, see “Image Setup Menu Options” on page 62.

Press **MEMORY STICK**  on the remote control.

Image Setup Menu Options

To access the Image setup menu

- 1 Press **↑** or **↓** to select the menu option.
- 2 Press **(+/-)**
- 3 Press **↑** or **↓** to select the desired option.

Image setup menu

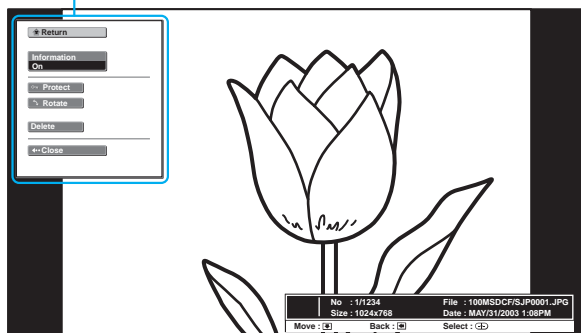

Option	Description
Return	Displays the Memory Stick Home.
Information	Allows you to turn on or off the display of file information. Select On or Off.
Protect	Allows you to protect this file from any changes. Selecting Off unlocks the protect.
Rotate	Allows you to rotate a still image in 90 degree increments clockwise or counterclockwise. If the file has been protected (or if the Memory Stick is locked), it cannot be rotated. Select ↻ (clockwise) or ↺ (counterclockwise).
Delete	Deletes the displayed file from the Memory Stick. Select Selected Items and press + . When the dialog appears, select YES. If the file has been protected (or if the Memory Stick is locked), it cannot be deleted.

Playing Movies

When you select Movie Player from the Movie index menu, it displays as shown below.

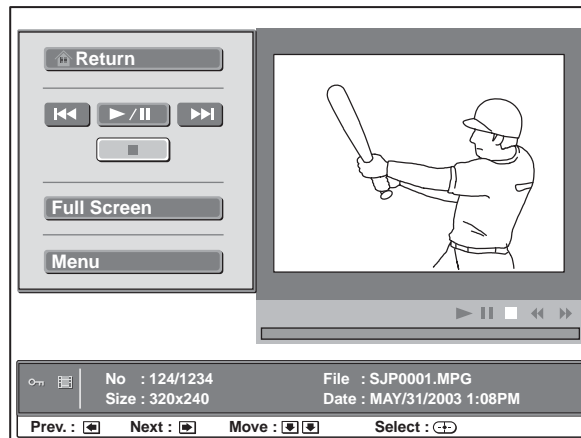

To Do This ...

Play (or pause) the movie.

Do This ...

1 Press **↑** or **↓** to select **▶/⏸**.

2 Press **+**.

Display the previous file on the Memory Stick

Press **←** during movie stop mode.

During playback or pause mode the control changes to **⏮** (Rewind).

(Continued)

To Do This ...	Do This ...
Display the next file on the Memory Stick	Press → during movie stop mode. During playback or pause mode the control changes to ▶▶ (Fast-forward).
Stop playback.	Press ↑ or ↓ to select ■ and press ⊕ .
Display the movie full screen	Press ↑ or ↓ to select Full Screen and press ⊕ . To display the Movie Player window, press ⊕ .
Display the Movie setup menu to access additional options	1 Press ↑ or ↓ to select Menu. 2 Press ⊕ . For details, see “Movie Setup Menu Options”.
Displays the Memory Stick Home.	1 Press ↑ or ↓ to select Return. 2 Press ⊕ .

 When displaying a large file, it will take longer time.

 The rewind and fast-forward may not work due to the movie file.

Movie Setup Menu Options

To access the Movie setup menu

- 1 Press **↑** or **↓** to select the menu option.
- 2 Press **⊕**
- 3 Press **↑** or **↓** to select the desired option.

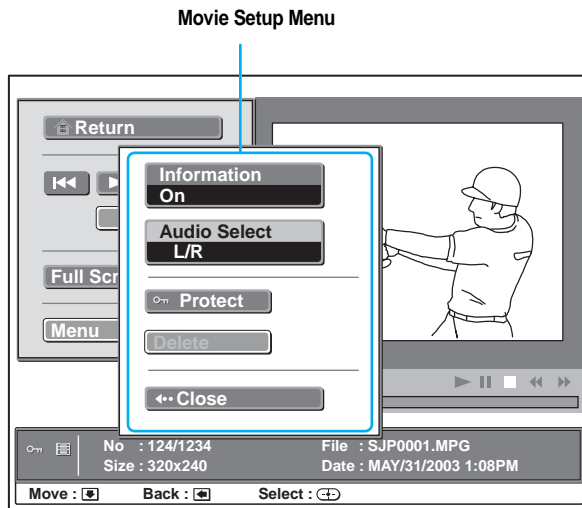

Option	Description
Information	Allows you to turn on or off the display of file information. Select On or Off .
Audio Select	Switches the sound to be heard. Select L (left sound), R (right sound) or L/R (left and right sounds) to hear the respective sound(s). The setting affects movie files.
Protect	Allows you to protect the file from any changes. Select On to protect. Select Off to unlock the protect.
Delete	Deletes the displayed file from the Memory Stick. Select Selected Items and press (+) . When the dialog appears, select YES . If the file has been protected (or if the Memory Stick is locked), it cannot be deleted.

Memory Stick Home Menu Options

The Memory Stick Home lets you select the Slide Show, Options and Select Folder menus that include additional options for each menu.

To access the Memory Stick Home menu

- 1 Press **↑** or **↓** to select Slide Show, Options or Select Folder.
- 2 Press **(+)**. The setup menu appears.
- 3 Press **↑** or **↓** to select the desired option and press **(+)**.

Slide Show Menu Options

The Slide Show menu includes the following menu options.

Option	Description				
Start	Starts the slide show. Slide show plays all still and movie files. To stop the slide show, press (+) .				
Advance	<table border="0"> <tr> <td>Auto</td> <td>Advances slides automatically. Slide show repeats after all files are displayed. Press (+) to stop the slide show.</td> </tr> <tr> <td>Manual</td> <td>Advances slides manually. Press → or ← on the remote control to go to the next or previous still or movie image file. Select ▶/ to play movie files in the Movie Player window.</td> </tr> </table>	Auto	Advances slides automatically. Slide show repeats after all files are displayed. Press (+) to stop the slide show.	Manual	Advances slides manually. Press → or ← on the remote control to go to the next or previous still or movie image file. Select ▶/ to play movie files in the Movie Player window.
Auto	Advances slides automatically. Slide show repeats after all files are displayed. Press (+) to stop the slide show.				
Manual	Advances slides manually. Press → or ← on the remote control to go to the next or previous still or movie image file. Select ▶/ to play movie files in the Movie Player window.				
Interval	Allows you to specify a timed slide advance after a selected time interval. Select from 5 sec , 10 sec , 30 sec , 1 min and 5 min .				
Close	Displays the Memory Stick Home.				

Options Menu Options

The Options Menu includes the following options.

Option	Description
File	The File option is available when Digi. Cam. Mode is set to Off. For details, see “Using Select Folder Menu” on page 67.
Sort	Allows you to change the order in which the Memory Stick files are displayed. Select from Name Order \downarrow^A_Z (in alphabetical order by filename), Name Order \downarrow^Z_A (in reverse alphabetical order by filename), Date Order \downarrow^1_9 (in chronological order by recording or modification date) and Date Order \downarrow^9_1 (in reverse chronological order by recording or modification date).  The Sort function works only when fewer than 2000 files are saved.
Filter	Allows you to selectively display specific file types within the selected folder. Select from Show Stills (only still image files), Show Movies (only movie files), and Off (all readable files).
Memory Stick	Displays the current status of the Memory Stick, including Memory Stick type, total capacity, used capacity, and free capacity.

Select Folder Menu Options

The Select Folder Menu includes the following options.

Option	Description
Digi. Cam. Mode On	Displays only JPEG and MPEG1 files defined by the DCF rules and JPEG and MPEG1 files recorded on a Sony digital still camera or digital video camera.
Off	Displays all folders within the directories. JPEG and MPEG1 files in those directories are recognized even if they do not conform to the DCF file naming rules.

Using Select Folder Menu

Allows you to select different folders to view in the Memory Stick Viewer when you set Digi. Cam. Mode to Off.

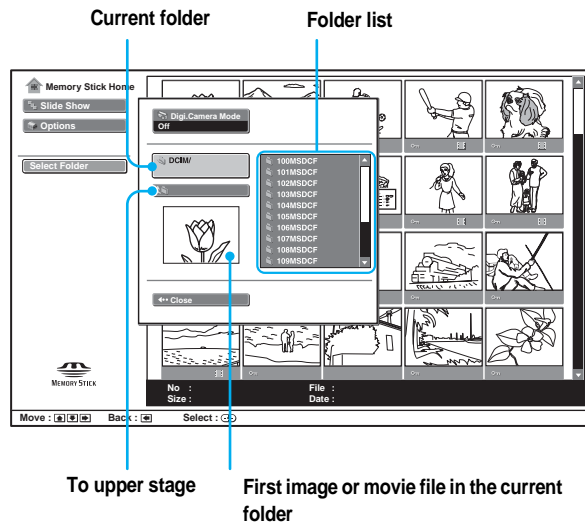

- 1 Select Off in Digi. Cam. Mode.
 - 2 Press **→** to select the folder list.
 - 3 Press **↑** or **↓** to select the folder which includes the file you want, and press **⊕**.
-  To select the hidden folders, press **→** to select the slider and press **↑** or **↓**.

Using the Menus

Overview

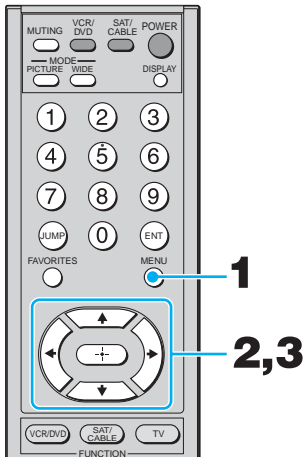

Opening and choosing a menu

- 1 Press MENU to display the menu screen.
- 2 Press ◀ or ▶ to highlight the desired menu icon and press (+) to select it.
- 3 Use the arrow button to scroll through the features.
- 4 See the specific menu page for instructions on moving through the menu.







To end a menu session

- Press MENU again.

To end one menu session and move to another

- Press ▲ to return to the menu icons.
Press ◀ or ▶ to choose the next menu icon and press (+) to select it.

The menu gives you access to the following features:

Menu Icon	Description	Page
	Allows you to make adjustments to your picture settings. It also allows you to customize the Picture Mode based on the type of program you are viewing.	69
	Offers enhanced audio options such as listening to second audio programming (SAP), or customizing the Effect of the sound on your LCD projection TV.	72
	Allows you to set the wide screen mode, adjust the vertical center in wide mode, and set the 4:3 Default mode.	74
	Allows you to set up a Favorite Channel list, run the Auto Program function, and more.	76
	Lets you control the viewing of programs based on their ratings.	78
	Provides several options for setting up your channels, labeling your Video inputs, and selecting the language of the on-screen menus.	82



Using the Video Menu

To select the Video Menu

- 1 Press MENU.
- 2 Press **←** or **→** to highlight the Video icon  and press **+**.
- 3 Use the arrow button to scroll through the features.
- 4 Press **+** to select a feature. That feature's adjustment appears.
- 5 Use the arrow button to make the desired adjustments.
- 6 Press **+** to select/set.
- 7 Press MENU to exit the menu screen.

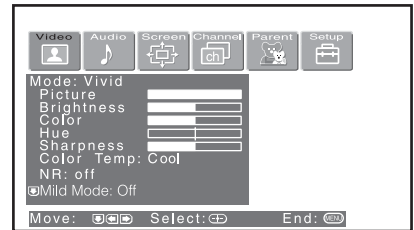





To restore the factory default settings for Picture, Brightness, Color, Hue, Sharpness and Color Temp

- Press RESET on the remote control when in the Video menu.

Selecting Video Options





The Video menu includes the following options.

Option	Description
Mode	Vivid Select for enhanced picture contrast and sharpness.
Customized picture viewing	Standard Recommended for Normal viewing conditions.
	Pro Select to display a picture with minimum enhancements.

-  You can alter the Video menu settings (Picture, Brightness, Color, etc.) for each Mode.
-  You may set up a Picture Mode (Vivid, Standard, Pro) independently for each Video input (Video 1 - Video 7, including the Antenna input). Your Picture Mode settings will automatically be saved after each selection. This will enable you to customize the Picture Mode setting for each type of signal source. Typically, Vivid should be used for higher quality input signal sources, and Pro for lower quality signals.
-  We recommend selecting Standard for normal home use.
-  To quickly and easily change from one Video Mode to another, use PICTURE MODE on the remote control.

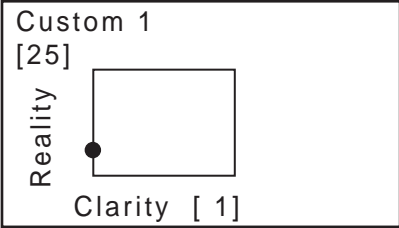
(Continued)

<i>Option</i>	<i>Description</i>		
Picture	Adjust to increase picture contrast and deepen the color or decrease picture contrast and soften the color.		
Brightness	Adjust to brighten or darken the picture.		
Color	Adjust to increase or decrease color intensity.		
Hue	Adjust to increase or decrease the green tones.		
Sharpness	Adjust to sharpen or soften the picture.		
Color Temp	Choose from three color temperatures:		
<i>White intensity adjustment</i>	Cool	Select to give the white colors a blue tint.	
	Neutral	Select to give the white colors a neutral tint.	
	Warm	Select to give the white colors a red tint.	
NR <i>Noise Reduction</i>	Select to reduce the noise level of connected equipment. It is also effective on the signal from the VHF/UHF jack. Select from High , Medium , Low and Off .		
Mild Mode	On	Select for a natural, soft picture.	
	Off	Select to turn off the Mild Mode.	
	 Mild Mode is unavailable when the Mode is set to vivid.		
Advanced Video	Program	DRC Mode	
		Creates a high-resolution picture with 4x density, for high quality sources (i.e., DVD player, satellite receiver).	
		High Density	Recommended for moving pictures.
		Progressive	Recommended for still images and text.
	CineMotion	Provides an optimized display by automatically detecting film content and applying a reverse 3/2 pulldown process. Moving pictures will appear clearer and more natural-looking.	

Option	Description
Advanced Video (Continued)	<p>Palette</p> <p>Allows you to customize the level of detail (Reality) and smoothness (Clarity) for up to three input sources. For example, you can create one Custom setting to optimize your cable input's picture, and create another to optimize your DVD player's picture. You can switch among the three Custom settings.</p>
	<p>1 Press the arrow button to highlight Custom 1, Custom 2, or Custom 3 and then press .</p> <p>The DRC palette appears.</p>
	
	<p>2 Press the arrow button to adjust the position of the marker (●). As you move the ● higher along the Reality axis, the picture becomes more detailed. As you move the ● to the right along the Clarity axis, the picture becomes smoother.</p>
	<p>3 To save the setting, press .</p> <p>To return the Custom options to the default factory settings, press the RESET button.</p>
	<p> Advanced Video is unavailable when you have selected Mild picture mode, or you are watching 1080i, 720p and 480p sources with Video 5 to 7 inputs.</p>
<p>BN Smoother <i>Block Noise Smoother</i></p>	<p>Select to reduce noise caused by video encoding and decoding process. It is especially effective for watching a DVD or HDTV picture. Select from High, Medium, Low and Off.</p>
	<p> An image may not be corrected due to the connected equipment.</p>



Using the Audio Menu

To select the Audio Menu

- 1 Press MENU.
- 2 Press **←** or **→** to highlight the Audio icon  and press **⏏**.
- 3 Use the arrow button to scroll through the options.
- 4 Press **⏏** to select an option. That option's settings appear.
- 5 Use the arrow button to scroll through the settings.
- 6 Press **⏏** to select the desired setting.
- 7 Press MENU to exit the menu screen.

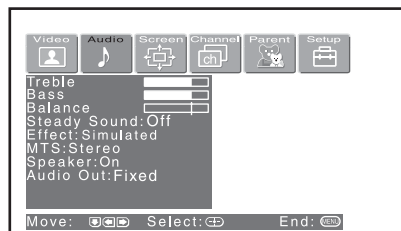

To restore the factory default settings for Treble, Bass and Balance

- Press RESET on the remote control when in the Audio menu.

Selecting Audio Options

The Audio menu includes the following options:

Option	Description
Treble	Adjust to increase or decrease higher-pitched sounds.
Bass	Adjust to increase or decrease lower-pitched sounds.
Balance	Adjust to emphasize left or right speaker balance.
Steady Sound	Auto Select to stabilize the volume.
	Off Select to turn off Steady Sound.
Effect	TruSurround Select for surround sound (for stereo programs only).
	Simulated Adds a surround-like effect to mono programs.
	Off Normal stereo or mono reception.
MTS <i>Enjoy stereo, bilingual and mono programs</i>	Stereo Select for stereo reception when viewing a program broadcast in stereo.
	Auto SAP Select to automatically switch the LCD projection TV to second audio programs when a signal is received. (If no SAP signal is present, the LCD projection TV remains in Stereo mode.)
	Mono Select for mono reception. (Use to reduce noise during weak stereo broadcasts.)

Option	Description	
Speaker	On	Select to turn on the LCD projection TV speakers.
	Off	Select to turn off the LCD projection TV speakers and listen to the LCD projection TV's sound only through your external audio system speakers.
Audio Out <i>Easy control of volume adjustments</i>	Variable	The LCD projection TV's speakers are turned off, but the volume output from your audio system can still be controlled by the LCD projection TV's remote control.
	Fixed	The LCD projection TV's speakers are turned off and the volume, bass and treble output of the LCD projection TV is fixed. Use your audio receiver's volume control to adjust the volume through your audio system.



Using the Screen Menu

To select the Screen menu

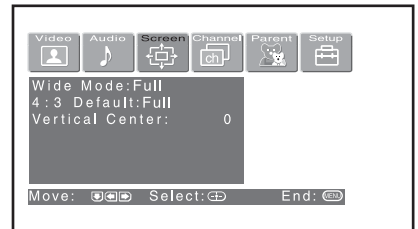

- 1 Press MENU.
- 2 Press ← or → to highlight the Screen icon  and press (+).
- 3 Use the arrow button to scroll through the features.
- 4 Press (+) to select a feature. That feature's options appear.
- 5 Use the arrow button to scroll through the options.
- 6 Press (+) to select the desired option.
- 7 Press MENU to exit the menu screen.











Selecting Screen Options

The Screen menu includes the following options:

-  To change from one Wide Mode to another, use WIDE MODE on the remote control.





Option	Description	
Wide Mode	Wide Zoom	
<i>Select a Screen Mode to use for 4:3 sources.</i>	Select to enlarge the 4:3 picture, to fill the 16:9 screen, keeping the original image as much as possible.	
	Normal	Select to return the 4:3 picture to normal mode.
	Full	Select to enlarge the 4:3 picture horizontally only, to fill the wide screen.
	Zoom	Select to enlarge the 4:3 picture horizontally and vertically to an equal aspect ratio that fills the wide screen.
	Wide Mode is unavailable while in Twin View (page 50) or Freeze (page 53).	
	Wide mode is unavailable when you are watching 720p and 1080i sources, and when viewing photos from your Memory Stick media.	

Option	Description	
4:3 Default <i>Select the default Screen Mode to use for 4:3 sources.</i>	Wide Zoom	Select to enlarge the 4:3 picture, to fill the 16:9 screen, keeping the original image as much as possible.
	Normal	Select to return the 4:3 picture to normal mode.
	Full	Select to enlarge the 4:3 picture horizontally only, to fill the wide screen.
	Zoom	Select to enlarge the 4:3 picture horizontally and vertically to an equal aspect ratio that fills the wide screen.
	Off	Select to continue using the current Screen Mode setting when the channel or input is changed.
		<p> The 4:3 Default functions only when the LCD projection TV receives 480i and 480p signals.</p> <p> If 4:3 Default is set to anything but Off, the Wide Mode setting changes only for the current channel. When you change channels (or inputs), Wide Mode is automatically replaced with the 4:3 Default setting. To retain the current Wide Mode setting as channels and inputs are changed, set 4:3 Default to Off.</p>
Vertical Center	Adjust	<p>Allows you to move the position of the picture up and down in the window. (Available only in Wide Zoom and Zoom modes.)</p> <p>Press  or  and press  to choose a position between +25 and -25 (Zoom mode), and +10 and -10 (Wide Zoom mode).</p>
Vertical Size	Adjust	<p>Allows you to adjust the vertical size of the picture. (Available only in Wide Zoom and Zoom modes.)</p> <p>Press  or  and press  to choose a correction between +7 and -7.</p>



Using the Channel Menu

To select the Channel Menu



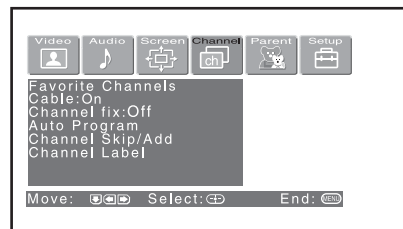











- 1 Press MENU.
- 2 Press ◀ or ▶ to highlight the Channel icon  and press .
- 3 Use the arrow button to scroll through the features.
- 4 Press  to select a feature. That feature's options appear.
- 5 Use the arrow button to scroll through the options.
- 6 Press  to select the desired option.
- 7 Press MENU to exit the menu screen.



Selecting Channel Options

The Channel menu includes the following options:

Option	Description
Favorite Channels	Let you set up a list of your favorite channels. For details, see “Using Favorite Channels” on page 49.
Cable	<p>On Select if you are receiving cable channels with a CATV cable.</p> <p>Off Select if you are using an antenna.</p> <p> You should run Auto Program after changing the Cable setting.</p>
Channel Fix	2-6 “Fix” your TV's channel setting to 2-6 and use the cable box or satellite receiver to change channels. Select one of these settings if you connected the equipment to the VHF/UHF jack.
<i>Useful when you have a cable box or satellite receiver connected</i>	<p>AUX 2-6 Same as 2-6, except you select one of these settings if you have connected the device to the AUX jack (see page 23).</p> <p>Video 1 Use when connecting a cable box. TV output should be connected through the cable box.</p>
Auto Program	Automatically programs the LCD projection TV for all receivable channels.



Option	Description
Channel Skip/Add	<p data-bbox="623 187 991 213">Removes and adds viewable channels.</p> <ol style="list-style-type: none"> <li data-bbox="623 227 1217 288">1 Use the arrow button to scroll through the channels until you find the channel you want to skip/add. <li data-bbox="623 302 897 328">2 Press  to select it. <li data-bbox="623 348 1157 374">3 Press  or  to toggle between “Add” and “Skip.” <li data-bbox="623 395 878 421">4 Press  to select. <p data-bbox="623 442 1233 499"> Channels that you set to be skipped can be accessed only with the 0-9 buttons.</p>
Channel Label	<p data-bbox="623 513 1184 565">Allows you to assign labels (such as station call letters) to channel numbers. You can label up to 40 channels.</p> <ol style="list-style-type: none"> <li data-bbox="623 579 1188 640">1 Press the arrow button to highlight Channel and press . <li data-bbox="623 654 1237 749">2 Press  or  to scroll through the channel numbers (1-125). Then press  to select the channel number that you want to assign a label. <li data-bbox="623 763 1233 789">3 Press the arrow button to highlight Label and press . <li data-bbox="623 810 1237 888">4 Press  or  to scroll through the label characters (A-Z, 0-9, etc.). Then press  to select the highlighted character. <li data-bbox="623 909 1099 935">5 Repeat to add up to 5 characters to the label. <li data-bbox="623 956 1166 982">6 To assign labels to more channels, repeat steps 1-4. <li data-bbox="623 1003 1233 1064">7 Press  to return to the Channel Menu, or press MENU to exit the Menus. <p data-bbox="623 1078 1184 1124"> Channel Label is not available (grayed out) when watching the AUX and VIDEO inputs.</p>





Using the Parent Menu

The Parent Menu allows you to set up the TV to block programs according to their content and rating levels.

To select the Parent Menu

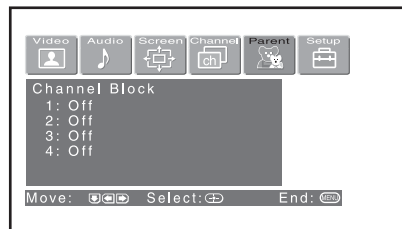
- 1 Press MENU.
- 2 Press **◀** or **▶** to highlight the Parent icon  and press .
- 3 Use the 0-9 buttons on the remote control to enter a four-digit password.
- 4 If this is the first time you are creating this password, confirm the password by entering it again. (The Parent Menu options appear.)
- 5 Press **▲** **▼** **◀** **▶** to change settings. Press  to select the changed setting.
- 6 Press MENU to exit the Menu.





 You need your password for any future access into the Parent Menu. If you lose your password, see “Lost password” on page 97.

Selecting Parent Options

The Parent Menu includes the following options:

Option	Description
Parental Lock <i>Turn ratings on/off and select a rating system</i>	Off Parental lock is off. No programs are blocked from viewing.
	Child Maximum ratings permitted are: US: TV-Y, TV-G, G Canada: C, G, TV-Y
	Youth Maximum ratings permitted are: US: TV-PG, PG Canada: C8+, PG, 8 ans+, TV-PG
	Y. Adult Maximum ratings permitted are: US: TV-14, PG-13 Canada: 14+, 13 ans+, TV-14
	Custom Select to set ratings manually. US: See page 80 for details. Canada: See page 81 for details.

Option	Description
	<p> If you are not familiar with the Parental Guideline rating system, you should select Child, Youth, or Young Adult to help simplify the rating selection. To set more restrictive ratings, select Custom.</p> <p> For descriptions of Child, Youth, and Young Adult ratings, see page 80.</p>
Change Password	For changing your password.
Select Country	<p>U.S.A. Select to use USA ratings (see page 80).</p> <p>Canada Select to use Canadian ratings (see page 81).</p>

To deactivate the Parental Control feature

- Set Parental Lock to OFF when in the Parent menu.

To change the password

- 1 Select Change Password option when in the Parent menu using the arrow button, and press .
- 2 Enter a new four-digit password using the 0-9 buttons.
- 3 Confirm the new password by entering it again.
- 4 Press MENU to exit the menu screen.

Viewing Blocked Programs

You can view a blocked program by entering the password.

- 1 Press ENTER when tuned to a blocked program.
- 2 Enter your password using the 0-9 buttons.
Parental Control will be canceled temporarily until you turn your LCD projection TV off.

Selecting Custom Rating Options

US custom rating options

If you selected U.S.A. as the country of residence on page 79, the Custom Rating Menu includes the following options. (If you selected Canada, see page 81.)

 To ensure maximum blocking capability, the age-based ratings should be blocked.

Option	Description	
Movie Rating	G All children and General Audience.	
	PG Parental Guidance suggested.	
	PG-13 Parental Guidance for children under 13.	
	R Restricted viewing, parental guidance is suggested for children under 17.	
	NC-17 and X No one 17 and under allowed.	
TV Rating	Age-Based Options	
<i>Block programs by their rating, content or both</i>	TV-Y All children.	
	TV-Y7 Directed to older children.	
	TV-G General Audience.	
	TV-PG Parental Guidance suggested.	
	TV-14 Parents Strongly cautioned.	
	TV-MA Mature Audience only.	
	Content-Based Options	
	FV Fantasy Violence.	
	D Suggestive Dialogue.	
	L Strong Language.	
S Sexual situations.		
V Violence.		
Unrated	Block Blocks all programs and movies that are broadcast without a rating.	
	Allow Allows programs and movies that are broadcast without a rating.	
	 If you select "Block," please be aware that the following programs may be blocked: emergency broadcasts, political programs, sports, news, public service announcements, religious programs and weather.	

 The content ratings will increase depending on the level of the age-based rating. For example, a program with a TV-PG V (Violence) rating may contain moderate violence, while a TV-14 V (Violence) rating may contain more intense violence.

Canadian custom rating options

If you selected Canada as the country of residence on page 79, the Custom Rating Menu includes the following options. (If you selected U.S.A., see page 80.)

<i>Option</i>	<i>Description</i>	
English Rating	C	All children.
	C8+	Children 8 years and older.
	G	General programming.
	PG	Parental Guidance.
	14+	Viewers 14 and older.
	18+	Adult programming.
French Rating	G	General programming.
	8 ans+	Not recommended for young children.
	13 ans+	Not recommended for ages under 13.
	16 ans+	Not recommended for ages under 16.
	18 ans+	Programming restricted to adults.
USA Rating	See “TV Rating” on page 80 for details.	



Using the Setup Menu

To select the Setup Menu

- 1 Press MENU.
- 2 Press **←** or **→** to highlight the Setup icon  and press **(+)**.
- 3 Use the arrow button to scroll through the features.
- 4 Press **(+)** to select a feature. That feature's options appear.
- 5 Use the arrow button to scroll through the options.
- 6 Press **(+)** to select the desired option.
- 7 Press MENU to exit the menu screen.

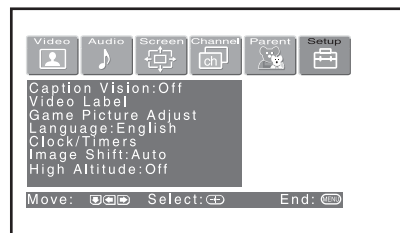

Selecting Setup Options

The Setup menu includes the following options:

Option	Description
Caption Vision	Allows you to select from three closed caption modes (for programs that are broadcast with closed captioning).
Off	Turns off Caption Vision.
CC1, CC2, CC3, CC4	Displays a printed version of the dialog or sound effects of a program. (Should be set to CC1 for most programs.)
Text1, Text2, Text3, Text4	Displays network/station information presented using either half or the whole screen (if available). For closed captioning, set to CC1.
Info	Displays the program name and the time remaining in the program (if the broadcaster offers this service). Displays when the channel is changed or the DISPLAY button is pressed.

<i>Option</i>	<i>Description</i>
Video Label	Allows you to label the audio/video components you connected to the LCD projection TV so you can identify them when using TV/VIDEO. When in the Setup menu's Video Label feature, press ▲ or ▼ to highlight an input to label, then press (+) to select it. Use the arrow button to scroll through the labels. Press (+) to select the component you connected to each of the input jacks on the back of your LCD projection TV. Select "Skip" if you do not have a component connected to a particular set of input jacks.
Video 1/2/3/4	VHS, DVD, Receiver, Satellite, Cable Box, 8mm, DTV, Game, LD, Web, Beta, Skip
Video 5/6/7	DVD, Satellite, Cable Box, DTV, HD, Game, Skip
	If you select "Skip," your LCD projection TV skips this connection when you press TV/VIDEO.
	 When you select "Receiver" on Video Label, your LCD projection TV's input is fixed (for Video 1 only).
Game Picture Adjust	Allows you to move the position of the picture left and right in the window. (Available for the picture of connected equipment.) Select while watching the picture to be adjusted. The TV stores the position in memory for each input.
Language	Select to display all on-screen menus in your language of choice: English, Español, Français.

(Continued)

Option	Description
Clock/Timers	Lets you set the clock on your TV and allows you to program your TV for scheduled viewing using the Timers.
Sleep	Allows you to select the time in minutes (15, 30, 45, 60, or 90) that you want the TV to remain on before shutting off automatically.
Timer 1 Timer 2	You can use the Timers to program the TV to turn on and off and tune to a specific channel at two scheduled viewing times.
Timer 1 and Timer 2 are not available to be set until you set the Current Time.	
<p>1 Press ▲ or ▼ to highlight Timer 1 or Timer 2. To set the timer, press ▶.</p>	
<p>2 Press ▲ or ▼ to highlight one of the following options, then press ⊕.</p>	
Program	Select to set the Timer by day, time, duration, and channel.
Off	Select to turn off the Timer. (Your previous settings are saved.)
<p>3 If you selected Program in step 2, press ▲ and ▼ to set the day(s), hour, minute, duration, and channel number. Press ⊕ or press ▶ to confirm each setting and move to the next setting. Press ◀ to go back to the previous setting.</p>	
<p>4 Press MENU to exit the Menu. An LED on the front panel will light, indicating the timer has been set.</p>	
<p> To go directly to programming Timer 1 or 2, press ⊕ instead of pressing ▶.</p>	
Current Time	
<p>1 Press ⊕ to select Current Time.</p>	
<p>2 Press ▲ and ▼ to set the current time (day, hour, and minute). Press ⊕ (or press ▶) to confirm each setting and move to the next setting. Press ◀ to go back the previous setting.</p>	
<p>3 Press MENU to exit the Menu.</p>	

Option	Description
--------	-------------

Image Shift	Corrects the Image on your LCD projection TV. Before adjusting
-------------	---

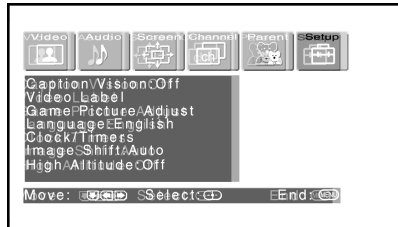

After adjusting

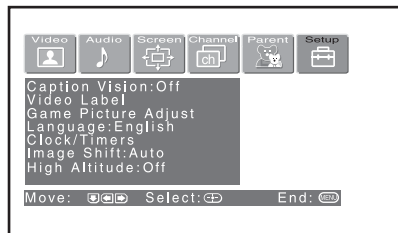

Auto: (Factory setting) Automatically corrects double images.

Level 1-4 (manual): Select the value with which double images are improved.

High Altitude	On	Set to use the unit at an altitude of 1,500 m (4921 ft.) or higher.
	Off	Set to use the unit at normal altitudes.

Other Information

Programming the Remote Control

The remote control is preset to operate Sony brand video equipment.

Function	Equipment	Programmable Code Number
VCR/DVD	Sony VCR	301
SAT/CABLE	Sony DSS tuner	801

If you have video equipment that you want to control with the LCD projection TV's remote control, use the following procedures to program the remote control.

 The equipment must have infrared (IR) remote capability in order to be used with the remote control.

From the "Manufacturer's Codes" listed on page 87, select the three-digit code number for the manufacturer's code for your component. If more than one code number is listed, start with the number listed first. Use the code number to complete the following procedure.

- 1 Press CODE SET.
- 2 Press the desired FUNCTION button.
- 3 Input the three-digit manufacturer's code number.
- 4 Press ENT.

 When no code number is input for 30 seconds or invalid or incorrect numbers are input, the remote control is reset to the normal TV remote control mode.

Tips

- ❑ If more than one code number is listed, try entering them one by one until you come to the correct code for your component.
- ❑ If you enter a new code number, the code number you previously entered at that setting is erased.
- ❑ In some rare cases, you may not be able to operate your component with the Sony remote control. In this case, use the component's own remote control unit.

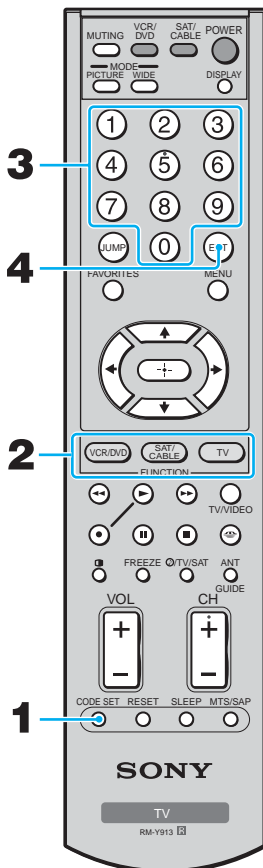

Other Information

Manufacturer's Codes

VCRs

<i>Manufacturer</i>	<i>Code</i>
Sony	301
Admiral (M. Ward)	327
Aiwa	338, 344
Audio Dynamic	314, 337
Broksonic	319, 317
Canon	309, 308
Citizen	332
Craig	302, 332
Criterion	315
Curtis Mathes	304, 338, 309
Daewoo	341, 312, 309
DBX	314, 336, 337
Dimensia	304
Emerson	319, 320, 316, 317, 318, 341
Fisher	330, 335
Funai	338
General Electric	329, 304, 309
Go Video	322, 339, 340
Goldstar	332
Hitachi	306, 304, 305, 338
Instant Replay	309, 308
JC Penney	309, 305, 304, 330, 314, 336, 337
JVC	314, 336, 337, 345, 346, 347
Kenwood	314, 336, 332, 337
LXI (Sears)	332, 305, 330, 335, 338
Magnavox	308, 309, 310
Marantz	314, 336, 337
Marta	332
Memorex	309, 335
Minolta	305, 304
Mitsubishi/MGA	323, 324, 325, 326
Multitech	325, 338, 321

<i>Manufacturer</i>	<i>Code</i>
NEC	314, 336, 337
Olympic	309, 308
Optimus	327
Panasonic	308, 309, 306, 307
Pentax	305, 304
Philco	308, 309
Philips	308, 309, 310
Pioneer	308
Quasar	308, 309, 306
RCA/PROSCAN	304, 305, 308, 309, 311, 312, 313, 310, 329
Realistic	309, 330, 328, 335, 324, 338
Sansui	314
Samsung	322, 313, 321
Sanyo	330, 335
Scott	312, 313, 321, 335, 323, 324, 325, 326
Sharp	327, 328
Shintom	315
Signature 2000 (M. Ward)	338, 327
SV2000	338
Sylvania	308, 309, 338, 310
Symphonic	338
Tashiro	332
Tatung	314, 336, 337
Teac	314, 336, 338, 337
Technics	309, 308
Toshiba	312, 311
Wards	327, 328, 335, 331, 332
Yamaha	314, 330, 336, 337
Zenith	331

DVD Players

<i>Manufacturer</i>	<i>Code</i>
Sony	751
Panasonic	753
Pioneer	752
RCA	755
Toshiba	754

Cable Boxes

<i>Manufacturer</i>	<i>Code</i>
Hamlin/Regal	223, 224, 225, 226
Jerrold/G. I.	201, 202, 203, 204, 205, 206, 207, 208, 218, 222
Oak	227, 228, 229
Panasonic	219, 220, 221
Pioneer	214, 215
Scientific Atlanta	209, 210, 211
Sony	230
Tocom	216, 217
Zenith	212, 213

Satellite Receivers

<i>Manufacturer</i>	<i>Code</i>
Sony	801
General Electric	802
Hitachi	805
Hughes	804
Panasonic	803
RCA/ PROSCAN	802, 808
Toshiba	806, 807

Operating Other Components with Your LCD Projection TV Remote Control

Operating a VCR

Press FUNCTION VCR/DVD.

To Do This ...	Press
Turn on/off	SAT/CABLE (POWER)
Change channels	CH +/-
Record	▶ and ● simultaneously
Play	▶
Stop	■
Fast forward	▶▶
Rewind the tape	◀◀
Pause	(press again to resume normal playback)
Search the picture forward or backward	▶▶ or ◀◀ during playback (release to resume normal playback)

Operating a DVD Player

Press FUNCTION VCR/DVD.

To Do This ...	Press
Turn on/off	SAT/CABLE (POWER)
Play	▶
Stop	■
Pause	(press again to resume normal playback)
Step through different tracks of an audio disc	▶▶ to step forward or ◀◀ to step backward
Step through different chapters of a video disc	CH+ to step forward or CH- to step backward

Operating a Cable Box

Press FUNCTION SAT/CABLE.

To Do This ...	Press
Turn on/off	SAT/CABLE (POWER)
Select Cable Box	SAT/CABLE (FUNCTION)
Select a channel	0-9 buttons, ENTER
Change channels	CH +/-
Back to previous channel	JUMP

Operating a Satellite Receiver

Press FUNCTION SAT/CABLE.

To Do This ...	Press
Turn on/off	SAT/CABLE (POWER)
Select Satellite Receiver	SAT/CABLE (FUNCTION)
Select a channel	0-9 buttons, ENTER
Change channels	CH +/-
Back to previous channel	JUMP
Display channel number	DISPLAY
Display DBS menu	MENU
Select item	

Notes on Using Memory Stick, Memory Stick PRO Media

Memory Stick, Memory Stick PRO Precautions

When using Memory Stick, Memory Stick PRO media, follow these precautions:

- ❑ To avoid permanent damage to still image data, do not turn off the TV or remove Memory Stick media from the insertion slot while data is being read (as indicated by the Memory Stick indicator light being on).
- ❑ Avoid touching the terminal of Memory Stick media or bringing it into contact with a metal object.
- ❑ Do not drop, bend, or submit Memory Stick media to external shock.
- ❑ Do not disassemble or modify Memory Stick media.
- ❑ Avoid getting liquid on Memory Stick media.
- ❑ Apply labels only within the designated label area.

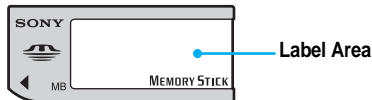

- ❑ To avoid permanent damage to still image data, do not use or store Memory Stick media in a location subject to:
 - ❑ High temperature (such as near a heater or inside a hot car)
 - ❑ High humidity
 - ❑ Direct sunlight
 - ❑ Corrosive substances
 - ❑ Magnetic fields
 - ❑ Excessive dust
 - ❑ Static electricity or electric noise
 - ❑ Electric surges
- ❑ Store and carry Memory Stick media in its original case to ensure protection of stored data.
- ❑ Save a backup of stored data.
- ❑ Memory Stick PRO of maximum 1GB-memory can be used for this unit.

Notes on Using Memory Stick Duo

Memory Stick Duo is a new, compact version of the standard-sized Memory Stick recording medium. You can use a Memory Stick Duo on your LCD projection TV by inserting a Memory Stick Duo into an adapter before inserting it into the TV.

- ❑ Be sure to attach a Memory Stick Duo to the adapter with the correct orientation.
- ❑ Be sure to insert the Memory Stick Duo adapter into the Memory Stick slot with the correct orientation. Otherwise, the LCD projection TV may be damaged.
- ❑ Do not insert the Memory Stick Duo adapter without the Memory Stick Duo attached. Doing so may result in malfunction of the LCD projection TV.

Contacting Sony

If, after reading these operating instructions, you have additional questions related to the use of your Sony television, please call our Customer Information Services Center at 1-800-222-SONY (7669) (US residents only) or (416) 499-SONY (7669) (Canadian residents only).

Troubleshooting

Twin View

<i>Problem</i>	<i>Possible Remedies</i>
I cannot get Twin View to work	<ul style="list-style-type: none">❑ If you are using a cable box to unscramble all channels (as shown on page 28), you cannot use the Twin View feature. This is because the cable box can unscramble only one channel at a time.❑ You can use Twin View to view a signal from a different source that is connected to the TV's A/V jacks (such as a VCR or DVD player) in the second window by pressing TV/VIDEO while in Twin View.❑ Sources connected to the AUX, HD/DVD IN 5 and 6, DVI-HDTV IN 7 inputs display in the left Twin View window, but not the right.
There is no Twin View window, or it is just static	<ul style="list-style-type: none">❑ Be sure the Twin View window is set to a video input or channel that has a signal airing.❑ You might be tuned to a video input with nothing connected to it. Try cycling through the video inputs by pressing TV/VIDEO.
Twin View cannot display anything but TV channels	<ul style="list-style-type: none">❑ Try cycling through the video inputs by pressing TV/VIDEO. Check that the Video Label option is not set to Skip. (See the Setup Menu on page 83.)
Twin View displays the same program in both windows	<ul style="list-style-type: none">❑ Both Twin View windows might be set to the same channel. Try changing channels in either window.

Remote Control

Problem	Possible Remedies
Remote control does not operate	<ul style="list-style-type: none"> <input type="checkbox"/> The batteries could be weak. Replace the batteries. <input type="checkbox"/> Check the orientation of the batteries. <input type="checkbox"/> Press FUNCTION (VCR/DVD, SAT/CABLE or TV) to select the equipment that you want to operate. <input type="checkbox"/> Make sure this unit's power cord is connected securely to the wall outlet. <input type="checkbox"/> Locate the unit at least 3-4 feet away from fluorescent lights.
Cannot change channels with the remote control	<ul style="list-style-type: none"> <input type="checkbox"/> If you are using the TV to change channels, first press FUNCTION TV button. <input type="checkbox"/> If you are using another device to change channels, be sure you have not inadvertently switched your TV from the channel 3 or 4 setting. Use the Channel Fix option to "fix" the channel based on the hookup you used (see page 76). <input type="checkbox"/> If you are using another device to change channels, be sure to press FUNCTION (VCR/DVD, SAT/CABLE or TV) for that device.
Remote control does not operate non-Sony video equipment	<ul style="list-style-type: none"> <input type="checkbox"/> If you replaced the batteries to the remote recently, the code numbers for the video equipment may need to be reset. <input type="checkbox"/> There may be more than one code for the equipment that you are attempting to operate. <input type="checkbox"/> There is a possibility that some non-Sony equipment cannot be operated by your Sony TV remote. You may need to use the equipment's original remote control.

Memory Stick

Problem	Possible Remedies
Image does not display	<ul style="list-style-type: none"> <input type="checkbox"/> Make sure the Memory Stick is inserted properly (see page 57). <input type="checkbox"/> Memory Stick functions are not available while using Twin View, Freeze or Favorite Channel functions. <input type="checkbox"/> Press the MEMORY STICK button (see page 45). <input type="checkbox"/> Make sure that the photo or movie files are contained in the Memory Stick. <input type="checkbox"/> Set Digi. Cam. Mode to Off and select the folder when the photo or movie image is processed by the computer.
"No Memory Stick" is displayed	<ul style="list-style-type: none"> <input type="checkbox"/> Make sure the Memory Stick is inserted properly (see page 57).
"Memory Stick error" is displayed	<ul style="list-style-type: none"> <input type="checkbox"/> The Memory Stick is not correct. Remove the Memory Stick and insert it again (see page 57). <input type="checkbox"/> The Memory Stick may be broken. Insert another Memory Stick.
"File error" is displayed	<ul style="list-style-type: none"> <input type="checkbox"/> A name of the selected file is not correct.
"Format error" is displayed	<ul style="list-style-type: none"> <input type="checkbox"/> The Memory Stick is not formatted correctly. Format correctly with other equipment such as a digital camera or insert another Memory Stick formatted correctly.
"Cannot play" is displayed	<ul style="list-style-type: none"> <input type="checkbox"/> Make sure that the photo or movie files to be played back are contained in the Memory Stick. <input type="checkbox"/> Set Digi. Cam. Mode to Off and select the folder.

(Continued)

Other Information

Problem	Possible Remedies
"Memory Stick type error" is displayed	<input type="checkbox"/> A Memory Stick not available for use with this LCD projection TV is inserted.
"No files that can be displayed" is displayed	<input type="checkbox"/> The photo or movie image to be played back is not contained when the Digi. Cam. Mode is set to On.
"No files in this folder that can be displayed" is displayed	<input type="checkbox"/> The photo or movie image is not contained in the selected folder when the Digi. Cam. Mode is set to Off.
"Memory Stick Locked" is displayed	<input type="checkbox"/> The Memory Stick is locked. Unlock the Memory Stick.
"No movie file" is displayed	<input type="checkbox"/> Show Movies is selected from Filter of the Option menu. However there is no movie file in the folder.
"No still file" is displayed	<input type="checkbox"/> Show Stills is selected from Filter of the Option menu. However there is no still file in the folder.
Cannot use Memory Stick Duo	<input type="checkbox"/> Check that the Memory Stick Duo and adaptor are inserted correctly.
Blank square appears instead of a thumbnail image	<input type="checkbox"/> This indicates that the image does not support a thumbnail view. Selecting the icon, however, displays the full-size image on the screen. It could also indicate that both the thumbnail and full-size images are corrupted or not supported.
Cannot rotate image, no thumbnail appears	<input type="checkbox"/> Be sure the LOCK switch on the Memory Stick is set to off. <input type="checkbox"/> If a blank square appears instead of the thumbnail image, this indicates that the image does not support a thumbnail view and cannot be rotated.
Cannot hear audio while using Memory Stick	<input type="checkbox"/> There is no audio available while using Memory Stick.
Image file name does not appear; instead, dashes (---) appear	<input type="checkbox"/> Dashes appear instead of the file name if the image was recorded using equipment that is not DCF-compliant. Dashes also appear if a DCF-compliant file was renamed.

Video

Problem	Possible Remedies
No picture (screen not lit), no sound	<input type="checkbox"/> If your LCD projection TV does not turn on, and a red light keeps flashing, your LCD projection TV may need service. Call your local Sony Service Center. <input type="checkbox"/> Make sure the power cord is plugged in. <input type="checkbox"/> Press POWER/STANDBY on the front of the LCD projection TV. <input type="checkbox"/> Check to see if the TV/VIDEO setting is correct: when watching TV, set to TV, and when watching connected equipment, set to VIDEO 1, 2, 3, 4, 5, 6 or 7. <input type="checkbox"/> The Parental Control feature is activated (See "Using the Parent Menu" on page 78.). <input type="checkbox"/> If your LCD projection TV's power is on, and LAMP (red) indication is flashing, the lamp for the light source burns out. Replace it with new Sony XL-2100U replacement lamp (see page 13). <input type="checkbox"/> Try another channel; it could be station trouble.

Problem	Possible Remedies
Dark, poor or no picture (screen lit), good sound	<ul style="list-style-type: none"> ❑ Adjust the Picture option in the Video Menu (see page 70). ❑ Adjust the Brightness option in the Video Menu (see page 70). ❑ Check the antenna/cable connections. It is strongly recommended to connect the antenna using a 75-ohm coaxial cable to get optimum picture quality. A 300-ohm twin lead cable can be easily affected by radio noise and the like, resulting in signal deterioration. If you use a 300-ohm twin lead cable, keep it away as far as possible from the LCD projection TV. Do not use an indoor antenna because it is especially susceptible to radio noise (see page 25).
No color	<ul style="list-style-type: none"> ❑ Adjust the Color option in the Video Menu (see page 70).
Only snow and noise appear on the screen	<ul style="list-style-type: none"> ❑ Check the antenna/cable connections. ❑ Check the Cable setting in the Channel menu (see “Cable” on page 76). ❑ Make sure the channel is broadcasting programs. ❑ Press ANT to change the input mode (see page 45).
Dotted lines or stripes	<ul style="list-style-type: none"> ❑ Adjust the antenna. ❑ Move the LCD projection TV away from noise sources such as cars, neon signs, or hair-dryers.
Double images	<ul style="list-style-type: none"> ❑ Use a highly directional outdoor antenna or a cable (when the problem is caused by reflections from nearby mountains or tall buildings). ❑ Set the Image Shift to an appropriate value. The default setting is Auto. If doubled images appear with Auto, select the best value from 1 to 4 (see page 85).
“Black box” on screen	<ul style="list-style-type: none"> ❑ You have selected a text option in the Setup Menu and no text is available. (see page 82) to reset Setup selections.) To turn off this feature, set the Caption Vision option to Off. If you were trying to select closed captioning, select CC1 instead of Text 1-4.
Black bands appear at the top and bottom of the screen	<ul style="list-style-type: none"> ❑ Some wide-screen programs are filmed in aspect ratios that are greater than 16:9 (this is especially common with theatrical releases). Your LCD projection TV will show these programs with black bands at the top and bottom of the screen. For more details, check the documentation that came with your DVD (or contact your program provider).
Certain programs on DVD or other digital sources display a loss of detail, especially during fast-motion or dark scenes	<ul style="list-style-type: none"> ❑ The compression used by certain digital broadcasts and DVDs may cause your TV’s screen to display less detail than usual, or cause artifacts (small blocks or dots, pixelations) to appear on your screen. This is due to your TV’s large screen and ability to show very fine detail, and is normal for certain digitally recorded programs. Adjust the reality/clarity in the Palette menu (see page 71) to optimize the picture while viewing these sources.
Some video sources do not appear when you press TV/VIDEO	<ul style="list-style-type: none"> ❑ Ensure that Video Label is not set to “Skip” (see “Video Label” on page 83).

(Continued)

Audio

<i>Problem</i>	<i>Possible Remedies</i>
Good picture, no sound	<ul style="list-style-type: none">❑ Press MUTING so that Muting disappears from the screen (see page 44).❑ Make sure the Speaker option is set to On in the Audio Menu (see page 73).
Audio noise	<ul style="list-style-type: none">❑ Communication problems may occur if the infrared communication equipment (e.g., infrared cordless headphones) is used near the TV. Please use headphones other than infrared cordless headphones. Also, if you use the infrared communication equipment other than infrared cordless headphones, move the infrared transceiver away from the TV until the noise is eliminated, or move the transmitter and receiver of the infrared communication equipment closer together.
Cannot gain enough volume when using a cable box	<ul style="list-style-type: none">❑ Increase the volume of the cable box using the cable box's remote control. Then press FUNCTION TV button and adjust the TV's volume.
Sound seems weak or insufficient	<ul style="list-style-type: none">❑ The TV's audio might be set to Auto SAP or Mono, when it might be better set to Stereo. In the Audio Menu (see page 72), set the MTS setting to Stereo. If already set to Stereo, switch to Mono (which may reduce background noise during weak stereo broadcasts).
Cannot raise the volume on external speakers	<ul style="list-style-type: none">❑ If the Speaker option is set to Off and the Audio Out option is set to Fixed (in order to output the sound to your audio system) use your audio receiver to adjust the sound (see page 73). Or, to use the TV remote control, set the Audio Out option to Variable.❑ To turn on the TV speakers, set the Speaker option to On (see page 73).

Channels

<i>Problem</i>	<i>Possible Remedies</i>
Cannot receive upper channels (UHF) when using an antenna	<ul style="list-style-type: none">❑ Change the Cable option to Off (see page 76).❑ Use Auto Program in the Channel Menu to add receivable channels that are not presently in the TV's memory (see page 76).
TV is fixed to one channel	<ul style="list-style-type: none">❑ Use Auto Program in the Channel Menu to add receivable channels that are not presently in the TV's memory (see page 76).❑ Check your Channel Fix settings (see page 76).
Cannot receive any channels when using cable TV	<ul style="list-style-type: none">❑ Use Auto Program in the Channel Menu to add receivable channels that are not presently in the TV's memory (see page 76).❑ Check your cable settings.❑ Make sure the Cable option is set to On in the Channel Menu (see page 76).
Cannot receive or select channels	<ul style="list-style-type: none">❑ Use Auto Program in the Channel Menu to add receivable TV channels that are not presently in TV memory (see page 76).
Cannot receive digital channels (when a DTV receiver is connected)	<ul style="list-style-type: none">❑ Check the connections between the DTV receiver and the LCD projection TV (see page 39).❑ Check your local listings to find out if you can receive digital broadcasts in your area.

General

<i>Problem</i>	<i>Possible Remedies</i>
How to restore Video settings to factory settings	<ul style="list-style-type: none"> ❑ Press RESET on the remote control while in the Video Menu (see page 69).
How to restore Audio settings to factory settings	<ul style="list-style-type: none"> ❑ Press RESET on the remote control while in the Audio Menu (see page 72).
Cannot cycle through the other video equipment connected to the TV	<ul style="list-style-type: none"> ❑ Be sure the Video Label option is not set to Skip (see page 83).
Cannot operate Menu	<ul style="list-style-type: none"> ❑ If a menu option appears in gray, this indicates that the menu option is not available.
Lost password	<ul style="list-style-type: none"> ❑ In the password screen (see page 78), enter the following master password: 4357. The master password clears your previous password; it cannot be used to temporarily unblock channels.
LED on the display unit is lit	<ul style="list-style-type: none"> ❑ The POWER/STANDBY LED lights up when the TV is turned on. If the LED blinks continuously, this may indicate the TV needs a service. ❑ The TIMER LED indicates that the timer is set. When the timer is set, this LED will remain lit even when the LCD projection TV is turned off.
LCD projection TV is fixed to one channel	<ul style="list-style-type: none"> ❑ Use Auto Program in the Channel menu to add receivable channels that are not presently in TV memory (see page 76). ❑ Check your Channel Fix settings (see page 76).

Flashing Indicators on the Front of the Monitor

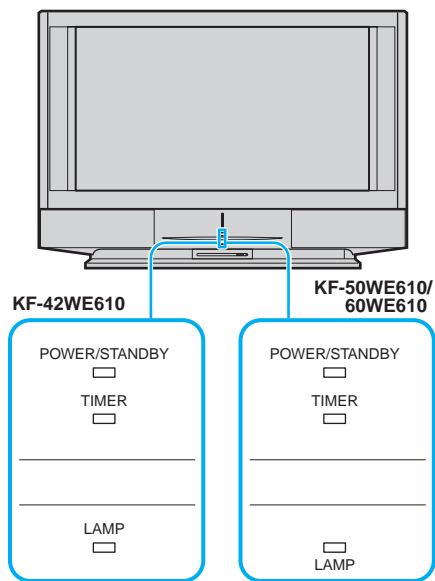

The POWER/STANDBY (red) and/or LAMP (red) indicators indicate the conditions of the LCD projection TV and warnings by lighting or flashing, as follows.

The POWER/STANDBY indicator flashes.

- ❑ The lamp for the light source is ready to turn on.

The POWER/STANDBY indicator flashes three times.

- ❑ The lamp cover is not attached securely. When you correct, the POWER/STANDBY indicator goes out and the LCD projection TV enters the standby mode (see page 16).

The LAMP indicator flashes.

- ❑ The lamp for the light source burns out. Replace it with new one (see page 13).

If the LCD projection TV is not recovered after correcting the problems, contact with qualified Sony personnel.

Specifications

Projection System	3 LCD Panels, 1 lens projection system	
LCD Panel	0.87 inch TFT LCD panel Approx. 3.28 million dots (1,092,168 pixels)	
Projection Lens	High Performance, large diameter hybrid lens F2.4	
Antenna	75 ohm external terminal for VHF/UHF	
Lamp	UHP lamp, 100W XL-2100U	
Television System	NTSC, American TV Standard	
Screen Size (measured diagonally)	KF-42WE610: 42 inches, KF-50WE610: 50 inches, KF-60WE610: 60 inches	
Channel Coverage		
VHF	2-13	
UHF	14-69	
CATV	1-125	
Power Requirements	120V, 60 Hz	
Number of Inputs/Outputs		
DVI-HDTV	1 terminal, 3.3 V T.M.D.S., 50 ohms The DVI-HDTV input terminal is compliant with the EIA-861 standard and is not intended for use with personal computers.	
Video (IN)	4	1 Vp-p, 75 ohms unbalanced, sync negative
S Video (IN)	4	Y: 1 Vp-p, 75 ohms unbalanced, sync negative C: 0.286 Vp-p (Burst signal), 75 ohms
Audio (IN)	6	500 mVrms (100% modulation) Impedance: 47 kilohms
AUDIO (VAR/FIX)	1	500 mVrms at the maximum volume setting (Variable) 500 mVrms (Fixed) Impedance (output): 2 kilohms
CONTROL S (IN/OUT)	1	minijacks
Component Video Input	2 (Y, P _B , P _R)	Y: 1.0 Vp-p, 75 ohms unbalanced, sync negative P _B : 0.7 Vp-p, 75 ohms P _R : 0.7 Vp-p, 75 ohms
RF Inputs	2	
Converter	1	
Speaker Output	5W (L), 5W (R), 20W (Woofer)	
Dimensions (W × H × D)	KF-42WE610: 1,201 × 819 × 371 mm (47 1/4 × 32 1/4 × 14 1/2 inches) KF-50WE610: 1,377 × 928 × 452 mm (54 1/4 × 36 1/2 × 17 3/4 inches) KF-60WE610: 1,619 × 1,067 × 541 mm (63 3/4 × 42 × 21 1/4 inches)	
Mass	KF-42WE610: 32 Kg (70 lb 12 oz) KF-50WE610: 39.5 kg (87 lb 1 oz), KF-60WE610: 49.5 kg (109 lb 2 oz)	
Power Consumption		
In Use	210 W	
In Standby	Under 1 W	

Other Information

Supplied Accessories

Remote Control	RM-Y913
AA Batteries	2 supplied for remote control
Cleaning Cloth	1

Optional Accessories

TV Stand	SU-GW1 (for KF-50/60WE610), SU-GW2 (for KF-42WE610)
Lamp	XL-2100U
AV Cable	VC-810S/820S/830S
Control S Cable	RK-G69
Component Video Cable	VMC-10/30
AV Receiver	STR series or equivalent
Memory Stick media	Memory Stick Media, Memory Stick Duo Media, Memory Stick Media with Memory Select Function, Memory Stick PRO Media*

* Memory Stick PRO media features vary by and are dependent upon the design of host hardware devices. Memory Stick PRO in this projection TV has been tested to support up to 1 GB media capacity and does not support high-speed transfer, MagicGate copyright protection technology, or access control security features.

Design and specifications are subject to change without notice.

Index

- A**
 - Activating a Twin View screen **50**
 - Adding channels to the channel list **76**
 - Adjusting audio, Steady Sound **72**
 - ANT button **45**
 - Antenna, connecting **25**
 - Audio menu **68, 72**
 - Audio receiver, connecting **36**
 - Audio/Video cable **24**
 - Auto Program (channel setup) **43, 76**
 - Auto Setup **43, 76**
- B**
 - Balance, adjusting **72**
 - Bass, adjusting **72**
 - Batteries, inserting in remote **17**
 - Bilingual audio **72**
 - BN Smoother **71**
 - Brightness, adjusting **70**
- C**
 - Cable
 - connecting **25–28**
 - setting ON/OFF **76**
 - with VCR, connecting **29**
 - Cable box
 - connecting with VCR **30**
 - using with TV remote control **89**
 - Camcorder, connecting **41**
 - Caption Vision **82**
 - CATV. See Cable.
 - Channel list, adding channels **76**
 - Channel menu **68, 76**
 - Channel Skip/Add **77**
 - Channels
 - Auto Program **76**
 - creating labels **77**
 - setting up **43**
 - Cleaning Cloth **12**
 - Closed caption modes **82**
 - CODE SET button **86**
 - Color temperature, adjusting **70**
 - Color, adjusting **70**
 - Connecting
 - Audio receiver **36**
 - Cable box **26–28, 30–31**
 - Cable or an Antenna **25**
 - Cable or Antenna **25**
 - Camcorder **41**
 - Digital TV Receiver **39**
 - DVD player **37, 38**
 - Satellite receiver **33–35**
 - VCR **30–32, 34**
 - Connector Types **24**
 - Contents of box **17**
 - CONTROL S **42**
- D**
 - Digital TV
 - connecting **39**
 - watching **48**
 - Digital TV program **48**
 - Digital TV receiver, connecting **39**
 - DISPLAY button **45**
 - Display, turning off **45**
 - DRC Mode **70**
 - DVD player
 - using with TV remote control **88**
 - with A/V connectors, connecting **38**
 - with component video connectors, connecting **37**
- E**
 - Enlarging pictures, in Twin View **52**
- F**
 - Favorite Channel
 - setting up **76**
 - using **49**
 - FAVORITES button **44**
 - Features **9**
 - FREEZE button **44**
 - Freeze, using **46, 53**
 - FUNCTION button **44**
- H**
 - High Altitude **85**
 - Hue, adjusting **70**
- I**
 - Image Setup Menu **62**

Image Shift **85**
Inputs, labeling **83**
Installation of the projection TV **25–42**

J

JUMP button **44**
Jump, using **46**

L

Label
 Channels **77**
 video inputs **83**
Lamp, replacing **13–16**

M

Memory Stick
 Advance **65**
 Audio Select **65**
 Close **61, 65**
 Delete **61, 63, 65**
 Digi. Cam. Mode **66**
 File **66**
 Full Screen **61**
 Home Menu **65**
 Index Menu **60**
 Information **63, 65**
 inserting **57**
 Interval **65**
 Memory Stick Home **58**
 Movie Player **61**
 Playing Movies **63**
 Protect **61, 63, 65**
 Return **63**
 Rotate **61, 63**
 Slide Show **61**
 Start **65**
 Still Images **62**
MEMORY STICK button **45**
MENU button **45**
Menus

 Audio **68, 72**
 Channel **68, 76**
 Parent **68, 78**
 Screen **68, 74**
 Setup **68, 82**
 Video **68, 69**

Mild Mode **70**

MODE

 Pro **47**
 Standard **47**
 Vivid **47**

MTS/SAP button **45**
MTS/SAP, using **47**
Muting, using **46**

N

NR **70**

P

Palette **71**
Password, changing **79**
Picture contrast, adjusting **70**
PICTURE MODE button **44**
Picture size, adjusting in Twin View **52**
Playing Movies **63**
POWER buttons (GREEN) **45**
POWER/STANDBY **98**
Presetting channels **43**
Problems, troubleshooting **92, 97**

R

Ratings
 setting **80**
 viewing blocked programs **79**
Remote control
 Function of buttons **46**
 inserting batteries **17**
 programming **86–87**
Remote control, operating other components with
 Cable box **89**
 DVD player **88**
 Satellite receiver **89**
 VCR **88**
Removing channels from the channel list **77**
RESET button **45**
Resetting
 Audio options **72**
 Video options **69**

S

S Video cable **24**
Satellite receiver
 connecting **33**
 using with TV remote control **89**
Screen menu **74**
Setting up channels **43**
Setup menu **68, 82**
Sharpness, adjusting **70**
Sleep **84**
Specifications **99–100**

(Continued)

Steady Sound
adjusting **72**
Still Images **62**
Surround sound **72**

T

Timer
set current **84**
Timer menu **84**
Timer setting **84**
Treble, adjusting **72**
Troubleshooting **92, 97**
TV/VIDEO button **45**
Twin View™
activating a picture **50**
using **50**

V

VCR
using with TV remote control **88**
with cable box, connecting **30**
with cable, connecting **29**
with satellite receiver, connecting **34**
Video inputs, labeling **83**
Video menu **68, 69**
Video Modes, selecting **69**
Viewing area, recommended **20**
VOL +/- button **44**

W

WIDE MODE button **44**

Z

Zoom feature, with Twin View **52**

Free Manuals Download Website

<http://myh66.com>

<http://usermanuals.us>

<http://www.somanuals.com>

<http://www.4manuals.cc>

<http://www.manual-lib.com>

<http://www.404manual.com>

<http://www.luxmanual.com>

<http://aubethermostatmanual.com>

Golf course search by state

<http://golfingnear.com>

Email search by domain

<http://emailbydomain.com>

Auto manuals search

<http://auto.somanuals.com>

TV manuals search

<http://tv.somanuals.com>