

Getting Started

GB

Operating Instructions

GB

Uvedení do provozu

CZ

Funkce

CZ

Przed rozpoczęciem

PL

Instrukcja obsługi

PL

A kész, lÈk
, zembhelyezÈse
Hasn·lati /tmutatÙ

H

H

ç+~+îÓ

BG

àìòú ùí^ÈÈ Á†
Âíòòíó†ú†^È†

BG

èó%„óúó, í† í
~íòòíó†ú†^ÈÈ

RF

àìòú ùí^È† òó
~íòòíó†ú†^ÈÈ

RF

KL-40WA1K

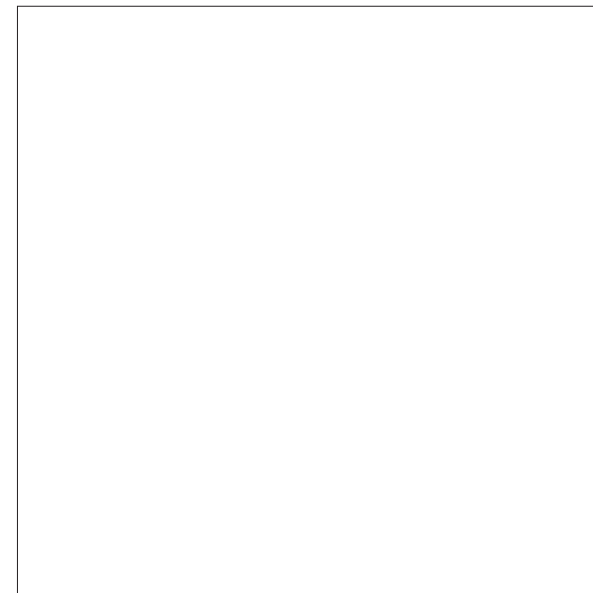

LCD Projection TV



WARNING

To prevent fire or shock hazard, do not expose the unit to rain or moisture.

Dangerously high voltages are present inside the set. Do not open the cabinet. Refer servicing to qualified personnel only.

Safety Information

All TVs operate on extremely high voltages. To prevent fire or electric shock, please follow the safety procedures below. For your protection, refer all servicing to qualified personnel only.

For general safety:

- Do not expose the TV to rain or moisture.
- Do not open the rear cover.

For safe operations:

- Do not operate the TV on any other voltages, but 220–240 V AC.
- Do not operate the TV if any liquid or solid object falls in it - have it checked immediately.
- Do not keep the set plugged in if you are not going to use it for several days.
- Do not pull on the power cord to disconnect the TV. Pull it out by the plug.
- Do not place anything on the surface of the front panel cover when you open it.

Important Information

Please read the following information on using and maintaining the TV, for optimum viewing quality.

Picture Quality

- Avoid touching the screen, and take care not to scratch the surface with hard objects.

Illumination

To obtain a clear picture, do not expose the screen to direct illumination or direct sunlight. If possible, use spot lighting directed down from the ceiling.

Installation

- To prevent over heating of the set, do not block the ventilation openings.
- Do not install the TV in a hot or humid place, or in a place subject to direct sunlight, excessive dust or mechanical vibration.
- After transporting the TV directly from a cold to a warm location, or if the room temperature has changed suddenly, pictures may be blurred or show poor colour over portions of the picture. This is because moisture has condensed on the mirrors or lenses inside the TV. Let the moisture evaporate before using the TV.

Maintenance

- Save the original shipping carton and packing material to use if you ever have to ship your TV. For maximum protection, repack your TV as it was originally packed at the factory.
- To keep the cabinet looking brand-new, periodically clean it with a soft cloth. Stubborn stains may be removed with a cloth slightly dampened with a mild detergent solution. Never use strong solvents such as thinner or benzene, or abrasive cleaners since these will damage the cabinet. As a safety precaution, unplug the TV before cleaning it.
- To remove dust from the front of the screen, unplug the TV and wipe gently with a soft cloth lightly dampened with water or a mild detergent solution, using vertical strokes only. Then wipe it with a dry, soft cloth. Never use solvents or thinners for cleaning purposes.
- If the picture turns dark after the TV has been in use for a long period of time, it may be necessary to clean the inside of the TV. Consult qualified service personnel for this.

Contents

Overview	4
Getting Started	6
Step 1 Preparation	6
Check the supplied accessories	6
Insert the batteries into the Remote Commander	6
Connect the aerial	6
Step 2 Tuning in to TV Stations	7
Choosing the Menu Language and the Country	7
Presetting Channels Automatically	8
Additional Presetting Functions	9
Presetting Channels Manually	9
Sorting Programme Positions	10
Using "Further Programme Preset"	11
Skipping Programme Positions	12
Captioning a Station Name	12
Using Parental Lock	13
Tuning in a Channel Temporarily	13
Operating Instructions	14
Watching the TV	14
Switching the TV on and off	14
Selecting TV Programmes	14
Adjusting the Volume	14
Operating the TV Using the Buttons on the TV	14
Watching Teletext or Video Input	15
More Convenient Functions	15
Adjusting and Setting the TV Using the Menu	16
Adjusting the Picture and Sound	16
Using the Sleep Timer	17
Operating Screen Mode	18
Auto 16:9	18
Teletext	19
Direct Access Functions	19
Using the Teletext Menu	21
User Page Bank System	22
Connecting and Operating Optional Equipment	23
Connecting Optional Equipment	23
Selecting Input and Output	24
Using AV Preset	25
Remote Control of Other Sony Equipment	26
For Your Information	27
Optimum Viewing Area	27
Cleaning the Air Filter	28
Replacing the Lamp	29
Troubleshooting	30
Specifications	30
Warning Indicators	31
Stabilizing the Projection TV	31

Getting Started

GB

Operating Instructions

GB

Overview

This section briefly describes the buttons and controls on the TV set and on the Remote Commander. For more information, refer to the pages given next to each description.

TV set-front

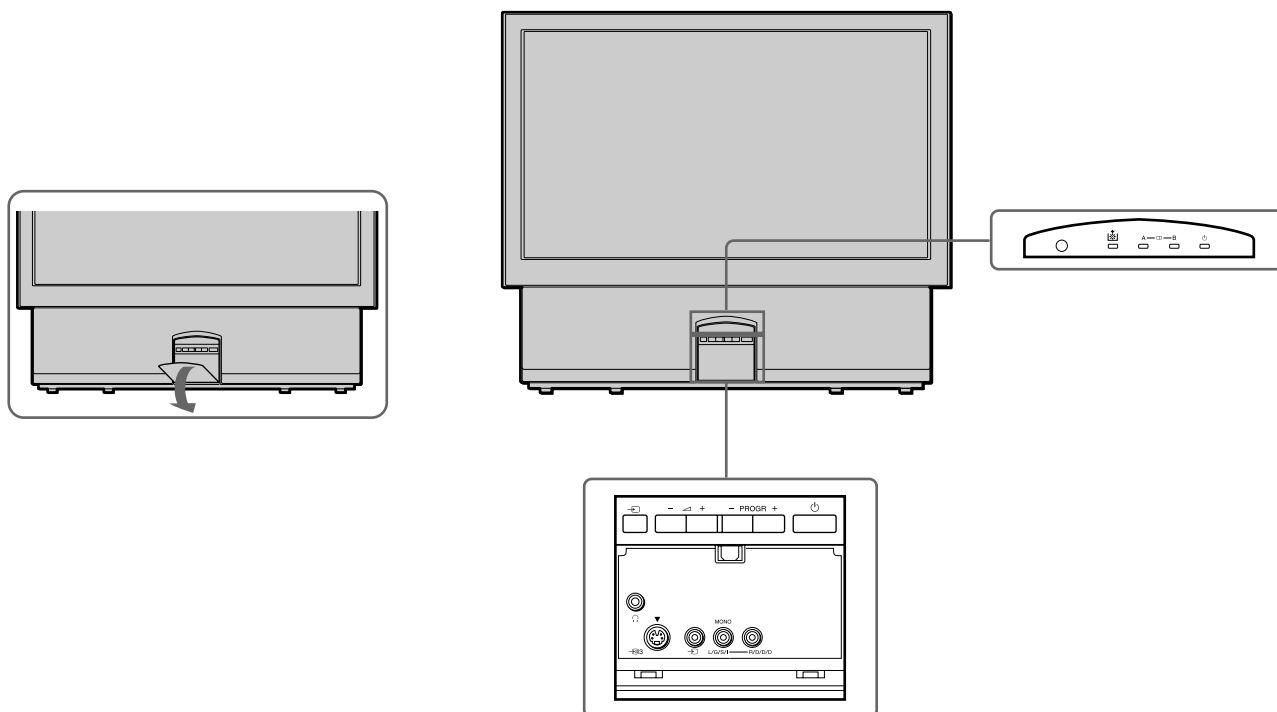

Symbol	Name	Refer to page
⏻	Main power switch	14
⏻	Standby indicator	14, 31
A - m - B	Stereo A/B indicators	17
⚡	Lamp indicator	29, 31
PROGR +/-	Programme	14
↔ +/-	Volume buttons	14
↺	Input select buttons	15
🎧	Headphones jack	23
📺 3, 📺 3, 🎧 3	Input jacks (S video/video/audio)	24

Remote commander

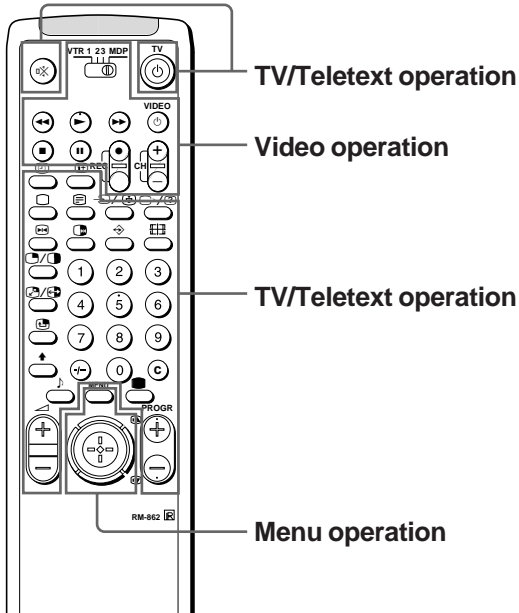

Menu operation

Symbol	Name	Refer to page
	Menu on/off button	See below.
	Joystick for Menu selection	See below.
	Press to confirm selection (OK function)	

Video operation

Symbol	Name	Refer to page
VTR1/2/3, MDP	Video equipment selector	26
; ; - :: L	Video equipment operation	26
J a VIDEO f	VIDEO buttons	
CH +/-	Channel +/- buttons	

No function on this set

Symbol :

TV/Teletext operation

Symbol	Name	Refer to page
	Mute on/off button	15
TV	TV Standby button	14
	TV power on/TV mode selector button	14
	Teletext button	15
	Input mode selector/	15
	Teletext: Freezing the subpage	20
	Output mode selector/	24
	Teletext: Reveal button	20
1,2,3,4,5,6, 7,8,9 and 0	Number buttons	14
	Double-digit entering button	14
C	Direct channel entering button	9
	Volume control button	14
PROGR +/-	Programme selectors	14
	Teletext: Page up/page down buttons	20
	Picture adjustment button	16
	Sound adjustment button	16
	On-screen display button	15
	Time display button	15
	"Freeze" button	15
	Button to change Screen Format	15
	Teletext: Favourite pages button	22

For the Menu System

Use the MENU button and the joystick as follows.

1 Press MENU button to switch menu on or off.



2 Use the joystick as follows:

GREEN: scroll up

RED: decrease/back to last item or to last menu
When menu is not displayed: Push to red to display the last menu screen

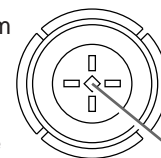

YELLOW: increase/forward to next item

BLUE: scroll down

Joystick: Press at its neutral position to confirm selection or store

The operable functions of the joystick are displayed on the screen.

Getting Started

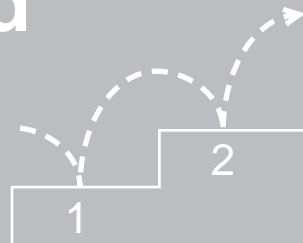

Step 1 Preparation

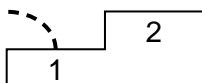

1 Check the supplied accessories

When you've taken everything out of the carton, check that you have these items:

- RM-862 Remote Commander
- Two IEC designation R6 batteries
- Wrench (1)
- Bracket (2)

2 Insert the batteries into the Remote Commander

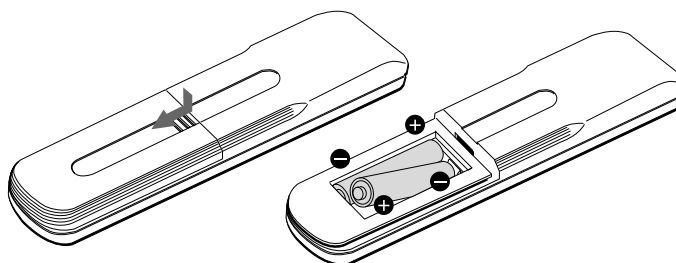

Remove the cover.

Check the correct polarities.

Note: Always remember to dispose of used batteries in an environmentally friendly way.

3 Connect the aerial

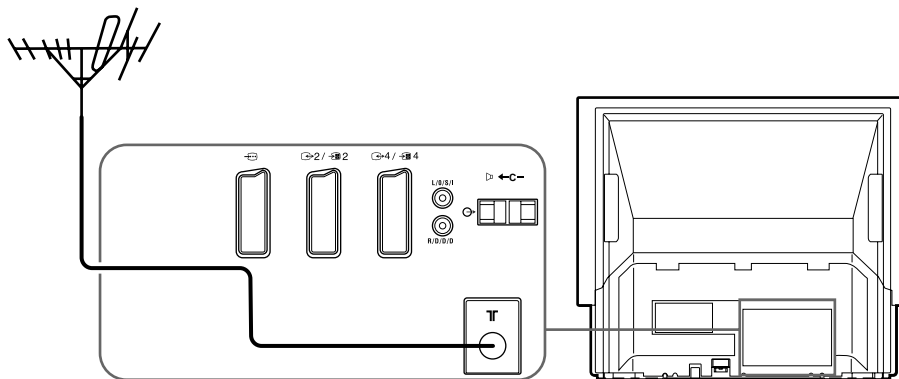

Fit an IEC aerial connector attached to 75-ohm coaxial cable (not supplied) to the) socket at the rear of the TV.

Step 2 Tuning in to TV Stations

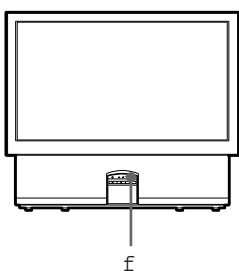
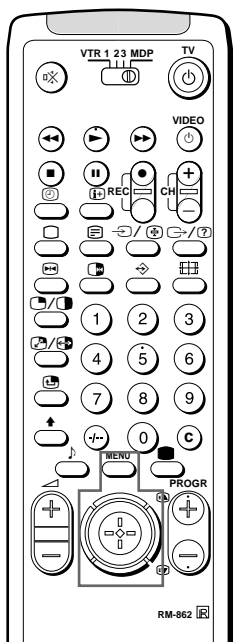
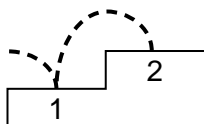

1 Choosing the Menu Language and the Country

Using this function, you can select the language of the menu screens. Also, you can select the country in which you will use the TV. In this way, the channels of the selected country will automatically get the top positions during automatic presetting.

- 1 Press the power switch on the TV. If the standby indicator on the TV is lit, press or a number button on the Remote Commander.
- 2 Press MENU on the Remote Commander. The LANGUAGE menu appears.
- 3 Push the joystick to blue or green to select the language. Press the joystick to confirm your selection. The COUNTRY menu appears.
- 4 Push the joystick to blue or green to select the country in which you wish to operate the TV. Press the joystick to confirm the selection.
- 5 Press MENU to restore the normal TV picture.

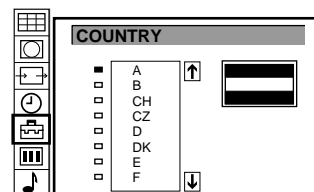
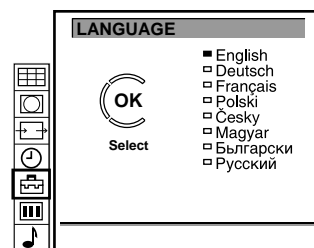

To go back to the normal TV picture
Press MENU. Normal TV picture will be restored after one minute if menu functions are not selected.

Note on the Demo function
If you choose Demo in the INSTALLATION menu, you can see a sequential demonstration of the menu functions. Press MENU to stop the function.

2 Presetting Channels Automatically

With this function, the TV automatically searches and stores up to 100 channels onto programme positions. If you prefer "Presetting Channels Manually", please refer to page 9 in Additional Presetting Functions.

- 1 Press MENU.
- 2 Push the joystick to blue or green to select the symbol  on the menu screen, then push to yellow.
- 3 Push the joystick to blue or green to select "Auto Programme", then push to yellow.
The AUTO PROGRAMME menu appears.
- 4a) All items shown on the menu screen are as wanted: Press the joystick to select START.
Now the automatic channel presetting starts from programme position 1.

or

- 4b) You wish to change items as shown on the menu screen: Push the joystick to blue or green. Push to yellow repeatedly until the desired item is highlighted.

Push the joystick to blue or green to select the following options:

ACI(AutomaticChannelInstallation,dependingon availabilityofserviceinyourcountry)

on: fast channel presetting by special networks using the channel frequency (e.g. F055)

TV-system and station label

off: ACI is not active, only ITP (Intelligent Tuner Preset)

SYS(TVBroadcastSystem)

I for U.K.

B/G for Western European Countries

D/K for Eastern European Countries

L for France

PROG(ProgrammePosition)

Presetting automatically starts from position 1.

CH(channel)

C to start presetting with terrestrial channels

S to start presetting with cable channels

Press the joystick as soon as the automatic presetting starts.

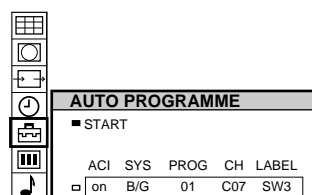
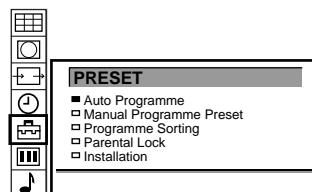

Notes

- After presetting the channels automatically, you can check which channels are stored on which programme positions. For details, see "Displaying the Programme Table" on page 15.
- You can sort the programme positions to have them appear on screen in the order you like. For details, see "Sorting Programme Positions" on page 10.

Additional Presetting Functions

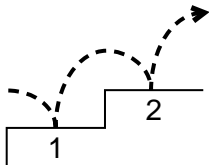

MANUAL PROGRAMME PRESET

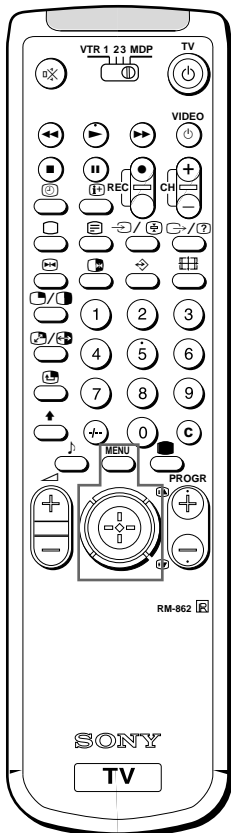

Presetting Channels Manually

Using this function, you can preset channels one by one to different programme positions. This is also convenient to allocate programme numbers to video input sources.

- 1 Press MENU.
- 2 Push the joystick to blue or green to select the symbol  on the menu screen. Push to yellow to confirm the selection.
- 3 Push to blue or green to select "Manual Programme Preset". Push to yellow to confirm the selection.
- 4 Push to blue or green to select the programme position (PROG) to which you want to preset a channel. Push to yellow to confirm.
- 5 Push to blue or green to select the TV broadcast system (SYS) (I for U.K., B/G for western European countries, D/K for eastern European countries, L for France) or a video input source (EXT). Push to yellow to confirm.
- 6 Push to blue or green to select "C" (for terrestrial channels), "S" (for cable channels) or "F" (for channel frequency). Push to yellow to confirm.

There are two options to preset channels manually:

- a) You know the channel number or channel frequency. Please use method "Direct Input".
- b) You don't know the channel number or frequency. Please use method "Search".

7a) Direct Input

For channel numbers, you need to input a two digit number, for the frequency, a three digit number.

- Push to blue or green to select the first digit of the channel number or frequency. Push to yellow to confirm.
- Push to blue or green to select the second digit of the number or frequency. Push to yellow to confirm. In case of the channel number, the search starts.
- Push to blue or green to select the third digit of the frequency number. Push to yellow to start the search of the frequency.
- To continue search for another channel: Push to blue or green.
- To store the selected channel: Press the joystick.
- Repeat steps 4 to 7 a) to preset other channels.

7b) Search

- Push repeatedly to yellow until a blue and a green arrow appear in the section SEARCH.
- Push to blue or green to search for the next available channel.
- To continue search for another channel: Push to blue or green.
- To store the selected channel: Press the joystick.
- Repeat steps 4 to 7 b) to preset other channels.

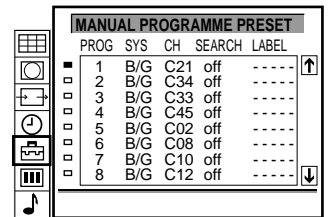
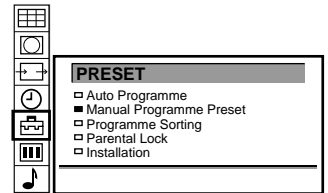

PROGRAMME SORTING

Sorting Programme Positions

This function enables you to sort the programme positions to a preferable order.

- 1 Press MENU.
- 2 Push the joystick to blue or green to select the symbol  on the menu screen. Push to yellow to confirm.
- 3 Push to blue or green to select "Programme Sorting". Push to yellow to confirm.
- 4 Push to blue or green to select the programme position of the channel you want to change. Press joystick to confirm.
- 5 Push to blue or green to select the new programme position. Press joystick to confirm. Now the selected channel is changed to the new programme position.
- 6 Repeat steps 4 and 5 to sort other programme positions.

To go back to the normal TV picture Press MENU.

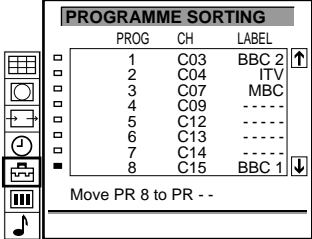

PROG	CH	LABEL
1	C03	BBC 2
2	C04	ITV
3	C07	MBC
4	C09	-----
5	C12	-----
6	C13	-----
7	C14	-----
8	C15	BBC 1

Move PR 8 to PR - -

8	C15	BBC1
---	-----	------

Using “Further Programme Preset”

Using the FURHTER PROGRAMME PRESET menu you can:

- a) individually adjust and store the volume level of each channel (Volume offset).
 - b) in case of picture distortions, use manual fine tuning to obtain a better picture quality. The factory setting is “on” for AFT (Automatic Fine Tuning).
- 1 Press MENU.
 - 2 Push the joystick to blue or green to select the symbol  on the menu screen. Push to yellow to confirm.
 - 3 Push to blue or green to select “Installation”. Push to yellow to confirm.
 - 4 Push to blue or green to select “Further Prog. Preset”. Push to yellow to confirm.
 - 5 Push to blue or green to select the programme position you want. Push to yellow repeatedly to select:
 - a) VOL (Volume Offset) or b) AFT (Automatic Fine Tuning).
 The selected item changes its colour.
 - a) **VOL**

Push to blue or green to adjust the volume for the selected programme position within a range of -7 to +7. Press the joystick to confirm. Repeat step 6 to set the volume level for other programme positions.
 - b) **AFT**

Push to blue or green to fine-tune the channel within a range of -15 to +15. Press the joystick to confirm. Repeat step 6 to fine-tune other channels.
 - 7 Press MENU to restore the normal TV picture.

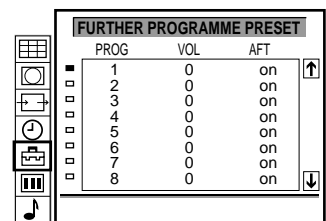
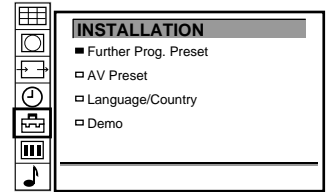

MANUAL PROGRAMME PRESET

Skipping Programme Positions

This function enables you to skip unused programme positions when selecting them with the PROGR +/- buttons. However, by using the number buttons you can still select the skipped programme position.

- 1 Press MENU.
- 2 Push the joystick to blue or green to select the symbol  on the menu screen. Push to yellow to confirm.
- 3 Push to blue or green to select "Manual Programme Preset". Push to yellow to confirm.
- 4 Push to blue or green to select the programme position you want to skip. Push to yellow to confirm.
- 5 Push to blue or green to select "- - -" in the position SYS (system). Press the joystick to confirm.
- 6 Repeat steps 4 and 5 to skip other programme positions.
- 7 Press MENU to restore the normal TV picture.

To go back to the normal TV picture Press MENU.

MANUAL PROGRAMME PRESET				
PROG	SYS	CH	SEARCH	LABEL
1	B/G	C21	off	-----
2	B/G	C24	off	-----
3	B/G	C25	off	-----
4	B/G	C27	off	-----
5	B/G	C28	off	-----
6	B/G	C22	off	-----
7	B/G	C26	off	-----
8	B/G	C25	off	-----

3 ---

3 ---
4 B/G

MANUAL PROGRAMME PRESET

Captioning a Station Name

Channels are automatically labelled during presetting. You can, however, individually name a channel or a video source using up to five characters.

- 1 Press MENU.
- 2 Push the joystick to blue or green to select the symbol  on the menu screen. Push to yellow to confirm.
- 3 Push to blue or green to select "Manual Programme Preset". Push to yellow to confirm.
- 4 Push to blue or green to select the programme position with the channel you want to label. Push to yellow repeatedly until the first element of the position LABEL is highlighted.
- 5 Push to blue or green to select a letter or a number (select "-" for a blank). Push to yellow to confirm. Select the other four characters in the same way.
- 6 After selecting all characters, press the joystick to confirm.
- 7 Repeat steps 4 to 6 to label other channels or video sources.
- 8 Press MENU to restore the normal TV picture.

MANUAL PROGRAMME PRESET				
PROG	SYS	CH	SEARCH	LABEL
1	B/G	C21	off	-----
2	B/G	C24	off	-----
3	B/G	C25	off	-----
4	B/G	C27	off	-----
5	B/G	C28	off	-----
6	B/G	C22	off	-----
7	B/G	C26	off	-----
8	B/G	C25	off	-----

2 B/G C 25 off S|---

2 B/G C 25 off SONY

PARENTAL LOCK

If you try to select a programme that has been blocked



The message "LOCKED" appears on the blank TV screen.

To unblock





Select the channel to unblock in the "PARENTAL LOCK" menu. Press the joystick. The symbol  disappears.

Using Parental Lock

This function enables you to prevent children from watching undesirable broadcasts.

- 1 Press MENU.
- 2 Push the joystick to blue or green to select the symbol  on the menu screen. Push to yellow to confirm.
- 3 Push to green or blue to select "Parental Lock". Push to yellow to confirm.
- 4 Push to green or blue to select the channel you want to block. Press the joystick to confirm. The symbol  appears before the programme position to indicate that this channel is now blocked.
- 5 Repeat step 4 to block other channels.
- 6 Press MENU to restore the normal TV picture.

PARENTAL LOCK		
PROG	CH	LABEL
	1	AV1 VHS
	2	C25 BBC 2
	3	C42 BBC 1
	4	C26 C 4
	5	C34 ITV
	6	C35 ----
	7	C36 ----
	8	C37 ----

PROG	CH	LABEL
	1	AV1 VHS
	2	C25 BBC 2
	3	C42 BBC 1
	4	C26 C 4

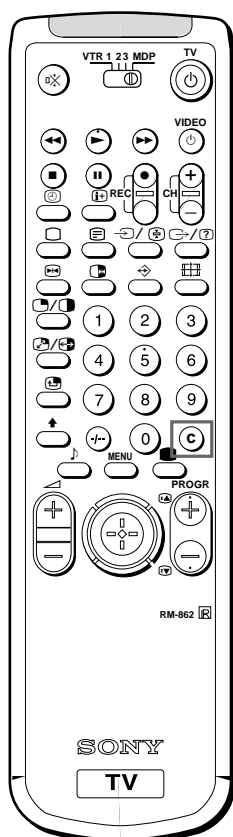

Tuning in a Channel Temporarily

You can tune in to a channel temporarily, even though it has not been preset.

- 1 Press C on the Remote Commander. For cable channels, press C twice. The indication "C" ("S" for cable channels) appears on the screen.
- 2 Enter the double-digit channel number using the number buttons (e.g. for channel 4, first press 0, then 4). The channel appears. Note that the channel will not be stored.



Operating Instructions

Watching the TV

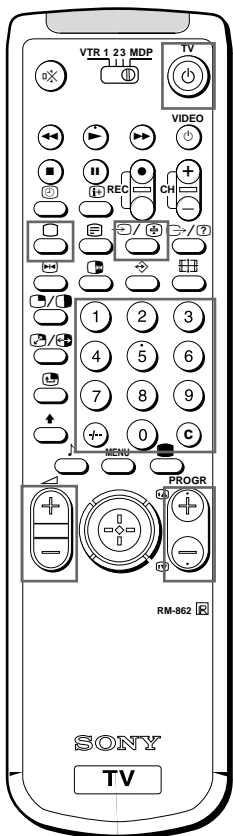

If no picture appears when you depress  on the TV and if the standby indicator on the TV is lit, the TV is in standby mode.

Press  or one of the number buttons to switch it on.

This section explains the basic functions you use while watching the TV. Most operations are done using the Remote Commander.

Switching the TV on and off

Switching on

Depress  on the TV.

Switching off temporarily

Press  on the Remote Commander.

The TV enters standby mode and the standby indicator on the front of the TV lights up in red.

To switch on again

Press , PROGR +/-, or one of the number buttons on the Remote Commander.

Switching off completely

Depress  on the TV and the indicator on the front of the TV lights up in amber.

To save energy, we recommend you switch off your TV completely when the TV is not in use.

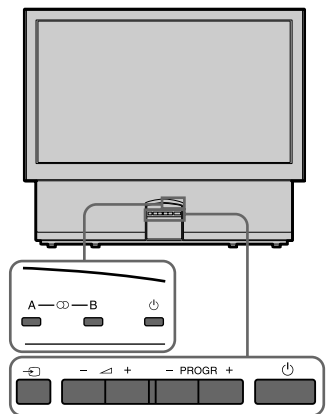

Selecting TV Programmes

Press PROGR +/- or press the number buttons.

To select a double-digit number

Press , then the numbers.

For example, if you want to choose 23, press , 2 and 3.

Adjusting the Volume

Press .

Operating the TV Using the Buttons on the TV

To select the programme number, press the PROGR +/- buttons.

To adjust the volume, press the .

To select the video input picture, press the .

To reset picture and sound controls to the factory preset level (Reset function), press PROGR +/- buttons simultaneously.

Watching Teletext or Video Input

Watching teletext

- 1 Press **TV** to view the teletext.
- 2 For teletext operation, enter a 3-digit page number with the number buttons to select a page.
For fastext operation, push the joystick to the colour mark which corresponds to the colour-coded menu.
For both operations, press **√** (PAGE +) for the next page or **◇** (PAGE -) for the preceding page.
- 3 To go back to the normal TV picture, press **○**.

Watching a video input picture

- 1 Press **VIDEO** repeatedly until the desired video input appears.
- 2 To go back to the normal TV picture, press **○**.

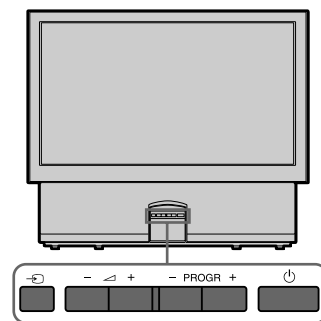

For details of the teletext operation, refer to page 19.

For details of the video input picture, refer to page 24.

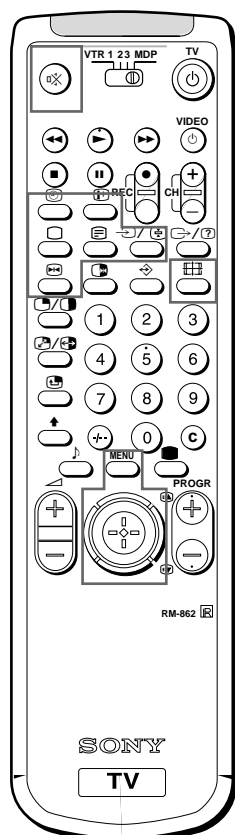

More Convenient Functions

Displaying the on screen indications

Press **INFO** to display the indications.
Press again to make the indications disappear.

Muting the sound

Press **○**.
To resume normal sound, press **○** again.

Displaying the time

Press **#**. This function is available only when teletext is broadcast.
To make the time display disappear, press **#** again.

Displaying the Programme Table

Push the joystick to blue or green to select a programme, then press the joystick to confirm. A Programme Table will be displayed on the left side of the TV screen.
To make the Programme Table disappear, press MENU.

1	BBC	↑
2	SAT	
3	TV5	
4	C02	
5	C15	
6	RTL	
7	SKY	
8	S34	
9	AV1	
10	MTV	↓

Freezing the picture

When watching the TV you can "freeze" the picture. Press **⏸**.
Press the button again to return to the normal TV picture.

Changing the screen format

Press **⏏** repeatedly to change the Screen mode as follows:

4:3 (4:3 picture)

A 14 : 9 (for 14 : 9 laser discs)

A Zoom (16:9 for movies broadcast in the cinemascopic format)

A Wide (for 16:9 broadcasts)

A Auto Wide (automatic selection of the optimum screen ratio)

A Smart (imitation of 16:9 for 4:3 broadcasts)

See also page 18 for more information.

Adjusting and Setting the TV Using the Menu

PICTURE CONTROL

SOUND CONTROL

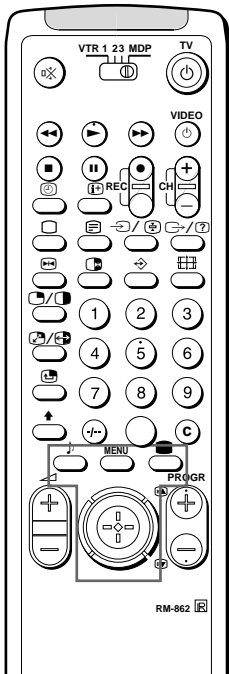

Adjusting the Picture and Sound

Although the picture and sound are adjusted at the factory, you can adjust them to suit your own taste. You can also select dual sound (bilingual) programmes when available or adjust the sound for listening with the headphones.

- Press (or picture) or \geq (for sound) on the Remote Commander.
or
Press MENU and select the symbol for Picture Control or \geq for Sound Control. Push to yellow to confirm.
The PICTURE CONTROL or SOUND CONTROL menu appears.
- Push the joystick to blue or green to select the desired item. Push to yellow to confirm.
The selected item changes its colour.
- Push to red or yellow to adjust the selected item. Press the joystick to confirm.
For the effect of each control, see the table below.
- Repeat steps 2 and 3 to adjust other items.
- Press MENU to restore the normal TV picture.

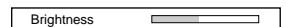
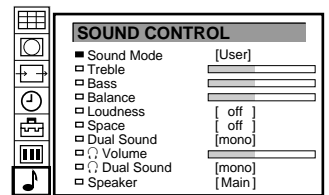
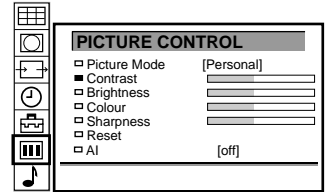

Effect of each control

PICTURE CONTROL	Effect
Picture Mode	Personal ↔ Game ↔ Movie ↔ Sports ↔ Live
Contrast	Less More
Brightness	Darker Brighter
Colour	Less More
Hue	Greenish Reddish
Sharpness	Softer Sharper
Reset	Resets picture to the factory preset levels.
AI	Off: normal On: automatic optimization of contrast level according to TV signal

Notes





- HUE is available for NTSC colour systems only.
- Brightness, Colour and Sharpness are available, only if "Personal" is selected in "Picture Mode".
- Treble, Bass and Loudness are available, only if "User" is selected in "Sound Mode".

Note on LINE OUT

The dual sound mode output from the > jack on the rear correspond to the Headphones Dual Sound settings.

When watching a video input source with stereo sound

You can select Dual Sound to change the sound.

SOUND CONTROL	Effect
Sound Mode	Choice between different sound effects User ↔ Pop ↔ Jazz ↔ Rock 
Treble	Less  More
Bass	Less  More
Balance	More left  More right
Loudness	Off: normal On: for music broadcasts
Space	Off: normal On: special acoustic effect
Dual Sound	A: left channel B: right channel Stereo → Mono The selected mode of the A- ^m -B indicator on the TV lights up.
Headphones:	Less  More
🔊 Volume	A: channel 1 → B: channel 2
🔊 Dual Sound	Stereo → Mono
Speaker	Main: sound from TV set Centre in: sound from external amplifier

TIMER



To switch off the timer
Select "off" in step 3.

To check the remaining time
Press .

To go back to the normal TV picture
Press MENU.

Using the Sleep Timer

You can select a time period after which the TV automatically switches into standby mode.

- 1 Press MENU.
- 2 Push the joystick to blue or green to select the symbol  on the menu screen. Push to yellow to confirm.
- 3 Push to yellow. Push to blue or green to select the time.
The time period (in minutes) changes as follows:
off ↔ 10 ↔ 20 ↔ 30 ↔ 40 ↔ 50 ↔ 60 ↔ 70 ↔ 80 ↔ 90

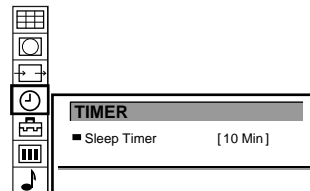
- 4 After selecting the time period, press the joystick to confirm.
One minute before the TV switches into standby mode, a message is displayed on the screen.

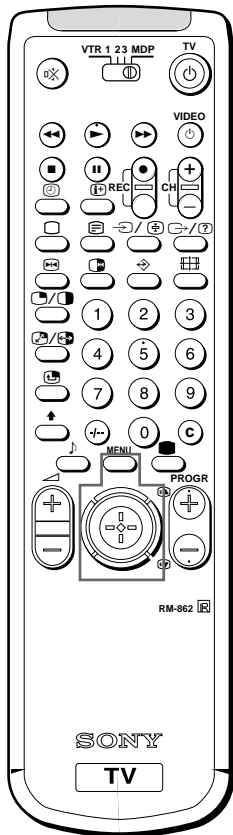



When you want to select the screen mode

You can also select the screen mode by pressing the  button on the Remote Commander.

To restore the normal TV picture

Press MENU.

Operating Screen Mode

Using the Screen Mode menu, you can change the aspect ratio for the TV display for wide screen effects.

- 1 Press MENU to display the main menu.
- 2 Push the joystick to blue or green to select the symbol  on the menu screen. Push to yellow to confirm. The SCREEN MODE menu appears.
- 3 Push to blue or green to select "Screen Mode". Push to yellow to confirm. The Screen Mode menu appears.

You have the following options:

- 4:3 for normal ratio 4:3 **(a)**
- Smart: imitation of wide screen effect (16:9) for 4:3 broadcasts **(b)**
- Zoom imitation of wide screen effect (16:9) for movies broadcast in cinemascopic format **(c)**
- Wide: for 16:9 broadcasts **(d)**
- 14:9 for 14:9 laser discs **(e)**

Auto Wide: automatic selection of the optimum screen ratio (e. g. 4:3 picture automatically changes to Smart mode, 16:9 picture changes to Zoom mode).

Press the joystick to confirm the selection.

Changing the screen position (for Zoom/Auto Wide modes)

When using the Zoom mode and 14:9 mode, part of the picture at the top and bottom will be cut off. With the help of the function "Screen position", you can move the screen up or down in order to see the cut-off part of the screen (e.g., to read the subtitles). Push the joystick to blue or green to select "Screen Position". Push to yellow to confirm.

Push to blue or green to adjust the screen Position (Zoom: -7 to +7, 14:9: -4 to +4, Auto Wide: -5 to +5). Press the joystick to confirm.

Auto 16:9

Set Auto 16:9 to "on" for automatic selection of format or PAL plus for PAL plus broadcasts, or "off" for normal mode.

- 1 Press MENU.
- 2 Push the joystick to blue or green to select the symbol  on the menu screen. Push to yellow to confirm. The SCREEN MODE menu appears.
- 3 Push joystick to blue or green to select "Screen Mode". Push to yellow to confirm.
- 4 Push joystick to blue or green to select "Auto 16:9". Push to yellow to confirm.
- 5 Push joystick to blue or green to select "on" or "off". Press the joystick to confirm.

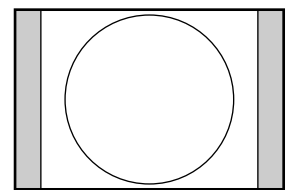
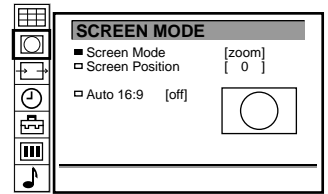

(a)

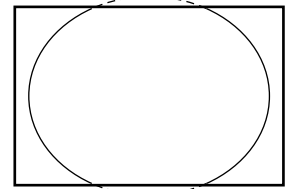

(b)

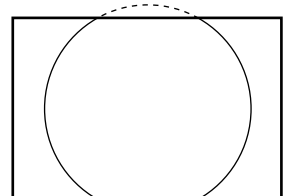

(c)

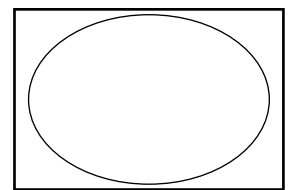

(d)

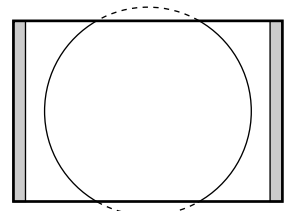

(e)

Teletext

GB

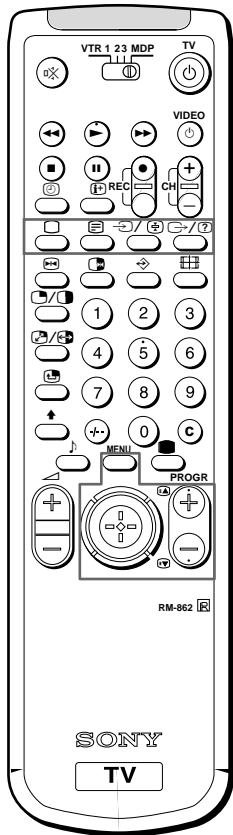

Note
Teletext errors may occur if the broadcasting signals are weak.

TV stations broadcast an information service called Teletext via the TV channels. Teletext service allows you to receive various information pages such as weather reports or news at any time you want.

Direct Access Functions

Switching Teletext on and off

- 1 Select the TV channel which carries the teletext broadcast you want to watch.
- 2 Press **0** to switch on teletext.
A teletext page will be displayed (usually the index page).
If there is no teletext broadcast, "No text available" is displayed on the information line at the top of the screen.

To switch teletext off

Press **0**.

Selecting a teletext page

With direct page selection

Use the number buttons to input the three digits of the chosen page number.
If you have made a mistake, type in any three digits. Then re-enter the correct page number.

With page-catching

- 1 Select a teletext page with a page overview (e.g. index page).
- 2 Press the joystick.
"Page Catching" is displayed at the top of the page.
- 3 Push joystick to blue or green to select the page you want. Press the joystick to confirm.
The requested page will appear in a few seconds.
Press **0** to resume normal teletext reception.

Accessing next or preceding page

Press \blacktriangledown (PAGE+) or \blacktriangleleft (PAGE-).
The next or preceding page appears.

Superimposing the teletext display on the TV programme

- Press ⏏ once to get Teletext only.
- Press ⏏ twice for Mix mode.
The normal TV screen and the Teletext screen are overlapped.

Preventing a teletext page from being updated

- Press ⏏ .
- The symbol “ ⏏ ” is displayed on the information line.
- Press ⏏ resume normal teletext reception.

Revealing hidden information (e.g. for a quiz)

Sometimes pages contain concealed information, such as answers to a quiz. The reveal option lets you disclose the information.

Press ⏏ . Press again to cancel.

Press ⏏ resume normal teletext reception.

Using Fastext

With Fastext you can access pages with one key stroke.

When a Fastext page is broadcast, a colour-coded menu will appear at the bottom of the screen. The colours of this menu correspond to the red, green, yellow and blue positions on the Remote Commander.

Push the joystick to the colour mark which corresponds to the colour-coded menu. The page will be displayed after a few seconds.

Note

Fastext operation is possible, only when the TV station broadcasts Fastext signals.

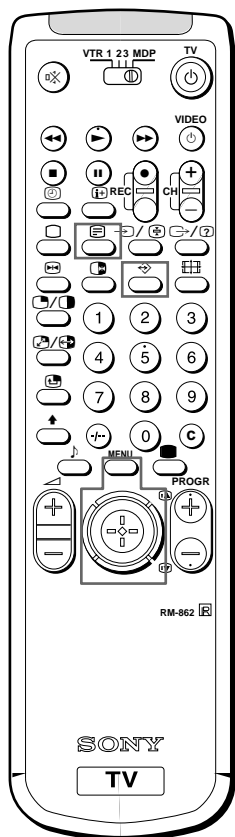

Note
Some of the features may not be available depending on the teletext service.

Using the Teletext Menu

This TV is provided with a menu-guided teletext system. When teletext is switched on, you can use the menu buttons to operate the teletext menu. Select the teletext menu functions in the following way:

- 1 Press MENU.
The menu will be superimposed on the teletext display.
- 2 Push the joystick to blue or green to select the teletext function you want. Push to yellow to confirm the selection.

USER PAGES/PRESET USER PAGES

See page 22 for information about presetting and operating the user pages.

INDEX

The index will give you an overview of the contents of the teletext and the page numbers.

TOP/BOTTOM/FULL

For convenient reading of a teletext page, you can enlarge the teletext display with the ability to scroll up and down. After having selected the function, an information line Top/Bottom/Full will be displayed.

Push the joystick to green to enlarge the upper half, push to blue to enlarge the lower half. Press the joystick to resume the normal display.

Press resume normal teletext reception.

TEXT CLEAR

After selecting the function, you can watch a TV programme while waiting for a teletext page to be captured. (The symbol changes its colour.)

Press resume normal teletext reception.

SUBTITLES

Your teletext service will inform you if a TV programme is subtitled. After having selected the function, the subtitles will be displayed.

TIME PAGE

Your teletext service will inform you, if a time coded page is available. You can have a page (e.g., an alarm page) displayed at a certain time.

- 1 Select the Time Page in the teletext menu.
Push the joystick to yellow.
An information window is displayed. Push to blue or green to select "on". Push to yellow.
- 2 Use the number buttons to enter the three digits of the page you want (e.g. 301). Push to yellow after each digit.
- 3 Use the number buttons to enter the four digits of the desired time (e.g. 18-54). Push to yellow after each digit. Press joystick to confirm.
- 4 Press MENU.
The time is displayed in the top left-hand corner of the screen.
At the requested time the page is displayed.
Press resume normal teletext mode.

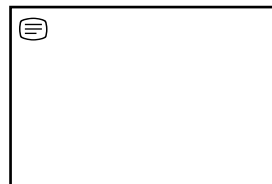
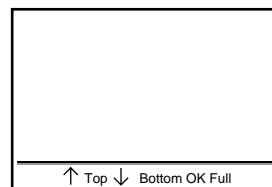
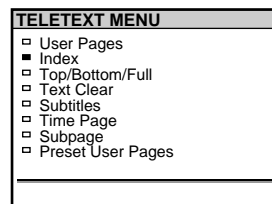
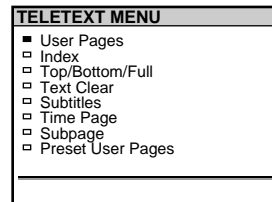

To cancel the request
Push the joystick to red and then to yellow.

If two broadcasting stations use the same Teletext
You can preset one bank to 2 different programme positions.

SUBPAGE

You may want to select a particular teletext page from several subpages which are rotated automatically. After having selected the function, an information line will be displayed.

To select the desired subpage, enter four digits using PROGR +/- or the number buttons (e.g., enter 0002 for the second page of a sequence).

User Page Bank System

You can store up to 30 pages in the "Teletext page bank system". In this way you have quick access to the pages you watch frequently.

Storing pages

There are 5 "banks" (A to E) for 5 teletext stations. In each bank you can store 6 preferred pages (P1 to P6).

- 1 Press  (if Teletext is not on already) and MENU so that the TELETEXT MENU display appears.
- 2 Push the joystick to blue or green to select "Preset User Pages". Push to yellow to confirm.
- 3 Push to blue or green to select the bank (from A to E) you want. Push to yellow to confirm.
The cursor will go to the first position (P1) of the preferred pages.
- 4 Push to blue or green to select the three digits of your first favourite page. Push to yellow after each digit. Push to yellow to confirm.
The cursor will go to the second position.
- 5 Repeat step 4 for the other 5 favourite pages. If you do not want to preset all 6 page numbers, push to yellow without inserting any number. After finishing the presetting, press the joystick.
- 6 Push to blue or green to select "Allocate Bank". Push to yellow to confirm.
- 7 Push to blue or green to select the programme position of the channel which carries the teletext service for which you have selected your favourite pages. Push to yellow to confirm.
- 8 Push to blue or green to select the bank from step 3. Press the joystick to confirm.
- 9 Repeat steps 3 to 8 for other 4 banks available.

Displaying User Pages

- 1 Press MENU.
 - 2 Push the joystick to blue or green to select "Preset User Pages". Push to yellow to confirm.
A table of the stored preferred pages will be displayed.
 - 3 Push to blue or green to select the page you want. Press the joystick.
The page is displayed after some seconds.
- or**
- 1 Press .
 - 2 Push joystick to blue or green to select the page you want. Press the joystick.

PRESET USER PAGES						
BANK	P1	P2	P3	P4	P5	P6
■ A	300	255	456	234	200	179
□ B	200	120	301	303	550	345
□ C	100	220	300	444		
□ D	128	321	255			
□ E	400	238	240	118	127	
□ Allocate Bank						
	PROG	LABEL	BANK	PROG	LABEL	BANK
00	VHS	-	04	MTV	D	
01	BBC1	A	05	SKY	B	
02	BBC2	C	06	ITV	C	

USER PAGES - BANK B	
■	PAGE 300
□	PAGE 200
□	PAGE 203
□	PAGE 500
□	PAGE 234
□	PAGE 159

Connecting and Operating Optional Equipment

Connecting Optional Equipment

You can connect optional audio-video equipment to this TV such as a VCR, video disc player, and stereo system.

GB

To connect a VCR using the) terminal
Connect the aerial output of the VCR to the aerial terminal) of the TV. We recommend that you tune in the video signal to programme number "0". For details, see "Presetting Channels Manually" on page 9.

If the picture or the sound is distorted
Move the VCR away from the TV.

S/video Input (Y/C input)
Video signals can be separated into Y (luminance or brightness) and C (chrominance) signals. Separating the Y and C signals prevents them from interfering with one another, therefore it improves picture quality (especially luminance). This TV is equipped with 3 S Video input jacks, through which these separated signals can be input directly.

When connecting a monaural VCR
Connect only the white ≤ jack to both the TV and VCR.

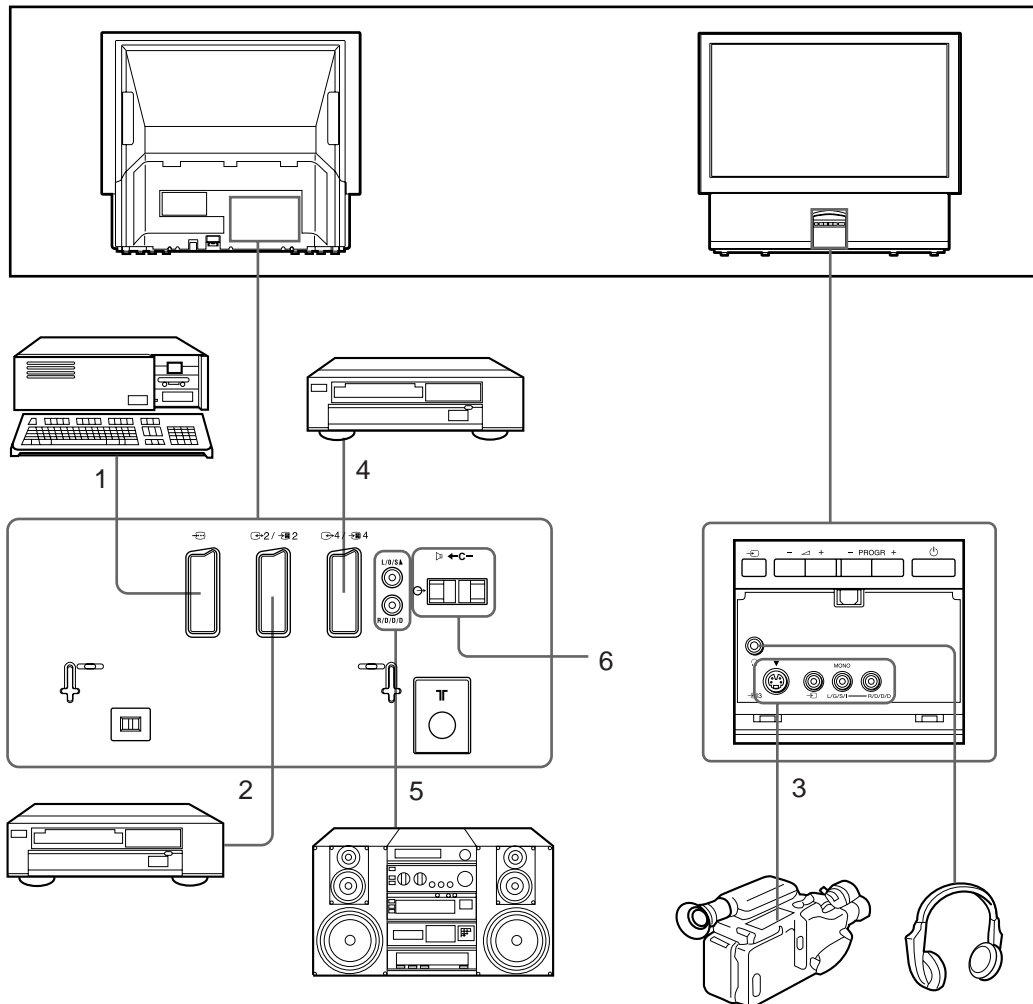

Acceptable input signal

- | Acceptable input signal | Available output signal |
|---|--|
| 1 Normal audio/video and RGB signal | Video/audio from TV tuner |
| 2 Normal audio/video and S video signal | Video/audio from selected source |
| 3 Normal audio/video and S video signal | No outputs |
| 4 Normal audio/video and S video signal | Video/audio displayed on TV screen (monitor out) |
| 5 No inputs | Audio signal |
| 6 Centre speaker input
Set "Speaker" on the SOUND CONTROL menu to "Main" or "Centre in". | No outputs |

Available output signal

Selecting input with PROGR +/- or number buttons

You can preset video input sources to the programme positions so that you can select them with PROGR +/- or number buttons. For details, see "Presetting Channels Manually" on page 9.

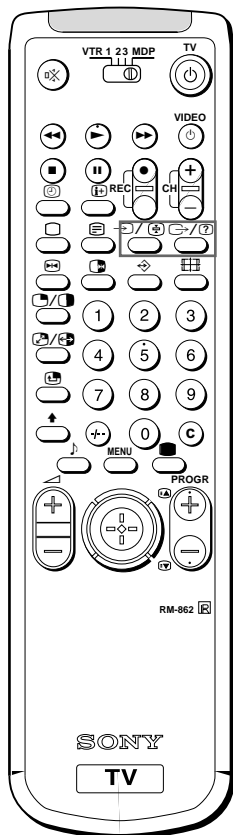

Selecting Input and Output

This section explains how to view the video input picture (of the video source connected to your TV), and how to select the output signal using direct access buttons or the menu system.























Selecting input

Press  repeatedly to select the input source. The symbol of the selected input source will appear.

To go back to the normal TV picture



Press 0.

Input modes

Symbol	Input signal
 1	Audio/video input through the  1 connector
 1	Audio/RGB input through the  1 connector
 2	Audio/video input through the  2 /  2 connector
 2	Audio/S video input through the  2 /  2
 3	Audio/video input through  3 and  3 connector on the front
 3	S video input through the  3 connector (4-pin connector) on the front
 4	Audio/video input through the  4 /  4 connector
 4	S video input through the  4 /  4

You can also select the input mode using the  button on the TV.

Selecting the output







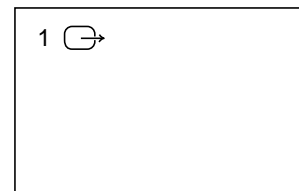







The  2 /  2 connector outputs the source input from the other connectors.

Press  repeatedly to select the output.

The symbol of the selected output source appears.



Output modes

Symbol	 2 /  2 connector outputs
1 	Audio/video signal from the  1 connector
2 	Audio/video signal from the  2 /  2 connector
3 	Audio/video signal from the  3,  3 connectors
4 	Audio/video signal from the  4 /  4 connector
TV 	Audio/video signal from the) aerial terminal

Using AV Preset

Using this function you can preset the desired input source (e.g. 1, RGB signal) to the respective AV input (AV 1). In this way, a connected VCR will automatically switch to the RGB signal.

- 1 Press MENU.
- 2 Push the joystick to blue or green to select the symbol on the menu screen. Push to yellow to confirm.
- 3 Push to blue or green to select "Installation". Push to yellow. Push to blue or green to select "AV Preset". Push to yellow to confirm. The AV PRESET menu appears.
- 4 Push to blue or green to select the desired AV input. Push to yellow to confirm.
- 5 Push to blue or green to select the desired source. Push to yellow to confirm. For the respective AV inputs you have the following choice:

AV1: RGB or AV	AV3: YC3 or AV
AV2: YC2 or AV	AV4: YC4 or AV
- 6 To label a source: Push to blue or green to select the first character (letter or number, "-" for a blank). Push to yellow to confirm. Select the other four characters in the same way.
- 7 For automatic format and PAL plus selection (Auto 16:9): Push to blue or green to select "on" for the AV input.
- 8 Press the joystick to store.
- 9 Repeat steps 4 to 8 for other AV inputs.

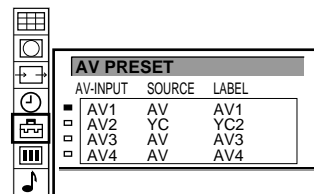

Checking and selecting the input and output sources using the menu

You can display the menu to see which input sources are selected for the TV screen, as well as which output source is selected. You can also select them on the menu display.

- 1 Press MENU.
- 2 Push the joystick to blue or green to select the symbol on the menu screen. Push to yellow to confirm. The VIDEO CONNECTION menu appears. You can see which source is selected for the TV and for the output. If you want to select the input and output on this menu, go on to the next step.
- 3 Push to blue or green to select "TV screen" (input source for TV-screen), or "Output" (output source for 2). Push to yellow to confirm.
- 4 Push to blue or green to select the desired source. Press joystick to store. For details about each source, see the table on page 24.
- 5 Repeat steps 3 to 4 to select the source for other inputs or outputs.
- 6 Press MENU to restore the normal TV picture.

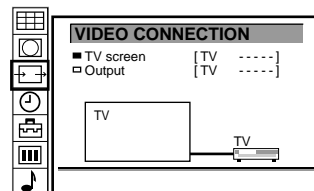

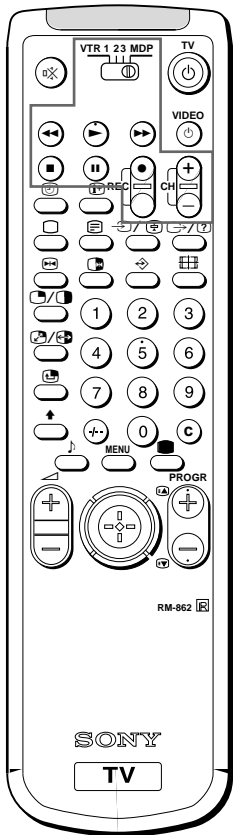

Remote Control of Other Sony Equipment

You can use the TV Remote Commander to control most of Sony remote-controlled video equipment: beta, 8 mm and VHS VCRs and video disc players.

Tuning the Remote Commander to the equipment

- 1 Set the VTR 1/2/3 MDP selector according to the equipment you want to control:
 - VTR1: Beta VCR
 - VTR2: 8 mm VCR
 - VTR3: VHS VCR
 - MDP: Video disc player
- 2 Use the buttons indicated in the illustration to operate the additional equipment.

If your video equipment is furnished with a COMMAND MODE selector, set this selector to the same position as the VTR 1/2/3 MDP selector on the TV Remote Commander.

If the equipment does not have a certain function, the corresponding button on the Remote Commander will not operate.

When recording

When you use the a (record) button, make sure to press this button and the one to the right of it simultaneously.

For Your Information

Optimum Viewing Area

For the best picture quality, try to position the projection TV so that you can view the screen from within the areas shown below.

GB

Horizontal viewing area

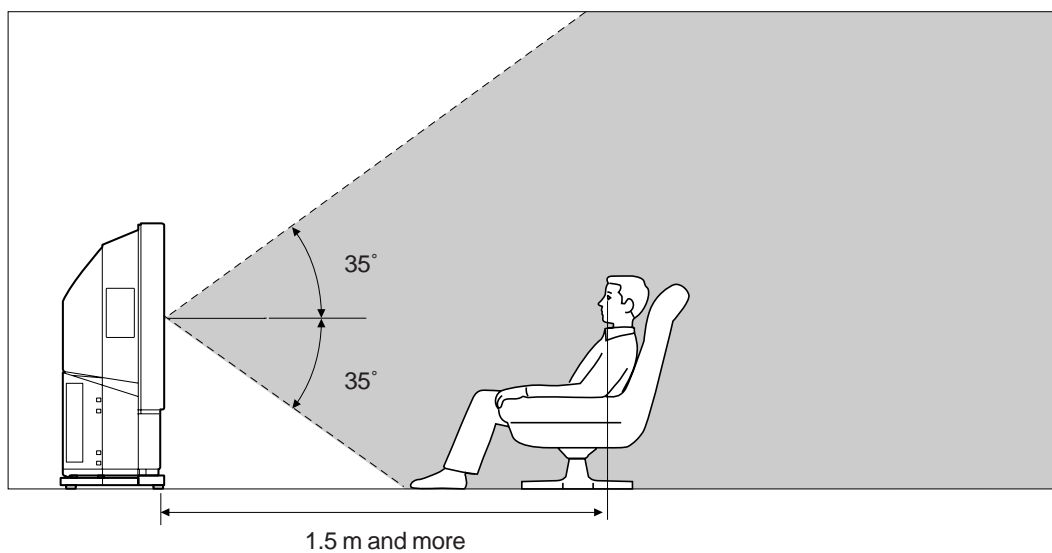

Vertical viewing area

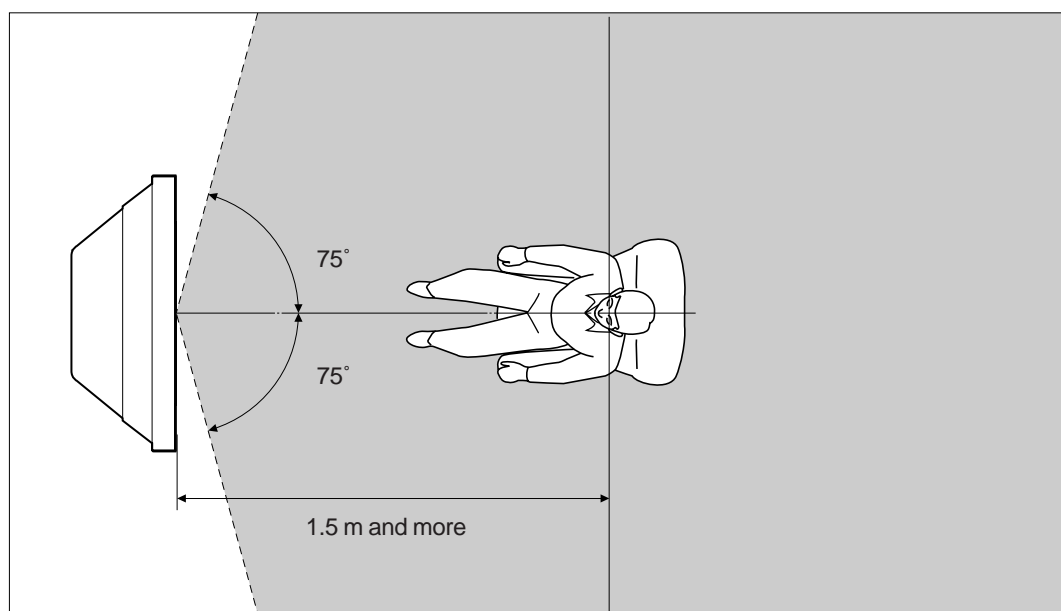

Cleaning the Air Filter

Periodic cleaning of the air filter is necessary. Clean the air filter once a month. When the filter becomes old and dust remains on the filter even after cleaning, replace it with a new one.

If you do not take the following precautions, you may get hurt or household belongings may be damaged.

- Clean the air filter periodically. If you don't clean it, it may cause internal heat build-up.
- Never use an air filter which is torn or has holes. Attach the filter firmly with six tabs. If dust enters the TV, the picture may become dark or it may cause fire.

1 Turn off the power and disconnect the power cord.

2 Remove the front panel.

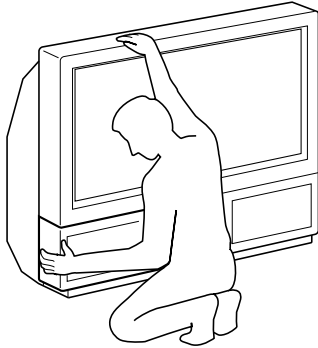

Remove the front panel without moving the TV. Grasping the sides of the front panel with your fingers, pull the panel forward. Be careful not to catch your fingernails.

3 Pull the filter upward and remove it.

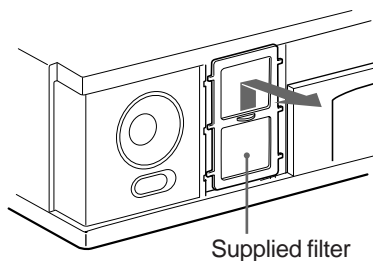

4 Clean the dust with a vacuum cleaner.

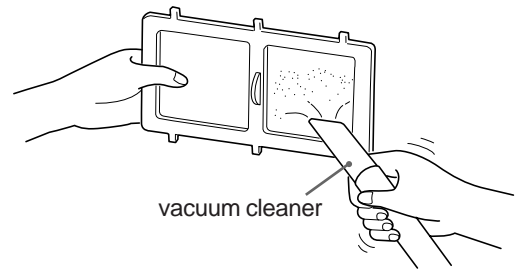

5 Attach the filter.

Attach the six tabs securely.

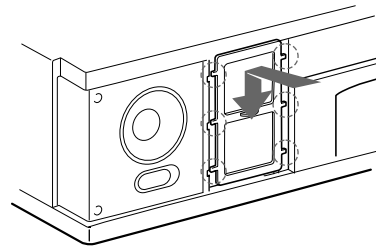

6 Attach the front panel.

Be careful not to damage the speaker.

Notes

- Attach the filter firmly. If it is not firmly attached, the power will not turn on.
- Consult your nearest Sony service centre to obtain a new filter.

Replacing the Lamp

When the lamp becomes dark or the picture colour is not normal, replace the lamp with a new one.

If you do not take the following precautions, you may get hurt or household belongings may be damaged.

- Use the supplied new lamp for replacement. If you use another lamp, it may cause damage to the TV.
- Do not remove the lamp except when replacing it. This may cause heat damage or fire.
- Before replacing the lamp, turn off the power and disconnect the power cord.
- Replace the lamp after it becomes cool. The front glass of the lamp remains 100 °C (212 °F) and more even 30 minutes after the power is turned off.
- Do not place the removed lamp in proximity to children or flammable material.
- Do not get the removed lamp wet, or insert objects inside the lamp.
- Do not place near metal or easily flammable objects, as this may cause fire. Also, do not put your hand inside the lamp compartment, as you may be burned.
- Attach the new lamp firmly. If it is not firmly attached, the picture may become dark or fire may result.

1 Turn off the power and disconnect the power cord.

Replace the lamp 30 minutes or more after the power is turned off.

Prepare the new lamp.

2 Remove the front panel.

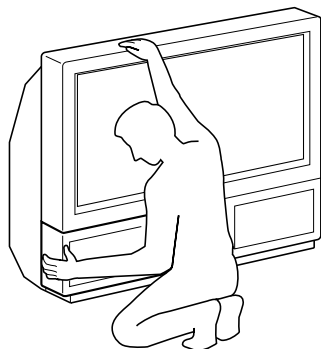

Remove the front panel without moving the TV. Grasping the side of the front panel with your fingers, pull the panel forward. Be careful not to catch your fingernails.

3 Loosen the screw with the object such as a coin and remove the lamp cover.

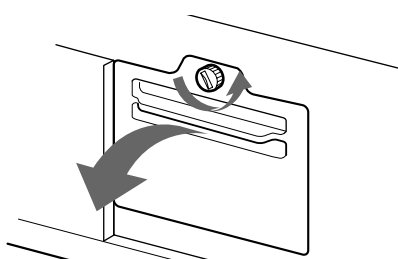

4 Loosen the screw and pull out the lamp.

The lamp is still very hot just after the power is turned off. Be careful not to touch the front glass or surrounding area of the lamp or the glass of the lamp compartment.

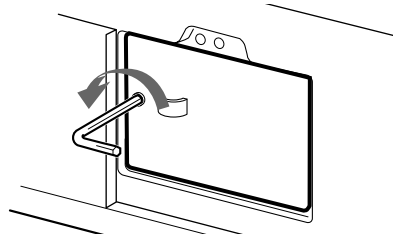

Loosen the screw with the supplied wrench.

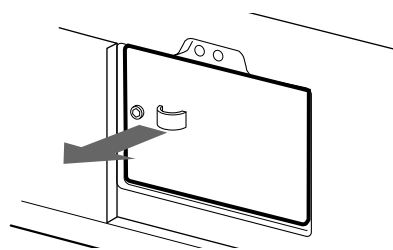

Pull out the lamp by the handle.

5 Attach the new lamp.

Fasten the screw tightly.

6 Attach the lamp cover.

Fasten the screw tightly.

7 Attach the front panel.

Be careful not to damage the speaker.

When the indicator on the front panel flashes











The lamp is damaged, replace it with a new one.

Notes

- Do not touch or stain the front glass of the new lamp or the glass of the lamp compartment. If the glass becomes dirty, the picture quality may deteriorate or the lamp life may be shortened.
- Attach the lamp cover firmly. If it is not firmly attached, the power will not turn on.
- When the lamp burns out, a noise is audible. This does not represent a damage.
- Consult your nearest Sony service centre to obtain a new lamp.

Troubleshooting

Here are some simple solutions to some problems which may affect the picture and sound.

Problem	Solution
No picture (screen is dark), no sound	<ul style="list-style-type: none"> • Plug in the TV in. • Press  on the TV (if  indicator is on, press  or a programme number on the Remote Commander). • Check the aerial connection. • Check if the selected video source is on.
Poor or no picture (screen is dark), but sound is OK	<ul style="list-style-type: none"> • Press  to enter the PICTURE CONTROL menu and adjust the brightness, contrast and colour.
Poor picture quality when watching an RGB video source	<ul style="list-style-type: none"> • Press  repeatedly to select .
Good picture but no sound	<ul style="list-style-type: none"> • Press  +. • Check loudspeakers connection. • If  is displayed on the screen, press .
No colour for colour programmes	<ul style="list-style-type: none"> • Press  to enter the PICTURE CONTROL menu, select Reset, then press the joystick to confirm.
Remote Commander does not function	<ul style="list-style-type: none"> • The batteries are weak.









If you continue to have problems, have your TV serviced by qualified personnel. Never open the casing yourself.

Specifications

This product complies with the EU Directive 89/336/EEC.

Television system	B/G/H, D/K, I, L	Sound output	2 × 30 W (music power) 2 × 15 W (RMS)
Colour system	PAL/SECAM	Centre SP input	50 W (RMS) (using as the centre speaker)
Channel coverage	NTSC 3.58/4.43 (VIDEO IN) See "Receivable channels and channel displays" at the bottom.	Power consumption	155 W
Projected picture size	40 inches Approx. 101.6 cm measured diagonally	Dimensions (W × H × D)	980 × 834 × 399 mm (38 ⁵ / ₈ × 32 ⁷ / ₈ × 15 ³ / ₄ inches)
		Mass	27 kg (59 lbs 8 oz)
		Supplied accessories	See page 6.
		Other features	Digital comb filter (High resolution) FASTTEXT DCI (Digital Constant Image)

Terminals

Rear	<p>Center speaker input terminals, 2 terminals</p> <p> (L, R), audio outputs - phono jacks</p> <p> 1, 21-pin Euro connector (CENELEC standard)</p> <ul style="list-style-type: none"> - inputs for audio and video signals - inputs for RGB - outputs of TV audio and video signals <p> 2/ 2, 21-pin Euro connector</p> <ul style="list-style-type: none"> - inputs for audio and video signals - inputs for S video - outputs for audio and video signals (selectable) <p> 4/ 4, 21-pin Euro connector</p> <ul style="list-style-type: none"> - inputs for audio and video signals - inputs for S video - outputs for audio and video signals (monitor out)
Front	<p> 3, S video inputs - 4-pin DIN</p> <p> 3, video inputs - phono jacks</p> <p>≤ (L, R), audio inputs - phono jacks</p> <p>, headphones jack - stereo minijack</p>

Design and specifications are subject to change without notice.

Receivable Channels and Channel Displays



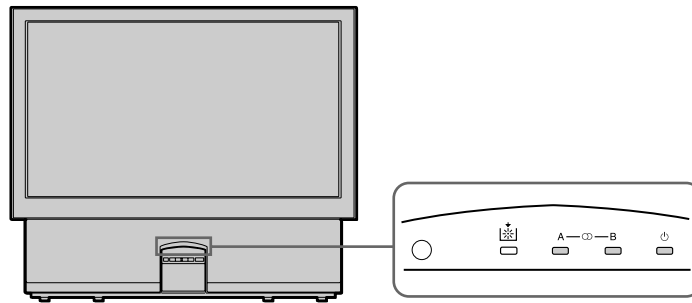

	Receivable channels	Indication on the screen
B/G/H	E2..12 21..69	C02 C03 C04..C12 C21..C69
CABLE TV (1)	S1..41	S01 S02..S41
CABLE TV (2)	S01..S05 M1..M10 U1..U10	S42..S46 S01..S10 S11..S20
ITALY	A B C D E F G H H1 H2 21..69	C11..C69
D/K	R01..R12 R21..R69	C02..C12 C21..C69
CABLE TV (1)		S01 S02..S41
CABLE TV (2)		S42 S43..S46
CABLE TV	B..Q, S21..41	S02, S03..S17, S21..S41
L	F2..F10 F21..F69	C01..C12 C21..C69
I	B21..B68	C21..C68

Warning Indicators

When a problem occurs, the indicator flashes as follows.
Attempt the solution recommended for the given problem.



GB

Cause	Indicator flashing patterns
The lamp does not light (when the lamp is damaged)	The  indicator flashes.
The lamp does not light (when the lamp is not damaged)	The  indicator flashes twice. Flashing continues in this manner.
The cover of the filter or the lamp is removed.	The  indicator flashes three times. Flashing continues in this manner.
The fan for cooling stops.	The  indicator flashes four times. Flashing continues in this manner.

If the lamp flashes in a way not described above, consult your nearest Sony service centre.

Stabilizing the Projection TV

After setting up, secure the projection TV to a wall, etc., with the supplied brackets, for safety purposes.

- 1 Mount the two supplied brackets with the screws to the upper rear side of the projection TV.**

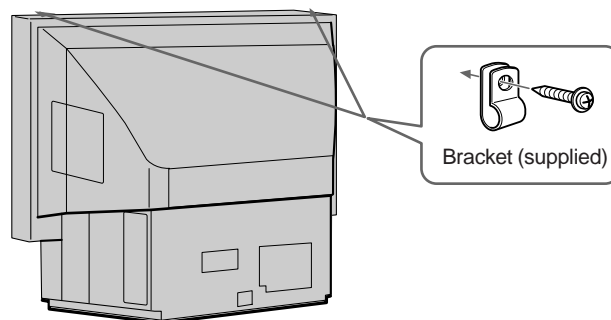

- 2 Pass a strong cord or a chain through each bracket mounted in 1, and then secure to a wall or a pillar, etc.**

Free Manuals Download Website

<http://myh66.com>

<http://usermanuals.us>

<http://www.somanuals.com>

<http://www.4manuals.cc>

<http://www.manual-lib.com>

<http://www.404manual.com>

<http://www.luxmanual.com>

<http://aubethermostatmanual.com>

Golf course search by state

<http://golfingnear.com>

Email search by domain

<http://emailbydomain.com>

Auto manuals search

<http://auto.somanuals.com>

TV manuals search

<http://tv.somanuals.com>