

Color Rear Video Projector

Operating Instructions

FLASH FOCUS

*Free Layout Picture-
in-Picture (PIP)*

KP-43T75

KP-48S75

KP-53S75

KP-53N77

KP-61S75

WARNING

To prevent fire or shock hazard, do not expose the TV to rain or moisture.

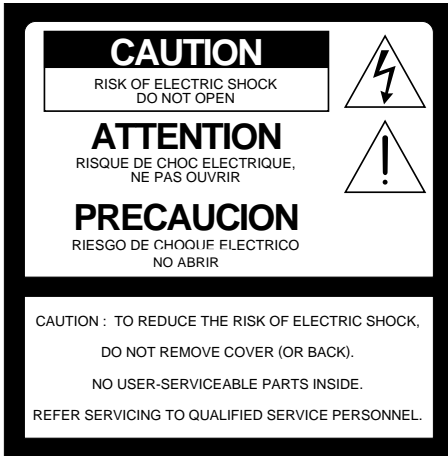

This symbol is intended to alert the user to the presence of uninsulated "dangerous voltage" within the product's enclosure that may be of sufficient magnitude to constitute a risk of electric shock to persons.



This symbol is intended to alert the user to the presence of important operating and maintenance (servicing) instructions in the literature accompanying the appliance.

CAUTION

To prevent electric shock, do not use this polarized AC plug with an extension cord, receptacle or other outlet unless the blades can be fully inserted to prevent blade exposure.

CAUTION

When using TV games, computers and similar products with your projection TV, or viewing a TV station whose logo always stays on the screen, keep the brightness and contrast functions at low settings. If a fixed (non-moving) pattern such as a station logo is left on the screen for long periods of time, especially at a high brightness or contrast setting, the image can be permanently imprinted onto the screen. These types of imprints are not covered by your warranty because they are the result of misuse.

Note on Caption Vision

This television receiver provides display of television closed captioning in accordance with §15.119 of the FCC rules.

Note on convergence adjustment

Before you use your projection TV, make sure to adjust convergence. For details, see page 19.

Note to CATV system installer

This reminder is provided to call the CATV system installer's attention to Article 820-40 of the NEC that provides guidelines for proper grounding and, in particular, specifies that the cable ground shall be connected to the grounding system of the building, as close to the point of cable entry as practical.

Use of this television receiver for other than private viewing of programs broadcast on UHF or VHF or transmitted by cable companies for the use of the general public may require authorization from the broadcaster/cable company and/or program owner.

NOTIFICATION

This equipment has been tested and found to comply with the limits for a Class B digital device pursuant to Part 15 of the FCC Rules. These limits are designed to provide reasonable protection against harmful interference in a residential installation. This

equipment generates, uses, and can radiate radio frequency energy and, if not installed and used in accordance with the instructions, may cause harmful interference with radio communications. However, there is no guarantee that interference will not occur in a particular installation. If this equipment does cause harmful interference to radio or television reception, which can be determined by turning the equipment off and on, the user is encouraged to try to correct the interference by one or more of the following measures:

- Reorient or relocate the receiving antennas.
- Increase the separation between the equipment and receiver.
- Connect the equipment into an outlet on a circuit different from that to which the receiver is connected.
- Consult the dealer or an experienced radio/TV technician for help.

You are cautioned that any changes or modifications not expressly approved in this manual could void your authority to operate this equipment.

This document is for the remote control RM-Y906
MODELS: KP-43T75, KP-48S75, KP-53S75,
KP-53N77, KP-61S75

Please keep this notice with the instruction manual.



As an ENERGY STAR Partner, Sony Corporation has determined that this product meets the ENERGY STAR guidelines for energy efficiency.

ATTENTION

Pour prévenir les chocs électriques, ne pas utiliser cette fiche polarisée avec un prolongateur, une prise de courant ou une autre sortie de courant, sauf si les lames peuvent être insérées à fond sans en laisser aucune partie à découvert.

Remote Control

In the instructions that follow, we will refer to the buttons on your remote control. Keep this flap unfolded and use this page for reference.

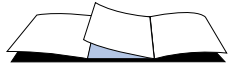

VCR/DVD/MDP
operation buttons
(page 48)

CC (page 22)

JUMP (page 21)

MUTING
(page 20)

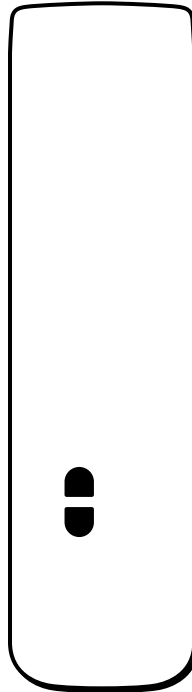

POWER
(pages 20, 48, 49)

FUNCTION
(pages 20, 48, 49)

TV/VIDEO
(pages 21, 23)

ANT (page 24)

DISPLAY
(page 21)

MENU (page 25)

Getting to know the buttons on the remote control

Names of the buttons on the remote control are presented in different colors to represent the available functions.

Button color

- Transparent Press to select the component you want to control; e.g. VTR (VCR)/MDP/DVD Player, SAT (satellite receiver)/CABLE, or projection TV.
- Green Buttons relevant to power operations, like turning the projection TV, SAT/CABLE, or VTR (VCR)/MDP/DVD Player on or off

Label color

- White TV/VTR (VCR)/MDP/DVD Player/SAT (satellite receiver)/CABLE operation buttons
- Yellow PIP operation buttons
- Blue SAT operation buttons
- Green S-Link operation buttons
- Pink DVD Player operation buttons

For a detailed explanation of most buttons, see "Watching the TV" on page 20.

Table of Contents

Welcome!	1
Using This Manual	1
Precautions	2
Important Safeguards	3
<hr/>	
<i>Installing and Connecting the Projection TV</i>	7
Carrying Your Projection TV	7
Installing the Projection TV	7
Connector Types	8
Making Connections	8
Connecting directly to a cable or an antenna	8
Cable or antenna	9
Cable and antenna	9
Connecting a cable box	9
Cable box and cable	9
Connecting a cable TV system/ antenna to a VCR	10
Connecting a VCR and projection TV to a cable box	10
Connecting a satellite receiver (SAT)	11
Connecting a satellite receiver (SAT) and a VCR	12

Connecting a DTV (digital television) receiver	13
Connecting a camcorder	13
Connecting two VCRs for tape editing	14
Connecting a DVD Player	15
Connecting a DVD Player with component video output connectors	15
Connecting an audio system	16
Connecting a Sony SAVA series speaker system	17

<i>Basic Set Up</i>	18
Using the Remote Control	18
Setting Up the Projection TV Automatically	18
Adjusting the Convergence Automatically (FLASH FOCUS)	19

<i>Using Your New Projection TV</i>	20
Watching the TV	20
Watching Two Programs at One Time — PIP	23

<i>Adjusting Your SET UP (menus)</i>	25
Learning Menu Selection	25
Using the Video Menu	26
Using the Audio Menu	27
Using the Timer Menu	29
Using the Channel Set Up Menu	30
Setting and Selecting Favorite Channel	32
Using the Set Up Menu	34
Using the Parental Control Feature	36
Activating the Parental Control Feature	36
Selecting a Custom Rating in U.S.A.	38
Selecting a Custom Rating in Canada	41
Changing the Password	42
What the Ratings Mean	43
Ratings in U.S.A.	43
Ratings in Canada	45

Welcome!

Thank you for purchasing the Sony Color Rear Video Projection TV.

This manual is for models KP-43T75, KP-48S75, KP-53S75, KP-53N77, KP-61S75.

Model KP-53S75 is used for illustration purposes.

The features you will enjoy include:

- FLASH FOCUS, allowing you to adjust convergence automatically.
- Parental Control, enabling you to block programs that you feel are unsuitable for your children.
- Picture-in-Picture (PIP), allowing you to view another TV channel, video or cable image as a window picture.
- Favorite Channel, allowing you to view and choose from eight of your favorite channels
- Y/P_B/P_R inputs for DVD Player and DTV receiver connections.
- Three AUDIO/VIDEO/S VIDEO inputs.

Operating Video Equipment 47

Setting the Manufacturer's Code 47

Operating a Cable Box or Satellite Receiver (SAT) 49

Setting the Manufacturer's Code 49

Troubleshooting 50

Specifications 52

Index 53

Owner's Record

The model and serial numbers are located at the rear of the projection TV, below the Sony logo, on the sticker, and also on the TV box (white label). Record these numbers in the spaces provided below. Refer to them whenever you call upon your Sony dealer regarding this product.

Model No. _____

Serial No. _____

Using This Manual

We recommend that you carefully review the contents of the following four sections in the order provided to ensure that you fully understand the operation of your new projection TV.

1 Installing and Connecting the Projection TV

This section guides you through your initial set up. It shows you how to install your projection TV, to connect your new components and to connect to the antenna and cable.

2 Basic Set Up

This section teaches you the basic skills needed to operate your new projection TV, including Auto Set Up. It shows you how to operate the remote control's special functions.

3 Using Your New Projection TV

This section shows you how to begin using your new projection TV. It shows you how to use your remote control's features.

4 Adjusting Your Set Up (menus)

This section teaches you how to access on-screen menus and adjust your projection TV's settings.

Instructions in this manual are written for the remote control. Similar controls may be found on the projection TV console.

Precautions

Safety

- Operate the projection TV only on 120 V AC.
- The plug is designed, for safety purposes, to fit into the wall outlet only one way. If you are unable to insert the plug fully into the outlet, contact your dealer.
- If any liquid or solid object should fall inside the cabinet, unplug the projection TV immediately and have it checked by qualified service personnel before operating it further.
- If you will not be using the projection TV for several days, disconnect the power by pulling the plug itself. Never pull on the cord.

Note on cleaning

Clean the cabinet of the projection TV with a dry soft cloth. To remove dust from the screen, wipe it gently with a soft cloth. Stubborn stains may be removed with a cloth slightly dampened with solution of mild soap and warm water. Never use strong solvents such as thinner or benzine for cleaning.

If the picture becomes dark after using the projection TV for a long period of time, it may be necessary to clean the inside of the projection TV. Consult qualified service personnel.

Installing

- To prevent internal heat buildup, do not block the ventilation openings.
- Do not install the projection TV in a hot or humid place, or in a place subject to excessive dust or mechanical vibration.
- Avoid operating the projection TV at temperatures below 5° C (41° F).
- If the projection TV is transported directly from a cold to a warm location, or if the room temperature changes suddenly, the picture may be blurred or show poor color. In this case, please wait a few hours to let the moisture evaporate before turning on the projection TV.
- To obtain the best picture, do not expose the screen to direct illumination or direct sunlight. It is recommended to use spot lighting directed down from the ceiling or to cover the windows that face the screen with opaque drapery. It is desirable to install the projection TV in a room where the floor and walls are not of a reflective material.

Important Safeguards

For your protection, please read these instructions completely, and keep this manual for future reference.

Carefully observe and comply with all warnings, cautions and instructions placed on the set, or described in the operating instructions or service manual.

WARNING

To guard against injury, the following basic safety precautions should be observed in the installation, use, and servicing of the set.

Use

Power Sources

This set should be operated only from the type of power source indicated on the serial/model plate.

If you are not sure of the type of electrical power supplied to your home, consult your dealer or local power company. For those sets designed to operate from battery power, refer to the operating instructions.



Grounding or Polarization

This set is equipped with a polarized AC power cord plug (a plug having one blade wider than the other), or with a three-wire grounding type plug (a plug having a third pin for grounding).

Follow the instructions below:



For the set with a polarized AC power cord plug

This plug will fit into the power outlet only one way. This is a safety feature. If you are unable to insert the plug fully into the outlet, try reversing the plug. If the plug should still fail to fit, contact your electrician to have a suitable outlet installed. Do not defeat the safety purpose of the polarized plug by forcing it in.

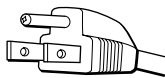

Alternate Warning

For the set with a three-wire grounding type AC plug

This plug will only fit into a grounding-type power outlet. This is a safety feature. If you are unable to insert the plug into the outlet, contact your electrician to have a suitable outlet installed. Do not defeat the safety purpose of the grounding plug.

Overloading

Do not overload wall outlets, extension cords or convenience receptacles beyond their capacity, since this can result in fire or electric shock.



Always turn the set off when it is not to be used. When the set is left unattended and unused for long periods of time, unplug it from the wall outlet as a precaution against the possibility of an internal malfunction that could create a fire hazard.



Object and Liquid Entry

Never push objects of any kind into the set through the cabinet slots as they may touch dangerous voltage points or short out parts that could result in a fire or electric shock.



Never spill liquid of any kind on the set.

(continued) 3



Attachments

Do not use attachments not recommended by the manufacturer, as they may cause hazards.

Cleaning

Unplug the set from the wall outlet before cleaning or polishing it. Do not use liquid cleaners or aerosol cleaners. Use a cloth lightly dampened with water for cleaning the exterior of the set.



If a snapping or popping sound from a projection TV set is continuous or frequent while the projection TV is operating, unplug the projection TV and consult your dealer or service technician.

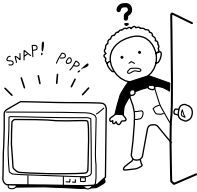

It is normal for some projection TV sets to make occasional snapping or popping sounds, particularly when being turned on or off.

Installation



Use only a cart or stand recommended by the manufacturer for the specific model of projection TV.



Water and Moisture

Do not use power-line operated sets near water—for example, near a bathtub, washbowl, kitchen sink, or laundry tub, in a wet basement or near a swimming pool, etc.

Accessories

Do not place the set on an unstable cart, stand, table or shelf. The set may fall, causing serious injury to a child or an adult, and serious damage to the set.

An appliance and cart combination should be moved with care. Quick stops, excessive force, and uneven surfaces may cause the appliance and cart combination to overturn.

Ventilation

The slots and openings in the cabinet and in the back or bottom are provided for necessary ventilation. To ensure reliable operation of the set, and to protect it from overheating, these slots and openings must never be blocked or covered.

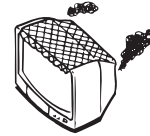

- Never cover the slots and openings with a cloth or other materials.

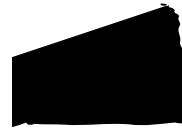

- Never block the slots and openings by placing the set on a bed, sofa, rug or other similar surface.

- Never place the set in a confined space, such as a bookcase, or built-in cabinet unless proper ventilation is provided.

- Do not place the set near or over a radiator or heat register, or where it is exposed to direct sunlight.

Power-Cord Protection



Do not allow anything to rest on or roll over the power cord, and do not place the set where the power cord is subject to wear or abuse.

Antennas

Outdoor Antenna Grounding — If an outdoor antenna is installed, follow the precautions below.

An outdoor antenna system should not be located in the vicinity of overhead power lines or other electric light or power circuits, or where it can come in contact with such power lines or circuits.

WHEN INSTALLING AN OUTDOOR ANTENNA SYSTEM, EXTREME CARE SHOULD BE TAKEN TO KEEP FROM CONTACTING SUCH POWER LINES OR CIRCUITS AS CONTACT WITH THEM IS ALMOST INVARIABLY FATAL.

Be sure the antenna system is grounded so as to provide some protection against voltage surges and built-up static charges.

Section 810 of the National Electrical Code (NEC) in USA and Section 54 of the Canadian Electrical Code in Canada provides information with respect to proper grounding of the mast and supporting structure, grounding of the lead-in wire to an antenna discharge unit, size of grounding conductors, location of antenna discharge unit, connection to grounding electrodes, and requirements for the grounding electrode.

Antenna Grounding According to the NEC — Refer to section 54-300 of Canadian Electrical Code for Antenna Grounding.

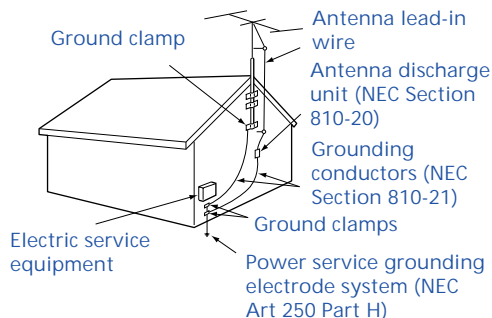

NEC: National Electrical Code

Lightning

For added protection for this television receiver during a lightning storm, or when it is left unattended and unused for long periods of time, unplug it from the wall outlet and disconnect the antenna. This will prevent damage to the receiver due to lightning and power-line surges.

Service

Damage Requiring Service

Unplug the set from the wall outlet and refer servicing to qualified service personnel under the following conditions:

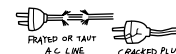

- When the power cord or plug is damaged or frayed.



- If liquid has been spilled into the set.

(continued)

Important Safeguards (continued)



- If the set has been exposed to rain or water.



- If the set has been subject to excessive shock by being dropped, or the cabinet has been damaged.



- If the set does not operate normally when following the operating instructions. Adjust only those controls that are specified in the operating instructions. Improper adjustment of other controls may result in damage and will often require extensive work by a qualified technician to restore the set to normal operation.

- When the set exhibits a distinct change in performance—this indicates a need for service.



Servicing

Do not attempt to service the set yourself since opening the cabinet may expose you to dangerous voltage or other hazards. Refer all servicing to qualified service personnel.



When the set reaches the end of its useful life, improper disposal could result in a picture tube implosion. Ask a qualified service technician to dispose of the set.

Replacement Parts

When replacement parts are required, be sure the service technician certifies in writing that he has used replacement parts specified by the manufacturer that have the same characteristics as the original parts. Unauthorized substitutions may result in fire, electric shock, or other hazards.

Safety Check

Upon completion of any service or repairs to the set, ask the service technician to perform routine safety checks (as specified by the manufacturer) to determine that the set is in safe operating condition, and to so certify.



Installing and Connecting the Projection TV

Carrying Your Projection TV

Carrying the projection TV requires three or more people.

For KP-48S75/53S75/53N77/61S75

The projection TV has been equipped with casters for easy movement on a hard surface. Please move your projection TV using the casters.

Installing the Projection TV

Recommended viewing area (Horizontal)

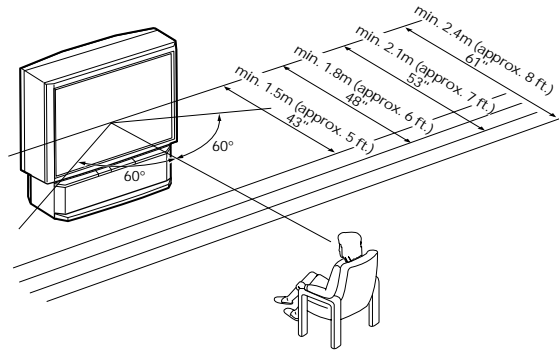

Recommended viewing area (Vertical)

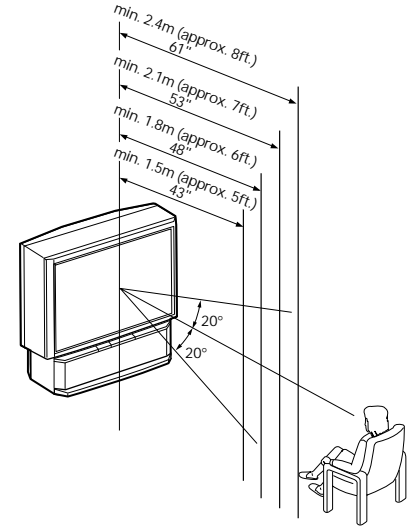

Installing and Connecting the Projection TV (continued)

Connector Types

You may find it necessary to use some of the following connector types during set up.

Coaxial cable

Standard TV cable and antenna

Push into connection.

Push into connection.

White

(Light) - Red

Video Players and DTV Receivers are equipped with the following three video connectors.

Y - Green

P_B (C_B, C_b or B-Y) - Blue

P_R (C_R, C_r or R-Y) - Red

CONTROL S cable

Sony cable for CONTROL S connection. This feature is exclusive to Sony products and allow greater control of all Sony equipment.



Push into connection.

Connect the CONTROL S OUT jack

To control other Sony equipment with the projection TV's remote control, connect the CONTROL S IN jack of the equipment to the CONTROL S OUT jack on the projection TV with the CONTROL S cable.

75-ohm coaxial cable

(Rear of projection TV)
VHF/UHF

300-ohm twin lead cable

(Rear of projection TV)
VHF/UHF

Antenna connector

Installing and Connecting the Projection TV (continued)

Connecting a cable TV system/
antenna to a VCR

- 1 Attach the coaxial cable from the incoming cable connection or antenna to VHF/UHF IN on the VCR.
- 2 Using a coaxial cable, connect VHF/UHF OUT on the VCR to VHF/UHF on the projection TV.
- 3 Using AUDIO and S VIDEO* cables, connect AUDIO and S VIDEO OUT on the VCR to AUDIO and S VIDEO IN on the projection TV (White-AUDIO Left, Red-AUDIO Right**).

Disconnect all power sources before making any connections.

(Rear of projection TV)

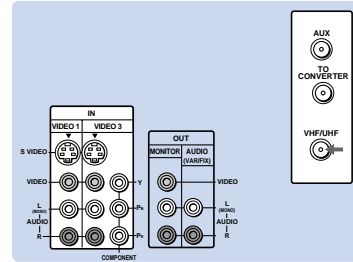

S VIDEO

VIDEO
AUDIO-L
AUDIO-R

VMC-810S/820S
(not supplied)

YC-15V/30V
(not supplied)

Coaxial cable

2

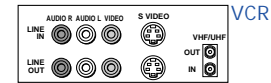

VCR

1

Cable/
Antenna

Connecting a VCR and projection
TV to a cable box

- 1 Connect the single (input) jack of the splitter to the incoming cable connection, and connect the other two (output) jacks (using the coaxial cable) to IN on the cable box and VHF/UHF on the projection TV.
- 2 Using a coaxial cable, connect OUT on the cable box to VHF/UHF IN on the VCR.
- 3 Using AUDIO and S VIDEO* cables, connect AUDIO and S VIDEO OUT on the VCR to AUDIO and S VIDEO IN on the projection TV (White-AUDIO Left, Red-AUDIO Right**).

(Rear of projection TV)

Coaxial cable

1

Cable/
Antenna
Splitter (not supplied)

VCR

2

S VIDEO

VIDEO
AUDIO-L
AUDIO-R

VMC-810S/820S
(not supplied)

YC-15V/30V
(not supplied)

Cable box

Note:

- To view scrambled channels through the cable box, select the video input which the cable box is connected to by pressing TV/VIDEO.
- * If your VCR is not equipped with S VIDEO, use a VIDEO cable (yellow) instead of the S VIDEO cable.
- ** If you are connecting a monaural VCR, connect only the single audio output to the left (MONO) input on the projection TV.

Connecting a satellite receiver (SAT)

- 1 Connect the cable from the satellite antenna to the satellite receiver.
- 2 Attach the coaxial cable from the incoming cable connection or antenna to VHF/UHF on the projection TV.
- 3 Using AUDIO and S VIDEO cables, connect AUDIO and S VIDEO OUT on the satellite receiver to AUDIO and S VIDEO IN on the projection TV (White-AUDIO Left, Red-AUDIO Right).

Note:

- To view input from the satellite receiver, select the video input which the satellite receiver is connected to by pressing TV/VIDEO on the remote control.

Disconnect all power sources before making any connections.

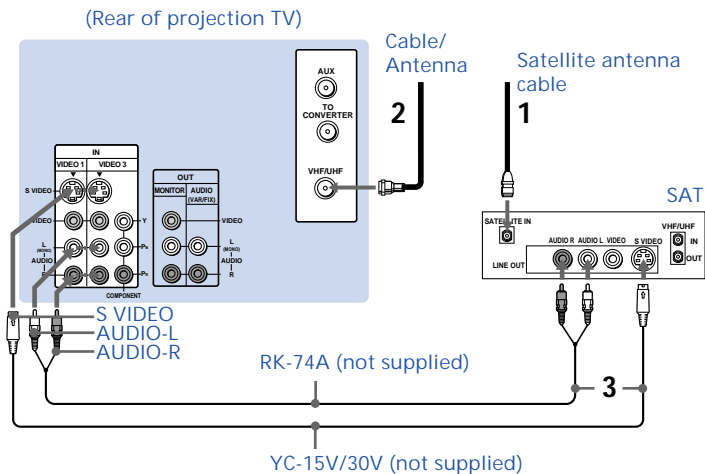

Installing and Connecting the Projection TV (continued)

Disconnect all power sources before making any connections.

Connecting a satellite receiver (SAT) and a VCR

- 1 Connect the cable from the satellite antenna to the satellite receiver.
- 2 Attach the coaxial cable from the incoming cable connection or antenna to VHF/UHF IN on the VCR.
- 3 Using a coaxial cable, connect VHF/UHF OUT on the VCR to VHF/UHF on the projection TV.
- 4 Using AUDIO and S VIDEO* cables, connect AUDIO and S VIDEO OUT on the satellite receiver to AUDIO and S VIDEO IN on the VCR.
- 5 Using AUDIO and S VIDEO* cables, connect AUDIO and S VIDEO OUT on the VCR to AUDIO and S VIDEO IN on the projection TV (White-AUDIO Left, Red-AUDIO Right).

* If your VCR is not equipped with S VIDEO, use a VIDEO cable (yellow) instead of the S VIDEO cable.

Note:

- To view input from the satellite receiver or VCR, select the video input which your satellite receiver or VCR is connected to by pressing TV/VIDEO on the remote control.

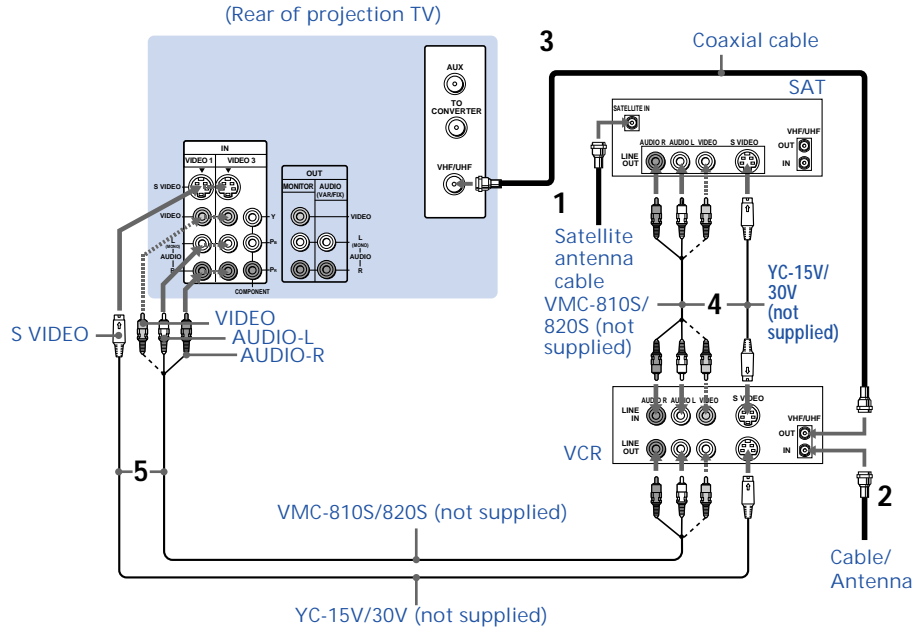

Connecting a DTV (digital television) receiver

Before connecting, be sure to read the Operating Instructions of the DTV receiver.

- 1 Attach the coaxial cable from the roof antenna to VHF/UHF IN (DTV) on the DTV receiver.
- 2 Using AUDIO and S VIDEO cables, connect AUDIO and S VIDEO OUT on the DTV receiver to AUDIO and S VIDEO IN on the projection TV (White-AUDIO Left, Red-AUDIO Right).

Note:

- If your DTV receiver supports 480i signal from YPBPR, you can connect Y, PB and PR of VIDEO OUT on the DTV receiver to Y, PB and PR of VIDEO 3 IN on the projection TV using VIDEO cables.

Connecting a camcorder

Use this connection to view a picture directly from your camcorder.

- 1 Using AUDIO and S VIDEO* cables, connect AUDIO and S VIDEO OUT on the camcorder to AUDIO and S VIDEO IN inside the drop-down panel on the front of the projection TV (White-AUDIO Left, Red-AUDIO Right**).
- 2 Press VIDEO 2 to select the video inputs from a camcorder.

* If your camcorder is not equipped with S VIDEO, use a VIDEO cable (yellow) instead of the S VIDEO cable.

** If you are connecting a monaural camcorder, connect only the single audio output to the left (MONO) input on the projection TV.

Disconnect all power sources before making any connections.

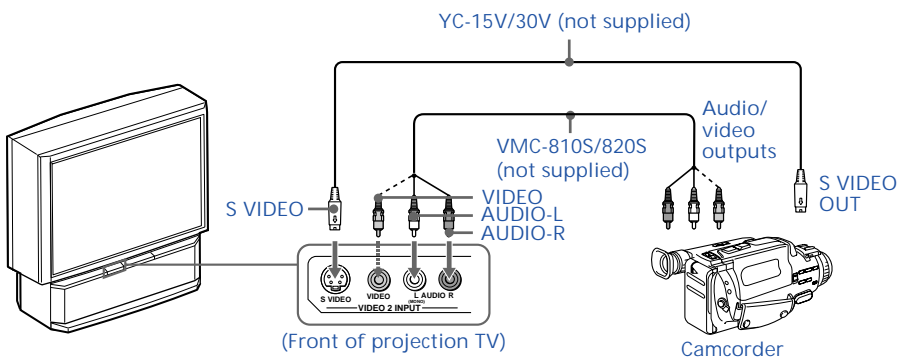
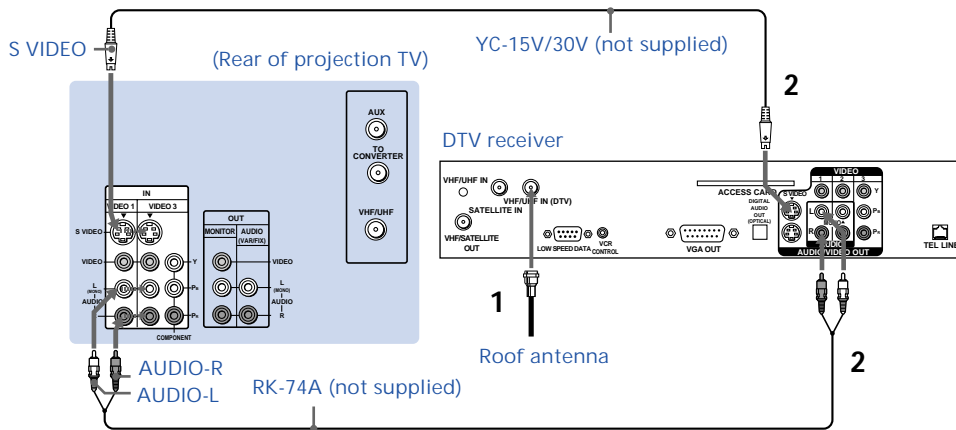

Installing and Connecting the Projection TV (continued)

Disconnect all power sources before making any connections.

Connecting two VCRs for tape editing

By connecting a second VCR to MONITOR OUT, you can record a program being played by the primary VCR to the second VCR or perform tape editing and dubbing.

- 1 Connect the VCR intended for playback using the connection instructions on page 10 of this manual.
- 2 Using an AUDIO/VIDEO cable, connect AUDIO and VIDEO IN on the VCR intended for recording to AUDIO and VIDEO OUT of MONITOR OUT on the projection TV.

Notes:

- Do not change the input signal while editing through MONITOR OUT.
- When connecting a single VCR to the projection TV: if VCR LINE OUT is connected to VIDEO IN on the projection TV, *do not* connect MONITOR OUT on the projection TV to the VCR LINE INPUT (see right). Doing so will cause program interference and other viewing problems.

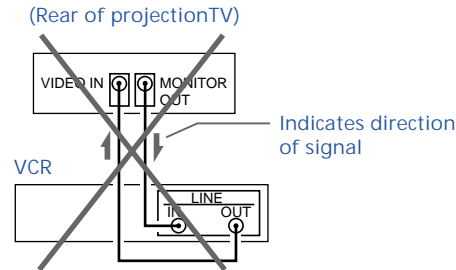
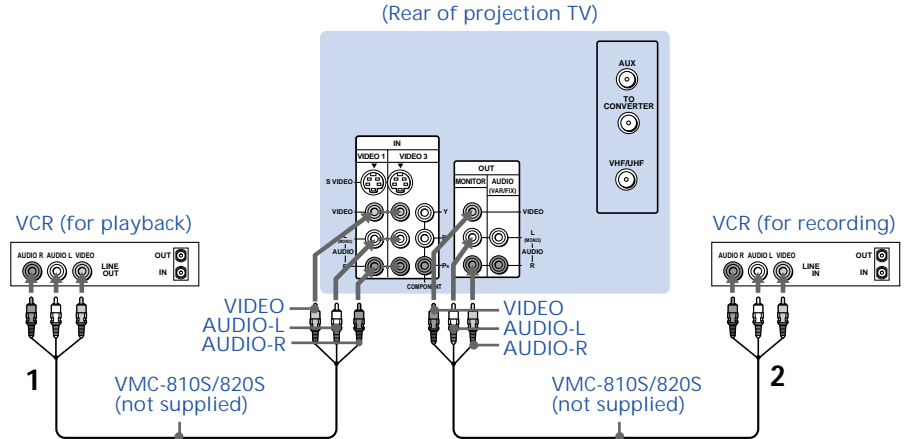

Connecting a DVD Player (Upper illustration)

Using an AUDIO and S VIDEO cables, connect AUDIO to AUDIO and S VIDEO IN on the projection TV to AUDIO and S VIDEO OUT on the DVD Player (White-AUDIO Left, Red-AUDIO Right).

Connecting a DVD Player with component video output connectors (Lower illustration)

- Using an AUDIO cable, connect AUDIO of LINE OUT on the DVD Player to AUDIO of VIDEO 3 IN on the projection TV (White-AUDIO Left, Red-AUDIO Right).
- Using three yellow VIDEO cables, connect Y, P_B, and P_R of COMPONENT VIDEO OUT on the DVD Player to Y, P_B, and P_R of VIDEO 3 IN on the projection TV.

Notes:

- Since the high quality pictures on a DVD disc contain a lot of information, picture noise may appear. In this case, adjust "Noise Reduction" in the Video menu. (see "Noise Reduction" on page 26)
- Some DVD Player terminals may be labeled differently. If so, connect as follows:
 Connect Y (green) to Y.
 Connect P_B (blue) to C_B, C_b or B-Y.
 Connect P_R (red) to C_R, C_r or R-Y.

Disconnect all power sources before making any connections.

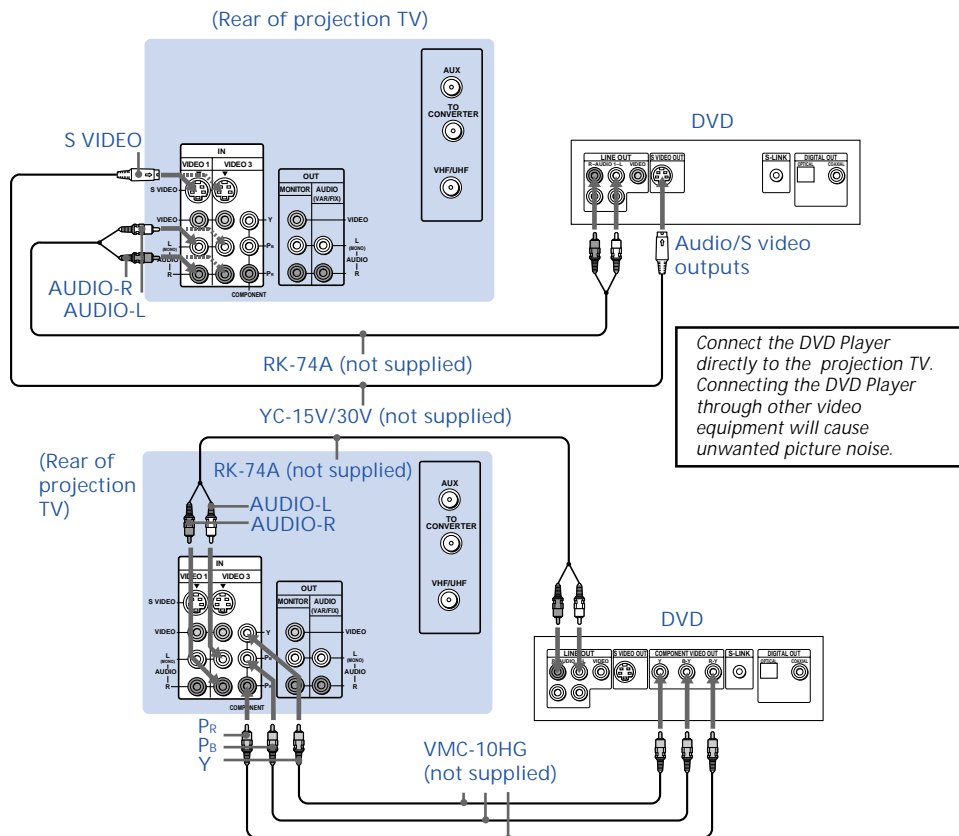

Installing and Connecting the Projection TV (continued)

Disconnect all power sources before making any connections.

Connecting an audio system

For more dynamic sound, connect an audio system to the projection TV.

- 1 Using an AUDIO cable, connect AUDIO (VAR/FIX) OUT on the projection TV to one of the unused Line inputs (e.g. Tape-2, AUX1, etc.) on the stereo.
- 2 Set the stereo to the chosen Line input and use the Audio menu to set the audio output and switch the TV's speakers off. (see "Audio Out" and "Speaker" on page 28)

Note:

- You can adjust VOLUME, "Bass," "Treble," "Balance," "MTS/SAP" and "Effect" with the supplied remote control. The control items except VOLUME can be adjusted only when "Audio Out" is set to "Variable" in the Audio menu. (see "Audio Out" on page 28)

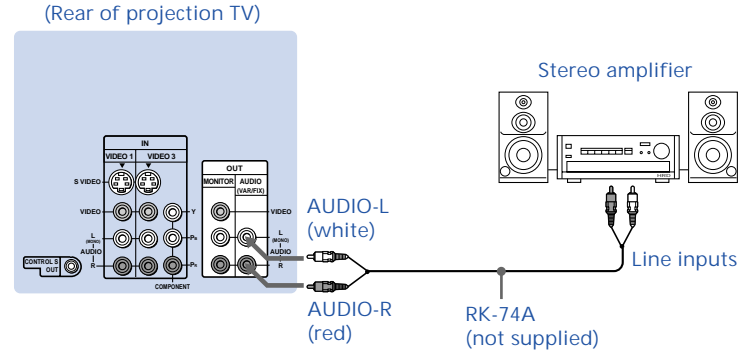



Connecting a Sony SAVA series speaker system

Use this connection to control the speaker's Dolby* Pro Logic surround system and super woofer mode with the remote control. (see "SAVA SP Control" on page 28)

- 1 Using the AUDIO cable supplied with the speaker to AUDIO (VAR/FIX) OUT on the projection TV.
- 2 Using the CONTROL S cable, connect CONTROL S IN on the speaker to CONTROL S OUT on the projection TV.

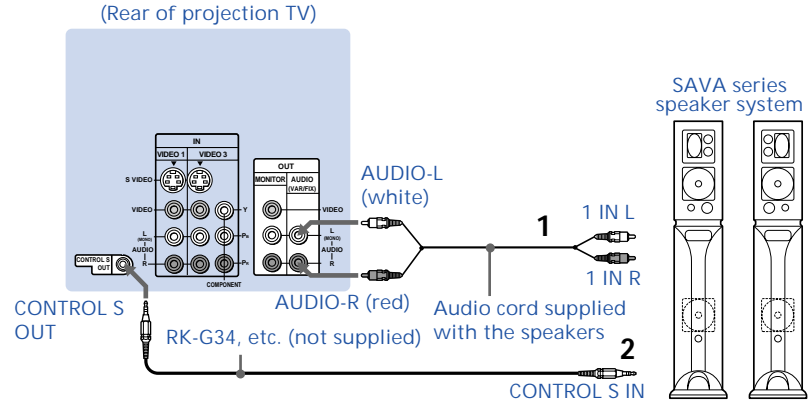
Disconnect all power sources before making any connections.



* Manufactured under license from Dolby Laboratories Licensing Corporation. Additionally licensed under Canadian patent number 1,037,877. "Dolby," the double-D symbol  and "Pro Logic" are trademarks of Dolby Laboratories Licensing Corporation.

Using the Remote Control

Inserting the batteries

Insert two size AA (R6) batteries (supplied) by matching the + and - on the batteries to the diagram inside the remote control's battery compartment.

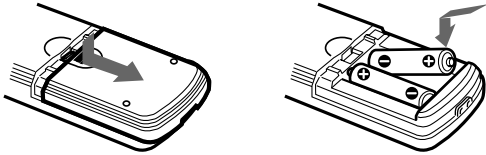

Notes:

- Remove the batteries to avoid damage from possible battery leakage whenever you anticipate that the remote control will not be used for an extended period.
- Handle the remote control with care. Avoid dropping it, getting it wet, or placing it in direct sunlight, near a heater or where the humidity is high.
- Your remote control can be programmed to operate most video equipment. (see "Operating Video Equipment" on page 47)

Setting Up the Projection TV Automatically

The AUTO SET UP feature will allow you to set the on-screen language and set all receivable channels.

The AUTO SET UP feature does not apply for installations that use a cable box for all channel selection.

You can also set up the projection TV manually. (see "Using the Channel Set Up menu" on pages 30 and 31)

Notes:

- Before you perform AUTO SET UP again, make sure that the input from ANT (not AUX) is selected by pressing ANT until "AUX" does not appear next to the channel number.
- Perform this function during the day, with the antenna and/or cable properly connected, to ensure that all available channels will be broadcasting and receivable.
- When you perform AUTO SET UP, all the settings in the Video, and Audio menus are reset to the factory settings.

Using the buttons on the front panel of the projection TV:



- 1 Press POWER to turn on the projection TV.
Press SET UP inside the drop-down panel on the projection TV and the AUTO SET UP screen appears.

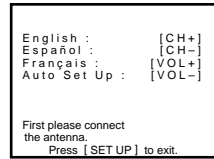

- 2 Press CHANNEL + to select English, CHANNEL - to select Español or VOLUME + to select Français.
The screen will change to reflect your choice.

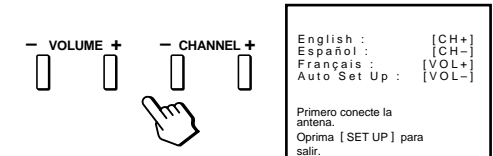

3 Press VOLUME - to continue.

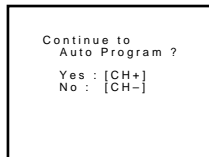
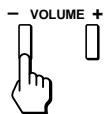

4 Press CHANNEL + to preset channels automatically.

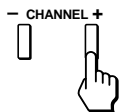

“Auto Program” appears and the projection TV starts scanning and presetting channels automatically. While scanning, the received channel will be displayed on the sub screen. When all the receivable channels are stored, the lowest numbered channel is displayed.

To perform AUTO SET UP again

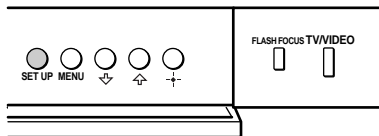

Press SET UP inside the drop-down panel on the projection TV and perform steps 2-4 above.

Press SET UP again to exit.

Adjusting the Convergence Automatically (FLASH FOCUS)

The projection tube image appears on the screen in three layers (red, green and blue). If they do not converge, the color is poor and the picture blurs.

Before you use your projection TV, be sure to adjust the convergence.

The FLASH FOCUS feature allows you to adjust the convergence automatically.

Tips

- It is recommended to perform FLASH FOCUS about 30 minutes after the projection TV is first turned on.
- You can also perform FLASH FOCUS using the Set

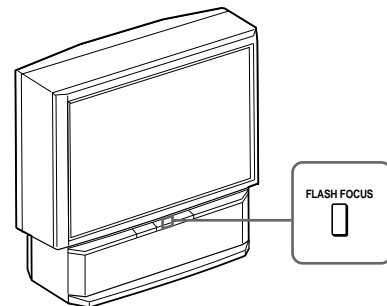

Press FLASH FOCUS.

The cross pattern appears and FLASH FOCUS begins to work. The adjustment is completed when the cross pattern becomes white.

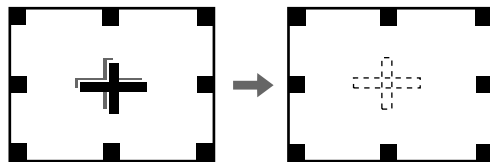

Note:

- FLASH FOCUS is canceled if you perform any other function while FLASH FOCUS is working.

Watching the TV

Many TV features can be accessed directly through the remote control. The following chart will explain the function of some buttons found on your remote control.

Using the White Labeled Buttons for Projection TV Operations	
TV (FUNCTION)	Activates the remote control for use with the projection TV.
TV POWER	Turns the projection TV on and off. If a video input indication (e.g., VIDEO 1, VIDEO 2) appears on the screen, press TV/VIDEO until a channel number appears.
 and ENTER	Use for direct channel selection. Press 0-9 to select a channel (for example, to select channel 10, press 1 and 0). The channel will change after 2 seconds, or you can press ENTER for immediate selection.
CH +/-	Press to scan through the channels (+ up or – down). Speed Surf 1 Press and hold CH + or – to change the channel number rapidly. 2 Release to display the desired channel.
VOL +/-	Press to adjust the volume (+ up or – down).
MUTING	Press to mute the sound. “Muting” will appear on the screen and will dim three seconds later. To restore sound, press again or press VOL +.

PICTURE MODE

Press PICTURE MODE repeatedly to directly choose one of five different video modes that best suits the program you are watching.

Vivid: Select for enhanced picture contrast and sharpness.

Standard: Select to display a standard picture for normal viewing environments.

Movie: Select to display a finely detailed picture for low light environments.

Personal 1, Personal 2: Select to customize the “Picture Adjustment” of the Video menu according to your personal preference.

When you select “Movie,” “Personal 1” and “Personal 2,” you can also perform the “Picture Adjustment” (such as “Brightness,” “Color,” etc.) to suit your taste. For details, see “Mode” on page 26.



REFER TO THE ILLUSTRATION OF THE REMOTE CONTROL ON THE INSIDE FRONT COVER OF THIS MANUAL AS YOU REVIEW THIS CHART

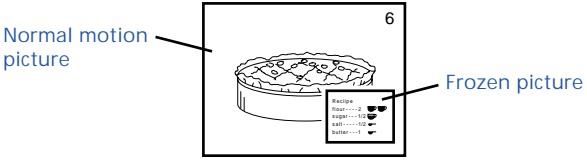

Using the White Labeled Buttons for Projection TV Operations	
TV/VIDEO	Press repeatedly to scroll through available video inputs: TV, VIDEO 1, VIDEO 2 and VIDEO 3 . If you select "Skip" as a "Video Label" in the Set Up menu, your projection TV will skip the video input you selected. (see "Video Label" on page 35)
JUMP	Press to alternate or <i>jump</i> back and forth between two channels. The projection TV will jump between the current channel and the last channel selected using the 0-9 buttons.
FREEZE <i>(yellow labeled button)</i>	<p>This is useful when you need to copy down information that appears on the TV's screen.</p> <p>Press to <i>freeze</i> the desired picture. The frozen picture is displayed in the window picture while viewing the normal picture of the current channel in the main picture.</p>  <p>To change the location of the window picture, press \uparrow, \downarrow, \leftarrow or \rightarrow. Press FREEZE again to display the normal picture.</p>
DISPLAY	Press to display the channel number, current time, channel caption (if set), and MTS/SAP mode (if SAP is selected). The SAP indication disappears and the other indications dim three seconds later. To turn the display off, press DISPLAY again.

(continued)

Using Your New Projection TV (continued)



REFER TO THE
ILLUSTRATION OF THE
REMOTE CONTROL ON THE
INSIDE FRONT COVER OF
THIS MANUAL AS YOU
REVIEW THIS CHART

Using the White Labeled Buttons for Projection TV Operations	
	<p>Press repeatedly to scroll through available displays: XDS (Extended Data Service) Displays a network name, program name, program type, program length, program description, call letters and time of the show if the broadcaster offers this service.</p> <p>Caption Vision Displayed on the screen if the broadcaster offers this service. (see "Caption Vision" on page 34)</p> <p>No display "Off" appears and the display is canceled.</p>
SLEEP	<p>Press repeatedly until the projection TV displays the approximate time in minutes (30, 60, or 90) that you want the projection TV to remain on before shutting off automatically. Cancel by pressing until "Sleep Off" appears.</p>
ANT <i>(AUX input)</i>	<p>Press to change between the VHF/UHF input and the AUX input. (for detailed connection information, see "Cable and antenna" or "Cable box and cable" on page 9)</p>
MTS/SAP	<p>Press to scroll through the Multi-channel TV Sound (MTS) options: Stereo, SAP and Mono. (see "MTS/SAP" on page 27)</p>
	<p>Press to select an audio option: Simulated, Surround, BBE and Effect Off. (see "Effect" on page 27)</p>
TV/VTR	<p>Press when you are finished using a VCR and you want to switch to the TV input. The VCR power will remain on.</p>
SYSTEM OFF	<p>Press to turn off the projection TV and all other Sony equipment.</p>

Watching Two Programs at One Time — PIP

The Picture-in-Picture (PIP) feature allows you to view two channels simultaneously, one in the full size “main” picture and one in a smaller “window” picture.

You can move the window picture to any location on the screen. (Free Layout Picture-in-Picture)

The symbol “▶” or “◀” indicates which picture’s TV channel or input source can be changed.

The symbol “♪” indicates which picture’s sound is being received.

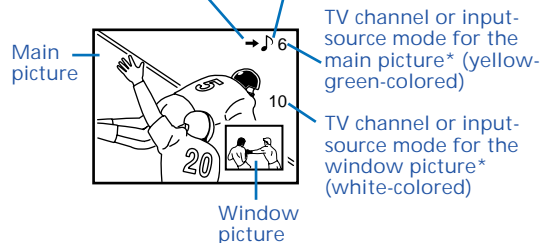





* It will dim in about 3 seconds.

Tip







If you press **RESET** in PIP mode, the window picture will move to the bottom right (factory-preset location).

Using the Yellow Labeled Buttons for PIP Operations

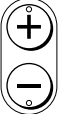
<p>PIP</p> 	<p>Press to display a window picture.</p> <p>Each time you press this button, the picture size will change (1/9 → 1/16 → no display).</p> <p style="text-align: center;">←—————→</p> <p>To close the window picture, press PIP repeatedly until it disappears.</p>
<p>POSITION</p>  <p>or</p> 	<p>Press POSITION repeatedly to change the location of the window picture (counterclockwise) around the main picture.</p> <p>You can also change the location by pressing the ▲, ▼, ◀ or ▶ button.</p> <p>The window picture moves in the direction of the arrow indicated on the pressed button.</p>
<p>ACTIVE</p> 	<p>Press to select either the main or window picture in order to change the TV channel or video source using the white labeled buttons below. The symbol “▶” (or “◀”) will appear to indicate which picture’s channel or input mode can be changed.</p>
<p>TV/VIDEO</p>  <p>(white labeled button)</p>	<p>Press repeatedly to scroll through the available video inputs for the picture on which the symbol “▶” (or “◀”) is displayed. (see “TV/VIDEO” on page 21)</p>

Using Your New Projection TV (continued)

Using the Yellow Labeled Buttons for PIP Operations

<p>CH</p>  <p>or 0-9 or JUMP</p>   <p>and ENTER</p> <p><i>(white labeled button)</i></p>	<p>Press to select the TV channel on which the symbol "➔" is displayed. (for details, see "Watching the TV" on page 20)</p> <p>Speed Surf</p> <ol style="list-style-type: none"> 1 Press and hold CH + or – to change the channel number rapidly. 2 Release to display the desired channel.
<p>ANT</p>  <p><i>(white labeled button)</i></p>	<p>Press to change between the VHF/UHF input and the AUX input for the picture on which the symbol "➔" (or "⚡") is displayed.</p>
<p>AUDIO</p> 	<p>Press to alternate sound between the main picture and the window picture. The symbol "♪" will appear for a few seconds to indicate which picture's sound is being received.</p>
<p>FREEZE</p> 	<p>This is useful when you need to copy down information of the main picture. Press to freeze the desired scene in the main picture. The frozen picture is displayed in the window picture while viewing the normal picture in the main picture. The window picture size is automatically changed to 1/9 if it was 1/16. Press again to resume normal PIP viewing.</p>
<p>SWAP</p> 	<p>Press to switch the audio and video of the main picture and the window picture. Each time you press SWAP, the picture and sound of the two will be exchanged.</p>



REFER TO THE ILLUSTRATION OF THE REMOTE CONTROL ON THE INSIDE FRONT COVER OF THIS MANUAL AS YOU REVIEW THIS CHART

Note:

- If one of the pictures received through PIP is snowy, the entire screen may become unstable. In this case, erase the snowy channel. (see "Channel Skip/Add" on page 31)

Adjusting Your SET UP (menus)

Learning Menu Selection

Use the MENU button to access a menu and use the \uparrow , \downarrow , \leftarrow , \rightarrow and \oplus buttons to alter the settings. Use the following example to learn how to modify settings.

- 1 Press the MENU button.

The main menu appears.

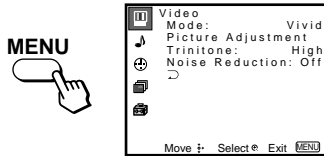

- 2 Press \uparrow or \downarrow to highlight the desired menu and press \oplus to activate it.

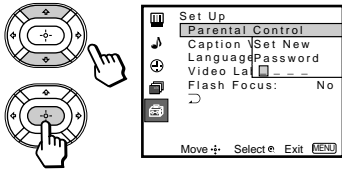

You may also press \rightarrow to activate your selection.

- 3 Press \uparrow or \downarrow to highlight the desired option.

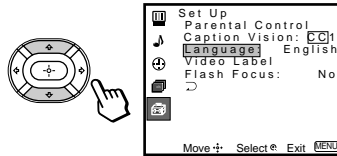

- 4 Press \oplus .

Options for your selection (Pop-up menu or Adjusting menu) will be displayed.



Pop-up menu

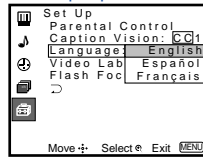

Adjusting menu

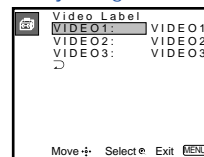

- 5 Press \uparrow or \downarrow to make your selection and press \oplus to activate it. The previous screen will reappear.

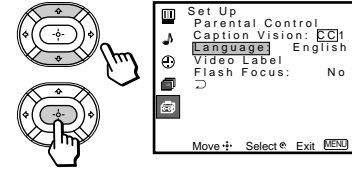

Some adjustment menus may require further operations. For details, see each menu option.

To return to the previous screen (except for the slider adjustment menus), choose " \rightarrow " at the bottom of the menu and press \oplus or \leftarrow .

- 6 Once you have completed all menu corrections, press MENU to exit the menu screens.

MENU



To exit from the menus at any time

Press MENU.

Tip 

You can also use the MENU, \uparrow / \downarrow and \oplus buttons inside the front drop-down panel of the projection TV for the menu selection.

Adjusting Your SET UP (menus) (continued)

Using the Video Menu

Video	
Mode:	Vivid
Picture Adjustment	
Trinitone:	High
Noise Reduction	:Off

Mode

*Customized
picture viewing*

You can choose one of five different video modes that best suits the program you are watching. You can also perform the "Picture Adjustment" (such as "Brightness," "Color," etc.) for "Movie," "Personal 1" or "Personal 2" to suit your taste.

Vivid: Select for enhanced picture contrast and sharpness.

Standard: Select to display a standard picture for normal viewing environments.

Movie: Select to display a finely detailed picture for low light environments.

To
Pres
Vide
"Mod
after s

adjustment

NTSC Standard: Select to give the white colors a reddish tint.

Noise Reduction
Noise reduction

Select **On** to reduce picture noise.

Select **Off** to cancel the feature.

"Noise Reduction" can be set separately from the "Mode" settings of the Video menu.



🎵 Using the Audio Menu

For detailed information on using the remote control to modify menu settings, refer to “Learning Menu Selection” on page 25.

To select the Audio 🎵 menu:

Display → Highlight 🎵



Treble <i>Sound adjustment</i>	Adjust slider right (up) to increase high pitched sounds. Adjust slider left (down) to decrease high pitched sounds.
Bass <i>Sound adjustment</i>	Adjust slider right (up) to increase low pitched sounds. Adjust slider left (down) to decrease low pitched sounds.
Balance <i>Sound adjustment</i>	Adjust slider right (up) to emphasize right speaker volume. Adjust slider left (down) to emphasize left speaker volume.
MTS/SAP <i>Enjoy stereo, bilingual and mono programs.</i>	When the sound is intermittent due to poor reception conditions, select “Stereo” or “SAP.” Stereo: Select for stereo reception when viewing a program broadcast in stereo. SAP: Select to listen to a bilingual broadcast. (non-SAP programs will be muted when this feature is selected) Mono: Select for mono reception. (use to reduce noise during stereo broadcasts) Quick MTS access: Press  on the remote control to cycle through the “MTS/SAP” options as follows: Stereo → SAP → Mono.
Auto Volume <i>Adjust the sound level.</i>	On: Sound output coming from TV speakers have the volume level equalized for all channel audio inputs when broadcasts have different sound transmission levels. Off: Sound output coming from the TV speakers varies according to the received channel.
Effect <i>Customizes surround sound effects based on the program's audio type.</i>	“Effect” can only be set when “Speaker” is set to “On” or “Off.” Simulated: Adds a surround-like effect to mono programs. Surround: Simulates sound with the atmosphere of a movie theater or a concert hall for stereo programs. BBE*: Centers the sound intensity to the front, creating an effect as if you were seated in front of an orchestra. Off: Normal stereo or mono reception. Quick Effect access: Press  on the remote control to cycle through the “Effect” options as follows: Simulated → Surround → BBE → Effect Off.

Adjusting Your SET UP (menus) (continued)

<p>Speaker <i>Custom selection of audio output source</i></p>	<p>On: Select to listen to the sound from the projection TV speakers alone. Off: Select to turn off the projection TV speakers and listen to the projection TV's sound only through an external audio system's speakers. SAVA SP: Select to turn off the projection TV speakers and listen to the projection TV's sound only through the Sony SAVA series speaker system. You can adjust volume, muting, "Surround Mode," and "Super Woofer Mode" with the projection TV's remote control. (see "SAVA SP Control" below)</p>
<p>Audio Out <i>Easy control of volume adjustment</i></p>	<p>"Audio Out" can only be set when "Speaker" is set to "Off." Fixed: Sound output is held at a fixed level through the audio system. Use the AV receiver's remote control to adjust the volume. Variable: Sound output varies according to the TV settings. Useful when you want to use your remote control to control the output of a separate audio system.</p>
<p>SAVA SP Control <i>Controls Sony SAVA speaker's mode.</i></p>	<p>"SAVA SP Control" can only be set when Sony SAVA speaker system is connected to the AUDIO (VAR/FIX) OUT connectors and "Speaker" is set to "SAVA SP." (see "Speaker" above) You can also adjust the SAVA speaker's volume using VOL +/- of the projection TV's remote control. Surround Mode: Select to activate the SAVA Speaker's surround mode. Super Woofer Mode: Select to activate the SAVA Speaker's super woofer mode.</p>

⌚ Using the Timer Menu

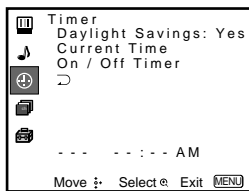

After setting the clock you can use the timer to turn the projection TV on and off.

For detailed information on using the remote control to modify menu settings, refer to “Learning Menu Selection” on page 25.

To select the Timer ⌚ menu:

Display → Highlight ⌚ → Select

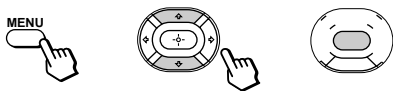

Tip 💡

Set daylight saving time before setting the clock. Any loss of power will cause these settings to be erased.

<p>Daylight Savings <i>Automatically adjusts the time.</i></p>	<p>Spring: Select Yes to compensate for Daylight Saving Time. The current time automatically moves ahead one hour. Fall: Select No at the end of Daylight Saving Time. The current time moves back one hour.</p>
<p>Current Time <i>Necessary for the Timer.</i></p>	<ol style="list-style-type: none"> 1 Press (+), then press ▲ or ▼ until the current day (Sun-Sat) is displayed, and press (+). 2 Press ▲ or ▼ until the current hour (1-12) and AM/PM is displayed, and press (+). 3 Press ▲ or ▼ until the current minute (00-59) is displayed, and press (+). <p>The clock has now started. Press MENU to exit.</p>
<p>On/Off Timer <i>Wake up or scheduled viewing.</i></p>	<ol style="list-style-type: none"> 1 Press ▲ or ▼ until the desired day or range of days (Every Sun-Sat, Every Mon-Fri, Sunday, Monday, ... Saturday, Every Sunday, ... Every Saturday) is displayed, and press (+). 2 Press ▲ or ▼ until the time (hours and minutes) that you want the projection TV to remain on is displayed, and then press (+). 3 Press ▲ or ▼ to set the time duration (maximum of 6 hours) and press (+). 4 Press ▲ or ▼ to select the desired channel and press (+). <p>The timer is now set. The TIMER/STAND BY indicator on your projection TV will be lit. Press MENU to exit. To cancel your timer setting, press RESET while in the On/Off Timer window. Performing Auto Program will erase all Timer settings.</p>

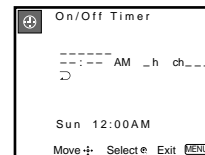
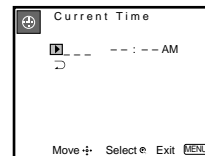

Adjusting Your SET UP (menus) (continued)

Using the Channel Set Up Menu

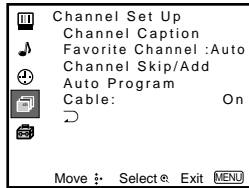

For detailed information on using the remote control to modify menu settings, refer to “Learning Menu Selection” on page 25.

To select the Channel Set Up menu:

Display → Highlight → Select

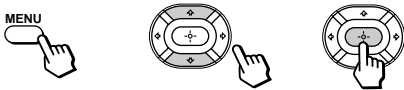

Channel Caption

Easy recognition of the channel you are watching

You can add a caption for up to 32 channels of VHF/ UHF input.

With the Channel Caption window open:

- 1 Press **+** and then press **▲** or **▼** to select the desired channel. You can view the channel that is selected with the Channel Caption menu in the sub screen.
- 2 Press **+**.
- 3 Press **▲** or **▼** to display the first letter or number of the caption and press **+** to select it. Repeat until up to five digits are selected.
- 4 Press **+**.

To erase a caption, press RESET.

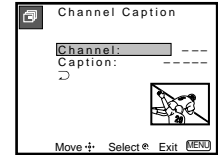

Favorite Channel

User's favorite channels

The Favorite Channel feature enables easy access to the eight channels that you preset (or the last channel that you were watching). (for details on how to set up this feature, see “Setting and Selecting Favorite Channel” on page 32)

<p>Channel Skip/Add <i>Skips unnecessary channels.</i></p>	<p>After AUTO SET UP, you can erase unnecessary channels from the channel preset memory. With the Channel Skip/Add window open:</p> <ol style="list-style-type: none"> 1 Press ▲ or ▼ to select the desired channel. You can view the channel that is selected with the Channel Skip/Add menu in the sub screen. You can also use CH +/- or 0-9 and ENTER buttons. 2 Press +. 3 Press ▲ or ▼ to select Skip, and press +. The selected channel will be erased. If you want to re-enter the skipped channel, follow the steps above and select Add.
<p>Auto Program <i>Automatic channel presetting</i></p>	<p>Select Yes to signal the projection TV to automatically program all receivable channels. When all the receivable channels are stored, the lowest numbered channel is displayed. Select No to cancel Auto Program.</p>
<p>Cable <i>Cable system setting</i></p>	<p>Select On if your projection TV is connected to a cable system. Select Off if your projection TV is connected to an antenna.</p>



Adjusting Your SET UP (menus) (continued)

Setting and Selecting Favorite Channel

The Favorite Channel feature of your projection TV enables easy access to the eight channels that you preset (or the last channel that you were watching).

Your Favorite Channel options can be set automatically or manually.

The factory setting for “Favorite Channel” is “Auto.”

When “Favorite Channel” is set to “Auto,” the last eight channels selected with the 0–9 buttons will be set as Favorite Channel options. If you want to input your own selections as Favorite Channel settings, set to “Manual.”

Setting Favorite Channel manually

- 1 Select “Favorite Channel” from the Channel Set Up menu. (see page 30)

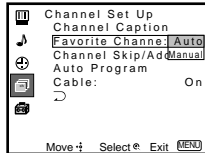

- 2 Press **▲** or **▼** to select “Manual” and press **[+]**.

The Favorite Channel menu will appear. If you set Channel Caption names (e.g. CNN, HBO), they will also be displayed. (see “Channel Caption” on page 30)

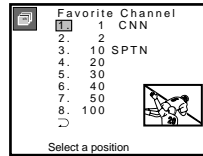
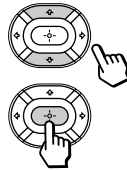

- 3 Press **▲** or **▼** to select a position (1–8), and press **[+]**.

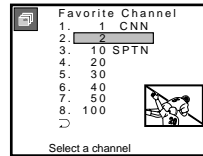
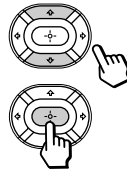

- 4 Press **▲** or **▼** to select a channel and press **[+]**.

You have now selected a favorite channel.

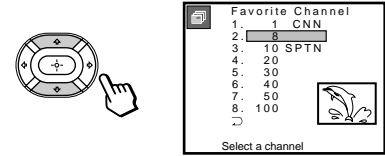

- 5 Use **▲** and **▼** to program other favorite channels. (Follow steps 3 and 4.)
- 6 Press MENU when you have finished. Your favorite channels are now ready for use.

Changing Favorite Channel choices

You have the option of returning to the Favorite Channel screen to adjust any of your favorite channel choices.

Simply proceed as described in “Setting Favorite Channel manually” (skip step 2 if “Manual” is already selected).

When you reach step 3, select the position you want to change and press \oplus . Press \uparrow or \downarrow to select a new channel.

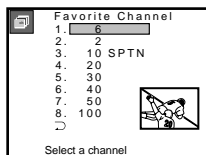

Press MENU when you are done.

Using Favorite Channel

You can use the Favorite Channel feature to directly select the channel you want to watch.

1 Press \oplus once.

The favorite channel menu and a window picture will be superimposed over the current channel. The window picture displays the channel selected from the menu.

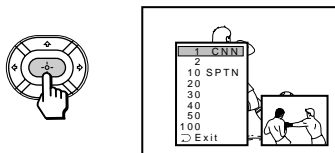

2 Press \uparrow or \downarrow to select the channel that you wish to view from the menu.

The picture of the selected channel will be displayed in the window picture.

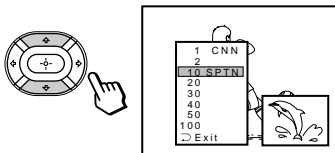

3 Press \oplus to select the channel.

The selected channel will be displayed for normal viewing.

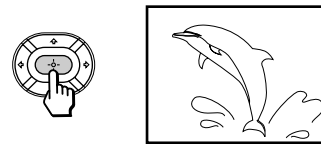

To cancel the favorite channel menu before selecting a channel, press \uparrow or \downarrow to select “Exit” at the bottom of the menu and press



Adjusting Your SET UP (menus) (continued)

Using the Set Up Menu

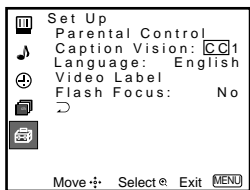

For detailed information on using the remote control to modify menu settings, refer to “Learning Menu Selection” on page 25.

To select the Set Up  menu:

Display  Highlight   Select

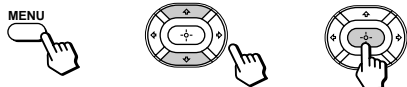

<p>Parental Control <i>Blocks programs unsuitable for children.</i></p>	<p>Allows you to block TV programs that you feel are unsuitable for your children. (see “Using the Parental Control Feature” on page 36 for details)</p>
<p>Caption Vision <i>Television closed caption display</i></p>	<p>Some programs are broadcast with Caption Vision. To display “Caption Vision,” select CC1, CC2, CC3, CC4, TEXT1, TEXT2, TEXT3 or TEXT4 from the menu. Then press the CC button until “Caption Vision” is displayed. CC1, CC2, CC3 or CC4 displays a printed version of the dialogue or sound effects of a program. (The mode should be set to CC1 for most programs.) TEXT1, TEXT2, TEXT3, or TEXT4 displays network/station information presented using either half or the whole screen.</p> <p>Notes:</p> <ul style="list-style-type: none"> Poor reception of TV programs can cause errors in Caption Vision and XDS. Captions may appear with a white box or other errors instead of the intended text. XDS, Caption Vision, and the status display cannot be used at the same time.
<p>Language <i>Preferred language</i></p>	<p>Select from available languages (English, Español or Français) to display all menus in your language of choice.</p>

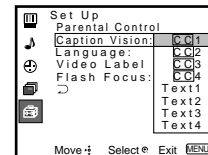

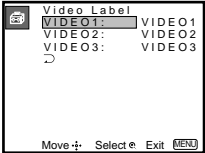
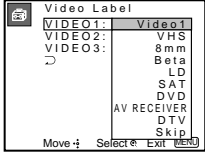
<p>Video Label <i>Easy recognition of connected equipment (e.g. SAT, VHS, etc.)</i></p>	<p>This feature allows you to label each input mode so that you can easily identify the connected equipment (e.g. you can label VIDEO 1 IN as VHS).</p>  <p>With the Video Label window open:</p> <ol style="list-style-type: none"> 1 Press ▲ or ▼ to select the input mode you want to label and press (+). 2 Press ▲ or ▼ to select the label and press (+). <p>Video Label Options: VIDEO 1: VIDEO 1, VHS, 8mm, Beta, LD, SAT, DVD, AV RECEIVER, DTV, Skip VIDEO 2/3: VIDEO 2/VIDEO 3, VHS, 8mm, Beta, LD, SAT, DVD, DTV, Skip <i>If you select "Skip," your projection TV will skip this connection when you scan through video sources using the TV/VIDEO button.</i></p> 
<p>Flash Focus <i>Automatic convergence adjustment</i></p>	<p>Select Yes and press (+) to start Flash Focus adjustment. When the adjustment is completed, the cross pattern on the screen becomes white. (for details, see page 19) Select No to cancel Flash Focus.</p>

Adjusting Your SET UP (menus) (continued)

Using the Parental Control Feature

The TV programs and movies shown on TV are given a rating signal based on the following rating systems.

In U.S.A.: U.S. Television Parental Guidelines to rate television programs (U.S. TV ratings), and Motion Picture Association of America (MPAA) Guidelines to rate movies including those shown on TV (movie ratings)

In Canada: Canadian English Language ratings to rate television programs in English, and Canadian French Language ratings to rate those in French.

To block programs you feel are unsuitable for your children, you need to set the TV for the desired rating systems. Sony's predetermined ratings are also available.

See pages 43 to 45 for a description of the ratings.

The Parental Control feature of the TV functions by receiving the rating signal from your local broadcasting station or cable service provider.

Activating the Parental Control Feature

First, set a password, then select your desired rating from Sony's predetermined ratings.

36

- 1 Select "Parental Control" from the Set Up menu. (see page 34)

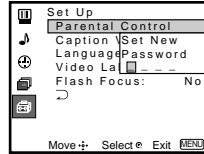

- 2 Enter a four digit password* using the 0-9 buttons.

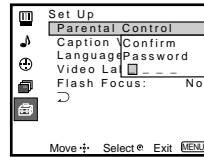

* Do not enter "4357" corresponding to "HELP" on a phone number pad. (see page 43)

- 3 To confirm the password, re-enter the same password with the 0-9 buttons. Your password is stored and the Parental Control menu automatically appears. If you want to change the password, see page 42.

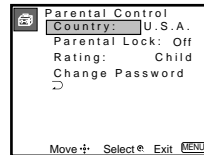

- 4 Make sure that "Country" is highlighted, and press (+).

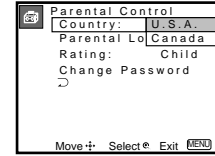

- 5 Press ↑ or ↓ to select your country (U.S.A. or Canada), and press (+).

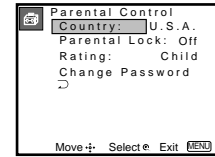

- 6 Press ↑ or ↓ to select "Parental Lock," and press (+).

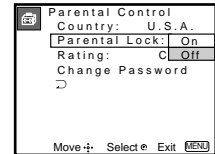

7 Press **▲** or **▼** to select “On,” and press

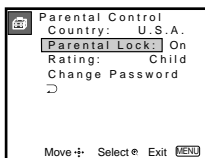
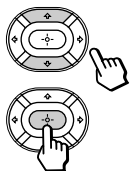

8 Press **▲** or **▼** to select “Rating,” and press

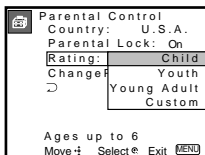
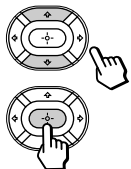

9 Press **▲** or **▼** to select a desired rating (“Child,” “Youth” and “Young Adult”), and press **+**.

If you want to select the ratings from “Custom,” go to step 4 of “Selecting a Custom Rating in U.S.A.” on page 38 or “Selecting a Custom Rating in Canada” on page 41, according to your “Country” setting.

10 Press **MENU** to exit the menu.

To deactivate the Parental Control feature

If you set “Parental Lock” in the Parental Control menu to “Off,” the Parental Control feature will not work and you can view all TV programs and movies shown on TV.

1 Select “Parental Control” from the Set Up menu. (see page 34)

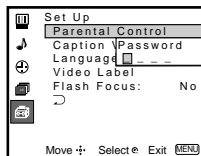

2 Enter your four digit password using the 0-9 buttons.

The Parental Control menu appears.

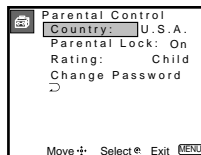

3 Press **▲** or **▼** to select “Parental Lock,” and press **+**.

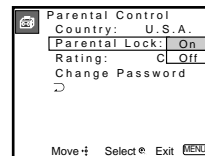

4 Press **▲** or **▼** to select “Off,” and press **+**.

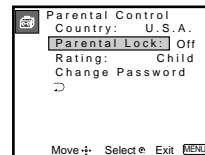

5 Press **MENU** to exit the menu.

Adjusting Your SET UP (menus) (continued)

To unlock the Parental Control feature temporarily

When you select a Parental Control program, no sound or picture except for a channel number will appear. The  indicator is displayed. To view the program, follow the steps below.

- 1 Press ENTER to display the “Password” screen.
- 2 Enter your password using the 0–9 buttons. Parental Control will be canceled (“Parental Lock” set to “Off”) until you turn your projection TV off.

Selecting a Custom Rating in U.S.A.

If you want to select the ratings to be blocked from “Custom” once you have activated the Parental Control feature (page 37), follow the procedure below.

For a detailed description of each rating, see “What the Ratings Mean” on pages 43 to 45.

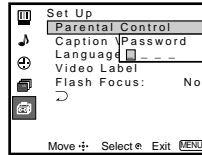

- 1 Select “Parental Control” from the Set Up menu. (see page 34)





- 2 Enter your four digit password using the 0–9 buttons.

The Parental Control menu appears. Make sure that “Country” is set to “U.S.A.”

```
Parental Control
Country: U.S.A.
Parental Lock:
Rating: Child
Change Password
  >
```

- 3 Press  or  to select “Rating,” and press .

- 4 Press  or  to select “Custom,” and press .

First, select a TV rating.

- 5 Press **▲** or **▼** to select “TV Rating,” and press **(+)**.

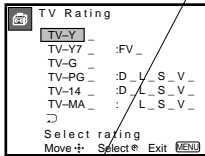

- 6 Press **▲** or **▼** to select the TV rating to be blocked, and press **(+)**.

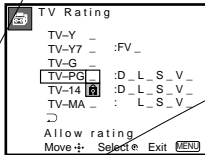

- 7 Press **▲** or **▼** to select “**Ⓢ**,” and press **(+)**. The **Ⓢ** indicator automatically appears beside the selected rating and all “higher” ratings, indicating that the programs that match the ratings will be blocked.

Some ratings have additional content ratings called “extenders.” The extenders are defined as follows: D (sexually suggestive Dialog), FV (Fantasy Violence), L (coarse Language), S (Sexual situations) and V (Violence). By setting the extenders, you can define additional viewing limits. For more details of extenders, see page 45.

All of the extenders included in the selected ratings will be blocked. If you wish to allow any of them to be viewed, go to step 8.

- 8 Press **←** or **→** to select the extender to be viewed, and press **(+)**.

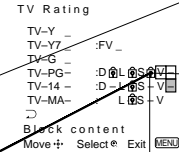

- 9 Press **▲** or **▼** to select “-,” and press **(+)**.

“-” appears beside the selected extender, indicating that the programs that match the extender can be viewed.

If you select “**Ⓢ**,” **Ⓢ** is displayed to show that the programs that match the extender will be blocked again.

Adjusting Your SET UP (menus) (continued)

10 Repeat steps 8 and 9 for other extenders.

All programs that match the ratings you select and higher, except for the extenders that were canceled, will be blocked.

11 After setting of the TV rating is complete, press \uparrow or \downarrow to select “ \supset ,” and press \oplus .

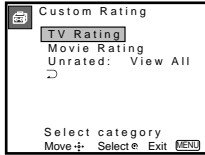

Second, select a movie rating.

12 Press \uparrow or \downarrow to select “Movie Rating,” and press \oplus .

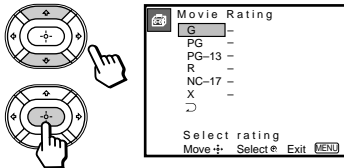

13 Press \uparrow or \downarrow to select the movie rating to be blocked, and press \oplus .

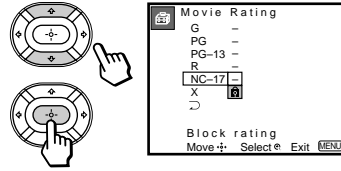

14 Press \uparrow or \downarrow to select “ \supset ,” and press \oplus . The \supset indicator automatically appears beside the selected rating and all “higher” ratings, indicating that the programs that match the ratings will be blocked.

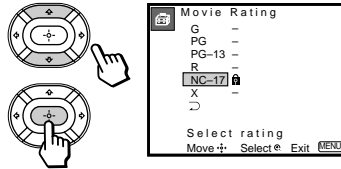

15 Press MENU to exit the menu.

To block TV programs and/or movies for which a rating signal is not given (NR and N/A)

For a description of the NR and N/A ratings, see page 44.

1 Perform steps 1–4 of “Selecting a Custom Rating in U.S.A.” on page 38.

2 Press \uparrow or \downarrow to select “Unrated,” and press \oplus .

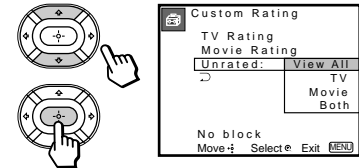

- 3 Press **▲** or **▼** to select the type of programs to be blocked, and press **(+)**.

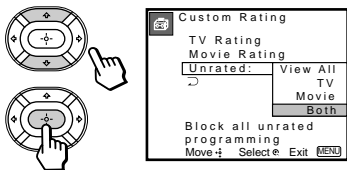

Selecting a Custom Rating in Canada

If you want to select the ratings to be blocked from “Custom” once you have activated the Parental Control feature (page 37), follow the procedure below.

For a detailed description of each rating, see “What the Ratings Mean” on pages 45 and 46.

- 1 Select “Parental Control” from the Set Up menu. (see page 34)

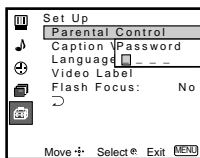

- 2 Enter your four digit password using the 0–9 buttons.

The Parental Control menu appears. Make sure that “Country” is set to “Canada.”

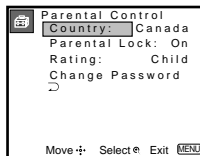

- 3 Press **▲** or **▼** to select “Rating,” and press **(+)**.

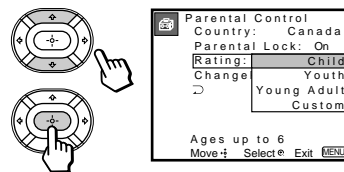

- 4 Press **▲** or **▼** to select “Custom,” and press **(+)**.

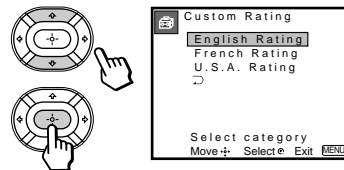

(continued)

- 4 Press **MENU** to exit the menu.

To block ...	Select ...
No program (to view any unrated TV program and movie)	View All
Unrated TV programs	TV
Unrated movies	Movie
Unrated TV programs and movies	Both

Adjusting Your SET UP (menus) (continued)

- 5 Press \uparrow or \downarrow to select the rating you want to block, and press \oplus .
The selected rating appears.

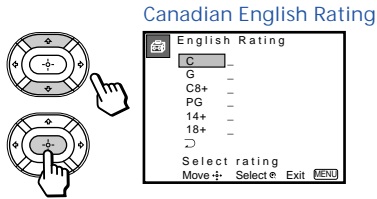

Canadian French Rating U.S. TV Rating

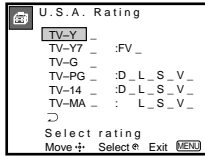
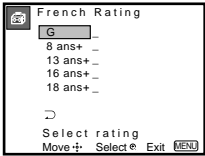

- 6 Press \uparrow or \downarrow to select the TV rating to be blocked, and press \oplus .

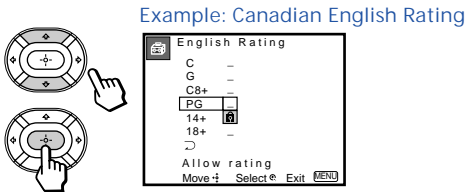

- 7 Press \uparrow or \downarrow to select “ \oplus ,” and press \oplus .
The \oplus indicator automatically appears beside the selected rating and all “higher” ratings, indicating that the programs that match the ratings will be blocked.

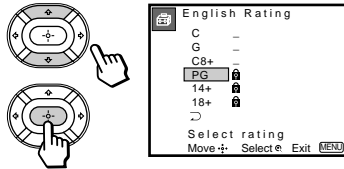

Some U.S. TV ratings have additional content ratings called “extended” as D, FV, L, S and V. By extended, see steps 7 and 40. For more information, see page 45.

All of the extended ratings will be blocked unless you wish to allow any of them to be viewed. To allow, go to step 8.

- 8 Press MENU to exit the menu.

Changing the

- 1 Select “Parent” menu. (see page 42)

- 2

- 4 Enter a new four digit password using the 0-9 buttons.

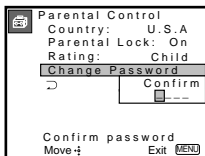

- 5 Enter the password set in step 4 again to confirm.

If you entered it incorrectly, “Password incorrect” appears.

Re-enter the correct password.

- 6 Press MENU to exit the menu.

If you have forgotten your password

In step 2 of “Changing the Password” on page 42, enter the master password “4357” (corresponding to “HELP” on a phone number pad). You can then store a new password.

Notes:

- If you entered “4357” as your password the first time, you cannot store a new password. (see step 2 of “Activating the Parental Control Feature” on page 36)
- When you select a Parental Control program and the  indicator is displayed on the screen, you cannot view that program even if you enter “4357.” (see “To unlock the Parental Control feature temporarily” on page 38)

What the Ratings Mean

Ratings in U.S.A.

Sony’s predetermined ratings

These are original ratings that Sony predetermined according to the viewer’s age. Each rating allows you to view the certain programs, as follows.

See pages 44 and 45 for a description of each rating.

Child: Suitable for children under the age of 6.

Viewable U.S. movie ratings: G, NR, and N/A
Viewable U.S. TV ratings: TV-Y, TV-G, and TV-NR

Youth: Suitable for children aged 7 and older.

Viewable U.S. movie ratings: G, PG, NR, and N/A
Viewable U.S. TV ratings: TV-Y, TV-Y7, TV-G, TV-PG, and TV-NR

Young Adult: Suitable for children aged 13 and older.

Viewable U.S. movie ratings: G, PG, PG-13, NR, and N/A
Viewable U.S. TV ratings: TV-Y, TV-Y7, TV-G, TV-PG, TV-14, and TV-NR

(continued)

Adjusting Your SET UP (menus) (continued)

U.S. movie ratings

U.S. movie ratings are for movies (including those shown on TV) rated according to the Motion Picture Association of America (MPAA) Guidelines.

G (General Audiences—All Ages Admitted): In G-rated films no strong words are used, the violence is at a minimum, nudity and sex scenes are not present, nor is there any drug use.

PG (Parental Guidance Suggested. Some Material May Not Be Suitable For Children): This is a film which may need to be monitored first by parents.

PG-13 (Parents Strongly Cautioned. Some Material May Be Inappropriate For Children Under 13): Parents are alerted to be very careful about the attendance of their under-teenage children when viewing.

R (Restricted, Under 17 Require Accompanying Parent Or Adult Guardian): This film includes hard language, tough violence, nudity, drug abuse or other elements of concern.

NC-17 or X (No One 17 Or Under Admitted.): This is a film that most parents would consider not suitable for children aged 17 and under. There may be violence, sex, aberrational behavior, drug abuse or other elements of concern.

NR (Not Rated): This is a film that a producer has not rated, intending to have his film widely released.

N/A (Not Applicable): This is a film that a producer considers outside the scope of the MPAA ratings.

Note:

- NR and N/A ratings are shown together as “Unrated” in the menu.

U.S. TV ratings

U.S. TV ratings are for TV programs rated according to the U.S. Television Parental Guidelines.

TV-Y (All Children): This program is designed for young children aged 2–6 and is appropriate for all children.

TV-Y7 (Directed to Older Children): This program is designed for children aged 7 and above. Themes and elements in this program may include mild fantasy violence or slapstick violence, or may frighten children under the age of 7.

TV-G (General Audience): Most parents would find this program suitable for all ages. It contains little or no violence, no strong language and little or no sexual dialog or situations.

TV-PG (Parental Guidance Suggested): This program contains some material that parents may find unsuitable for younger children.

TV-14 (Parents Strongly Cautioned): This program contains some material that many parents would find unsuitable for children under the age of 14.

TV-MA (Mature Audience Only): This program is specifically designed to be viewed by adults and therefore may be unsuitable for children under the age of 17.

TV-NR (Not Rated/Unrated): This is a program broadcast without any rating, such as news, news flashes or sports.

Note:

The TV-NR rating is shown as “Unrated” in the menu.

About the extenders of U.S. TV ratings TV-Y7, TV-PG, TV-14 and TV-MA ratings have additional content ratings called “extenders” to define additional viewing limits. The extenders are defined as follows:

D (sexually suggestive Dialog): Programs containing suggestive dialog, or sexual innuendo

FV (Fantasy Violence): Programs containing cartoon violence occurring in TV-Y7 programs only

L (coarse Language): Programs containing coarse language

S (Sexual situations): Programs containing sexual content

V (Violence): Programs containing violence There may be some profanity, violence or brief nudity in these programs.

Ratings in Canada

Sony's predetermined ratings

These are original ratings that Sony predetermined according to the viewer's age. Each rating allows you to view the certain programs, as follows.

See the right column and page 46 for a description of each rating.

Child: Suitable for children under the age of 7.

Viewable Canadian English Language ratings: C and G

Viewable Canadian French Language ratings: G

Viewable U.S. TV ratings: TV-Y, TV-G, and TV-NR

Youth: Suitable for children aged 8 and older.

Viewable Canadian English Language ratings: C, G, C8+ and PG

Viewable Canadian French Language ratings: G and 8 ans+

Viewable U.S. TV ratings: TV-Y, TV-Y7, TV-G, TV-PG, and TV-NR

Young Adult: Suitable for children aged 14 and older.

Viewable Canadian English Language ratings: C, G, C8+, PG and 14+

Viewable Canadian French Language ratings: G, 8 ans+, 13 ans+

Viewable U.S. TV ratings: TV-Y, TV-Y7, TV-G, TV-PG, TV-14, and TV-NR

Canadian English Language ratings

The Canadian English Language Ratings are for TV programs in English broadcast in Canada.

C (Programming intended for children under age 8): There will be no realistic scenes of violence or no offensive language, nudity or sexual content. Careful attention is paid to themes, which could threaten children's sense of security and well-being.

G (General Audience): Will contain very little violence, either physical or verbal or emotional. There may be some inoffensive slang, no profanity and no nudity.

(continued)

Adjusting Your SET UP (menus) (continued)

C8+ (Programming generally considered acceptable for children 8 years and over to watch on their own): Violence will not be portrayed as the preferred, acceptable, or only way to resolve conflict; or encourage children to imitate dangerous acts which they may see on television. There will be no profanity, nudity or sexual content.

PG (Parental Guidance): Programming intended for a general audience but which may not be suitable for younger children. Parents may consider some content inappropriate for unsupervised viewing by children aged 8 - 13.

14+ (Programming contains themes or content which may not be suitable for viewers under the age of 14): Parents are strongly cautioned to exercise discretion in permitting viewing by pre-teens and early teens.

18+ (Adult): May contain violence integral to the development of the plot, character or theme, intended for adult audiences. May contain graphic language and explicit portrayals of nudity and/or sex.

E (Exempt): Exempt programming includes: news, sports documentaries and other information programming; talk shows, music videos, and variety programming.

Note:

The E (Exempt) rating is not shown in the menu.

Canadian French Language ratings

The Canadian French Language Ratings are for TV programs in French broadcast in Canada.

G (General): Programming intended for audience of all ages. Contains no violence, or the violence it contains is minimal or is depicted appropriately with humor or caricature or in an unrealistic manner.

8 ans+ (8+ General - Not recommended for young children): Programming intended for a broad audience but contains light or occasional violence that could disturb young children. Viewing with an adult is recommended for young children (under the age of 8).

13 ans+ (Programming may not suitable for children under the age of 13): Viewing with an adult is strongly recommended for children under 13.

16 ans+ (Programming is not suitable for children under the age of 16): Contains frequent scenes of violence or intense violence.

18 ans+ (Programming restricted to adults): Contains constant violence or scenes of extreme violence.

E (Exempt): Exempt programming.

Note:

The E (Exempt) rating is not shown in the menu.

Operating Video Equipment

Setting the Manufacturer's Code

You can use the supplied remote control to operate Sony or non-Sony video equipment that has an infrared sensor.

Press CODE SET, DVD/VTR (FUNCTION), and the 0-9 buttons to enter the manufacturer's code number (see the following chart), then press ENTER.

For example, to operate a Sony 8mm VCR:



If the remote control doesn't work

- See the tips on page 49.

VCR manufacturer code numbers

Manufacturer	Code
Sony (VHS VCR)	301
Sony (8mm VCR)	302
Sony (Beta, ED Beta, VCRs)	303
Aiwa	338
Admiral (M. Ward)	327
Audio Dynamic	314, 337
Bell & Howell (M. Ward)	330
Broksonic	319, 317
Canon	309, 308
Citizen	332
Craig	302, 332
Curtis Mathis	304, 338, 309
Daewoo	341, 312, 309
DBX	314, 336, 337
Dimensia	304
Emerson	319, 320, 316, 317, 318, 341
Fisher	330, 335
Funai	338
General Electric	329, 304, 309
Go Video	340, 339, 322
Goldstar	332
Hitachi	306, 304, 305, 338
Instant Replay	309, 308
JC Penney	309, 305, 304, 330, 314, 336, 337
JVC	314, 336, 337
Kenwood	314, 336, 332, 337
LXI (Sears)	332, 305, 330, 335, 338
Magnavox	308, 309, 310
Marantz	314, 336, 337
Marta	332
Memorex	309, 335
Minolta	305, 304
Mitsubishi/MGA	323, 324, 325, 326
Multitech	325, 338, 321
NEC	314, 336, 337
Olympic	309, 308
Optimus	327
Panasonic	308, 309, 306, 307
Pentax	305, 304
Philco	308, 309
Philips	308, 309, 310
Pioneer	308
Quasar	308, 309, 306
RCA/PROSCAN	304, 305, 308, 309, 311, 329, 312, 313, 310
Realistic	309, 330, 328, 335, 324, 338
Sansui	314
Samsung	322, 313, 321
Sanyo	330, 335
Scott	312, 313, 321, 335, 323, 324, 325, 326
Sharp	327, 328
Signature 2000 (M. Ward)	338, 327
Sylvania	308, 309, 338, 310
Symphonic	338
SV2000	338
Tashiro	332
Tatung	314, 336, 337
Teac	314, 336, 338, 337
Technics	309, 308
Teknica	338
Toshiba	312, 311
Wards	327, 328, 335, 331, 332
Yamaha	330, 314, 336, 337
Zenith	331

Operating Video Equipment (continued)

MDP manufacturer code numbers

Manufacturer	Code
Sony	701
Panasonic	704, 710
Mitsubishi	702

DVD Player manufacturer code numbers

Manufacturer	Code
Sony	751
Panasonic	753
Pioneer	752
RCA	755
Toshiba	754

Tips

- In some rare cases, you may not be able to operate your non-Sony video equipment with the supplied remote control. In this case, please use the equipment's own remote control.
- When you remove the batteries, the code number may revert to the factory setting.

To operate video equipment

- 1 Press DVD/VTR (FUNCTION).
- 2 Use the VCR/DVD/MDP operation buttons indicated in the following tables.

Operating a VCR using the remote control

To turn On/Off	Press DVD/VTR (POWER). [Green Button]
To select a channel	Press the 0 – 9 buttons.
To change channels	Press CH +/-.
To record	Press ▶ while pressing ● .
To play	Press ▶ .
To stop	Press ■ .
To fast forward	Press ▶▶ .
To rewind the tape	Press ◀◀ .
To pause	Press . Press again to resume normal playback.
To search the picture forward or backward	Press ▶▶ or ◀◀ during playback. Release to resume normal playback.
To change input mode	Press TV/VTR.

Operating an MDP using the remote control

To turn On/Off	Press DVD/VTR (POWER). [Green Button]
To play	Press ▶ .
To stop	Press ■ .
To pause	Press . Press again to resume normal playback.

To search the picture forward or backward	Press ▶▶ or ◀◀ during playback. Release to resume normal playback.
---	--

To search a chapter forward or backward	Press CH +/-.
---	---------------

Operating a DVD Player using the remote control

To turn On/Off	Press DVD/VTR (POWER). [Green Button]
To play	Press ▶ .
To stop	Press ■ .
To pause	Press . Press again to resume normal playback.
To step through different tracks of an audio disc	Press ▶▶ to step forward or ◀◀ to step backward.
To step through different chapters of a video disc	Press CH + to step forward or CH – to step backward.
To select tracks directly	Press 0-9 buttons.
To display the menu (Set up)	Press MENU.

Operating a Cable Box or Satellite Receiver (SAT)

Setting the Manufacturer's Code

You can program the supplied remote control to operate a cable box or satellite receiver.

Press CODE SET, SAT/CABLE (FUNCTION), and the 0-9 buttons to enter the manufacturer's code number (see the following chart), then press ENTER.

For example, to operate a Sony satellite receiver:

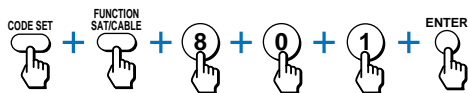

Manufacturer code numbers (cable box)

Manufacturer	Code
Hamlin/Regal	222, 223, 224, 225, 226
Jerrold/G.I	201, 202, 203, 204, 205, 222, 206, 207, 208, 218
Oak	227, 228, 229
Panasonic	219, 220, 221
Pioneer	214, 215
Scientific Atlanta	209, 210, 211
Tocom	216, 217
Zenith	212, 213

Manufacturer code numbers (satellite receiver)

Manufacturer	Code number
Sony	801 (preset code for remote control)
General Electric	802, 808
Hitachi	805
Hughes	804
Panasonic	803
RCA/PROSCAN	802
Toshiba	806, 807

To operate the cable box or satellite receiver (SAT)

- 1 Press SAT/CABLE (POWER) [Green Button] to turn on/off the cable box or satellite receiver.
- 2 Press SAT/CABLE (FUNCTION).
- 3 For other operations, refer to the operating instructions that come with the equipment. The GUIDE and INDEX (blue-labeled) buttons can be used only with a satellite receiver.

If the remote control doesn't work

- Try repeating the set up procedures using the other codes listed for your equipment.

To operate the projection TV Press TV (FUNCTION). Then use the projection TV control buttons to control the projection TV.

Tips

- If more than one code number is listed, try entering them one by one until you come to the correct code for your equipment.
- If you enter a new code number, the code number you previously entered at that setting is erased.
- In some rare cases, you may not be able to operate your equipment with the supplied remote control. In this case, use the equipment's own remote control unit.
- Whenever you remove the batteries — to replace them, for example — if too much time is taken, the code numbers may revert to the factory setting and must be reset.

If, after reading the following instructions, you have additional questions related to the use of your Sony projection TV, please call one of the following numbers (English only).

Customers in the continental United States contact the Direct Response Center at: 1-800-222-SONY (7669)

Customers in Canada contact the Customer Relations Center at: (416) 499-SONY (7669)

The picture turns off and the TIMER/STAND BY indicator on the front panel flashes (self-diagnosis function)	<ul style="list-style-type: none">• The projection TV is equipped with a self-diagnosis function. If there is a problem with your projection TV, the TIMER/STAND BY indicator on the front panel will flash repeatedly. Counting the number of flashes helps you inform qualified Sony personnel of the projection TV's condition.• Press POWER on the projection TV to turn it off, then inform qualified Sony personnel or the above Direct Response Center of the number of flashes.
No picture (screen not lit), no sound	<ul style="list-style-type: none">• Make sure the power cord is plugged in.• Operate with the buttons on both the projection TV and the remote control.• Check to see if the TV/VIDEO setting is correct: when watching TV, set to TV, and when watching video tapes, set to VIDEO 1, 2, or 3.• Try another channel. <i>It could be station trouble.</i>• Perform AUTO SET UP again using the SET UP button to return to the factory preset condition. (see "To perform AUTO SET UP again" on page 19)• The Parental Control feature is activated. (see "To deactivate the Parental Control feature" on page 37)
Remote control does not operate	<ul style="list-style-type: none">• Batteries could be weak. Replace the batteries.• Press TV (FUNCTION) when operating your projection TV.• Make sure the projection TV's power cord is connected securely to the wall outlet.• Locate the projection TV at least 3-4 feet away from fluorescent lights.• Check the polarity of the batteries.
Dark, poor or no picture (screen lit), good sound	<ul style="list-style-type: none">• Adjust "Picture" in the Video menu. (see "Picture Adjustment" on page 26)• Adjust "Brightness" in the Video menu. (see "Picture Adjustment" on page 26)• Check antenna/cable connections.• Perform AUTO SET UP again using the SET UP button to return to the factory preset condition. (see "To perform AUTO SET UP again" on page 19)• Adjust the convergence again using the FLASH FOCUS button. (see "Adjusting the Convergence Automatically (FLASH FOCUS)" on page 19)
Good picture, no sound	<ul style="list-style-type: none">• Press MUTING so that "Muting" disappears from the screen. (see "MUTING" on page 20)• Check the MTS/SAP setting in the Audio menu. (see "MTS/SAP" on page 27)• Make sure "Speaker" is set to "On" in the Audio menu. (see "Speaker" on page 28)• Perform AUTO SET UP again using the SET UP button to return to the factory preset condition. (see "To perform AUTO SET UP again" on page 19)

Cannot receive upper channels (UHF) when using an antenna	<ul style="list-style-type: none"> • Make sure "Cable" is "Off" in the Channel Set Up menu. (see "Cable" on page 31) • Use "Auto Program" to add receivable channels that are not presently in the TV's memory. (see "Auto Program" on page 31)
No color	<ul style="list-style-type: none"> • Adjust "Color" in the Video menu. (see "Picture Adjustment" on page 26) • Black and white programs cannot be seen in color. • Perform AUTO SET UP again using the SET UP button to return to the factory preset condition. (see "To perform AUTO SET UP again" on page 19)
Only snow and noise appear on the screen	<ul style="list-style-type: none"> • Check the "Cable" setting in the Channel Set Up menu. (see "Cable" on page 31) • Check the antenna/cable connections. • Make sure the channel is broadcasting programs. • Press ANT to change the input mode. (see "ANT" on page 22)
Dotted lines or stripes	<ul style="list-style-type: none"> • Adjust the antenna. • Keep the projection TV away from noise sources such as cars, neon signs or hair-dryers.
TV is fixed to one channel	<ul style="list-style-type: none"> • Use "Auto Program" to add receivable channels that are not presently in TV's memory. (see "Auto Program" on page 31)
Double images or ghosts	<ul style="list-style-type: none"> • Use a highly directional outdoor antenna or a cable (when the problem is caused by reflections from nearby mountains or tall buildings).
Cannot operate the menu	<ul style="list-style-type: none"> • If the item you want to choose appears in gray, you cannot select it. • Press the projection TV's power button off and on again.
Cannot receive any channels when using cable TV	<ul style="list-style-type: none"> • Make sure "Cable" is "On" in the Channel Set Up menu. (see "Cable" on page 31) • Use "Auto Program" to add receivable channels that are not presently in the TV's memory. (see "Auto Program" on page 31)
Cannot gain enough volume when using a cable box	<ul style="list-style-type: none"> • Increase the volume at the cable box. Then press TV (FUNCTION) and adjust the projection TV's volume.
Favorite Channel does not display your choices	<ul style="list-style-type: none"> • Verify that "Favorite Channel" is set to "Manual" in the Channel Set Up menu. (see "Setting Favorite Channel manually" on page 32)
Some video sources do not appear when you press TV/VIDEO	<ul style="list-style-type: none"> • Ensure that "Video Label" is not set to "Skip." (see "Video Label" on page 35)
Recording through MONITOR OUT does not function properly when recording in PIP mode	<ul style="list-style-type: none"> • MONITOR OUT will not record both images in PIP. Only the main picture will be recorded. • If you are recording the main picture and you switch to the sound of the sub picture using the AUDIO button, the main picture will be recorded with sound from the other program.
Cannot play shooting games	<ul style="list-style-type: none"> • Some shooting games which involve pointing a light beam at the TV screen with an electronic gun or rifle cannot be used with this projection TV. For details, see the instruction manual supplied with the video game software.

Specifications

Projection system

3 picture tubes, 3 lenses, horizontal in-line system

Picture tube

7-inch high-brightness monochrome tubes (6.3 raster size), with optical coupling and liquid cooling system

Projection lenses

High performance, large diameter hybrid lens F1.05

Television system

American TV standard

Channel coverage

VHF: 2-13/UHF: 14-69/CATV: 1-125

Antenna

75 ohm external terminal for VHF/UHF

Screen size (measured diagonally)

43 inches (KP-43T75)

48 inches (KP-48S75)

53 inches (KP-53S75/53N77)

61 inches (KP-61S75)

Inputs/outputs

VIDEO 1 IN

VIDEO 2 INPUT

S VIDEO IN (4-pin mini DIN):

Y: 1 Vp-p, 75-ohms unbalanced, sync negative

C: 0.286 Vp-p (Burst signal), 75 ohms

VIDEO (phono jack): 1 Vp-p, 75-ohms unbalanced, sync negative

AUDIO (phono jacks): 500 mVrms (100% modulation), Impedance: 47 kilohms

VIDEO 3 IN

S VIDEO IN (4-pin mini DIN):

Y: 1 Vp-p, 75-ohms unbalanced, sync negative

C: 0.286 Vp-p (Burst signal), 75 ohms

VIDEO (phono jack): 1 Vp-p, 75-ohms unbalanced, sync negative

Y: 1 Vp-p, 75 ohms, sync negative

Pr: 0.7 Vp-p, 75 ohms

Pr: 0.7 Vp-p, 75 ohms

AUDIO (phono jacks): 500 mVrms (100% modulation), Impedance: 47 kilohms

MONITOR OUT

VIDEO (phono jack): 1 Vp-p, 75-ohms unbalanced, sync negative

AUDIO (phono jacks): 500 mVrms (100% modulation), Impedance: 470 ohms

AUDIO (VAR/FIX) OUT (phono jacks): 500 mVrms (100% modulation), Impedance: 470 ohms

CONTROL S OUT: minijack

Speaker

Tweeter: 66 mm (2 5/8") × 2 (KP-53N77)

Woofers:

130 mm (5 1/8") × 2 (KP-53N77)

100 mm (4") × 2 (KP-43T75/48S75/53S75/61S75)

Speaker output

17W × 2 (KP-43T75/48S75/53S75/61S75)

20 W × 2 (KP-53N77)

Power requirement

120 V AC, 60 Hz

Power consumption

In use (Max.): 160 W

In standby: 1 W

Dimensions (W/H/D)

965 × 1,058 × 510 mm (38 × 41 5/8 × 20 1/8 inches) (KP-43T75)

1,105 × 1,338 × 579 mm (43 1/2 × 52 5/8 × 22 3/4 inches) (KP-48S75)

1,216 × 1,417 × 632 mm (47 7/8 × 55 3/4 × 24 7/8 inches) (KP-53S75)

1,216 × 1,417 × 632 mm (47 7/8 × 55 3/4 × 24 7/8 inches) (KP-53N77)

1,370 × 1,560 × 670 mm (54 × 61 3/8 × 26 3/8 inches) (KP-61S75)

Mass

64.6 kg (142 lbs 5 oz) (KP-43T75)

64 kg (141 lbs 2 oz) (KP-48S75)

67.6 kg (149 lbs) (KP-53S75)

75.2 kg (165 lbs 13 oz) (KP-53N77)

84.6 kg (186 lbs 8 oz) (KP-61S75)

Supplied accessories

Remote control RM-Y906 (1)

Batteries (2) size AA (R6)

Optional accessories



Connecting cables

RK-G34, RK-74A, RK-G69HG, VMC-10HG, VMC-720M, VMC-810S/820S, YC-15V/30V

U/V mixer EAC-66

Design and specifications are subject to change without notice.

A

Adjusting sliders	26, 27
ANT button	22, 24
Antenna cable	9
Antenna connector	8
Audio  button	22
Audio menu operations 	27, 28
Audio Out	28
(Fixed/Variable)	
Audio/Video cable	8
Auto Program	19, 31
AUTO SET UP	18
Auto Volume	27
AUX Hookup	9, 24

B

Balance	27
Bass	27
Battery installation	18
Brightness	26

C

Cable	31
Cable box	
connection	9, 10
operation	49
Caption Vision 	22, 34
CATV cable	9
CH +/-	20, 24
CHANNEL +/-	18, 19
Channel Caption	30

Channel Set Up menu operations 

.....	30, 31
Channel Skip/Add	31
Coaxial cable	8, 9, 10, 12
Color	26
Connecting Projection TV to	
antenna	8
audio system	16
cable	8
cable box	9
cable box and VCR	10
camcorder	13
DTV receiver	13
DVD Player	15
satellite receiver (SAT)	11
satellite receiver (SAT) and	
VCR	12
Sony SAVA series speaker	
system	17
two VCRs	14
VCR	10
CONTROL S OUT jack	8
Convergence	19
Current Time	29
D	
Daylight Savings	29
DISPLAY button	21
DVD	
connection	15
operation	48
DVD/VTR (FUNCTION)	48

E

Editing using MONITOR OUT	14
Effect	27
(BBE/Surround/Simulated/Off)	

F, G

Factory settings	26, 27
Favorite Channel	
Selecting	33
Setting	32
FLASH FOCUS	19, 35
FREEZE button	21, 24

H, I

Hook Ups	8
Hue	26

J, K

JUMP button	21
-------------------	----

L

Language	34
Learning menus	
Audio	27
Channel Set Up	30
Set Up	34
Timer	29
Video	26

M

Manufacturer code numbers	47-49
MDP operation	48
MENU button	25
Menu selection	25

Mode	20, 26
(Vivid/Standard/Movie/ Personal 1/Personal 2)	

Movie rating	40
MTS/SAP	22, 27
(Stereo/SAP/Mono)	
MUTING button	20

N

Noise Reduction	26
-----------------------	----



O

On/Off Timer	29
Operating video equipment	47

P, Q

Parental Control	34, 36
Parental Control menu	
Change Password	42
Country	36
Custom Rating	38, 41
Parental Lock	36, 37
Rating	37
Password	36
Picture	26
Picture Adjustment	26
(Picture/Brightness/Color/Hue/ Sharpness)	
Picture-in-Picture (PIP)	23
PICTURE MODE button	20
PIP operations	
ACTIVE 	23
AUDIO	24

Index (continued)

CH+/-	24	Sharpness	26	V, W
FREEZE	24	Skip/Add	31	VCR
PIP	23	SLEEP button	22	connection
POSITION	23	Sliders	26, 27	operation
SWAP	24	Speaker	28	Video Label
TV/VIDEO	23	(On/Off/SAVE SP)		Video menu operations 
R		Specifications	52	VOL +/-
Remote control	18	Splitter	10	VOLUME +/-
Graphic Illustration ... (inside cover)		SYSTEM OFF button	22	X
RESET button	26, 27	Surround	27	XDS
S		SWAP button	24	Y, Z
S Video cable	8	T, U		Y/P _B /P _R
Safety	2	Timer menu operations 	29	
SAP	27	Treble	27	
SAT/CABLE (FUNCTION)	49	Troubleshooting	50, 51	
Satellite receiver (SAT) operation ...	49	TV (FUNCTION) button	20	
SET UP button	19	TV POWER button	20	
Set Up menu operations 	34, 35	TV rating	39	
Setting Up the Projection TV		TV/VIDEO button	21, 23	
Automatically	18	TV/VTR button	22	

Sony  line <http://www.world.sony.com/>

Printed in U.S.A.

If, after reading this instruction manual, you have additional questions related to the use of your Sony projection TV, please call one of the following numbers (English only).

Customers in the continental United States contact the Direct Response Center at:
1-800-222-SONY (7669)

Customers in Canada contact the
Customer Relations Center at:
(416) 499-SONY (7669)

Free Manuals Download Website

<http://myh66.com>

<http://usermanuals.us>

<http://www.somanuals.com>

<http://www.4manuals.cc>

<http://www.manual-lib.com>

<http://www.404manual.com>

<http://www.luxmanual.com>

<http://aubethermostatmanual.com>

Golf course search by state

<http://golfingnear.com>

Email search by domain

<http://emailbydomain.com>

Auto manuals search

<http://auto.somanuals.com>

TV manuals search

<http://tv.somanuals.com>