

# ***Data Projector***

---

Operating Instructions

***VPL-CX20***  
***VPL-CS20***

---

# Table of Contents

---

## **Overview**

Features .....	3
Location and Function of Controls ....	4
Top/Front/Left Side .....	4
Rear/Right Side/Bottom .....	4
Control/Connector Panel .....	5
Remote Commander .....	6

---

## **Projecting the Picture**

Installing the Projector .....	8
Connecting the Projector .....	9
Connecting a Computer .....	9
Connecting a VCR .....	10
Projecting .....	11
Turning Off the Power .....	14

---

## **Convenient Functions**

Selecting the Menu Language .....	15
Security Lock .....	16
Other Functions .....	18
Off & Go Function .....	18
Effective Tools for Your Presentation .....	18

---

## **Adjustments and Settings Using a Menu**

Using a MENU .....	20
The Picture Menu .....	22
The Signal Menu .....	23
The Function Menu .....	25
The Installation Menu .....	27

The Setup Menu .....	29
The Information Menu .....	30

---

## **Maintenance**

Replacing the Lamp .....	32
Cleaning the Air Filter .....	34

---

## **Others**

Troubleshooting .....	35
Messages List .....	38
Specifications .....	40
Index .....	44

---

# Features

---

## High brightness, high picture quality

### High brightness

Adopting Sony's unique new optical system that incorporates newly developed LCD panels provides a high-efficiency optical system. It allows the 165 W UHP lamp to give a light output of 2000 ANSI lumen.

### High picture quality

VPL-CX20: Three super-high-aperture 0.63-inch XGA panels with approximately 790,000 effective pixels, produce a resolution of 1024 × 768 dots (horizontal/vertical) for RGB input, and 750 horizontal TV lines for video input.

VPL-CS20: Three super-high-aperture 0.63-inch SVGA panels with approximately 480,000 effective pixels, produce a resolution of 800 × 600 dots (horizontal/vertical) for RGB input, and 600 horizontal TV lines for video input.

---

## Compact and lightweight

The projector is light because the weight is only about 1.9 kg, and the body is designed to be thin. This makes the projector convenient for carrying.

---

## Easy setup and simple operation

### Advanced Intelligent Auto-setup function with auto focus adjustment

Simply press the power key, and the projector automatically performs the setups required before use. The projector corrects the V Keystone, adjusts the focus automatically, detects a signal, and sets optimum conditions for projection.

### Powered zoom/focus equipped

The projector is equipped with a powered zoom and powered focus lens, allowing you to adjust the size and focus of an image with the Remote Commander away from the projector.

## Short focal lens

The projection distance is very short, approximately 2.3 m (7.6 feet), when projecting an 80-inch image, which allows projection on a larger screen even in a limited space.

---

## Off & Go feature

The cooling fan built into the projector will work even after the power is turned off and the power cord is disconnected. This enables you to move the projector to another location immediately after turning it off.

---

## Security Functions

### Security lock

This function makes it possible to prevent projection of a picture on the screen unless the required password is entered when the projector is turned on.

### Panel key lock

This function locks all the keys on the control panel of the projector, allowing use of the keys on the Remote Commander. This prevents the projector from operating incorrectly.

---

## About Trademarks

- Adobe Acrobat is a trademark of Adobe Systems Incorporated.
- Windows is a registered trademark of Microsoft Corporation in the United States and/or other countries.
- VGA, SVGA, XGA and SXGA are registered trademarks of the International Business Machines Corporation, U.S.A.
- Kensington is a registered trademark of Kensington Technology Group.
- Macintosh is a registered trademark of Apple Computer, Inc.
- VESA is a registered trademark of the Video Electronics Standard Association.
- Display Data Channel is a trademark of the Video Electronics Standard Association.

# Location and Function of Controls

## Top/Front/Left Side

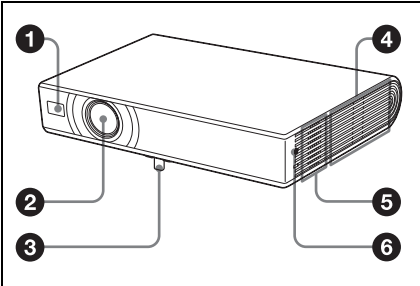

## Rear/Right Side/Bottom

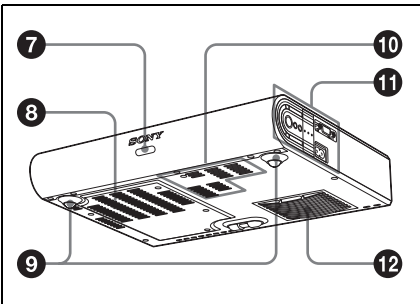

**1 Front remote control detector**

**2 Lens**

**3 Powered tilt adjuster**

**4 Ventilation holes (exhaust)**

**5 Speaker**

**6 Security lock**

Connects to an optional security cable (from Kensington).

Web page address:  
<http://www.kensington.com/>

**7 Rear remote control detector**

**8 Ventilation holes (intake)/Lamp cover**

**9 Adjusters (hind pad)**

Turn the appropriate adjuster to the right or left for minor tilt adjustment of the projected picture.

**10 Ventilation holes (intake)**

**11 Control/Connector Panel**

For details, see "Control/Connector Panel" on page 5.

**12 Ventilation holes (intake)/Air filter cover**

### Notes

- Do not place anything near the ventilation holes as this may cause internal heat build-up.
- Do not place your hand near the ventilation holes as this may cause injury.
- To maintain optimal performance, **clean the air filter every 500 hours.**

For details, see "Cleaning the Air Filter" on page 34.

## Control/Connector Panel

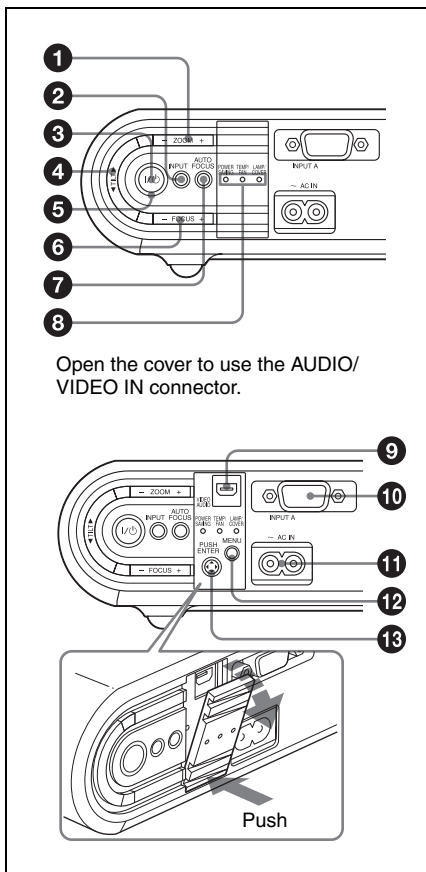

Open the cover to use the AUDIO/VIDEO IN connector.

### 1 ZOOM +/- key

Adjusts the picture size.

### 2 INPUT key

### 3 I/⏻ (On/Standby) key

Turns on the projector when the projector is in standby mode. The ON/STANDBY indicator around the I/⏻ key flashes in green until the projector is ready to operate.

### 4 TILT adjustment key

Adjusts the tilt of the projector.  
For details, see "Projecting" on page 11.

### 5 ON/STANDBY indicator (located around the I/⏻ key)

Lights up or flashes under the following conditions:

- Lights in red when the AC power cord is plugged into a wall outlet. Once the projector is in standby mode, you can turn it on with the I/⏻ key.
- Lights in green when the power is turned on, and when it is ready to operate.
- Flashes in green from the projector is turned on until the projector is ready to operate. Also, flashes in green while the cooling fan is running after the power is turned off with the I/⏻ key. The fan runs for about 45 seconds after the power is turned off.

For details, see page 14.

### 6 FOCUS +/- key

Adjusts the picture focus manually.

### 7 AUTO FOCUS key

Adjusts the picture focus automatically.

### 8 Status indicators

#### • POWER SAVING

Lights when the projector is in power saving mode.

#### • TEMP (Temperature)/FAN

Lights or flashes under the following conditions:

- Lights when the temperature inside the projector becomes unusually high.
- Flashes when the fan is broken.

#### • LAMP/COVER

Lights or flashes under the following conditions:

- Lights when the lamp has reached the end of its life or reaches a high temperature.
- Flashes when the lamp cover or air filter cover is not secured firmly.

For details, see page 37.

### 9 AUDIO/VIDEO connector

Connects to the audio output and video output, or S video output (Y/C video output) of the video equipment or the computer.

- 10 INPUT A connector (HD D-sub 15-pin, female)**  
Inputs a computer signal, video GBR signal, component signal, or DTV signal depending on the connected equipment. Connects to the output connector of equipment using the supplied cable or an optional cable.  
*For details, see “Connecting a Computer” on page 9 and “Connecting a VCR” on page 10.*

- 11 AC IN socket**  
Connects the supplied AC power cord.

- 12 MENU key**  
Displays the on-screen menu. Press again to clear the menu.

- 13 ENTER/Arrow (▲/▼/◀/▶) keys**  
Used to enter the settings of items in the menu system, select a menu, or make various adjustments. Press the center of the key when you use this key as the ENTER key.

## Remote Commander

The keys that have the same names as those on the control panel function identically.

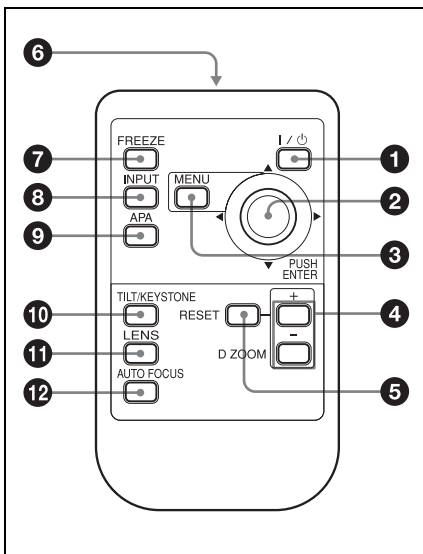

- 1 I/⏻ (On/Standby) key**
- 2 ENTER/▲/▼/◀/▶ (Arrow) keys**
- 3 MENU key**
- 4 D ZOOM (Digital Zoom) +/- keys**  
Enlarge the image at a desired location on the screen.
- 5 RESET key**  
Resets the value of an item to its factory preset value or returns the enlarged image to its original size. This key functions when the menu or a setting item is displayed on the screen.
- 6 Infrared transmitter**
- 7 FREEZE key**  
Freezes the projected picture. To cancel the frozen picture, press the key again.
- 8 INPUT key**
- 9 APA (Auto Pixel Alignment) key**  
Automatically adjusts a picture to its clearest while a signal is input from a computer.

*For details, see “Smart APA” in “The Function Menu” on page 25.*

- 10 TILT/KEYSTONE (Trapezoidal distortion correction) key**  
Adjusts the tilt of the projector, or the trapezoidal distortion of the image manually. Each time you press this key, the Tilt menu and the V Keystone menu are displayed in turn. Use the arrow keys (▲/▼/◀/▶) for adjustment.
- 11 LENS key**  
Each time you press this key, the Lens Focus adjustment and Lens Zoom adjustment menus are displayed alternately.
- 12 AUTO FOCUS key**  
Adjusts the picture focus automatically.

---

## Before using the Remote Commander

Pull out the clear film from the lithium battery holder.

---

### To replace a battery

- 1 Release the lock of the lithium battery holder by picking it, and pull out the holder from the Remote Commander.

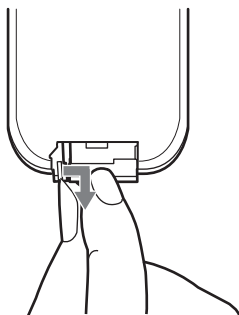

- 2 Install the lithium battery.

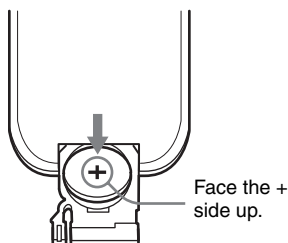

- 3 Put the lithium battery holder back into the Remote Commander.

### Notes on the lithium battery

- A button type lithium battery (CR2025) is used in the Remote Commander. Do not use batteries other than CR2025.
- Keep the lithium battery out of the reach of children.
- Should the battery be swallowed, immediately consult a doctor.

### Notes on Remote Commander operation

- Make sure that nothing obstructs the infrared beam between the Remote Commander and the remote control detector on the projector. Direct the Remote Commander toward the remote control detector.
- The operation range is limited. The shorter the distance between the Remote Commander and the remote control detector is, the wider the angle within which the commander can control the projector becomes.

# Installing the Projector

The distance between the lens and the screen varies depending on the size of the screen. Use the following table as a guide.

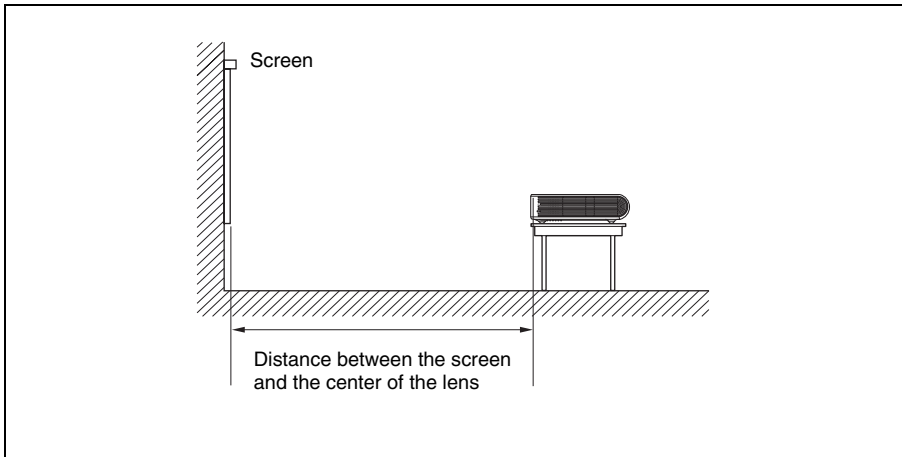

Unit: m (feet)

Screen size (inches)	40	80	100	150
Minimum Distance	1.2 (3.8)	2.3 (7.6)	2.9 (9.6)	4.4 (14.4)
Maximum Distance	1.4 (4.6)	2.8 (9.4)	3.6 (11.7)	5.4 (17.6)

There may be a slight difference between the actual value and the design value shown in the table above.



# Connecting the Projector

**When you connect the projector, make sure to:**

- Turn off all equipment before making any connections.
- Use the proper cables for each connection.
- Insert the cable plugs firmly; loose connections may increase noise and reduce performance of picture signals. When pulling out a cable, be sure to pull it out by the plug, not the cable itself.

## Connecting a Computer

This section describes how to connect the projector to a computer. For more information, refer to the computer's instruction manual.

## To connect a computer

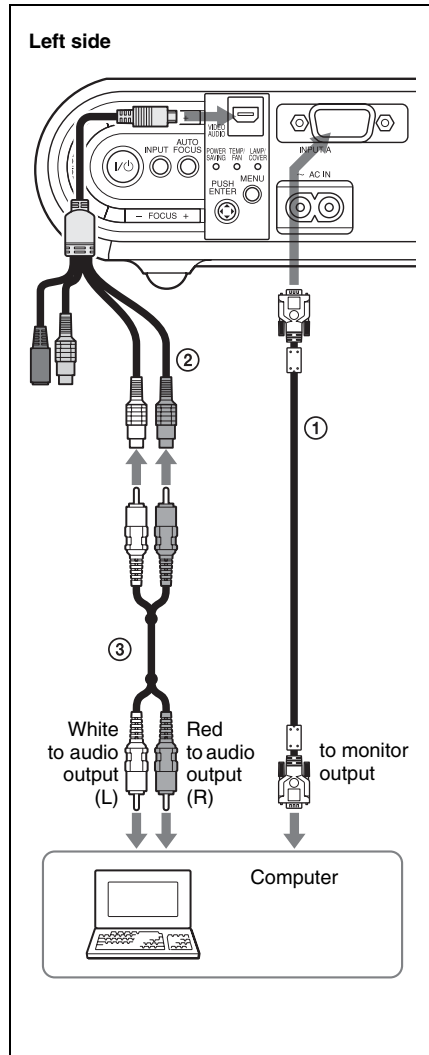

- ① HD D-sub 15-pin cable (supplied)
- ② A/V connecting adaptor (supplied)
- ③ Audio cable (not supplied) (Connect only when you want to output the audio from the speaker of the projector.)

## Notes

- The projector accepts VGA, SVGA, XGA, SXGA, and SXGA+ signals. However, we recommend that you set the output mode of your computer to XGA (VPL-CX20) or

SVGA (VPL-CS20) mode for the external monitor.

- If you set your computer, such as a notebook computer, to output the signal to both your computer's display and the external monitor, the picture of the external monitor may not appear properly. Set your computer to output the signal to only the external monitor.

*For details, refer to the operating instructions supplied with your computer.*

#### Note

To connect a Macintosh computer equipped with a video output connector of a type having two rows of pins, use a commercially available plug adaptor.

### Connecting a VCR

This section describes how to connect the projector to a VCR.

For more information, refer to the instruction manuals of the equipment you are connecting.

### To connect to a video or S video output connector

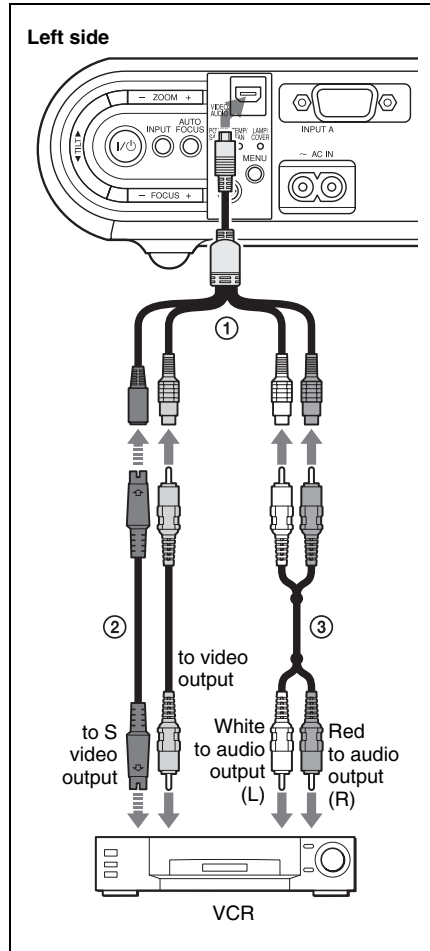

- ① A/V connecting adaptor (supplied)
- ② S-video cable (not supplied) or Video cable (not supplied)
- ③ Stereo audio connecting cable (not supplied)  
(Use a no-resistance cable.)

#### Note

Connect either a video or S video output connector.

**To connect to a video GBR/  
Component output connector**

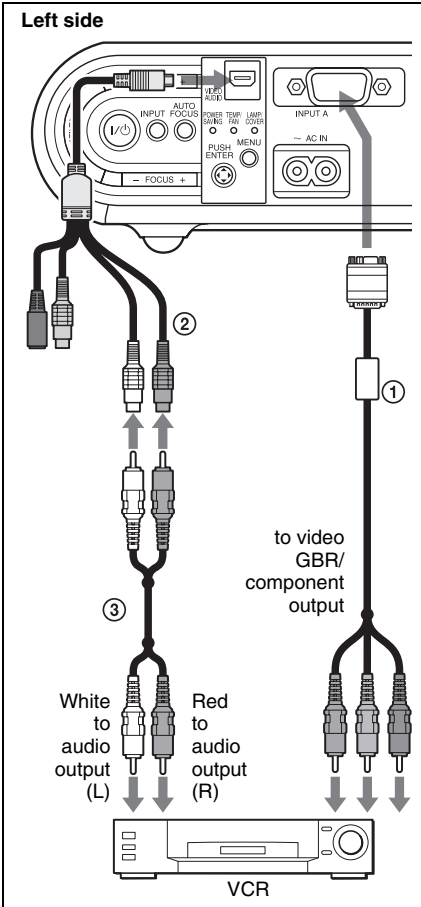

- ① SMF-402 Signal Cable (not supplied)  
HD D-sub 15-pin (male) ↔ 3 × phono jack
- ② A/V connecting adaptor (supplied)
- ③ Stereo audio connecting cable (not supplied)  
(Use a no-resistance cable.)

**Note**

Set the aspect ratio using “Wide Mode” on the Signal menu according to the input signal.

# Projecting

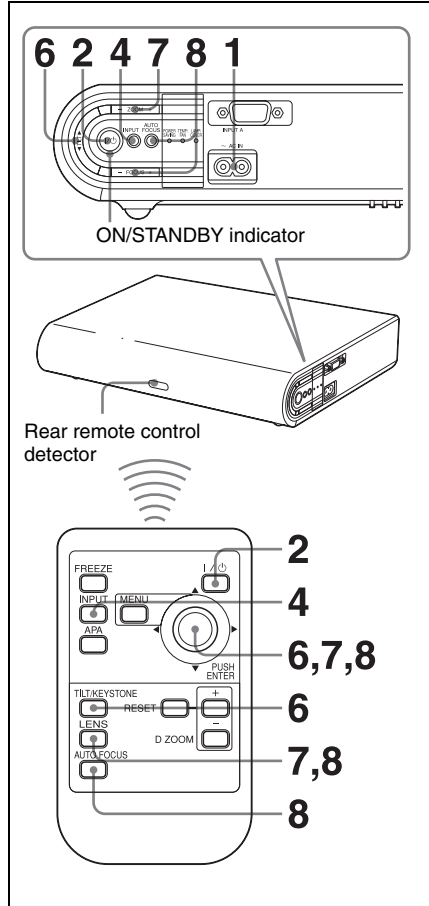

- 1** Plug the AC power cord into a wall outlet, then connect all equipment. The ON/STANDBY indicator lights in red and the projector goes into standby mode.
- 2** Press the I/⏻ key. The ON/STANDBY indicator flashes in green and the Advanced Intelligent Auto-setup starts. The powered tilt adjuster rises and stops at the previously adjusted position and adjusts the focus.

### Note

The projection size that can be adjusted with the automatic focus adjustment is from 40-inch up to 150-inch. However, it may not be perfectly adjusted depending on the brightness of the room, or the state of the screen. In this case, adjust it manually in step 8 on page 13.

- Turn on the equipment connected to the projector.
- Press the INPUT key to select the input source.  
Each time you press the key, the input signal switches as follows:

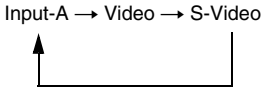

To input from	Press INPUT to display
Computer connected to the INPUT A connector	Input-A
Video equipment connected to the AUDIO/VIDEO input connector	Video
Video equipment connected to the AUDIO/S-Video input connector	S-Video

Smart APA (Auto Pixel Alignment) adjusts the picture of the connected equipment so that it is projected clearly.



### Notes

- If “Auto Input Search” is set to “On,” the projector searches for the signals from the connected equipment and displays the input channel where the input signals are found.

*For details, see “Auto Input Search” on page 25.*

- The Smart APA feature is effective for the input signal from a computer only.

- Switch the equipment connected to output to the projector.

Depending on the type of your computer, for example a notebook, or an all-in-one LCD type, you may have to switch the computer to output to the projector by pressing certain keys (e.g., / , , etc.), or by changing your computer’s settings.

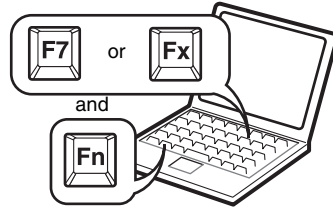

### Note

The key used for switching the computer to output to the projector varies depending on the type of computer.

- Adjust the upper or lower position of the picture.

#### To adjust using the Remote Commander

Press the TILT/KEystone key on the Remote Commander to display the Tilt menu and adjust the tilt using the ▲/▼/◀/▶ keys.

#### To adjust using the control panel on the left side of the projector

Press ▲ or ▼ of the TILT key to adjust the tilt of the projector.

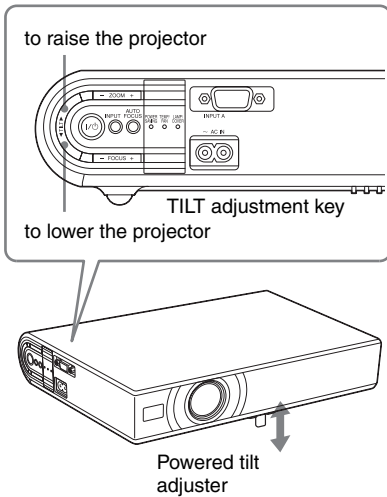

### Notes

- When you adjust the powered tilt adjuster with the TILT key, the V keystone adjustment is performed at the same time. If you do not want to perform the automatic keystone adjustment, set the V Keystone menu to “Manual.” (See page 27.)
- If you set the “V Keystone” adjustment to “Auto,” the “V Keystone” correction is automatically adjusted. However, it may not be perfectly adjusted depending on the room temperature or the screen angle. In this case, adjust it manually. Press the TILT/KEYSTONE key on the Remote Commander until “V Keystone” appears on the screen, and adjust the value with the ▲/▼/◀/▶ key. The corrected value is effective until the power is turned off.
- Be careful not to let the projector down on your fingers.
- Do not push hard on the top of the projector with the powered tilt adjuster extended. It may cause a malfunction.

## 7 Adjust the size of the picture.

### To adjust using the Remote Commander

Press the LENS key on the Remote Commander to display the Lens Zoom menu and adjust the size of the picture using the ▲/▼/◀/▶ keys.

### To adjust using the control panel on the left side of the projector

Press the ZOOM +/- keys on the projector to adjust the size of the picture.

## 8 Adjust the focus.

### To adjust the focus automatically

Press the AUTO FOCUS key on the left side of the projector or on the Remote Commander.

### To adjust the focus manually

### To adjust the focus using the Remote Commander:

Press the LENS key on the Remote Commander to display the Lens Focus menu and adjust the focus using the ▲/▼/◀/▶ keys.

### To adjust using the control panel on the left side of the projector:

Press the FOCUS +/- keys to adjust the focus.

---

# Turning Off the Power

- 1 Press the I/⏻ key.  
“POWER OFF? Please press I/⏻ key again.” appears to confirm that you want to turn off the power.

## Note

The message disappears if you press any key other than the I/⏻ key, or if you do not press any key for five seconds.

- 2 Press the I/⏻ key again.  
The powered tilt adjuster is retracted into the projector. The ON/STANDBY indicator flashes in green and the fan continues to run to reduce the internal heat. Also, the ON/STANDBY indicator flashes quickly for the first 45 seconds. During this time, you will not be able to light up the ON/STANDBY indicator again with the I/⏻ key.
- 3 Unplug the AC power cord from the wall outlet after the fan stops running and the ON/STANDBY indicator lights in red.

## When you cannot confirm the on-screen message

When you cannot confirm the on-screen message under certain conditions, you can turn off the power by holding the I/⏻ key for about two seconds instead of above steps 1 and 2.

## Note

The internal circuitry of the Off & Go function may cause the fan to continue to operate for a short time even after the I/⏻ key is pressed to turn off the power and the ON/STANDBY indicator changes to red.

## ► Convenient Functions

# Selecting the Menu Language

You can select one of fifteen languages for displaying the menu and other on-screen displays. The factory setting is English. To change the menu language, proceed as follows:

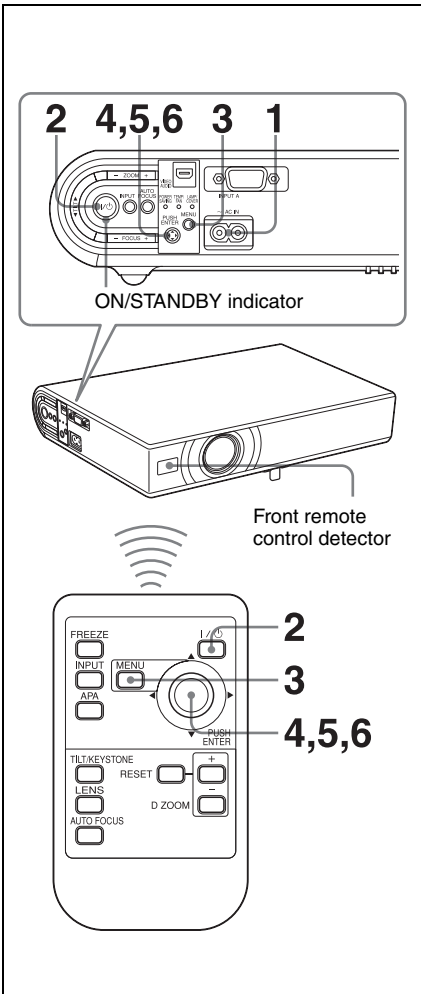

**1** Plug the AC power cord into a wall outlet.

**2** Press the I/O key to turn on the projector.

**3** Press the MENU key.

The menu appears.

The menu currently selected is shown as a yellow button.

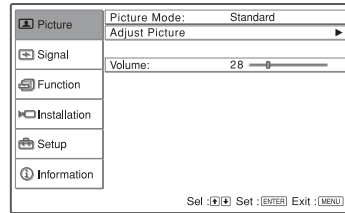

**4** Press the ▲ or ▼ key to select the Setup menu, then press the ► or ENTER key.

The selected menu appears.

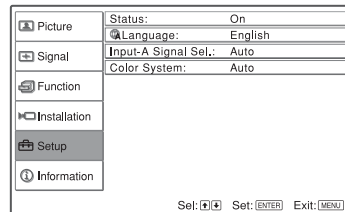

**5** Press the ▲ or ▼ key to select "Language," then press the ► or ENTER key.

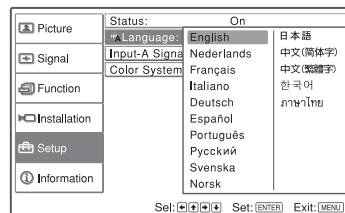

**6** Press the ▲, ▼, ◀ or ▶ key to select a language, then press the ENTER key. The menu changes to the selected language.

Convenient Functions

## To clear the menu

Press the MENU key.

The menu disappears automatically if a key is not pressed for one minute.

---

# Security Lock

The projector is equipped with a security lock function. When you turn the power of the projector on, you are required to input the previously set password. If you do not input the correct password, you will not be able to project the picture.

### Note

You will not be able to use the projector if you forget your password and the password administrator is not available. Be please aware that using the security lock can prevent valid usage in such cases.

## To use the security lock

**1** Press the MENU key and then, on the Function menu, turn on the “Security Lock” setting.

**2** Enter the password.

Use the MENU, ▲/▼/◀/▶, and ENTER keys to enter the four-digit password.

(The default initial password setting is “ENTER, ENTER, ENTER, ENTER.”

After this is entered you can put in your own password. Therefore, when you use this function for the first time, please input “ENTER” four times.)

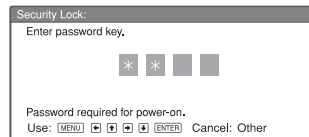

Next, the screen for entering the new password is displayed. (Enter the password on this screen even if you want to keep the current password.)



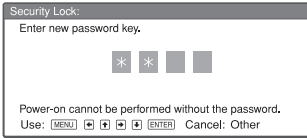

**3** Enter the password again to confirm.

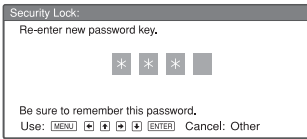

When the following message is displayed, the setting for security lock is completed.

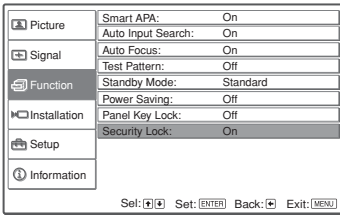

If “Invalid Password!” is displayed on the menu screen, perform this procedure again from step 1.

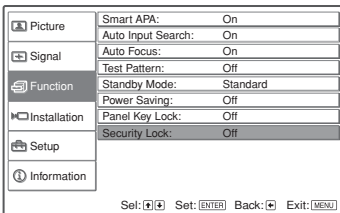

**4** Turn the main power off and disconnect the AC power cord.  
The security lock is set to on, then it becomes effective. The screen used for

entering the password is displayed when the power is turned on the next time.

**Security certification**

When the password screen is displayed, enter the password that was set. If you fail to enter the correct password after three tries, the projector cannot be used. In this case, press the I/⏻ key to turn off the power.

**To cancel the security lock**

- 1 Press the MENU key, then turn off the “Security Lock” setting on the Function menu.
- 2 Enter the password.  
Enter the password that was set.

**Note**

If you call the customer service center because you have forgotten the password, you will need to be able to verify the projector’s serial number and your identity. (This process may differ in other countries/regions.) Once your identity has been confirmed, we will provide you with the password.

# Other Functions

## Off & Go Function

If you are leaving the conference room immediately, turn the projector off, and then, after the powered tilt adjuster is retracted into the projector, you can unplug the AC power cord. After the AC power cord is unplugged, the fan runs for a certain time automatically.

### Notes

- When unplugging the AC power cord, ensure that the powered tilt adjuster has been retracted into the projector. Moving the projector with the powered tilt adjuster extended may damage the adjuster.
- Turn off the projector according to the procedure explained in “Turning Off the Power” on page 14,” then cool it down before storing the projector in the carrying case.
- However, if the unit has been on for less than 15 minutes, the fan might not begin to turn as a result of inadequate charging. In that case, follow the procedure for turning off the power as described in “Turning Off the Power” on page 14.

## Effective Tools for Your Presentation

### To enlarge the image (Digital Zoom function)

You can select a section of the image to enlarge. This function works when a signal from a computer is input.

This function does not work when a video signal is input.

- 1** Project a normal image, and press the D ZOOM + key on the Remote Commander.

The digital zoom icon appears in the center of the image.

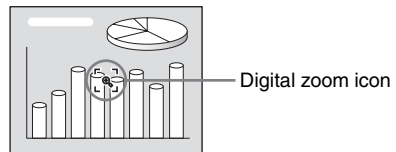

- 2** Move the icon to the point on the image you want to enlarge. Use the arrow key (▲/▼/◀/▶) to move the icon.

- 3** Press the D ZOOM + key again.

The portion of the image where the icon is located is enlarged. The enlargement ratio is displayed on the screen for a few seconds.

By pressing the + key repeatedly, the image size (ratio of enlargement: max. 4 times) increases.

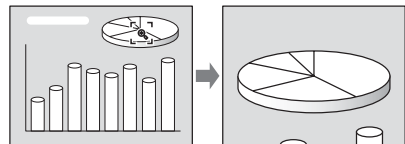

Use the arrow key (▲/▼/◀/▶) to scroll the enlarged image.

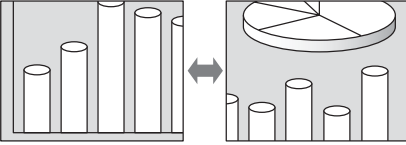

### To return the image to its original size

Press the D ZOOM – key.

Just pressing the RESET key returns the image back to its original size immediately.

---

### To freeze the image projected (Freeze function)

Press the FREEZE key on the remote commander. “Freeze” appears when the key is pressed. This function works when a signal from a computer is input.

To restore the original screen, press the FREEZE key again.



# Using a MENU

The projector is equipped with an on-screen menu for making various adjustments and settings. Some of the adjustable/setting items are displayed in a pop-up menu, in a setting menu or adjustment menu with no main menu, or in the next menu window. If you select an item name followed by an arrow (►), the next menu window with setting items appears. To change the on-screen menu language, see “Selecting the Menu Language” on page 15.

- 1 Press the MENU key.  
The menu appears.

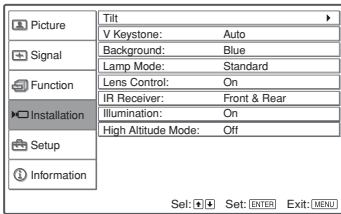

- 2 Use the ▲ or ▼ key to select a menu, then press the ► or ENTER key.  
The items that can be set or adjusted with the selected menu appear. The item presently selected is shown in yellow.

- 3 Select an item.  
Use the ▲ or ▼ key to select the item, then press the ► or ENTER key.  
The setting items are displayed in a pop-up menu, in a setting menu, in an adjustment menu or in the next menu window.

## Pop-up menu

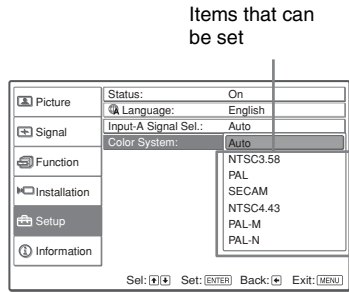

## Setting menu

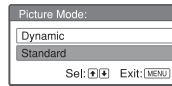

## Adjustment menu



## Next menu window

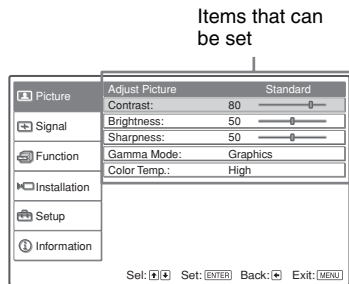

- 4 Make the setting or adjustment of an item.
  - **When changing the adjustment level:**
    - To increase the number, press the ▲ or ► key.
    - To decrease the number, press the ▼ or ◀ key.
  - Press the ENTER key. The setting or adjustment done is stored and the previous screen is restored.
  - **When changing the setting:**
    - Press the ▲ or ▼ key to select the setting.
    - Press the ENTER or ► key to restore the previous screen.

---

### To clear the menu

Press the MENU key.

The menu disappears automatically if a key is not pressed for one minute.

---

### To reset items that have been adjusted

Select the item that you want to reset, and press the RESET key on the Remote Commander.

“Complete!” appears on the screen and **the setting of the item that you have selected is reset to its factory preset value.**

Items that can be reset are:

- “Contrast,” “Brightness,” “Color,” “Hue” and “Sharpness” on the “Adjust Picture...” menu of the Picture menu.
- “Dot Phase,” “H Size,” and “Shift” on the “Adjust Signal...” menu of the Signal menu

---

### Storage of the settings

The settings are automatically stored in the projector memory when the ENTER key is pressed.

---

### If no signal is input

If there is no input signal, “Cannot adjust this item.” appears on the screen.

---

### Unadjustable items

Items that cannot be adjusted, depending on the input signal, are not displayed on the menu.

*For details, see page 31.*

# The Picture Menu

The Picture menu is used for adjusting the picture or volume.

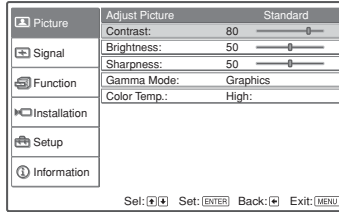
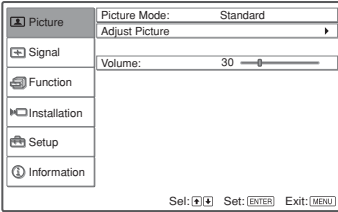

Setting items	Functions	Initial setting
Picture Mode	Selects the picture mode. <ul style="list-style-type: none"> <li>• <b>Dynamic:</b> Emphasizes the contrast to produce a “dynamic” picture.</li> <li>• <b>Standard:</b> Normally select this setting. If the picture has roughness with the “Dynamic” setting, this setting reduces the roughness.</li> </ul>	Standard
Adjust Picture...	The unit can store the setting values of the following sub menu items for each “Dynamic” or “Standard” picture mode separately.	
Contrast	Adjusts the picture contrast.	80
Brightness	Adjusts the picture brightness.	50
Color	Adjusts color intensity.	50
Hue	Adjusts color tones. The higher the setting, the more greenish the picture becomes. The lower the setting, the more purplish.	50
Sharpness	Adjusts the picture sharpness. The higher the setting, the sharper the picture becomes. The lower the setting, the softer the picture becomes.	50
Gamma Mode	Selects a gamma correction curve. <ul style="list-style-type: none"> <li>• <b>Graphics:</b> Improves the reproduction of halftones. Photos can be reproduced in natural tones.</li> <li>• <b>Text:</b> Contrasts black and white. Suitable for images that contain lots of text.</li> </ul>	Graphics
Color Temp.	Adjusts the color temperature. <ul style="list-style-type: none"> <li>• <b>High:</b> Makes white colors bluish.</li> <li>• <b>Low:</b> Makes white colors reddish.</li> </ul>	High Low (Video/S-Video)
Volume	Adjusts the volume.	30

# The Signal Menu

The Signal menu is used to adjust the input signal.

## Adjust Signal...menu

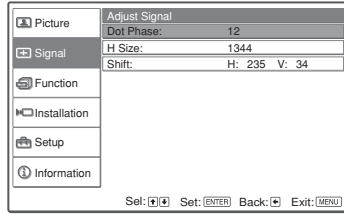
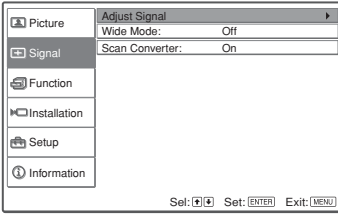

Setting items	Functions	Initial setting
Adjust Signal...		
Dot Phase	Adjusts the dot phase of the LCD panel and the signal output from a computer. Adjust the picture further for finer picture after the picture is adjusted by pressing the APA key.	
H Size	Adjusts the horizontal size of a picture output from a computer. Adjust the setting according to the dots of the input signal. For details, see page 42.	Set according to the input signal
Shift	Adjusts the position of the picture. H adjusts the horizontal position of the picture. V adjusts the vertical position of the picture. As the setting for H increases, the picture moves to the right, and as the setting decreases, the picture moves to the left. As the setting for V increases, the picture moves up, and as the setting decreases, the picture moves down. Use the ◀ or the ▶ key to adjust the horizontal position and the ▲ and ▼ key for the vertical position.	Set according to the input signal
Wide Mode	Sets the aspect ratio of the picture. • <b>Off:</b> When a picture with a ratio of 4:3 is input. • <b>On:</b> When a picture with a ratio of 16:9 (squeezed) is input from a DVD player.	Off
Scan Converter	Converts the signal to display the picture according to the screen size. When set to "Off," displays the picture while matching one pixel of input picture element to that of the LCD. The picture will be clear but the picture size will be smaller.	On

### Note

Note that if the projector is used for profit or for public viewing, modifying the original picture by switching to the wide mode may constitute an infringement of the rights of authors or producers, which are legally protected.

## About the Preset Memory No.

This projector has 40 types of preset data for input signals (the preset memory). When a preset signal is input, the projector automatically detects the signal type and recalls the data for the signal from the preset memory to adjust it to an optimum picture. The memory number and signal type of that signal are displayed on the Information menu (See page 30). You can also adjust the preset data through the Signal menu.

This projector has 20 types of user memories for Input-A into which you can save the setting of the adjusted data for an unpressed input signal.

When an unpressed signal is input for the first time, a memory number is displayed as 0. When you adjust the data of the signal using the Signal menu, it will be registered in the projector. If more than 20 user memory items are registered, the newest memory always overwrites the oldest one.

*See the chart on page 42 to find if the signal is registered in the preset memory.*

Since the data for the following signals is recalled from the preset memory, you can use these preset data items by adjusting "H Size." Make finer adjustments by adjusting "Shift."

Signal	Memory No.	SIZE
Super Mac-2	37	1312
SGI-1	37	1320
Macintosh 19"	39	1328
Macintosh 21"	41	1456
Sony News	47	1708
PC-9821 1280 × 1024	47	1600
WS Sunmicro	48	1664

### Note

When the aspect ratio of input signal is other than 4:3, a part of the screen is displayed in black.



# The Function Menu

The Function menu is used for changing the settings of the projector.

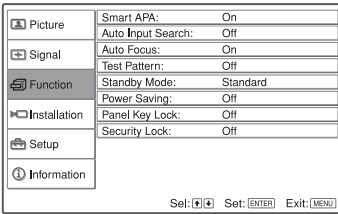

Setting items	Functions	Initial setting
Smart APA	<p>The APA (Auto Pixel Alignment) automatically adjusts “Dot Phase,” “H Size” and “Shift” on the Signal menu for the input signal from a computer.</p> <ul style="list-style-type: none"> <li>• <b>On:</b> When a signal is input from a computer, the APA functions automatically so that the picture can be seen clearly. Once the specified input signal has been adjusted by the “Smart APA,” it will not be readjusted even when the cable is disconnected and connected again or the input channel is changed. You can adjust the picture by pressing the APA key on the Remote Commander even if “Smart APA” set to “On.”</li> <li>• <b>Off:</b> The APA functions when you press the APA key on the Remote Commander.</li> </ul>	On
Auto Input Search	When set to “On,” the projector detects input signals in the following order: Input-A/Video/S-Video. It indicates the input channel when the INPUT key is pressed.	Off
Auto Focus	When set to “Off,” the focus adjustment does not work automatically when the projector is turned on or when the AUTO FOCUS key on the projector or the remote commander is pressed.	On
Test Pattern	When set to “On,” a test pattern is displayed on the screen during “Lens Zoom”, “Lens Focus,” or “V Keystone” adjustment.	Off
Standby Mode	When set to “Low”, the power consumption is set to low in standby mode.	Standard
Power Saving	When set to “On,” the projector goes into power saving mode if no signal is input for 10 minutes. Although the lamp goes out, the cooling fan keeps running. The power saving mode is canceled when a signal is input or any key is pressed. In power saving mode, no keys function for the first 45 seconds after the lamp goes out.	Off

Setting items	Functions	Initial setting
Panel Key Lock	Locks all the control panel keys on the side panel of the projector so that the projector can be operated only with the Remote Commander. To lock the control panel keys, set to "On." When it is set to "On," keeping the I/⏻ key on the control panel pressed for 10 seconds turns the projector on when it is in standby mode, and turns the projector to standby mode when the power is on. If you press and hold the MENU key for about 10 seconds when the power is on, the lock will be released and "Panel Key Lock" is automatically set to "Off."	Off
Security Lock	Turns on the projector's security lock function. When set to "On," turns on the security lock function, which locks the projector once a password has been set. <i>For details, see "Security Lock" on page 16.</i>	Off



### Notes

- Press the APA key when the full image is displayed on the screen. If the projected image includes a black portion around it, the APA function will not work properly and some parts of the image may not be displayed on the screen.
- You can cancel the adjustment by pressing the APA key again while "Adjusting" appears on the screen.
- The picture may not be adjusted properly depending on the type of input signal.
- Adjust the "Dot Phase," "H Size," and "Shift" items on the Signal menu when you adjust the picture manually.

# The Installation Menu

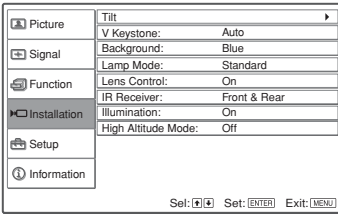
The Installation menu is used for changing the settings of the projector.



Setting items	Functions	Initial setting
Tilt...	Adjusts the position (height) of the projected picture.	
V Keystone	<p>Corrects the trapezoidal distortion caused by the projection angle. Select "Auto" for automatic correction, or "Manual" for manual correction using the ▲/▼/◀/▶ keys on the Remote Commander.</p> <p><b>When the bottom of the trapezoid is longer than the top</b>   : Sets a lower value.</p> <p><b>When the top of the trapezoid is longer than the bottom</b>   : Sets a higher value.</p>	Auto
Background	<p>Selects the background color of the screen when no signal is input to the projector. Select "Black" or "Blue."</p> <p>Normally, set to "Blue."</p>	Blue
Lamp Mode	<p>Sets the lamp brightness used during the projection.</p> <ul style="list-style-type: none"> <li>• <b>High:</b> Illuminates the projected image brightly.</li> <li>• <b>Standard:</b> Reduces fan noise and power consumption. The brightness of the projected image will be lower compared with the "High" setting.</li> </ul>	Standard
Lens Control	<p>When set to "Off," the LENS (FOCUS, ZOOM) key on the Remote Commander, and the FOCUS and ZOOM keys on the projector do not function.</p>	On
IR Receiver	<p>Selects the remote control detectors (IR Receiver) on the front and rear of the projector.</p> <ul style="list-style-type: none"> <li>• <b>Front &amp; Rear:</b> Activates both the front and rear detectors.</li> <li>• <b>Front:</b> Activates the front detector only.</li> <li>• <b>Rear:</b> Activates the rear detector only.</li> </ul>	Front & Rear
Illumination	<p>Selects whether the SONY logo on the rear panel of the projector lights when the projector is on.</p>	On
High Altitude Mode	<p>Set to "On" when the projector is used at an altitude of 1,500 m or higher.</p>	Off

**Note**

The auto V Keystone adjustment may not correct the trapezoidal distortion perfectly, depending on the room temperature or the screen angle.

# The Setup Menu

The Setup menu is used for changing the menu displays.

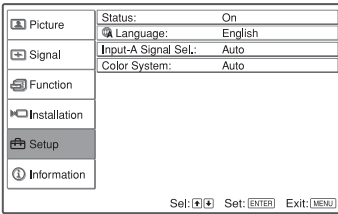

Setting items	Functions	Initial setting
Status (on-screen display)	Sets up the on-screen display. When set to “Off;” turns off the on-screen displays except for the menus, a message when the power is turned off, and warning messages.	On
Language	Selects the language used in the menu and on-screen displays. The languages available are: English, Nederlands, Français, Italiano, Deutsch, Español, Português, Русский, Svenska, Norsk, 日本語, 中文(简体字), 中文(繁體字), 한국어 and ภาษาไทย.	English
Input-A Signal Sel.	Selects the “Auto”, “Computer,” “Component,” or “Video GBR” signal input via the INPUT A connector. When the “Auto” is selected, the type of the input signal is detected automatically. When the input signal is not displayed correctly with this item set to Auto, select the item according to the input signal.	Auto
Color System	Selects the color system of the input signal. If you select “Auto;” the projector detects the color system of the input signal automatically. If the picture is distorted or colorless, select the color system according to the input signal. When the color system of the input signal is PAL60, select “PAL.” If “Auto” is selected, the color system cannot be detected.	Auto

# The Information Menu

The Information menu displays the model name, serial number, the horizontal and vertical frequencies of the input signal and the cumulated hours of usage of the lamp.

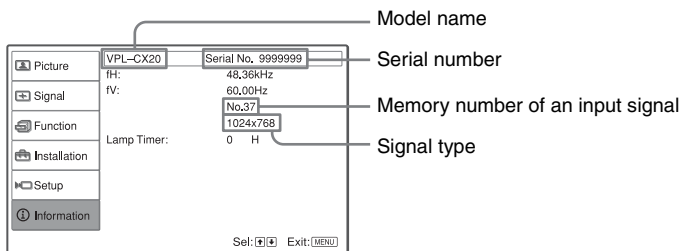

Setting items	Functions
fH	Displays the horizontal frequency of the input signal. The displayed value is approximate.
fV	Displays the vertical frequency of the input signal. The displayed value is approximate.
Lamp Timer	Indicates how long the lamp has been turned on.

## Note

These are only displayed on the screen. You cannot alter the display, and these is no setting to be altered.

## Input signals and adjustable/setting items

### Adjust Picture... menu

Item	Input signal				
	Video or S-Video (Y/C)	Component	Video GBR	Computer	B&W
Contrast	●	●	●	●	●
Brightness	●	●	●	●	●
Color	●	●	●	–	–
Hue	● (NTSC 3.58/4.43 only)	●	●	–	–
Sharpness	●	●	●	–	●
Gamma Mode	–	–	● <sup>*1</sup>	●	–
Color Temp.	●	●	●	●	●
Volume	●	●	●	●	●

● : Adjustable/can be set

– : Not adjustable/cannot be set

\*1: Preset memory No. 3, 4 only

### Signal menu

Item	Input signal				
	Video or S-Video (Y/C)	Component	Video GBR	Computer	B&W
Dot Phase	–	–	–	●	–
H Size	–	–	–	●	–
Shift	–	● <sup>*1</sup>	● <sup>*1</sup>	●	–
Scan Converter	–	–	–	● <sup>*2</sup>	–
Wide Mode	●	● <sup>*3</sup>	● <sup>*3</sup>	–	●

● : Adjustable/can be set

– : Not adjustable/cannot be set

\*1: Except preset memory No. 3, 4

\*2: VPL-CX20: Lower than SVGA

VPL-CS20: Lower than VGA

\*3: Except preset memory No. 7, 8, 10, 11

## Replacing the Lamp

The lamp used as a light source is a consumable product. Thus, replace the lamp with a new one in the following cases.

- When the lamp has burnt out or dims
- “Please replace the Lamp.” appears on the screen
- The LAMP/COVER indicator lights up

The lamp life varies depending on conditions of use.

Use an LMP-C162 Projector Lamp as the replacement lamp.

Use of any other lamps than the LMP-C162 may cause damage to the projector.

### Caution

The lamp remains hot after the projector is turned off with the I/⏻ key. **If you touch the lamp, you may burn your finger. When you replace the lamp, wait for at least an hour for the lamp to cool.**

### Notes

- **If the lamp breaks, contact your Customer Information Center.**
- Pull out the lamp by holding the handle. If you touch the lamp, you may be burned or injured.
- When removing the lamp, make sure it remains horizontal, then pull straight up. Do not tilt the lamp. If you pull out the lamp while it is tilted and if the lamp breaks, the pieces may scatter, causing injury.

- 1 Turn off the projector, and disconnect the AC power cord from the AC outlet.

### Note

When replacing the lamp after using the projector, wait for at least an hour for the lamp to cool.

- 2 Place a protective sheet (cloth) beneath the projector. Turn the projector over so you can see its underside.

### Note

Be sure that the projector is stable after turning it over.

- 3 Open the lamp cover by loosening the three screws with a Phillips screwdriver.

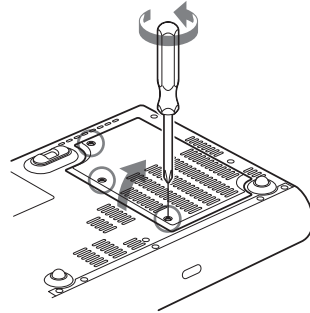

### Note

For safety reasons, do not loosen any other screws.

- 4 Loosen the two screws on the lamp unit with the Phillips screwdriver (1). Fold out the handle (2), then pull out the lamp unit by the handle (3).

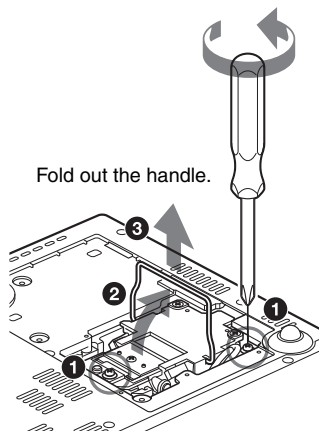



- 5 Insert the new lamp all the way in until it is securely in place (1). Tighten the two screws (3). Fold down the handle to replace it (2).

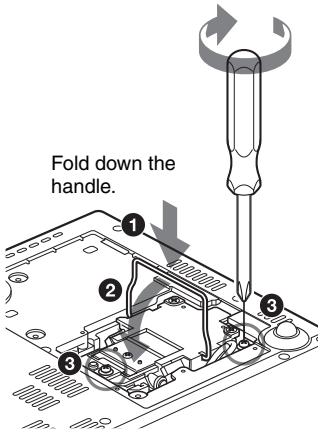

### Caution

Do not put your hands into the lamp replacement slot, and do not allow any liquid or other objects into the slot **to avoid electrical shock or fire.**

### Disposal of the used lamp

#### For the customers in the USA

This product contains mercury. Disposal of this product may be regulated if sold in the United States. For disposal or recycling information, please contact your local authorities or the Electronics Industries Alliance (<http://www.eiae.org>).

### Notes

- Be careful not to touch the glass surface of the lamp.
- The power will not turn on if the lamp is not secured properly.

- 6 Close the lamp cover and tighten the three screws.

### Note

Be sure to attach the lamp cover securely as it was. If not, the projector cannot be turned on.

- 7 Turn the projector back over.
- 8 Connect the power cord.  
The ON/STANDBY indicator around the I/⏻ key lights in red.
- 9 Press the following keys on the Remote Commander in the following order for less than five seconds each: RESET, ◀, ▶, ENTER.

# Cleaning the Air Filter

The air filter should be cleaned every 500 hours.

Remove dust from the outside of the ventilation holes with a vacuum cleaner. 500 hours are approximate. This value varies depending on the environment or how the projector is used.

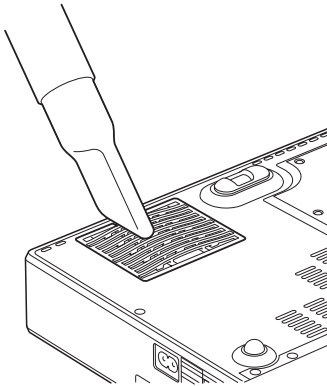

When it becomes difficult to remove the dust from the filter with a vacuum cleaner, remove the air filter and wash it.

- 1 Turn the power off and unplug the power cord.
- 2 Place a protective sheet (cloth) beneath the projector and turn the projector over.
- 3 Remove the air filter cover.

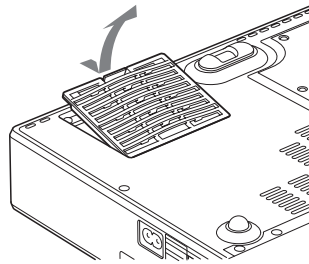

- 4 Remove the air filter.

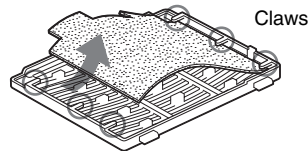

- 5 Wash the air filter with a mild detergent solution and dry it in a shaded place.
- 6 Attach the air filter so that it fits into the each claws (6 positions) on the air filter covers and replace the cover.

## Notes

- **If you neglect to clean the air filter, dust may accumulate, clogging it. As a result, the temperature may rise inside the unit, leading to a possible malfunction or fire.**
- If the dust cannot be removed from the air filter, replace the air filter with the supplied new one.
- Be sure to attach the air filter cover firmly; the power can not be turned on if it is not closed securely.

# Troubleshooting

If the projector appears to be operating erratically, try to diagnose and correct the problem using the following instructions. If the problem persists, consult with qualified Sony personnel.

## Power

Symptom	Cause and Remedy
The power is not turned on.	<ul style="list-style-type: none"> <li>• The power has been turned off and on with the I/⏻ key at a short interval. → Wait for about 45 seconds before turning on the power (see page 14).</li> <li>• The lamp cover is not secured. → Close the lamp cover securely (see page 33).</li> <li>• The air filter cover is detached. → Attach the air filter cover securely (see page 34).</li> </ul>
Both the LAMP/COVER and TEMP/FAN indicators light up.	<p>The electrical system has broken down. → Consult with qualified Sony personnel.</p>
The powered tilt adjuster is not retracted into the projector.	<p>The AC power cord was unplugged with the power of the projector turned on. → Connect the power cord to the AC outlet again, turn on the power of the projector, then turn it off.</p>

## Picture

Symptom	Cause and Remedy
No picture.	<ul style="list-style-type: none"> <li>• A cable is disconnected or the connections are wrong. → Check that the proper connections have been made (see page 9).</li> <li>• The connections are wrong. → This projector is compatible with DDC2B (Digital Data Channel 2B). If your computer is compatible with DDC, turn the projector on according to the following procedures.               <ol style="list-style-type: none"> <li>1 Connect the projector to the computer.</li> <li>2 Turn the projector on.</li> <li>3 Start the computer.</li> </ol> </li> <li>• Input selection is incorrect. → Select the input source correctly using the INPUT key (see page 12).</li> <li>• The computer signal is not set to output to an external monitor or set to output both to an external monitor and a LCD monitor of a computer. → Set the computer signal to output only to an external monitor. → Depending on the type of your computer, for example a notebook, or an all-in-one LCD type, you may have to switch the computer to output to the projector by pressing certain keys or by changing your computer's settings. For details, refer to the computer's operating instructions supplied with your computer.</li> </ul>

Symptom	Cause and Remedy
The picture is noisy.	Noise may appear on the background depending on the combination of the number of dots input from the connector and the numbers of pixels on the LCD panel. → Change the desktop pattern on the connected computer.
The picture from the INPUT A connector is colored strangely.	The setting of "Input-A Signal Sel." on the Setup menu is incorrect. → Select "Auto", "Computer," "Video GBR" or "Component" correctly according to the input signal (see page 29).
"Please check Input-A Signal Sel." appears in spite of inputting the correct signal from INPUT A.	The setting of "Input-A Signal Sel." on the Setup menu is incorrect. → Select "Auto", "Computer," "Video GBR" or "Component" correctly according to the input signal (see page 29).
On-screen display does not appear.	"Status" on the Setup menu has been set to "Off." → Set "Status" on the Setup menu to "On" (see page 29).
Color balance is incorrect.	<ul style="list-style-type: none"> <li>• The picture has not been adjusted properly. → Adjust the picture (see page 22).</li> <li>• The projector is set to the wrong color system. → Set "Color System" on the Setup menu to match the color system being input (see page 29).</li> </ul>
The picture is too dark.	<ul style="list-style-type: none"> <li>• Contrast or brightness has not been adjusted properly. → Adjust the contrast or brightness on the "Adjust Picture..." menu of the Picture menu properly (see page 22).</li> <li>• The lamp has burnt out or is dim. → Replace the lamp with a new one (see page 32).</li> </ul>
The picture is not clear.	<ul style="list-style-type: none"> <li>• The picture is out of focus. → Adjust the focus (see page 13).</li> <li>• Condensation has accumulated on the lens. → Leave the projector for about two hours with the power on.</li> </ul>
The image extends beyond the screen.	The APA key has been pressed even though there are black edges around the image. → Display the full image on the screen and press the APA key. → Adjust "Shift" on the Adjust Signal... menu of the Signal menu properly (see page 23).
The picture flickers.	"Dot Phase" on the Adjust Signal... menu of the Signal menu has not been adjusted properly. → Adjust "Dot Phase" on the Adjust Signal... menu of the Signal menu properly (see page 23).

## Sound

Symptom	Cause and Remedy
No sound.	<ul style="list-style-type: none"> <li>• A cable is disconnected or the connections are wrong. → Check that the proper connections have been made (see page 9).</li> <li>• The connecting cable used is incorrect. → Use the A/V connecting adaptor (supplied) (see page 9).</li> <li>• The sound is not adjusted properly. → Adjust “Volume” on the Picture menu (see page 22).</li> </ul>

## Remote Commander

Symptom	Cause and Remedy
The Remote Commander does not work.	<p>The Remote Commander battery is dead. → Replace it with a new battery (see page 7).</p>

## Others

Symptom	Cause and Remedy
The control panel keys do not function.	<p>The control panel keys are locked. → Unlock the control panel keys (see page 26).</p>

## Indicators

Symptom	Cause and Remedy
The LAMP/COVER indicator flashes.	<ul style="list-style-type: none"> <li>• The lamp cover or the air filter cover is detached. → Attach the cover securely (see page 33 and 34).</li> <li>• The electrical system may break down. → Consult with qualified Sony personnel.</li> </ul>
The LAMP/COVER indicator lights up.	<ul style="list-style-type: none"> <li>• The lamp has reached the end of its life. → Replace the lamp (see page 32).</li> <li>• The lamp has reached a high temperature. → Wait for 45 seconds to cool the lamp and then turn on the power again.</li> <li>• If the LAMP/COVER indicator still lights even after you have replaced the lamp, the electrical system may break down. → Consult with qualified Sony personnel.</li> </ul>
The TEMP/FAN indicator flashes.	<p>The fan is broken. → Consult with qualified Sony personnel.</p>
The TEMP/FAN indicator lights up.	<ul style="list-style-type: none"> <li>• The internal temperature is unusually high. → Check to see that nothing is blocking the ventilation holes.</li> <li>• The projector is being used at a high altitude. → Ensure that “High Altitude Mode” on the Installation menu is set to “On.”</li> </ul>
Both the LAMP/COVER and TEMP/FAN indicators light up.	<p>The electrical system has broken down. → Consult with qualified Sony personnel.</p>

## Messages List

### Warning Messages

Use the list below to check the meaning of the messages displayed on the screen.

Message	Meaning and Remedy
High temp.! Probably use in high altitude. Switch to high altitude mode on? Yes ↑ No ↓	Internal temperature is too high. → When using the projector at an altitude of 1,500 m or higher, set “High Altitude Mode” on the Installation menu to “On” (see page 27). → If this message appears on the screen when using the projector at normal altitudes, check to see if anything is blocking the ventilation holes (exhaust).
High temp.! Lamp off in 1 min.	The internal temperature is too high. → Turn off the power. → Check to see that nothing is blocking the ventilation holes.
Frequency is out of range!	<ul style="list-style-type: none"> <li>• This input signal cannot be projected as the frequency is out of the acceptable range of the projector. → Input a signal that is within the range of the frequency.</li> <li>• The resolution setting of the output signal of the computer is too high. → Set the output setting to XGA (VPL-CX20) and SVGA (VPL-CS20) (see page 9).</li> </ul>
Please check Input-A Signal Sel.	You have input an RGB signal from the computer when “Input-A Signal Sel.” on the Setup menu is set to “Component.” → Set “Input-A Signal Sel.” correctly (see page 29).
Please replace the Lamp.	<ul style="list-style-type: none"> <li>• It is time to replace the lamp. → Replace the lamp.</li> <li>• When this message appears even after replacing the lamp, the task has not been completed. → Perform the operation of steps 8 and 9 on page 33.</li> </ul>
Please clean the filter.	It is time to clean the filter. → Clean the filter (see page 34).

### Caution Messages

Use the list below to check the meaning of the messages displayed on the screen.

Message	Meaning and Remedy
Not applicable!	You have pressed the wrong key. → Press the appropriate key.
The panel keys are locked!	“Panel Key Lock” on the Function menu is set to “On.” → All the keys on the control panel of the projector are locked. Operate the projector with the keys on the Remote Commander (see page 26).
Auto Focus is disabled! Do you wish to enable? Yes ↑ No ↓	“Auto Focus” on the Function menu is set to “Off.” → To enable the Auto Focus function, set it to “On.”

Message	Meaning and Remedy
Lens control is locked! Do you wish to unlock? Yes <b>↑</b> No <b>↓</b>	“Lens Control” on the Installation menu is set to “Off.” <b>→</b> To enable the the LENS (FOCUS, ZOOM) key on the Remote Commander, and the FOCUS and ZOOM keys on the projector, set “Lens Control” to “On.”

# Specifications

## Optical characteristics

### Projection system

3 LCD panels, 1 lens, projection system

LCD panel VPL-CX20: 0.63-inch XGA panel, approximately 2,360,000 pixels (786,432 pixels × 3)

VPL-CS20: 0.63-inch SVGA panel, approximately 1,440,000 pixels (480,000 pixels × 3)

Lens 1.2 times zoom lens (powered) f 18.8 to 22.6 mm/F1.6 to 1.94

Lamp 165 W UHP

### Projected picture size

40 to 150 inches (measured diagonally)

Light output ANSI lumen<sup>1)</sup> 2000 lm (When the Lamp Mode is set to "High.")

### Throwing distance (When placed on the floor.)

40-inch: 1.2 to 1.4 m

(3.8 to 4.6 feet)

80-inch: 2.3 to 2.8 m

(7.6 to 9.4 feet)

100-inch: 2.9 to 3.6 m

(9.6 to 11.7 feet)

150-inch: 4.4 to 5.4 m

(14.4 to 17.6 feet)

There may be a slight difference between the actual value and the design value shown above.

<sup>1)</sup> ANSI lumen is a measuring method described in American National Standard IT 7.228.

## Electrical characteristics

Color system NTSC<sup>3.58</sup>/PAL/SECAM/NTSC<sup>4.43</sup>/PAL-M/PAL-N/PAL60 system, switched automatically/manually (NTSC<sup>4.43</sup> is the color system used when playing back a video recorded in NTSC on a NTSC<sup>4.43</sup> system VCR.)

Resolution VPL-CX20: 750 horizontal TV lines (Video input) 1,024 × 768 dots (RGB input) VPL-CS20: 600 horizontal TV lines (Video input) 800 × 600 dots (RGB input)

Acceptable computer signals<sup>1)</sup>

fH: 19 to 92 kHz

fV: 48 to 92 Hz

(Maximum input signal resolution:

SXGA+ 1400 × 1050

fV: 60 Hz

<sup>1)</sup> Set the resolution and the frequency of the signal of the connected computer within the range of acceptable preset signals of the projector.

### Applicable video signals

15 k RGB/Component 50/60 Hz, Progressive component 50/60 Hz, DTV (480/60I, 575/50I, 480/60P, 575/50P, 720/60P, 720/50P, 1080/60I, 1080/50I), Composite video, Y/C video

Speaker Monaural speaker system, 40 × 20 mm (1 5/8 × 1 3/16 inches)

### Speaker output

1 W (max.)

## Input/Output

INPUT A HD D-sub15-pin (female)

Analog RGB/component:

R/R-Y: 0.7 Vp-p ±2 dB

(75 ohms terminated)

G: 0.7 Vp-p ±2 dB

(75 ohms terminated)

G with sync/Y: 1 Vp-p ±2 dB

sync negative

(75 ohms terminated)

B/B-Y: 0.7 Vp-p ±2 dB

(75 ohms terminated)

SYNC/HD: Composite sync input:

TTL level, positive/negative

Horizontal sync input: TTL level

Positive/negative VD: Vertical

sync input: TTL level, positive/

negative

### AUDIO/VIDEO

VIDEO: Composite video: 1 Vp-p

±2 dB sync negative (75 ohms

terminated)

S VIDEO: Y/C (luminance): 1

Vp-p ±2 dB sync negative (75

ohms terminated)

C (chrominance): burst

0.286 Vp-p ±2 dB (NTSC)

(75 ohms terminated),

burst 0.3 Vp-p ±2 dB (PAL)

(75 ohms terminated)

AUDIO: rated input 500 mVrms,

input impedance 47 kilohms

### Safety regulations

UL60950, cUL (CSA No. 60950), FCC Class B,

IC Class B, NEMKO (EN60950), CE (LVD,

EMC), C-Tick



## General

Dimensions	273 × 52 × 210 mm (10 <sup>3</sup> / <sub>4</sub> × 2 <sup>1</sup> / <sub>8</sub> × 8 <sup>3</sup> / <sub>8</sub> inches) (w/h/d) (without projecting parts)
Mass	Approx. 1.9 kg (4 lb 3 oz)
Power requirements	AC 100 to 240 V, 2.2 to 1.0 A, 50/60 Hz
Power consumption	Max. 220 W in standby: 0.8 W
Heat dissipation	750.7 BTU
Operating temperature	0°C to 35°C (32°F to 95°F)
Operating humidity	35% to 85% (no condensation)
Storage temperature	-20°C to +60°C (-4°F to +140°F)
Storage humidity	10% to 90%
Supplied accessories	Remote Commander (1) Lithium battery CR2025 (1) HD D-sub 15 pin cable (2 m) (1) (1-791-992-XX) A/V connecting adaptor (1) (1-830-658-XX) Carrying case (1) AC power cord (1) Operating Instructions (CD-ROM) (1) Quick Reference Manual (1) Safety Regulations (1) Security Label (1)

Design and specifications are subject to change without notice.

## Optional accessories

Projector Lamp	LMP-C162(for replacement)
Signal Cable	SMF-402 (HD D-sub 15-pin (male) ↔ 3 × phono type (male))

*Some of the items may not be available in some areas. For details, please consult your nearest Sony dealer.*

## Pin assignment

### INPUT A connector (HD D-sub 15-pin, female)

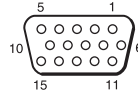

1	R/R-Y	9	N.C.
2	G/Y	10	GND
3	B/B-Y	11	GND
4	GND	12	DDC/SDA
5	GND	13	HD/C.Sync
6	GND (R)	14	VD
7	GND (G)	15	DDC/SCL
8	GND (B)		

## Preset signals

Memory No.	Preset signal		fH (kHz)	fV (Hz)	Sync	SIZE
1	Video 60 Hz	60 Hz	15.734	59.940	–	–
2	Video 50 Hz	50 Hz	15.625	50.000	–	–
3	480/60i	480/60i	15.734	59.940	S on G/Y	–
4	575/50i	575/50i	15.625	50.000	S on G/Y	–
5	480/60p	480/60p (Progressive component)	31.470	60.000	S on G/Y	–
6	575/50p	575/50p (Progressive component)	31.250	50.000	S on G/Y	–
7	1080/60i	1035/60i, 1080/60i	33.750	60.000	S on G/Y	–
8	1080/50i	1080/50i	28.130	50.000	S on G/Y	–
10	720/60p	720/60p	45.000	60.000	S on G/Y	–
11	720/50p	720/50p	37.500	50.000	S on G/Y	–
21	640 × 350	VGA mode 1	31.469	70.086	H-pos, V-neg	800
22		VGA VESA 85 Hz	37.861	85.080	H-pos, V-neg	832
23	640 × 400	PC-9801 Normal	24.823	56.416	H-neg, V-neg	848
24		VGA mode 2	31.469	70.086	H-neg, V-pos	800
25		VGA VESA 85 Hz	37.861	85.080	H-neg, V-pos	832
26	640 × 480	VGA mode 3	31.469	59.940	H-neg, V-neg	800
27		Macintosh 13"	35.000	66.667	H-neg, V-neg	864
28		VGA VESA 72 Hz	37.861	72.809	H-neg, V-neg	832
29		VGA VESA 75 Hz	37.500	75.000	H-neg V-neg	840
30		VGA VESA 85 Hz	43.269	85.008	H-neg V-neg	832
31	800 × 600	SVGA VESA 56 Hz	35.156	56.250	H-pos, V-pos	1024
32		SVGA VESA 60 Hz	37.879	60.317	H-pos, V-pos	1056
33		SVGA VESA 72 Hz	48.077	72.188	H-pos, V-pos	1040
34		SVGA VESA 75 Hz	46.875	75.000	H-pos, V-pos	1056
35		SVGA VESA 85 Hz	53.674	85.061	H-pos, V-pos	1048
36	832 × 624	Macintosh 16"	49.724	74.550	H-neg, V-neg	1152
37	1024 × 768	XGA VESA 60 Hz	48.363	60.004	H-neg V-neg	1344
38		XGA VESA 70 Hz	56.476	69.955	H-neg V-neg	1328
39		XGA VESA 75 Hz	60.023	75.029	H-pos, V-pos	1312
40		XGA VESA 85 Hz	68.677	84.997	H-pos, V-pos	1376

Memory No.	Preset signal		fH (kHz)	fV (Hz)	Sync	SIZE
41	1152 × 864	SXGA VESA 70 Hz	63.995	70.019	H-pos, V-pos	1472
42		SXGA VESA 75 Hz	67.500	75.000	H-pos, V-pos	1600
43		SXGA VESA 85 Hz	77.487	85.057	H-pos, V-pos	1568
44	1152 × 900	Sunmicro LO	61.795	65.960	H-neg, V-neg	1504
45	1280 × 960	SXGA VESA 60 Hz	60.000	60.000	H-pos, V-pos	1800
46		SXGA VESA 75 Hz	75.000	75.000	H-pos, V-pos	1728
47	1280 × 1024	SXGA VESA 60 Hz	63.974	60.013	H-pos, V-pos	1696
48		SXGA VESA 75 Hz	79.976	75.025	H-pos, V-pos	1688
49*		SXGA VESA 85 Hz	91.146	85.024	H-pos, V-pos	1476
50	1400 × 1050	SXGA+ 60 Hz	63.981	60.020	H-neg, V-neg	1688

### Notes

- When a signal other than the preset signals shown above is input, the picture may not be displayed properly.
- For the Memory No.49\*, the smart APA function and the APA key of the remote commander do not active. Make adjustments for the input signal using the Adjust Signal... on the Signal menu.
- When an SXGA+ signal is input, the image may extend beyond the edges of the screen. In this case, input a signal with no black edges around the image, and disconnect and reconnect the cable or select the input signal by pressing the INPUT key.

### Warning on power connection

Use the supplied power cord when you use the projector in your country/region. Otherwise, use a proper power cord meeting the following specifications.

	The United States, Canada	Continental Europe, Korea	UK	Australia	Japan
Plug type	YP-11	YP-21	SP-61	B8	YP-13
Female end	YC-13L	YC-13L	YC-13L	C7-2	YC-13L
Cord type	SPT-2	H03VVH2-F	H03VVH2-F	H03VVH2-F	VCTFK
Rated Voltage & Current	10A/125V	2.5A/250V	2.5A/250V	2.5A/250V	7A/125V
Safety approval	UL/CSA	VDE	BS	SAA	DENAN
Cord length (max.)	4.5 m	–	–	–	–

---

# Index

## A

Adjusting	
memory of the settings .....	21
the picture .....	22
the picture size/shift .....	23
Air filter .....	34
Auto Focus .....	25
Auto Input Search .....	25

## B

Background .....	27
Brightness .....	22

## C

Color .....	22
Color System .....	29
Color Temp. ....	22
Connecting a computer .....	9
Connecting a VCR .....	10
Contrast .....	22

## D

Digital Zoom function .....	18
Dot Phase .....	23

## F

fH (Horizontal Frequency) .....	30
fV (Vertical Frequency) .....	30

## G

Gamma Mode .....	22
------------------	----

## H

H Size .....	23
High Altitude Mode .....	27
Hue .....	22

## I

Illumination .....	27
Input-A Signal Sel. ....	29
Installation .....	8
IR .....	27
IR Receiver .....	27

## L

Lamp Mode .....	27
Lamp replacement .....	32
Lamp Timer .....	30
Language .....	29
selecting the menu language .....	15
Lens Control .....	27
Location and function of controls	
control/connector panel .....	5
rear/right side/bottom .....	4
Remote Commander .....	6
top/front/left side .....	4

## M

Menu	
clearing the menu display .....	21
Function menu .....	25
Information Menu .....	30
Installation menu .....	27
Picture menu .....	22
Setup menu .....	29
Signal menu .....	23
using the menu .....	20
Message List	
caution .....	38
warning .....	38

## O

Off & Go function .....	18
Optional accessories .....	41

## P

Panel Key Lock .....	26
Picture Mode .....	22
Pin assignment .....	41
Power	
turn on .....	11
Power Saving .....	25
Powered tilt adjuster .....	12
Projecting .....	11

## R

Remote Commander .....	6
front remote control detector .....	4
location and function of controls .....	6
rear remote control detector .....	4
Reset	
resettable items .....	21
resetting an item .....	21

## S

Scan Converter .....	23
Screen size .....	8, 40
Security Lock .....	26
Sharpness .....	22
Shift .....	23
Smart APA .....	25
Specifications .....	40
Standby Mode .....	25
Status .....	29
Supplied accessories .....	41

## T

Test Pattern .....	25
Tilt... ..	27
Troubleshooting .....	35

## V

V Keystone .....	27
Volume .....	22

## W

Wide Mode .....	23
-----------------	----



## Free Manuals Download Website

<http://myh66.com>

<http://usermanuals.us>

<http://www.somanuals.com>

<http://www.4manuals.cc>

<http://www.manual-lib.com>

<http://www.404manual.com>

<http://www.luxmanual.com>

<http://aubethermostatmanual.com>

Golf course search by state

<http://golfingnear.com>

Email search by domain

<http://emailbydomain.com>

Auto manuals search

<http://auto.somanuals.com>

TV manuals search

<http://tv.somanuals.com>