

DIRECTV Digital Satellite Receiver

Operating Instructions

Before you begin using your Digital Satellite Receiver for the first time, follow the instructions in "Connecting Your Digital Satellite Receiver" on pages 6-13 and "Setting Up Your Digital Satellite Receiver (SYSTEM)" on pages 22-34. Also, make sure your Satellite Dish Antenna has been properly installed and call your service provider to begin service:

DIRECTV: 1-800-DIRECTV (347-3288)

SAT-A55 MODEL ONLY

RF ANTENNA: This Digital Satellite Receiver is shipped with IR reception enabled and RF reception disabled. To use the RF feature (and the RF Antenna) you must change the factory setting (IR only) to the RF setting (RF only) using the on-screen displays, as described in these Operating Instructions.



SAT-A55

SAT-B55

WARNING

To reduce the risk of fire or shock hazard, do not expose the unit to rain or moisture.

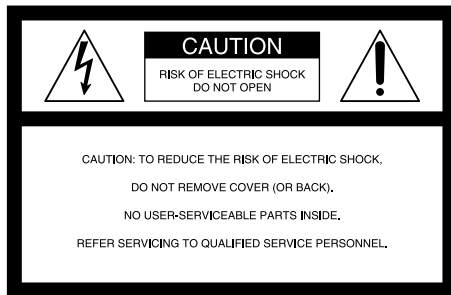

This symbol is intended to alert the user to the presence of uninsulated “dangerous voltage” within the product’s enclosure that may be of significant magnitude to constitute a risk of electric shock to persons.



This symbol is intended to alert the user to the presence of important operating and maintenance (servicing) instructions in the literature accompanying the appliance.

Note to the CATV Installer

This reminder is provided to call the CATV system installer’s attention to Article 820-40 of the NEC that provides guidelines for proper grounding and, in particular, specifies that the cable ground shall be connected to the grounding system of the building as close to the point of cable entry as practical.

Note to the Satellite Dish Antenna Installer

This reminder is provided to call the Satellite Dish Antenna installer’s attention to Article 810 and in particular Article 810-15 of the NEC, which covers proper installation and grounding of television receiving equipment, as well as to Article 820-40 of the NEC, which specifies that the Satellite Dish Antenna cable ground shall be connected to the grounding system of the building as close to the point of cable entry as practical.

Attention

Telephone Line Interruption

Periodically, information on your DIRECT TICKET® and Pay Per View selections is sent, free of charge, via your telephone line to an 800 number. If you use your telephone during the time the information is being forwarded, you will hear static noise for approximately 30 seconds. If you would like to use your telephone while the information is being sent, you can interrupt the sending of this information at any time by temporarily unplugging the phone line to the receiver.

Local Programming

With this Digital Satellite Receiver and a DIRECTV Plus satellite dish antenna, you may be able to receive local channels from DIRECTV in certain areas. Additional equipment may be required in some areas. Check with your retailer or visit www.directv.com for information on availability of local channels from DIRECTV in your area.

You are cautioned that any changes or modifications not expressly approved in this manual could void your authority to operate this equipment.

The Digital Satellite Receiver is intended for use only within the United States.

Owner’s Record

The model and serial numbers are located on the bottom of the Digital Satellite Receiver. The number for the Access Card is on the back of the card and on the carton label. Record these numbers in the space provided below. Refer to these numbers whenever you need to call your sales or service representative regarding this product.

Model Number: _____

Serial Number: _____

Access Card Number: _____

Customer Support

For Programming

For subscription information, or to resolve problems related to programming, call:
DIRECTV at 1-800-DIRECTV (347-3288)

For Hardware and Installation

To arrange for the installation of your Digital Satellite Receiver, call the dealer from whom you purchased your system. For general information, or to resolve problems related to the operation of your Digital Satellite Receiver or Satellite Dish Antenna, please contact your Sony dealer. If your dealer or installer is unable to answer your questions, call the Sony Satellite System Information Center at 1-800-838-7669.

Trademark and Copyrights

Sony, Media Window, Signal Seeker, Remote Commander and SmartFile are trademarks of Sony. DIRECTV is a trademark of DIRECTV, Inc., a unit of Hughes Electronics, and is used with permission. Manufactured under license from Dolby Laboratories. “Dolby” and the double-D symbol are trademarks of Dolby Laboratories. Confidential Unpublished Works. © 1992-1997 Dolby Laboratories Inc. All rights reserved.

Macrovision Information

This product incorporates copyright protection technology that is protected by U.S. patents and other intellectual property rights. Use of this copyright protection technology is granted by Macrovision for home and other limited pay per view uses only. Reverse engineering or disassembly is prohibited.

Note on Recording Programming

Programming may be taped for home viewing only. All other taping is expressly prohibited. Some programming may not be taped. An additional taping fee may be applied. Call your program providers for details.

StarSight Licensed

The manufacture and sale of the television schedule feature of this product was licensed under one or more of the following patents of StarSight Telecast, Inc.: U.S. Patent Nos. 4,706,121; 4,977,455; 5,151,789; and 5,353,121; with use rights reserved.

About These Operating Instructions

These Operating Instructions describe how to use the SAT-A55 and its remote control. Any differences in operation for the SAT-B55 are noted in the text.

The  icon indicates hints and tips for making the task easier.

A **Note** provides information that may be necessary to complete the task.

Getting to Know Your Digital Satellite Receiver

Connecting Your Digital Satellite Receiver (Page 6)

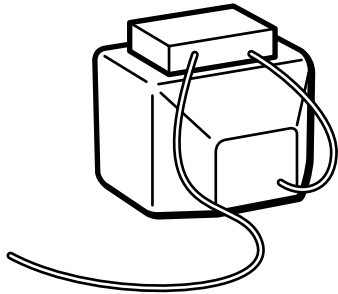

Using Your Remote Control (Page 14)

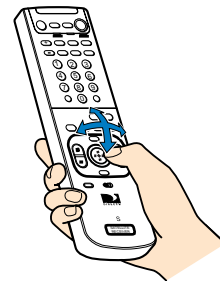

Setting Up Your Digital Satellite Receiver (Page 22)



Using the Program Guide (Page 37)



Using the Favorite Stations Guide (Page 40)



Setting Locks & Limits (Page 53)

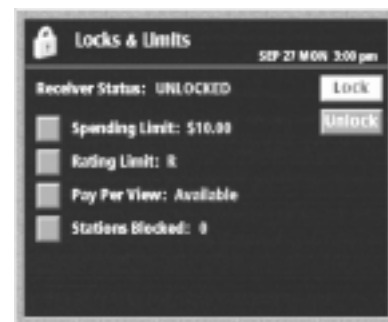

Features

Congratulations on your purchase of the Sony Digital Satellite Receiver. This manual can help you to become familiar with the many great features of the Digital Satellite Receiver. Check below to find out about some of the most exciting features.

Convenience and Ease-of-Use

- The Program Guide shows the picture and sound in the Media Window™ while you check station and program information. See page 37.
- The One Button Record and VCR Control features allow you to easily record your favorite programming on your VCR. See pages 26–28 and page 60.
- SAT-A55 model: Operate your Digital Satellite Receiver from another room or from outside a cabinet by setting up the RF feature on your remote control. See pages 32–34.

Excellent Performance

- The Auto Title Insert feature for VCR recording can display program information at the beginning of any Timer & Rec event. You'll have a convenient "title" recorded at the beginning of your tapes. See page 26.
- Choose to listen to different audio tracks available with many programs. See page 64
- SAT-A55 model: Select Dolby Digital audio to truly make your home theater come alive. See page 64.

Easy to Customize

- Organize the channels your family watches most often by setting up the Favorite Stations guide. See pages 40–42.
- Control access to programming with the Locks & Limits feature. See pages 53–58.
- Set up the Custom Stations feature to exclude stations that you don't want to see from the Program Guide, Category Guide and Station Index. See pages 50–51.
- Choose your favorite color palette for the on-screen displays. See pages 47–48

Table of Contents

Connecting Your Digital Satellite Receiver

Carton Contents	6
Connection Overview	7
Step 1: Inserting the Batteries	7
Step 2: Connecting the Satellite Dish Antenna and Telephone Line	8
Step 3: Connecting Your TV	9
Step 4: Adding a VCR and Audio System	10
Step 5: Connecting the VCR Controller	11
Connecting a Sony SmartFile™ VCR	11
Step 6: Connecting the RF Antenna (SAT-A55 only)	12
Step 7: Connecting the AC Power Cord	13
Step 8: Inserting the Access Card	13

Viewing Pictures From Your Digital Satellite Receiver

Using Your Remote Control	14
RM-Y802 Remote Control (SAT-A55 model)	14
RM-Y139 Remote Control (SAT-B55 model)	16
Selecting Items	18
Turning On the Power	19
Changing Channels	20

Using the On-Screen Displays

Using the Main Menu	21
Setting Up Your Digital Satellite Receiver (SYSTEM)	22
Using the System Menu	22
Setting Up the Satellite Dish Antenna	23
Setting Up the VCR Control Feature	26
Performing a System Test	29
Setting the Aspect Ratio	30
Replacing Your Access Card	31
Selecting RF or IR Remote Control Reception (SAT-A55 only)	32
Using the Guides Menu	35
Viewing Station and Program Information (GUIDES)	35
Using the Alpha List	36
Using the Program Guide	37
Using the Category Guide	38
Using the Station Index	39
Using the Favorite Stations Guide	40
Using Other Guides	43
Viewing Pay Per View Programs	45

Adjusting the Displays (PREFERENCES)	46
Using the Preferences Menu	46
Setting Display Options	47
Setting Up Custom Stations	50
Selecting Data Services	51
Viewing Messages (MESSAGES)	52
Setting Locks and Limits (LOCKS & LIMITS)	53
Using the Locks & Limits Display	53
Locking Your Receiver	57
Unlocking Your Receiver	58
Checking Pay Per View Purchases (PURCHASES)	59
Checking Your Purchases	59
Scheduling Programs (TIMER & REC)	60
Using One Button Timer & Rec	60
Using the Timer & Rec Feature	61
Editing Timer Events	63
Setting Audio Options (AUDIO)	64
Using the Audio Display	64

Other Information

Setting Up the Remote Control	65
Manufacturer Codes	66
Location and Function of Controls	68
Front Panel	68
SAT-A55 Back Panel	69
SAT-B55 Back Panel	70
Specifications	71
Troubleshooting	72
FCC Regulations and Information	76
Limited Warranty	77
Index	78

Carton Contents

Check to make sure the following items are in the Digital Satellite Receiver's carton.

If you are missing any items, contact your Sony dealer.

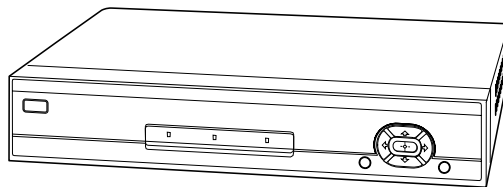

Digital Satellite Receiver



RF Antenna**

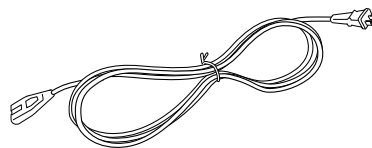

AC Power Cord

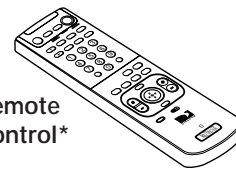

Remote Control*

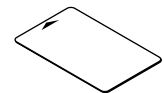

Access Card



Size AA Batteries

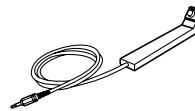

VCR Controller

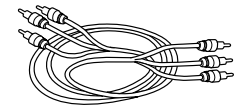

Audio/Video Cable



RF Coaxial Cable

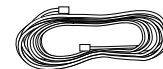

Telephone Cord

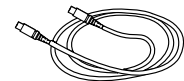

S-Video Cable**

* The RM-Y802 Remote Control shown.

** The RF Antenna and S-Video cable are not included with the SAT-B55 model.

Note

Keep the original carton and packing materials to safely transport the Digital Satellite Receiver in the future.

Connection Overview

Follow the procedures or make the connections in each of the steps to connect your Digital Satellite Receiver.

Step 1: Inserting the Batteries
Page 7



Step 2: Connecting the Satellite Dish Antenna and Telephone Line
Page 8



Step 3: Connecting Your TV
Page 9



Step 4: Adding a VCR and Audio System
(advanced connection) Page 10



Step 5: Connecting the VCR Controller
(advanced connection) Page 11



Step 6: Connecting the RF Antenna (SAT-A55 only)
(advanced connection) Page 12



Step 7: Connecting the AC Power Cord
Page 13



Step 8: Inserting the Access Card
Page 13

Step 1: Inserting the Batteries

Before you can use the remote control, you must insert the supplied batteries. If you want to use this remote control to operate other audio/video equipment, such as a TV or VCR, you must set up the remote control (see page 65).

1 Push and slide open the battery compartment.

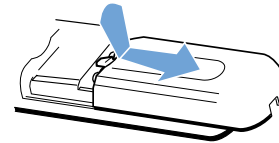

2 Insert two size AA batteries (supplied).

Be sure to match the + and - marks on the batteries with the + and - marks inside the battery compartment.

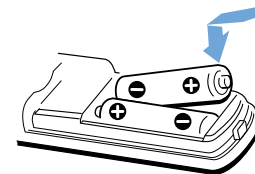

Notes

- When the batteries become weak, the Function button indicators flash. If the remote control does not work properly, the batteries may be weak.
- When replacing batteries, replace both batteries with new ones. Do not mix different types of batteries together.
- When you remove the batteries, any manufacturer codes you've set up may be erased. To set up the remote control again, see "Setting Up the Remote Control" on page 65.

Step 2: Connecting the Satellite Dish Antenna and Telephone Line

The SATELLITE IN jack sends power to, and receives satellite signals from, the Satellite Dish Antenna. The telephone line connection periodically sends information about your receiver and Access Card to your service provider.

Digital Satellite Receiver

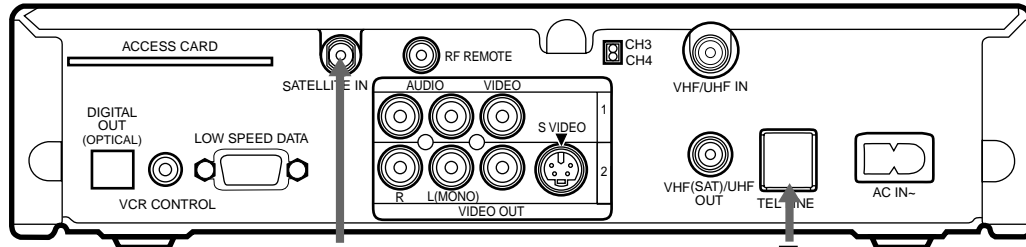

1 Connect the SATELLITE IN jack to your Satellite Dish Antenna using RG-6 coaxial cable.

RG-6 Coaxial Cable from Satellite Dish Antenna

Telephone Cord

2 Connect the TEL LINE jack to a telephone line wall jack using the supplied telephone cord.

Notes

- The SAT-A55 model is shown. Connections for the SAT-B55 model are the same.
- Your Satellite Dish Antenna Installation Instructions provides detailed instructions on how to install RG-6 coaxial cable from your Satellite Dish Antenna.



CAUTION

Only connect your authorized Satellite Dish Antenna to the SATELLITE IN jack as described in the Installation Instructions. Connecting any other equipment to this jack could result in damage to the equipment and/or receiver.

Step 3: Connecting Your TV

Connect your TV to the Digital Satellite Receiver as shown below. Refer to your TV's instruction manual for more information.

- 1 If you have a local TV antenna or cable company service**
Connect it to the VHF/UHF IN jack on your Digital Satellite Receiver using a coaxial cable or RF adapter (not supplied).
You can view local stations using your TV controls.

Note
You must use the VHF(SAT)/UHF OUT jack to connect to your TV or VCR when a local TV antenna or cable company service is connected to the VHF/UHF IN jack (see "2c" below and on page 10).

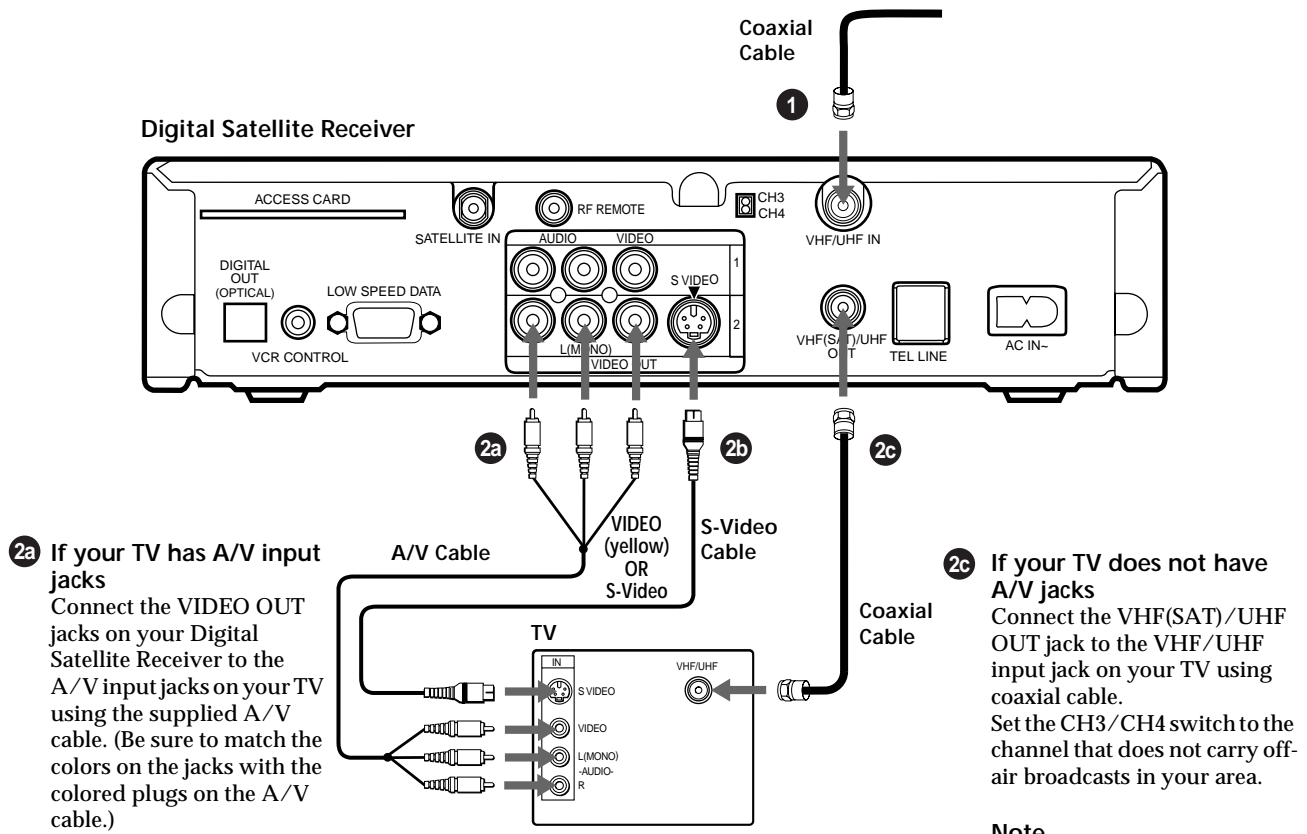

- 2a If your TV has A/V input jacks**
Connect the VIDEO OUT jacks on your Digital Satellite Receiver to the A/V input jacks on your TV using the supplied A/V cable. (Be sure to match the colors on the jacks with the colored plugs on the A/V cable.)

- 2b If your TV has an S-Video input**
Use the S-Video cable instead of the yellow video connection.
If your TV has only one audio input, connect it to the L(MONO) jack on the receiver.

- 2c If your TV does not have A/V jacks**
Connect the VHF(SAT)/UHF OUT jack to the VHF/UHF input jack on your TV using coaxial cable.
Set the CH3/CH4 switch to the channel that does not carry off-air broadcasts in your area.

Note
With this connection, your input source is channel 3 or channel 4 depending on how you set the CH3/CH4 switch on the receiver.

Step 4: Adding a VCR and Audio System

You can record programs by adding a VCR. You can also connect your Digital Satellite Receiver to an audio system for enhanced sound enjoyment.

- 1a** If you have a digital or Dolby® Digital audio system (SAT-A55 only) Connect the DIGITAL OUT (OPTICAL) of the Digital Satellite Receiver to the optical digital input of your audio system.



Tip
If you connect your Digital Satellite Receiver to a Dolby Digital receiver, set the Dolby Digital option of the Audio display to Auto Select. See "Setting Audio Options (AUDIO)" on page 64 for more information.

- 1b** If you have a stereo or Dolby Pro Logic® audio system Connect the upper AUDIO R and L(MONO) jacks on the Digital Satellite Receiver to the audio inputs of your stereo amplifier.

- 2a** If your TV and VCR have A/V jacks Connect the VIDEO OUT jacks of your Digital Satellite Receiver to the A/V input jacks of your VCR using the supplied A/V cable. Then, connect the A/V output jacks of your VCR to the A/V input jacks of your TV using an A/V cable. (Be sure to match the colors on the jacks with the colored plugs on the A/V cable.)

- 2b** If your TV and VCR have S-Video jacks Use the S-Video cable instead of the yellow video connection.



Tip
To allow your Digital Satellite Receiver to control the recording functions of your VCR, see "Step 5: Connecting the VCR Controller" on page 11.

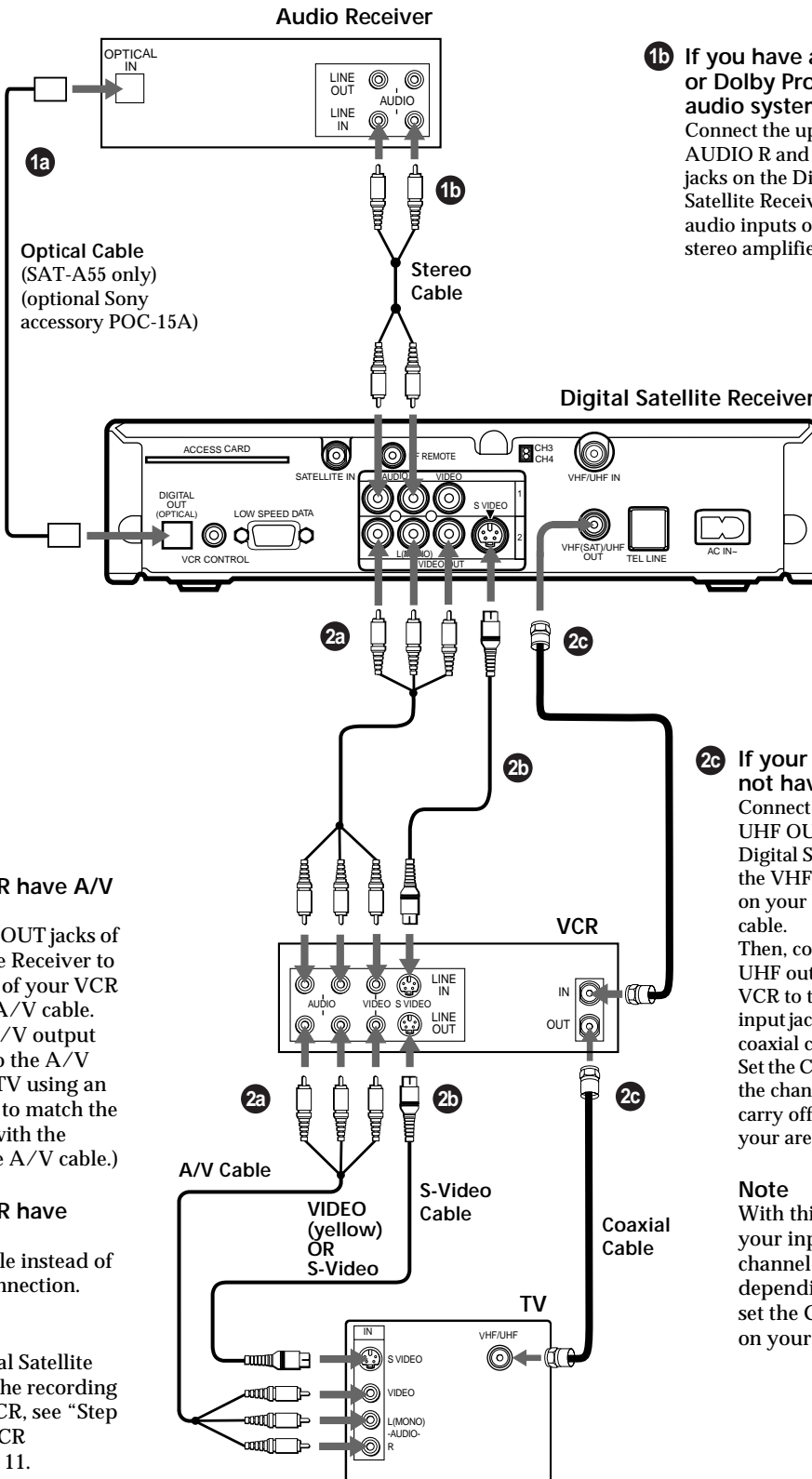

- 2c** If your TV and VCR do not have A/V jacks Connect the VHF(SAT)/UHF OUT jack on the Digital Satellite Receiver to the VHF/UHF input jack on your VCR using coaxial cable. Then, connect the VHF/UHF output jack on your VCR to the VHF/UHF input jack on your TV using coaxial cable. Set the CH3/CH4 switch to the channel that does not carry off-air broadcasts in your area.

Note
With this connection, your input source is channel 3 or channel 4 depending on how you set the CH3/CH4 switch on your VCR.

Step 5: Connecting the VCR Controller

Connect the VCR Controller to allow the Timer & Rec feature to automatically operate your VCR. See “Setting Up the VCR Control Feature” on page 26 for information about setting up the Digital Satellite Receiver to work with your VCR.

- 1a** To allow the Digital Satellite Receiver to control your VCR
Connect the VCR Controller to the VCR CONTROL jack on the receiver.

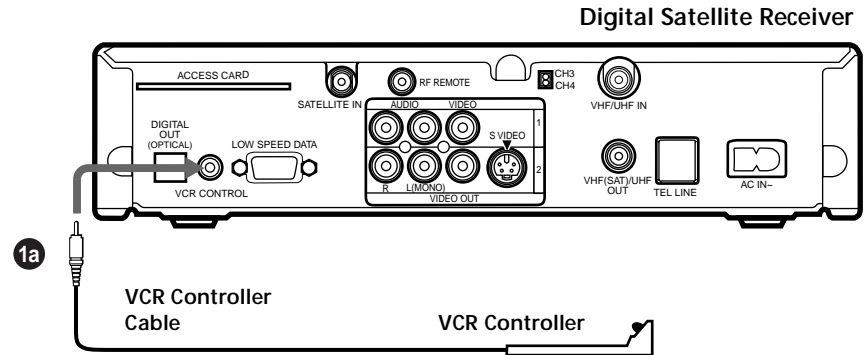

In front of the VCR

Place the VCR Controller under and in front of the VCR. The VCR Controller must extend just in front of the infrared sensor of the VCR.

Tip

If the infrared sensor is not marked on your VCR, shine a flashlight into the front panel of the VCR to locate the sensor.

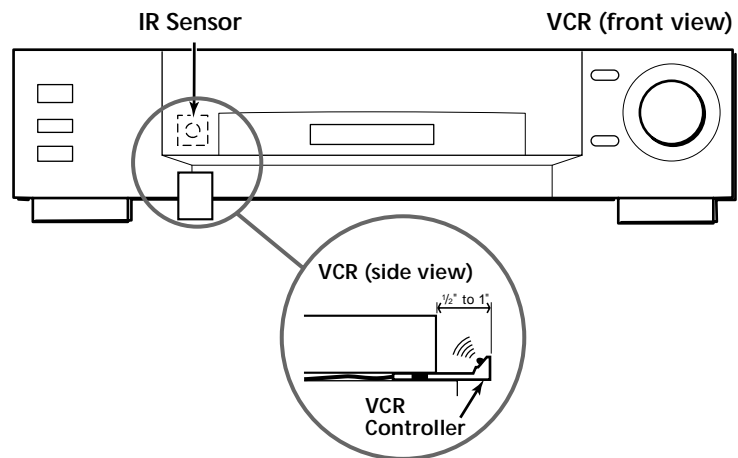

Connecting a Sony SmartFile™ VCR

- 1b** If you are using a Sony SmartFile VCR to take advantage of the Program Data Download feature Use this connection instead of the VCR Controller connection. For information about setting up the VCR control feature, see page 26. For details about the Program Data Download feature, refer to your SmartFile VCR Operating Instructions.

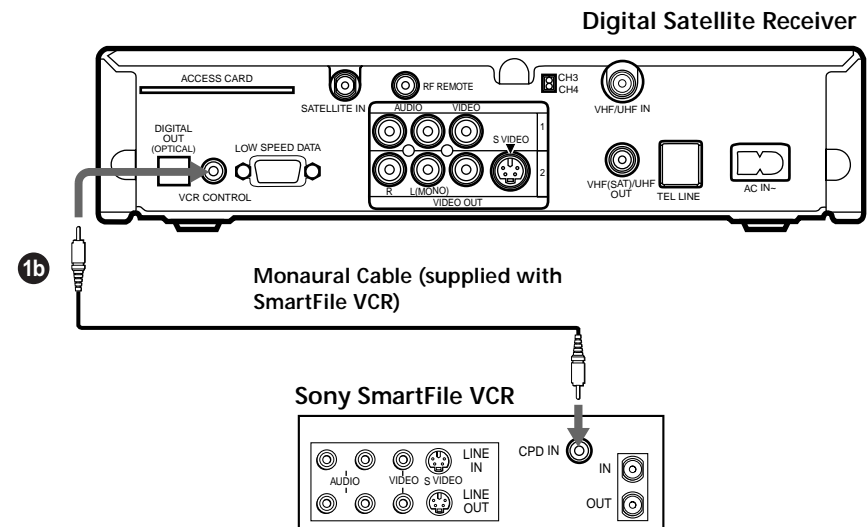

Step 6: Connecting the RF Antenna (SAT-A55 only)

With the SAT-A55 model you can connect the RF Antenna and operate the Digital Satellite Receiver when installed in a cabinet or from another room in your house using the remote control. See page 32 for information about how to set up the Digital Satellite Receiver to use the RF feature.

1 If you want to use the RF feature

Connect the RF Antenna to the RF REMOTE jack of the Digital Satellite Receiver. Then, place the RF Antenna in a convenient location.

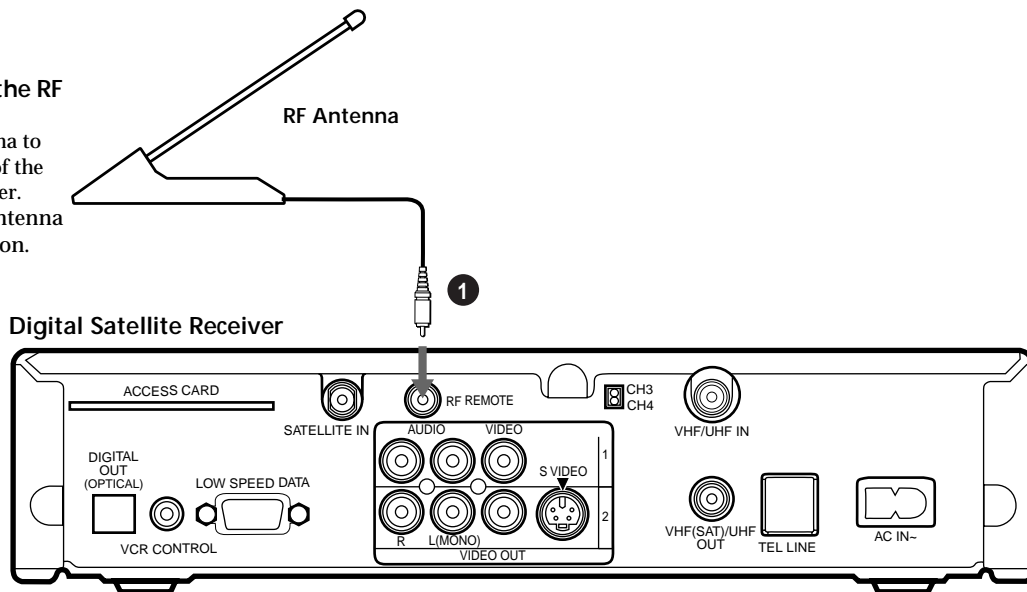

Notes

- Do not place the RF Antenna directly on top of the Digital Satellite Receiver or any other metal object. For best results, place the RF Antenna in a visible location.
- The operating range of the remote control is about 100 feet when using the RF feature. This may decrease due to ambient reception conditions, weak batteries, etc.

Step 7: Connecting the AC Power Cord

After all other connections are complete, connect the AC Power Cord to the Digital Satellite Receiver.

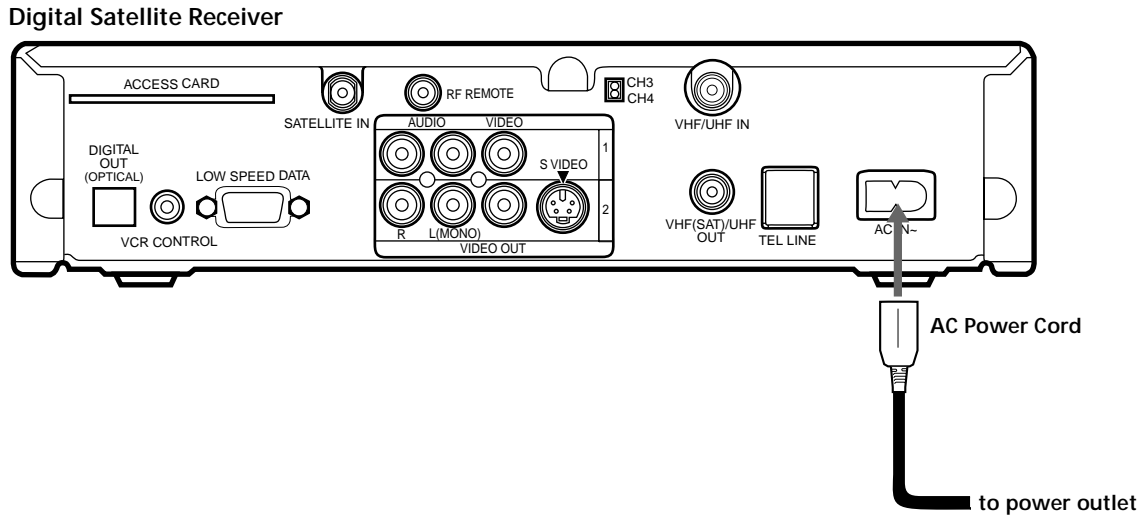

Step 8: Inserting the Access Card

After you insert the Access Card and your Satellite Dish Antenna is installed, you are ready to begin enjoying digital satellite programming. Call DIRECTV at 1-800-DIRECTV (347-3288) to begin service.

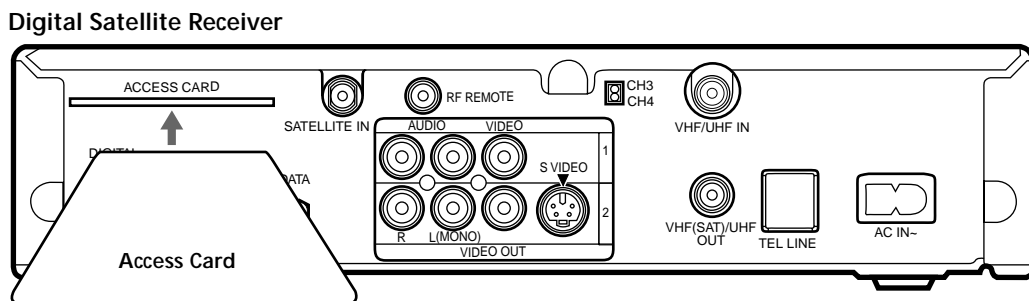

Using Your Remote Control

RM-Y802 Remote Control (SAT-A55 model)

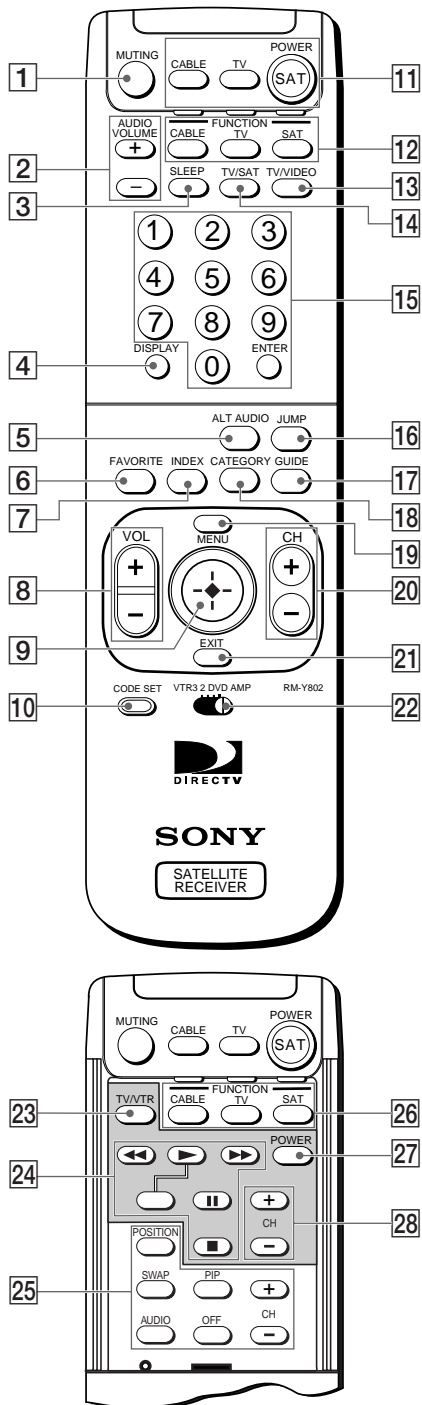

- 1 MUTING button**
Mutes the volume. Press again to restore the volume. To operate your TV, you must first set up the remote control (see page 65).
- 2 AUDIO VOLUME buttons**
Adjust the volume of your audio receiver. To operate your audio receiver, you must first set up the remote control (see page 65).
- 3 SLEEP button**
Sets the TV to turn off automatically after a certain amount of time (if your TV has the Sleep feature). To operate your TV, you must first set up the remote control (see page 65).
- 4 DISPLAY button**
Opens the program information display for the current program.
- 5 ALT AUDIO button**
Switches among the available audio broadcasts.
- 6 FAVORITE button**
Opens the Favorite Stations guide.
- 7 INDEX button**
Opens the Station Index.
- 8 VOL buttons**
Adjust the volume. To operate your TV, you must first set up the remote control (see page 65).
- 9 Joystick**
Moving the joystick up, down, left, right, and diagonally moves the highlight in on-screen displays. Press the joystick to select the highlighted item.
- 10 CODE SET button**
Lets you program the remote control to operate your TV and other audio/video equipment (see page 65).

Note

You may need to set up the remote control to operate your other audio/video equipment. See "Setting Up the Remote Control" on page 65 for details.

- 11 POWER buttons**
Turn on and off the Digital Satellite Receiver, TV and VTR (VCR). To operate your TV or VTR (VCR), you must first set up the remote control (see page 65).
- 12 FUNCTION buttons**
Select the equipment (CABLE, TV or SAT) that you want to operate. The indicators light up to show which device the remote control is operating. To operate your TV or cable box, you must first set up the remote control (see page 65).
- 13 TV/VIDEO button**
Switches between the various inputs of your TV. To operate your TV, you must first set up the remote control (see page 65).
- 14 TV/SAT button**
Switches the output of your Digital Satellite Receiver between regular TV and satellite broadcasts. To receive regular TV broadcasts, you must have a local TV antenna or cable company connection (see page 9).
- 15 0–9 and ENTER buttons**
Change channels directly, and enter numerical values in on-screen displays.
- 16 JUMP button**
Changes channels to the previously tuned channel.
- 17 GUIDE button**
Opens the Program Guide.
- 18 CATEGORY button**
Opens the Category Guide.
- 19 MENU button**
Opens the Main Menu.
- 20 CH buttons**
Change channels. When a program guide is open, pressing the CH buttons pages through the guide.
- 21 EXIT button**
Closes all on-screen displays including program guides and menus.
- 22 VTR3/2/DVD/AMP switch**
Sets the remote to operate other devices in your A/V system. To operate these other devices, you must first set up the remote control (see page 65).
- 23 TV/VTR button**
Switches between the TV and VTR (VCR) inputs of your TV. To operate your TV, you must first set up the remote control (see page 65).
- 24 VCR Control buttons**
Operate VCR features such as play, record, pause, stop, and fast wind. To operate your VCR, you must first set up the remote control (see page 65).
- 25 PIP control buttons**
Operate the Picture-in-picture features of your TV (if your TV has PIP). To operate your TV, you must first set up the remote control (see page 65).
- 26 FUNCTION buttons**
Select the equipment (CABLE, TV or SAT) that you want to operate. The indicators light up to show which device the remote control is operating. To operate your TV or cable box, you must first set up the remote control (see page 65).
- 27 POWER button**
Turns on or off the equipment selected with the VTR3/2/DVD/AMP switch.
- 28 CH +/- buttons**
Change channels in numerical order on the equipment selected with the VTR3/2/DVD/AMP switch.

RM-Y139 Remote Control (SAT-B55 model)

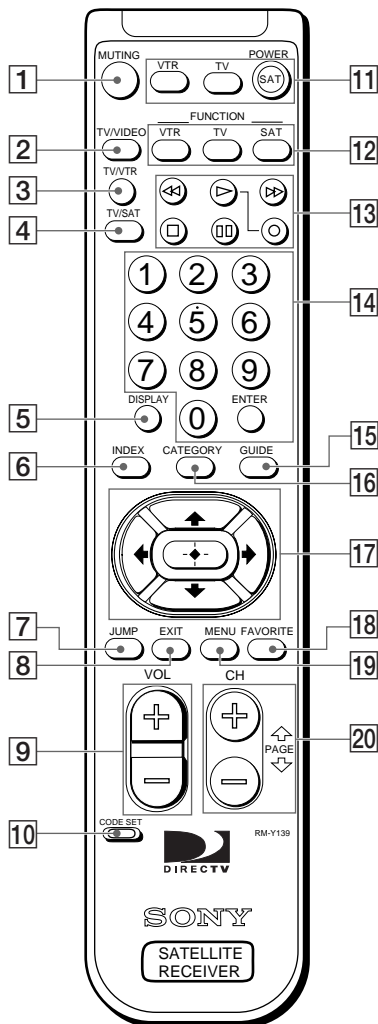

- 1 MUTING button**
Mutes the volume. Press again to restore the volume. To operate your TV, you must first set up the remote control (see page 65).
- 2 TV/VIDEO button**
Switches between the inputs of your TV. To operate your TV, you must first set up the remote control (see page 65).
- 3 TV/VTR button**
Switches between the inputs of your VCR. To operate your VCR, you must first set up the remote control (see page 65).
- 4 TV/SAT button**
Switches the output of your Digital Satellite Receiver between regular TV and satellite broadcasts. To receive regular TV broadcasts, you must have a local TV antenna or cable company connection (see page 9).
- 5 DISPLAY button**
Opens the program information display for the current program.
- 6 INDEX button**
Opens the Station Index.
- 7 JUMP button**
Changes channels to the previously tuned channel.
- 8 EXIT button**
Closes all on-screen displays including program guides and menus.

Note

You may need to set up the remote control to operate your other audio/video equipment. See "Setting Up the Remote Control" on page 65 for details.

- 9 VOL buttons**
Adjust the volume. To operate your TV, you must first set up the remote control (see page 65).
- 10 CODE SET button**
Lets you program the remote control to operate your TV and other audio/video equipment (see page 65).
- 11 POWER buttons**
Turn on and off the Digital Satellite Receiver, TV and VTR (VCR). To operate your TV or VTR (VCR), you must first set up the remote control (see page 65).
- 12 FUNCTION buttons**
Select the equipment (SAT, TV, VTR) that you want to operate. The indicators light up to show which device the remote control is operating. To operate your TV or VTR (VCR), you must first set up the remote control (see page 65).
- 13 VCR Control buttons**
Operate VCR features such as play, record, pause, stop, and fast wind. To operate your VTR (VCR), you must first set up the remote control (see page 65).
- 14 0-9 and ENTER buttons**
Change channels directly and enter numerical values in on-screen displays.
- 15 GUIDE button**
Opens the Program Guide.
- 16 CATEGORY button**
Opens the Category Guide.
- 17 Arrow and +/- buttons**
The arrow buttons move the highlight in on-screen displays. The +/- button selects the highlighted item.
- 18 FAVORITE button**
Opens the Favorite Stations guide.
- 19 MENU button**
Opens the Main Menu.
- 20 CH/PAGE buttons**
Change channels. When a program guide is open, these buttons page through the guide.

Selecting Items

In on-screen displays such as the Main Menu and program guides, you must first move the highlight to the item you want, then select the item.

RM-Y802 Remote Control (SAT-A55 model)

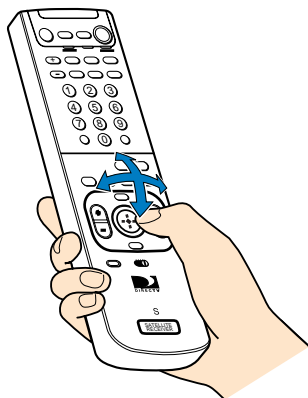

1 Move the joystick in any direction to move the highlight to the item you want.

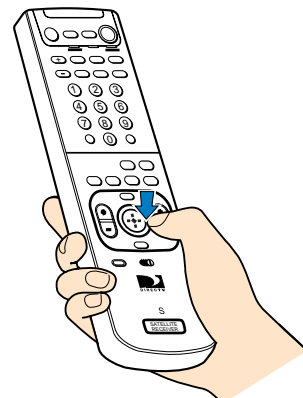

2 Press down on the joystick to select the item.

RM-Y139 Remote Control (SAT-B55 model)

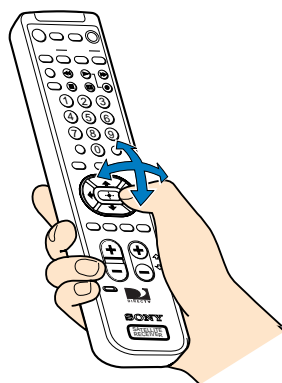

1 Press the $\uparrow/\downarrow/\leftarrow/\rightarrow$ buttons to move the highlight to the item you want.

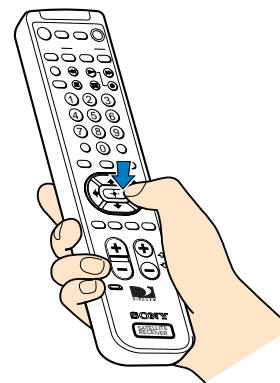

2 Press the \cdot button to select the item.

Note (SAT-B55 model)

Whenever these Operating Instructions refer to using the joystick, use the arrow $\uparrow/\downarrow/\leftarrow/\rightarrow$ buttons surrounding the \cdot button.



Tip
Be sure to press the SAT FUNCTION button before operating the Digital Satellite Receiver with the remote control.

Turning On the Power

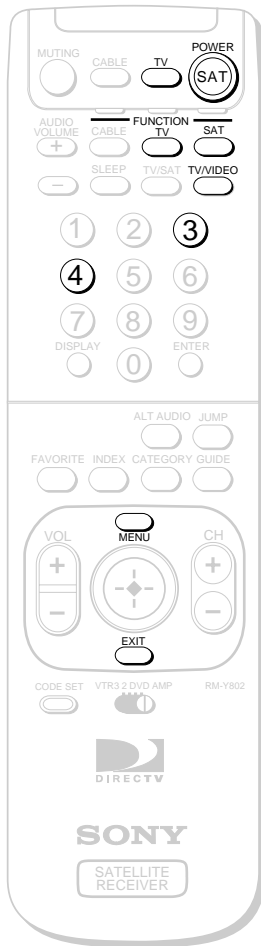

RM-Y802
Remote Control

1

Press the **POWER SAT** button to turn on the Digital Satellite Receiver.

The POWER indicator lights up.

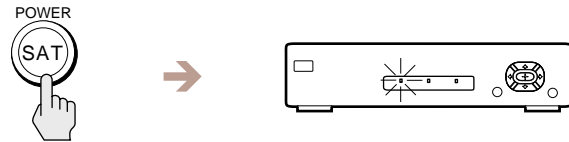

2

Press the **TV** button to turn on the TV.



3

Press the **TV FUNCTION** button, then select the TV's input source to which you connected the Digital Satellite Receiver.

Depending on how you connected your Digital Satellite Receiver to your TV, the input source could be channel 3 or channel 4, or you may need to use the TV/VIDEO button to select one of the A/V input sources.

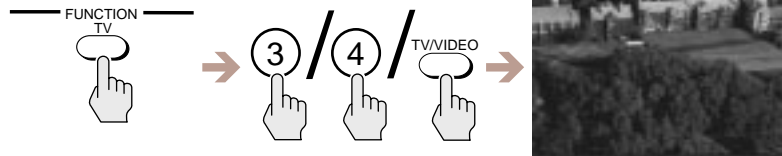

Tip
The **FUNCTION** button indicators light up to show you which equipment the remote control is operating.

Note

You may need to set up the remote control to operate your other audio/video equipment. See "Setting Up the Remote Control" on page 65 for details.

To make sure you are viewing satellite pictures

Press the **SAT FUNCTION** button, then press the **MENU** button to open the Main Menu.

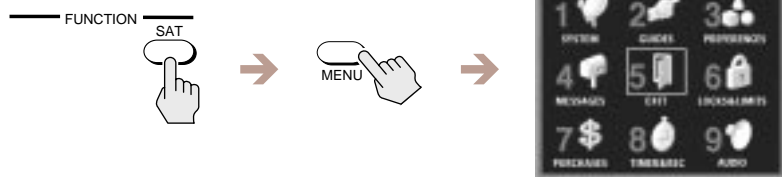

If the Main Menu does not appear, turn off your equipment, check your connections and repeat from step 1. Press the **EXIT** button to close the Main Menu.

Changing Channels

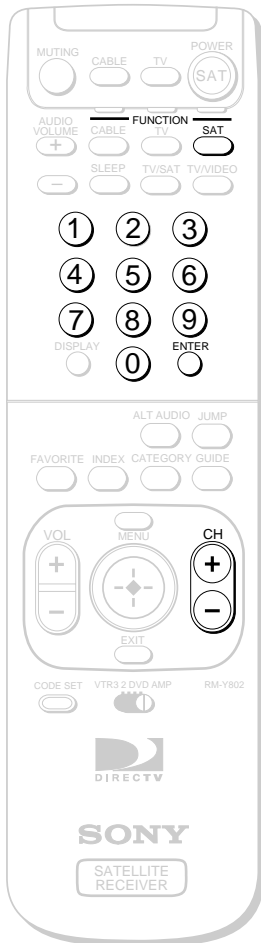

RM-Y802
Remote Control

1

Press the SAT FUNCTION button.

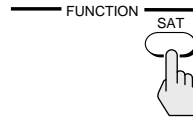

2

Press the CH +/- buttons.

The Digital Satellite Receiver tunes to the next channel, and the Station ID and channel number appear in the upper right corner of your TV screen.



You can also change channels by entering the three digit channel number using the 0-9 buttons, and either pressing the ENTER button or waiting several seconds.

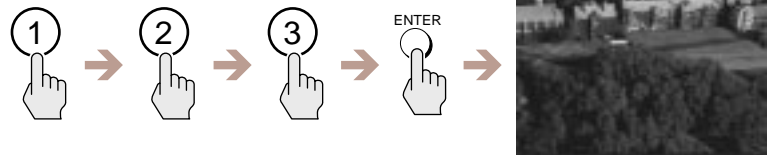

The Digital Satellite Receiver tunes to that channel, and the Station ID and channel number appear in the upper right corner of your TV screen.



Tip
You can see information about a program you are watching by pressing the DISPLAY button.

Using the On-Screen Displays

Using the Main Menu

The Main Menu acts as a gateway to all of the features your Digital Satellite Receiver has to offer.



RM-Y802
Remote Control

1 Press the MENU button.
The Main Menu appears.

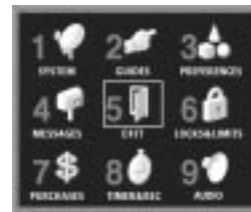

2 Highlight and select the feature you want to access.

SYSTEM (Page 22)
Adjust and test your Digital Satellite Receiver's settings.

- Antenna
- VCR Control
- System Test
- Aspect Ratio
- Access Card
- Remote Control (SAT-A55 only)

GUIDES (Page 35)
Access the many guides that help you find the program you want.

- Alpha List
- Program Guide
- Category Guide
- Station Index
- Favorite Stations
- Other Guides

PREFERENCES (Page 46)
Adjust the way menus and information appear.

- Display Options
- Custom Stations
- Data Services (future application)

MESSAGES (Page 52)
Read messages from your service provider.

LOCKS & LIMITS (Page 53)
Set limits on spending and ratings. Block stations and pay per view programs.

PURCHASES (Page 59)
Review the pay per view program purchases and cancellations you have made.

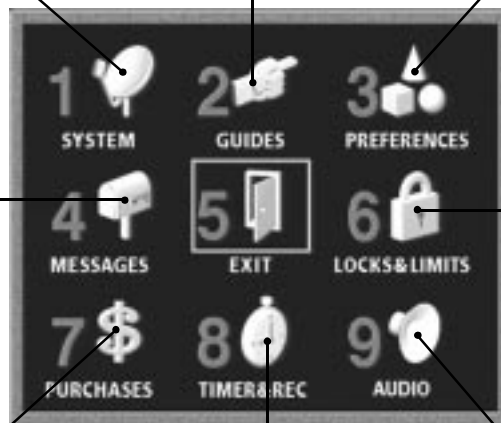

TIMER & REC (Page 60)
Schedule program tuning and recording.

AUDIO (Page 64)
Choose a preferred language for the default audio and current audio for multiple language programs. You can also select the Dolby Digital settings (SAT-A55 only).

Closing the Main Menu

- Highlight and select EXIT to close the Main Menu (the current program appears on your screen). You can also press the EXIT button on your remote control.
- The on-screen displays close automatically after several minutes.

Setting Up Your Digital Satellite Receiver (SYSTEM)

Using the System Menu

The System Menu provides many ways to adjust your Digital Satellite Receiver so it matches your preferences and optimizes the conditions of your home entertainment system.



RM-Y802
Remote Control

1 Press the MENU button, then highlight and select **SYSTEM**.

The SYSTEM pop-up appears.

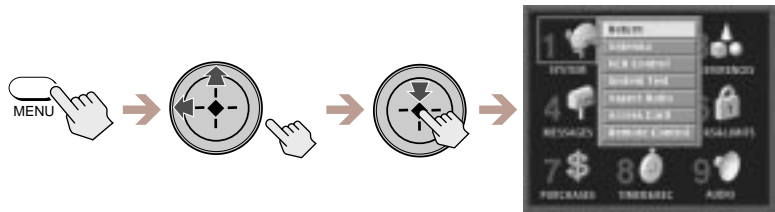

2 Highlight and select the item you want to set up.

Return

Closes the SYSTEM pop-up to show the Main Menu.

Antenna

Lets you find the position of the satellite and helps you get the strongest signal from your Satellite Dish Antenna (see page 23).

VCR Control

Lets you set up and test your VCR using the VCR Controller (see page 26).

System Test

Lets you test the connections to your Satellite Dish Antenna, and telephone line (see page 29).



Aspect Ratio

Lets you set the receiver's output to match the aspect ratio of your TV (see page 30).

Access Card

Lets you initialize a replacement card (see page 31).

Remote Control (SAT-A55 only)

Lets you set up the receiver so the remote control can operate the receiver from behind a cabinet or from another room (see page 32).

Setting Up the Satellite Dish Antenna



RM-Y802
Remote Control

This display helps you aim your Satellite Dish Antenna to get the strongest signal. For complete information on installation of your Satellite Dish Antenna, see the Satellite Dish Antenna Installation Instructions.

1 Press the MENU button, then highlight and select **SYSTEM**.
The SYSTEM pop-up appears.

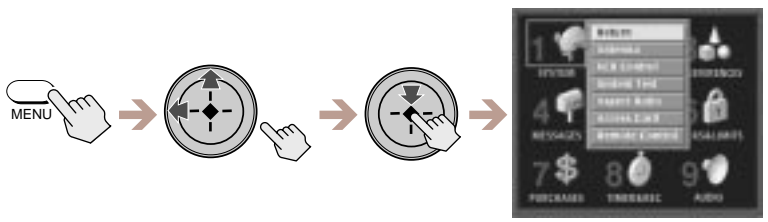

2 Highlight and select "Antenna".
The Antenna display appears.

- Antenna Type**
Select Round, Oval 2-Sat or Oval 3-Sat depending on your Satellite Dish Antenna type.
- Transponder**
Lets you select the transponder from which the Satellite Dish Antenna receives its signal. You do not need to change this setting unless instructed by your service provider.
- Antenna Location**
Lets you find out the direction of the satellite from your location.
- Azimuth, Elevation and Tilt**
Shows how to aim your Satellite Dish Antenna depending on your antenna type and location.
- Status**
"Locked" shows that your Satellite Dish Antenna is receiving a signal. "Unlocked" shows that a signal is not being received.

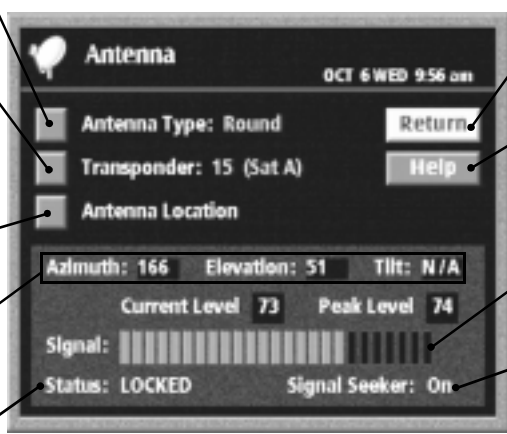

- Return**
Closes the Antenna display to show the Main Menu.
- Help**
Opens information about the Antenna display.
- Signal Strength Meter**
Shows the current and peak levels of the signal strength.
- Signal Seeker™**
When using a Round antenna, shows that your Satellite Dish Antenna's Signal Seeker can be used.

Note
Most areas of the United States will not receive a peak signal strength of 100. Although there is no picture quality difference between a signal strength of 60 and 100, a higher signal strength will limit any negative effects in degraded conditions such as rain or snow.

Setting Up Your Digital Satellite Receiver (SYSTEM) (continued)

Selecting an Antenna Type

The Antenna Type display lets you or your professional installer enter which type of Satellite Dish Antenna you use. After you have entered your antenna type, you can use the Antenna Location pop-up to help aim your antenna

- 1 Highlight and select "Antenna Type" from the Antenna Display.

The Antenna Type display appears.

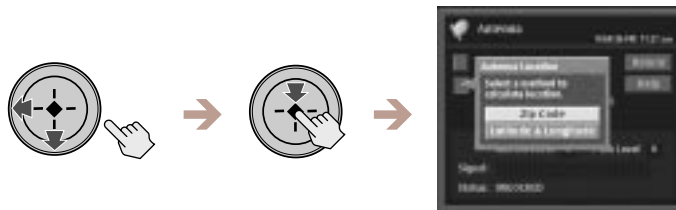

- 2 Highlight and select the Satellite Dish Antenna type that you have installed.

The Signal Seeker pop-up appears if you have selected "Round". The Antenna Type display closes if you have selected "Oval 2-Sat" or "Oval 3-Sat".

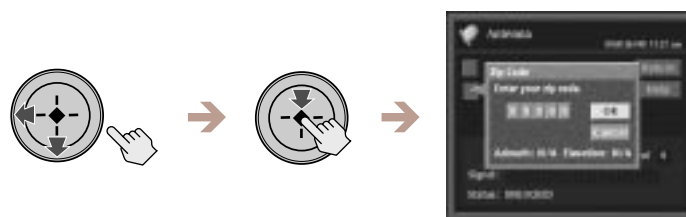

Tip

Selecting "off" in the Signal Seeker pop-up may allow you to see the Signal Strength Meter if you use a diplexer or certain other accessories with your Satellite Dish Antenna.

- 3 Highlight and select "On" if you selected "Round".

The Signal Seeker pop-up closes to show the Antenna Display.

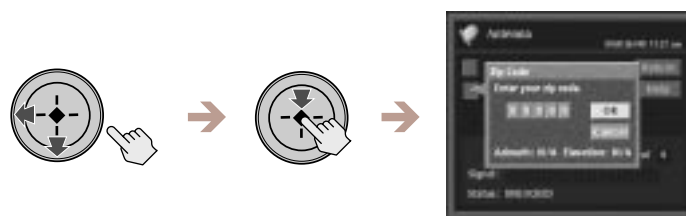

Note

The Signal Seeker feature is available only with the Round Antenna. See your Satellite Dish Antenna Installation Instructions for more information about this feature.

Entering Your Antenna Location

The Antenna Location pop-up helps you or your professional installer aim your Satellite Dish Antenna based on your zip code or your latitude and longitude location.

1 Highlight and select "Antenna Location" from the Antenna display.

The Antenna Location pop-up appears.

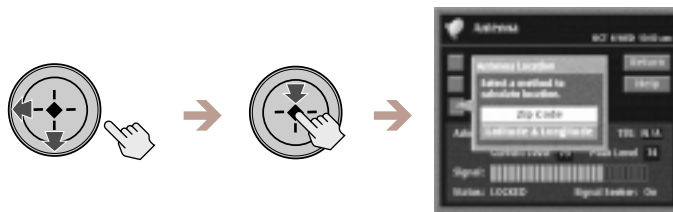

2 Select "Zip Code".

The Zip Code pop-up appears.



Tip

If it is more convenient for you to enter latitude and longitude, select "Latitude & Longitude" instead of "Zip Code".



3 Enter your Zip Code, then select "OK".

If you have a Round Satellite Dish Antenna, you or your professional installer can use the azimuth and elevation readings to aim the antenna. If you have an Oval 2-Sat or Oval 3-Sat Satellite Dish Antenna, you or your professional installer can use the azimuth, elevation and tilt readings to aim the antenna.

Note

Round Satellite Dish Antennas do not have a Tilt setting.

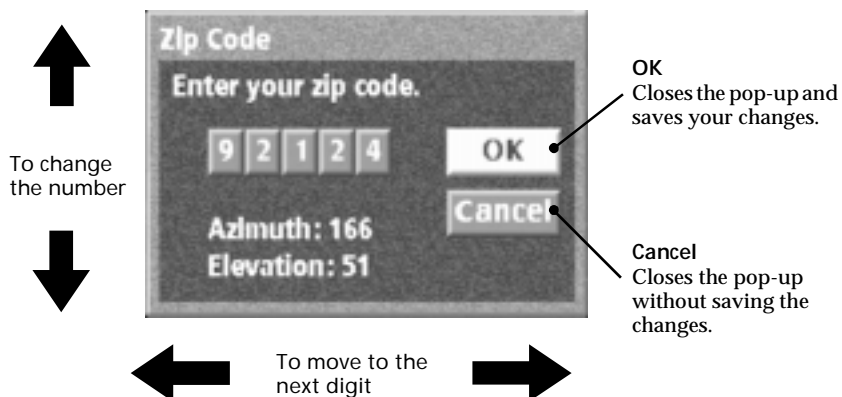

Setting Up Your Digital Satellite Receiver (SYSTEM) (continued)



RM-Y802
Remote Control

Setting Up the VCR Control Feature

The VCR Control feature lets the Digital Satellite Receiver control your VCR using the Timer & Rec feature (see page 60). To use the VCR Control feature you must connect the VCR Controller or a Sony SmartFile VCR (see page 11).

- 1** Press the MENU button, then highlight and select **SYSTEM**.
The SYSTEM pop-up appears.

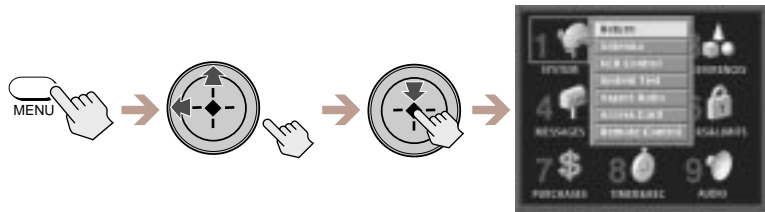

- 2** Highlight and select **"VCR Control"**.
The VCR Control display appears.

Manufacturer
Lets you select the manufacturer code for your VCR (see page 27).

Auto Title Insert
Lets you turn on the Auto Title Insert feature (see page 28).

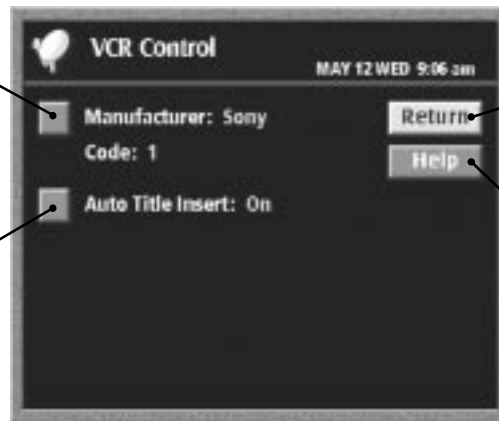

Return
Closes the VCR Control display to show the Main Menu.

Help
Opens information about the VCR Control display.

Setting the VCR Manufacturer Code

The VCR Manufacturer Code allows the Digital Satellite Receiver to control your VCR using the VCR Controller or a Sony SmartFile VCR.

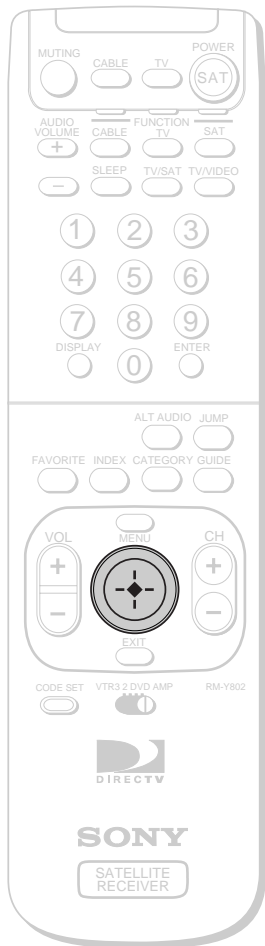

RM-Y802
Remote Control

- 1 Highlight and select "Manufacturer" from the VCR Control display (see page 26).**
The Manufacturer pop-up appears.

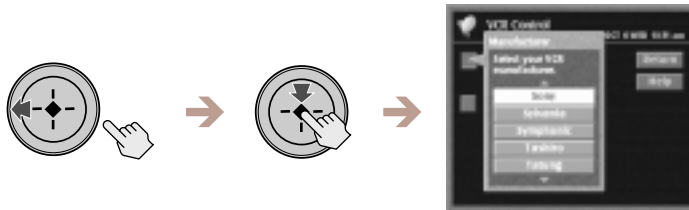

- 2 Highlight and select the manufacturer of your VCR.**
The manufacturer's pop-up appears.

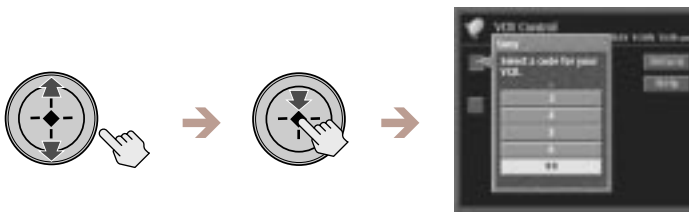

- 3 Select a VCR manufacturer code from the list.**
The Test pop-up appears.
Some manufacturers have more than one code to choose from. If the VCR manufacturer code you select does not work in step 4 below you can select another code for that manufacturer.

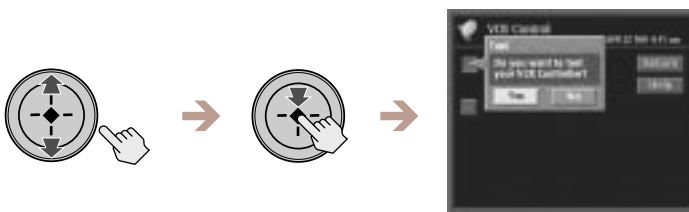

- 4 Select "Yes" to perform a VCR test.**
If you select "Yes", a pop-up appears giving you instructions on how to perform a VCR test.

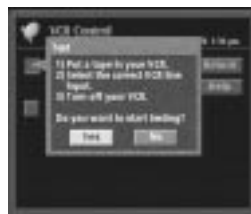

If the test is unsuccessful, check your connections and the VCR Controller placement, then repeat this procedure selecting a different VCR manufacturer code in step 3 (if your VCR manufacturer has more than one code).

Tip

If you connected a Sony SmartFile VCR, use the manufacturer code of 99.

Note

Do not stop or interrupt the VCR test by pressing any buttons until after the VCR test is complete.

continued

Setting Up Your Digital Satellite Receiver (SYSTEM) (continued)

Setting Up Auto Title Insert

The Auto Title Insert feature lets you display information about the program at the beginning of a Timer & Rec event. This is convenient if you want a "title" to appear at the beginning of programs you schedule or record.

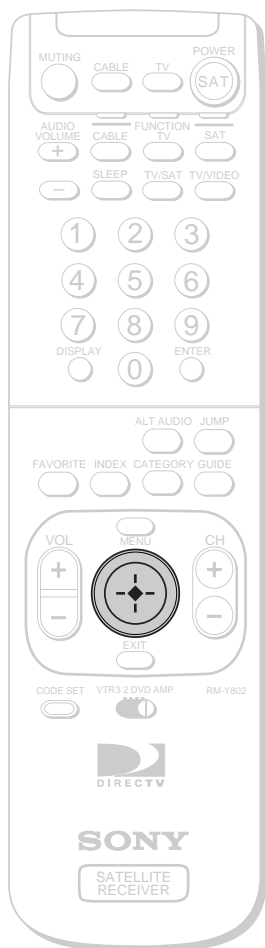

RM-Y802
Remote Control

- 1 Highlight and select "Auto Title Insert" from the VCR Control display (see page 26).

The Auto Title Insert pop-up appears.

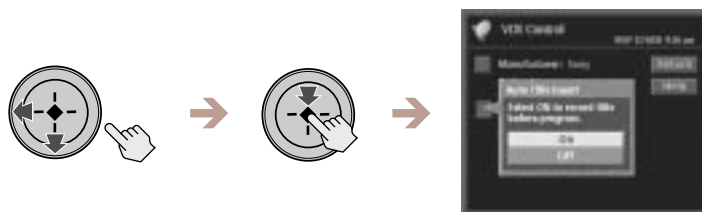

- 2 Select "On" or "Off".

The Auto Title Insert pop-up closes to show the VCR Control display.

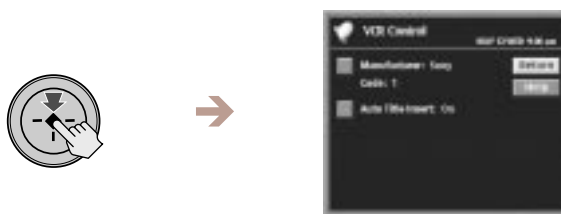

When the scheduled event begins

A title appears at the beginning of any Timer & Rec event.

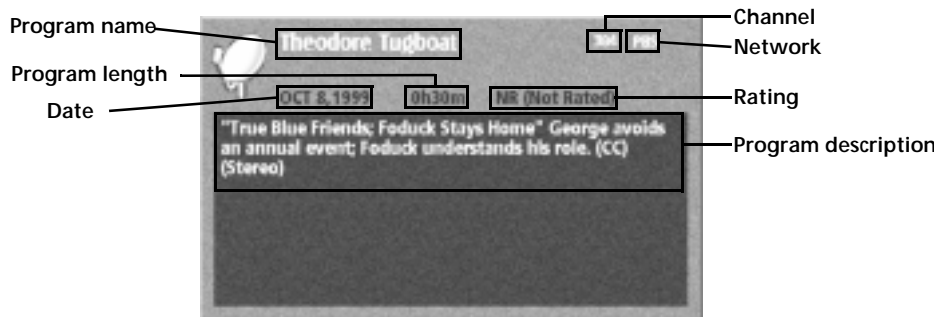

Note

When you schedule two or more consecutive programs, the Auto Title Insert feature will only appear before the first program.

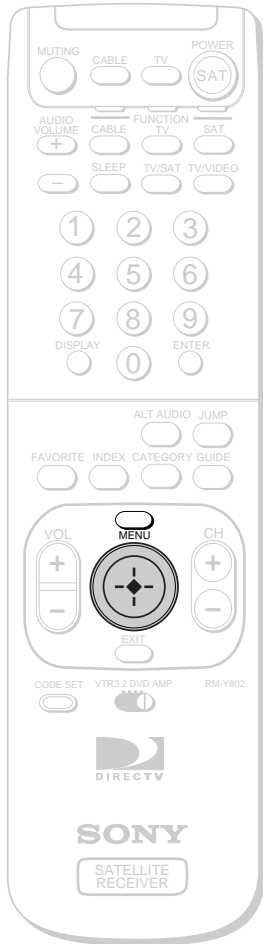

RM-Y802
Remote Control

Performing a System Test

The system test checks your Access Card, telephone line, and Satellite Dish Antenna connections for proper operation.

- 1 Press the MENU button, then highlight and select **SYSTEM**.

The SYSTEM pop-up appears.

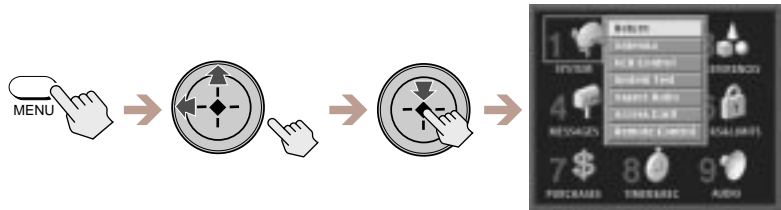

- 2 Highlight and select "System Test".

The System Test display appears.

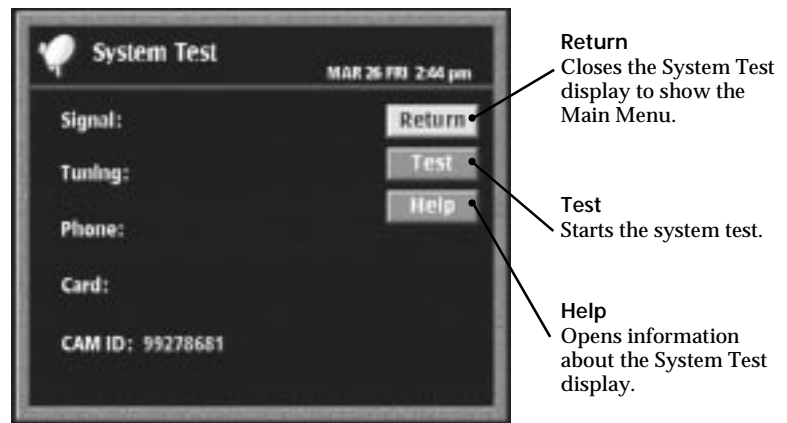

- 3 Highlight and select "Test".

The system test begins.

If the system test fails, check your connections before calling your service provider or Sony.

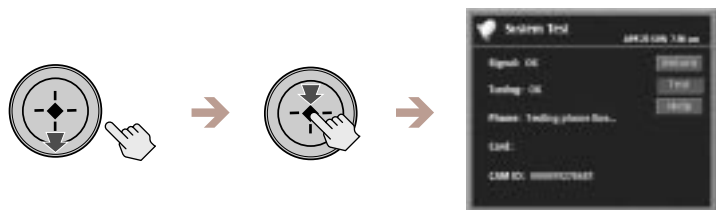

- 4 Select "Return".

The System Test display closes to show the Main Menu.

continued

Setting Up Your Digital Satellite Receiver (SYSTEM) (continued)

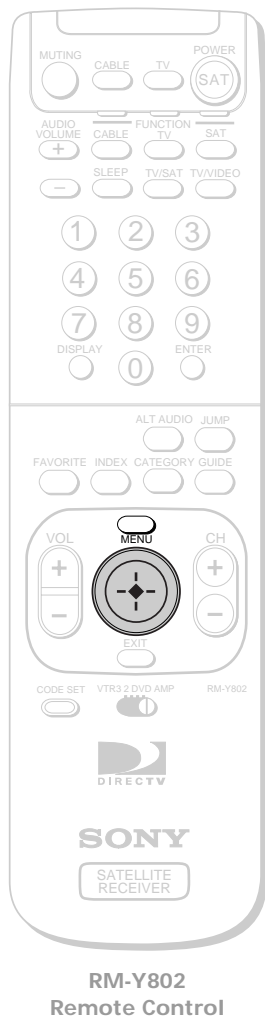

Setting the Aspect Ratio

The aspect ratio refers to the proportion of your TV screen. Some newer TVs may offer the 16:9 ratio which is similar to the proportions of a movie screen. Most TVs use the standard 4:3 ratio.

- 1 Press the MENU button, then highlight and select SYSTEM.

The SYSTEM pop-up appears.

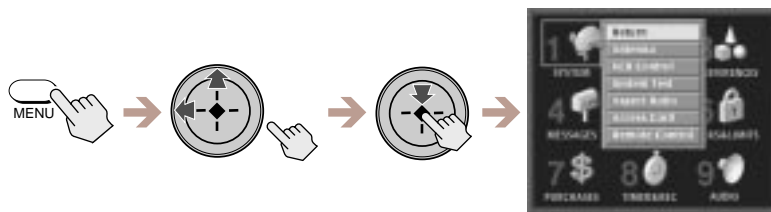

- 2 Highlight and select "Aspect Ratio".

The Aspect Ratio display appears.



Return
Closes the Aspect Ratio display to show the Main Menu.

Help
Opens information about the Aspect Ratio display.

- 3 Highlight and select the aspect ratio of your TV.

The highlight moves to "Return".

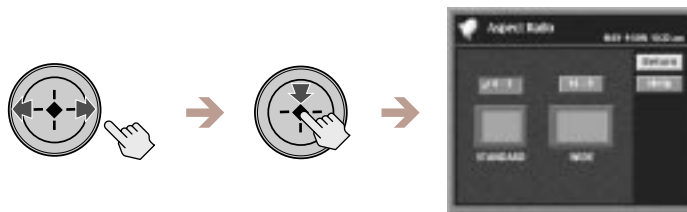

Note

To use the Wide aspect ratio feature, you must receive a 16:9 aspect ratio signal. Check with your service provider to see if 16:9 programming is available.

- 4 Select "Return".

The Aspect Ratio display closes to show the Main Menu.

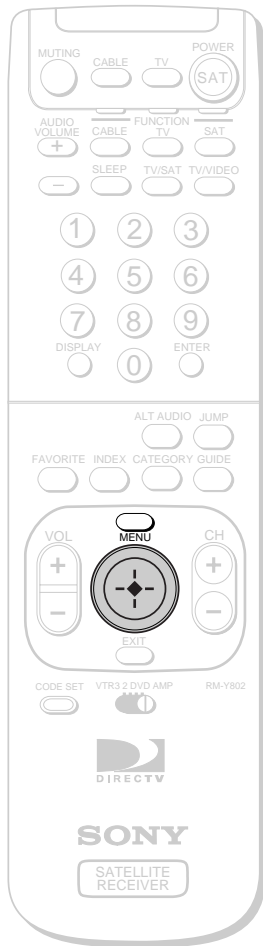

RM-Y802
Remote Control

Replacing Your Access Card

Occasionally your service provider may send you a new Access Card. Use this display to set up your new card. See “Inserting the Access Card” on page 13 for information about inserting the Access Card into the Digital Satellite Receiver.

- 1 Press the MENU button, then highlight and select **SYSTEM**.
The SYSTEM pop-up appears.

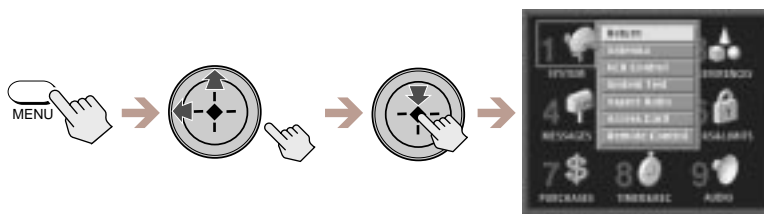

- 2 Highlight and select “Access Card” from the System pop-up.
The Access Card display appears.

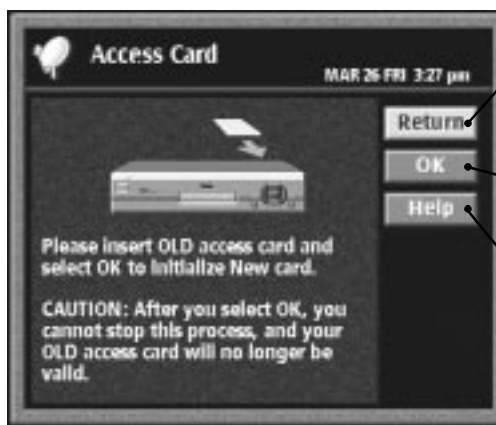

- Return**
Closes the Access Card display to show the Main Menu.
- OK**
Starts the Access Card replacement process.
- Help**
Opens information about the Access Card display.

- 3 Highlight and select “OK”.
The display shows instructions on how to proceed.



- 4 Follow the instructions in each display to complete the replacement process.

Setting Up Your Digital Satellite Receiver (SYSTEM) (continued)

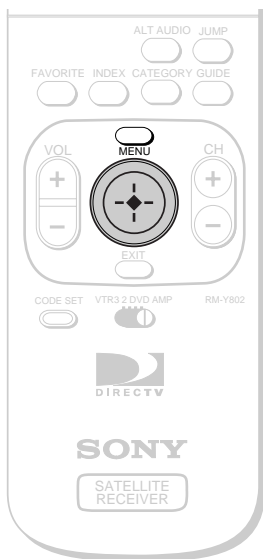

RM-Y802
Remote Control

1 Selecting RF or IR Remote Control Reception (SAT-A55 only)

The RF feature allows you to operate the Digital Satellite Receiver from outside a cabinet or from another room within your home. The RF Antenna must be connected to use the RF feature (see page 12).

- 1** Press the MENU button, then highlight and select **SYSTEM**.
The SYSTEM pop-up appears.

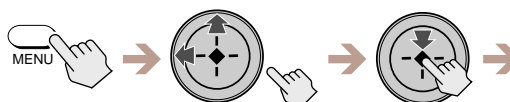

- 2** Highlight and select **"Remote Control"**.
The Remote Control display appears.

Remote Signal

Lets you select IR or RF as the type of signal the receiver accepts.

RF Security Control

Lets you change the security code. RF signals are used to control many devices. You may need to change the security code so that this remote control operates the Digital Satellite Receiver only.



Return

Closes the Remote Control display to show the Main Menu.

Help

Opens information about the Remote Control display.

- 3** Highlight and select **"Remote Signal"**.
The Remote Signal pop-up appears.

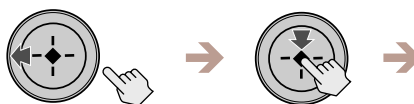

4

Highlight and select "RF".

The Remote Signal pop-up closes to show the Remote Control display.



5

Highlight and select "Return".

The display closes to show the Main Menu, and the Digital Satellite Receiver is set to receive RF signals from the remote control.

Setting the Security Code

If the Digital Satellite Receiver is receiving signals from another RF remote control in your home (or from your neighbor's home), you can eliminate this problem by changing the security codes for the Digital Satellite Receiver and remote control, or by selecting IR control. Both the Digital Satellite Receiver and the remote control must use the same three digit security code.

1 Select "Remote Control" from the SYSTEM pop-up (see page 32).

The Remote Control display appears.

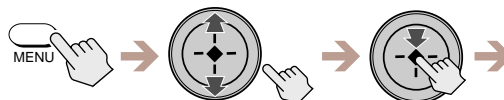

2 Highlight and select "RF Security Code".

The confirmation pop-up appears.

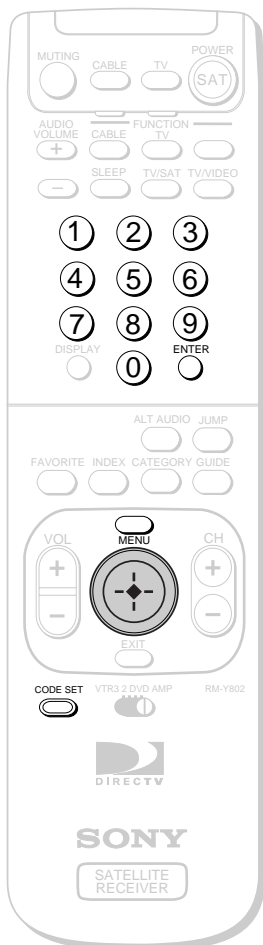
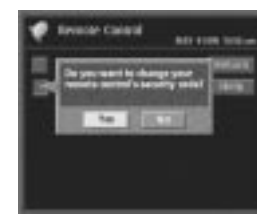

RM-Y802 Remote Control

continued

Setting Up Your Digital Satellite Receiver (SYSTEM) (continued)

3 Select "Yes".

The RF Security Code pop-up appears.



4 Select a different security code.

The conformation pop-up appears.

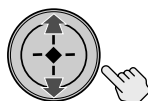

5 Press the CODE SET button on the remote control.

The CABLE and TV FUNCTION indicators flash.

CODE SET

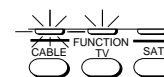

6 Enter the three digit security code you selected for the receiver in step 4 above.

7 Press the enter button.

The remote control and Digital Satellite Receiver are now set to a new security code.

ENTER



8 Select "OK" to save your changes.

The Remote Control display appears.



Note

If the remote control no longer operates your Digital Satellite Receiver after completing this procedure, use the controls on the front panel to open the Remote Control display (see page 32). Then repeat the steps in "Setting the Security Code" to try again.

Viewing Station and Program Information (GUIDES)



Using the Guides Menu

The Guides Menu helps you find the program you want to watch. You can choose to see all stations or just a few. You can also create your own favorite station guides for fast access to your favorite stations.

1 Press the MENU button, then highlight and select GUIDES.

The GUIDES Menu appears.

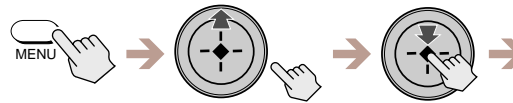

2 Highlight and select the guide you want to use.

Return

Closes the GUIDES Menu to show the Main Menu.

Alpha List

Shows a list of categories (movies, sports, etc.) and only the programs that match the category you select in alphabetical order (see page 36).

Program Guide

Opens your custom list of stations and shows program information for up to three days in advance (see page 37).

Category Guide

Shows a list of categories (movies, sports, etc.) and only those stations broadcasting programs that match the category you select (see page 38).

Tips

- Be sure to press the SAT FUNCTION button before operating the Digital Satellite Receiver with the remote control.
- You can see information about a program you are watching by pressing the DISPLAY button.

Station Index

Opens your custom list of stations as a grid of station logos (see page 39).

Favorite Stations

Opens the Favorite Stations guide which allows you to create and access up to four different sets of stations you enjoy watching most (see page 40).

Other Guides

Opens the Other Guides display which shows a variety of special categories provided by DIRECTV. Each category is divided into subcategories so you can find exactly the kind of program you want (see page 43).



continued

Viewing Station and Program Information (GUIDES) (continued)

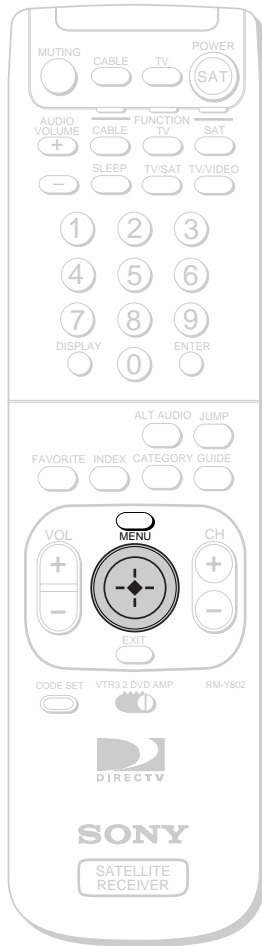

RM-Y802
Remote Control

Using the Alpha List

The Alpha List shows program information in the category you select (such as movies, sports, etc.) in alphabetical order. Program information is available for up to four hours in advance.

- 1 Press the MENU button, then highlight and select GUIDES.**

The GUIDES Menu appears.

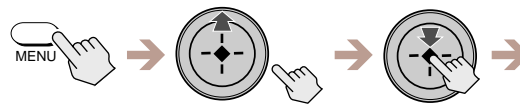

- 2 Highlight and select "Alpha List".**

The Alpha List guide appears.

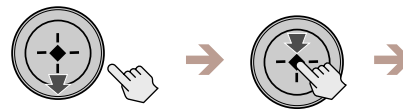

- 3 Highlight and select a category.**

Programs appear in alphabetical order.

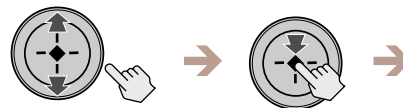

- 4 Highlight and select a program.**

If you select a current program, the Alpha List guide closes. For information about selecting a future program see "Using One Button Timer & Rec" on page 60.



Using the Program Guide

The Program Guide shows program information for up to three days in advance. You can open the Program Guide using the Main Menu or by pressing the GUIDE button.

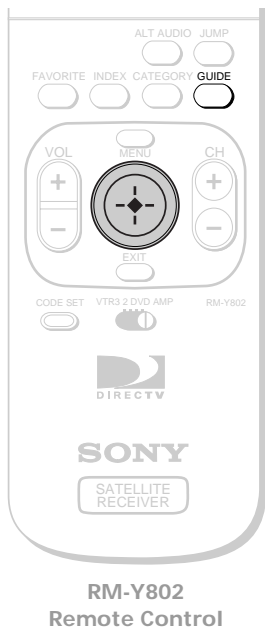

1 Press the GUIDE button.

The Program Guide opens and the current program appears in the Media Window.



2 Highlight the program you want.

The sound and the picture in the Media Window change as you highlight different programs. Skipped stations do not appear (see page 50).

Media Window



Move the joystick up and down to highlight different stations.

Press the CH \uparrow/\downarrow buttons to move the highlight to the next page of stations.

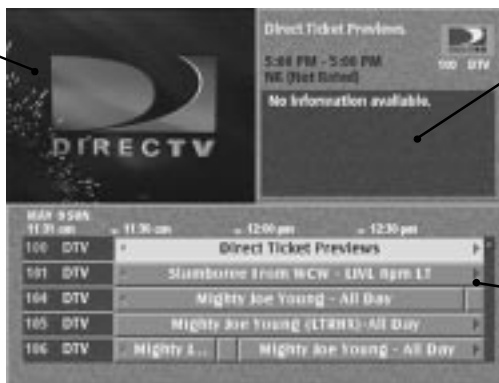

Information Area

List Area



Move the joystick right to highlight future programs.



3 Select the program you want.

If you select a current program, the Program Guide closes. For information about selecting a future program, see “One Button Timer & Rec” on page 60.



continued



Tip
Press the EXIT button to close the Program Guide and return to the previous station.

Note

If you select a program and the station is blocked or a limit has been reached, you can temporarily unlock your Digital Satellite Receiver using your passcode. See “Locking Your Receiver” on page 57 for information about the passcode.

Viewing Station and Program Information (GUIDES) (continued)

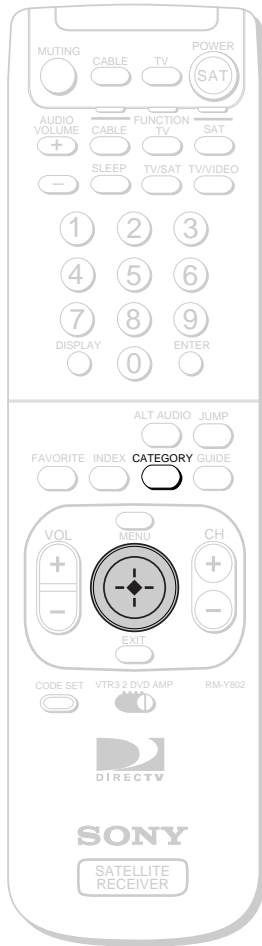

RM-Y802
Remote Control



Tip
Press the EXIT button to close the Category Guide and return to the previous station.

Using the Category Guide

The Category Guide shows programs in the category you select (such as movies, sports, etc.). Program information is available for up to three days in advance. You can open the Category Guide using the Main Menu or by pressing the CATEGORY button.

1

Press the CATEGORY button.

The Category Guide opens and the current program appears in the Media Window.



2

Highlight and select the category you want.

The program list changes each time you select a different category. Skipped stations do not appear (see page 50).

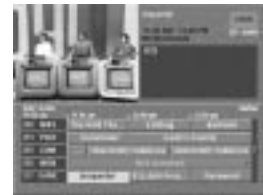
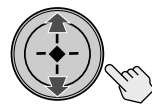

3

Highlight and select the program you want.

If you select a current program, the Program Guide closes. For information about selecting a future program, see "One Button Timer & Rec" on page 60.

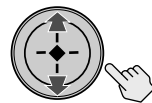

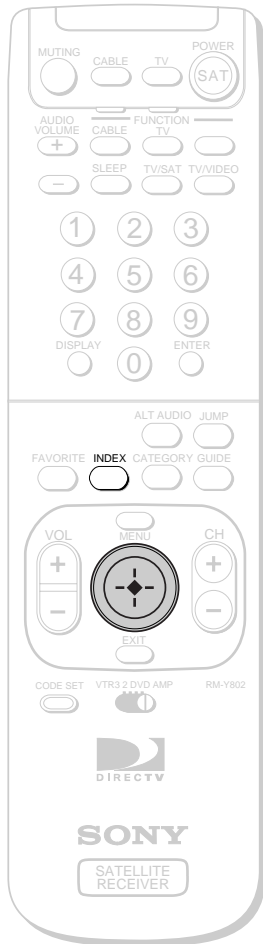

RM-Y802
Remote Control

Using the Station Index

The Station Index displays each station's logo and channel number in a grid format. Program information is available for the current time only. You can open the Station Index using the Main Menu or by pressing the INDEX button.

1 Press the INDEX button.

The Station Index opens and the current program appears in the Media Window.



2 Highlight the station you want.

The sound and the picture in the Media Window change as you highlight different stations. Skipped stations do not appear (see page 50).

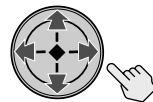

3 Select the station you want.

The Station Index closes and the program broadcast by the station you selected appears on your TV screen.



Tips

- Press the EXIT button to close the Station Index and return to the previous station.
- To view the current program while checking the program information of other stations, turn on the Surf feature (see page 49).

Viewing Station and Program Information (GUIDES) (continued)

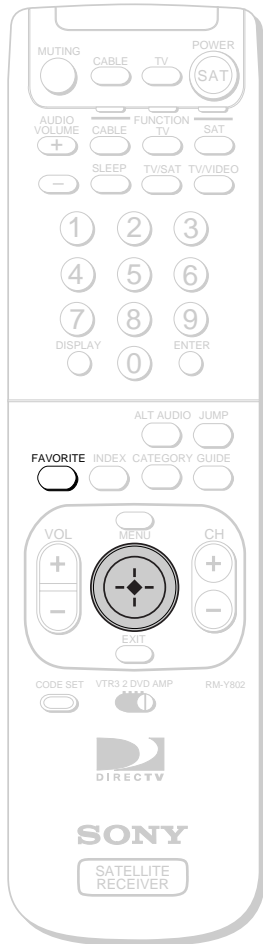

RM-Y802
Remote Control

Using the Favorite Stations Guide

The Favorite Stations guide shows four Favorite Titles that you can customize with eight stations each. Program information is available for the current time only.

You can open the Favorite Stations guide using the Main Menu or by pressing the FAVORITE button.

Before you can use the Favorite Stations guide, you must set up your favorite stations in a personal guide by following the procedure on the next page.

1

Press the FAVORITE button.

The Favorite Stations guide opens and the current program appears in the Media Window.



2

Highlight and select the Favorite Title you want.

The station list in the right half of the display changes as you highlight different Favorite Titles.

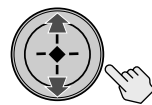

3

Highlight and select the station you want.

The Favorite Stations guide closes and the program broadcast by the station you selected appears.

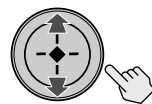

Tip

Press the EXIT button to close the Favorite Stations guide and return to the previous station.

Customizing the Favorite Stations Guide

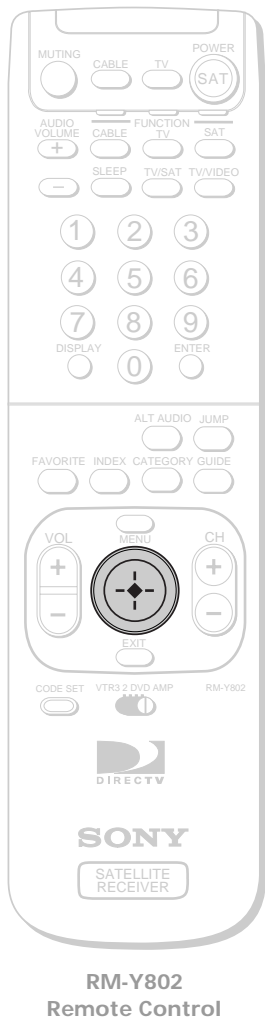

- 1 Highlight and select the Favorite Title you want to customize.**
The station list appears in the right half of the display.

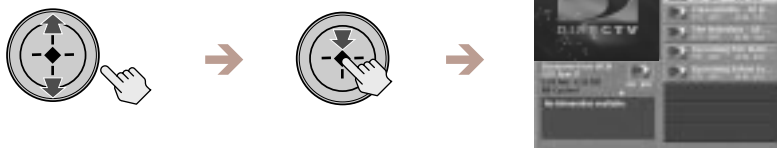

- 2 Highlight and select "Edit".**
The Edit pop-up appears.

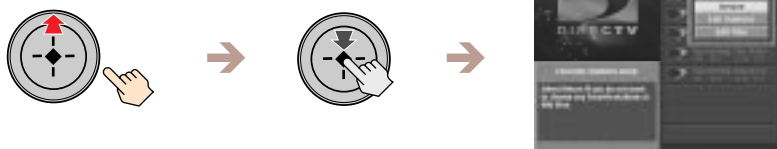

- 3 Highlight and select "Edit Stations".**
The station index appears in the right half of the display.

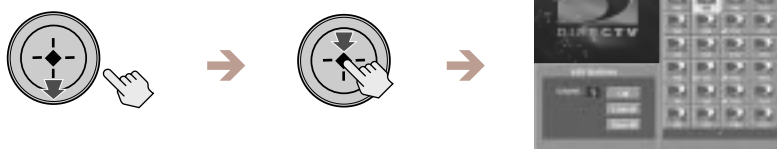

- 4 Highlight and select a station in the index.**
A checkmark appears in the lower left part of the icon to indicate that the station is included in the Favorite Title, and the number in the "Count" box increases by one.

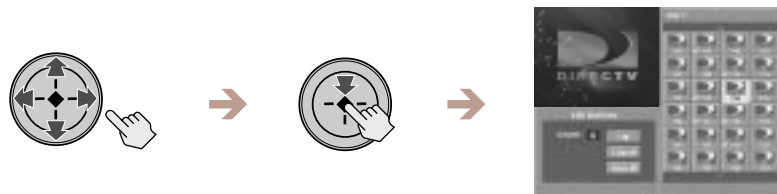

- 5 Repeat step 4 to add up to eight stations to this Favorite Title.**
When you have added all the stations you want in this Favorite Title, highlight and select OK.

Tip

Press the EXIT button to close the Favorite Stations guide and return to the previous station.

Note

The "Count" box indicates how many stations are included in the personal guide.

continued

Viewing Station and Program Information (GUIDES) (continued)

Editing the Title of a Favorite Title

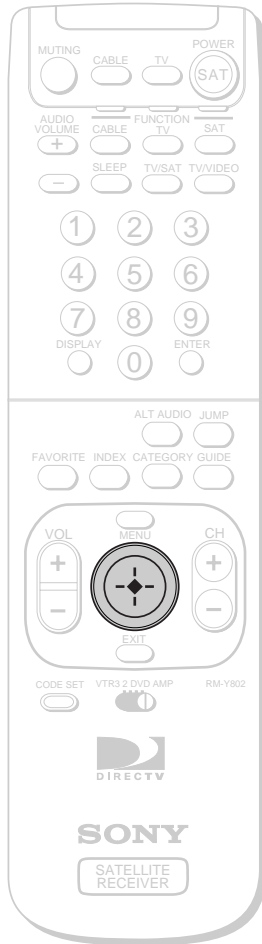

RM-Y802
Remote Control

- 1 Highlight and select the Favorite Title you want to edit.**
The station list appears in the right half of the display.

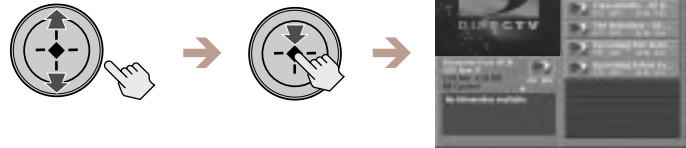

- 2 Highlight and select "Edit".**
The Edit pop-up appears.

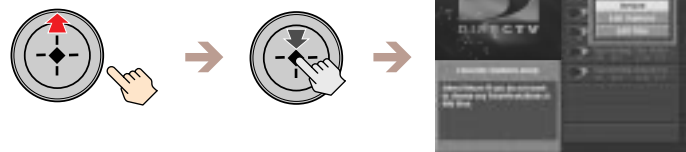

- 3 Select "Edit Title" from the pop-up menu.**
The Edit Title display appears in the lower left part of the display.

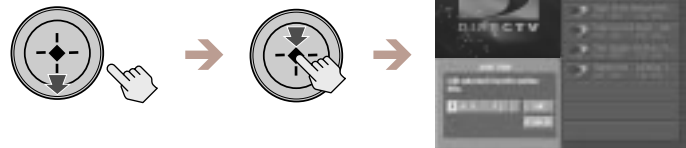

- 4 Enter a seven character title for this Favorite Title.**
You can enter upper and lower case letters, numbers, and symbols in the title.

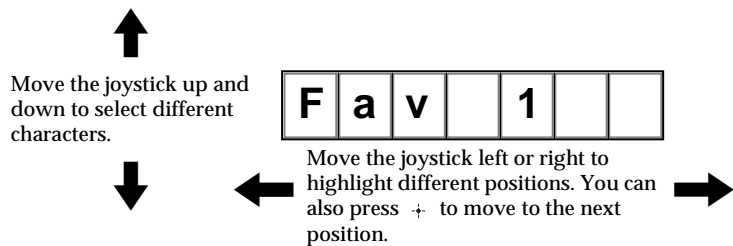

- 5 When your title is complete, highlight and select "OK".**
The Edit Title pop-up closes to show the Favorite Stations guide.



Tip
Press the EXIT button to close the Favorite Stations guide and return to the previous program.

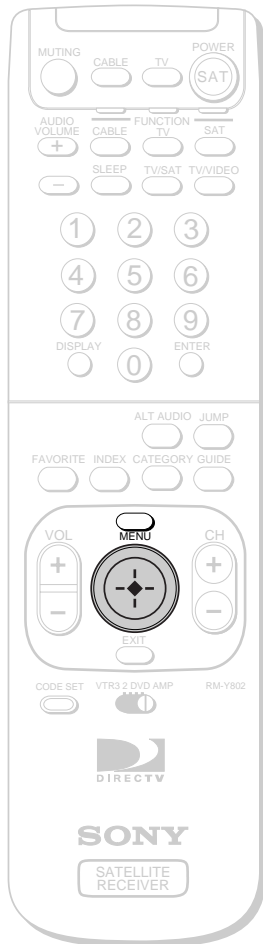

RM-Y802
Remote Control

Using Other Guides

The Other Guides display provides special categories supplied by DIRECTV. Each category is divided into subcategories to help you find the exact program you want to watch. Program information is available for up to three days in advance.

- 1 Press the MENU button, then highlight and select GUIDES.

The GUIDES pop-up appears.

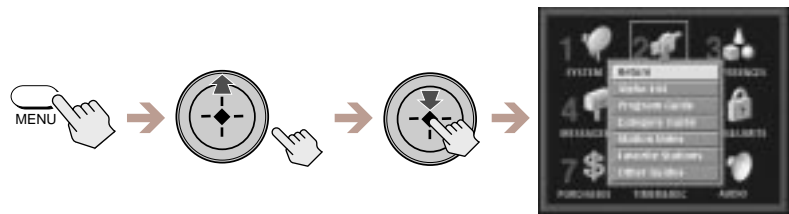

- 2 Highlight and select "Other Guides".

The Other Guides display appears.

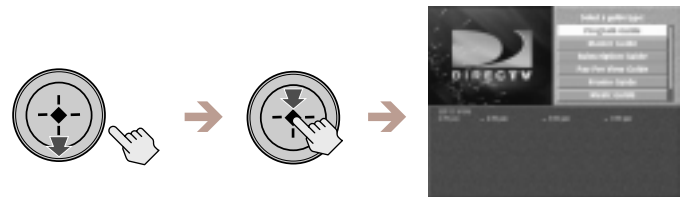

- 3 Select the Guide Type you want.

The available time ranges appear.

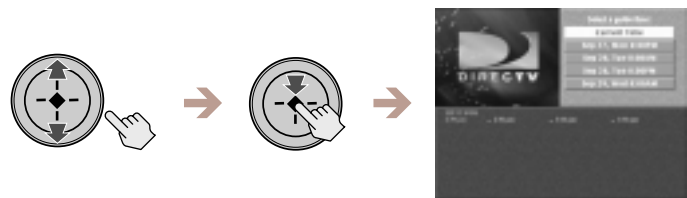

- 4 Select the time range you want.

The available categories appear.

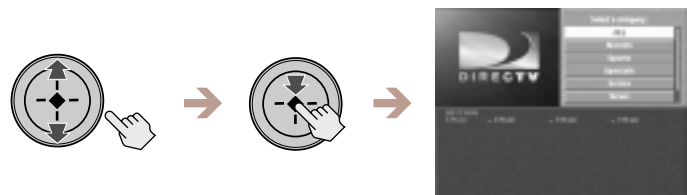

Tip

Press the EXIT button to close the Other Guides display and return to the previous station.

Note

DIRECTV occasionally changes the contents of the category and subcategory lists.

Viewing Station and Program Information (GUIDES) (continued)

5

Select the category you want.

If the category you select has subcategories, the available subcategories appear.

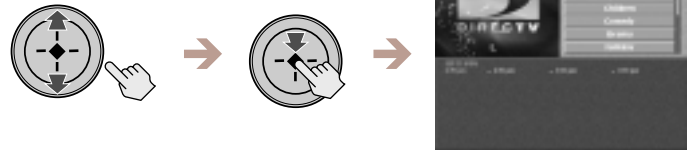

6

Select the subcategory you want.

The programs that match your selections appear in the lower half of the display.

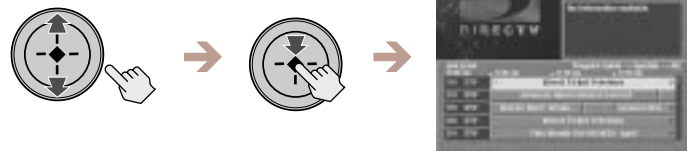

7

Highlight and select the program you want.

If you select a current program, the Other Guides display closes. For information about selecting a future program, see "One Button Timer & Rec" on page 60.

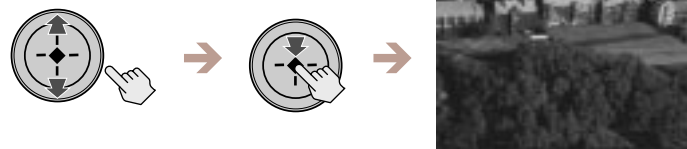

Viewing Pay Per View Programs

Many programs are available as pay per view. By selecting a pay per view program you agree to be charged for that program.

Select a pay per view program using any of the methods described in the "Viewing Station and Program Information (GUIDES)" section on pages 35 through 44.

The Purchase Program display appears. This display shows detailed information about the program including the cost.

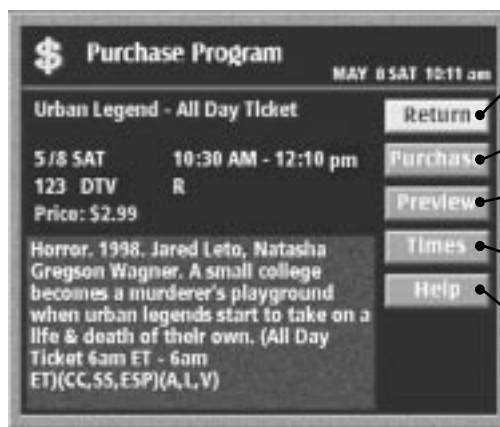

Return

Closes the Purchase Program display to show the previous screen.

Purchase

Opens the Purchase pop-up.

Preview

Closes the Purchase Program display to show a preview of the program if available.

Times

Opens the Other Show Times display so you can select another time to view the program.

Help

Opens information about the Purchase Program display.

Note

To order pay per view by remote, a DIRECTV subscription is required and the Digital Satellite Receiver must be continuously connected to a land-based phone line.

Adjusting the Displays (PREFERENCES)



Using the Preferences Menu

The Preferences Menu lets you change the appearance of the on-screen displays, the stations you want to appear in the program list area, and the order in which the stations are listed.

- 1** Press the MENU button, then highlight and select PREFERENCES.
The PREFERENCES Menu appears.

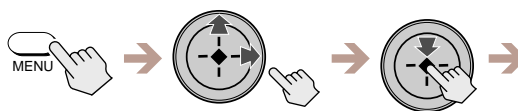

- 2** Highlight and select the item you want to adjust.

Return

Closes the PREFERENCES Menu to show the Main Menu.

Display Options

Lets you change the color scheme of the on-screen displays, choose how the stations are ordered in the guides and select what is displayed in the Media Window when surfing through the Station Index (see page 47).



Custom Stations

Lets you customize which stations appear in the program guides (see page 50).

Data Service

A future application (see page 51).

Setting Display Options

Display Options lets you choose the color scheme of the on-screen displays and the order in which stations are listed in the program list area. You can also turn the surf option on or off.

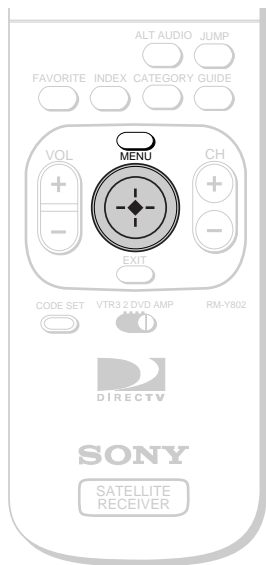

RM-Y802
Remote Control

1 Press the MENU button, then highlight and select PREFERENCES.

The PREFERENCES Menu appears.

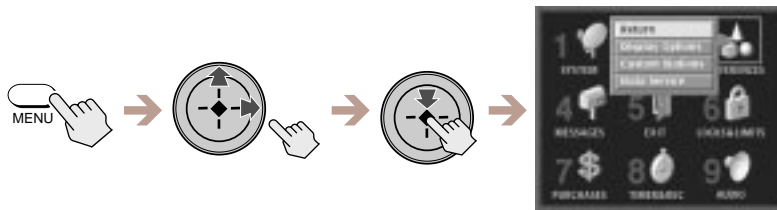

2 Highlight and select "Display Options".

The Display Options display appears.

Colors

Lets you change the color of the on-screen displays (see page 48).

Station order

Lets you select the order in which stations appear in the list area (see page 49).

Surf

Lets you view the Current Program in the Station Index while view other Program information (see page 49).



Return

Closes the Display Options display to show the Main Menu.

Help

Opens information about the Display Options display.

Adjusting the Displays (PREFERENCES) (continued)

Changing the Color Scheme

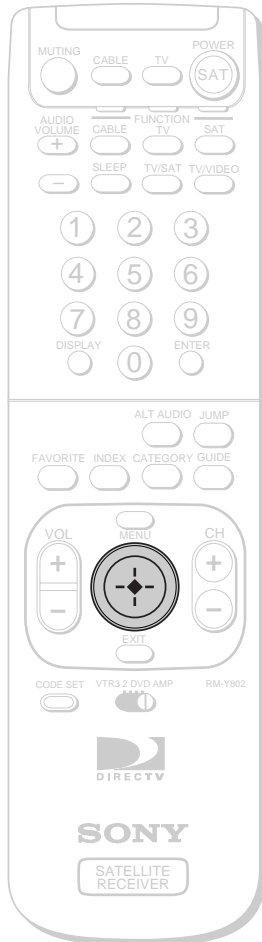

RM-Y802
Remote Control

- 1 Highlight and select "Colors" from the Display Options display (see page 47).
The Colors pop-up appears.**



- 2 Highlight and select the color scheme you like.
The display changes colors as you highlight each color scheme.**

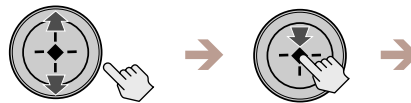

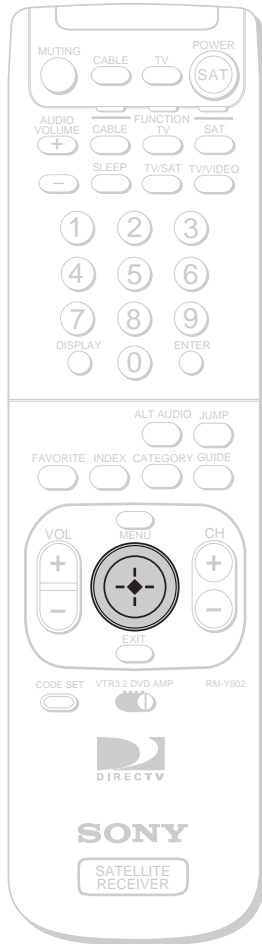

RM-Y802
Remote Control

Changing the Station Order

You can select numerical or alphabetical for the order in which stations appear in the List Area of the Program Guide, Category Guide and Other Guides display.

- 1 Highlight and select "Station Order" from the Display Options display (see page 47).
The Station Order pop-up appears.

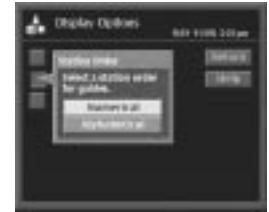

- 2 Highlight and select the order you like.
The Station Order pop-up closes to show the Display Options display.



Changing the Surf Setting

When the Surf setting is On you can view the current program in the Media Window of the Station Index while viewing the program information of other programs as you highlight them in the Station Index.

- 1 Highlight and select "Surf" from the Display Options display (see page 47).
The Surf pop-up appears.

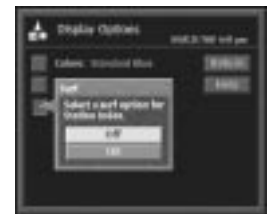
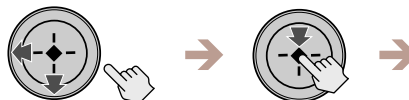

- 2 Highlight and select "On" or "Off".
The Surf pop-up closes to show the Display Options display.

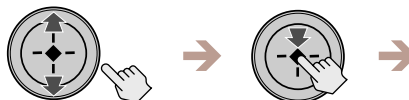

continued



RM-Y802
Remote Control

Setting Up Custom Stations

The Custom Stations display lets you choose which stations will be skipped in the Program Guide, Category Guide and Station Index, and when you change channels using the CH +/- buttons. You can reduce the number of stations that appear by skipping unwanted stations.

- 1 Press the MENU button, then highlight and select PREFERENCES.

The PREFERENCES Menu appears.

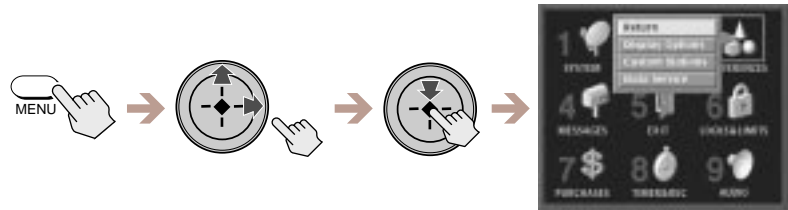

- 2 Highlight and select "Custom Stations".

The Custom Stations display appears.

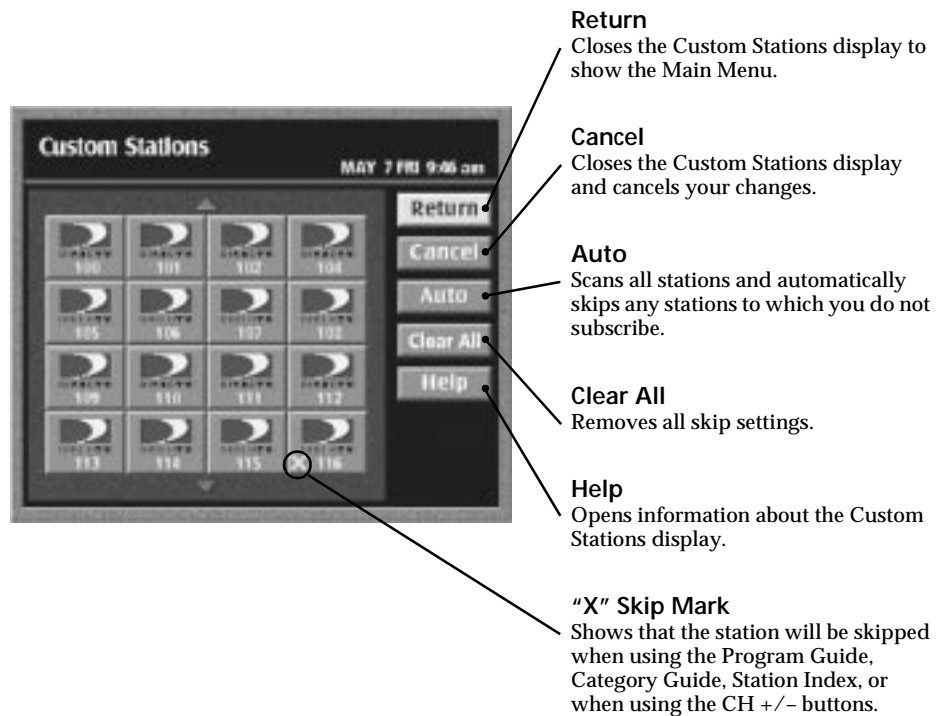

3 Highlight and select a station icon to add or remove the "X" mark.

The "x" mark indicates that the station will be skipped when you open the Program Guide, Category Guide or Station Index, or change channels using the CH +/- buttons.

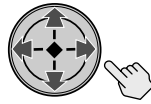

4 Highlight and select "Return".

The Custom Stations display closes to show the Main Menu.

Selecting Data Services

The Data Services feature is reserved for future applications.

Viewing Messages (MESSAGES)

Your service provider may occasionally send messages to your Digital Satellite Receiver to inform you of changes to your service and other special announcements.



1 Press the MENU button, then highlight and select MESSAGES.

The Messages display appears.

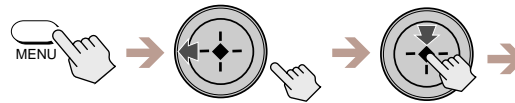

2 Highlight and select the message you want to read.

The message pop-up appears.

Delete

Closes the message pop-up and deletes the message.

Return

Closes the message pop-up and saves the message.

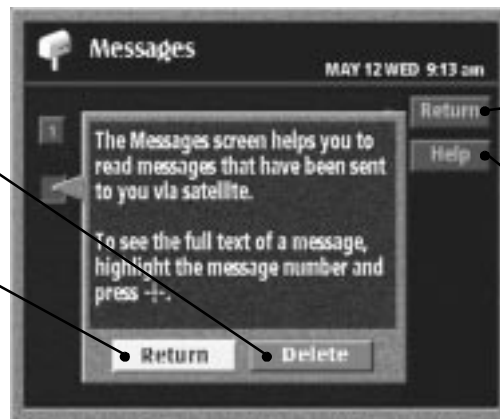

Return

Closes the Messages display to show the Main Menu.

Help

Opens information about the Messages display.

3 Highlight and select "Return" or "Delete".

The message pop-up closes to show the Messages display.

Note

Your receiver can hold a total of between 10 and 20 new and old messages, depending on the size of the messages. Your receiver will continue to hold a message until you delete it or until the AC Power Cord is disconnected. If your receiver's memory is full, you must delete old messages before you can receive new ones.

Setting Locks and Limits (LOCKS & LIMITS)



RM-Y802
Remote Control

Using the Locks & Limits Display

The Locks & Limits feature gives you control over access to your Digital Satellite Receiver. You can restrict program viewing by cost, ratings, and station. You can also set a lock to prevent the ordering of pay per view programs.

- 1 Press the MENU button, then highlight and select **LOCKS & LIMITS**.
The Locks & Limits display appears.

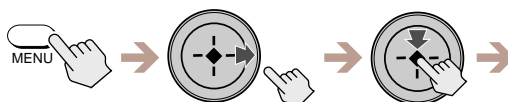

- 2 Highlight and select **"Edit"**.
The Locks & Limits edit display appears.
The following pages describe how to change the settings for each of these items.

Receiver Status

Shows if your Digital Satellite Receiver is now locked or unlocked.

Spending Limit

Sets a maximum limit on charges per event (see page 54).

Rating Limit

Sets a maximum limit on rated content (see page 55).

Pay Per View

Blocks access to pay per view programs (see page 55).

Stations Blocked

Blocks access to specific stations (see page 56).

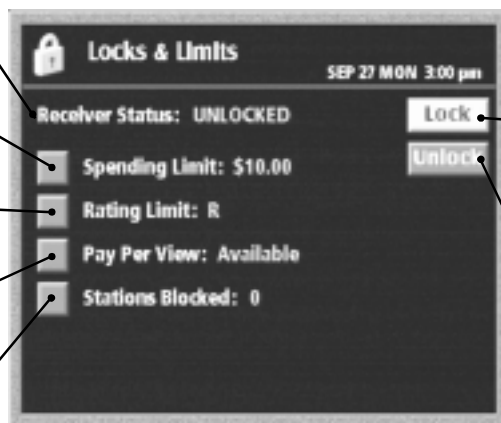

Lock

Opens the passcode pop-up. You must enter your passcode to lock the receiver.

Unlock

Opens the passcode pop-up for unlocking your receiver.

Note

You must lock the receiver before any locks or limits take effect (see page 57).

Setting Locks and Limits (LOCKS & LIMITS) (continued)

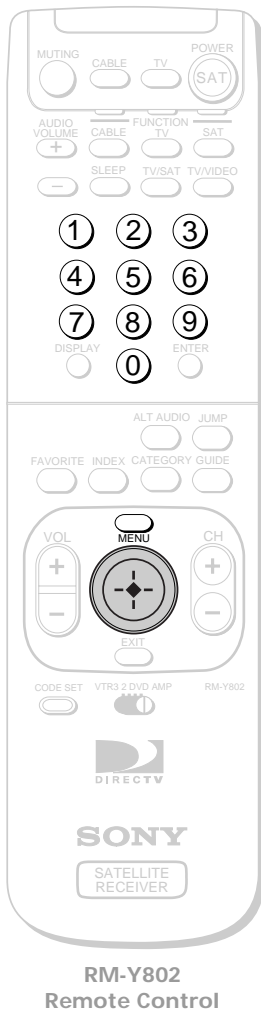

RM-Y802
Remote Control

Changing the Spending Limit

The spending limit pop-up lets you limit the amount you can spend per event on pay per view purchases.

- 1 Highlight and select "Spending Limit" from the Locks & Limits edit display (see page 53).**
The Spending Limit pop-up appears.



- 2 Press the 0-9 buttons to enter the dollar value.**
You can enter a value of less than \$656.

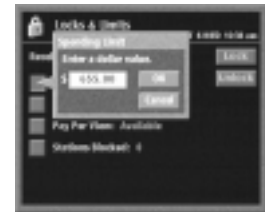
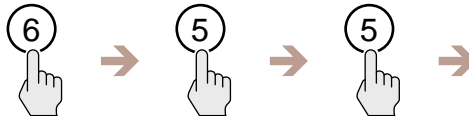

- 3 Highlight and select "OK".**
The Spending Limit pop-up closes to show the Locks & Limits edit display.
Select "Cancel" to close the Spending Limit pop-up without saving changes.

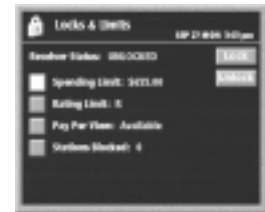

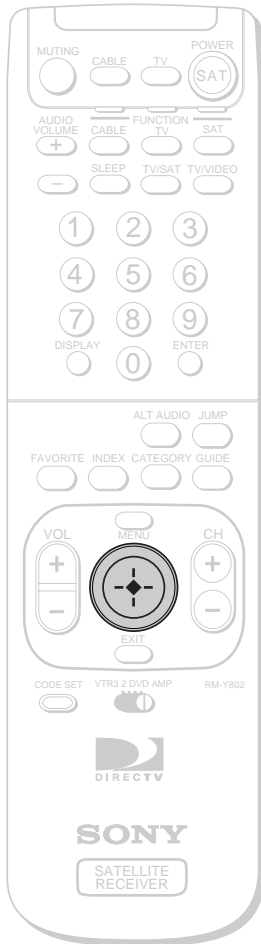

RM-Y802
Remote Control

Changing the Rating Limit

The Rating Limit pop-up lets you limit programs according to the content rating.

- 1 Highlight and select "Rating Limit" from the Locks & Limits edit display (see page 53).

The Rating Limit pop-up appears.

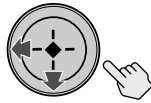

- 2 Highlight and select the highest content rating you want your Digital Satellite Receiver to access.

The Rating Limit pop-up closes to show the Locks & Limits edit display.

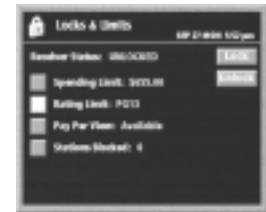
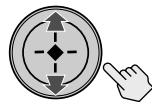

Changing the Pay Per View Access Setting

The pay per view access setting lets you block access to pay per view stations.

- 1 Highlight and select "Pay Per View" from the Locks & Limits edit display (see page 53).

The Pay Per View Access pop-up appears.

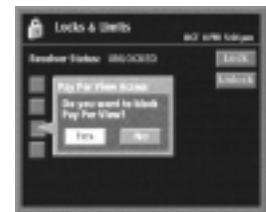
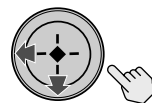

- 2 Select "Yes" to block access to pay per view programs. Select "No" to allow access to pay per view programs.



continued

Setting Locks and Limits (LOCKS & LIMITS) (continued)

Changing the Stations Blocked Settings

The Stations Blocked feature lets you block access to specific stations.

- 1 Highlight and select "Stations Blocked" from the Locks & Limits edit display (see page 53).
The Stations Blocked display appears.

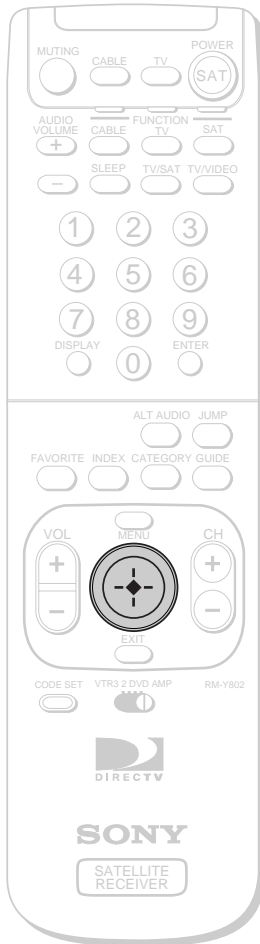

RM-Y802
Remote Control

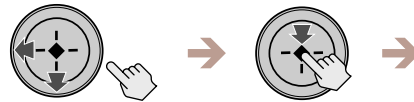

- 2 Highlight and select a station icon to block that station.
The block symbol appears in the station icon to indicate that the station is blocked.

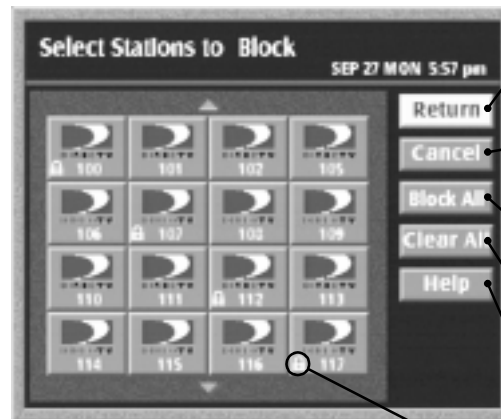

- Return**
Closes the Station Blocked display.
- Cancel**
Closes the Stations Blocked display without saving your changes.
- Block All**
Blocks all stations.
- Clear All**
Unblocks all stations.
- Help**
Opens the help display.
- Block Icon**
Shows that this station will be blocked.

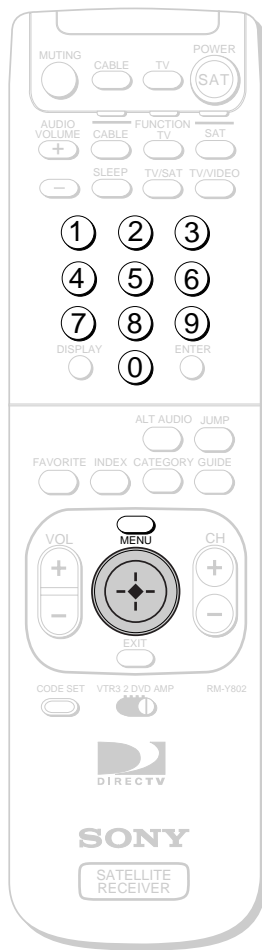

RM-Y802
Remote Control

Locking Your Receiver

After you have made the changes you want to the Locks & Limits settings, you must enter a passcode to lock the receiver.

1 Press the MENU button, then highlight and select **LOCKS & LIMITS**.
The Locks & Limits display appears.

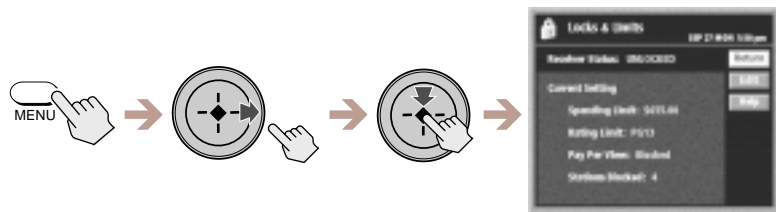

2 Highlight and select **"Edit"**, then select **"Lock"**.
The Lock Receiver pop-up appears.

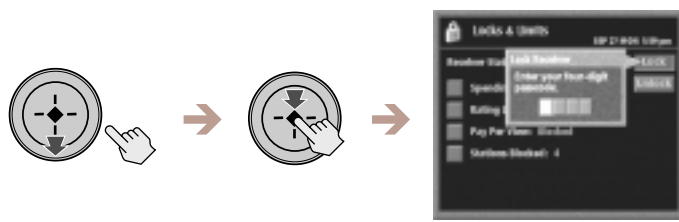

3 Enter a four digit passcode using the 0-9 buttons.
Each number you enter appears as an asterisk (*) which keeps your passcode secret.

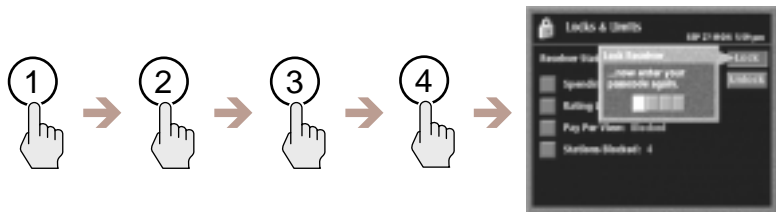

4 Enter your passcode again.
This confirms your selection of a passcode number.

5 Highlight and select **"Return"**.
The Main Menu appears.
Your receiver is now locked with your passcode using the locks and limits you have set.

Tip
Do not forget your passcode. You will need this number to unlock your system or make any changes to the locks or limits you have set. If you forget your passcode, contact your program provider for assistance.

continued

Setting Locks and Limits (LOCKS & LIMITS) (continued)

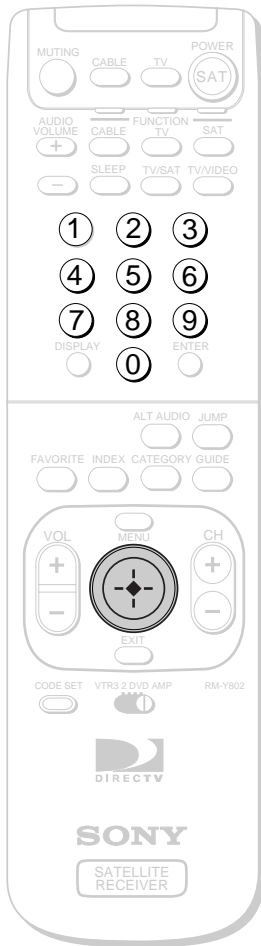

RM-Y802
Remote Control

Unlocking Your Receiver

If you want to make changes to the Locks & Limits settings, you must enter your passcode to unlock the receiver.

- 1 Press the MENU button, then highlight and select LOCKS & LIMITS.**

The Locks & Limits display appears.

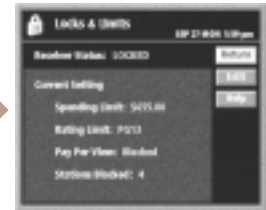
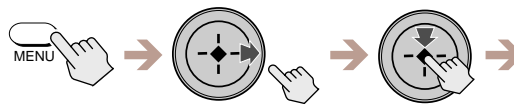

- 2 Highlight and select "Edit".**

The Unlock Receiver pop-up appears.

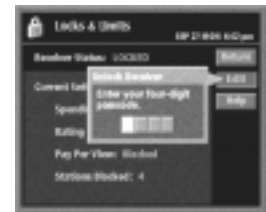
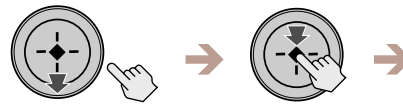

- 3 Enter your four digit passcode using the 0-9 button.**

Each number you enter appears as an asterisk (*) which keeps your passcode secret.

The Locks & Limits edit display appears.

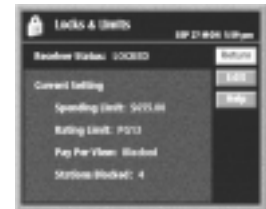
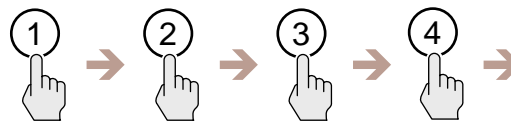

- 4 Highlight and select "Unlock".**

Your receiver is now unlocked.

- 5 Highlight and select "Return".**

The Main Menu appears.



Tip

You can temporarily unlock your Digital Satellite Receiver with your passcode if you select a program from a guide and the station is locked or a limit has been reached.

Checking Pay Per View Purchases (PURCHASES)



RM-Y802
Remote Control

Checking Your Purchases

You can view a history of the pay per view purchases you have made. This display also shows the future purchases you have ordered and those that you have canceled.

- 1** Press the MENU button, then highlight and select PURCHASES.
The Purchases display appears.

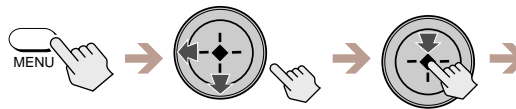

- 2** Highlight and select the purchase number you want to view.
The information pop-up for that purchase appears.

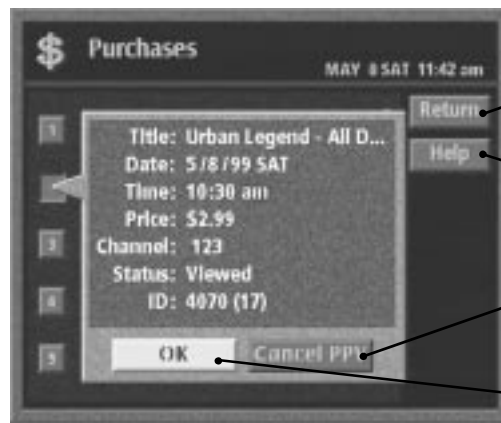

Return

Closes the Purchases display to show the Main Menu.

Help

Opens information about the Purchases display.

Cancel PPV

Cancels the Pay Per View program.

OK

Closes the information pop-up to show the Purchases display.



Tip
You can purchase pay per view programs from any guide. See "Viewing Pay Per View Programs" on page 45.

- 3** Highlight and select "OK".
The information pop-up closes to show the Purchases display.

Scheduling Programs (TIMER & REC)

Using One Button Timer & Rec

You can easily set the timer to view or record programs by selecting future programs directly from program guides.

To record a future program use the VCR Control feature to turn on your VCR and start recording automatically. For information on how to set up the VCR Control feature, see page 26.

Highlight and select a future program using any of the methods described in "Viewing Station and Program Information (GUIDES)" on pages 35 through 44.

Return

Closes the future program pop-up to show the current guide.

Tune to Station

Closes the program guide to show the current program of the selected station.

Add to Timer & Rec

Adds the program to the Timer & Rec display for recording, and opens the schedule pop-up.

Add to Timer

Adds the program to the Timer & Rec display for tuning, and opens the schedule pop-up.

Tips

- You can set up the Digital Satellite Receiver to send program information to your VCR so it records the information at the beginning of the recording. See page 28 for information.
- Your Digital Satellite Receiver has a Program Data Download feature and will automatically send the following information when you record a program with a Sony SmartFile VCR: program title, program category, program date/time and duration.
For further information regarding the SmartFile function, refer to your Sony SmartFile VCR Operating Instructions.

Notes

- When using the VCR Control feature to record a future program, make sure that the VCR is turned off before the program begins. The VCR Control feature will turn on your VCR and start recording.
- When you schedule two or more continuous events to be recorded, the Auto Title Insert and Program Data Download features will only send information about the first program.

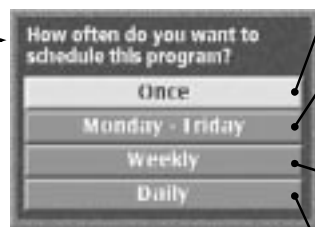
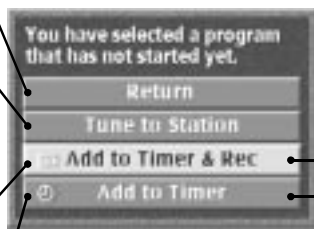

Once

Adds the program to the Timer & Rec display for one time tuning and/or recording.

Monday-Friday

Adds the program to the Timer & Rec display for the remaining week days of the current week for tuning and/or recording.

Weekly

Adds the program to the Timer & Rec display for tuning and/or recording on the same day of the following four weeks.

Daily

Adds the program to the Timer & Rec display for tuning and/or recording every day for the next 30 days.

Using the Timer & Rec Feature

The Timer & Rec feature lets you set up the Digital Satellite Receiver to automatically tune to a program scheduled at a future time. You can also use the One Button Timer & Rec feature to set up the timer by selecting a future program.

To record a future program, use the VCR Control feature to turn on your VCR and start recording automatically. For information on how to set up the VCR Control feature see page 26.

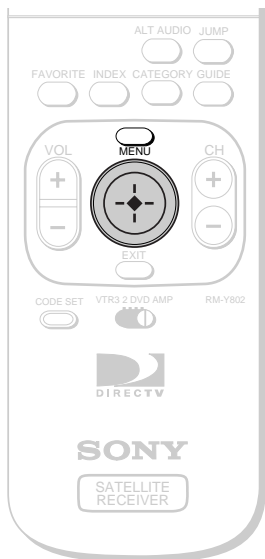

RM-Y802
Remote Control

- 1 Press the MENU button, then highlight and select **TIMER & REC**.

The Timer & Rec display appears.

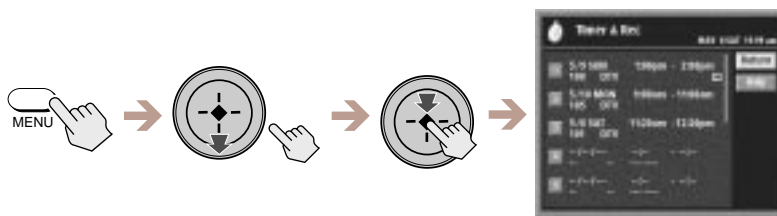

- 2 Highlight and select the next available timer event number.

The Date/Day field is highlighted and the current date appears.

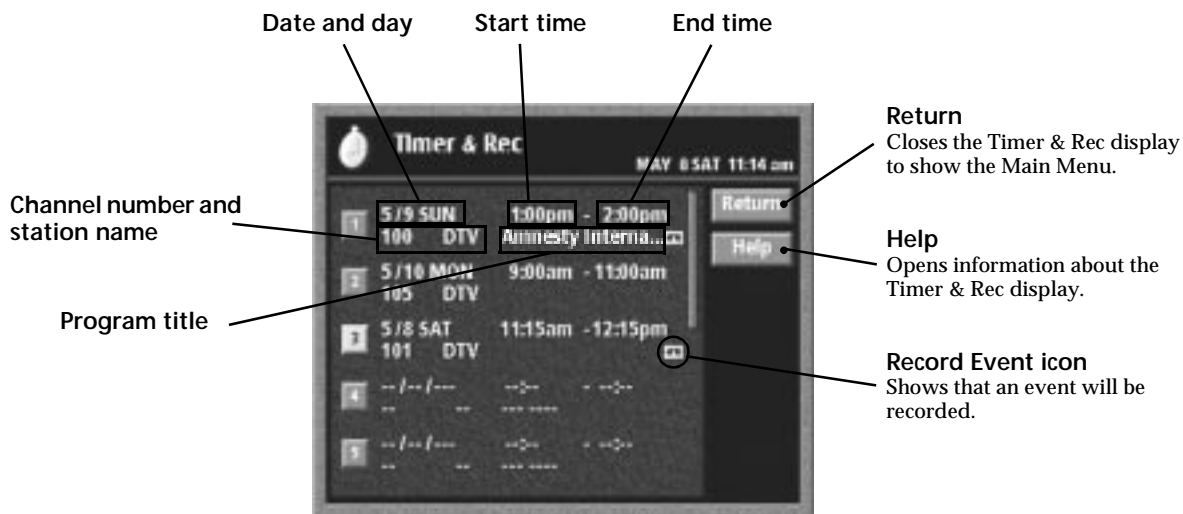

Tip
When using the VCR Control feature to record a future program, make sure that your VCR is turned off before the program begins. The VCR Control feature will turn on the VCR and start recording.

continued

Scheduling Programs (TIMER & REC) (continued)

3

Follow the steps below to set the timer.

Move the joystick in the direction indicated in these steps.

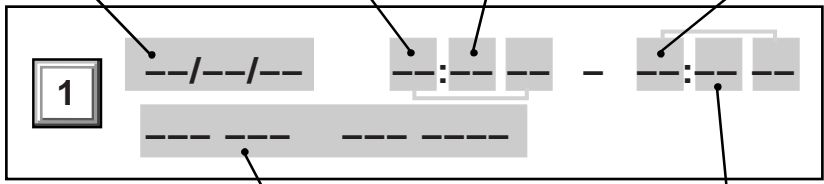
- ① Press \uparrow/\downarrow to select from the following.
 - Any date up to 30 days from the current date
 - EVERY SUN
 - EVERY MON
 - EVERY TUE
 - EVERY WED
 - EVERY THU
 - EVERY FRI
 - EVERY SAT
 - MON-FRI
 - DAILY
 - ② Press \leftarrow or \rightarrow to move to the next item.
 - ③ Press \uparrow/\downarrow to change the starting hour. Then, press \leftarrow or \rightarrow to move to the next item.
 - ④ Press \uparrow/\downarrow to change the starting minute. Then, press \leftarrow or \rightarrow to move to the next item.
 - ⑤ Press \uparrow/\downarrow to change the ending hour. Then, press \leftarrow or \rightarrow to move to the next item.
 - ⑥ Press \uparrow/\downarrow to change the ending minute. Then, press \leftarrow or \rightarrow to move to the next item.
 - ⑦ Use the number buttons or press \uparrow/\downarrow to select the channel number. Then, press \leftarrow or \rightarrow to move to the next item.
 - ⑧ Press \leftarrow . The Timer & Rec pop-up appears. Highlight Timer & Rec or Timer and press \leftarrow .
- 

4

Highlight and select "Return" to close the TIMER & REC display.

The Main Menu appears.

Tips

- Shortly before beginning a scheduled timer event, an information box appears on your screen. You can press the EXIT button on your remote control to cancel the timer event.
- If the Auto Title Insert feature is on (see page 28), the Auto Title will appear 10 seconds before the scheduled program.

Editing Timer Events

You can easily edit or delete timer events.



RM-Y802
Remote Control

1

Press the MENU button, then highlight and select **TIMER & REC.**

The Timer & Rec display appears.

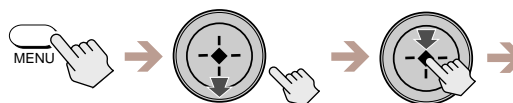

2

Highlight and select the number of the event you want to edit.

The edit pop-up appears.

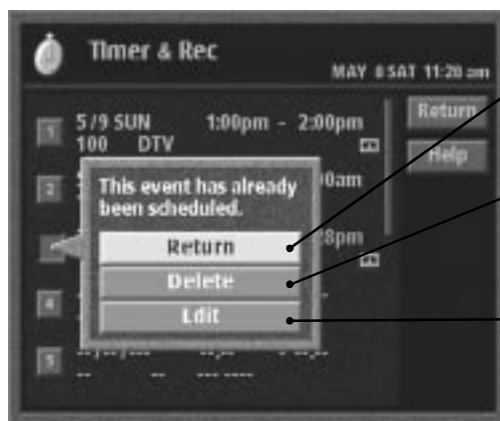

Return

Closes the edit pop-up to show the Timer & Rec display.

Delete

Removes the event from the list. Higher numbered events move up to fill the gap.

Edit

Closes the edit pop-up to highlight the date of that event. See page 62 for instructions on how to change the timer settings.

Setting Audio Options (AUDIO)

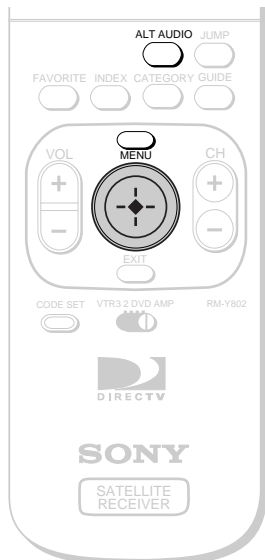

RM-Y802
Remote Control

Using the Audio Display

You can set your Digital Satellite Receiver to play the audio track in the language you prefer if that language is available. You can set the language for the current program and as the default language for all programs when that language is available. You can also set your Digital Satellite Receiver to receive Dolby Digital audio signals (SAT-A55 only).

- 1** Press the MENU button, then highlight and select **AUDIO**.

The Audio display appears.

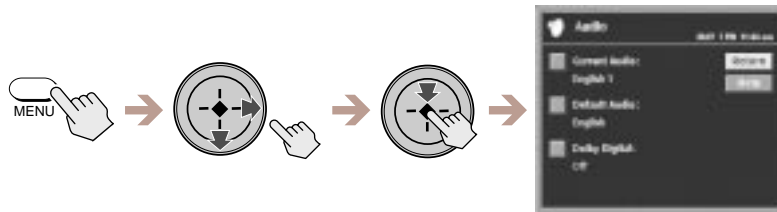

- 2** Highlight and select the setting you want to change.

Current Audio

Opens a pop-up that displays the languages available for the current program.

Default Audio

Opens a pop-up that displays the eight available default languages. When a program broadcasts an audio track in the default language, that language is automatically selected.

Dolby Digital (SAT-A55 only)

Opens a pop-up that lets you set your Dolby Digital options. Choose "Auto Select" (if you have a Dolby Digital audio system) to enjoy surround sound whenever a station broadcasts a Dolby Digital audio track. Select "Off" if you do not have a Dolby Digital audio system.



Return

Closes the Audio display to show the Main Menu.

Help

Opens information about the Audio display.

💡 Tip (SAT-A55 only)

You can also use the ALT AUDIO button on the remote control to select among the currently available tracks.

Setting Up the Remote Control



RM-Y802
Remote Control

The RM-Y139 and RM-Y802 remote controls can be programmed to operate your other audio/video equipment.

1 Find the code(s) for the manufacturer of the device you want to operate with this remote control.

You can find these codes on pages 66 and 67.

2 Press the CODE SET button.

The function indicators begin flashing.



3 Press the 0-9 buttons to input the manufacturer code, then press the ENTER button.

The function indicator goes off, and the remote is setup to operate that device.

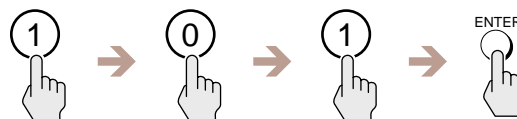

4 Test the remote control.

Press the POWER button for that equipment, then press other operation controls such as the CH +/- buttons.

If the device does not respond to the remote control, repeat from step 2 and enter a different manufacturer code in step 3.

💡 Tips

- Remember to aim the remote control at the device you are trying to operate.
- To control extra VTRs (VCRs), a DVD player or an amplifier with the RM-Y802 remote control, slide the device switch to VTR2, 3, DVD or AMP after you have set up the remote with the correct manufacturer code.

Manufacturer Codes

TV Codes

Manufacturer	Code
Sony	101
Admiral (M. Wards)	102, 114, 109
ABC	112
Bell & Howell (M. Wards)	114, 109, 138
Broksonic	103, 112
Craig	122, 123, 120, 121
Croslex	111
Curtis Mathis	103, 119, 123
Daewoo	135, 136, 103
Daytron	113
Emerson	122, 113, 120, 121, 123, 103, 115
Fisher	125
General Electric	102, 118, 103, 107
Goldstar	103, 113, 112, 130
Hitachi	131, 113, 103, 132
JC Penney	103, 102, 130, 107
JVC	128, 129
KTV	133, 113, 103, 123, 134
LXI (Sears)	102, 103, 111, 125, 119, 112
Magnavox	111, 112, 113, 107
Mitsubishi/MGA	124, 103, 112
NEC	103, 112
Panasonic	118, 116, 117, 107
Philco	111, 118, 109
Philips	111
Pilot	103
Pioneer	137, 118, 119
Portland	103, 108
Quasar	110, 107
Radio Shack	102, 112, 124, 123
RCA/Proscan	102, 103, 104, 105, 106, 107, 108
Samsung	126, 112, 113, 103
Sanyo	125
Scott	123, 112
Sharp	114, 113, 115
Signature 2000 (M. Wards)	114, 109
Sylvania	111, 112, 108
Symphonic	123, 139
Tenika	109
Toshiba	119, 114
Videch	131, 103, 112
Wards	113, 103, 115, 112
Zenith	108, 110

VCR Codes

Manufacturer	Code
Sony	301, 302, 303
Aiwa	338
Audio Dynamic	314, 347
Bell & Howell (M. Wards)	330, 343
Broksonic	317, 319
Canon	309, 308
Citizen	332
Craig	315, 302, 332
Curtis Mathis	304, 338, 309
Daewoo	341, 312, 309
DBX	314, 336, 337
Dimensia	304
Emerson	319, 320, 316, 317, 318, 341
Fisher	330, 334, 335, 333
Funai	338
General Electric	329, 304, 309
Go Video	322, 339, 340
Goldstar	332
Hitachi	306, 304, 305, 338
HQ	315
Instant Replay	309, 308
JC Penney	309, 305, 304, 330, 314, 336, 337
JVC	314, 336, 337
Kenwood	314, 336, 332, 337
LXI (Sears)	332, 305, 333, 334, 330, 335, 338
Magnavox	310, 308, 309
Marantz	314, 336, 337
Marta	332
Memorex	309, 335
Minolta	305, 304
Mitsubishi/MGA	323, 324, 325, 326
Multitech	325, 338, 321
NEC	314, 336, 337
Olympic	309, 308
Optimus	327
Panasonic	308, 309, 306, 307
Pentax	305, 304
Philco	308, 309
Philips	310, 308, 309
Pioneer	308
Quasar	306, 308, 309
RCA/Proscan	304, 305, 308, 309, 310, 311, 312, 313

VCR Codes (continued)

Manufacturer	Code
Realistic	309, 330, 328, 335, 324, 338
Sansui	314
Singer	315
Samsung	322, 313, 321
Sanyo	330, 335
Scott	312, 313, 321, 335, 323, 324, 325, 326
Sharp	327, 325, 328
Shintom	315
Signature 2000 (M. Wards)	336, 327
Sylvania	310, 308, 309, 338
Symphonic	338
Tashiro	332
Tatung	314, 336, 337
Teac	314, 336, 338, 337
Technics	309, 308
Teknika	338, 342
Toshiba	312, 311
Wards	327, 328, 335, 331, 332
Yamaha	330, 314, 336, 337
Zenith	331

DVD Codes (RM-Y802 Only)

Manufacturer	Code
Sony	601
Panasonic	604
Pioneer	605
RCA	602
Toshiba	603

AMP (Amplifier) Codes (RM-Y802 Only)

Manufacturer	Code
Sony	501
Denon (Sharp)	516, 517, 518
Harmon	519
JVC	506, 507, 508
Kenwood	504, 505
McIntosh	520
Onkyo	512, 513
Pioneer	502, 503
Technics	509, 510, 511
Yamaha	514, 515

Cable Box Codes (RM-Y802 Only)

Manufacturer	Code
Hamlin/Regal	222, 223, 224, 225, 228
Jerrold/G.I.	201, 202, 203, 204, 205, 206, 207, 208, 218
Oak	227, 228, 229
Panasonic	219, 220, 221
Pioneer	214, 215
Scientific Atlanta	209, 210, 211
Tocom	216, 217
Zenith	212

Location and Function of Controls

Front Panel

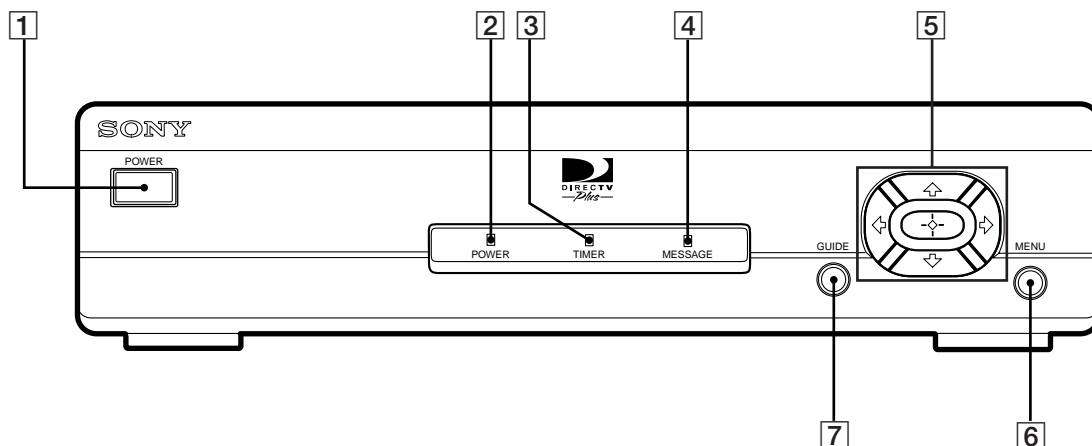

- 1 POWER Button**
Turns your Digital Satellite Receiver on and off.
- 2 POWER Indicator**
Indicates whether the Digital Satellite Receiver is on or off.
- 3 TIMER Indicator**
Indicates that the Timer is set.
- 4 MESSAGE Indicator**
Indicates that you have a new message.
- 5 Arrow and \rightarrow Buttons**
The arrow buttons move the highlight in the on-screen displays. The \rightarrow button selects the highlighted item.
- 6 MENU Button**
Opens the Main Menu.
- 7 GUIDE Button**
Opens the Program Guide.

SAT-A55 Back Panel

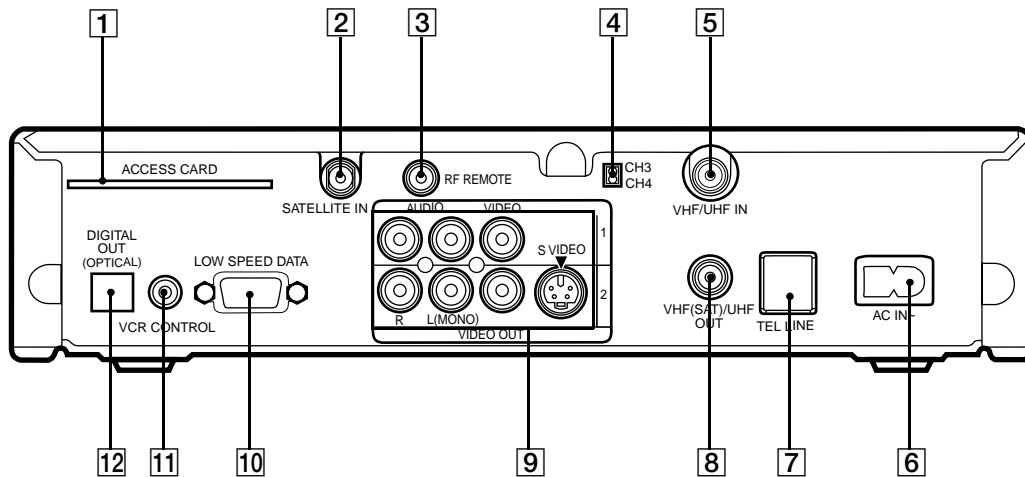

- 1 ACCESS CARD slot**
Do not remove the Access Card unless instructed to do so by your service provider.
- 2 SATELLITE IN jack**
Inputs satellite signals from your Satellite Dish Antenna using RG-6 coaxial cable.
- 3 RF REMOTE jack**
Inputs remote control signals using the RF Antenna.
- 4 CH3/CH4 switch**
When you use an RF connection (VHF(SAT)/UHF OUT jack), this setting determines the TV channel on which programs from the Digital Satellite Receiver can be viewed.
- 5 VHF/UHF IN jack**
Inputs off-air signals from your local TV off-air antenna using coaxial cable. Some antennas require an adapter (not supplied).
- 6 AC IN jack**
Inputs AC power from a power outlet using the AC Power Cord.
- 7 TEL LINE jack**
Connects the Digital Satellite Receiver to a telephone outlet using a telephone line cable.
- 8 VHF(SAT)/UHF OUT jack**
Outputs audio and video signals to the VHF/UHF input on your TV or VCR using coaxial cable.
- 9 A/V OUTPUT jacks**
Output audio and video signals to your TV and other audio/video equipment using A/V cables.
- 10 LOW SPEED DATA**
Can be used for future products such as Personal Video Recorders.
- 11 VCR CONTROL jack**
Allows the VCR Controller to control a VCR and/or cable box. Also allows connection of a monaural cable for use with Sony SmartFile VCRs.
- 12 DIGITAL OUT (OPTICAL)**
Outputs digital audio signals to the digital optical input of your audio receiver.

SAT-B55 Back Panel

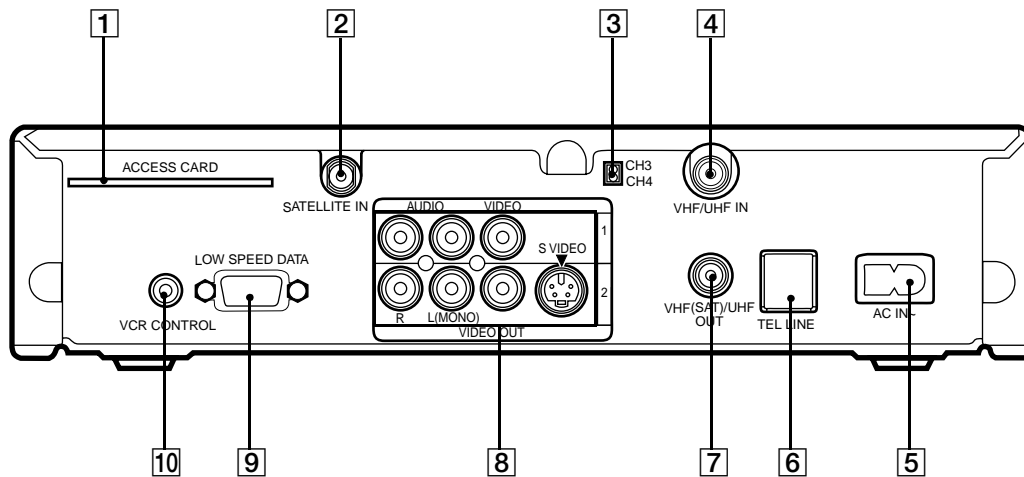

- 1 ACCESS CARD slot**
Do not remove the Access Card unless instructed to do so by your service provider.
- 2 SATELLITE IN jack**
Inputs satellite signals from your Satellite Dish Antenna using RG-6 coaxial cable.
- 3 CH3/CH4 switch**
When you use an RF connection (VHF(SAT)/UHF OUT jack), this setting determines the TV channel on which programs from the Digital Satellite Receiver can be viewed.
- 4 VHF/UHF IN jack**
Inputs off-air signals from your local TV off-air antenna using coaxial cable. Some antennas require an adapter (not supplied).
- 5 AC IN jack**
Inputs AC power from a power outlet using the AC Power Cord.
- 6 TEL LINE jack**
Connects the Digital Satellite Receiver to a telephone outlet using a telephone line cable.
- 7 VHF(SAT)/UHF OUT jack**
Outputs audio and video signals to the VHF/UHF input on your TV or VCR using coaxial cable.
- 8 A/V OUTPUT jacks**
Output audio and video signals to your TV and other audio/video equipment using A/V cables.
- 9 LOW SPEED DATA**
Can be used for future products such as Personal Video Recorders.
- 10 VCR CONTROL jack**
Allows the VCR Controller to control a VCR and/or cable box. Also allows connection of a monaural cable for use with Sony SmartFile VCRs.

Specifications

Input Jacks

UHF/VHF IN	75 ohm f-type
SATELLITE IN	75 ohm f-type
RF REMOTE (SAT-A55)	
AC IN (120 V, 60 Hz)	

Output Jacks

	Cable Type
S-VIDEO OUT	4-pin mini DIN
VIDEO (2)	RCA type
OPTICAL OUT (1) (SAT-A55 only)	Optical Rectangular
AUDIO R/L (2)	RCA type
VHF (SAT)/UHF	75 ohm f-type
Low-Speed Data	9-pin D-Sub Female
TEL LINE	RJ-11
VCR CONTROL (1)	VCR Controller (or monaural cable for Sony SmartFile VCRs)

General

Input Frequency	950–1450 MHz
Power Requirements	120 V, 60 Hz
Power Consumption	20 W max
Dimensions (w/h/d)	11 × 2 5/8 × 9 inches 280 × 66.5 × 228.5 mm

Weight

SAT-A55

Set:	6.0 lbs (2.7 kg)
Unit:	3.6 lbs (1.6 kg)

SAT-B55

Set:	5.4 lbs (2.5 kg)
Unit:	3.4 lbs (1.5 kg)

Supplied Accessories

Remote Control	RM-Y802 (SAT-A55) RM-Y139 (SAT-B55)
----------------	--

Size AA Batteries (2)
Access Card (1)
Audio/Video Cable (1)
Coaxial RF Cable (1)
Telephone Line Cord (1)
AC Power Cord (1)
VCR Controller (1)
S-Video Cable (1) (SAT-A55)
RF Antenna (1) (SAT-A55)

Optional Sony-brand Digital Satellite Receiver Accessories

Local TV Antenna

ANJ-AA1

Installation Kit

ANJ-DS2

Amplifier

EAC-DA1

Diplexer

EAC-DD1

Voltage Switch

EAC-DV2

RF Universal Remote Commander™ Remote Control

RM-Y802

Design and specifications are subject to change without notice.

Troubleshooting

Problem	What you can do
Poor picture quality or no picture	<ul style="list-style-type: none">• If you are receiving only a few stations, (only 2 or 3 channels for example), call your service provider to have your programming activated.• Some pay per view programs may be protected by Macrovision copy protection at the discretion of the copyright owner. You may want to connect the Digital Satellite Receiver directly to your TV.• Check the connections to your TV and other equipment (see pages 7–13).• Make sure that your TV and other equipment are set to the input source to which you connected your Digital Satellite Receiver, for example, channel 3 or 4, Video 1 or 2 (see pages 9–10).• Check the Satellite Dish Antenna's signal strength (see page 23).• Make sure the RG-6 coaxial cable is properly connected to the Satellite Dish Antenna.• If the cable distance between the Satellite Dish Antenna and the Digital Satellite Receiver is more than 100 feet, you must use the Sony Amplifier EAC-DA1.• Make sure your Access Card is inserted correctly (see page 13).• Move any antenna cables that may be directly above your Digital Satellite Receiver.• Change the setting of the CH3/CH4 switch on the back of the Digital Satellite Receiver. This could improve picture quality only if you are using the UHF/VHF IN jack of the Digital Satellite Receiver to connect a local TV antenna or cable company service.
Poor picture quality or no picture when it rains or snows	<ul style="list-style-type: none">• Heavy rain or snow may degrade the strength of the signal coming from the satellite to your Satellite Dish Antenna. To limit any negative effects during degraded conditions, make sure that your professional installer has aimed your Satellite Dish Antenna so that you are receiving a high signal strength level (see page 23, or refer to your Satellite Dish Antenna Installation Instructions).
You cannot turn on the unit	<ul style="list-style-type: none">• Make sure that the AC Power Cord is plugged in (see page 13).• If the AC Power Cord is plugged in, unplug the AC Power Cord, wait a few minutes, then plug in the AC Power Cord again.
You cannot access a program	<ul style="list-style-type: none">• Make sure you subscribe to the station you are trying to access. Your service provider can tell you to which stations you subscribe.• Make sure the station you are trying to access is not set to be skipped (see pages 50–51).• Make sure the system is not locked (see page 58).• Use the Program Guide to access the station (see page 37).• Press the SAT FUNCTION button on the remote control before you select a channel (see page 20).

Problem	What you can do
You cannot order a pay per view program	<ul style="list-style-type: none"> • Make sure your Digital Satellite Receiver is connected to a telephone line (see page 8). • Make sure the system is not locked (see page 58). • Use the Program Guide to access the station (see page 37). • If the message “Purchase information not available” appears, you must contact your service provider to order the program. • Your Access Card may be full. If so, contact your service provider. • It may be too late to order the program you want. If so, check for other show times (see page 45).
You cannot find the station of the pay per view program that you ordered	<ul style="list-style-type: none"> • See “Checking Pay Per View Purchases” on page 59 to get information (station, start time, etc.) about programs that you have ordered.
You cannot cancel a pay per view order	<ul style="list-style-type: none"> • You cannot cancel pay per view orders that you have watched. Contact your service provider for details.
The program highlighted in the Program Guide does not appear	<ul style="list-style-type: none"> • Highlight and select the program. Although the program you highlight appears in the Media Window, you must press the \rightarrow button to complete your selection (see page 37).
You cannot see any Favorite Stations	<ul style="list-style-type: none"> • Set up your personal Favorite Titles before you try to use the Favorite Stations guide (see page 41).
Locks & Limits feature not working properly	<ul style="list-style-type: none"> • Make sure that the Spending, Rating, Pay Per View, and Stations Blocked are set as you want them (see pages 53–56). Then, make sure that the system is locked (see page 57).
You cannot access the Locks & Limits screens	<ul style="list-style-type: none"> • The system must be unlocked before you can make changes to the Locks & Limits (see page 58).
You cannot unlock the system	<ul style="list-style-type: none"> • Make sure that you entered the passcode correctly. If you have lost or forgotten your passcode, contact your service provider.
Language of audio track is incorrect or audio track is not available	<ul style="list-style-type: none"> • Check the default language setting. The program provider may not broadcast all of the languages in the Default Audio pop-up (see page 64). • Some programs may not offer audio tracks.

continued

Troubleshooting (continued)

Problem	What you can do
You cannot record programs with your VCR	<ul style="list-style-type: none">• Make sure that your VCR is connected correctly (see page 10).• If you want to use the VCR Control feature, make sure that the VCR Controller is connected correctly (see page 11). Also make sure that you have selected the correct VCR Manufacturer Code (see page 26).• If you are using the VCR Control feature to record a future program, make sure that your VCR is turned off before the program begins. The VCR Control feature will turn on the VCR and start recording.• Make sure that the program you are trying to record doesn't conflict with any Locks & Limits you have set.• If you are trying to record a pay per view program, you must first order the program (see page 45).• Some pay per view programs may be protected by Macrovision copy protection at the discretion of the copyright owner. If so, it may not be possible to record these programs.
Access Card problems	<ul style="list-style-type: none">• Make sure your Access Card is inserted correctly (see page 13).• Contact your service provider with any other Access Card problems.
Remote control does not work	<ul style="list-style-type: none">• Make sure that the batteries are inserted correctly and that the batteries are not weak (see page 7).• Remove and then reinsert the batteries without pressing any buttons on the remote control.• To operate your TV or other equipment, make sure that the remote control is set up to operate that equipment (see page 65). If the batteries are removed or become weak, you may need to set up the remote control to operate other equipment again.• Press the FUNCTION button on the remote control of the equipment you want to operate (SAT, TV, VTR, and/or CABLE). These buttons will flash to show which equipment the remote control is set to operate.• SAT-A55 model only: If there is a problem when using the RF function, check that the RF Antenna is connected correctly (see page 12).• SAT-A55 model only: Make sure that the remote control and the Digital Satellite Receiver are both using the same security code (see page 33).
Audio noise	<ul style="list-style-type: none">• SAT-A55 model only: If you connect the DIGITAL OUT jack to equipment that is not Dolby Digital compatible, set the Dolby Digital option to "off" (see page 64). Not all optical jacks on audio systems are Dolby Digital compatible.
"Frozen" picture or display	<ul style="list-style-type: none">• Press both the GUIDE and ARROW DOWN buttons at the same time on the front panel of the Digital Satellite Receiver to reset the receiver.

If you are unable to resolve problems with your system, see "Customer Support" inside the front cover.

FCC Regulations and Information

Your Digital Satellite Receiver has been registered by the Federal Communication Commission (FCC) as not being harmful to the telephone network when connected directly to the telephone lines. In order to fully comply with the Rules of the FCC, the following instructions should be read carefully and followed completely where applicable:

- 1 The Federal Communication Commission (FCC) has established Rules which permit this device to be directly connected to the telephone network. Standardized jacks are used for these connections. This equipment should not be used on party lines or coin phones.
- 2 If this device is malfunctioning, it may also be causing harm to the telephone network; this device should be disconnected until the source of the problem can be determined and until repair has been made. If this is not done, the telephone company may temporarily disconnect service.
- 3 The telephone company may make changes in its technical operations and procedures; if such changes affect the compatibility or use of this device, the telephone company is required to give adequate notice of the changes. You will be advised of your right to file a complaint with the FCC.
- 4 If the telephone company requests information on what equipment is connected to their lines, inform them of:
 - a. The telephone number to which this unit is connected.
 - b. The ringer equivalence number.
 - c. The USOC jack required.
 - d. The FCC Registration Number.
- 5 Items (b) and (d) are indicated on the label. The Ringer Equivalence Number (REN) is used to determine how many devices can be connected to your telephone line. In most areas, the sum of the RENs of all devices on any one line should not exceed five (5). If too many devices are attached, they may not ring properly.

Service Requirements

In the event of equipment malfunction, all repairs should be performed by our Company or an authorized agent. It is the responsibility of users requiring service to report the need for service to our company or to one of our authorized agents. For service, call 1-800-838-7669.

Declaration of Conformity

Trade Name: Sony
Model No.: SAT-A55/SAT-B55
Responsible Party: Sony Electronics Inc.
Address: 1 Sony Drive, Park Ridge, NJ. 07656 USA
Telephone No.: 201-930-6970

This device complies with Part 15 of the FCC rules. Operation is subject to the following two conditions: (1) This device may not cause harmful interference, and (2) this device must accept any interference received, including interference that may cause undesired operation.

Radio Interference Information

This equipment has been tested and found to comply with the limits for a Class B digital device, pursuant to Part 15 of the FCC Rules. These limits are designed to provide reasonable protection against harmful interference in a residential installation. This equipment generates, uses and can radiate radio frequency energy and, if not installed and used in accordance with the instructions, may cause harmful interference to radio communications. However, there is no guarantee that interference will not occur in a particular installation. If this equipment does cause interference to radio or television reception (which you can determine by turning the equipment off and on), you are encouraged to try to correct the interference by one or more of the following measures:

- Reorient or relocate the receiving antenna (the antenna for radio or television that is receiving the interference)
- Change the position of the Digital Satellite Receiver with respect to the radio or television equipment that is receiving the interference
- Move the Digital Satellite Receiver away from the equipment that is receiving the interference
- Plug the Digital Satellite Receiver into a different outlet so that the Digital Satellite Receiver and the equipment receiving the interference are on different branch circuits

Shielded cables and I/O cords must be used for this equipment to comply with the relevant FCC regulations. Changes or modifications not expressly approved in writing by Sony Electronics, Inc., void the user's authority to operate this equipment.

If these measures do not eliminate the interference, you should consult your Digital Satellite Receiver dealer or an experienced radio/television technician for additional suggestions. In addition, you may find the following booklet prepared by the Federal Communications Commission helpful: "How to Identify and Resolve Radio-TV Interference Problems." This booklet is available from the U.S. Government Printing Office, Washington, D.C., 20402 Stock No. 004-000-00345-4.

Limited Warranty

Digital Satellite Receivers

SONY ELECTRONICS INC. ("SONY") warrants this Product (including any accessories) against defects in material or workmanship as follows:

- 1 **LABOR.** For a period of 90 days from the original date of purchase, if the Product is determined to be defective, SONY will repair or replace the Product at no charge. After this 90 day period, you must pay for all labor charges.
- 2 **PARTS.** For a period of one (1) year from the original date of purchase, SONY will supply, at no charge, new or rebuilt replacements in exchange for defective parts. Any replacements will be warranted for the remainder of the original warranty period or ninety (90) days from installation by SONY's authorized facility, whichever is longer.
- 3 **ACCESSORIES.** Parts and labor for all accessories are for one (1) year.
- 4 **IN-HOME.** For a period of one (1) year from installation date, if the unit was professionally installed by a SONY authorized Digital Satellite Receiver Installer and the LNB (Electronic Antenna Element) fails to function properly, SONY will repair or replace the LNB with a new or rebuilt part. Labor to repair or replace the LNB (after 90 days from purchase) will be at your expense. If no problem is found, or any other item fails, it will be your responsibility to pay the installer their regular rate for an in-home service call.

To obtain warranty service, you must take the Product, or deliver the Product freight prepaid, in either its original packaging or packaging affording an equal degree of protection, to a SONY authorized Digital Satellite Receiver service facility. Please see the telephone number at the end of this section for a number to call to locate the closest facility.

This warranty does not cover customer instruction, installation, setup adjustments or signal reception problems.

This warranty does not cover cosmetic damage or damage due to acts of God, accident, misuse, abuse, negligence, commercial use, or modification of, or to any part of the Product, including the antenna. This warranty does not cover improper installation (if self-installed), loss of use of the product, or wasted programming charges due to product malfunction. This warranty does not cover damage due to improper operation or maintenance, connection to improper voltage supply, or attempted repair by anyone other than a facility authorized by SONY to service the Product. This warranty does not cover Products sold AS IS or WITH ALL FAULTS. This warranty is valid only in the United States.

Proof of purchase in the form of a bill of sale or receipted invoice which is evidence that the unit is within the Warranty period must be presented to obtain warranty service.

REPAIR OR REPLACEMENT AS PROVIDED UNDER THIS WARRANTY IS THE EXCLUSIVE REMEDY OF THE CONSUMER. SONY SHALL NOT BE LIABLE FOR ANY INCIDENTAL OR CONSEQUENTIAL DAMAGES FOR BREACH OF ANY EXPRESS OR IMPLIED WARRANTY ON THIS PRODUCT. IN NO EVENT SHALL SONY BE LIABLE FOR ANY INCIDENTAL OR CONSEQUENTIAL DAMAGES WHATSOEVER ARISING OUT OF THE USE OR INABILITY TO USE THE PRODUCT. UNDER NO CIRCUMSTANCES SHALL SONY'S LIABILITY, IF ANY, EXCEED THE PURCHASE PRICE PAID FOR THE PRODUCT. EXCEPT TO THE EXTENT PROHIBITED BY APPLICABLE LAW, ANY IMPLIED WARRANTY OR MERCHANTABILITY OR FITNESS FOR A PARTICULAR PURPOSE ON THIS PRODUCT IS LIMITED IN DURATION TO THE DURATION OF THIS WARRANTY.

This warranty is invalid if the factory applied serial number has been altered or removed from the Product.

Some states do not allow the exclusion or limitation of incidental or consequential damages, or allow limitations on how long an implied warranty lasts, so the above limitations or exclusions may not apply to you. In addition, if you enter into a service contract with the SONY Partnership within 90 days of the date of sale, the limitation on how long an implied warranty lasts does not apply to you. This warranty gives you specific legal rights, and you may have other rights which vary from state to state.

For your convenience, SONY ELECTRONICS INC. has established telephone numbers for frequently asked questions. To locate the servicer or dealer nearest you, for assistance or resolution of a service problem, or for product information or operation, call:

**SONY SATELLITE SYSTEM INFORMATION CENTER
1-800-838-7669 (Sony)**

For an accessory or part not available from your authorized dealer, call:

1-800-488-7669

About Sony Customer Support

Every DIRECTV System manufactured by Sony comes with Sony's Express Support at no charge to you. In the event of a system failure, our Express Support Program can have a replacement receiver on its way to you via overnight Federal Express (for calls Monday-Friday until 7:30 pm Eastern Time; Saturday delivery depends upon zip code). All it takes is a valid credit card to cover a security deposit, and Sony will pay freight in both directions. Our Express Support continues with our 800 number, staffed by dedicated technical representatives who can answer questions on dealer locations, system operation, installation, hookup, accessories, and how to get the most out of your home entertainment system. Sony's Express Support program: another expression of our commitment to excellence in customer service.

Index

A

- AC Power Cord, connecting, 13
- Access Card, inserting, 13
 - replacing, 31
 - slot, 13, 69, 70
- Adjusting the on-screen displays, 47
- Alert. *See* Timer & Rec.
- Alpha List, 36
- ALT AUDIO button, 14
- Antenna. *See* RF antenna, satellite dish antenna, and Local TV off-air antenna.
- Arrow buttons, on front panel, 68
 - on RM-Y139 remote control, 16
- Aspect Ratio, setting, 30
- Audio system, connecting, 10
- Audio, display, 64
 - track, 64
- AUTO skip feature, 50
- Auto Title Insert, 28
- Azimuth, 25

B

- Back panel connections, SAT-A55, 69
 - SAT-B55, 70
- Batteries, inserting into remote control, 7
- Blocking, pay per view, 55
 - stations, 56

C

- Carton contents, 6
- CATEGORY button, 15, 17, 38
- Category Guide, 35
- CH +/- buttons, 15
- CH/PAGE buttons, 17
- Changing channels, 20
- CODE SET button, 14, 17, 65
- Codes, Manufacturer, 66, 67
 - RF security, 33
 - VCR Manufacturer, 27
- Color, setting, 48
- Connecting, audio system, 10
 - IR Blaster, 11
 - local TV off-air antenna, 9
 - RF Antenna, 12
 - TV and VCR, 10
 - TV with A/V connectors, 9
 - TV with RF connector, 9
- Controls, location and Function, 68
- Custom stations, 50
- Customer support, 2
- Customizing the Favorite Stations guide, 41

D

- Data services, 51
- Default language, setting, 64
- DIGITAL OUT (OPTICAL) jack, 10, 69
- DISPLAY button, 14, 16
- Display options, 47
- Display, changing the colors, 48
- Dolby Digital, 10, 64

E

- Editing Favorite Stations, 41
- Editing Favorite Titles, 42
- Editing Locks & Limits, 53
- Editing timer events, 63
- Elevation, 25
- ENTER button, 15, 17
- EXIT button, 15, 16

F

- FAVORITE button, 14, 17, 40
- Favorite Stations guide, 40
 - changing the Favorite Title, 42
 - setting up, 40
- FCC Regulations, 76
- Features, 4
- Front panel controls, 68
- FUNCTION buttons, 15, 17

G

- GUIDE button, 15, 17, 37
- Guides Menu, 35
- Guides, using, 35

H

- Highlight and Select, 18

I

- INDEX button, 14, 16, 39
- Information Area, 37
- Input source, 9, 10, 19
- IR remote control reception, 32

J

- Joystick, 14, 18
- JUMP button, 15, 16

L

- Languages, 64
- Limited Warranty, 77
- List Area, 37
- Local TV off-air antenna, 9
- Locking your receiver, 57

Locks and limits, 53
 display, 53
 locking, 57
 setting, 54
 unlocking, 58
 LOW SPEED DATA port, 69, 70

M

Macrovision copy-protection, 2
 Mail. *See* messages.
 Main Menu, 21
 Manufacturer codes, 66, 67
 Media Window, 37
 MENU button, 15, 17, 21, 68
 Messages, 52
 indicator, 68
 viewing, 52
 MUTING button, 14, 16

O

One Button Timer & Rec, 60
 Other Guides, 43

P

Passcode, setting, 57
 Pay per view, cancelling programs, 59
 checking purchases, 59
 locking, 55
 purchasing programs, 45
 POWER buttons, 15, 17, 19
 POWER Indicator, 68
 Preferences Menu, 46
 Problems, troubleshooting, 72
 Program Data Download, 11, 60
 Program Guide, 37
 Program information, 35
 Purchases display, 59

R

Rating limit, setting, 55
 Recording programs, with Timer, 60–63
 Reminder. *See* Timer & Rec.
 Remote control, buttons and functions, 14–17
 inserting the batteries, 7
 manufacturer codes, 66, 67
 selecting items, 18
 setting IR and RF, 32
 setting up, 65
 RF Antenna, connecting, 12
 RF remote control reception, 32
 RF REMOTE jack, 69
 RF security code, setting, 33

S

Satellite Dish Antenna, connecting, 8
 setting, 23
 SATELLITE IN jack, 8, 69, 70
 Scheduling programs, 60
 Security code. *See* RF security code and passcode.
 Selecting items, 18
 Setting up the receiver, 22
 the remote control, 65
 Signal Seeker, 23, 24
 Signal Strength meter, 23
 Skipping stations, 50
 SLEEP button, 14
 Specifications, 71
 Spending limit, 54
 Station and program information, 35
 order, 49
 Station Index, 39
 Stations Blocked, setting, 56
 Surf setting, 49
 S-VIDEO jack, 9, 10
 System Menu, 22
 System test, performing, 29

T

Telephone line, connecting, 8
 Testing the system, 29
 Tilt, 23
 Timer & Rec, checking and editing, 63
 display, 61
 setting up, 61
 Timer events, 60–63
 indicator, 68
 Transponder, 23
 Troubleshooting, 72
 TV, connecting, 9, 10
 TV/SAT button, 15, 16
 TV/VIDEO button, 15, 16
 TV/VTR button, 15, 16

U, V

Unlocking your receiver, 58
 VCR Control feature, 11, 26
 VCR CONTROL jack, 11, 69, 70
 VCR Controller, connecting, 11
 VCR, connecting, 10
 recording, 60
 Viewing pictures, 19
 VOL buttons, 14, 17
 VTR3/2/DVD/AMP switch, 15

W, Z

Warranty. *See* Limited Warranty.
 Zip code, for setting antenna, 25

Free Manuals Download Website

<http://myh66.com>

<http://usermanuals.us>

<http://www.somanuals.com>

<http://www.4manuals.cc>

<http://www.manual-lib.com>

<http://www.404manual.com>

<http://www.luxmanual.com>

<http://aubethermostatmanual.com>

Golf course search by state

<http://golfingnear.com>

Email search by domain

<http://emailbydomain.com>

Auto manuals search

<http://auto.somanuals.com>

TV manuals search

<http://tv.somanuals.com>