

DIRECTV Digital Satellite Receiver

Operating Instructions

BEFORE USING YOUR DIRECTV SYSTEM

You must activate your programming service by calling your program providers:

*DIRECTV 1-800-347-3288
USSB 1-800-204-8772*

For more information, see page 22.

SAT-A4 MODEL ONLY

RF ANTENNA: The digital satellite receiver is shipped with IR reception enabled and RF reception disabled. To use the RF feature (and the antenna), you must change the factory setting (IR ONLY) to the RF setting (RF ONLY) using the on-screen displays, as described in this manual.



***SAT-A4
SAT-B3***

WARNING

To reduce the risk of fire or shock hazard, do not expose the unit to rain or moisture.

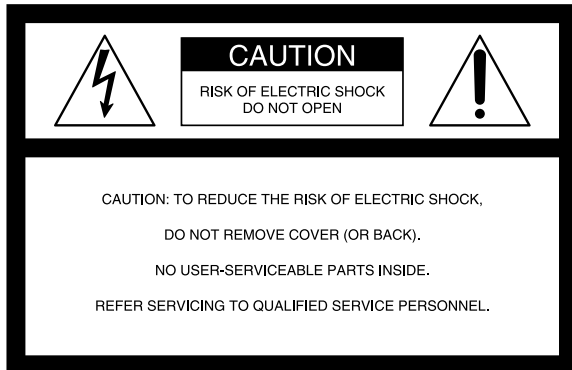

This symbol is intended to alert the user to the presence of uninsulated "dangerous voltage" within the product's enclosure that may be of significant magnitude to constitute a risk of electric shock to persons.



This symbol is intended to alert the user to the presence of important operating and maintenance (servicing) instructions in the literature accompanying the appliance.

Note to the CATV Installer

This reminder is provided to call the CATV system installer's attention to Article 820-40 of the NEC that provides guidelines for proper grounding and, in particular, specifies that the cable ground shall be connected to the grounding system of the building as close to the point of cable entry as practical.

Note to the Satellite Dish Antenna Installer

This reminder is provided to call the Satellite Antenna installer's attention to Article 810 and in particular Article 810-15 of the NEC, which covers proper installation and grounding of television receiving equipment, as well as to Article 820-40 of the NEC, which specifies that the Satellite Antenna cable ground shall be connected to the grounding system of the building as close to the point of cable entry as practical.

Telephone Line Interruption

Periodically, information on your DIRECT TICKET® and Pay Per View selections is sent, free of charge, via your telephone line to an 800 number. During the time the information is being forwarded, you cannot use your telephone and you will hear static noise for approximately 30 seconds. If you would like to use your telephone while the information is being sent, you can interrupt the sending of this information at any time by temporarily unplugging the phone line to the receiver.

You are cautioned that any changes or modifications not expressly approved in this manual could void your authority to operate this equipment.

Owner's Record

The model and serial numbers are located on the bottom of the Digital Satellite Receiver. The number for the access card is on the back of the card and on the carton label. Record these numbers in the space provided below. Refer to these numbers whenever you need to call your sales or service representative regarding this product.

Model Number: _____

Serial Number: _____

Access Card Number: _____

Customer Support

For Programming

For subscription information, or to resolve problems related to programming, call:

DIRECTV at 1-800-DIRECTV (347-3288) or
USSB at 1-800-204-USSB (8772).

For Hardware and Installation

To arrange for the installation of your DIRECTV System, call the dealer from whom you purchased your system.

For general information, or to resolve problems related to the operation of your Digital Satellite Receiver or Satellite Antenna, please contact your Sony dealer. If your dealer or installer is unable to answer your questions, call the Sony Satellite System Information Center at 1-800-838-7669.

Trademark and Copyrights

Sony and Express Navigator are trademarks of Sony. DIRECTV is a trademark of DIRECTV, Inc., a unit of Hughes Electronics, and is used with permission. USSB and USSB Entertainment Plus are official service marks of the United States Satellite Broadcasting Company, Inc.

Manufactured under license from Dolby Laboratories Licensing Corporation. "Dolby", the double-D symbol, and "AC-3" are trademarks of Dolby Laboratories Licensing Corporation.

Macrovision Information

This product incorporates copyright protection technology that is protected by U.S. patents and other intellectual property rights. Use of this copyright protection technology is granted by Macrovision for home and other limited pay-per-view uses only. Reverse engineering or disassembly is prohibited.

Note on Recording Programming

Programming may be taped for home viewing only. All other taping is expressly prohibited. Some programming may not be taped. An additional taping fee may be applied. Call your program providers for details.

StarSight Licensed

The manufacture and sale of the television schedule feature of this product was licensed under one or more of the following patents of StarSight Telecast, Inc.: U.S. Patent Nos. 4,706,121; 4,977,455; 5,151,789; and 5,353,121; with use rights reserved.

Network Broadcasting Information

ABC, CBS, NBC, FOX, and PBS networks are available from DIRECTV. Some restrictions apply.

Contents

Chapter 1

Introducing the DIRECTV System

- 4 Features
- 5 Package Contents
- 6 Inserting Batteries into the Remote Control

Chapter 2

Using Basic Functions

- 7 Remote Control for Model SAT-A4
- 8 Remote Control for Model SAT-B3
- 9 Using a Program Guide
- 10 Using the Station Index

Chapter 3

Connecting Your DIRECTV System

- 11 Overview
- 12 TV Only
- 14 TV and VCR
- 16 Home Entertainment System
(Hi-Fi TV, Hi-Fi VCR, Audio/Video Receiver)
- 18 Connecting the IR Blaster
- 19 Setting Up the RF Antenna (SAT-A4 Only)
- 20 Setting Up Your DIRECTV System

Chapter 4

Using the DIRECTV System Features

- 21 Overview
- 22 Before You Get Started ...
- 23 Using the On-Screen Displays:
Highlight and Select
- 24 Displaying the Program Guide
- 25 Features of the Program Guide
- 26 Moving Through the Program Guide
- 28 Selecting a Program from the Guide
- 29 Selecting a Category List
- 30 Selecting a Different Category Guide or List
- 33 Using the Station Index
- 35 Setting Up the Timer
- 37 Using the Favorite Station Guides
- 40 Displaying the Program Banner
- 41 Using the DISPLAY Feature

Chapter 5

Using the Options Menu

- 43 Overview
- 44 Displaying the Options Menu
- 45 Checking and Cancelling PPV Purchases
- 46 Setting Display Options
- 48 Using the Jump Loop Feature
- 49 Setting Locks and Limits
- 54 Setting Up a List of Custom Stations
- 56 Setting Audio Options
- 59 Reading Your Messages
- 61 Selecting Data Services

Chapter 6

Using the Setup Menu

- 63 Overview
- 64 Displaying the Setup Menu
- 65 Setting Up the Satellite Dish Antenna
- 66 VCR Recording
- 68 Replacing Your Access Card
- 70 Setting the Aspect Ratio
- 71 Setting Up the Remote Control (SAT-A4 Only)
- 75 Running a System Test
- 76 Displaying Help, Tips, and Shortcuts

Appendix

Other Information

- 78 Location and Function of Controls
- 81 Using the Remote Control
- 85 Programming the Remote Control
- 87 Troubleshooting
- 90 Precautions
- 91 FCC Regulations and Information
- 92 Limited Warranty
- 93 Specifications
- 94 Index

Introducing the DIRECTV System

Welcome to the Sony brand DIRECTV System, the ultimate digital entertainment experience. Read this chapter for an overview of features of the system and to check the carton contents of the Digital Satellite Receiver.

Features

Here are just a few benefits you'll enjoy:

Excellent Performance

- ❑ Superior, digital-quality video that rivals the performance of laserdisc players.
- ❑ Crisp digital-quality audio that will enhance your TV or home theater experience.

Premium Entertainment

- ❑ Choose from a variety of program packages available through your program providers, DIRECTV and USSB.
- ❑ Connect this receiver to your Dolby[®] Digital decoder or Dolby Digital A/V receiver for dynamic surround sound.

Convenience and Ease-of-Use

- ❑ Order premium pay per view (PPV) movies. PPV programs start as often as every 30 minutes, so you can watch programs when *you* want to see them.
- ❑ Sony's Express Navigator™ on-screen display system guides you through all the system features and functions.
- ❑ Select from a variety of program guides that are sorted by program categories, including Sports, Movies, News, and more.
- ❑ The Timer feature, when used with Sony's IR Blaster, allows easy One Button Recording of digital satellite programs.

Easy to Customize

- ❑ Create a Custom Category Guide and up to five of your own Favorite Station Guides for stations you watch most often.
- ❑ Change the color palette, and station ordering of the program guides. Use the DISPLAY button to toggle among different sizes of on-screen displays.
- ❑ Set up a passcode, which lets you choose spending limits and control viewing of programs by rating and station.

Package Contents

Check to make sure you've received the following items in the Digital Satellite Receiver's carton:

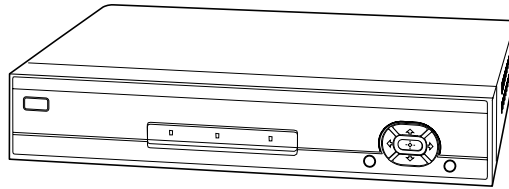

Digital Satellite Receiver

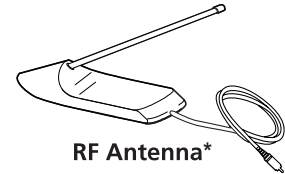

RF Antenna*

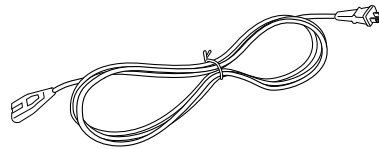

AC Power Cable

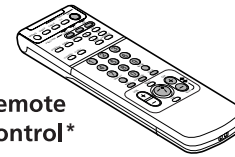

Remote Control*

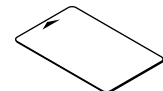

Access Card



Size AA Batteries

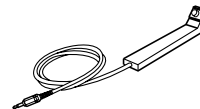

IR Blaster

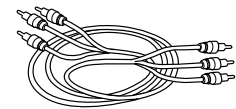

Audio/Video Cable



RF Coaxial Cable

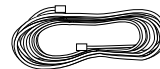

Phone Line

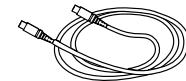

S-Video Cable*

* RF Antenna and S-Video cable are not included with SAT-B3. SAT-A4 includes the RM-Y800 remote control shown above; SAT-B3 includes the RM-Y139 remote control shown on page 8.

If you are missing items, contact the dealer from whom you purchased the Digital Satellite Receiver.

Note

Keep the original carton and packing materials to safely transport the system in the future.

Inserting Batteries into the Remote Control

Before you can use the remote control, you must first insert the supplied batteries. If you want to use this remote control to operate other video components, such as a TV or cable box, you must also program the remote as described in the Appendix on page 85.

To install the batteries:

- 1 Push and slide open the battery compartment.

SAT-A4 Remote Control:

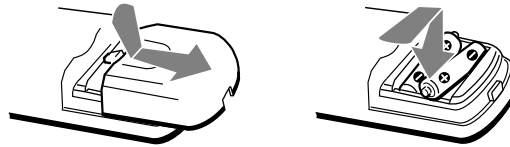

SAT-B3 Remote Control:

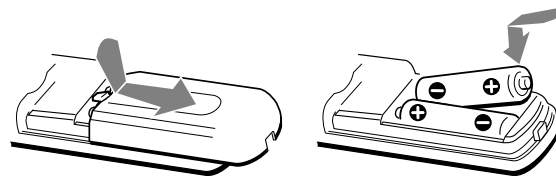

- 2 Insert two size AA batteries (supplied). Be sure to match the + and – marks on the batteries with the + and – marks in the battery compartment.

Notes on Batteries

- ❑ When the batteries become weak, the Function button indicator flashes. If the remote control does not operate properly, the batteries might be weak. When replacing batteries, replace both batteries with new ones. Do not mix different types of batteries together.
- ❑ When you remove the batteries — to replace them, for example — any codes you've set may be erased. If this happens, you must reprogram the remote. See "Programming the Remote Control" on page 85 for details.
- ❑ When replacing the batteries, do not touch any buttons on the remote control.

Using Basic Functions

You can start watching programs using just a few buttons on the remote control. Here's an overview of the buttons you'll use most often.

Remote Control for Model SAT-A4

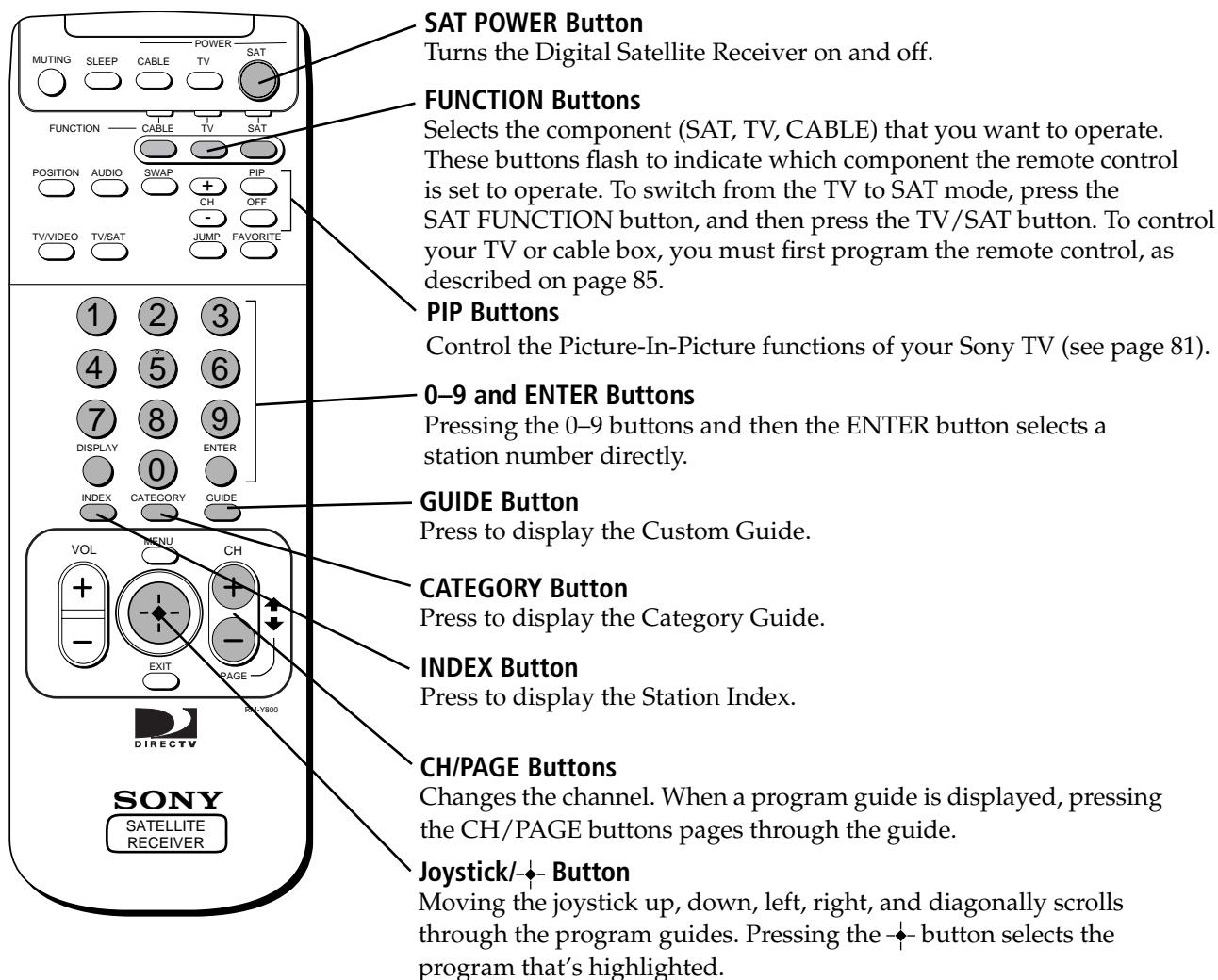

See Also

- ❑ Pages 9-10 for a quick start to using the program guide and the Station Index.
- ❑ Pages 81-83 for a complete description of the buttons on the remote.

Remote Control for Model SAT-B3

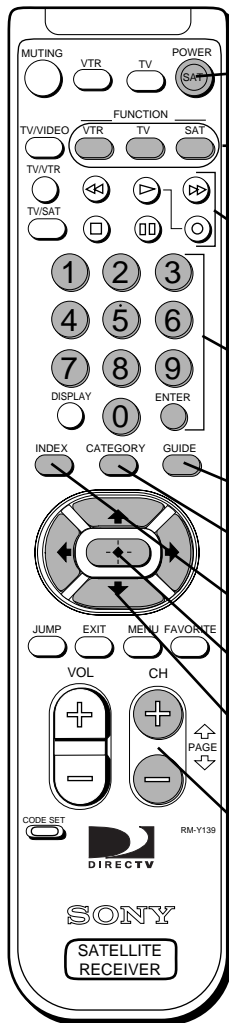

SAT POWER Button

Turns the Digital Satellite Receiver on and off.

FUNCTION Buttons

Selects the component (SAT, TV, VTR) that you want to operate. These buttons flash to indicate which component the remote control is set to operate. To control your TV or VTR(VCR), you must first program the remote control, as described on page 85.

VCR Control Buttons

Pressing the buttons will activate standard VCR features: Play, Record, Pause, Stop, Rewind and Fast Forward.

0-9 and ENTER Buttons

Pressing the 0-9 buttons and then the ENTER button selects a station number directly.

GUIDE Button

Press to display the Custom Guide.

CATEGORY Button

Press to display the Category Guide.

INDEX Button

Press to display the Station Index.

◆ Button

Selects the program that's highlighted.

Arrow Buttons

Scroll through the program guide.

CH/PAGE Buttons

Change the channel. When a program guide is displayed, pressing the CH/PAGE buttons pages through the guide.

See Also

- ❑ Pages 9-10 for a quick start to using the program guide and the Station Index.
- ❑ Page 84 for a complete description of the buttons on the remote.

Using a Program Guide

The program guide displays the programming that's available from your program providers.

- 1 Press the GUIDE button to bring up the Custom Guide.

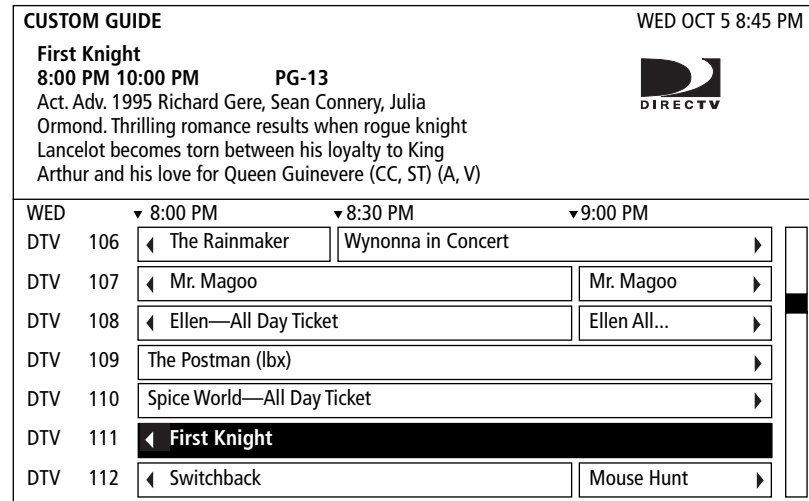

- 2 Move the highlight to the name of the program you want.

You'll hear the audio and see the video (in the background) of each program as they are highlighted.







The table below lists the various ways in which you can move around in the guide.

- 3 Press the  button to select the highlighted program.

Moving Around In a Program Guide

You can also change the look of the program guide by pressing the DISPLAY button. See "Using the DISPLAY Feature" on page 41.

In program guides, you can select station call letters/numbers to display a description of the station.

To Do This ...	Use This Button
Go to other stations in the guide one station at a time	SAT-A4 : Move the joystick up and down SAT-B3: Press the  and  buttons
Go to other time slots in the guide one program at a time	SAT-A4: Move the joystick left and right to move one time slot at a time. SAT-B3: Press the  and  buttons Both Models: Or press the GUIDE button to "page" to future time slots.
Go to other stations in the guide one "page" at a time	Press the PAGE  (CH+) and PAGE  (CH-) buttons
Go to a station directly	Press the 0-9 buttons and press ENTER (to specify the station number)
Return to the last station you were watching	Press the EXIT button

Using the Station Index

The Station Index lets you select a program from a grid of station logos and call letters.

Note

Pressing EXIT removes all on-screen displays. Also, you may need to change to another station if a message appears, which requests that you press the \leftarrow button to purchase the program, etc.

- 1 Press INDEX to bring up the Station Index.

Your Station Index may not look exactly like this. The stations displayed depend on the programming you've ordered.

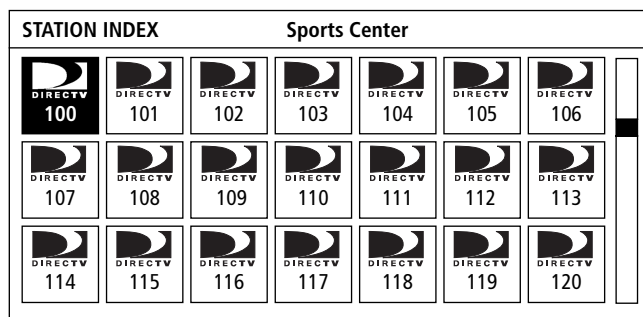

- 2 Move the highlight to the station you want.

The program title is displayed at the top of the Station Index. Also, you'll hear the audio and see the video (in the background) of each program, as they are highlighted.

The table below lists the various ways in which you can move around in the Station Index.

- 3 Press the \leftarrow button to tune to the program that's highlighted.

Moving Around In the Station Index

You can also change the look of the Station Index by pressing the DISPLAY button. See "Using the DISPLAY Feature" on page 41.

To Do This ...	Use This Button
Go to other stations in the guide, one station at a time	SAT-A4: Move the joystick in any direction SAT-B3: Press the \uparrow \downarrow \leftarrow \rightarrow buttons
Go to other stations in the Station Index, one "page" at a time	Press the PAGE \uparrow (CH+) and PAGE \downarrow (CH-) buttons
Go to a station directly	Press the 0-9 buttons and press ENTER (to specify the station number)
Return to the last station you were watching	Press the EXIT button

Connecting Your DIRECTV System

Read this chapter to set up your Digital Satellite Receiver for the first time, or to add or remove audio or video components connected to your system.

Overview

You can connect the Digital Satellite Receiver in a variety of configurations. The answers to the following questions will determine how you hook up and operate your Digital Satellite Receiver. For example:

- Do you have cable TV or a broadcast (terrestrial) TV antenna?
- What type of connectors do your TV and VCR have: S-VIDEO, A/V (RCA-type), or RF coaxial?
- Do you plan to integrate your Digital Satellite Receiver with your audio or video system?
- Do you have a Dolby Digital decoder or Dolby Digital A/V receiver?

Detailed hookup instructions are provided on the pages that follow. For optimum audio and video performance, follow these general recommendations as much as possible when hooking up your components:

- If you have an audio or audio/video system, consider integrating the Digital Satellite Receiver into a home entertainment configuration to take advantage of your hi-fi system's audio capabilities.
- If your TV has an S-VIDEO jack, use it to connect your TV to the Digital Satellite Receiver. An S-Video connection provides a better picture than A/V or RF connections.
- If your TV does not have an S-VIDEO jack, use your TV's A/V connectors to connect your components. An A/V connection provides a better picture and audio when compared to an RF connection.
- If you have a Dolby Digital decoder, or an A/V receiver with Dolby Digital, you can connect these components using an optical cable and set the Audio options to allow Dolby Digital signals to be output to your other components (see page 58). Dolby Digital provides up to six discrete channels of audio for a complete surround sound experience.
- If your A/V receiver has a digital optical input terminal, you can connect it to your A/V receiver using an optical cable.

Note:

Before you connect the RG-6 coaxial cable from the LNB to the Digital Satellite Receiver, make sure the Digital Satellite Receiver is unplugged. This will prevent your Digital Satellite Receiver from experiencing a short.

(SAT-A4 Only)

TV Only

TV With RF Connector Only

Your VHF/UHF IN jack may be labeled as RF IN.

Refer to the illustration below.

- 1 Connect the RG-6 cable from the Satellite Antenna's LNB to the Digital Satellite Receiver's SATELLITE IN jack.
- 2 Connect the Digital Satellite Receiver's VHF(SAT)/UHF OUT jack to the TV's VHF/UHF IN jack.

Note

A VHF/UHF connection does not provide stereo sound. To receive stereo sound, you must use an A/V connection (described on page 13).

- 3 Connect one end of the telephone line cord to the Digital Satellite Receiver's TEL LINE jack. Connect the other end to your home's modular telephone outlet. Do not connect to a "wireless" telephone extension. Since these devices typically do not support high data rates, connecting to one may result in very slow operation or may even prevent connection with your program provider.
- 4 Connect one end of the AC power cord to the Digital Satellite Receiver's AC IN jack. Connect the plug end to an AC outlet.

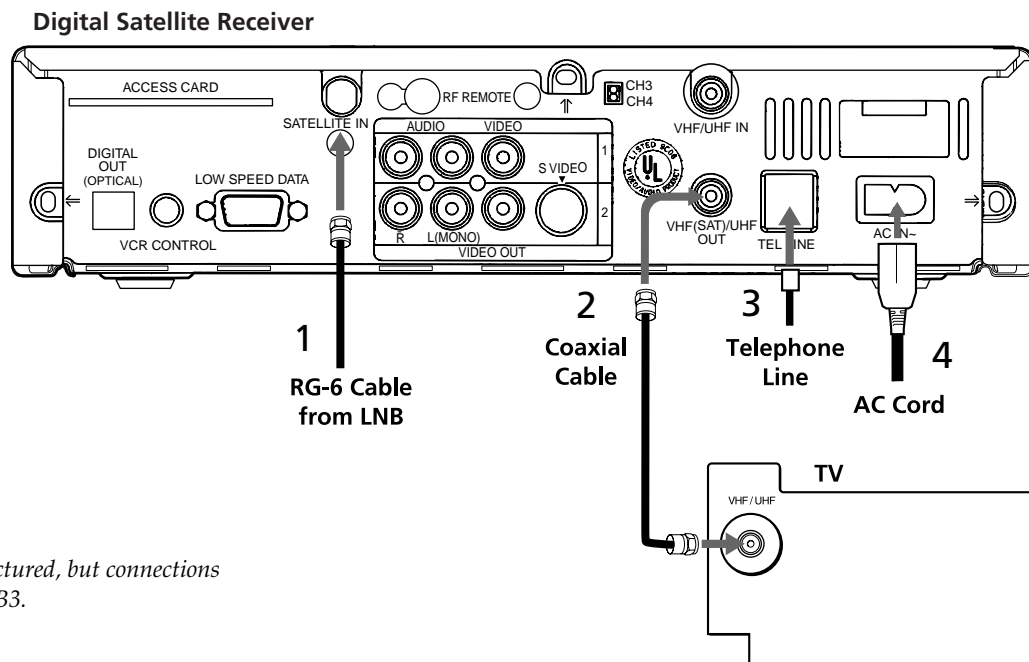

SAT-A4 receiver is pictured, but connections are identical for SAT-B3.

Optional Connections

- If you have a cable input, cable box, or a terrestrial TV antenna, connect it to the Digital Satellite Receiver's VHF/UHF IN jack.
- You can also connect the Digital Satellite Receiver to your audio receiver's AUDIO IN jacks using audio cables.

TV With A/V Connectors

If your TV has only one AUDIO IN jack, connect the lower (mono) AUDIO L jack on the Digital Satellite Receiver to the TV's AUDIO IN jack.

Refer to the illustration below.

- 1 Connect the RG-6 cable from the Satellite Antenna's LNB to the Digital Satellite Receiver's SATELLITE IN jack.
- 2 Connect the Digital Satellite Receiver's A/V jacks to the TV's A/V IN jacks.
- 3 Connect one end of the telephone line cord to the Digital Satellite Receiver's TEL LINE jack. Connect the other end to your home's modular telephone outlet. Do not connect to a "wireless" telephone extension. Since these devices typically do not support high data rates, connecting to one may result in very slow operation or may even prevent connection with your program provider.
- 4 Connect one end of the AC power cord to the Digital Satellite Receiver's AC IN jack. Connect the plug end to an AC outlet.

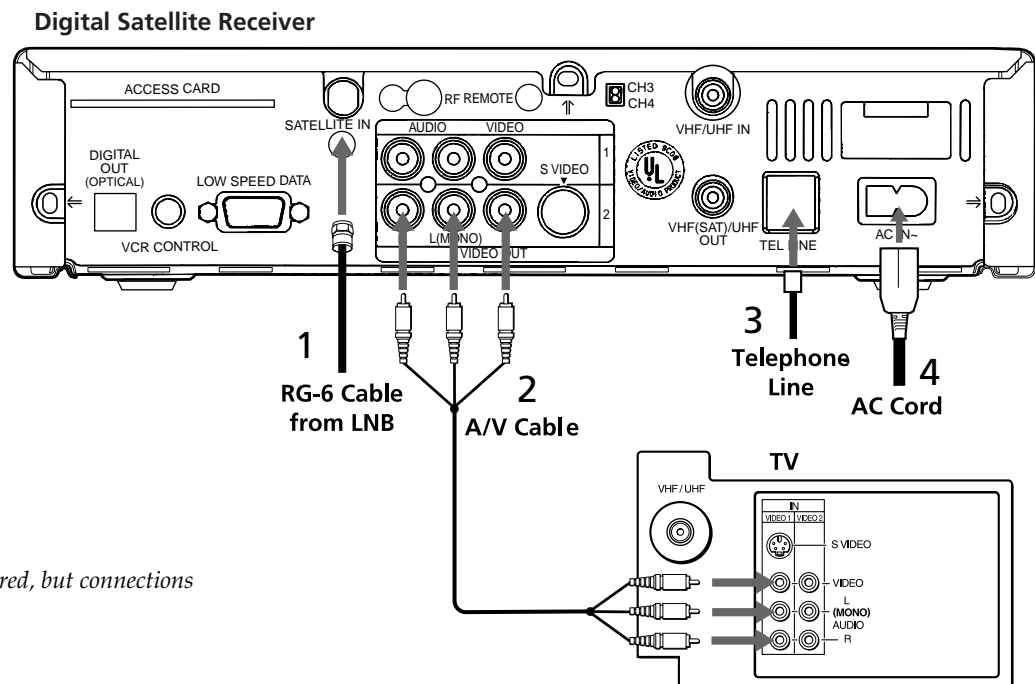

SAT-A4 receiver is pictured, but connections are identical for SAT-B3.

Your VHF/UHF IN jack may be labeled as RF IN.

Optional Connections

- If you have a cable input, cable box, or a terrestrial TV antenna, connect it to the TV's VHF/UHF IN jack.
- Best Connection:* If your TV has an S-VIDEO jack, use an S-VIDEO cable to connect the Digital Satellite Receiver's S-VIDEO jack to the TV's S-VIDEO IN jack. This provides the best picture quality. Then use audio cables to connect one set of the Digital Satellite Receiver's audio jacks to the TV's AUDIO IN jacks.
- You can also connect the Digital Satellite Receiver to your audio receiver's AUDIO IN jacks using audio cables.

TV and VCR

Refer to the illustration on the opposite page.

- 1 Connect the RG-6 cable from the Satellite Antenna's LNB to the Digital Satellite Receiver's SATELLITE IN jack.
- 2 Complete one of the following to connect the Digital Satellite Receiver:
 - ❑ *Better Connection:* Connect the Digital Satellite Receiver's A/V jacks to the A/V IN jacks on the TV and VCR. If your VCR has only one AUDIO IN jack (monoaural VCR), connect it to the lower AUDIO L (mono) jack on the Digital Satellite Receiver.
 - ❑ *Good Connection:* Connect the Digital Satellite Receiver's VHF(SAT)/UHF OUT jack to the VCR's VHF/UHF IN jack.
- 3 Complete one of the following to connect the VCR to the TV:
 - ❑ *Better Connection:* If both your TV and VCR have A/V jacks, connect the VCR's A/V OUT jacks to the TV's A/V IN jacks.
 - ❑ *Good Connection:* If your TV or VCR has only an RF jack, connect the VCR's VHF/UHF OUT jack to the TV's VHF/UHF IN jack.
- 4 Connect one end of the telephone line cord to the Digital Satellite Receiver's TEL LINE jack. Connect the other end to your home's modular telephone outlet. Do not connect to a "wireless" telephone extension. Since these devices typically do not support high data rates, connecting to one may result in very slow operation or may even prevent connection with your program provider.
- 5 Connect one end of the AC power cord to the Digital Satellite Receiver's AC IN jack. Connect the plug end to an AC outlet.

Your VHF/UHF IN jack may be labeled as RF IN.

Optional Connections

- ❑ If you have a cable input, cable box, or a terrestrial TV antenna, connect it to the TV or VCR's VHF/UHF IN jack.
- ❑ *Best Connection:* If your TV has an S-VIDEO jack, use an S-VIDEO cable to connect the Digital Satellite Receiver's S-VIDEO jack to the TV's S-VIDEO IN jack. This provides the best picture quality. Then use audio cables to connect one set of the Digital Satellite Receiver's audio jacks to the TV's AUDIO IN jacks.
- ❑ You can also connect the Digital Satellite Receiver to your audio receiver's AUDIO IN jacks using audio cables.
- ❑ If you are using the IR Blaster, see page 18 for setup instructions.

Note

If the screen appears fuzzy, the program you are watching may be protected by Macrovision. Turn the VCR off to improve the picture quality.

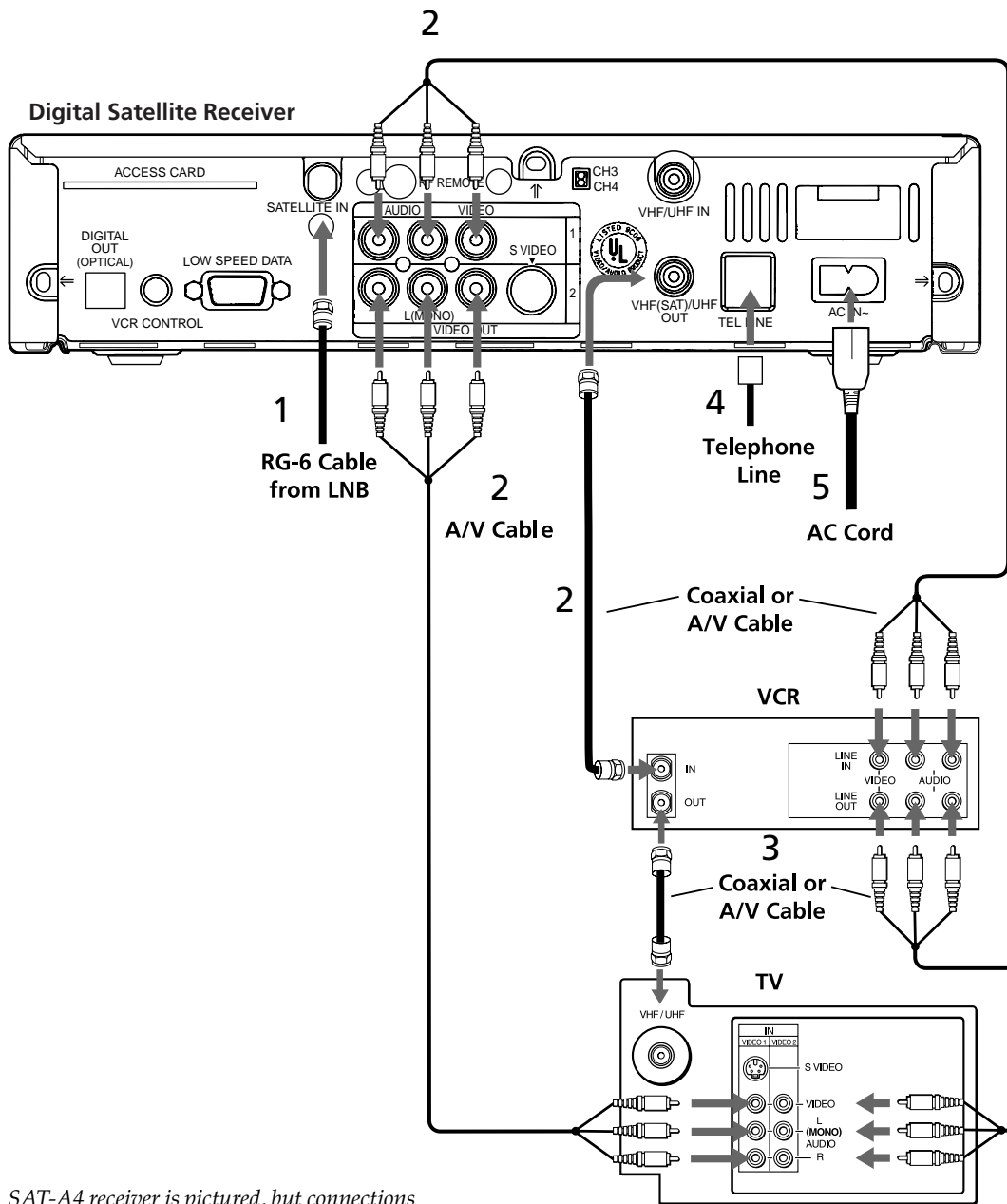

SAT-A4 receiver is pictured, but connections are identical for SAT-B3.

Home Entertainment System (Hi-Fi TV, Hi-Fi VCR, Audio/Video Receiver)

Refer to the illustration on the opposite page.

- 1 Connect the RG-6 cable from the Satellite Antenna's LNB to the Digital Satellite Receiver's SATELLITE IN jack.
- 2 Connect the Digital Satellite Receiver's A/V jacks to the VCR and A/V receiver's A/V IN jacks.
- 3 Connect the Digital Satellite Receiver's DIGITAL OUT jack to the A/V receiver's digital optical input jack (SAT-A4 only).
- 4 Connect the VCR's A/V OUT jacks to one set of the A/V receiver's A/V IN jacks.
- 5 Connect the A/V receiver's MONITOR OUT jack to the TV's VIDEO IN jack.
- 6 Connect one end of the telephone line cord to the Digital Satellite Receiver's TEL LINE jack. Connect the other end to your home's modular telephone outlet. Do not connect to a "wireless" telephone extension. Since these devices typically do not support high data rates, connecting to one may result in very slow operation or may even prevent connection with your program provider.
- 7 Connect one end of the AC power cord to the Digital Satellite Receiver's AC IN jack. Connect the plug end to an AC outlet.

Optional Connections

- If you have a cable input, cable box, or a terrestrial TV antenna, connect it to the VCR's VHF/UHF IN jack.
- Best Connection:* If your A/V receiver has an S-VIDEO jack, use an S-VIDEO cable to connect the Digital Satellite Receiver's S-VIDEO jack to the A/V receiver's S-VIDEO IN jack. Then connect an S-VIDEO cable from the A/V receiver to the TV's S-VIDEO IN jack. This provides the best picture quality. Then use audio cables to connect one set of the Digital Satellite Receiver's audio jacks to the A/V receiver's AUDIO IN jacks.
- If you are using the IR Blaster, see page 18 for setup instructions.

Note

If the screen appears fuzzy, the program you are watching may be protected by Macrovision. Turn the VCR off to improve the picture quality.

In this configuration, the A/V receiver must be turned on in order to view TV programs.

Your VHF/UHF IN jack may be labeled as RF IN.

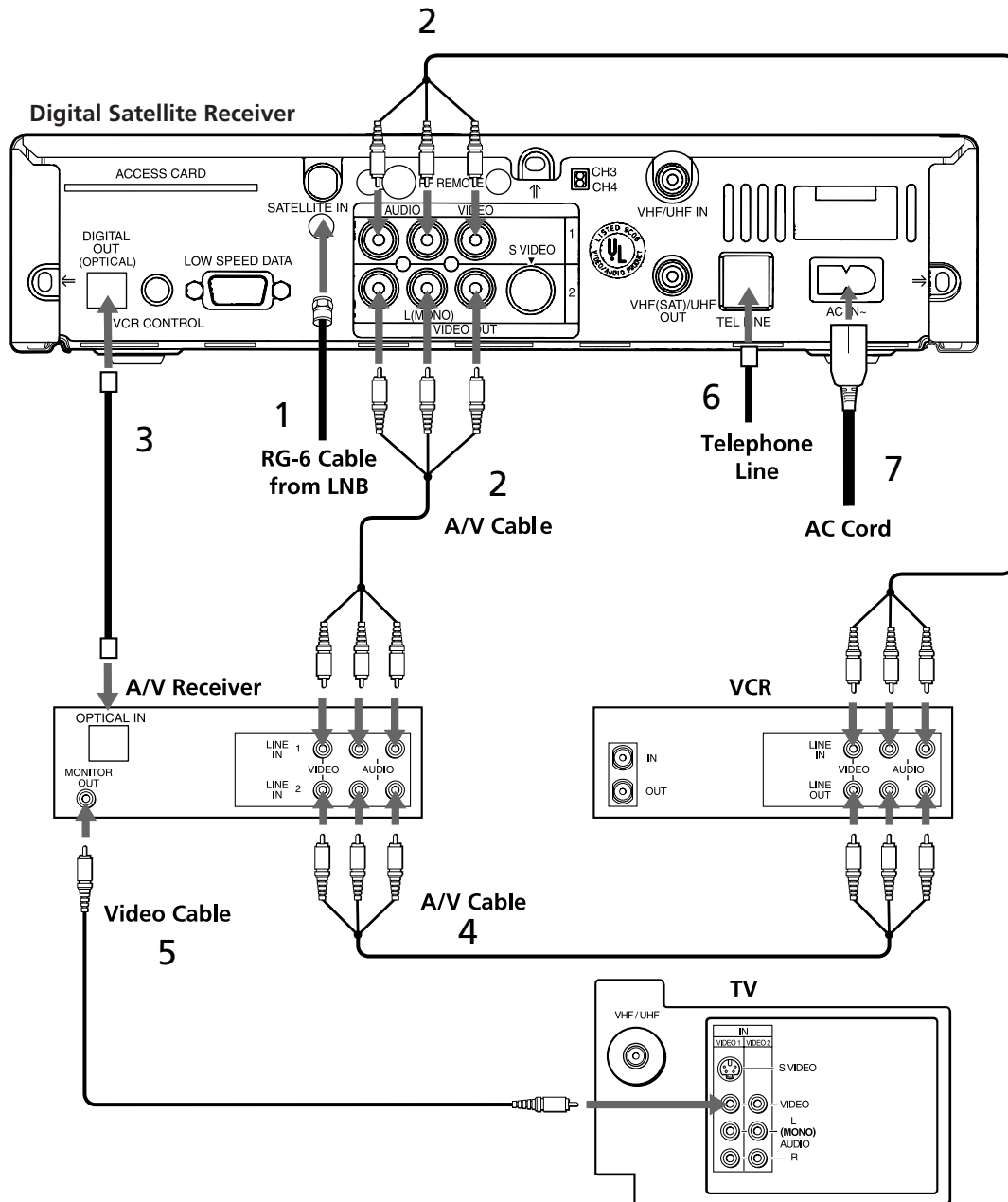

Connecting the IR Blaster

SAT-A4 receiver is pictured, but connections are identical for SAT-B3.

The IR Blaster works with the Digital Satellite Receiver's Timer function to automatically start and stop the recording function of your VCR.

- 1 Connect the IR Blaster to the Digital Satellite Receiver's VCR CONTROL jack. Then place the IR Blaster below and in front of the VCR, about $\frac{1}{2}$ " to 1". For best results, place the IR Blaster directly below the VCR's IR receiving area.

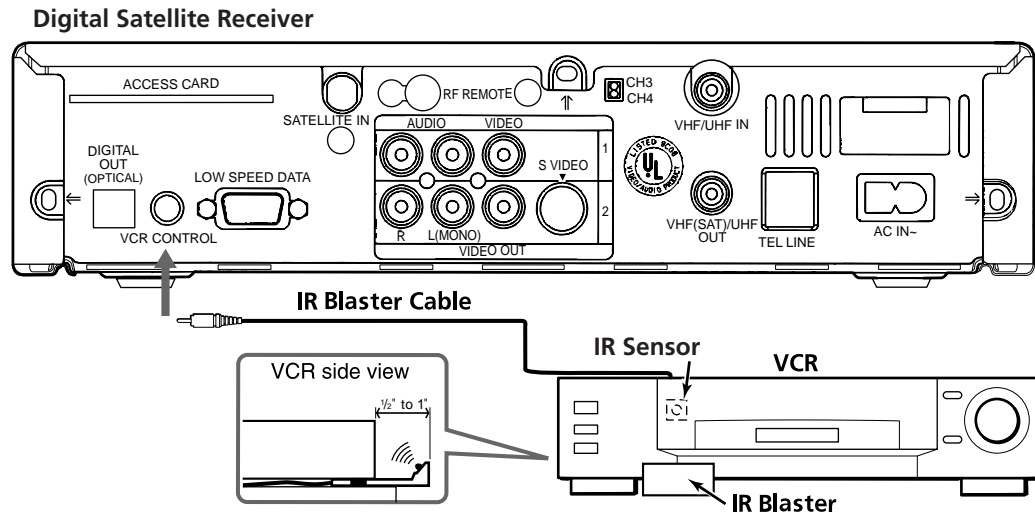

- 2 Set the manufacturer, and code type of your VCR using the VCR RECORDING Screen on page 66. This must be done for the IR Blaster to function properly.
- 3 To use the IR Blaster: **1)** Set the Timer (page 35), **2)** Turn on the VCR and set the VCR's line input to the Digital Satellite Receiver, **3)** Insert a tape, **4)** Turn off the VCR.

If the IR Blaster doesn't seem to be working correctly, first check that the IR Blaster is positioned directly below the VCR's IR receiving area and that the VCR's line input is set to the Digital Satellite Receiver. If it's still not working, try this procedure again using the other codes listed for your VCR on page 86.

Setting Up the RF Antenna (SAT-A4 Only)

The RF (radio frequency) antenna enables the remote control to operate the Digital Satellite Receiver even if the Digital Satellite Receiver is located in another room or is placed behind a cabinet door.

Note

You must set up the RF antenna if you plan on using the RF feature.

To set up the RF antenna:

- 1 Connect the RF antenna to the Digital Satellite Receiver's RF REMOTE jack.
- 2 Place the RF antenna at least one foot away from the Digital Satellite Receiver.
- 3 Use the on-screen displays to set up the Digital Satellite Receiver to accept RF transmission (RF ONLY). See "Setting Up the Remote Control" on page 71 for details.

Do not place the RF antenna directly on top of the Digital Satellite Receiver or any other metal object. For best results, place the RF antenna in a visible location.

The Digital Satellite Receiver is shipped with IR transmission enabled and RF transmission disabled. To use the RF feature, you must first change the factory setting (IR ONLY) to the RF setting (RF ONLY) using the on-screen displays, as described on page 71.

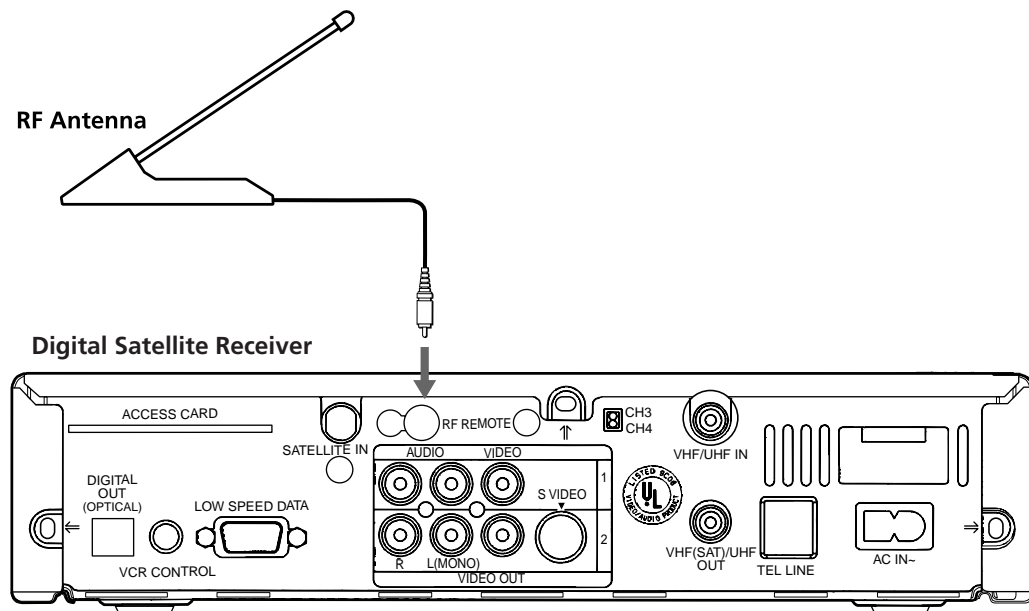

The operating range of the remote control is about 100 ft. This may decrease due to ambient radio wave conditions, your room's walls, weak batteries, etc.

Setting Up Your DIRECTV System

Viewing Satellite Programs

- 1 Turn on the TV, and then set the TV's line input to the Digital Satellite Receiver. (For example, set the TV to channel 3 or 4, if you used an RF connection; or set to VIDEO1, etc., if you used an A/V connection.)
- 2 Turn on the VCR and A/V receiver, if you connected these components. Then set their output switches accordingly.
- 3 Turn on the Digital Satellite Receiver and select a station.

Viewing Cable or Off-Air Programs

The following instructions apply only if you connected your cable TV or terrestrial antenna to your Digital Satellite Receiver.

- 1 Turn off your Digital Satellite Receiver, or press the TV/SAT button to set the Digital Satellite Receiver to TV mode.
- 2 Turn on the TV and then:
 - If you have a cable box, turn it on and then tune the TV to the output channel of your cable box, usually channel 3 or 4.
 - If you do not have a cable box, just tune your TV to the station you want to watch.

Recording Satellite Programs While Watching Cable or Off-Air Programs

The following instructions apply only if you connected your cable TV or terrestrial antenna to your Digital Satellite Receiver.

- 1 Turn on the TV and then:
 - If you have a cable box, turn it on and then tune the TV to the output channel of your cable box, usually channel 3 or 4.
 - If you do not have a cable box, tune your TV to the station you want to watch.
- 2 Turn on the Digital Satellite Receiver, and tune to the program you want to record. Then select the VCR to line input, and start recording, according to your VCR's instruction manual.
- 3 Press the TV/SAT button to set the Digital Satellite Receiver to TV.

The Digital Satellite Receiver's signal is sent to the VCR, while the off-air signal is sent to your TV for you to watch.

Note

For information on using the Digital Satellite Receiver's automatic timer, see "Setting Up the Timer" on page 35.

You cannot record one satellite program while watching another satellite program (unless you have a second Digital Satellite Receiver).

If the screen appears fuzzy, the program you are watching may be protected by Macrovision. Turn the VCR off to improve the picture quality.

Using the DIRECTV System Features

Read this chapter to learn how to use system features including the Master program guide, Station Index, Favorite Station Guide, and the ordering of pay per view programs.

Overview

This chapter provides detailed instructions for using the main features of your Digital Satellite Receiver. Topics include:

- ❑ Checking to make sure your system is completely set up and ready to be used (page 22).
- ❑ Using Highlight and Select, the simple, two-step process for operating the on-screen displays (page 23).
- ❑ Displaying and navigating through the program guide (page 24).
- ❑ Selecting subscription and pay per view programs from the program guides (page 28).
- ❑ Using the program list (page 29).
- ❑ Selecting other program guides that are sorted by category and subcategory (page 30).
- ❑ Using the Station Index (page 33).
- ❑ Setting the Timer (page 35).
- ❑ Using the five Favorite Station Guides (page 37).
- ❑ Displaying the Program Banner (page 40).
- ❑ Using the DISPLAY feature (page 41).

Before You Get Started ...

Make sure you (or your DIRECTV System installer) have completed the following procedures before you start using your Digital Satellite Receiver:

- 1 Install the Satellite Antenna as described in the *Satellite Dish Antenna Operating Instructions*.

Note

Make certain that you (or your installer) have optimized the signal strength. If the signal is not optimized, you may experience losses in audio or video, especially during rain, snow, or other conditions that tend to degrade signal performance. See the Satellite Dish Antenna Operating Instructions for details on pointing the dish and optimizing the antenna's signal strength.

- 2 Connect the Satellite Antenna to your Digital Satellite Receiver. Then connect the Digital Satellite Receiver to your television and telephone line. (See Chapter 3.)

Note

Your phone line must be connected to the Digital Satellite Receiver in order for you to purchase a pay per view program with the remote control.

- 3 Make sure the access card is inserted into the Digital Satellite Receiver. (See page 68 for details on inserting the access card.)
- 4 Call your program providers (DIRECTV and USSB) to activate your service. You'll need to provide information, including the model and serial numbers of your Digital Satellite Receiver and the access card number.

DIRECTV 1-800-DIRECTV (347-3288)

USSB 1-800-204-USSB (8772)

If Your System Is Not Completely Installed ...

See the manual that came with the Satellite Antenna and Chapter 3 of this manual for complete installation instructions. Or, see your dealer to arrange for a professional installation or the purchase of the Sony-brand Installation Kit.

Using the On-Screen Displays: Highlight and Select

All of the features and functions of the Digital Satellite Receiver can be operated using a simple, two-step process: Highlight and Select. These two steps are explained below.

Step 1: Highlight

- ❑ To highlight, move the joystick (SAT-A4) or press the arrow buttons (SAT-B3) on the remote to move the on-screen **highlight** to the item that you want to select.

Step 2: Select

- ❑ After you've highlighted the item that you want, select it by pressing the **↵** button.

Example: Highlight and Select

- 1 In the sample menu that follows, moving the joystick up (SAT-A4) or pressing the **↑** button (SAT-B3) moves the highlight from ITEM 5...

Shortcut

(SAT-A4 Only)

In many of the on-screen displays you can move the joystick in eight directions: left, right, up, down, and diagonally (up left, up right, down left, and down right).

SAMPLE MENU		
ITEM 1	ITEM 2	ITEM 3
ITEM 4	ITEM 5	ITEM 6
ITEM 7	ITEM 8	ITEM 9

... to ITEM 2.

SAMPLE MENU		
ITEM 1	ITEM 2	ITEM 3
ITEM 4	ITEM 5	ITEM 6
ITEM 7	ITEM 8	ITEM 9

- 2 Pressing the **↵** button selects ITEM 2.

You can apply this basic operation of highlighting and selecting to perform any of the system's functions.

Displaying the Program Guide

You can select programs using the CH+ and CH- buttons, or you can enter the station number directly using the 0-9 buttons. However, because the DIRECTV System offers you such a variety of programming choices, you'll get the most out of the system by using one of the on-screen program guides to find the programs you want to watch.

To display the Master Guide:

- ❑ Press the MENU button to bring up the Main Menu. Then highlight and select MASTER GUIDE from the menu.

Shortcut

You can select menu items directly by pressing the corresponding number button. For example, press 2 to select the Master Guide from the Main Menu.

MAIN MENU		
CATEGORY GUIDE 1	MASTER GUIDE 2	CATEGORY LIST 3
MOVIES GUIDE 4	EXIT 5	MOVIES LIST 6
OPTIONS MENU 7	TIMER SETUP 8	SETUP MENU 9

Note

To bring up the Custom Guide, press the GUIDE button on the remote control. See "Setting Up a List of Custom Stations" on page 54 for details.

Features of the program guide are discussed in more detail on the following pages.

Features of the Program Guide

When you select a guide from the Main Menu or press the GUIDE button on the remote, a program guide appears, similar to the following:

The screenshot shows a TV program guide interface. On the left, labels point to 'Program Guide', 'Program Description', and 'Schedule Grid'. On the right, labels point to 'Day, Date, Time', 'Station logo', and 'Page Indicator'. The interface displays the following information:

- Header:** MASTER GUIDE (left), WED OCT 5 8:45 PM (right)
- Program Description:** First Knight, 8:00 PM - 10:00 PM, PG-13. Act. Adv. 1995 Richard Gere, Sean Connery, Julia Ormond. Thrilling romance results when rogue knight Lancelot becomes torn between his loyalty to King Arthur and his love for Queen Guinevere (CC, ST) (A, V). Station logo: DIRECTV.
- Schedule Grid:** A table showing programs for Wednesday, October 5th. The current time is 8:45 PM.

Day	8:00 PM	8:30 PM	9:00 PM
DTV 106	The Rainmaker	Wynonna in Concert	
DTV 107	Mr. Magoo	Mr. Magoo	
DTV 108	Ellen—All Day Ticket	Ellen—All...	
DTV 109	The Postman (lhx)		
DTV 110	Spice World—All Day Ticket		
DTV 111	First Knight		
DTV 112	Switchback	Mouse Hunt	

Program guides, such as the Master Guide shown above, feature a variety of elements, including:

- Program guide title, such as Master Guide, Custom Guide, Movie Guide, Sports Guide, etc.
- Current day of the week, date and time.
- Station logo (when available) and program description of the currently highlighted station.
- One Button Recording of programs.
- Schedule grid, which includes:
 - Station names, numbers, and program titles. These appear in ascending numerical order from top to bottom (unless you have changed the listing to alphabetical order. See “Setting the Station Order” on page 47 for details).
 - Time slots. These appear left to right, with the current time’s programming in the leftmost position.
 - Page indicator. This shows you approximately which page you’re on, relative to all the pages in the guide. The size of the indicator is proportional to the overall size of the entire program guide.

Moving Through the Program Guide

The on-screen program guides are displayed only one page at a time. Because the program guide usually contains many pages, you need to move through the guide to see more of the programs contained in the guide. You can move by scrolling, paging, and direct station tuning.

Scrolling

To scroll, use the remote control to move the highlight one position at a time. You can scroll to different stations or time slots.

To move to other stations in the guide one station at a time:

- SAT-A4*: Move the joystick up or down.
- SAT-B3*: Press the up or down arrow buttons.

To move to other time slots in the guide:

- SAT-A4*: Move the joystick left or right.
- SAT-B3*: Press the left or right arrow buttons.

Paging Vertically Through the Stations

To page, use the PAGE buttons to move through the guide one page at a time. This allows you to move through the guide more quickly than scrolling.

To page through the guide:

- Press the PAGE \uparrow or PAGE \downarrow buttons.

The PAGE \uparrow button pages in the up direction. The PAGE \downarrow button pages in the down direction.

Paging Through Later Program Start Times

To display future time slots in the guide:

- Press the GUIDE button.

Pressing the GUIDE button repeatedly cycles through all the available time slots in the guide as they are made available by your program providers (for example, THU 3:00 PM, THU 10:00 PM, FRI 3:00 AM, etc.).

Note

To select a future program guide directly, press the MENU button and then select SELECT GUIDE/TIME. See page 31 for details.

Direct Station Tuning

To move to a station directly:

- Press the 0-9 buttons to specify the station number. Press the ENTER button to change the station more quickly.

Displaying Favorite Stations

To see your favorite stations at the top of the program guide:

- ❑ Press the FAVORITE button.

Pressing the FAVORITE button repeatedly cycles through the stations currently set for the five Favorite Station Guides (FAVORITE 1, 2, 3, 4, 5), and then back to the normal guide.

Note

See page 37 for instructions on setting up your favorite stations.

Changing the Appearance of the Guide

To toggle through the three variations of program guide:

- ❑ Press the DISPLAY button repeatedly. (See "Using the DISPLAY Feature" on page 41 for details.)

Exiting the Guide

There are two ways to exit the program guide:

- ❑ Select a program from the guide by pressing the  button. (See "Selecting a Program from the Guide" on page 28 for details.)

OR

- ❑ Press the EXIT button on the remote. You will be returned to the last program you were watching before the program guide was displayed.

One Button Recording

Setting up the IR Blaster (See "Connecting the IR Blaster" on page 18 for details) and the VCR (See "VCR Recording" on page 66 for details) will allow you to record a future program, simply and automatically, when selected from a guide and added to the timer.

Selecting a Program from the Guide

For all programs except pay per view (PPV), you can select a program from the guide just by pressing the **↔** button. If the program is currently showing, the guide disappears and the program you selected appears.

If the program has not yet started, a pop-up window appears, which gives you the option of adding the program to the Timer list, returning to the program guide, or tuning to the current program on that station. See "Setting Up the Timer" on page 35 for details on using the Timer.

Watching a PPV program is similar, except it requires you to order the program before you can watch it beyond the free preview period (usually about five minutes after the program starts).

Ordering Pay Per View Programs

Selecting RETURN returns you to the previous screen, without purchasing the program.

Selecting TIMES brings up a list of additional show times that you can choose from for the program you selected.

A PREVIEW button, which gives you a free preview of the program, appears only when the preview is available.

If the BUY button does not appear (and the message "Purchase information not available" appears), you must call your program provider to order the program in advance.

To order a PPV program listed in the program guide:

- 1 Highlight the program name in the guide and press the **↔** button.
- 2 Select BUY from the Purchase Program screen.

PURCHASE PROGRAM	
First Knight	
WED OCT 5	8:00 PM - 9:30 PM
DTV 102	Rating:PG-13
Act. Adv. 1995 Richard Gere, Sean Connery, Julia Ormond. Thrilling romance results when rogue knight Lancelot becomes torn between his loyalty to King Arthur and his love for Queen Guinevere (CC, ST, (A, V)	
Price/View:\$2.99	
	<input type="button" value="RETURN"/>
	<input type="button" value="BUY"/>
	<input type="button" value="TIMES"/>
	<input type="button" value="HELP"/>

- 3 When the Confirm Purchase pop-up window appears, select YES to confirm your purchase. Selecting NO returns you to the Purchase Program screen, without purchasing the program.

If the program has not yet started, a pop-up window appears, which gives you the option of adding the program to the Timer list, returning to the program guide, or tuning to the current program on that station. See "Setting Up the Timer" on page 35 for details on using the Timer.

To watch a PPV program you've purchased in advance, just tune to the station when the program is about to start. Your program providers will bill you automatically.

About Copy-Protection

Some PPV programs are copy-protected by Macrovision at the discretion of the copyright owner. When watching a PPV program, turn the VCR off to ensure a quality picture.



















Selecting a Category List

The Category List displays programs alphabetically by program title, as opposed to the Guide format, which sorts the programs numerically by station number. A sample Movies List is shown below.

The buttons that appear for each program indicate start times.

For example, in this sample Movie List, "First Knight," with a start time of 9:00PM, is highlighted.

To select a program, highlight the start time button and then press the  button.

MOVIES LIST		WED OCT 5 8:45 PM			
First Knight					
8:00 PM - 10:00 PM	PG-13				
Act. Adv. 1995 Richard Gere, Sean Connery, Julia Ormond. Thrilling romance results when rogue knight Lancelot becomes torn between his loyalty to King Arthur and his love for Queen Guinevere (CC, ST) (A, V)					
		WED 9 PM	9:30	10 PM	10:30
Ellen—All Day Ticket					
First Knight					
Johnny Mnemonic					
Judge Dredd (Letterbox)					
The Postman					
Spice World—All Day Ticket					
Switchback					

To display a Category List, select MOVIES LIST from the Main Menu. To set up a different program category for the Category List, see "Selecting a Different Category Guide or List" on page 30.

To move to other programs in the list one program at a time:

- SAT-A4: Move the joystick up or down.
- SAT-B3: Press the up or down arrow buttons.

To move to other time slots in the list:

- SAT-A4: Move the joystick left or right.
- SAT-B3: Press the left or right arrow buttons.

To page through the list:

- Press the PAGE  or PAGE  buttons.

To toggle through the three variations of lists:

- Press the DISPLAY button repeatedly. (See "Using the DISPLAY Feature" on page 41 for details.)

To exit the list:

- Select a program from the list by pressing the  button.

Or

- Press the EXIT button on the remote. You will be returned to the last program you were watching before the list was displayed.

Selecting a Different Category Guide or List

You can use the SELECT GUIDE and SELECT LIST options in the Main Menu to select subsets of the Master Guide in either the Guide or List format.

- 1 Press the MENU button to bring up the Main Menu.
- 2 Select CATEGORY GUIDE or CATEGORY LIST from the Main Menu. The Select Guide (or List) screen appears.

The GUIDE and TIME options are not available when you select CATEGORY LIST.

Selecting RESET resets the screen to the default guide (Custom/Current/Movies/All).

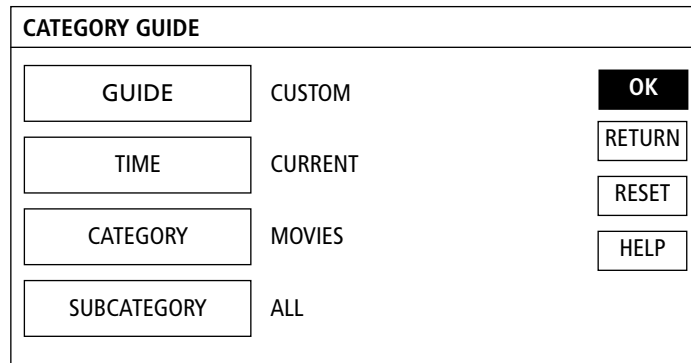

- 3 Select a different Guide, Time, Category, and Subcategory, described as follows.

Selecting a Category Guide Type

The GUIDE option lets you select from a list of alternative program guides, which are made available by your program providers. These guides may contain groups of stations with similar subjects, for example, special promotions or pay per view programs.

To select a guide type:

- 1 Select GUIDE from the Category Guide screen.
- 2 Select the type of guide you want to display.

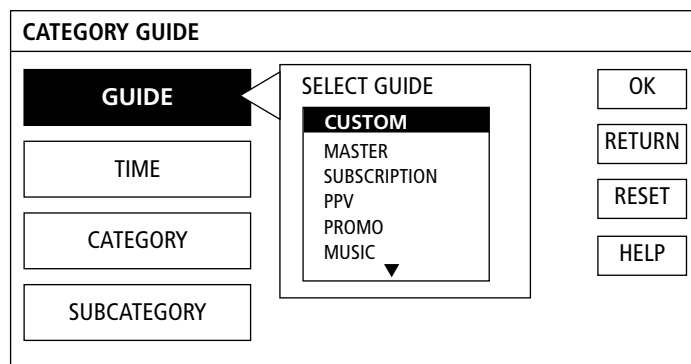

Press the  button on the remote control to bring up the CATEGORY GUIDE screen directly.

- 3 Select OK to display the selected program guide, or select different options for time, category, or subcategory.

Selecting a Guide Time

The TIME option lets you select from a list of future program guides.

To select a future program guide:

- 1 Select TIME from the Category Guide screen.
- 2 Select the time you want to display.

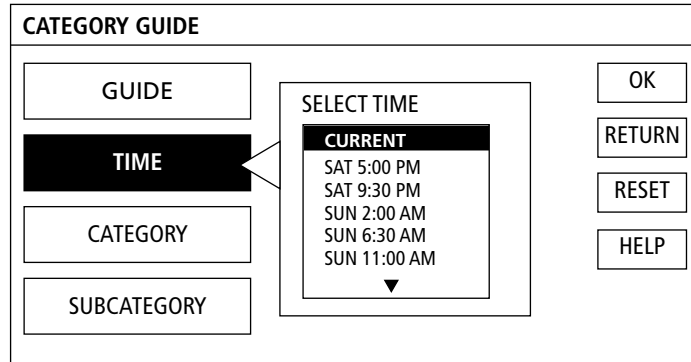

- 3 Select OK to display the selected program guide, or select different options for guide, category, or subcategory.

Selecting a Guide Category

The CATEGORY option lets you select from a list of program guide categories.

To select a program guide category:

- 1 Select CATEGORY from the Category Guide screen.
- 2 Select the program category you want to display.

Press the  button on the remote control to bring up the CATEGORY GUIDE screen directly.

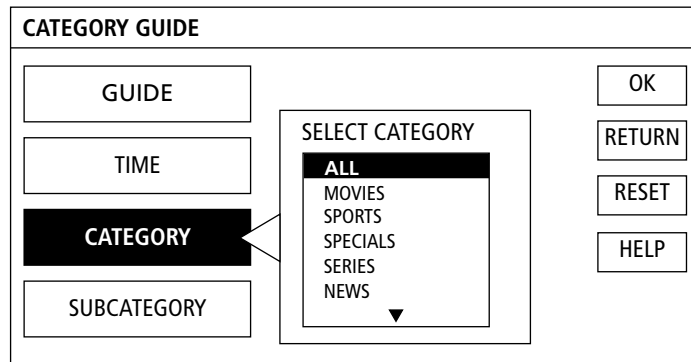

- 3 Select OK to display the selected program guide, or select different options for guide, time, or subcategory.

Selecting a Guide Subcategory

The SUBCATEGORY option lets you select from a list of program guide subcategories, based on the selected program category.

Note

You cannot select SUBCATEGORIES if CATEGORY is set to ALL.

To select a program guide subcategory:

- 1 Select SUBCATEGORY from the Category Guide screen.

The Select Subcategory screen appears.

- 2 Select the program subcategories you want (you can select more than one subcategory). A selected subcategory appears with a checkmark (✓) beside it. To deselect a subcategory, just select it again. The checkmark disappears. After you've made your selections, select OK to return to the Select Guide screen.

Selecting ALL places a checkmark beside all the subcategories. Selecting NONE removes the checkmark from all the subcategories.

Selecting CANCEL returns you to the previous screen, without saving your selections.

SELECT MOVIES SUBCATEGORY				
ACTION/ ADVENTURE ✓	CHILDREN ✓	COMEDY ✓	DRAMA ✓	OK
FANTASY ✓	HORROR ✓	MUSICAL ✓	ROMANCE ✓	CANCEL
SCIENCE FICTION ✓	WESTERN ✓	OTHER ✓		ALL
				NONE
				HELP

- 3 Select OK to display the selected program guide, or select different options for guide, category, or subcategory.

The next time you display the Main Menu, it will include the Guide or List category that you selected. To change category selections, select CATEGORY GUIDE or CATEGORY LIST from the Main Menu or hit the category button on the remote control.

How CATEGORY GUIDE and CATEGORY LIST Change the Main Menu

Example: If you select the Sports Guide using CATEGORY GUIDE, button 4 of the Main Menu automatically changes to SPORTS GUIDE.

Similarly, button 6 of the Main Menu automatically updates to the last selection you made using CATEGORY LIST.

The selections you make using CATEGORY GUIDE and CATEGORY LIST affect the program categories displayed in the Main Menu. The category you select using CATEGORY GUIDE changes button 4 of the Main Menu. The category you select using CATEGORY LIST changes button 6 of the Main Menu.

This feature allows you to recall the last program guide or list that you selected.

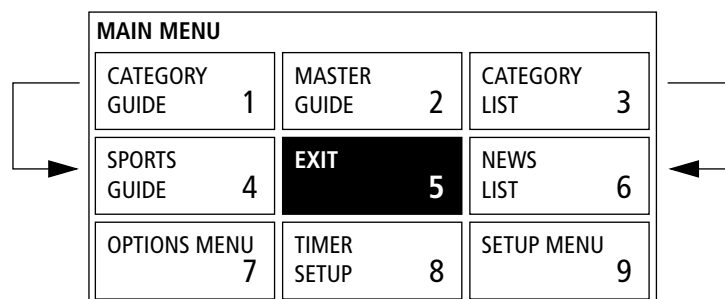

Using the Station Index























The Station Index is an on-screen display that contains the station logo (or call letters) of all the stations in the system.

To display the Station Index:

- ❑ Press the  button on the remote control.



The Station Index appears. The station you are currently tuned to is automatically highlighted and program title is displayed at the top.

Your Station Index may not look exactly like this. The stations displayed depend on the programming you've ordered.

STATION INDEX							Sports Center
 100	 101	 102	 103	 104	 105	 106	
 107	 108	 109	 110	 111	 112	 113	
 114	 115	 116	 117	 118	 119	 120	

Moving Through the Station Index

To move through the Station Index:

- ❑ Move the joystick (*SAT-A4*) or press the arrow buttons (*SAT-B3*) to move one station at a time.
- ❑ Press the PAGE  or PAGE  buttons to page (move up or down several rows at a time).
- ❑ Enter the station number, using the 0-9 buttons and press ENTER.

Displaying Favorite Stations in the Station Index

To display your favorite stations on the top row of the Station Index:

- ❑ Press the FAVORITE button.

Pressing the FAVORITE button repeatedly cycles through the five Favorite Station Guides.

The top row contains your seven favorite stations from one of your five Favorite Station Guides.

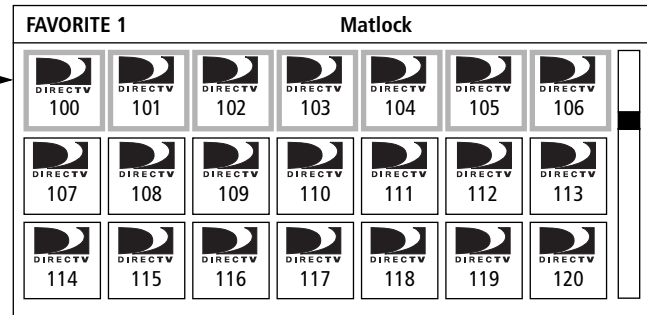

Note

See page 37 for instructions on setting up your favorite stations.

Changing the Appearance of the Station Index

To toggle through the three variations of Station Index:

- ❑ Press the DISPLAY button repeatedly. (See “Using the DISPLAY Feature” on page 41 for details.)

Selecting a Program from the Station Index

To select a program:

- ❑ Press the  button to tune to the highlighted station. The Station Index disappears.

To exit the Station Index without changing stations:

- ❑ Press the EXIT button. The Station Index disappears, and you return to the station you were watching before displaying the Station Index.

Setting Up the Timer

You can select from two ways to automate VCR recording of programs:

- ❑ Setting the Timer and then setting your VCR timer.
- ❑ Setting the Timer and using the Sony IR Blaster to automatically control the VCR (see “Connecting the IR Blaster” on page 18, and “VCR Recording” on page 66 for details).

Setting the Timer

To set the timer:

- 1 Press the MENU button to bring up the Main Menu.
- 2 Select TIMER SETUP. The Timer Setup screen appears.

Shortcut

You can automatically add future programs to the Timer screen by just selecting them from the program guide. See “Selecting a Program from the Guide” on page 28 for details.

- 3 Select one of the 10 timer setting buttons. Then highlight the DAY field (today’s date automatically appears).

One Button Recording

If you’ve entered the Timer Setup screen by selecting a future program from a program guide, the Day, Start and Stop times, Station, and program title are displayed automatically.

However, if you make any changes to the Timer Setup options, the program title disappears (although the Timer will still work as you’ve set it).

TIMER SETUP					
	DAY	START	STOP	STATION	
1	11/9 SAT	-:-	-:-	--- ----	OK
2	-/-	-:-	-:-	--- ----	CANCEL
3	-/-	-:-	-:-	--- ----	CLEAR
4	-/-	-:-	-:-	--- ----	HELP
5	-/-	-:-	-:-	--- ----	

- 4 Set the day, start time, stop time, and station number as follows:
 - ❑ To set each item (day, time, etc.), move the joystick up or down (SAT-A4) or press up or down arrow buttons (SAT-B3).
 - ❑ To move to the next or previous item, move the joystick right or left (SAT-A4) or press the right or left arrow buttons (SAT-B3).

Note

You can set the timer up to 30 days in advance. You can also set the timer for every day or for the same day(s) every week. See “Setting the Daily/Weekly Timer” on page 36.

- 5 Select OK to save your settings.

Setting the Daily/Weekly Timer

To set the timer for every day or for the same day(s) every week:

- 1 In step 4 (page 35), move the highlight down repeatedly to select one of the DAY options, which are displayed in the following sequence:
Current Date → DAILY → MON-FRI → EVERY SAT ... →
EVERY MON → EVERY SUN → 1 Month Later → (Cycles backward) → Current Date
- 2 Set the start time, stop time, and channel, then select OK to save your settings.

Changing/Checking/ Clearing Timer Settings

To change, check, or clear timer settings:

- 1 Bring up the Timer Setup screen, as described on page 35.
- 2 Check your settings.
 - ❑ If you don't want to make any changes, select OK.
 - ❑ If you want to change or clear settings, select the numbered button of the timer setting you want to change.
- 3 Change or clear the setting as follows:
 - ❑ To change the setting, highlight the item you want to change. Then reset the item by moving the joystick up or down (SAT-A4) or press the up or down arrow buttons (SAT-B3).
 - ❑ To clear the setting, select CLEAR.
- 4 Select OK to save your settings.

Notes on Using the Timer

- ❑ After the timer is set, the TIMER indicator on the front panel lights up, indicating that the timer has been set.
- ❑ To use the timer to record a PPV program, you must first purchase it in advance of its showing. See "Ordering Pay Per View Programs" on page 28.
- ❑ Use the MON-FRI option only if you do not plan to EXIT during your timer event. If you think you may want to EXIT during your timer event, set each day of the week individually.
- ❑ If locks and limits are set (and the system is locked), check to make sure they do not conflict with the program you're trying to record.
- ❑ About 60 seconds before the timer automatically tunes to the specified channel, a message appears. To cancel the timer setting and continue watching the current program, press the EXIT button.
- ❑ If you set overlapping (conflicting) timer settings, the Digital Satellite Receiver handles these timer settings as follows:
 - ❑ If you set two timer settings to start at the same time, the timer setting that's listed first has priority over any other conflicting timer settings. Conflicting timer settings are automatically cleared from the Timer Setup screen when the first timer setting is activated.
 - ❑ If you set a second timer setting to start before the first timer setting is set to stop, the second timer setting will start before the first timer setting stops.

Using the Favorite Station Guides

The Favorite Station Guide is a program guide that includes up to seven of your favorite stations. You can create up to five Favorite Station Guides: FAVORITE 1, 2, 3, 4, 5.

Setting Up and Using the Favorite Station Guides

Before you can bring up the Favorite Station Guide, you must first clear the program guide from your TV screen. Pressing EXIT turns off any on-screen displays.

To set up the Favorite Station Guide:

- 1 Press the FAVORITE button. The first Favorite Station Guide appears (FAVORITE 1).

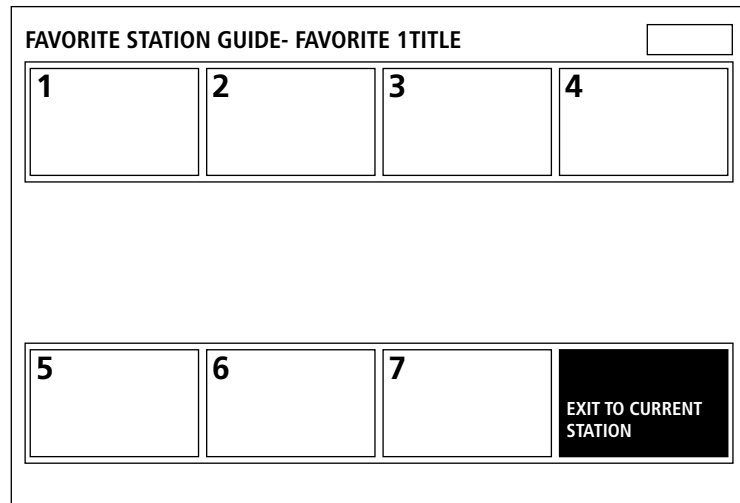

The system is shipped with no favorite stations set, so the first time you see this guide, the seven Favorite Station buttons are blank.

- 2 Highlight a Favorite Station button that you want to set. Then press and hold the  button.

The Favorite Station Guide switches to edit mode: The station list appears, the selected Favorite Station button flashes, and the highlight moves to the current station in the station list.

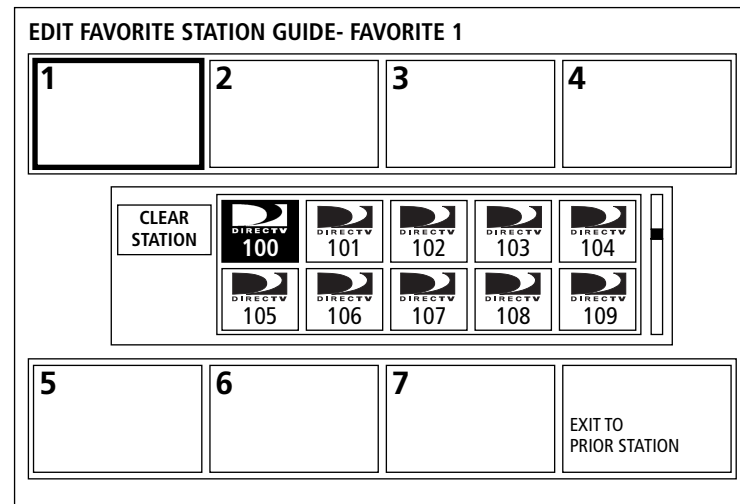

- 3 To assign a station to the flashing Favorite Station button, do one of the following:
- ❑ Select it from the station list by highlighting it and then pressing the **+** button.
 - ❑ Enter the station number (such as 100), using the 0-9 buttons on the remote. Then press the **+** button.

To clear a Favorite Station button that is already assigned, select **CLEAR STATION**.

EDIT FAVORITE STATION GUIDE - FAVORITE 1

1 100 DIRECTV DIRECT TICKET PREVIEWS	2	3	4
---	----------	----------	----------

CLEAR STATION					

5	6	7	EXIT TO PRIOR STATION
----------	----------	----------	--------------------------

The station list disappears, and the Favorite Station Guide reappears with the stations you've set up.

FAVORITE STATION GUIDE - FAVORITE 1 TITLE

1 100 DIRECTV DIRECT TICKET PREVIEWS	2	3	4
---	----------	----------	----------

5	6	7	EXIT TO PRIOR STATION
----------	----------	----------	--------------------------

To set other Favorite Station buttons:

- ❑ Repeat steps 2 and 3.

To clear a Favorite Station button setting:

- ❑ Overwrite the setting by repeating steps 2 and 3. Or, highlight the button and then select CLEAR STATION.

To set up or display a different Favorite Station Guide:

- ❑ Press the FAVORITE button repeatedly to select the Favorite Station Guide you want (FAVORITE 1, 2, 3, 4, 5).

To tune to a Favorite Station (and exit the Favorite Station Guide):

- ❑ Press the number button that represents the station. Or highlight and then select the Favorite Station button that you want to tune to.

To exit the Favorite Station Guide without changing stations:

- ❑ Select "Exit to Current Station," which appears in the bottom right corner of the Favorite Station Guide or press the EXIT button.

Creating a Custom Favorite Station Guide Title

To create a custom title for the Favorite Station Guide:

- 1 Select TITLE from the Favorite Station Guide. The Set Favorite Guide Title screen appears.
- 2 To edit the title, move the joystick up or down (SAT-A4) or press the up or down arrow buttons (SAT-B3) to enter each character.

To move from character to character, move the joystick left or right (SAT-A4) or press the left or right arrow buttons (SAT-B3).

Selecting CANCEL returns you to the previous screen, without saving your selections.

Selecting CLEAR erases all the characters in the title.

SET FAVORITE GUIDE TITLE

F	A	V	O	R	I	T	E		1
---	---	---	---	---	---	---	---	--	---

OK
CANCEL
CLEAR
HELP

- 3 Select OK to save your new title and return to the Favorite Station Guide.

Displaying the Program Banner

The program banner provides useful information about the program you're currently watching.

Note





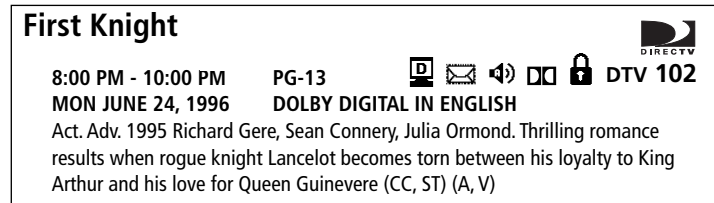

Before you can bring up the program banner, you must first clear the program guide from your TV screen. Pressing EXIT turns off any on-screen displays. Also, you may need to change to another station if a message appears, which requests that you press the  button to purchase the program, etc.

To display the program banner:

- Press the DISPLAY button.



The program banner shows the program title, station name and number, current date and time, start and end times, rating, and program description. It may also include any of the following indicators:

Symbol	Indicates	For Details See
	Data services available	page 61
	New and unread messages	page 59
	Audio tracks available	page 56
	Dolby Digital available	page 56
	System is locked	page 49
	System is temporarily unlocked	page 52

To clear the program banner:

- Press the DISPLAY or EXIT button or wait a few seconds (except some music channels) for it to automatically disappear.

Using the DISPLAY Feature

You can use the DISPLAY button to change the appearance of the on-screen displays.

The chart below illustrates how the DISPLAY button toggles through the three types of displays of Program Guides (and Lists), Station Index, and Favorite Station Guide.

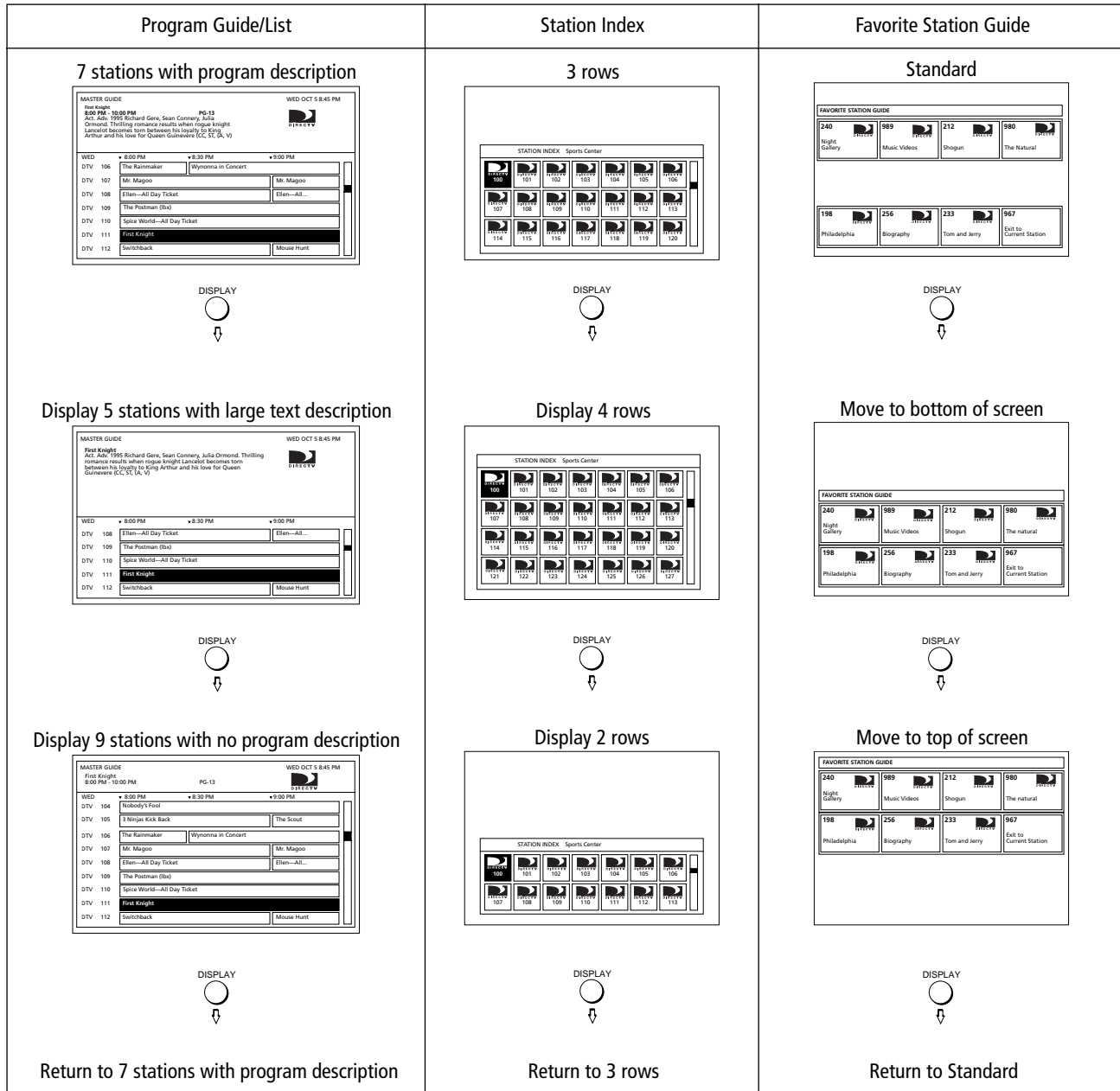

Using the Options Menu

Read this chapter to get information about using the Options Menu to customize the setup of the on-screen displays, review and cancel your purchases, and read mail messages that have been sent to you.

Overview

This chapter describes how to:

- ❑ Check and cancel pay per view programs you've ordered (page 45).
- ❑ Change the look of the program guides, including the color of the on-screen displays and the order in which the stations are displayed (page 46).
- ❑ Setting up and using the Jump Loop feature (pages 47–48).
- ❑ Set system locks and limits, which allow you to control program viewing by ratings, spending amount, and station (page 49).
- ❑ Create a Custom Guide by selecting stations from the Master Guide that you want to skip (page 54).
- ❑ Select an audio track for the program you're currently watching, set a default language for the audio of programs and set the Dolby Digital default (page 56).
- ❑ Read mail messages that have been sent to your Digital Satellite Receiver (page 59).
- ❑ Select a data service for stations that include data services offered by your program providers (page 61).

Displaying the Options Menu

To bring up the Options Menu:

- 1 Press the MENU button to bring up the Main Menu.
- 2 Select OPTIONS MENU.

MAIN MENU		
CATEGORY GUIDE	MASTER GUIDE 2	CATEGORY LIST 3
MOVIE GUIDE 4	EXIT 5	MOVIE LIST 6
OPTIONS MENU 7	TIMER SETUP 8	SETUP MENU 9

The Options Menu appears.

OPTIONS MENU		
AUDIO 1	PURCHASES 2	MESSAGES 3
DISPLAY OPTIONS 4	EXIT 5	LOCKS AND LIMITS 6
DATA SERVICES 7	CUSTOM STATIONS 8	

The following pages describe how to use the Options Menu to alter your system's setup.

Checking and Cancelling PPV Purchases



Use the Review/Cancel Purchases screen to see a record of recent purchases you've made through your Digital Satellite Receiver. You can also use this screen to cancel pay per view (PPV) programs you've ordered, but haven't yet watched.







Note

The Review/Cancel Purchases screen lists only purchases made using the Digital Satellite Receiver's remote control. It doesn't include purchases made by calling your program provider.

To display the Review/Cancel Purchases screen:

- 1 Select PURCHASES from the Options Menu. The Review/Cancel Purchases screen appears, which lists the programs purchased and canceled.

If there is more than one page of purchases, press the PAGE  and PAGE  buttons to page through the displays.

REVIEW/CANCEL PURCHASES			
	FIRST KNIGHT	UPCOMING	RETURN
	JOHNNY MNEMONIC	UPCOMING	REVIEW
	SPEED	CANCELLED	CANCEL PPV
	JEFFERSON IN PARIS	UPCOMING	HELP
	<NO TITLE AVAILABLE>		
	<NO TITLE AVAILABLE>		
	<NO TITLE AVAILABLE>		

- 2 To review the details of a pay per view program you've purchased:
 - Select the program you want to review. Then select REVIEW.To cancel a pay per view program you've ordered:
 - Select the program you want to cancel. Then select CANCEL PPV.
- 3 Select RETURN to return to the Options Menu.

Note

Once you tune to a purchased program, you cannot cancel its purchase.

Setting Display Options

The Set Display Options screen allows you to customize the look of the on-screen displays and to select how you want the JUMP button to function (Standard or Jump Loop).

To bring up the Set Display Options screen:

- 1 Select DISPLAY OPTIONS from the Options Menu.

The Set Display Options screen appears, with the current settings shown next to each button.

- 2 Select an option from the screen (see the following descriptions).

SET DISPLAY OPTIONS		
COLORS	EMERALD	RETURN
STATION ORDER	NUMERICAL	HELP
JUMP	STANDARD JUMP	

Setting the Colors

The COLORS option lets you change the color palette of the on-screen displays. The default color is EMERALD.

- 1 Select COLORS from the Set Display Options screen. The Set Colors screen appears.
- 2 To preview a color, move the highlight. The Set Colors screen automatically changes to reflect the color that's highlighted.

Selecting CANCEL returns you to the previous screen, without saving your selections.

SET COLORS				
EMERALD ✓	MAJESTIC	PACIFIC	RUGBY	OK
USA	REGAL	INDIGO	CANDY	CANCEL
				HELP

- 3 To change the color, select a different color and then select OK to return to the Set Display Options screen.
- 4 Select RETURN to return to the Options Menu.

Setting the Station Order

The STATION ORDER option lets you change the order in which stations are displayed in the program guides to alphabetical or numerical. The default setting is NUMERICAL.

- 1 Select STATION ORDER from the Set Display Options screen.
- 2 Select NUMERICAL or ALPHABETICAL.

ALPHABETICAL station order defines the sequence of the stations according to their call letters, such as ABC, CNN, etc. It does not define the sequence of stations by program name.

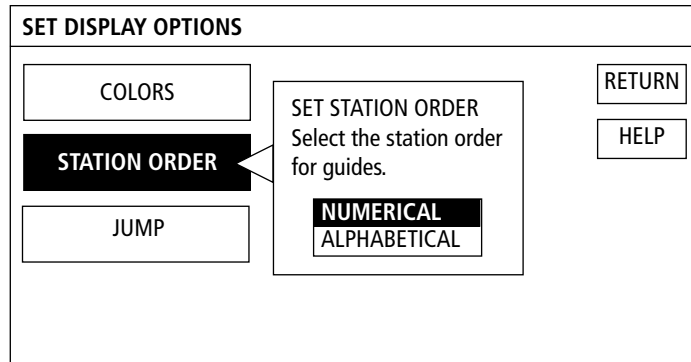

- 3 Select RETURN to return to the Options Menu.

Setting the Jump Mode

The JUMP option lets you select from two Jump modes:

- Standard Jump, which sets the JUMP button to jump back and forth between the two most recently selected stations.
- Jump Loop, which sets the JUMP button to jump among as many as 5 preset stations (see "Using the Jump Loop Feature" on page 48 for details on presetting stations).

To set the Jump Mode:

- 1 Select JUMP from the Set Display Options screen.
- 2 Select STANDARD JUMP or JUMP LOOP.

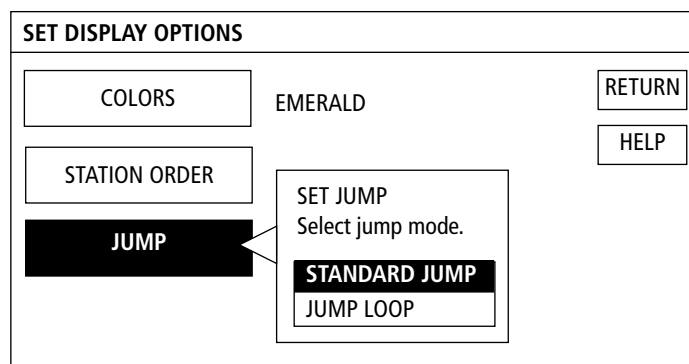

- 3 Select RETURN to return to the Options Menu.

Using the Jump Loop Feature

Standard Jump vs. Jump Loop Mode

When the Digital Satellite Receiver is set to Standard Jump mode, pressing the JUMP button toggles back and forth between the two most recently selected stations.

When the Digital Satellite Receiver is set to Jump Loop mode, pressing the JUMP button toggles among as many as 5 stations that you assign to a Jump Loop. Once you assign a station to the Jump Loop, you can use the JUMP button to quickly toggle through all the stations in the loop.

Using Jump Loops

To set jump stations:

- 1 Set the Digital Satellite Receiver to Jump Loop mode, as described on page 47. (You need to do this only the first time you create a Jump Loop.)
- 2 Tune to a station you want to assign to the Jump Loop.

Note

You cannot set jump stations while a program guide, menu, etc., is being displayed.

- 3 Press and hold the JUMP button. A message appears, indicating that the station has been assigned to the Jump Loop.
- 4 To set additional jump stations, repeat steps 2 and 3 of this procedure.

Note

If you set more than 5 jump stations, the sixth jump station automatically overwrites the first jump station in the loop, and so on.

To jump through the Jump Loop:

- Press the JUMP button repeatedly. The stations are displayed in the order they were set.

To clear a station from the Jump Loop:

- 1 Tune to the station you want to clear from the Jump Loop.

Note

You cannot clear Jump stations while a program guide, menu, etc., is being displayed.

- 2 Press and hold the JUMP button. A message appears, indicating that the station has been cleared from the Jump Loop.
- 3 To clear additional Jump stations, repeat steps 1 and 2 of this procedure.

Note

Jump Loops are cleared automatically when you shut off the Digital Satellite Receiver.

Setting Locks and Limits

The Locks and Limits feature gives you control over the use of your system. You can restrict program viewing by cost, ratings, and station. You can also set a lock to prevent the ordering of pay per view programs.

To display the Locks and Limits screen:

- 1 Select LOCKS AND LIMITS from the Options Menu.

The Set Locks and Limits screen appears, with the current settings shown next to each button.

- 2 Select a lock or limit from the screen (see the descriptions below).

If your system is locked, the padlock symbol appears (🔒), and you must first unlock it before you can make any changes to the locks and limits settings. See "Unlocking Your System" on page 53 for details.

SET LOCKS AND LIMITS		
SPENDING LIMIT	\$10.00	RETURN
RATINGS LIMIT	R	LOCK
PAY PER VIEW	UNLOCKED	HELP
STATION LOCKS	0 STATIONS CURRENTLY LOCKED	

Note

Your Digital Satellite Receiver is shipped to you unlocked, with the default settings as described below.

Spending Limit	Lets you set a maximum spending limit for a single pay per view program. When the system is locked, you cannot purchase a program that costs more than the amount set. The default setting is \$10.00.
Ratings Limit	Allows you to set a maximum ratings limit. When the system is locked, you cannot view programs rated higher than the rating set. The default rating is R.
Pay Per View	Allows you to prevent PPV purchases. When the system and the PPV option are locked, pay per view programs cannot be purchased. The default setting is <i>unlocked</i> .
Station Locks	Lets you prevent the viewing of stations that you lock. When the system is locked, programs that appear on locked stations cannot be viewed. The default is <i>no stations locked</i> .

Note

After you've set a lock or limit, you must lock the system before any locks or limits take effect. Locking the system is described on page 52.

Setting a Spending Limit

To set a spending limit:

- 1 Select SPENDING LIMIT from the Set Locks and Limits screen.
- 2 Enter a spending limit, using the 0-9 buttons to enter the dollar value. Then press the \leftarrow button.

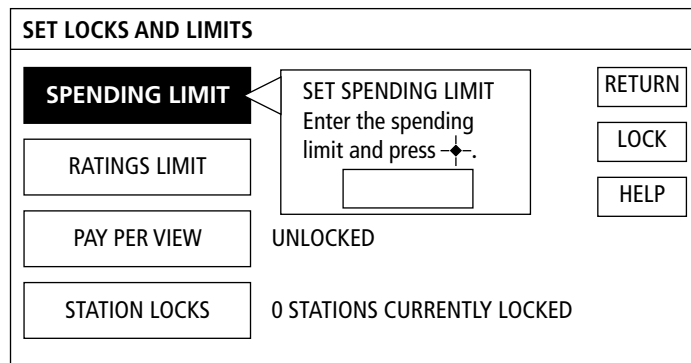

- 3 Select another lock or limit to set, or go to step 4.
- 4 Lock your system, as described in "Locking Your System" on page 52.

Setting a Ratings Limit

To set a ratings limit:

- 1 Select RATINGS LIMIT from the Set Locks and Limits screen.
- 2 Select a rating, beyond which programs cannot be watched.

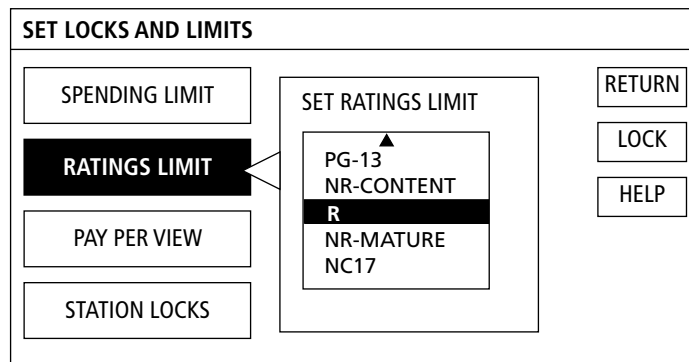

- 3 Select another lock or limit to set, or go to step 4.
- 4 Lock your system, as described in "Locking Your System" on page 52.

Setting the Pay Per View Lock

To set the pay per view lock:

- 1 Select PAY PER VIEW from the Set Locks and Limits screen.
- 2 Select LOCKED to prevent PPV program purchases. Select UNLOCKED to allow PPV program purchases.

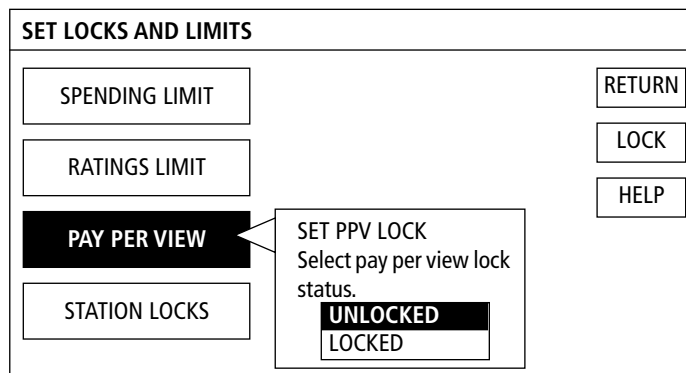

- 3 Select another lock or limit to set, or go to step 4.
- 4 Lock your system, as described in "Locking Your System" on page 52.

Note

You can also set a PPV lock by setting the spending limit to \$0.00. See "Setting a Spending Limit" on page 50 for details.

Setting Station Locks

To set station locks:

- 1 Select STATION LOCKS from the Set Locks and Limits screen.
- 2 Select stations that you want to lock from viewing. A locked station appears with a key (🔑) beside it. For example, in the following screen, stations 203, 204, 206, and 209 have been locked.

To unlock a station, just select it again. The key (🔑) disappears.

To quickly unlock or lock all stations, select ALL (to lock all) or NONE (to unlock all). Selecting CANCEL returns you to the previous screen, without saving your selections.

You can use the PAGE↑ and PAGE↓ buttons to quickly move through the rows of stations. You can also use the 0-9 buttons to enter the station number directly.

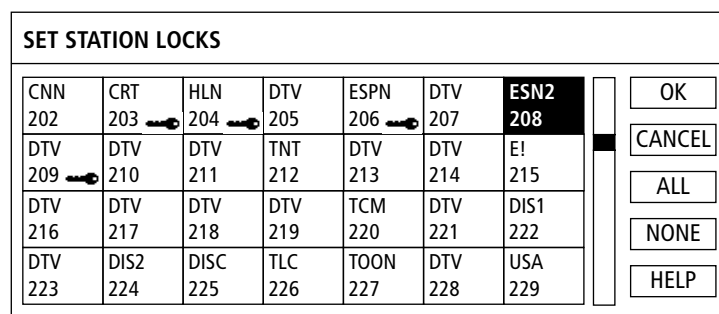

- 3 Select OK to return to the Set Locks and Limits screen.
- 4 Select another lock or limit to set, or go to step 5.
- 5 Lock your system, as described in "Locking Your System" on page 52.

Locking Your System

DON'T FORGET YOUR PASSCODE. You'll need this number to unlock your system or to make any changes to the locks and limits you've set. If you do forget your passcode, call your program provider for assistance.

To lock an unlocked system:

- 1 Select LOCK from the Set Locks and Limits screen.
- 2 Enter a four-digit passcode number. Use the 0-9 buttons to enter the numerical value.

SET LOCKS AND LIMITS

SPENDING LIMIT		LOCK SYSTEM Enter Your Four Digit Passcode	RETURN
RATINGS LIMIT	R	<input type="text"/>	LOCK
PAY PER VIEW	UNLOCKED		HELP
STATION LOCKS	4 STATIONS LOCKED		

Each number you enter appears as an asterisk (*), which keeps your passcode secret.

- 3 When prompted, enter your passcode again. (This confirms your selection of a passcode number.)

Your system is now locked, as indicated by the closed padlock (🔒) in the Set Locks and Limits screen. All locks and limits you've set are now in effect. The padlock also appears in the Program Banner to remind you of the locked status.

Overriding the System Lock

You can temporarily override any locks or limits that have been set if you know the system passcode.

For example, if you try to watch a program on a locked station, a message identifies the lock or limit exceeded. After you press the ✦ button, the Temporary Unlock window appears. By entering the passcode and then selecting when you want the system to automatically relock, you can temporarily unlock the system.

Note

If you override the system lock, you can reset the lock by turning the power off and then on again. If you want to unlock the system on a more permanent basis, follow the procedures under "Unlocking Your System" on page 53.

Unlocking Your System

To unlock a locked system:

- 1 Select LOCKS AND LIMITS from the Options Menu.
The Set Locks and Limits screen appears, with the current settings shown next to each button. The padlock (🔒) indicates that the system is currently locked.
- 2 Select UNLOCK.
- 3 Enter the passcode number you used to lock the system. Use the 0-9 buttons to enter the numerical value.

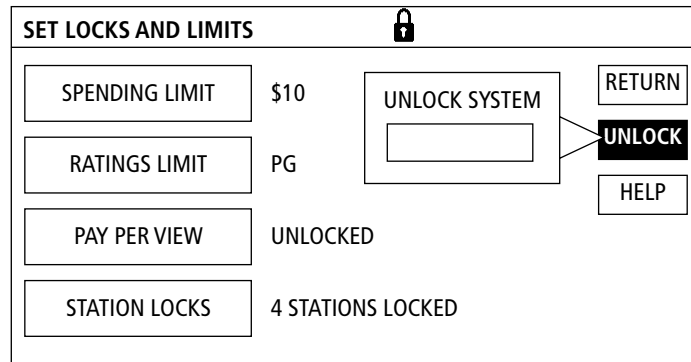

Each number you enter appears as an asterisk (*), which keeps your passcode secret.

Your system is now unlocked, and all locks and limits previously set are no longer in effect.

Determining the Status of the System Lock

While you're watching programs, you can check the status of the system lock by pressing the DISPLAY button to bring up the Program Banner, which includes the following lock symbols.

Symbol	System Lock Status
No padlock	Unlocked (default setting)
🔒	Locked
🔓	Temporarily unlocked using the system lock override

Setting Up a List of Custom Stations

If there are stations listed in the Master Guide that you don't subscribe to or watch often, you can use the Custom Stations feature to specify which stations from the Master Guide you want to skip. After you've set skipped stations, they will not appear in the:

- Custom Guide
- Station Index
- Stations that appear when you're using the CH+/CH- buttons to change channels

Note

Skipped stations will continue to be listed in the Master Guide, which you can always access through the Main Menu.

To define a list of custom stations:

- 1 Select CUSTOM STATIONS from the Options Menu.
- 2 Select stations that you want to skip.

A station that appears with a checkmark (✓) beside it will be skipped. For example, in the following screen, stations 203, 208, and 213 are set to be skipped.

To set a station so that it is not skipped, just select it again. The checkmark (✓) disappears.

To quickly skip or "unskip" stations, select ALL (to skip all) or NONE (to skip none).

Selecting CANCEL returns you to the previous screen, without saving your selections.

SET CUSTOM STATIONS								
CNN 202	CRT 203 ✓	HLN 204	DTV 205	ESPN 206	DTV 207	ESN2 208 ✓	OK	
DTV 209	DTV 210	DTV 211	TNT 212	DTV 213 ✓	DTV 214	E! 215	CANCEL	
DTV 216	DTV 217	DTV 218	DTV 219	TCM 220	DTV 221	DIS1 222	AUTO	
DTV 223	DIS2 224	DISC 225	TLC 226	TOON 227	DTV 228	USA 229	ALL	
							NONE	
							HELP	

Note

Use the PAGE↑ and PAGE↓ buttons to quickly move through the rows of stations. You can also use the 0-9 buttons to enter the three-digit station number directly.

- 3 Select OK when you're finished setting skipped stations.

To see the results of your Custom Stations settings:

- Bring up Custom Guide, by pressing the GUIDE button, the Station Index (see page 33), or use the CH+/CH- buttons.

Using the AUTO Skip Feature

When you select the AUTO button, the Digital Satellite Receiver automatically scans all the stations in the current Master Guide. During this scanning process, the Digital Satellite Receiver determines which stations you are not authorized to watch and then sets these stations to be skipped. You can use this feature as a starting point to creating your own list of custom stations.

For example, if there are stations to which you do not subscribe that appear in the Master Guide, the AUTO function automatically marks these stations to be skipped. This saves you the trouble of having to determine which of the 150+ stations in the Master Guide you cannot view and then having to manually set each of these stations to be skipped.

Note

The AUTO function does not skip pay per view stations.

To use the AUTO Skip feature:

- 1 Select CUSTOM STATIONS from the Options Menu.
- 2 Select the AUTO button.

The Digital Satellite Receiver begins to evaluate all the stations in the Master Guide, and displays a status bar, similar to the following.

Selecting STOP interrupts the Auto Skip process and returns you to the previous screen, which displays the stations that have been set to be skipped thus far.

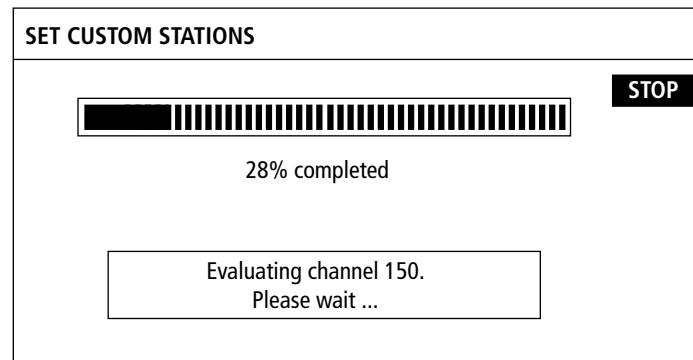

Note

This process may take a few minutes to complete.

When the Digital Satellite Receiver is finished scanning, the station list reappears, with checkmarks (✓) beside stations that are set to be skipped.

- 3 Select OK to save your selections. Or select additional stations to be skipped or unskipped.

Note

You may want to re-run the Auto skip procedure periodically in case your program providers make changes or additions to their station lineups, or if you order new program subscriptions.

Setting Audio Options

Your program providers may broadcast multiple audio tracks with a single video source. For example, a football game might use a different audio track for each sports commentator or a movie might include Dolby Digital sound as well as both English and Spanish language audio tracks.

How to Determine which Audio Tracks Are Available for a Program

To determine which audio track is available:

- 1 Tune to the program.
- 2 Press the DISPLAY button to bring up the Program Banner.

If the Program Banner includes the audio symbol (🔊), this indicates that multiple audio tracks are available for that program.

If the Program Banner includes the Double-D symbol (DD), this indicates that Dolby Digital sound is available for that program

Selecting an Audio Track

Using the on-screen menus:

- 1 Press the MENU button to bring up the Main Menu.
- 2 Select OPTIONS MENU.
- 3 Select AUDIO.

OPTIONS MENU		
AUDIO 1	PURCHASES 2	MESSAGES 3
DISPLAY OPTIONS 4	EXIT 5	LOCKS AND LIMITS 6
DATA SERVICES 7	CUSTOM STATIONS 8	

The Set Audio screen appears, which lists only the audio tracks available for the program you are currently tuned to.

SET AUDIO			
ENGLISH 1	SPANISH 1	DOLBY DIGITAL ENGLISH	RETURN
	✓		DEFAULT
			DOLBY DIGITAL
			HELP

* For SAT-B3 model, Dolby Digital does not appear.

- 4 To change the audio track for the current program, select an audio track.
To change the default language for all programs, select DEFAULT. Then see "Setting a Default Language" below.
To change the default Dolby Digital setting, select DOLBY DIGITAL. Then see "Setting Dolby Digital" on page 58.
- 5 To save your changes and return to the Options Menu, select OK. Then select EXIT from the Options Menu to return to the program you were watching.

Setting a Default Language

Use the DEFAULT button to specify the language you want to hear for programs broadcast in multiple languages.

To set a default language:

- 1 Select DEFAULT from the Set Audio screen.
- 2 Select a default language.

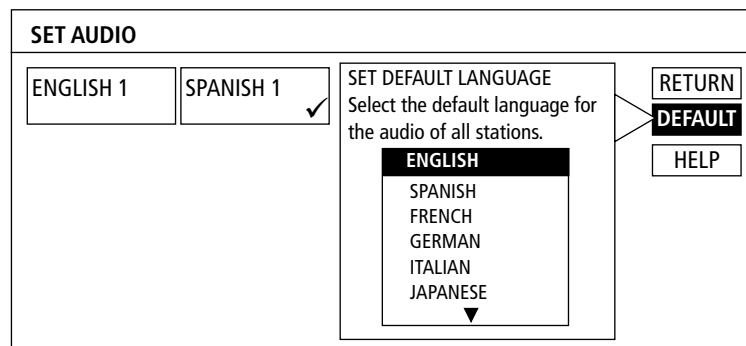

- 3 Select RETURN to return to the Options Menu.

Note

If the default language you select is not available for a program that you tune to, you will not hear the default language. Instead, you'll hear one of the languages available for that program (usually English). For example, if you set the default language to Spanish and a program is broadcast in English only, you'll automatically hear the audio in English.

Setting Dolby Digital (SAT-A4 only)

Use the DOLBY DIGITAL button to select the default setting for receiving Dolby Digital sound. This setting determines the output from the DIGITAL OUT terminal only. The AUDIO out jacks do not output Dolby Digital signals.

Note

To enjoy Dolby Digital sound, you must connect your Digital Satellite Receiver to a Dolby Digital decoder or Dolby Digital A/V receiver.

To set Dolby Digital:

- 1 Select DOLBY DIGITAL from the Set Audio screen.
- 2 Select the Dolby Digital option you want.

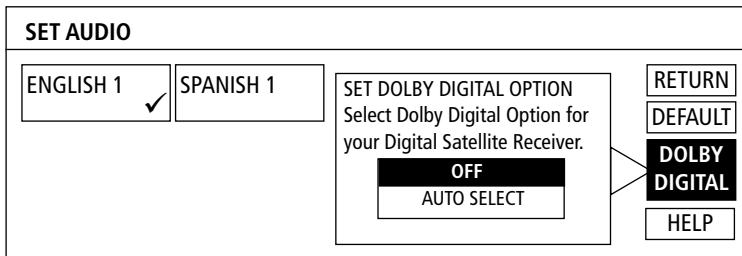

Select "OFF" if you do not have a Dolby Digital decoder or Dolby Digital A/V receiver.

Select "AUTO SELECT" to allow Dolby Digital signals to be output to your Dolby Digital decoder or Dolby Digital receiver when those signals are available.

Reading Your Messages

Occasionally, your program providers will send messages to your Digital Satellite Receiver. These messages contain useful information about your system, such as information about new services, program promotions, or billing.

How to Determine When You've Received Mail

There are several ways to tell if you have unread mail:

- The Digital Satellite Receiver front panel MESSAGE indicator lights up.
- An envelope (✉) appears in the Program Banner, accessed by pressing the DISPLAY button.
- An envelope (✉) appears in menu item 7 (Options Menu) of the Main Menu.

Displaying Your Messages

To display your messages:

- 1 Press the MENU button to bring up the Main Menu.
- 2 Select OPTIONS MENU.
- 3 Select MESSAGES.

OPTIONS MENU		
AUDIO 1	PURCHASES 2	MESSAGES 3 
DISPLAY OPTIONS 4	EXIT 5	LOCKS AND LIMITS 6
DATA SERVICES 7	CUSTOM STATIONS 8	

The date of the message, along with the first few words of the message, appear.

Reading a Message

To read a message:

- 1 Select the envelope from the Messages screen. A selected message appears with a checkmark (✓) beside it. Then select READ.



The full text of the message appears.

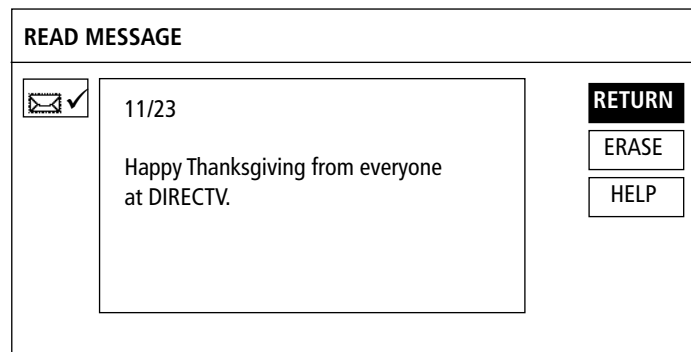

- 2 To erase a message after you've read it, select ERASE. To keep a message after you've read it, select RETURN.

Note

Your mailbox can hold about 50 messages before exhausting the Digital Satellite Receiver's memory.

Selecting Data Services

In the future, your program providers may provide data services, which you can access through specific stations using the Digital Satellite Receiver's low-speed data port. For details about using a data port to access these data services, call your program providers.

How to Determine if Data Services Are Available on a Station

To determine if data services are available on a specific station:

- 1 Tune to the station.
- 2 Press the DISPLAY button to bring up the Program Banner.

If the Program Banner includes the data services symbol (D), this indicates that data services are available for that specific station.

Selecting a Data Service

DATA SERVICES appears only when the station you've tuned to includes data services.

To select a data service:

- 1 Select DATA SERVICES from the Options Menu.

OPTIONS MENU		
AUDIO 1	PURCHASES 2	MESSAGES 3
DISPLAY OPTIONS 4	EXIT 5	LOCKS AND LIMITS 6
DATA SERVICES 7	CUSTOM STATIONS 8	

- 2 The Data Services screen appears, which lists only the data services that are available for the station you are currently tuned to.

Selecting CANCEL returns you to the previous screen, without saving your selections.

The titles of the data services may be different, based on the service being provided.

LOW SPEED DATA				
DATA 1 ✓	DATA 2	DATA 3	DATA 4	RETURN
				DEFAULT
DATA 5	DATA 6	DATA 7	DATA 8	BAUD
				HELP

3 Select one of the following:

To Do This ...	Do This ...
Change the data service for the current station only	Select the data service and then select RETURN.
Change the data service for all stations	Select DEFAULT (then see "Changing the Default Data Service" below).
Change the baud rate for the Digital Satellite Receiver's wide band data port	Select BAUD (then see "Setting the Baud Rate" below).

Changing the Default Data Service

Use the DEFAULT button to select a default data service for all stations that provide data services.

To change the data service for all stations:

- 1 Select DEFAULT from the Data Services screen.
- 2 Select a default data service.

The titles of the data services may be different, based on the service being provided.

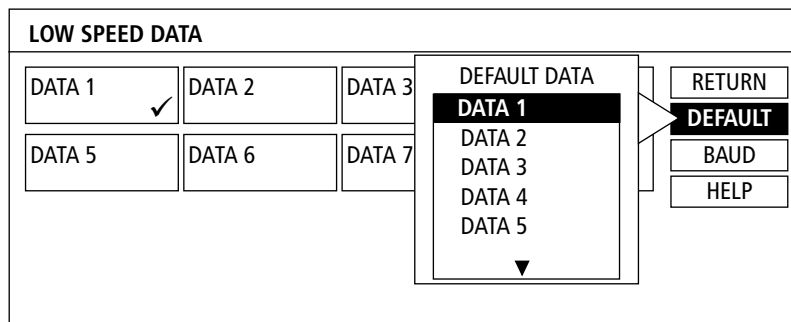

Setting the Baud Rate

To set the baud rate for the Digital Satellite Receiver's data port:

- 1 Select BAUD from the Data Services screen.
- 2 Select a baud rate for the data port.

The baud rates displayed may be different, depending on which data port is being used.

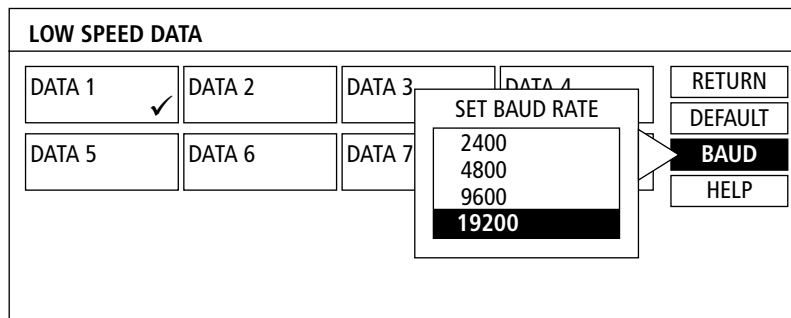

Using the Setup Menu

Read this chapter to set up your Digital Satellite Receiver for the first time, check the antenna's signal strength, or to run a system test to diagnose any difficulties you may be having with your system.

Overview

The Setup Menu includes several options you can use to set up and troubleshoot your system.

Use the Setup Menu to:

- Set up and point your Satellite Antenna (page 65).
- Set up your VCR Recording feature (page 66).
- Replace your access card (page 68).
- Change the aspect ratio of the Digital Satellite Receiver to match your TV screen: standard or widescreen (page 70).
- SAT-A4 Only*: Change the Digital Satellite Receiver to receive RF (radio frequency) remote control signals or IR (infrared) remote control signals (page 71).
- Display a list of programmable codes for other components you may want to operate using the remote control (page 74).
- Run a system test to check the operation of your system, including the access card, phone line, satellite signal, and tuning (page 75).
- Display helpful troubleshooting information (page 76).
- Get hints and shortcuts on using your DirecTV System (page 76).

Displaying the Setup Menu

To set up your system, first bring up the Setup Menu, as follows:

- 1 Press the MENU button to bring up the Main Menu.
- 2 Select SETUP MENU.

MAIN MENU		
CATEGORY GUIDE 1	MASTER GUIDE 2	CATEGORY LIST 3
MOVIES GUIDE 4	EXIT 5	MOVIES LIST 6
OPTIONS MENU 7	TIMER SETUP 8	SETUP MENU 9

- 3 The Setup Menu appears:

SETUP MENU		
REMOTE CONTROL 1	ACCESS CARD 2	VCR RECORDING 3
ANTENNA 4	EXIT 5	ASPECT RATIO 6
TROUBLE SHOOTING 7	SYSTEM TEST 8	TIPS AND SHORTCUTS 9

The following pages describe how to use the Setup Menu to set up your system.

Setting Up the Satellite Dish Antenna

To install the Satellite Antenna, or to check the current signal level of the antenna, use the Set Up Antenna screen.

Note

Make certain that the signal strength of the Satellite Antenna is optimized. If the signal is not optimized, you may experience losses in audio or video, especially during rain, snow, or other conditions that tend to degrade signal performance. See the Satellite Dish Antenna Operating Instructions for details on using the Set Up Antenna screen to point the Satellite Antenna and optimize the Satellite Antenna's signal strength.

- 1 Select ANTENNA from the Setup Menu.
- 2 The Set Up Antenna screen appears.

Selecting RETURN returns you to the Setup Menu.

The screenshot shows the 'SET UP ANTENNA' screen. At the top left is a satellite icon. Below it are two input fields: 'ZIP CODE' and 'LAT/LONG'. To the right is a 'Transponder' field with the value '2'. Further right are two buttons: 'RETURN' and 'HELP'. Below these fields is a 'Signal Strength Meter' with a 'LOCKED' label. The meter shows a 'CURRENT LEVEL' of 80 and a 'PEAK LEVEL' of 85. The meter's bar is partially filled, indicating the current signal strength.

To determine the elevation and azimuth settings for the Satellite Antenna, select ZIP CODE or LAT/LONG.

- ZIP CODE** uses your five-digit zip code to determine the elevation and azimuth settings.
- LAT/LONG** uses your location's latitude and longitude to determine the azimuth and elevation settings.
- The **Signal Strength Meter** indicates the current signal strength of the Satellite Antenna.
- The **Transponder** option allows you to select a transponder number from 1 to 32. You should not need to change this number (the default is 2) unless you're instructed to do so by your program provider.

See the Satellite Dish Antenna Operating Instructions for details on using the Set Up Antenna screen to point the Satellite Antenna and optimize the Satellite Antenna's signal strength.

- 3 Select RETURN to return to the Setup Menu.

VCR Recording

After hooking up your IR Blaster (see “Connecting the IR Blaster” on page 18 for details), you must identify and set the manufacturer and code type of your VCR. After doing this, you should perform an IR test to ensure that all of your VCR functions are working properly.

- 1 Select VCR RECORDING from the Setup Menu.

VCR RECORDING

Manufacturer	Sony	OK
Code	3	CANCEL
Test		HELP

- 2 When the VCR RECORDING test screen appears, select MANUFACTURER, and select the manufacturer name for your VCR.

VCR RECORDING

Manufacturer	3	VCR MANUFACTURERS Select your VCR's Manufacturer Sony Admiral Aiwa Audio Dynamic Bell & Howell	OK
Code			CANCEL
Test			HELP

- 3 After selecting the manufacturer, select the CODE type of your VCR.

Note:

You will need to reenter the Manufacturer and Code each time you enter the VCR RECORDING screen.

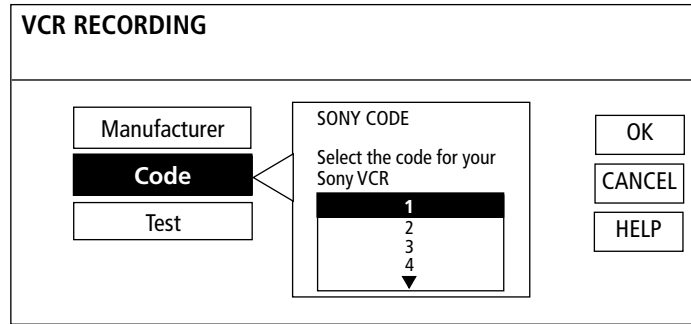

- 4 Select TEST to determine if the POWER ON/OFF, RECORD and STOP functions of your VCR are working properly.

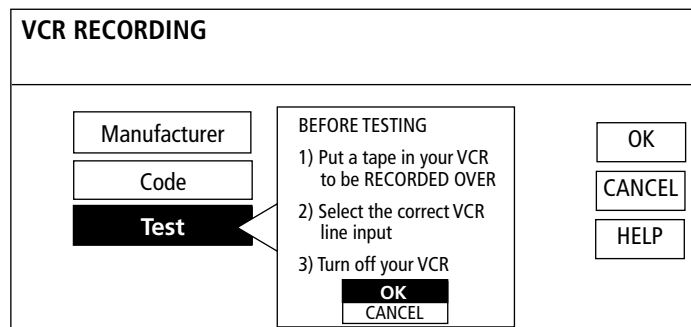

- 5 If the test is successful, select OK to return to the Setup Menu. If the test fails, check the connection between the IR Blaster and your Digital Satellite Receiver, make sure the correct video input is selected, and/or try a different code.

Replacing Your Access Card

In the event that your program providers need to send you a new access card, use the Access Card option to initialize your new card. During this process, you'll follow the on-screen instructions to copy information from the old card onto the new card. After you initialize the new card, your old card becomes invalid.

To replace your access card:

- 1 Select ACCESS CARD from the Setup Menu.

SETUP MENU		
REMOTE CONTROL 1	ACCESS CARD 2	VCR RECORDING 3
ANTENNA 4	EXIT 5	ASPECT RATIO 6
TROUBLE SHOOTING 7	SYSTEM TEST 8	TIPS AND SHORTCUTS 9

- 2 When the Replace Access Card screen appears, insert your old access card, if you removed it, as follows:
 - Slide the access card, arrow side up, into the slot located in the rear of the Digital Satellite Receiver, as shown in the illustration.

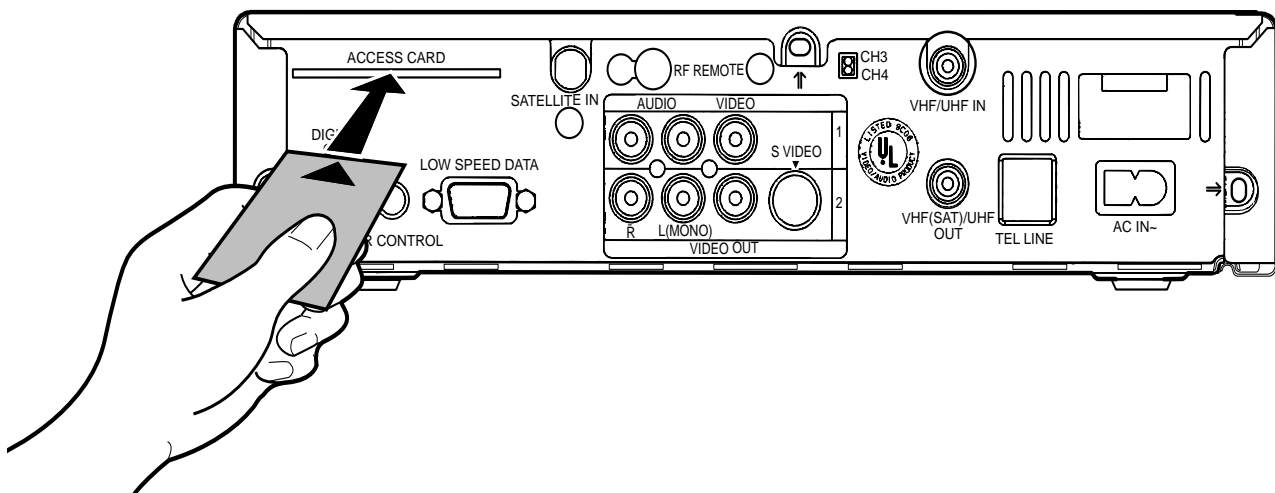

- 3 Select OK from the Replace Access Card screen.

Selecting RETURN returns you to the Setup Menu, without starting the initialization process.

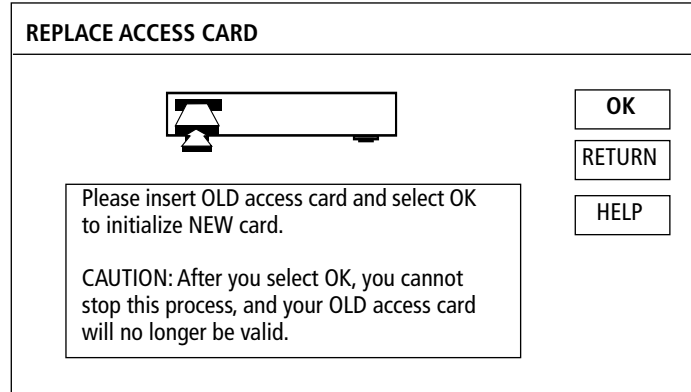

- 4 Follow the instructions as they are displayed to complete the procedure.

When the message "Replace Access Card Procedure Complete" appears, select OK to return to the Setup Menu.

Setting the Aspect Ratio

Use the Aspect Ratio option to set the Digital Satellite Receiver's display to match your TV's picture.

To set the aspect ratio:

- 1 Select ASPECT RATIO from the Setup Menu.
- 2 Select one of the options, based on the type of TV you have:
 - If you have a standard TV, select 4:3.
 - If you have a wide-screen TV, select 16:9.

Selecting CANCEL returns you to the Setup Menu, without saving your selection.

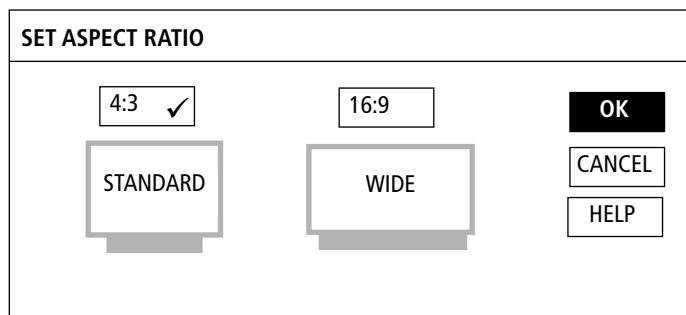

- 3 Select OK to return to the Setup Menu.

Setting Up the Remote Control (SAT-A4 Only)

The Set Up Remote screens let you set up the Digital Satellite Receiver to accept IR (infrared) or RF (radio frequency) signals from the remote control and to change the RF security code for the Digital Satellite Receiver.

You can also use this screen to display a list of codes you can use to program the remote control to operate other components, such as TVs and cable boxes.

Selecting IR/RF Transmission (SAT-A4 Only)

In addition to having IR remote control capability, your DirecTV System includes an RF feature, which enables the remote control to operate the Digital Satellite Receiver even if the receiver is located in another room or is placed behind a cabinet door. In other words, with the RF feature, the remote control does not require a direct line-of-sight to the front panel of the Digital Satellite Receiver.

Note

You must set up the RF antenna to take advantage of the RF feature. See "Setting up the RF Antenna (SAT-A4 Only)" on page 19 for details.

The Digital Satellite Receiver is shipped with IR transmission enabled and RF transmission disabled. To use the RF feature, you must change the factory setting (IR ONLY) to the RF setting (RF ONLY).

To select IR or RF transmission:

- 1 Select REMOTE CONTROL from the Setup Menu.
- 2 Select REMOTE SIGNAL and select a transmission type (IR or RF).

The screenshot shows the "SET UP REMOTE" menu. On the left, there are three options: "REMOTE CODES" (highlighted with a black background), "RF SECURITY CODE", and "REMOTE CODES". An arrow points from the "REMOTE SIGNAL" text to the "REMOTE CODES" option. In the center, there is a box titled "REMOTE SIGNAL" with the instruction "Select IR or RF transmission for the Digital Satellite Receiver." Below this box are two options: "IR ONLY" (highlighted with a black background) and "RF ONLY". On the right side of the screen, there are four buttons: "OK", "CANCEL", "IDENTIFY", and "HELP".

- 3 Select OK to save your selections and return to the Setup Menu.

Setting the Security Code (SAT-A4 Only)

If the Digital Satellite Receiver is accepting or receiving signals from another RF remote control in your home (or from a neighbor's house), you can eliminate this problem by changing the security codes for the Digital Satellite Receiver and remote control.

Note

As an alternative, you can eliminate this problem by disabling the RF capability of the Digital Satellite Receiver, if you have no need for RF transmission. See "Selecting IR/RF Transmission (SAT-A4 Only)" on page 71 for details.

There are two steps to changing the RF security code: Step 1 is changing the Digital Satellite Receiver's security code; step 2 is changing the remote control's security code. Both the Digital Satellite Receiver and the remote control must use the same three-digit security code.

Step 1: Select the Digital Satellite Receiver's RF Security Code

- 1 Select REMOTE CONTROL from the Setup Menu.
- 2 Select RF SECURITY CODE and then select a different security code.

The Digital Satellite Receiver and remote control are shipped with the RF security code set to 000.

The screenshot shows a menu titled "SET UP REMOTE". On the left, there are four menu items: "REMOTE SIGNAL", "RF SECURITY CODE" (highlighted in black), "REMOTE CODES", and "IR ONLY". On the right, there are four buttons: "OK", "CANCEL", "IDENTIFY", and "HELP". A callout box points to the "RF SECURITY CODE" menu item, containing the text "RF SECURITY CODE Select the RF security code for the Digital Satellite Receiver." Below this text is a list of options: "CODE", "CODE 001", "CODE 002", "CODE 003", and "CODE 004" (highlighted in black). A downward-pointing arrow is at the bottom of the list.

- 3 Select OK to save your changes and return to the Setup Menu.
- 4 Go to "Step 2: Set the Remote Control's RF Security Code" on page 73 to continue.

Step 2: Set the Remote Control's RF Security Code

- 1 Press the CODE SET button on the remote control.
- 2 Using the number buttons on the remote control, enter the three-digit security code you selected for the Digital Satellite Receiver in step 2 on page 72.
- 3 Press the ENTER button on the remote control.

The RF security code is now changed for both the Digital Satellite Receiver and remote control.

To Determine the Current Security Code for the Remote Control (SAT-A4 Only)

You can determine the current RF security code for the remote control using the IDENTIFY button in the Set Up Remote screen.

- 1 Bring up the Set Up Remote screen, as described on page 71.
- 2 Select IDENTIFY.

SET UP REMOTE		
REMOTE SIGNAL	IR ONLY	OK
RF SECURITY CODE	000	CANCEL
REMOTE CODES		IDENTIFY
		HELP
Press the joystick within 5 seconds.		

- 3 When the message "Press the joystick within 5 seconds" appears, press the joystick before the 5 seconds expire.

The current RF security code for the remote control appears.

SET UP REMOTE		
REMOTE SIGNAL	IR ONLY	OK
RF SECURITY CODE	000	CANCEL
REMOTE CODES		IDENTIFY
		HELP
Your remote is currently set at 000.		

Note

If the message, "Security code could not be identified" appears, check to make sure that RF is enabled and that the RF antenna is connected properly. See "Selecting IR/RF Transmission (SAT-A4 Only)" on page 71.

- 4 Select OK to return to the Setup Menu.

Displaying the Programmable Codes

You can also use the Setup Remote screen to display a list of codes you can use to program the remote control to operate other components, such as TVs and VCRs.

Note

These code numbers and instructions are also described in "Programming the Remote Control" on page 85.

To display the list of programmable codes:

- 1 Select REMOTE CONTROL from the Setup Menu.
- 2 Select REMOTE CODES and then select the type of component you want to use with the remote.

SAT-A4: The SAT-A4 remote control can be programmed to control most brands of TVs, cable boxes, VCRs, and laserdisc players (LDP).

SAT-B3: The SAT-B3 remote control cannot be programmed to control cable boxes or laserdisc players.

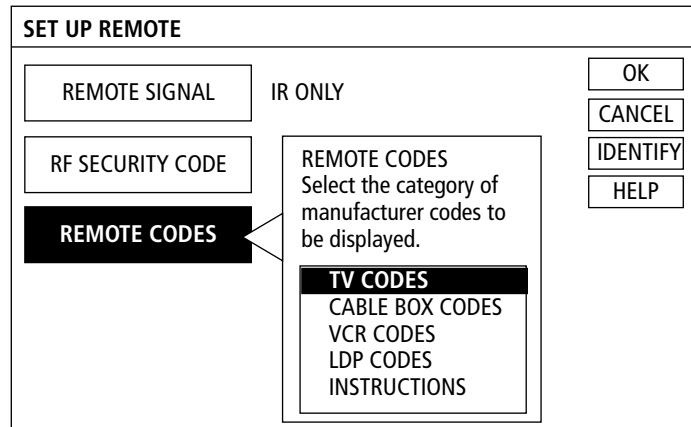

- 3 Scroll through the list that appears to find the remote codes for the manufacturer of your component. Press the \leftarrow button to return to the Set Up Remote screen.
- 4 To program the remote control, select INSTRUCTIONS and follow the on-screen instructions.
- 5 Select OK to return to the Setup Menu.

Running a System Test

The System Test lets you check the integrity of your system's components, including:

- Antenna signal
- System tuning
- Phone line
- Access card

Use the System Test if you are experiencing problems with your system.

To run the System Test:

- 1 Select SYSTEM TEST from the Setup Menu.
- 2 Select TEST.

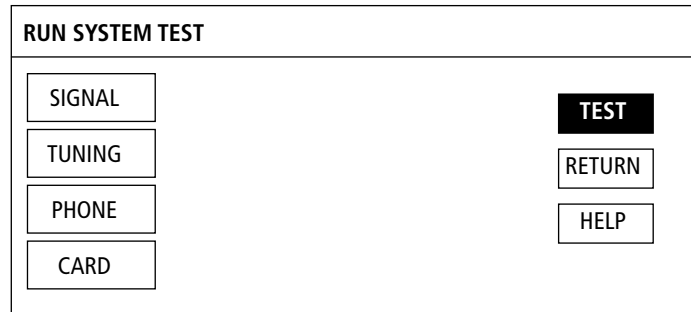

The System Test checks all the components automatically, and displays the result of each test.

- 3 Select RETURN to return to the Setup Menu.

If The System Test Reports Any Problems...

Check your system for any of the following:

- Check that all cables are connected properly to the Digital Satellite Receiver.
- Check that the Satellite Antenna is installed correctly, and that the signal has been optimized. See the manual that came with the Satellite Antenna for details.
- Check that the phone line connected to the Digital Satellite Receiver is working properly.
- Check that the access card is inserted properly.

If you cannot resolve problems reported by the System Test, see "Customer Support" on page 2.

Displaying Help, Tips, and Shortcuts

Displaying Troubleshooting Information

To display troubleshooting information:

- 1 Select TROUBLESHOOTING from the Setup Menu.

SETUP MENU		
REMOTE CONTROL 1	ACCESS CARD 2	VCR RECORDING 3
ANTENNA 4	EXIT 5	ASPECT RATIO 6
TROUBLE SHOOTING 7	SYSTEM TEST 8	TIPS AND SHORTCUTS 9

- 2 Select the topic for which you want information. Details of that topic are displayed.
- 3 Press the \leftarrow button to return to the Troubleshooting screen.
- 4 Select RETURN to return to the Setup Menu.

Displaying Tips and Shortcut Information

To display tips and shortcut information:

- 1 Select TIPS AND SHORTCUTS from the Setup Menu.

SETUP MENU		
REMOTE CONTROL 1	ACCESS CARD 2	VCR RECORDING 3
ANTENNA 4	EXIT 5	ASPECT RATIO 6
TROUBLE SHOOTING 7	SYSTEM TEST 8	TIPS AND SHORTCUTS 9

- 2 Select the topic for which you want information. Details of that topic are displayed.
- 3 Press the \leftarrow button to return to the Tips and Shortcuts screen.
- 4 Select RETURN to return to the Setup Menu.

Other Information

This appendix includes supplementary information, including:

- ❑ Locations and descriptions of the controls and indicators on the front and back panels of the Digital Satellite Receiver (page 78).
- ❑ Remote control button descriptions (page 81).
- ❑ Programming the remote to operate your TV and other video components (page 85).
- ❑ Troubleshooting information (page 87).
- ❑ Precautions (page 90).
- ❑ FCC Information (page 91).
- ❑ Limited warranty (page 92).
- ❑ Specifications (page 93).
- ❑ Index (page 94).

Location and Function of Controls

Front Panel

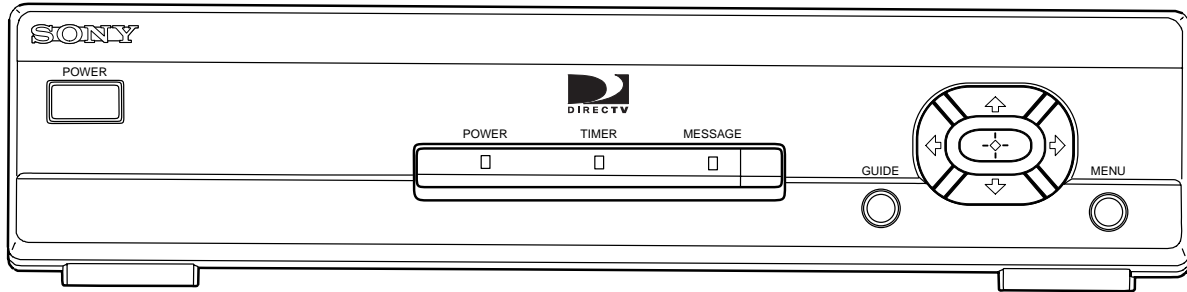

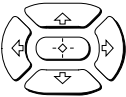
Button	Description
POWER Button	Turns the Digital Satellite Receiver on and off.
MENU Button	Brings up the Main Menu.
GUIDE Button	Brings up the Custom Guide.
	The arrow buttons highlight items in the on-screen displays (program guides, menus, etc.). The central button selects highlighted items.
Power Indicator	Indicates whether the Digital Satellite Receiver is on or off.
Timer Indicator	Indicates that the Timer is set.
Message Indicator	Indicates that you have an unread message.

Back Panel (SAT-A4)

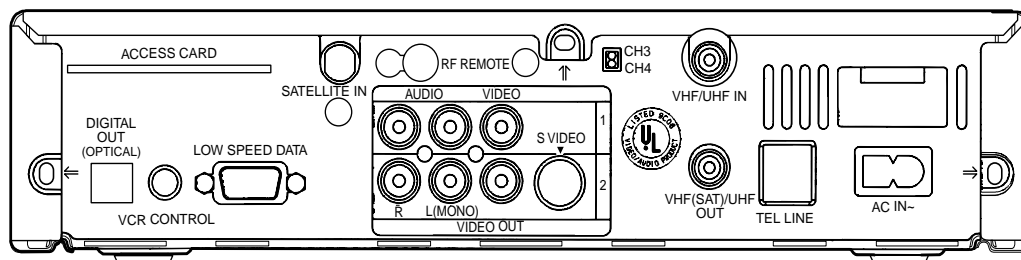

Connector	Description	Cable Type
SATELLITE IN	Connects to the LNB on the Satellite Antenna.	Solid Bare Copper RG-6 Coaxial (75-ohm/F-type)
DIGITAL OUT	Connects to the optical in jack on your Dolby Digital decoder or Dolby Digital A/V receiver.	Optical cable
LOW SPEED DATA	Allows you to connect your Digital Satellite Receiver to new technologies, as they are introduced. Additional accessories may be required.	Depends on future applications (D-sub 9 pin)
VCR CONTROL	Sends IR signal from Digital Satellite Receiver to VCR. Allows the Digital Satellite Receiver to automatically control your VCR's recording functions when you record a program.	Audio mono miniplug
RF REMOTE	Connects to the RF antenna.	RCA-type
AUDIO (R)/(L) OUT	Connects your Digital Satellite Receiver to the right and left audio inputs of your audio or video component.	Audio (2) (RCA-type)
VIDEO OUT	Connects your Digital Satellite Receiver to your TV or VCR's video input.	Video (RCA-type)
S-VIDEO OUT	Allows you to connect your Digital Satellite Receiver directly to your TV (if your TV has S-VIDEO IN).	S-Video (4-pin mini DIN)
CH3/CH4 Switch	When you use an RF connection, this setting determines the TV channel on which programs from the Digital Satellite Receiver can be viewed.	
VHF/UHF IN	Allows you to connect your Digital Satellite Receiver to your normal (terrestrial) TV or cable TV service.	RG-59 Coaxial (75-ohm/F-type)
VHF(SAT)/UHF OUT	Connects to your TV or VCR.	RG-59 Coaxial (75-ohm/F-type)
TEL LINE	Connects your Digital Satellite Receiver to a telephone jack. This allows you to order pay per view programs.	Telephone (RJ-11)
AC IN	Connects your Digital Satellite Receiver to a 120 V AC outlet.	AC

Back Panel (SAT-B3)

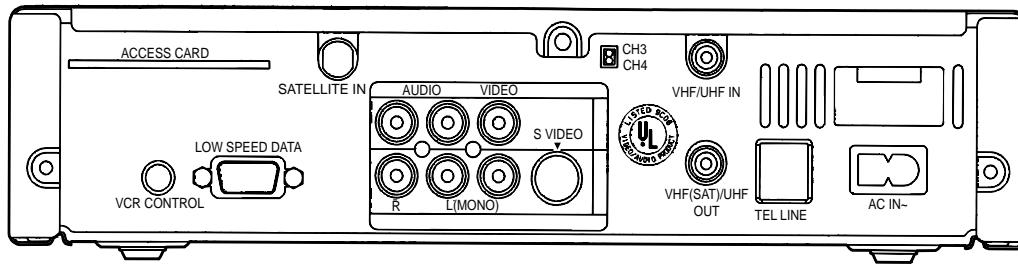

Connector	Description	Cable Type
SATELLITE IN	Connects to the LNB on the Satellite Antenna.	Solid Bare Copper RG-6 Coaxial (75-ohm/F-type)
LOW SPEED DATA	Allows you to connect your Digital Satellite Receiver to new technologies, as they are introduced. Additional accessories may be required.	Depends on future applications (D-sub 9 pin)
VCR CONTROL	Sends IR signal from Digital Satellite Receiver to VCR. Allows the Digital Satellite Receiver to automatically control your VCR's recording functions when you record a program.	Audio mono miniplug
AUDIO (R)/(L) OUT	Connects your Digital Satellite Receiver to the right and left audio inputs of your audio or video component.	Audio (2) (RCA-type)
VIDEO OUT	Connects your Digital Satellite Receiver to your TV or VCR's video input.	Video (RCA-type)
S-VIDEO OUT	Allows you to connect your Digital Satellite Receiver directly to your TV (if your TV has S-VIDEO IN).	S-Video (4-pin mini DIN)
CH3/CH4 Switch	When you use an RF connection, this setting determines the TV channel on which programs from the Digital Satellite Receiver can be viewed.	
VHF/UHF IN	Allows you to connect your Digital Satellite Receiver to your normal (terrestrial) TV or cable TV service.	RG-59 Coaxial (75-ohm/F-type)
VHF(SAT)/UHF OUT	Connects to your TV or VCR.	RG-59 Coaxial (75-ohm/F-type)
TEL LINE	Connects your Digital Satellite Receiver to a telephone jack. This allows you to order pay per view programs.	Telephone (RJ-11)
AC IN	Connects your Digital Satellite Receiver to a 120V AC outlet.	AC

Using the Remote Control

The **FUNCTION** buttons flash to indicate which component the remote control is set to operate.

After you've installed the batteries and programmed the remote control, use these procedures to operate your system components:

- 1 Select the component that you want to use: To operate a cable box, TV, or the Digital Satellite Receiver, press the corresponding **FUNCTION** button.

SAT-A4 Only: To operate a VCR or laserdisc player, open the lid on the remote control and set the slide switch to the position that you set for the component.

- 2 Aim the remote control at the component.
- 3 Press the **POWER** button of the component to turn it on and off.

To control other functions of the component, see the table that follows.

SAT-A4 Remote Control



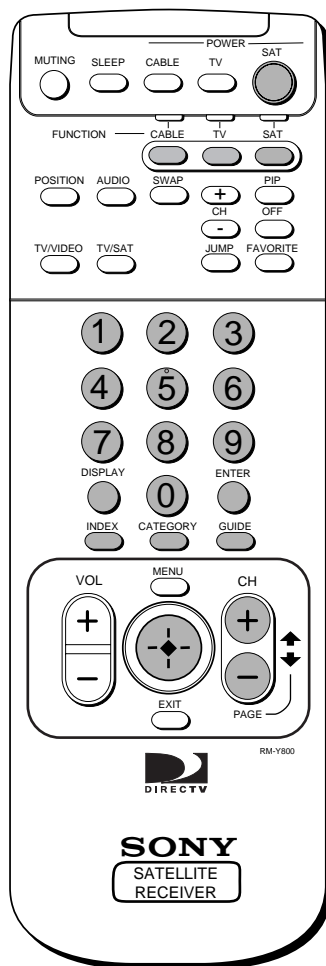









Outside Panel (SAT-A4)

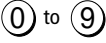

Note

Buttons described in the following table can operate components other than the Digital Satellite Receiver only if you've programmed the remote and the component supports the function described. See page 85 for instructions on programming the remote.

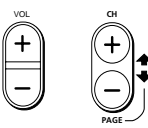
Button	Operates	Description
MUTING 	TV	Mutes the volume. Press again to restore the volume.
SLEEP 	TV	Automatically turns off the TV, after the time period that you specify.
CABLE, TV, SAT 	CABLE: Turns the cable box on and off. TV: Turns the TV on and off. SAT: Turns the Digital Satellite Receiver on and off.	
CABLE, TV, SAT 	CABLE: Puts the remote in cable mode. In cable mode, the remote operates your cable box. TV: Puts the remote in TV mode. In TV mode, the remote operates your TV. SAT: Puts the remote in SAT receiver mode. In SAT mode, the remote operates your Digital Satellite Receiver. To switch from the TV to SAT mode, press the SAT FUNCTION button, and then press the TV/SAT button.	
POSITION, AUDIO, SWAP, PIP, CH, OFF 	Only works with Sony TVs.	POSITION: Changes the PIP position. AUDIO: Swaps the audio between PIP and the main picture. SWAP: Swaps the PIP picture and the main picture. +/-: Changes the PIP channel. PIP: Turns PIP on. OFF: Turns PIP off.

Button	Operates	Description
	TV	Switches the input of the TV.
	SAT	Switches the output of the Digital Satellite Receiver to TV (normal TV programs), if you've connected a TV cable or antenna, or to SAT programs.
	SAT TV	SAT: Used to tune to and set stations in the Jump Loop (SAT). See "Using the Jump Loop Feature" on page 48 for details. TV, Cable: Tunes to the last station you were tuned to.
	SAT	Used for setting up and using the Favorite Station Guides. See "Using the Favorite Station Guides" on page 37 for details.
	SAT TV Cable box	Specifies the station number. SAT: In menus, selects the menu item with the corresponding number. Also, in some screens, used to enter numerical values (such as a spending limit or passcode).
	SAT TV	Toggles through the different displays of on-screen guides (SAT) or other display (TV). See "Using the DISPLAY Feature" on page 41 for details.
	SAT TV Cable box	Used with 0-9 buttons to change stations without any delay in tuning.
	SAT	Brings up the Index.
	SAT	Brings up the Category Guide.
	SAT	Brings up the Custom Guide. If you're already in a program guide, pressing GUIDE repeatedly brings up future time slots in the guide.
	SAT TV	When moved forward, back, left, right, and diagonally, highlights items in the on-screen displays (program guides, menus, etc.). When pressed, selects highlighted items.
	SAT TV	VOL: Increases and decreases the volume. CH/PAGE: Moves to the next (+) or previous (-) station during normal viewing. In SAT program guides and some setup screens, these buttons page through the on-screen displays.
	SAT TV	Clears all on-screen displays, including program guides, menus, etc. If you press EXIT before you complete your selections, the previous selections are restored.

Inside Panel (SAT-A4)

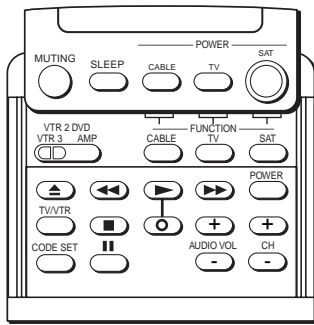

Button	Operates	Description
	VCR DVD AMP	Switches to VCR, DVD or AMP mode, depending on how you've set up the remote for these positions.
	VCR DVD	Eject
	VCR DVD	Rewind
	VCR DVD	Play
	VCR DVD	Fast-forward
	VCR DVD AMP	Turns the VCR, DVD or amp on and off.
	VCR AMP	Changes the VHF/UHF output of the VCR. Changes the input of the amp.
	VCR DVD	Stop
	VCR DVD	Pause
	VCR	Record
	VCR	Changes the channel.
	SAT	Used for programming the remote to operate your TV, cable box, VCR, DVD, or amp. Also used to change the RF security code.
	AMP	Changes the audio volume on the amp.

SAT-B3 Remote Control

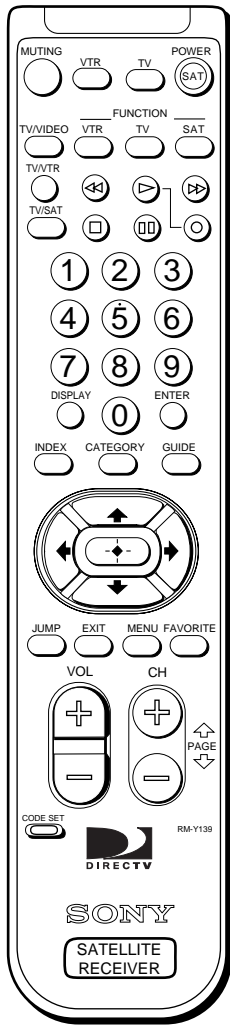

Button	Operates	Description
		VTR(VCR): Turns the VTR(VCR) on and off. TV: Turns the TV on and off. SAT: Turns the Digital Satellite Receiver on and off.
		VTR(VCR): Puts the remote in VTR mode. In VTR mode, the remote operates your VCR. TV: Puts the remote in TV mode. In TV mode, the remote operates your TV. SAT: Puts the remote in Digital Satellite Receiver mode. In SAT mode, the remote operates your digital satellite receiver.
		Used for programming the remote to operate your TV or VTR(VCR).
	SAT	Used for setting up and using the Favorite Station Guides. See "Using the Favorite Station Guides" on page 37 for details.
	TV	Switches the input of the TV.
	SAT	Switches the output of the Digital Satellite Receiver to TV (normal TV programs), if you've connected a TV cable or antenna, or to SAT programs.
	SAT TV	SAT: Used to tune to and set stations in the Jump Loop (SAT). See "Using the Jump Loop Feature" on page 48 for details. TV: Tunes to the last station you were tuned to.
	SAT TV	Specifies the station number. SAT: In menus, selects the menu item with the corresponding number. Also, in some screens, used to enter numerical values (such as a spending limit or passcode).
	SAT TV	Toggles through the different displays of on-screen guides (SAT) or other display (TV). See "Using the DISPLAY Feature" on page 41 for details.
	SAT	Brings up the Station Index.
	SAT	Brings up the Category Guide.
	SAT TV	Clears all on-screen displays, including program guides, menus, etc. If you press EXIT before you complete your selections, the previous selections are restored.
	SAT TV	Brings up the Main Menu (Sony-brand TVs only.)
	SAT	Brings up the Custom Guide. If you're already in a program guide, pressing GUIDE repeatedly brings up future time slots in the guide.
	SAT TV	When moved up, down, left, and right, highlights items in the on-screen displays (program guides, menus, etc.).
	TV SAT VCR	VOL: Increases and decreases the volume. CH/PAGE: Moves to the next (+) or previous (-) station during normal viewing. In SAT program guides and some setup screens, these buttons page through the on-screen displays.

Programming the Remote Control

The Digital Satellite Receiver's remote control is preset at the factory to operate Sony brand TVs.

If you have a TV other than Sony brand, or you have other video components that you want to control with the Digital Satellite Receiver's remote, use the following procedures to program the remote.

Note

Your components must have infrared (IR) remote control capability in order to be used with the Digital Satellite Receiver's remote.

To program the Digital Satellite Receiver's remote:

- 1** Turn to "Programmable Codes" on page 86, and find the three-digit code number for your component. If more than one code number is listed, use the number listed first to complete the following procedures.
- 2** Press the CODE SET button.
- 3** Press the FUNCTION button (VTR, SAT or TV) for the component you're setting up. *SAT-A4 Only:* To set up a VCR or laserdisc player, set the slide switch to any position (VTR3/VTR2/DVD/AMP).
- 4** Enter the three-digit code number.
- 5** Press the ENTER button.

To Check if the Code Number Works

Use the following procedure to make sure the code you've entered works:

- 1** Aim the Digital Satellite Receiver's remote control at the component and press the POWER button that corresponds to that component.
- 2** *For TVs and VCRs:* If the component responds, try the POWER, CH+ and CH- buttons. If the component responds, you're done.
- 3** If the code doesn't work for your component:
 - Try programming the remote using the other codes listed for your component.
 - If you cannot get your component to respond to the Digital Satellite Receiver's remote — even after trying all the code numbers for your component — your component may not be compatible with the Digital Satellite Receiver's remote. If this happens, you must use your component's own remote to operate it.

You can also find these code numbers using the on-screen displays. See "Displaying the Programmable Codes" on page 74.

You must perform step 3 within 10 seconds of step 2, or you must start again from step 2.

You must perform step 4 within 10 seconds of step 3, or you must start again from step 2. To cancel the operation, press the ENTER button.

Programmable Codes

TV Codes

Manufacturer	Code
Sony	101
Admiral (M. Wards)	102, 114, 109
ABC	112
Bell & Howell (M. Wards)	114, 109, 138
Broksonic	103, 112
Craig	122, 123, 120, 121
Croslex	111
Curtis Mathis	103, 119, 123
Daewoo	135, 136, 103
Daytron	113
Emerson	122, 113, 120, 121, 123, 103, 115
Fisher	125
General Electric	102, 118, 103, 107
Goldstar	103, 113, 112, 130
Hitachi	131, 113, 103, 132
JC Penney	103, 102, 130, 107
JVC	128, 129
KTV	133, 113, 103, 123, 134
LXI (Sears)	102, 103, 111, 125, 119, 112
Magnavox	111, 112, 113, 107
Mitsubishi/MGA	124, 103, 112
NEC	103, 112
Panasonic	118, 116, 117, 107
Philco	111, 118, 109
Philips	111
Pilot	103
Pioneer	137, 118, 119
Portland	103, 108
Quasar	110, 107
Radio Shack	102, 112, 124, 123
RCA/Proscan	102, 103, 104, 105, 106, 107, 108
Samsung	126, 112, 113, 103
Sanyo	125
Scott	123, 112
Sharp	114, 113, 115
Signature 2000 (M. Wards)	114, 109
Sylvania	111, 112, 108
Symphonic	123, 139
Tenika	109
Toshiba	119, 114
Videch	131, 103, 112
Wards	113, 103, 115, 112
Zenith	108, 110

Cable Box Codes (SAT-A4 Only)

Manufacturer	Code
Hamlin/Regal	222, 223, 224, 225, 228
Jerrold/G.I.	201, 202, 203, 204, 205, 206, 207, 208, 218
Oak	227, 228, 229
Panasonic	219, 220, 221
Pioneer	214, 215
Scientific Atlanta	209, 210, 211
Tocom	216, 217
Zenith	212

VCR Codes

Manufacturer	Code
Sony	300, 301, 302, 303
Aiwa	338
Audio Dynamic	314, 347
Bell & Howell (M. Wards)	330, 343
Broksonic	317, 319
Canon	309, 308
Citizen	332
Craig	315, 302, 332
Curtis Mathis	304, 338, 309
Daewoo	341, 312, 309
DBX	314, 336, 337
Dimensia	304
Emerson	319, 320, 316, 317, 318, 341
Fisher	330, 334, 335, 333
Funai	338
General Electric	329, 304, 309
Go Video	322, 339, 340
Goldstar	332
Hitachi	306, 304, 305, 338
HQ	315
Instant Replay	309, 308
JC Penney	309, 305, 304, 330, 314, 336, 337
JVC	314, 336, 337
Kenwood	314, 336, 332, 337
LXI (Sears)	332, 305, 333, 334, 330, 335, 338
Magnavox	310, 308, 309
Marantz	314, 336, 337
Marta	332
Memorex	309, 335
Minolta	305, 304
Mitsubishi/MGA	323, 324, 325, 326
Multitech	325, 338, 321
NEC	314, 336, 337
Olympic	309, 308
Optimus	327

Manufacturer	Code
Panasonic	308, 309, 306, 307
Pentax	305, 304
Philco	308, 309
Philips	310, 308, 309
Pioneer	308
Quasar	306, 308, 309
RCA/Proscan	304, 305, 308, 309, 310, 311, 312, 313
Realistic	309, 330, 328, 335, 324, 338
Sansui	314
Singer	315
Samsung	322, 313, 321
Sanyo	330, 335
Scott	312, 313, 321, 335, 323, 324, 325, 326
Sharp	327, 325, 328
Shintom	315
Signature 2000 (M. Wards)	336, 327
Sylvania	310, 308, 309, 338
Symphonic	338
Tashiro	332
Tatung	314, 336, 337
Teac	314, 336, 338, 337
Technics	309, 308
Teknika	338, 342
Toshiba	312, 311
Wards	327, 328, 335, 331, 332
Yamaha	330, 314, 336, 337
Zenith	331

DVD (Digital Video Disc) Codes (SAT-A4 Only)



Manufacturer	Code
Sony	601
Panasonic	604
Pioneer	605
RCA	602
Toshiba	603

AMP (Amplifier) Codes (SAT-A4 Only)

Manufacturer	Code
Sony	501
Denon (Sharp)	516, 517, 518
Harmon	519
JVC	506, 507, 508
Kenwood	504, 505
McIntosh	520
Onkyo	512, 513
Pioneer	502, 503
Technics	509, 510, 511
Yamaha	514, 515

Troubleshooting

Symptom	Possible Causes and Remedies
No picture (poor picture quality or loss of picture)	<ul style="list-style-type: none"><input type="checkbox"/> If you are receiving only a few stations, for example, stations 100, 205, and 999, call your program providers to have your programming activated.<input type="checkbox"/> Check to make sure the Digital Satellite Receiver is on and set to SAT mode. See page 81 or 84.<input type="checkbox"/> Check to make sure your access card is inserted properly into the Digital Satellite Receiver.<input type="checkbox"/> Run the System Test to verify that your system is working properly. See page 75.<input type="checkbox"/> Check the Satellite Antenna's signal strength. See page 65.<input type="checkbox"/> Check the connections to your TV (and other components). See the <i>Satellite Dish Antenna Operating Instructions</i> and Chapter 3 of this manual.<input type="checkbox"/> Check to make sure your TV (and other components) are set to receive the signal (channel 3 or 4, VIDEO1, etc.), as appropriate to the way your system is connected. See Chapter 3.<input type="checkbox"/> Some pay per view programs may be protected by Macrovision copy-protection at the discretion of the copyright owner. To ensure a quality picture, make sure that the signal is coming directly from the Digital Satellite Receiver and not through your VCR. Call your program providers for details.<input type="checkbox"/> Make sure the RG-6 cable is properly connected to the Satellite Antenna's LNB. If the Signal Seeker is not flashing on the LNB when the Set Up Antenna screen is displayed, there may be an electrical short in the RG-6 cable and you will need to replace it.<input type="checkbox"/> In rare cases, the picture may be distorted if you connected a terrestrial TV antenna to the UHF/VHF IN jack of the Digital Satellite Receiver. This distortion could occur if the channel selector on the back of the Digital Satellite Receiver is set to a channel that is normally received on channel 3 or 4 of your TV. For example, you can receive a local station on channel 4, and the channel selector is set to channel 4. If this happens, set the channel selector to the other channel (3 or 4), whichever one is not used on your TV.<input type="checkbox"/> Avoid placing 300-ohm wires above your Digital Satellite Receiver, i.e., off-air antenna wire, rabbit ear antenna.<input type="checkbox"/> If the cable distance between the Satellite Antenna and Digital Satellite Receiver exceeds 100 feet, you must use the Sony brand Amplifier EAC-DA1.
Cannot access program	<ul style="list-style-type: none"><input type="checkbox"/> Check to make sure that you are subscribing to the station you are trying to tune to. Call your program providers if you are not sure.<input type="checkbox"/> Check to make sure the system is not locked. See Chapter 5.<input type="checkbox"/> Check to make sure the station isn't set to be skipped. See page 54.
Cannot order pay per view program	<ul style="list-style-type: none"><input type="checkbox"/> Check to make sure you've connected the Digital Satellite Receiver to a phone line.<input type="checkbox"/> It may be too late to purchase this program. Check for other show times. See page 29.<input type="checkbox"/> If the message "Purchase information not available" appears, you must call your program provider (DIRECTV or USSB) to order the program.<input type="checkbox"/> Check to make sure the PPV option is not locked. See Chapter 5.<input type="checkbox"/> Your access card may be full. Call your program provider.

Symptom	Possible Causes and Remedies
Cannot find the station of the pay per view program you've ordered	<ul style="list-style-type: none"> <input type="checkbox"/> See "Checking and Cancelling PPV Purchases" on page 45 to get information (station, start times, etc.) about programs you've ordered.
Cannot cancel a pay per view order via the Purchase menu option	<ul style="list-style-type: none"> <input type="checkbox"/> You cannot cancel pay per view orders that you've watched or tuned to. Also, you can cancel only programs you've ordered using the remote control. Call your program providers for details.
Program guide does not bring up the program you've chosen	<ul style="list-style-type: none"> <input type="checkbox"/> You must press the  button to select the program you've highlighted. Although the guide automatically tunes to current stations that you highlight in any of the guides, you must press the  button to complete your selection.
Cannot display favorite stations	<ul style="list-style-type: none"> <input type="checkbox"/> You must set up your Favorite Station Guides before favorite stations can be displayed. See page 37. <input type="checkbox"/> If you selected a program guide using CATEGORY GUIDE or CATEGORY LIST, some of your Favorite Stations may not be displayed when you press the FAVORITE button. This is probably because the program that's on the Favorite Station is in a program category that's different from the category or subcategory you selected for the displayed guide or list.
Ratings limit, spending limit, or pay per view lock not working properly	<ul style="list-style-type: none"> <input type="checkbox"/> Check locks and limits. Then check that the system is locked. See Chapter 5.
Cannot access locks or limits screens	<ul style="list-style-type: none"> <input type="checkbox"/> The system must be unlocked before you can make changes to the locks and limits. See Chapter 5.
Cannot lock or unlock the system	<ul style="list-style-type: none"> <input type="checkbox"/> Make sure you've entered the correct passcode. If you've lost or forgotten your passcode, call your program provider. See "Customer Support" on page 2.
Audio track is not available	<ul style="list-style-type: none"> <input type="checkbox"/> Not all programs offer audio tracks. See page 56.
Language of audio track is incorrect	<ul style="list-style-type: none"> <input type="checkbox"/> Check default language setting. The program provider may not make available all the languages displayed in the Set Default Language screen. See page 57. Check the audio track setting. See page 56.
Cannot record programs on VCR	<ul style="list-style-type: none"> <input type="checkbox"/> Check to make sure the VCR is connected correctly, and that the VCR is set to receive the signal from the Digital Satellite Receiver. See Chapter 3. <input type="checkbox"/> If you are using the automatic timer to facilitate the recording of programs, make sure the program you are trying to record does not conflict with any locks or limits that have been set. If you are using the timer for PPV programs, you must purchase these programs in advance, which may require that you call your program provider to order the program. <input type="checkbox"/> Make sure you are not trying to record a pay per view program that is copy-protected by Macrovision. Some pay per view programs are copy-protected at the discretion of the copyright owner. Call your program provider for details.
One Button Recording/IR Blaster is not working	<ul style="list-style-type: none"> <input type="checkbox"/> Check to make sure the IR Blaster is connected and placed correctly. See "Connecting the IR Blaster" on page 18. <input type="checkbox"/> Check the code for your VCR. See "VCR Recording" on page 66. <input type="checkbox"/> Check to make sure the Video line input, which connect the Digital Satellite Receiver to the VCR, is correctly selected.
Main Menu, buttons 4 and 6, do not include the program categories that you want	<ul style="list-style-type: none"> <input type="checkbox"/> Use CATEGORY GUIDE to change the program category shown in button 4. Use CATEGORY LIST to change the program category shown in button 6. See page 32.

Symptom	Possible Causes and Remedies
Access card problems	<ul style="list-style-type: none"> <input type="checkbox"/> Check that the card is inserted properly. See page 68. <input type="checkbox"/> Call your program providers. See "Customer Support" on page 2.
Remote control does not work	<ul style="list-style-type: none"> <input type="checkbox"/> To operate your TV or other video components, make sure you've programmed the remote properly. See "Programming the Remote Control" on page 85. Note: The remote codes may be erased whenever you remove the batteries. Program the remote again if you've removed or replaced the batteries. <input type="checkbox"/> Press the appropriate FUNCTION button (SAT, TV, VTR(VCR)) for the component you want to operate. These buttons flash to indicate which component the remote control is set to operate. <input type="checkbox"/> Check to make sure the batteries are inserted correctly, and that the batteries are not dead. See page 6. <input type="checkbox"/> <i>SAT-A4 Only:</i> If you are having problems with the RF function, check that the RF antenna is connected properly and that you are using the remote control within operating range of the Digital Satellite Receiver (see "Setting Up the RF Antenna (SAT-A4 Only)" on page 19). Make sure that RF transmission is enabled (see "Selecting IR/RF Transmission (SAT-A4 Only)" on page 71). Make sure the Digital Satellite Receiver and remote control are using the same security code (see "Setting the Security Code (SAT-A4 Only)" on page 72). <input type="checkbox"/> Try removing the batteries and reinserting them without touching any buttons on the remote control.
Audio Noise	<ul style="list-style-type: none"> <input type="checkbox"/> If you connect the DIGITAL OUT terminal to a device that is not Dolby Digital compatible, set the Dolby Digital Option to OFF (page 58). Not all optical terminals on A/V receivers are Dolby Digital compatible.

If you are unable to resolve problems with your system, please see "Customer Support" on page 2 for customer support information and telephone numbers.

Precautions

On Safety

- ❑ If you spill or drop anything into the cabinet, unplug the Digital Satellite Receiver and have it checked by qualified personnel before operating it any further.
- ❑ Operate the Digital Satellite Receiver only on 120 V AC.
- ❑ For detailed safety precautions, see the “Important Safeguards” leaflet that came with the Digital Satellite Receiver.

On Power Sources

- ❑ The Digital Satellite Receiver continues to draw power from the AC power source as long as it is connected to the wall outlet, even if the Digital Satellite Receiver itself has been turned off.
- ❑ If you are not going to use the Digital Satellite Receiver for a long time, be sure to disconnect the Digital Satellite Receiver from the wall outlet and cancel your programming subscription. To disconnect the AC power cord, grasp the plug itself; never pull the cord.
- ❑ To further protect the Digital Satellite Receiver from damage caused by lightning or power surges, connect a power surge protector to your telephone line, AC power cord, and external antennas.
- ❑ One blade of the plug is wider than the other for the purpose of safety and will fit into the wall outlet only one way. If you are unable to insert the plug fully into the outlet, contact your dealer.
- ❑ If the AC power cord gets damaged and needs to be replaced, have it done at a qualified service shop only.

On Placement

- ❑ Place the Digital Satellite Receiver in a location with adequate ventilation to prevent heat build-up in the Digital Satellite Receiver and prolong the life of the Digital Satellite Receiver.
- ❑ Do not place the Digital Satellite Receiver in a location where it will be exposed to extreme hot or cold temperatures. Avoid direct sunlight and do not place near heat sources.
- ❑ Do not place the Digital Satellite Receiver in a location subject to excessive dust or mechanical vibration. Protect from vibration at all times.
- ❑ Do not place anything on top of the Digital Satellite Receiver, which might block the ventilation holes and cause malfunctions.
- ❑ Before connecting other components, be sure to turn off and unplug the Digital Satellite Receiver.

On Cleaning

- ❑ Clean the cabinet, panel, and controls with a soft cloth slightly moistened with a mild detergent solution. Do not use any type of abrasive pad, scouring powder, or solvent such as alcohol or benzine.

On Repacking

- ❑ Keep the original cartons and packing materials to safely transport the equipment in the future.

FCC Regulations and Information

FCC Registration Information

Your Digital Satellite Receiver has been registered by the Federal Communication Commission (FCC) as not being harmful to the telephone network when connected directly to the telephone lines. In order to fully comply with the Rules of the FCC, the following instructions should be read carefully and followed completely where applicable:

- 1 The Federal Communication Commission (FCC) has established Rules which permit this device to be directly connected to the telephone network. Standardized jacks are used for these connections. This equipment should not be used on party lines or coin phones.
- 2 If this device is malfunctioning, it may also be causing harm to the telephone network; this device should be disconnected until the source of the problem can be determined and until repair has been made. If this is not done, the telephone company may temporarily disconnect service.
- 3 The telephone company may make changes in its technical operations and procedures; if such changes affect the compatibility or use of this device, the telephone company is required to give adequate notice of the changes. You will be advised of your right to file a complaint with the FCC.
- 4 If the telephone company requests information on what equipment is connected to their lines, inform them of:
 - a The telephone number to which this unit is connected.
 - b The ringer equivalence number.
 - c The USOC jack required.
 - d The FCC Registration Number.
- 5 Items (b) and (d) are indicated on the label. The Ringer Equivalence Number (REN) is used to determine how many devices can be connected to your telephone line. In most areas, the sum of the RENs of all devices on any one line should not exceed five (5). If too many devices are attached, they may not ring properly.

Service Requirements

In the event of equipment malfunction, all repairs should be performed by our Company or an authorized agent. It is the responsibility of users requiring service to report the need for service to our company or to one of our authorized agents. For service, call 1-800-838-7669.

Declaration of Conformity

Trade Name: Sony
Model No.: SAT-A4
Responsible Party: Sony Electronics Inc.
Address: 1 Sony Drive, Park Ridge, NJ. 07656 USA
Telephone No.: 201-930-6972

This device complies with Part 15 of the FCC rules. Operation is subject to the following two conditions: (1) This device may not cause harmful interference, and (2) this device must accept any interference received, including interference that may cause undesired operation.

Radio Interference Information

This equipment has been tested and found to comply with the limits for a Class B digital device, pursuant to Part 15 of the FCC Rules. These limits are designed to provide reasonable protection against harmful interference in a residential installation. This equipment generates, uses and can radiate radio frequency energy and, if not installed and used in accordance with the instructions, may cause harmful interference to radio communications. However, there is no guarantee that interference will not occur in a particular installation. If this equipment does cause interference to radio or television reception (which you can determine by turning the equipment off and on), you are encouraged to try to correct the interference by one or more of the following measures:

- Reorient or relocate the receiving antenna (the antenna for radio or television that is receiving the interference)
- Change the position of the Digital Satellite Receiver with respect to the radio or television equipment that is receiving the interference
- Move the Digital Satellite Receiver away from the equipment that is receiving the interference
- Plug the Digital Satellite Receiver into a different outlet so that the Digital Satellite Receiver and the equipment receiving the interference are on different branch circuits

Shielded cables and I/O cords must be used for this equipment to comply with the relevant FCC regulations. Changes or modifications not expressly approved in writing by Sony Electronics, Inc., void the user's authority to operate this equipment.

If these measures do not eliminate the interference, you should consult your DIREC TV System dealer or an experienced radio/television technician for additional suggestions. In addition, you may find the following booklet prepared by the Federal Communications Commission helpful: "How to Identify and Resolve Radio-TV Interference Problems." This booklet is available from the U.S. Government Printing Office, Washington, D.C., 20402 Stock No. 004-000-00345-4.

Canadian Residents

Le present appareil numerique n'emet pas de bruits radioelectriques dépassant les limites applicables aux appareils numeriques de la class B prescrites dans le Reglement sur le brouillage radioelectrique edicte par le ministere des Communications du Canada.

Limited Warranty

DIRECTV Systems

SONY ELECTRONICS INC. ("SONY") warrants this Product (including any accessories) against defects in material or workmanship as follows:

- 1 LABOR. For a period of 90 days from the original date of purchase, if the Product is determined to be defective, SONY will repair or replace the Product at no charge. After this 90 day period, you must pay for all labor charges.
- 2 PARTS. For a period of one (1) year from the original date of purchase, SONY will supply, at no charge, new or rebuilt replacements in exchange for defective parts. Any replacements will be warranted for the remainder of the original warranty period or ninety (90) days from installation by SONY's authorized facility, whichever is longer.
- 3 ACCESSORIES. Parts and labor for all accessories are for one (1) year.
- 4 IN-HOME. For a period of one (1) year from installation date, if the unit was professionally installed by a SONY authorized DIRECTV System Installer and the LNB (Electronic Antenna Element) fails to function properly, SONY will repair or replace the LNB with a new or rebuilt part. Labor to repair or replace the LNB (after 90 days from purchase) will be at your expense. If no problem is found, or any other item fails, it will be your responsibility to pay the installer their regular rate for an in-home service call.

To obtain warranty service, you must take the Product, or deliver the Product freight prepaid, in either its original packaging or packaging affording an equal degree of protection, to a SONY authorized DIRECTV System service facility. Please see the telephone number at the end of this section for a number to call to locate the closest facility.

This warranty does not cover customer instruction, installation, setup adjustments or signal reception problems.

This warranty does not cover cosmetic damage or damage due to acts of God, accident, misuse, abuse, negligence, commercial use, or modification of, or to any part of the Product, including the antenna. This warranty does not cover improper installation (if self-installed), loss of use of the product, or wasted programming charges due to product malfunction. This warranty does not cover damage due to improper operation or maintenance, connection to improper voltage supply, or attempted repair by anyone other than a facility authorized by SONY to service the Product. This warranty does not cover Products sold AS IS or WITH ALL FAULTS. This warranty is valid only in the United States.

Proof of purchase in the form of a bill of sale or receipted invoice which is evidence that the unit is within the Warranty period must be presented to obtain warranty service.

REPAIR OR REPLACEMENT AS PROVIDED UNDER THIS WARRANTY IS THE EXCLUSIVE REMEDY OF THE CONSUMER. SONY SHALL NOT BE LIABLE FOR ANY INCIDENTAL OR CONSEQUENTIAL DAMAGES FOR BREACH OF ANY EXPRESS OR IMPLIED WARRANTY ON THIS PRODUCT. IN NO EVENT SHALL SONY BE LIABLE FOR ANY INCIDENTAL OR CONSEQUENTIAL DAMAGES WHATSOEVER ARISING OUT OF THE USE OR INABILITY TO USE THE PRODUCT. UNDER NO CIRCUMSTANCES SHALL SONY'S LIABILITY, IF ANY, EXCEED THE PURCHASE PRICE PAID FOR THE PRODUCT. EXCEPT TO THE EXTENT PROHIBITED BY APPLICABLE LAW, ANY IMPLIED WARRANTY OR MERCHANTABILITY OR FITNESS FOR A PARTICULAR PURPOSE ON THIS PRODUCT IS LIMITED IN DURATION TO THE DURATION OF THIS WARRANTY.

This warranty is invalid if the factory applied serial number has been altered or removed from the Product.

Some states do not allow the exclusion or limitation of incidental or consequential damages, or allow limitations on how long an implied warranty lasts, so the above limitations or exclusions may not apply to you. In addition, if you enter into a service contract with the SONY Partnership within 90 days of the date of sale, the limitation on how long an implied warranty lasts does not apply to you. This warranty gives you specific legal rights, and you may have other rights which vary from state to state.

For your convenience, SONY ELECTRONICS INC. has established telephone numbers for frequently asked questions. To locate the servicer or dealer nearest you, for assistance or resolution of a service problem, or for product information or operation, call:

SONY SATELLITE SYSTEM INFORMATION CENTER
1-800-838-7669 (Sony)

For an accessory or part not available from your authorized dealer, call:

1-800-488-7669

About Sony Customer Support

Every Sony brand DIRECTV System comes with Sony's Express Support at no charge to you. In the event of a system failure, our Express Support Program can have a replacement receiver on its way to you via overnight Federal Express (for calls Monday-Friday until 7:30 pm Eastern Time; Saturday delivery depends upon zip code). All it takes is a valid credit card to cover a security deposit, and Sony will pay freight in both directions. Our Express Support continues with our 800 number, staffed by dedicated technical representatives who can answer questions on dealer locations, system operation, installation, hookup, accessories, and how to get the most out of your home entertainment system. Sony's Express Support program: another expression of our commitment to excellence in customer service.

Specifications

Input Jacks	UHF/VHF 75 ohm f-type Satellite Dish Antenna 75 ohm f-type RF Remote (SAT-A4) AC Power (120 V, 60 Hz)
Output Jacks	S-VIDEO OUT 4-pin mini DIN VIDEO (RCA jacks) (2) OPTICAL OUT (1) AUDIO R/L (RCA jacks) (2) VHF(SAT)/UHF, f-type Low-Speed Data 9-pin D-Sub Female TEL LINE VCR CONTROL (1)
Input Frequency	950 - 1450 MHz
Power Requirements	AC 120 V
Power Consumption	20 W max
Dimensions (w/h/d)	280 x 66.5 x 228.5 mm 11 x 2 ⁵ / ₈ x 9 inches
Weight	Set: 2.7 kg/6.0 lbs (SAT-A4) 2.5 kg/5.4 lbs (SAT-B3) Unit: 1.6 kg/3.6 lbs (SAT-A4) 1.5 kg/3.4 lbs (SAT-B3)

Supplied Accessories	Remote Control RM-Y800 (SAT-A4) RM-Y139 (SAT-B3) Size AA Batteries (2) Access Card (1) Audio/Video Cable (1) S-VIDEO Cable (1) (SAT-A4) RF Antenna (1) (SAT-A4) RF Cable (1) Telephone Line Cord (1) AC Power Cord (1) IR Blaster (1)
Optional Sony-brand Digital Satellite System Accessories	Local TV Antenna ANJ-AA1 Installation Kit ANJ-DS2 Amplifier EAC-DA1 Diplexer EAC-DD1 Voltage Switch EAC-DV1

Note

Design and specifications are subject to change without notice.

Index

0-9 buttons **7, 8, 26, 82, 84**
16:9 aspect ratio **70**
4:3 aspect ratio **70**
⏮ (audio symbol) **40, 56**
⏭ (data services symbol) **40, 61**
⏮⏭ Dolby Digital Audio symbol **40, 56**
🔒 (lock symbol) **49, 53**
✉ (messages symbol) **59**
⬅ button **7, 8, 27, 78**

A

access card, replacing **68**
antenna
 See also RF antenna.
 setting up **65**
 signal level **65**
arrow buttons
 on front panel **78**
 on SAT-B3 remote control **8, 84**
aspect ratio, setting **70**
audio **56**
AUDIO button **56**
audio option **56**
audio screen **56**
AUTO skip feature **55**
audio track **56**
azimuth **65**

B

back panel connectors
 SAT-A4 **79**
 SAT-B3 **80**
batteries, inserting into remote control **6**
baud rate, setting **62**

C

CATEGORY button **7, 8, 82, 84**
CATEGORY GUIDE **30, 32**
CATEGORY LIST **30, 32**
CH +/- buttons **83**
CH/PAGE buttons **7, 8, 82, 84**
CODE SET button **83, 84**
colors, setting **46**
connecting
 audio system **16, 17**
 cable TV, terrestrial antenna **12, 13, 14, 16**

Hi-Fi A/V system **16**
home entertainment system **16**
IR Blaster **18**
RF antenna **19**
TV and VCR **14**
TV with A/V connectors **13**
TV with RF connector **12**
Custom Guide **54**
 See also Master Guide
customer support numbers **2, 92**

D, E

data services, setting **61**
default language, setting **57**
Digital Out terminal **16, 58, 79**
DISPLAY button **29, 34, 40, 59, 82, 84**
Dolby Digital **11, 56, 57, 79**
Dolby Digital button **56, 57**
Eject button **83**
elevation **65**
ENTER button **7, 8, 82**
EXIT button **9, 10, 29, 34, 82, 84**
Express Navigator **4**

F

Fast-forward button **83**
FAVORITE button **34, 37, 82, 84**
Favorite Station Guide
 changing the title **39**
 clearing a station **39**
 displaying and setting up **37**
 displaying different Favorite Station Guides **39**
 exiting **39**
 using DISPLAY button with **41**
features, described **4**
front panel controls **78**
FUNCTION buttons **81, 84**

G

GUIDE button **7, 8, 9, 30, 82, 84**
guides
 selecting a guide category **31**
 selecting a guide subcategory **32**
 selecting a guide time **31**
 selecting a guide type **30**

H, I, J

Highlight and Select, explained **23**
INDEX button **7, 8, 82, 84**
IR Blaster **18, 66**
joystick **7, 82**
Jump
 button **82, 84**
 Loop **48**

L

languages. See default language and audio.
latitude and longitude, for setting antenna **65**
locking the system **51, 52**
locks and limits
 overriding **52**
 setting **49-52**
 unlocking **53**
 with timer settings **36**

M

Macrovision copy-protection **28**
mail. See messages.
Main Menu **24**
Master Guide **24**
 adding programs to the Timer **28**
 displaying favorite stations in **27**
 exiting **27, 29**
 selecting programs in **28**
 using DISPLAY button with **41**
MENU button **24, 78, 84**
messages
 erasing **60**
 indicator **78**
 reading **60**
 receiving **59**
MUTING button **81**

O

One Button Recording **27, 35**
Options Menu, displaying **44**
overriding the system lock **52**

P

- paging **26, 29**
- passcode, setting **52, 53**
- Pause button **83**
- pay per view
 - cancelling programs **45**
 - free preview **28**
 - locking **49**
 - reviewing purchases **45**
 - watching programs **28**
- PIP **81**
- Play button **83**
- POWER buttons **7, 8, 78, 81, 83, 84**
- power indicator **78**
- precautions **90**
- problems
 - diagnosing **75**
 - troubleshooting **87**
- Program Banner **40**
- purchases. See pay per view.

R

- ratings limit
 - explained **49**
 - setting **50**
- Record button **83**
- recording SAT programs **20**
 - with IR Blaster **18**
 - with Timer **35**
- remote control
 - inserting batteries **6**
 - programmable codes **86**
 - programming **85**
 - RF security code **72**
 - SAT-A4 button descriptions **81**
 - SAT-B3 button descriptions **84**
 - setting IR and RF **71**
 - troubleshooting **89**
- Rewind button **83**
- RF antenna **19**

S

- satellite antenna, setting **65**
- scrolling **8, 26**
- SELECT  button **7, 8, 23, 78, 82, 84**
- Setup Menu, displaying **64**
- SLEEP button **81**
- spending limit
 - explained **49**
 - setting **50**
- Station Index
 - displaying **7, 8, 10, 33**

- displaying favorite stations in **34**
- exiting **34**
- selecting programs in **10, 34**
 - using DISPLAY button with **41**
- station locks
 - setting **51**
- station order, setting **47**
- Stop button **83**
- S-VIDEO jack **11, 13, 14, 16**
- system test, running **75**

T

- timer
 - checking and changing **36**
 - indicator **36, 78**
 - setting up **35**
- tips and shortcuts **76**
- transponder **65**
- TV/SAT button **82, 84**
- TV/VIDEO button **82, 84**
- TV/VTR button **83**

U, V

- unlocking the system **53**
- VCR Recording **66**
- VOL button **84**
- VTR3/VTR2/DVD/AMP switch **83**

W, Z

- Warranty **92**
- zip code, for setting antenna **65**

Printed in the U.S.A.

Free Manuals Download Website

<http://myh66.com>

<http://usermanuals.us>

<http://www.somanuals.com>

<http://www.4manuals.cc>

<http://www.manual-lib.com>

<http://www.404manual.com>

<http://www.luxmanual.com>

<http://aubethermostatmanual.com>

Golf course search by state

<http://golfingnear.com>

Email search by domain

<http://emailbydomain.com>

Auto manuals search

<http://auto.somanuals.com>

TV manuals search

<http://tv.somanuals.com>