

HDC-1000 Series

World-class HD Camera System

SONY

www.sonybiz.net/anycast



Sony HDC-1000 Series

A Family of HD Production Tools



HDC-1500



HDC-1000

The Sony HDC-1000 system camera family is based on more than 20 years of development of HD TV systems and has been the first choice for literally hundreds of broadcasters for both studio and OB applications. Many thousands of HDC-1000 systems have been sold around the world since the introduction in 2005 and the family has continued to improve and grow since then. Recent additions include the acclaimed HDC-3300 Slow-motion system (in a separate brochure) and the HDC-1400 and HDC1450 dual format cameras.

A major reason for this popularity is the wide range of system parts which allow customers to configure an HD camera system for almost any application they require. These parts include a selection of viewfinders, two Camera Control Units, six Remote Control Panels as well as comprehensive connectivity and control options and interfaces for Hybrid Fibre and Triax cabling. The innovative Large Lens and CRT adapters allow a portable camera to be docked with Studio peripherals almost instantly. No re-cabling or adjustment is required thanks to the camera 'hot-shoe' electrical interface and lens registration features.

No less important is the ability to capture superb images in all world wide standards, both progressive and interlaced, in 1080 or 720 formats and at multiple frame rates.

The amazing picture quality achieved by this new camera system is due to the development of an improved CCD and a completely new Digital Signal Processing LSI. The CCD is capable of capturing full HD resolution (1080 x 1920) images at up to 60 progressive frames per second in the normal camera and 180 interlaced frames per second in the unique, 3 x slow motion camera. The DSP in turn allows the camera operator unparalleled freedom of control over the 'look' of the images without unwanted side effects. New user functions include multi matrix and variable black gamma.

Sony HDC cameras are manufactured in our dedicated factory in Pencoed - South Wales, to the highest environmental standards.

Please see <http://www.sony.net/SonyInfo/Environment/activities/index.html> for more information

Studio Camera

Large Lens/Viewfinder Adaptor



HDC-1000

Optical-fibre interface

1080/50i, 59.94i
1080/23.98P, 24P, 25P, 29.97P
1080/50P*, 59.94P*
720/50P, 59.94P



HDLA-1500

(for HDVF-700A/9900)



HDLA-1505

(for HDVF-C950W/C730W)



HDLA-1507

(for HDVF-700A/9900)

Portable Cameras



HDC-1500

Optical-fibre interface

1080/50i, 59.94i
1080/23.98P, 24P, 25P, 29.97P
1080/50P*, 59.94P*
720/50P, 59.94P



HDC-1550

Triax interface

1080/50i, 59.94i
1080/23.98P, 24P, 25P, 29.97P
720/50P, 59.94P



HDC-1450

Triax interface

1080/50i
720/50P



HDC-1400

Optical-fibre interface

1080/50i
720/50P

* 1080/59.94P and 1080/50P signals can be output only from the HDC-1000/HDC-1500 camera head in a stand-alone configuration.

Cutting-edge Technologies

Newly Developed Progressive CCD

At the heart of the outstanding picture performance of the HDC-1000 Series of cameras is a newly developed 2/3-inch type 2.2-megapixel HD CCD. Based on Sony HAD sensor technology and the latest on-chip lens structure, this CCD offers a high sensitivity of F11 at 2,000 lx and an excellent signal-to-noise ratio of 54 dB (typical).

In addition to this performance, a wide variety of capturing modes including 1080/50i, 1080/59.94i, 1080/23.98P, 1080/24P, 1080/25P and 1080/29.97P are available.

What's more, this CCD can capture top-quality 1080/59.94P¹ and 1080/50P¹ images - a capability that also offers highest possible quality 720/50P and 720/59.94P image acquisition.²

1 1080/59.94P and 1080/50P signals can be output only from the HDC-1000/HDC-1500 camera head in a stand-alone configuration via dual-link.

2 The HDC-1400/HDC-1450 supports 1080/50i and 720/50p.

High-quality 14-bit A/D Conversion

The HDC-1000 Series of cameras incorporates a high-performance 14-bit A/D converter that enables images captured by the high-performance CCDs to be processed with maximum precision. In particular,

this high-resolution A/D conversion allows the gradation in mid-to-dark-tone areas of the picture to be faithfully reproduced. Thanks to the 14-bit A/D converter, pre-knee signal compression at highlight areas can be eliminated and the camera can clearly reproduce a high-luminance subject at a 600% dynamic range.

State-of-the-art DSP LSI

The newly developed DSP (Digital Signal Processing) LSI "Visual Image Processor" is at the heart of the image-processing device for the HDC-1000 Series of cameras. By adopting the latest 0.11 mm design rule, this processor can accommodate up to 1080/59.94 and 1080/50 progressive formats and 14-bit resolution, maximising the high-clarity images captured by the CCD. In addition, white balance, white shading, and flare are digitally corrected, allowing for stable image correction. Processing is performed with more than 30 bits accuracy to ensure freedom from rounding artefacts.

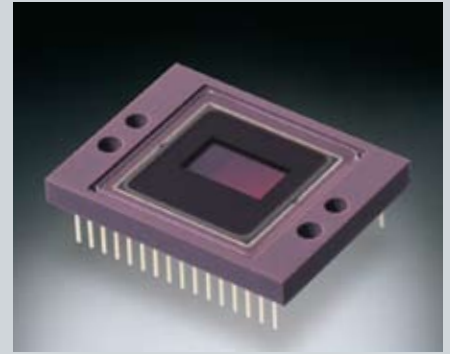

New Progressive CCD



New developed DSP



HDC-1500



HDC-1000

Great Operability

Ergonomic Design

The design of the HDC-1000 Series of cameras is based on over two decades of Sony experience in manufacturing broadcast video cameras and camcorders, and provides a high level of operability. All control switches and connectors are in the most logical places for optimum functionality and ease of use. The low-profile body of the HDC-1000 camera minimises the parallax between the optical axis of the camera head and the large viewfinder, while the HDC-1400/HDC-1450/HDC-1500/HDC-1550's low centre of gravity design allows the operator to carry the camera comfortably on the shoulder. In addition, the shoulder pad of these cameras can be adjusted either forwards or backwards without using a screwdriver, so the camera can easily be moved to a well-balanced position.

Optical Fibre Digital Transmission (HDC-1000/HDC-1400/HDC-1500)

The HDC-1000/HDC-1400/HDC-1500 camera comes equipped with an SMPTE standard optical fibre interface for connecting its associated HDCU-1000/HDCU-1500 Camera Control Unit.

In addition to its exceptional quality, the camera can transmit all-digital bi-directional video and audio signals, one control line, and prompter line over extremely long distances – up to 3000 meters (9843 feet)³ with the HDCU-1000 and 1800 meters (5906 feet)³ with the HDCU-1500.

³ When supplying power to the camera via the optical fibre cable, the maximum cable length varies with the camera system configuration, lens type, and the number of cable connectors.

Choice of Two Camera Control Systems

In a multi-camera configuration featuring the HDC-1000 Series, two types of camera control system can be used. One is based on the CNU-700 Camera Command Network Unit at the centre of the configuration, while the other makes use of the Ethernet functionality of the systems – a new and powerful feature that also provides a path to the future. Both control systems allow communication between all the devices in the configuration, including cameras, camera control units, remote controllers, and setup units.

Wide-band Triax Transmission (HDC-1450/HDC-1550)

The HDC-1450/HDC-1550 camera comes equipped with a widely-used triax transmission interface. This enables the camera to transmit bi-directional video and audio signals, and one control line to the HDCU-1000/HDCU-1500 Camera Control Unit via the HAFX-100 unit over long distances - up to 1400 meters (4593 feet)⁴ with a \varnothing 14.5 mm triax cable or 1000 meters (3281 feet)⁴ with a \varnothing 11 mm triax cable.

⁴ When supplying power to the camera via the triax cable, the maximum cable length varies with the camera system configuration, lens type, the size of the triax cable, and the number of cable connectors.

Compact and Lightweight

HDC-1400/HDC-1500/HDC-1550 portable cameras are designed to be very compact and lightweight for a high level of mobility in the field. The HDC-1400/HDC-1500 and HDC-1450/HDC-1550 cameras weigh approximately 4.5 kg and 4.9 kg respectively.

Versatile Interfaces

The HDC-1000/HDC-1500 camera and the HDC-1400/HDC-1450/HDC-1550 camera provide two HD-SDI outputs and one HD-SDI output respectively, as well as one digitally down-converted SD-SDI or analogue composite output. In addition, the viewfinder signals with characters can be output from the SD-SDI output connector, giving camera operators additional convenience. Furthermore, for 24P⁵ operation, the built-in 2-3 pull-down function of the cameras enables 59.94i down-converted SD signals to be output on a standard SD monitor.

⁵ Not supported by HDC-1400/HDC-1450

Memory Stick Storage of Camera Setup Parameters

The HDC-1000 Series is capable of saving and recalling setup parameters such as scene files, reference files, and lens files via Memory Stick™ media. This allows users to effectively manage camera parameters for individual scenes, plus the specific camera-setup preferences of individual operators, such as viewfinder indicator settings.

Servo-controlled ND and CC Filters

The HDC-1000/HDC-1500/HDC-1550 camera comes equipped with dual optical filters for ND (Neutral Density) and CC (Colour Correction), while the HDC-1400/HDC-1450 camera is equipped with a single optical filter for ND and electronic colour correction.

The filters can be remotely controlled from an RCP Series Remote Control Panel, MSU-900/950 Master Setup Unit, or RM-B750/B150 Remote Control Unit as well as locally controlled on the camera head.



HDLA-1500/HDLA-1505/HDLA-1507 – Maximising Operability

Responding to the ever-increasing requirement of operations that combine a portable camera with a large lens, Sony has developed the optimum solution.

The highly sophisticated HDLA-1500 and HDLA-1505 Large Lens Adaptors are designed to maximise operability of the HDC-1400/HDC-1450/HDC-1500/HDC-1550 camera. Until now, setting up a portable camera with a large lens adaptor has been a difficult task, especially fine-tuning the mechanical adjustments between each device. With the HDLA-1500/HDLA-1505 Large Lens Adaptor, time-consuming adjustments, as well as re-wiring, are absolutely eliminated.

Another convenient peripheral for the portable cameras, the HDLA-1507 Large Viewfinder Adaptor, is also available, enabling a large viewfinder to be used with the portable camera.



Docking 1

Open the rear cover of the HDLA Series adaptor. There is no need to detach the viewfinder.

Totally New Interlocking Mechanism

The HDLA-1500/HDLA-1505/HDLA-1507 adaptor does not require any cable wirings. Utilising a newly developed interlocking mechanism, the power, video and control signals are passed on directly from the portable cameras to the HDLA Series adaptor. This unique mechanism also allows the portable cameras to be attached and detached without removing the large lens. Furthermore, the lens can be removed even when the camera is mounted on the HDLA-1500/HDLA-1505 adaptor. The interlocking mechanism allows for an astonishingly quick and smooth setup.

Low-profile Design

Together with the low-profile design of the portable camera, the viewfinder position of the HDLA-1500 is 45 mm lower than the previous model. This low-profile design significantly improves the operator's view, as well as minimizes the parallax between the optical axis of the camera head and viewfinder.



HDLA-1500 with HDVF-700
(Large Lens and CRT Viewfinder)



Docking 2

Mount the portable camera and slide forward until you hear the locking click.



Docking 3

Close the rear cover and then slide the viewfinder forward.



HDLA-1505 with HDVF-C730W
(Large Lens and LCD Viewfinder)



HDLA-1507 with HDVF-9900
(2/3" Lens and CRT Viewfinder)

Creative Versatility

Digital Extender¹

The Digital Extender function of the HDC-1000 Series of cameras² enables images at the centre of the shot to be digitally doubled in size. Unlike lens extenders, the Digital Extender function performs this capability without any loss in image sensitivity.

- 1 Use of the digital extender function will reduce the resolution of the image by half.
- 2 The HDC-1400/HDC-1450 do not support the digital extender function.



Digital Extender

OFF



Digital Extender

ON

Multi-matrix

The Multi-matrix function of the HDC-1000 Series of cameras allows colour adjustments to be applied over the colour range specified by the operator. The colour spectrum is divided into 16 areas of adjustment, where the hue and/or saturation of each area can be modified. This function is especially useful when only the hue of certain colours needs to be adjusted in critical applications.



Multi-matrix

OFF



Multi-matrix

ON

Triple Skin Tone Detail Correction

Skin Tone Detail Correction controls the detail level of those objects in a scene with specific colour tones.

The HDC-1000 Series of cameras allows detail to be set independently for each of three separate colour ranges. These colours are not limited to skin tones, but can be set for any colour. Detail may be increased or decreased relative to the normal level.



Skin Tone Detail

OFF

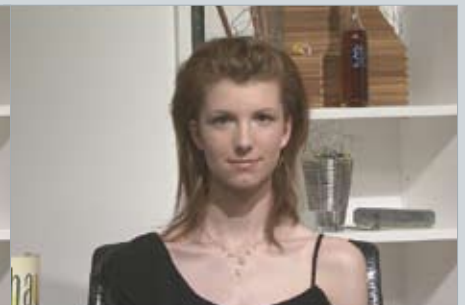

Skin Tone Detail

ON

Knee Saturation

Traditionally, very bright parts of a scene (such as key light from a person's forehead) suffer from a loss of saturation or a change in hue. The HDC-1000 family provide a 'Knee Saturation' function, which can counteract this effect and achieve a more natural appearance in these difficult areas.



Simulated Images

Knee Saturation

OFF

Knee Saturation

ON

Low-key Saturation

With conventional cameras, low light areas can be subject to a reduction in saturation. This can result in colours in those areas being lost. The Low-Key Saturation function on the HDC-1000 Series of cameras eliminates this problem by optimising the amplification of colour saturation at low light levels, providing more natural colour reproduction.



Low-key Saturation

OFF

Low-key Saturation

ON

Selectable Gamma Table

The selectable gamma table provided with the HDC-1000 Series cameras allows users to create a specific look for a picture by selecting from a choice of fixed gamma patterns.

Variable Black Gamma

The Variable Black Gamma function for the HDC-1000 Series of cameras allows for fine adjustment of tonal reproduction in the shadow area. This feature can help to bring out details from the dark parts of the picture without affecting mid-tones while maintaining the absolute black level.



Simulated Images

Standard Video Gamma

Variable Black Gamma ON

Versatile System Components

The HDC-1000 Series of cameras is compatible with a variety of peripherals including camera control units, remote controllers, command network units, and master setup units. This allows operators to flexibly configure the system according to their needs both in the studio and out in the field. Optional triax adaptors are available for the HDC-1000/HDC-1400/HDC-1500 optical fibre-based camera to enable triax-based operation.

HDCU-1000 Full-size Camera Control Unit

HDCU-1500 Half-rack-size Camera Control Unit

The HDC-1000 Series of cameras can be configured with two types of camera control unit – the full-size HDCU-1000 and half-rack-size HDCU-1500. The optical fibre transmission system used in these units maintains the high picture quality of the camera across cable runs of up to 3000 meters (9843 feet)¹ with the HDCU-1000 and up to 1800 meters (5906 feet)¹ with the HDCU-1500. Both models are equipped with a comprehensive range of built-in interfaces such as HD-SDI/SD-SDI outputs, HD-SDI/SD-SDI/analogue composite return inputs, and a down-converted analogue composite monitor output. In addition, a variety of output interfaces are offered via optional boards, which can be installed in four slots on the HDCU-1000 and two slots on the HDCU-1500. Furthermore, the Ethernet interface (10Base-T/100Base-TX) that is built into both CCUs allows the camera to be controlled over a network.

¹ When supplying power to the camera via the optical fibre cable, the maximum cable length varies with the camera system configuration, lens type, viewfinder type, and the number of cable connectors.

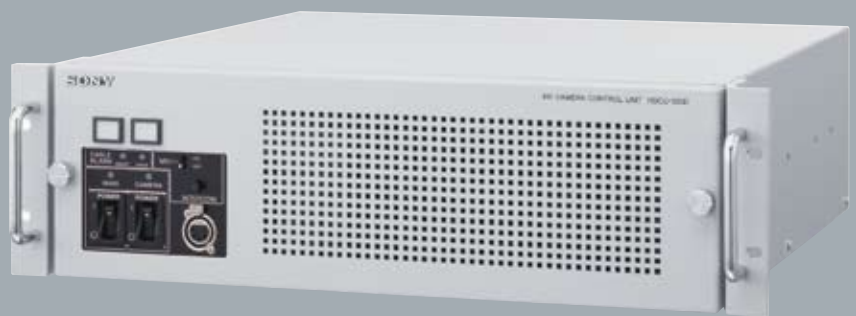

HDCU-1000

- > Eight HD-SDI or SD-SDI outputs
- > Up to eight additional HD-SDI or SD-SDI outputs (with two optional HKCU-1005 boards)
- > Four sets of HD-SDI, SD-SDI, and analogue composite return video inputs
- > Two-channel teleprompter inputs
- > Built-in Ethernet interface (10Base-T/100Base-TX)
- > Two-channel data trunk lines (RS-422A or RS-232C) for easy data transmission
- > AES/EBU digital audio output
- > Two-channel microphone outputs (two XLR connectors)
- > High power capability



Rear Panel

Three types of interface expansion option are available for both CCUs.

- > The **HKCU-1001** SD Analogue Interface Unit provides two analogue NTSC or PAL VBS signal outputs, a PIX (picture monitor) output, and a WFM (waveform monitor) output.
- > The **HKCU-1003** Multi Interface Unit consists of three types of interface board and provides:
 - Two analogue NTSC or PAL VBS signal outputs, a PIX output, and a WFM output (Board A)
 - A frame reference input, output to lock 2-3 pull-down sequence, a PIX output, and a WFM output (Board B)
 - Analogue NTSC or PAL VBS and analogue component R/G/B or Y/R-Y/B-Y outputs (Board C)



HDCU-1500

- > Compact CCU
- > Three HD-SDI or SD-SDI outputs
- > Up to eight additional HD-SDI or SD-SDI outputs (requires two optional HKCU-1005 boards)
- > Three HD-SDI, SD-SDI, or analogue composite return video inputs
- > RM-B750 Remote Control Unit attach capability on the front panel
- > One-channel teleprompter input
- > Built-in Ethernet interface (10Base-T/100Base-TX)
- > Two-channel data trunk line (RS-422A/RS-232C) for easy data transmission
- > Two-channel microphone outputs (two XLR connectors)



Rear Panel



RM-B750 Remote Control Unit

The RM-B750 Remote Control Unit has been designed to offer a highly mobile and fully controllable camera system in the field. The RM-B750 can be connected directly to the HDC-1000 Series camera or attached to the half-rack-size HDCU-1500 Camera Control Unit. The combination of an LCD touch-panel screen and direct push buttons enables full parameter adjustment of the camera to be controlled. For further operational convenience, the RM-B750 has a Memory Stick media card slot so that various setup parameters can be stored and recalled.



The RM-B750 attached to the HDCU-1500

- > The **HKCU-1005** HD/SD Output Expansion Unit provides 4 additional HD SDI or SD SDI outputs.



HKCU-1001
SD Analogue
Interface Unit



HKCU-1003
Multi Interface
Unit



HKCU-1005 HD/SD
Expansion Unit

Versatile System Components



MSU-900



MSU-950

MSU-900/950 Master Setup Unit

The MSU-900/950 Master Setup Unit is a central control panel used for the adjustment of camera parameters in a multi-camera system. The MSU-900/950 unit is connected to each camera control unit in the system via the CNU-700 Command Network Unit or an Ethernet network hub.

- > Central control of camera parameters for the entire camera system (up to 24 cameras)
- > Picture and waveform monitor switching
- > Precise picture adjustment
- > Built-in 6.5-inch¹ type LCD display for clear viewing of adjustment parameters during operation
- > Memory Stick slot for storing/recalling files
- > Built-in Ethernet interface (10Base-T/100Base-TX)

¹ Viewable area measured diagonally

RCP Series Remote Control Panel

Four types of Sony Remote Control Panel - the RCP-750, RCP-751, RCP-920, and RCP-921 - are available, providing a wide range of camera parameter controls. The RCP-750/751 offers in-depth menu-based controls, while the RCP-920/921 allows direct and quick control of various parameters using dedicated buttons on the panel. The RCP-750 and 751 are connected to the CCU via dedicated cabling. The RCP-920 and 921 can also be connected and powered directly from a (POE) network hub.



RCP-750



RCP-751



RCP-920



RCP-921

CNU-700 Camera Command Network Unit



The CNU-700 Camera Command Network Unit allows communication between all the units in the system, and provides the ability to assign CCUs, MSUs, RCPs, and HDC-1000 Series camera heads. A RISC-based microprocessor system provides high-speed transfer of command signals to the HDCU-1000/HDCU-1500 Camera Control Unit for rapid response and reliable control.

One CNU-700 unit can control six cameras, but can be expanded to control up to 12 cameras when fitted with an optional BKP-7930 Expansion Board.

Several CNU-700 units can be connected to the camera control network in a large system. The CNU-700 supports RCP assignment.

HDTX-100

HD Triax Adaptor (Camera side)

HDFX-100

HD Triax Adaptor (HDCU side)

The HDTX-100 and HDFX-100 HD Triax Adaptors are available to convert optical fibre transmission to the widely-used triax transmission. The HDTX-100 adaptor is used with the HDC-1000/HDC-1400/HDC-1500 camera¹ to convert their camera output to triax, while the HDFX-100 adaptor is used with the HDCU-1000/HDCU-1500 camera control unit to receive triax signals from the camera side.

The triax-based system enables high-quality pictures to be transmitted from the cameras over long distances - up to 1400 meters (4593 feet)² with a ϕ 14.5 mm triax cable or 1000 meters (3281 feet)² with a ϕ 11 mm triax cable. In addition, the HDTX-100 adaptor enables hybrid triax and optical fibre operation. In this case, longer cable runs of more than 2000 meters (6562 feet)² can be achieved with the HDC-1400/HDC-1500 portable camera that is equipped with a portable lens and a small viewfinder.

1 The HDC-1450/HDC-1550 does not require the HDTX-100 unit because it is equipped with a triax output as standard.

2 When supplying power to the camera via the optical fibre cable and/or triax cable, the maximum cable length varies with the camera system configuration, lens type, viewfinder type, diameter of the triax cable and the number of cable connectors.



HDTX-100 (Triax powered)



HDFX-100 (Requires mains power)

Triax and Optical Fibre Operation

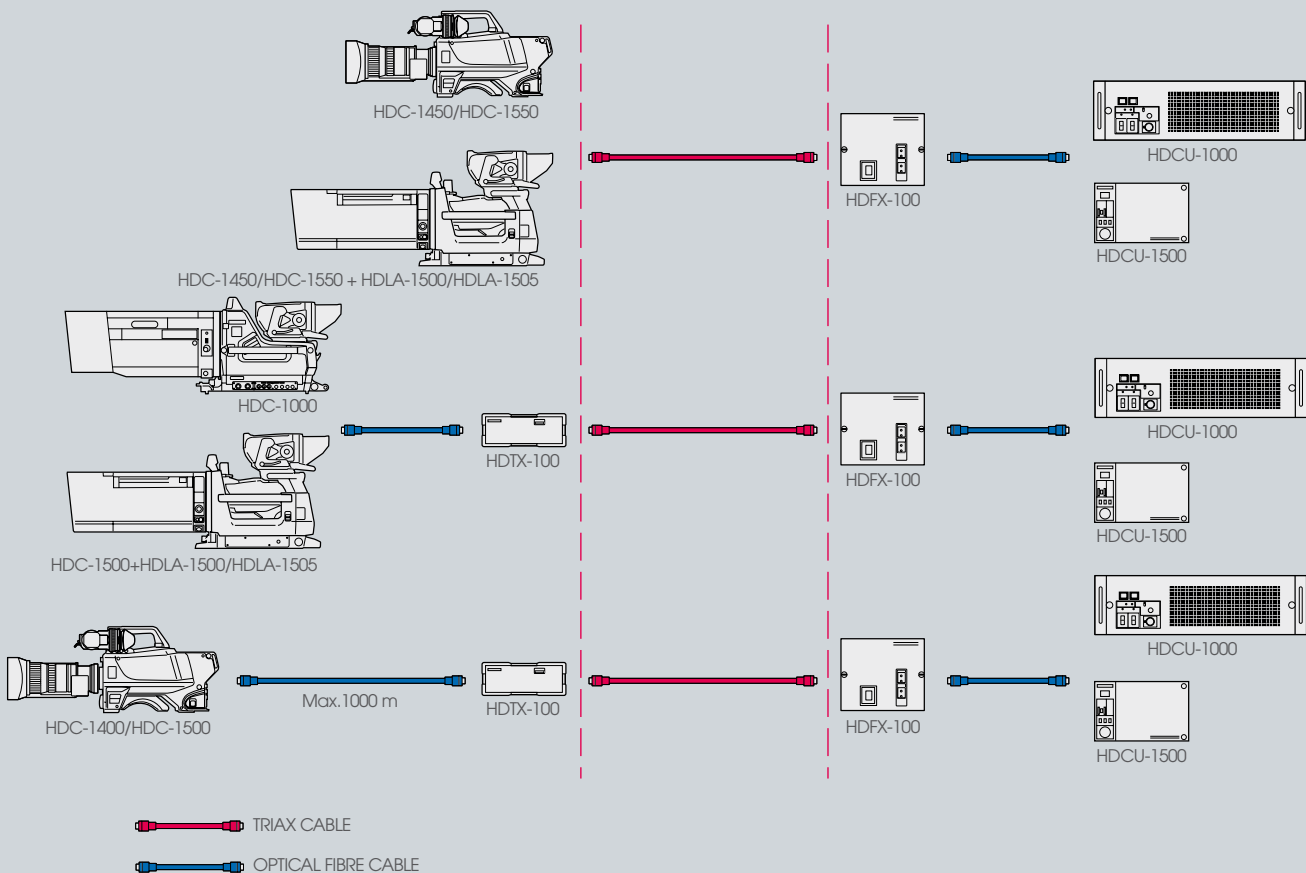

Versatile System Components

HKC-T1500

CCD Block Extension Adaptor

The HKC-T1500 CCD Block Extension Adaptor is a unique accessory for HDC-1400/HDC-1450/HDC-1500/HDC-1550 portable cameras. It allows the CCD block to be extended from the camera body by up to 12.5 m (or 50 m with an optional cable). More creative camera shooting angles can be achieved, along with the freedom to place the imaging assembly in areas where a full-size camera would be restricted. The HKC-T1500 adaptor will expand the spectrum of HD camera applications in areas such as snorkel lenses, helicopter gimbal mounts, and mini jibs.



HKC-T1500 connected to the HDC-1500



Control/Intercom Panels and Connectors

HDC-1000

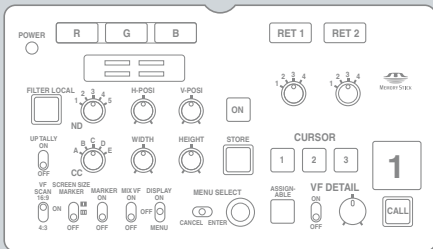

Control Panel

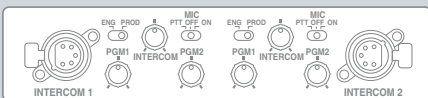

Intercom Panel

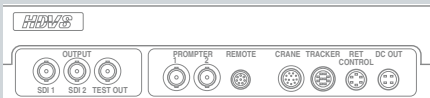

Connectors - Inside Panel



Connectors - Outside Panel

HDC-1400/HDC-1450/HDC-1500/HDC-1550

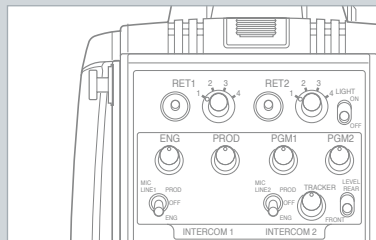

Control/Intercom Panel

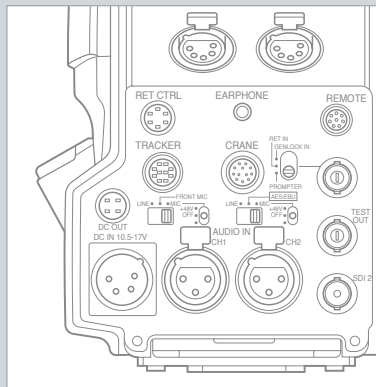

HDC-1400/1450/1500/HDC-1550 Connectors

Optional Accessories



HDLA-1500
Large Lens Adaptor
(for attachment of the
HDVF-700A/9900)



HDLA-1505
Large Lens Adaptor
(for attachment of the
HDVF-C950W/C730W)



HDLA-1507
Large Viewfinder Adaptor
(for attachment of the
HDVF-700A/9900)



RM-B150
Remote Control Unit



RM-B750
Remote Control Unit

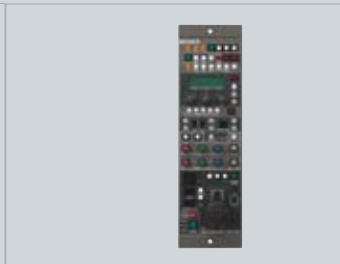

RCP-920/921
Remote Control Panel
(Photo shows RCP-920)

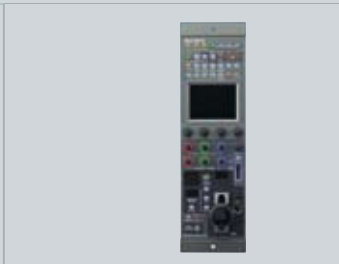

RCP-750/751
Remote Control Panel
(Photo shows RCP-750)



HDVF-20A
2.0-inch* CRT B/W Viewfinder



HDVF-C35W
3.5-inch* LCD Colour Viewfinder



HDVF-C950W
9.0-inch* LCD Colour Viewfinder



VFH-990
Outdoor Hood for HDVF-C950W



HDVF-C730W
6.3-inch* LCD Colour Viewfinder



HDVF-700A
7.0-inch CRT B/W Viewfinder



VFH-770
Outdoor Hood for
HDVF-700A/C730W



HDVF-9900
9.0-inch CRT Colour Viewfinder



BKW-401
Viewfinder Rotation Bracket



BKP-7911
Script Holder



CAC-6
Return Video Selector



CAC-12
Mic Holder



VCT-14
Tripod Adaptor

System Configuration for Optical Fibre Operation

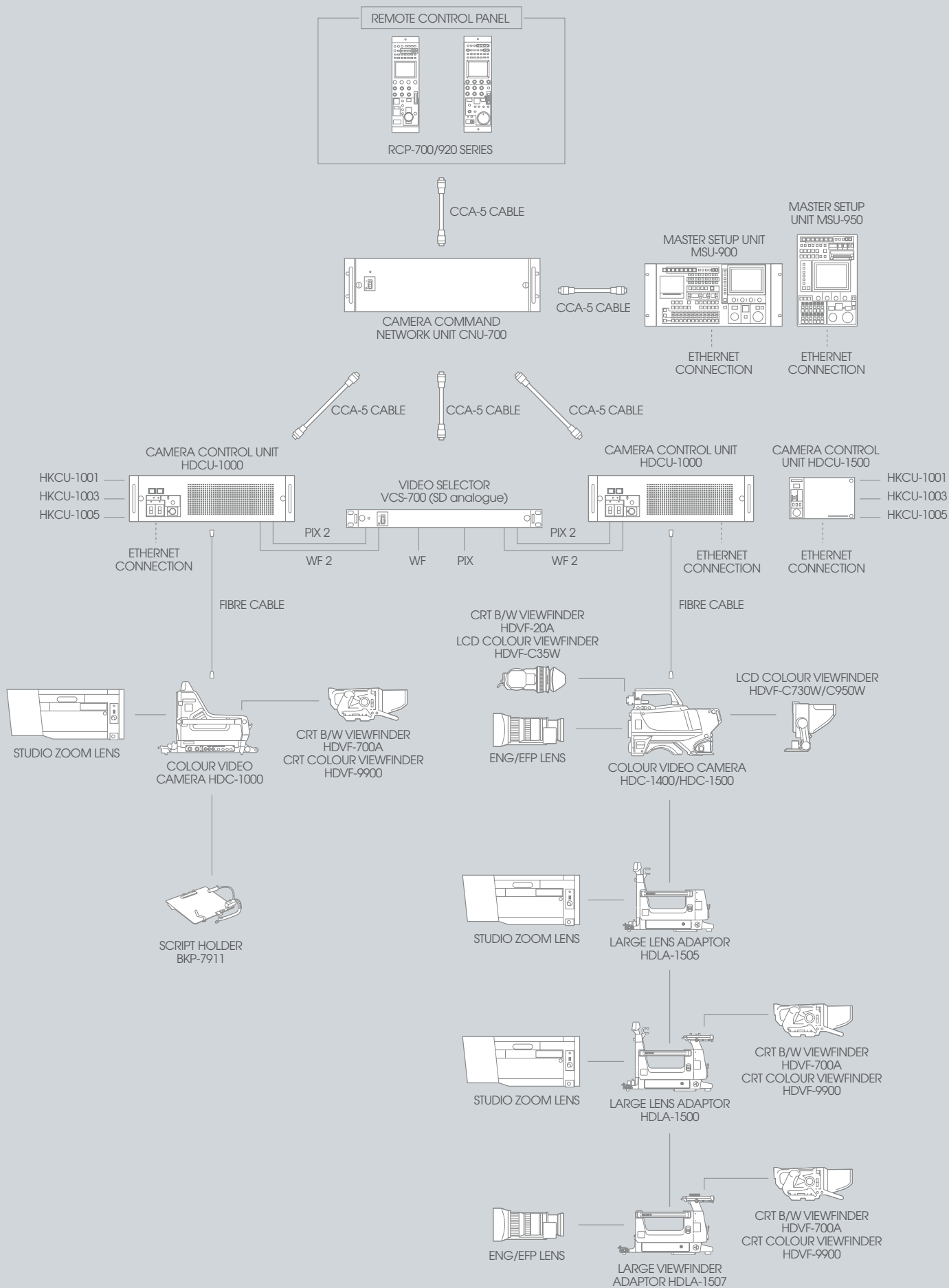

System Configuration for Triax Operation

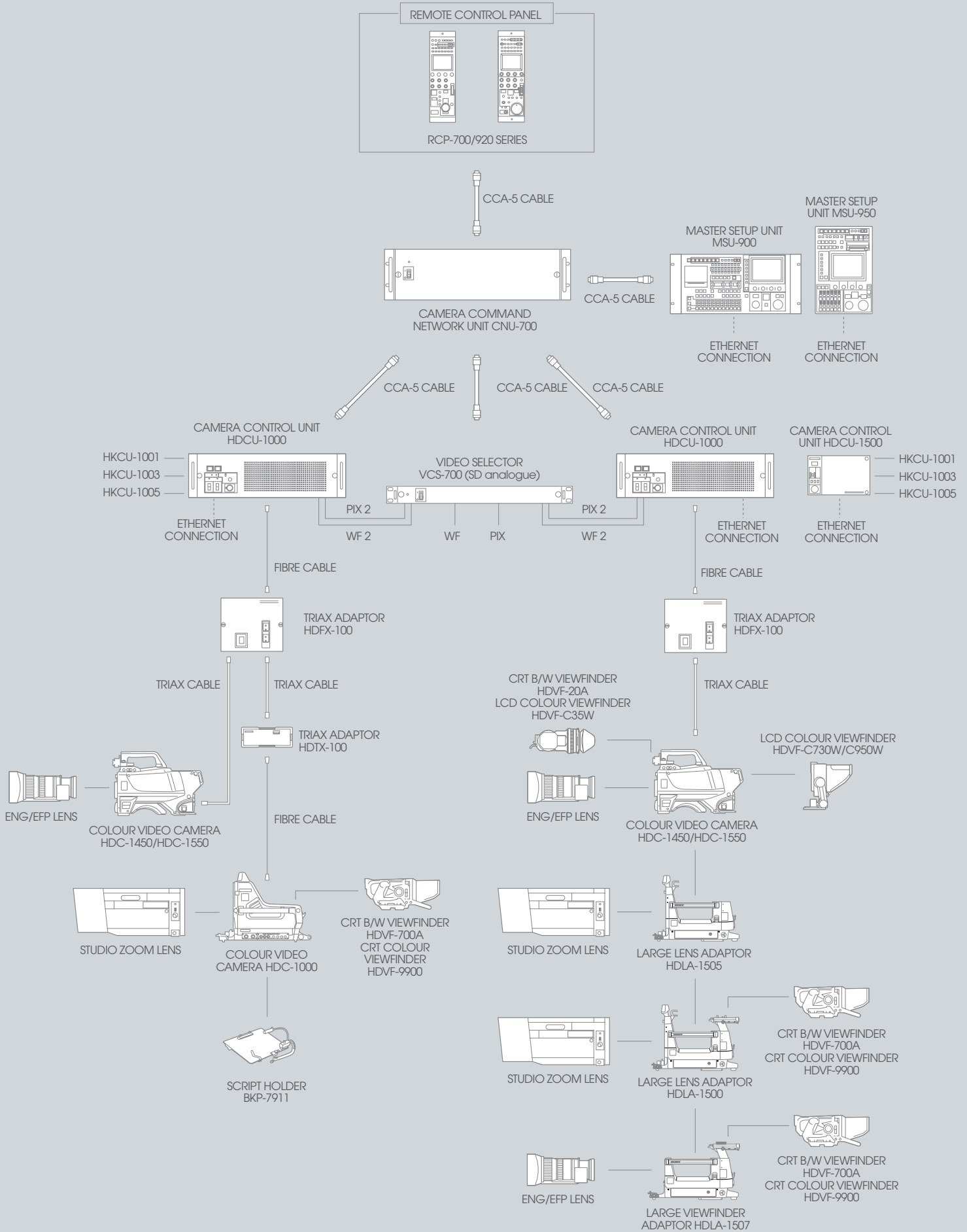

HDC-1000/1400/1450/1500/1550 Specifications

	HDC-1000	HDC-1400	HDC-1450	HDC-1500	HDC-1550
General					
Power requirements	240 V AC, 1.7 A (max.), 180 V DC, 0.9 A (max.), 12 V DC, 10 A (max.)	240 V AC, 1.4 A (max.), 180 V DC, 1.0 A (max.), 12 V DC, 7 A (max.)	180 V DC, 1.0 A (max.), 12 V DC, 7 A (max.)	240 V AC, 1.4 A (max.), 180 V DC, 1.0 A (max.), 12 V DC, 7 A (max.)	180 V DC, 1.0 A (max.), 12 V DC, 7 A (max.)
Operating temperature	-20 °C to +45 °C (-4 °F to +113 °F)				
Storage temperature	-20 °C to +60 °C (-4 °F to +140 °F)				
Mass	21 kg (46 lb 5 oz)	4.5 kg (9 lb 15 oz)	4.9 kg (10 lb 13 oz)	4.5 kg (9 lb 15 oz)	4.9 kg (10 lb 13 oz)
Camera					
Pickup device	3-chip 2/3-inch type CCD				
Effective picture elements (H x V)	1920 x 1080				
Signal format	1080/50i, 59.94i, 23.98P 24P, 25P, 29.97P, 50P, 59.94P 1080/50P*, 59.94P* 720/50P, 59.94P	1080/50i, 720/50P		1080/50i, 59.94i, 23.98P 24P, 25P, 29.97P, 50P, 59.94P 1080/50P*, 59.94P* 720/50P, 59.94P	1080/50i, 59.94i, 23.98P 24P, 25P, 29.97P 720/50P, 59.94P
Spectrum system	F1.4 prism system				
Lens mount	Sony hanger mount		Sony bayonet mount		
Built-in filters	CC	A: CROSS, B: 3200K, C: 4300K, D: 6300K, E: 8000K		A: CROSS, B: 3200K, C: 4300K, D: 6300K, E: 8000K	
	ND	1: CLEAR, 2: 1/4ND, 3: 1/8ND, 4: 1/16ND, 5: 1/64ND	1: CLEAR, 2: 1/4ND, 3: 1/16ND, 4: 1/64ND, 5: CROSS		1: CLEAR, 2: 1/4ND, 3: 1/8ND, 4: 1/16ND, 5: 1/64ND
Sensitivity (at 2000 lx, 3200K, 89.9% reflectance)	F10 (1080/59.94i), F11 (1080/50i)				
Signal-to-noise ratio (1080i)	54 dB				
Horizontal resolution (1080i)	1000 TV lines (at center)				
Registration	Within 0.02% (all zones, without lens)				
Shutter speed selection	1/100, 1/125, 1/250, 1/500, 1/1000, 1/2000 s (1080/59.94i)	1/60, 1/125, 1/250, 1/500, 1/1000, 1/2000 s		1/100, 1/125, 1/250, 1/500, 1/1000, 1/2000 s (1080/59.94i)	
Modulation depth (1080i)	45% horizontally (typical) (800 TV lines at center, 27.5 MHz, with typical lens)				
Input/output connectors					
Audio input (CH1)	XLR-3-31 type (male) (1), mic or line selectable	XLR-3-pin (female) (1), mic or line selectable			
Audio input (CH2)	XLR-3-31 type (male) (1), AES/EBU or mic or line selectable	XLR-3-pin (female) (1), AES/EBU or mic or line selectable	XLR-3-pin (female) (1), mic or line selectable	XLR-3-pin (female) (1), AES/EBU or mic or line selectable	XLR-3-pin (female) (1), mic or line selectable
Mic 1 input	—	XLR-3-pin (female) (1)			
Return control input	6-pin (1)				
Prompter output/Genlock input/Return input	—			BNC type (1), 1.0 Vp-p, 75 Ω	
Prompter	—	BNC type (1), 1.0 Vp-p, 75 Ω			
Prompter 1	BNC type (1), 1.0 Vp-p, 75 Ω	—			
Prompter 2	BNC type (1), 1.0 Vp-p, 75 Ω	BNC type (1), 1.0 Vp-p, 75 Ω			
DC input	XLR-4-pin (1), 10.5 to 17 V DC				
DC output	4-pin (1), 10.5 to 17.5 V DC, 500 mA (max.)				
Test output	BNC type (1), 1.0 Vp-p, 75 Ω				
SDI 1 output	BNC type (2) HD-SDI	—		BNC type (2) HD-SDI	—
SDI 2 output	BNC type (2) HD-SDI or SD-SDI selectable (without embedded audio)	—		BNC type (2) HD-SDI or SD-SDI selectable (without embedded audio)	—
SDI output	—	BNC type (1) HD-SDI or SD-SDI selectable (without embedded audio)			BNC type (1) HD-SDI or SD-SDI selectable (without embedded audio)
Earphone output	—	Stereo minijack (1)			
CCU	Electro-optical connector (1)				
HDCU/HDFX	—	Triax connector (1)			
Tracker	10-pin (1)				
Crane	12-pin (1)				
Intercom 1	XLR-5-pin (female) (1)				
Intercom 2	XLR-5-pin (female) (1)				
Remote	8-pin (1)				
Lens	36-pin (1)				
Viewfinder	D-sub 25-pin (1) (CRT)		20-pin (1) (LCD and Monocle)		
Supplied accessories					
	Angle adjustment brackets (2), Front cover (1), Number plates for side panel (2 sets), Number plates for up-tally lamp (1 set), Cable clamp (2), Operation manual (1)		Operation manual (1), Switch label 1, 2 (1 each)		

MSU-900/950 Specifications

	MSU-900	MSU-950
General		
Power requirements	100 to 240 V AC, 50/60 Hz	
Current consumption	0.35 A	
Operating temperature	+5 to +40 °C (+41 to +104 °F)	
Maximum cable length	200 m (656 feet)	
Mass	4.5 kg (9 lb 14 oz)	3.7 kg (8 lb 2 oz)
Dimensions (W x H x D)	482 x 67 x 222 mm (19 x 2 3/4 x 8 3/4 inches)	204 x 354 x 67 mm (8 1/8 x 14 x 2 3/4 inches)
Inputs/outputs		
Remote	CCU/CNU: 8-pin (1) AUX: 8-pin (1)	
I/O port	50-pin (1)	
Ethernet	6-pin (1)	
AC input	3-pin (1)	

HDLA-1500/1505/1507 Specifications

	HDLA-1500	HDLA-1505	HDLA-1507
General			
Power requirements	240 V AC (max. 1.2 A)/180 V DC (max. 0.65 A), 12 V DC (max. 9 A)		
Operating temperature	-20 °C to +45 °C (-4 °F to +113 °F)		
Storage temperature	-20 °C to +60 °C (-4 °F to +140 °F)		
Mass	18.5 kg (40 lb 13 oz)	17.1 kg (37 lb 11 oz)	15.5 kg (34 lb 3 oz)
Input/output connector			
Lens	36-pin		
DC IN	XLR-4-pin (1), 10.5 to 17 V DC		
DC OUT	4-pin (1), 10.5 to 17 V DC, max. 1.5 A		
Viewfinder	D-sub 25-pin (1) (CRT)	Camera-mounted LCD	D-sub 25-pin (1) (CRT)

HDCU-1000/1500 Specifications

	HDCU-1000	HDCU-1500
General		
Power supply	100 V or 120 V or 220 to 240 V AC, 50/60 Hz	100 to 240 V AC, 50/60 Hz
Operating temperature	+5 °C to +40 °C (+41 °F to +104 °F)	-10 °C to +40 °C (+14 °F to +104 °F)
Storage temperature	-20 °C to +60 °C (-4 °F to +140 °F)	
Mass	14.8 kg (32 lb 10 oz)	6.5 kg (14 lb 5 oz)
Input/output connectors		
Camera	Optical fiber connector (1), 1.485/1.4835 Gb/s Serial Digital x2, 240 V AC power supply	Optical fiber connector (1), 1.485/1.4835 Gb/s Serial Digital x2, 180 V AC power supply
Intercom/Tally/PGM	D-sub 25-pin (1) INCOM (PD/ENG): 4W/RTS/CC, 0 dB PGM: 2 systems, 0/-20 dB PGM: 2 systems, 0/-20 dB	
RCP/CNU	8-pin (1)	
Trunk A	12-pin (1)	
Trunk line	D-sub 9-pin (female) (1), RS-232C/422	—
Ethernet	RJ-45 (1), 10Base-T/100Base-TX	
I/O port	D-sub 15-pin (female) (1)	—
Input connectors		
AC input	(1), 100, 110 to 120, 220 to 240 V AC	(1), 100 to 240 V AC
Return input	BNC type (4), HD-SDI: SMPTE 292M, 1.485/1.4835 Gb/s BNC type (4), SD-SDI: SMPTE 259M, 270 Mb/s	BNC type (3), HD-SDI/SD-SDI/VBS selectable VBS: 1.0 Vp-p, 75 Ω HD-SDI: SMPTE 292M, 1.485/1.4835 Gb/s SD-SDI: SMPTE 259M, 270 Mb/s
Reference input	BNC type (2), loop-through output HD: SMPTE-274M, tri-level sync, 0.6 Vp-p, 75 Ω SD: Black burst (NTSC: 0.286 Vp-p, 75 Ω/PAL: 0.3 Vp-p, 75 Ω) or NTSC 10F-BB	
Prompter input	BNC type (4), loop-through output, analogue signal, 1.0 Vp-p, 75 Ω	
Mic remote	D-sub 15-pin (1)	
Output connectors		
Mic output	XLR-3-pin (male) (2), 0/-20 dBs	
AES/EBU	BNC type (1)	—
Character output	BNC type (1), VBS, 1.0 Vp-p, 75 Ω, character ON/OFF selectable	—
Character/Sync output	—	BNC type (1), HD sync/SD sync/Character selectable HD sync: BTA S001A, tri-level sync, 0.6 Vp-p, 75 Ω SD sync: composite sync, 0.3 Vp-p, 75 Ω Character: VBS, 1.0 Vp-p, 75 Ω, character ON/OFF selectable
WF remote	D-sub 15-pin (female) (1)	—
HD-SDI/SD-SDI output	BNC type (4), HD-SDI/SD-SDI selectable HD-SDI: SMPTE 292M, 0.8 Vp-p, 75 Ω, 1.485/1.4835 Gb/s SD-SDI: SMPTE 259M, 0.8 Vp-p, 75 Ω, 270 Mb/s	BNC type (2), HD-SDI/SD-SDI selectable HD-SDI: SMPTE 292M, 0.8 Vp-p, 75 Ω, 1.485/1.4835 Gb/s SD-SDI: SMPTE 259M, 0.8 Vp-p, 75 Ω, 270 Mb/s
HD-SDI/SD-SDI monitor output	BNC type (4), HD-SDI/SD-SDI, and character ON/OFF selectable HD-SDI: SMPTE 292M, 0.8 Vp-p, 75 Ω, 1.485/1.4835 Gb/s SD-SDI: SMPTE 259M, 0.8 Vp-p, 75 Ω, 270 Mb/s	BNC type (1), HD-SDI/SD-SDI, and character ON/OFF selectable HD-SDI: SMPTE 292M, 0.8 Vp-p, 75 Ω, 1.485/1.4835 Gb/s SD-SDI: SMPTE 259M, 0.8 Vp-p, 75 Ω, 270 Mb/s
Sync out	BNC type (1), HD sync/SD sync selectable HD: BTA S001A, tri-level sync, 0.6 Vp-p, 75 Ω SD: composite sync, 0.3 Vp-p, 75 Ω	—
WF mode	4-pin (2)	

Optional input/output boards

HKCU-1001 SD Analogue Interface Unit	
VBS output	BNC type (2)
Analogue composite monitor output	BNC type: WF (1), PIX (1)
HKCU-1003 Multi Interface Unit	
VDA-A board: VBS I/F	
VBS output	BNC type (2)
Analogue composite monitor output	BNC type: WF (1), PIX (1)
VDA-B board: VBS I/F	
Frame reference input/output	BNC type (1, loop-through), full pull-down sequence lock
Analogue composite monitor output	BNC type: WF (1), PIX (1)
VDA-C board: Sub I/F	
VBS output	BNC type (1)
Analogue component output	BNC type (3), R/G/B or Y/R-Y/B-Y selectable
HKCU-1005 HD/SD Expansion Unit	
HD SDI/SD SDI output	BNC type (2)
HD SDI/SD SDI monitor output	BNC type (2), character on/off selectable

HKC-T1500 Specifications

General	
Power requirements for Camera input	13.5 to 17.0 V DC
Operating temperature	-20 °C to +45 °C (-4 °F to +113 °F)
Operating humidity	10% to 90% (no condensation)
Mass	Cable adaptor: approx. 0.5 kg (1 lb 2 oz) CCD block adaptor: approx. 1.9 kg (4 lb 3 oz) (with CCD block)
CCD block adaptor I/F	
Camera cable	55-pin multicore cable connector (male)
MIC IN	XLR-3-pin (female) (1)
LENS	12-pin (1)
VF	20-pin (1)
Intercom	XLR-5-pin (female) (1)
Cable adaptor I/F	
Camera cable	55-pin multicore cable connector (female)
MIC OUT	XLR-3-pin (male) (1)
VF	20-pin (1)
INCOM	XLR-5-pin (male) (1)

SONY

Specialist Dealer

Specialist Dealers receive extensive training on all Sony's products and services. They combine this with an in-depth knowledge of the market, ensuring you get advice that meets your needs before and after purchase. To find your nearest Specialist Dealer visit our "dealer locator" at:

www.sonybiz.net/dealer

Services from Sony

> Working with you, working for you

Recognising that every company and every challenge is unique, we offer a complete and comprehensive range of services all the way through consulting, planning, financing, implementation, training, servicing, maintenance and support. Choose exactly what's right for you, when and where you need it.

> Professional Services

Tailor-made design, installation and project management of audio-visual and IT (AV/IT) systems using skills developed over 25 years of systems integration.

> Financial Services

Innovative and flexible finance solutions designed to meet budgetary and financial requirements and constraints, enabling businesses to always have the most current technology.

> Training Services

A range of off-the-shelf or customised training services from basic operation through to high-level technical maintenance.

> Support Services

Fully integrated and customised support for products and systems throughout their operational life, combining proactive and reactive technical services.

Not all services are available in all countries. If you'd like to find out more about what we do, who we do it for and how we do it, visit www.sonybiz.net or contact Sony's local office.

© 2008 Sony Corporation. All rights reserved.

Reproduction in whole or in part without written permission is prohibited. Features and specifications are subject to change without notice.

All non-metric weights and measurements are approximate. Sony, Memory Stick and HDVS are trademarks of Sony Corporation.

CA HDC Family/GB- /03/2008

Free Manuals Download Website

<http://myh66.com>

<http://usermanuals.us>

<http://www.somanuals.com>

<http://www.4manuals.cc>

<http://www.manual-lib.com>

<http://www.404manual.com>

<http://www.luxmanual.com>

<http://aubethermostatmanual.com>

Golf course search by state

<http://golfingnear.com>

Email search by domain

<http://emailbydomain.com>

Auto manuals search

<http://auto.somanuals.com>

TV manuals search

<http://tv.somanuals.com>