

Multi-Profile HQ1 CCD Box Type Network Camera

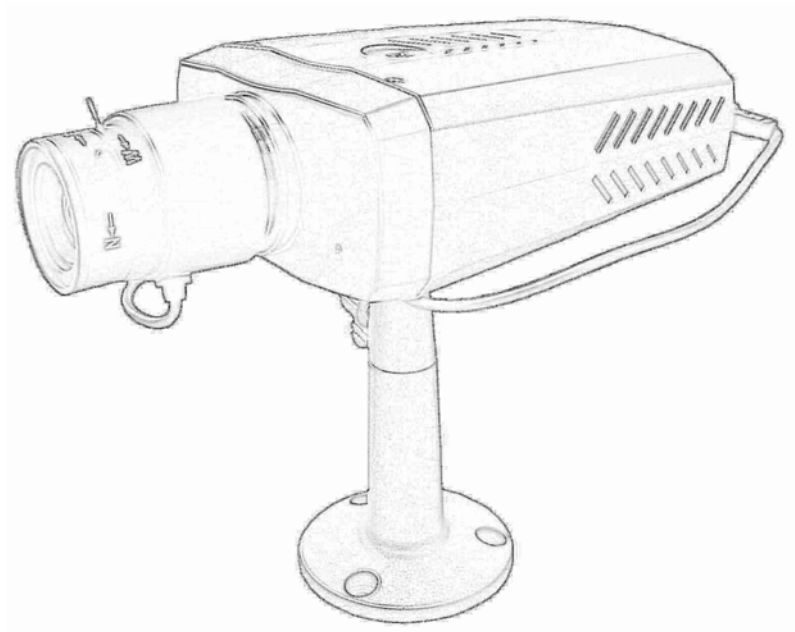

User's Manual

Firmware Version 3.0.2

Owner's Record

The model and serial numbers are located at the bottom of device. Record these numbers in the spaces provided below. Refer to these numbers whenever you call upon your dealer regarding this product.

Model No. _____

Serial No. _____

WARNING

To prevent fire or shock hazard, do not expose the unit to rain or moisture.

For AC Adaptor to avoid electrical shock, do not open the cabinet. Refer servicing to qualified personnel only.

Notice: The changes or modifications not expressly approved by the party responsible for compliance could void the user's authority to operate the equipment.

For customers in the U.S.A.

This equipment has been tested and found to comply with the limits for a digital device, pursuant to Part 15 of the FCC Rules. These limits are designed to provide reasonable protection against harmful interference in a residential installation. This equipment generates, uses, and can radiate radio frequency energy and, if not installed and used in accordance with the instructions, may cause harmful interference to radio communications. However, there is no guarantee that interference will not occur in a particular installation. If this equipment does cause harmful interference to radio or television reception, which can be determined by turning the equipment off and on, the user is encouraged to try to correct the interference by one or more of the following measures:

- Reorient or relocate the receiving antenna.
- Increase the separation between the equipment and receiver.
- Connect the equipment into an outlet on a circuit different from that to which the receiver is connected.
- Consult the dealer or an experienced radio/TV technician for help.

You are cautioned that any changes or modifications not expressly approved in this manual could void your authority to operate this equipment.

The shielded interface cable recommended in this manual must be used with this equipment in order to comply with the limits for a digital device pursuant to Subpart B of Part 15 of FCC Rules.

Declaration of Conformity

This device complies with part 15 of the FCC Rules. Operation is subject to the following two conditions:

- (1) this device may not cause harmful interference, and
- (2) this device must accept any interference received, including interference that may cause undesired operation.

IMPORTANT NOTE: To comply with the FCC RF exposure compliance requirements, no change to the antenna or the device is permitted. Any change to the antenna or the device could result in the device exceeding the RF exposure requirements and void user's authority to operate the device.

NOTICE TO USERS

© 2006~8 All rights reserved. This manual or the software described herein, in whole or in part, may not be reproduced, translated or reduced to any machine readable form without prior written approval.

WE PROVIDES NO WARRANTY WITH REGARD TO THIS MANUAL, THE SOFTWARE OR OTHER INFORMATION CONTAINED HEREIN AND HEREBY EXPRESSLY DISCLAIMS ANY IMPLIED WARRANTIES OF MERCHANTABILITY OR FITNESS FOR ANY PARTICULAR PURPOSE WITH REGARD TO THIS MANUAL, THE SOFTWARE OR SUCH OTHER INFORMATION. IN NO EVENT SHALL WE BE LIABLE FOR ANY INCIDENTAL, CONSEQUENTIAL OR SPECIAL DAMAGES, WHETHER BASED ON TORT, CONTRACT, OR OTHERWISE, ARISING OUT OF OR IN CONNECTION WITH THIS MANUAL, THE SOFTWARE OR OTHER INFORMATION CONTAINED HEREIN OR THE USE THEREOF.

We reserve the right to make any modification to this manual or the information contained herein at any time without notice. The software described herein may also be governed by the terms of a separate user license agreement.

Table of Contents

<i>Overview</i>	6
Introduction.....	6
Features	6
Minimum System Requirements.....	7
<i>Package Contents</i>	8
<i>Physical Description</i>	9
<i>Install the Camera in LAN</i>	11
<i>Preparation</i>	13
Search and Set up by IPWizard.....	13
Search.....	13
Wizard.....	14
Using UPnP of Windows XP or Vista.....	17
Install the Device behind a NAT Router	18
Access the device from the Internet Explorer for the first time.....	19
Logging in as an User	20
Logging in as an Administrator.....	20
<i>Operating the Network Camera</i>	21
Monitor Image Section	21
Video Profile	21
Streaming Protocol.....	22
Language.....	22
De-Interlace.....	22
2-Way Audio	22
Vertical Flip.....	22
Status Bar	23
ActiveX Control.....	23
Digital Zoom	24
Record	24
Snapshot.....	25
Voice	25
Statistics	26
About.....	27
<i>Administrrating the Device</i>	28
System Setting	28
Network: Configure Network settings	28
Network.....	28
DDNS service	30
PPPoE	31
Streaming	33
UPnP	33
IP Filter	35
IP Notification.....	35
Camera: Adjust Camera parameters.....	38

Picture	38
System: Configure and maintain system.....	39
System.....	39
Date & Time.....	40
Maintenance.....	42
Video: Configure profile.....	44
Common.....	44
MPEG4/VGA.....	44
MPEG4/QVGA.....	45
MPEG4/QQVGA.....	46
Video/JPEG.....	47
Audio: Audio parameters.....	49
User: Manage user name, password and login privilege	50
E-Mail: Setup E-Mail configuration	51
Object detection: Setup Object detection.....	53
Event Server: Setup FTP/TCP/HTTP server configuration.....	54
FTP Server	54
TCP Server.....	55
HTTP Server	55
Event Schedule: Configure the event schedule.....	57
<i>Appendix A: Restore Factory Default Settings</i>	<i>58</i>
<i>Appendix B: Alarm I/O Connector</i>	<i>59</i>
<i>Appendix C: Troubleshooting & Frequently Asked Questions</i>	<i>61</i>
<i>Appendix D: PING IP Address</i>	<i>65</i>
<i>Appendix E: Bandwidth Estimation.....</i>	<i>66</i>
<i>Appendix F: Specifications</i>	<i>67</i>
<i>Appendix G: Configure Port Forwarding Manually</i>	<i>69</i>
<i>Appendix H: DDNS Application</i>	<i>72</i>
<i>Appendix I: Power Line Frequency</i>	<i>78</i>
<i>Appendix J: 3GPP.....</i>	<i>79</i>
<i>Appendix K: Enable UPnP of Windows XP</i>	<i>80</i>

Overview

This user's guide explains how to operate the Network Camera from a computer. User should read this manual completely and carefully before you operate the device.

Introduction

This camera is an inexpensive and fully scalable surveillance device. Because the Network Cameras can be plugged into your existing local area network (LAN), you will potentially save thousands of dollars from unnecessary cabling.

The device is accessible via the LAN or Internet connection. Connect your device directly to a local area network or xDSL modem, and with Microsoft® Internet Explorer you get instant, on demand video streams. Within minutes you can set up the device to capture a video sequence to a PC. The live video can be uploaded to a website for the world to see.

Features

- **Superior quality SONY HQ1 1/3" CCD, 540TVL**
- **CS mount for camera lens**
- **DC Iris control**
- **Composite video output**
- **Easy installation with setup wizard**
- **Dynamic IP Service, DIPS®, to search your IP camera from Internet easily**
- **MPEG4 and JPEG video compression simultaneously**
- **Multi-profile encoder**
- **UDP / TCP / HTTP protocols selectable**
- **802.3af PoE support (option)**
- **3GPP for 3G mobile remote application**
- **30 fps for all resolutions**
- **Two-way audio**
- **Digital zoom**
- **Built-in and external microphone**
- **Sensor input and alarm output**
- **Intelligent motion detection**
- **Voice alerting while motion triggered**





- **Image transmission using an FTP or e-mail for event**
- **DDNS and PPPoE**
- **Support UPnP device discovery and NAT router transversal**
- **Multi-channel control software for surveillance application**
- **On-line firmware upgrade**

Minimum System Requirements

- **Microsoft Internet Explorer 6.0 or later**
- **VGA Monitor resolution 1024 x 768 or higher**
- **Pentium-4, 2.0 GHz or higher**
- **Memory Size: 512MB or more**
- **Windows 2000, XP, Vista**

Package Contents

User can find the following items in the package:

Item	Descriptions
	1. This Unit is the main element of the product.
	2. Camera Mount Kit and pads
	3. Power Adapter dedicates 12V DC electric power output to Network Camera.
	4. User's Manual CD provides important information and instructions for operating the Network Camera..
	5. Quick Start Guide provides important information and instructions for installing this device.

If any of the above items are missing, please contact your dealer immediately.

Note: Using a power supply with a different voltage than the one included with the Network Camera will cause damage and void the warranty for this product.

Physical Description

Front View

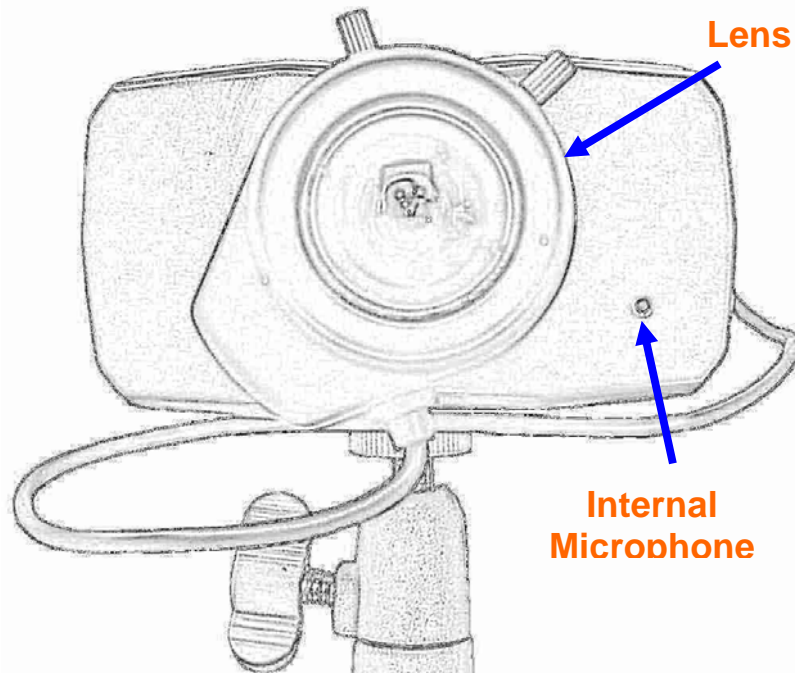

Lens

User could adjust the focus to get the best picture quality.

Internal Microphone

The Camera has built-in an internal microphone. This microphone is hidden in the pinhole located on the front panel.

Rear View

Audio Output Jack

Audio-out Jack allows this device to output audio for two-way communication or alerting sound.

DC Power Jack

The input power is 12VDC. **Note** that supply the power to the Camera with the power adapter included in package. Otherwise, the improper power adapter may damage the unit and result in danger.

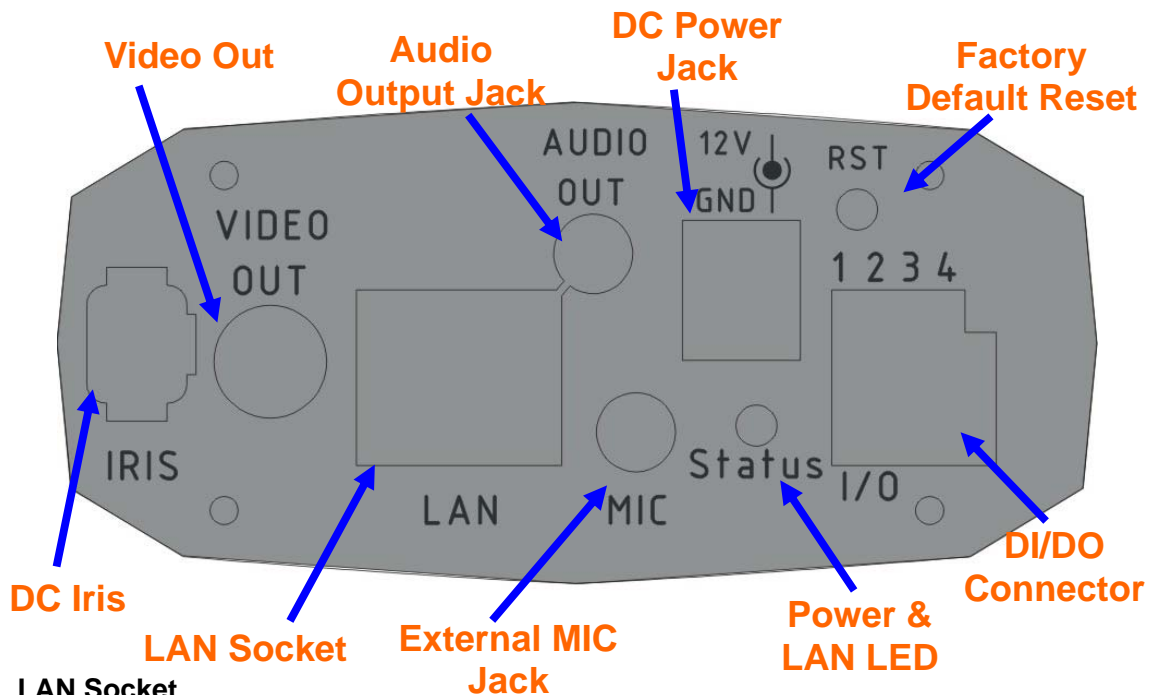

LAN Socket

The LAN socket is a RJ-45 connector for connections to 10Base-T Ethernet or 100Base-TX Fast Ethernet cabling. This Ethernet port built N-Way protocol can detect or negotiate the transmission speed of the network automatically. Please use Category 5 “straight through” cable to connect the Network Camera to a 100Mbps Fast Ethernet network switch or hub. **Note** that, in case you need to connect the device to PC or notebook directly, you should use “cross-over” cable instead.

Factory Default Reset

This button is hidden in the pinhole. Please refer to the Appendix A in this manual for more information.

Power & LAN LED (green color)

This LED is used to indicate whether DC power is on or not. In addition, this LED will be flashing while network accessing via Ethernet.

DI/DO Connector

The Camera provides a terminal block with 4 pins of connectors for DI and DO. Please refer to the Appendix B in this manual for more information.

External Microphone

The Camera also supports external microphone. User can plug in an external microphone to pick up voice more.

Local Video Output (RCA connector)

The Camera also provides composite video output. User can use cable to connect the Camera with a TV monitor or VCR.

DC Iris

The Camera provides Iris control interface which can connect to DC-driver Iris lens.

Install the Camera in LAN

- 1. Attach the Camera with the included stand**
- 2. Fix camera to desired location with stand**

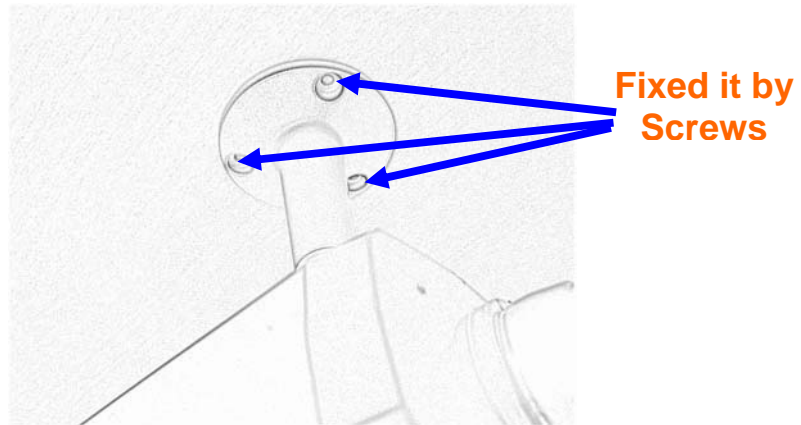

- 3. Plug an Ethernet cable into the Camera**

Connect an Ethernet cable to the LAN socket located on the camera's rear and attach it to the network.

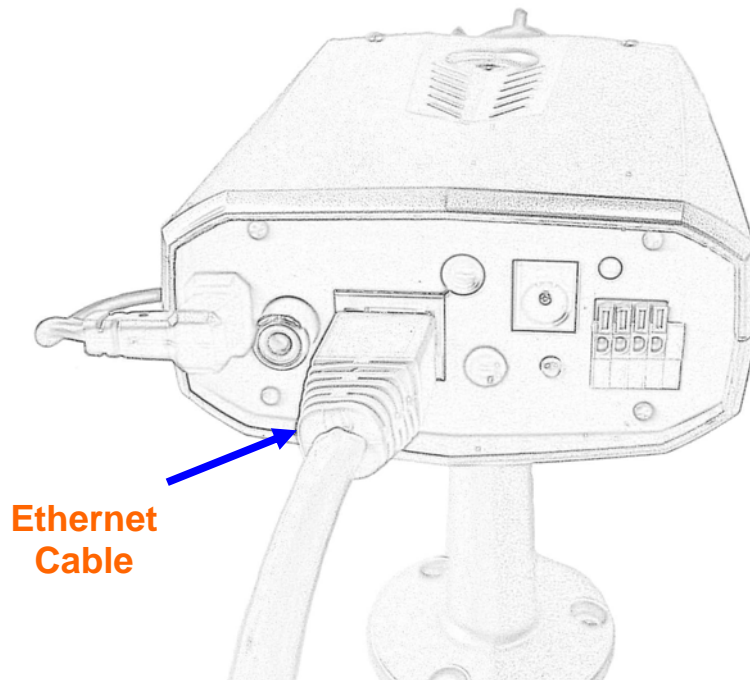

4. Connect the external power supply to Camera

Connect the attached power adapter to the DC power jack of the camera. **Note:** Use the power adapter, 12VDC, included in the package and connect it to wall outlet for AC power.

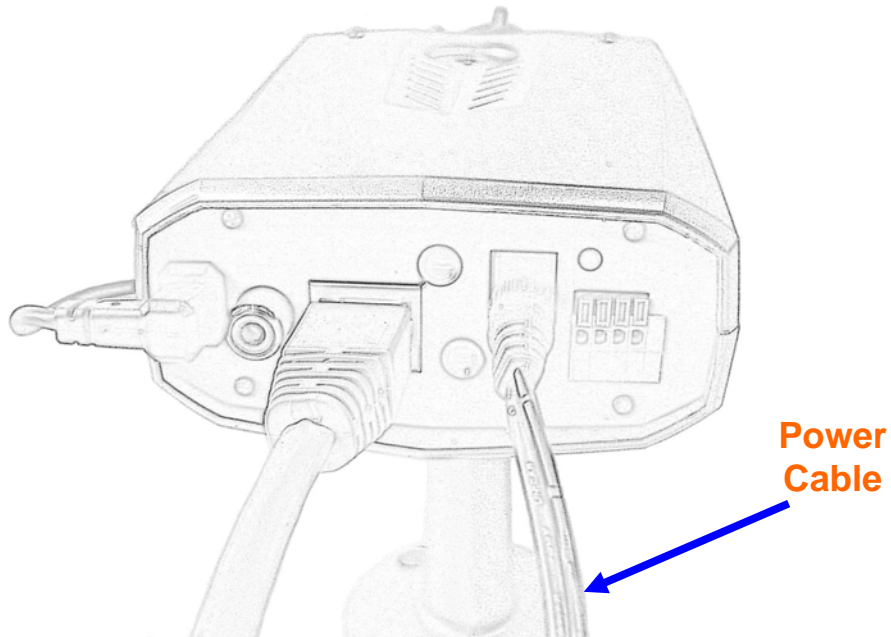

Once you have installed the camera well and powered it on, the power LED will turn on. It means the system is booting up successfully. Furthermore, if you have a proper network connection, and access to the camera, the LED will flash green under wired mode.

5. Done

Preparation

Search and Set up by IPWizard

When you installed the Camera on a LAN environment, you have two easy ways to search your Cameras by IPWizard or UPnP discovery. Here is the way to execute IPWizard to discover Camera's IP address and set up related parameter in a Camera.

Search

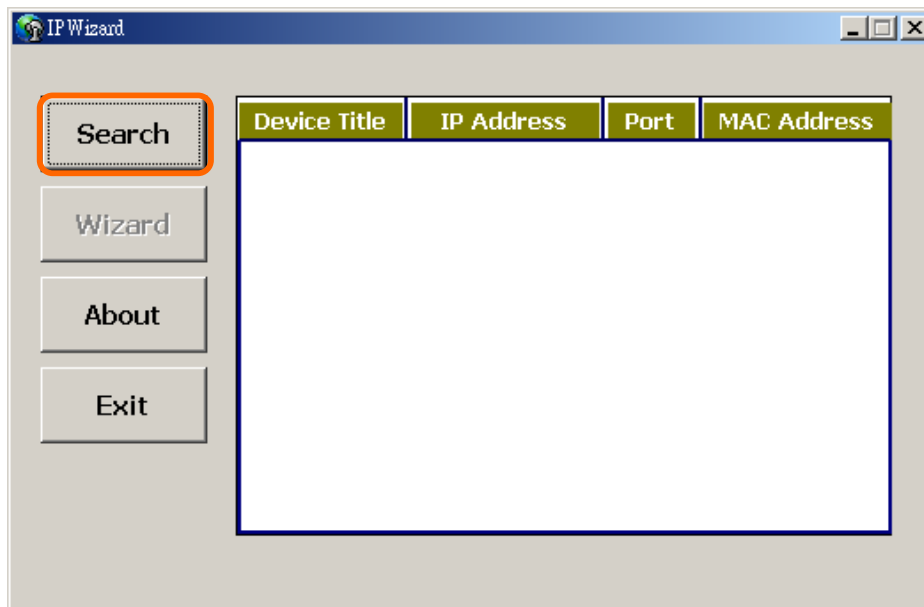

When click **Search** button, a searching window will pop up. IPWizard is starting to search Network Cameras on the LAN. The message "No Network Camera Is Found" will appear on this window if IPWizard can not find any device on the LAN. Otherwise, existed devices will be listed as below.

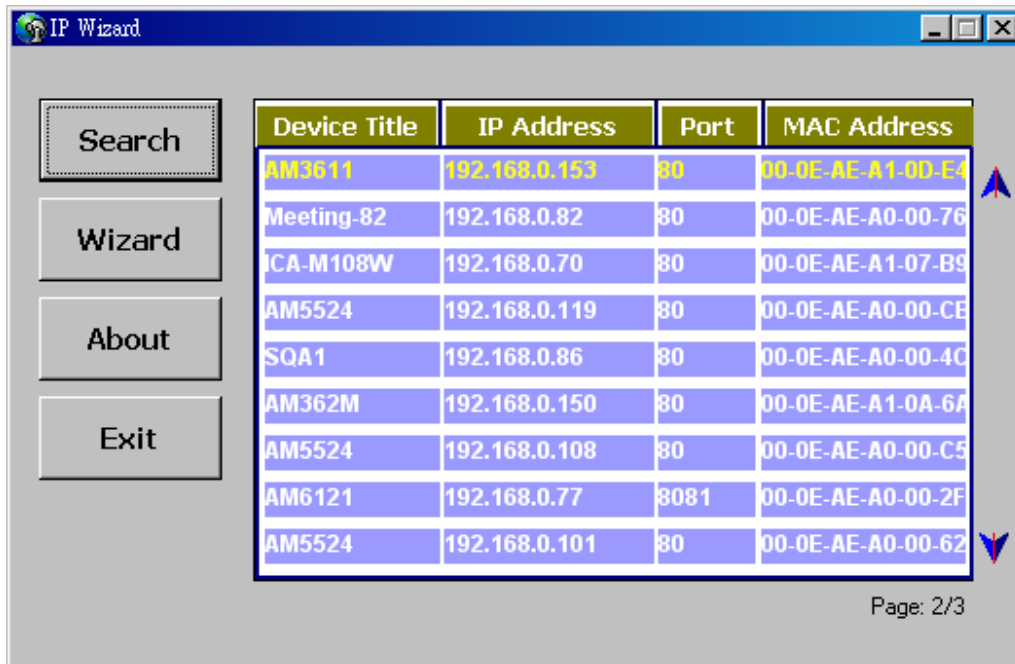

If IPWizard finds network devices, **Wizard** button will be available. Please select the device you want to set-up or connect and click the left button of the mouse on the Information Box. The words on the Information Box will turn from white to yellow which means this device is selected. Or you could double click the left button to connect to the network device. Relative settings will be carried out after you press Installation **Wizard**. Details of Installation **Wizard** will be specified as below.

Wizard

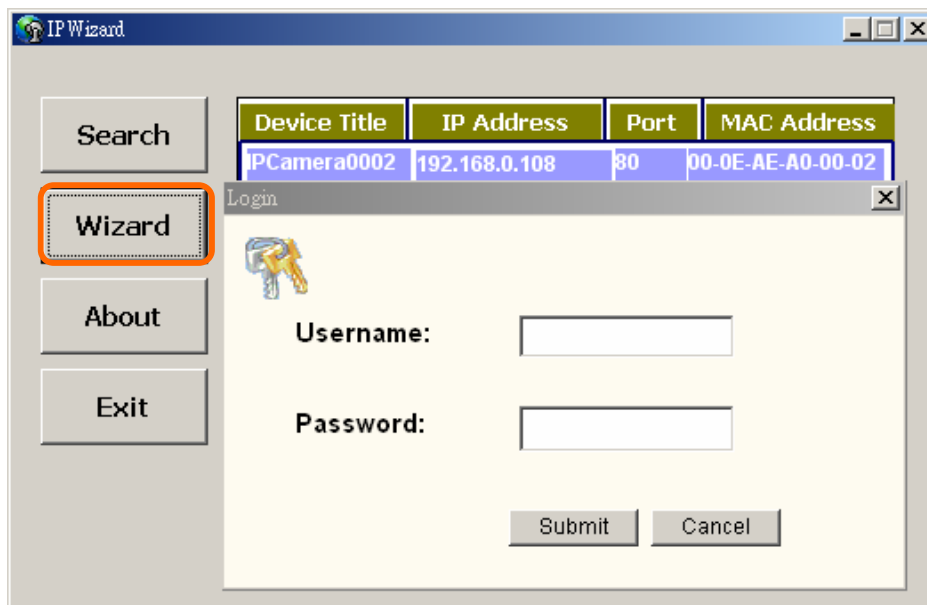

When Wizard button is available, you can proceed to set up relative settings on the selected device. Further procedures can be carried out when device is available on the LAN.

After pressing Installation Wizard, please key in authorized username of the device and password when login dialog box appears on the screen. You can login the setting page if authorized name and password is approved.

Wizard page 1: Username and Password

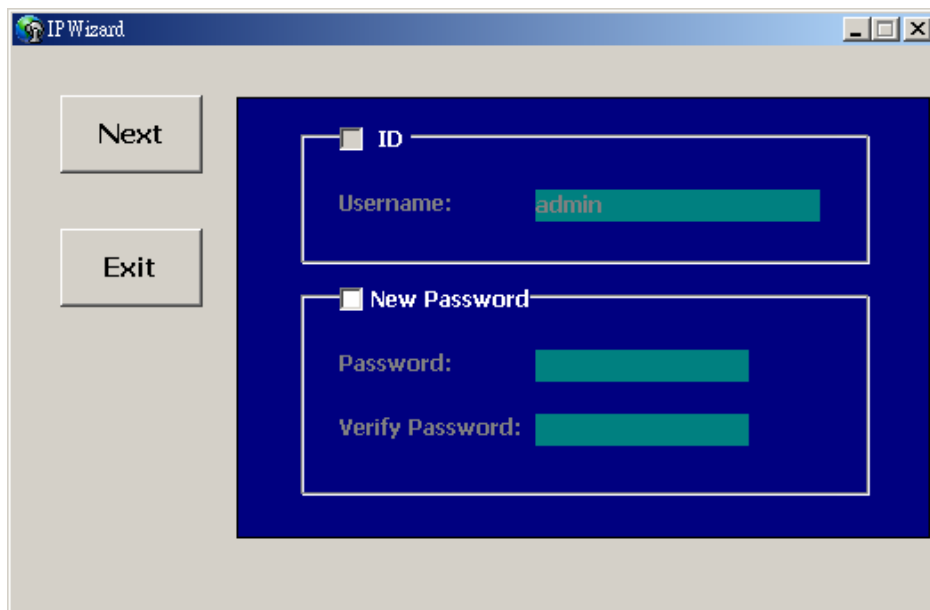

This page is about the change of the authorized name and password of the selected device. If you don't want to change them for the time being, please click on "Next" to move to the next page. Press "Exit" button if you don't want to set up right now. If you want to change authorized username or password, you have to click on the box. Authorized username should contain at least 5~20 characters and password should contain at least 4~8 characters.

Wizard page 2: LAN Setting

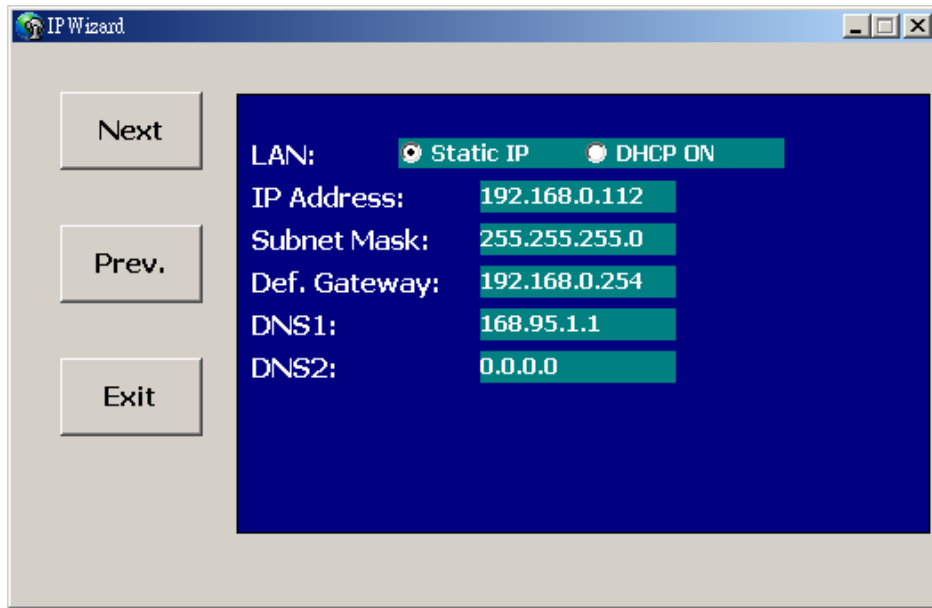

Wizard page 3: Confirmation

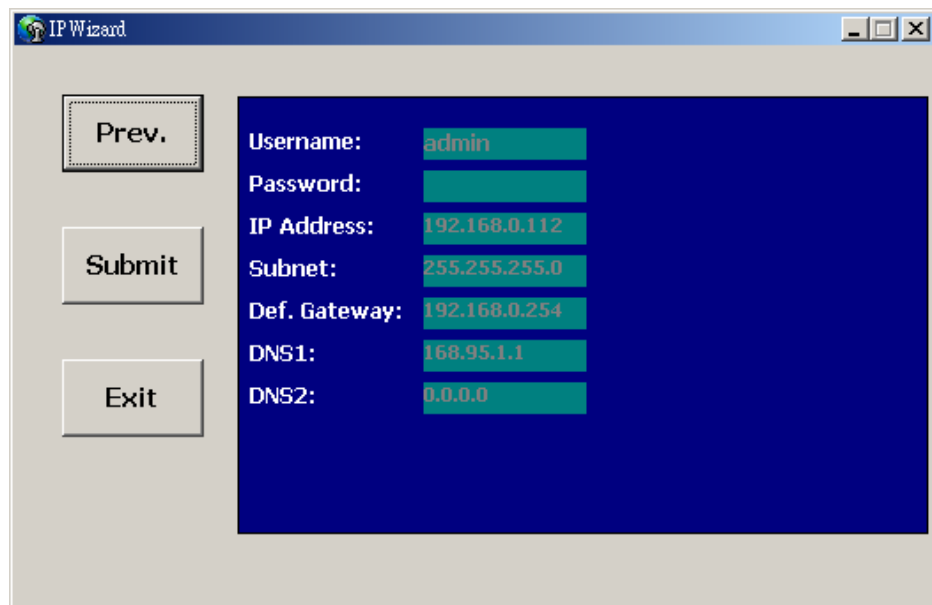

This page shows the information of the selected device to check if there is any mistake or not. If it is correct, please press "Submit" button and the setting information will be uploaded to the selected device. Click on "Exit" button if you don't want to set it up; Click on "Prev." button to go back to the previous page for the modification.

Using UPnP of Windows® XP or Vista

UPnP™ is short for Universal Plug and Play, which is a networking architecture that provides compatibility among networking equipment, software, and peripherals. This device is an UPnP enabled device. If the operating system, Windows XP or Vista, of your PC is UPnP enabled, the Network Camera will be very easy to be found.

Please refer to Appendix K to enable UPnP settings only if your operating system of PC is running Windows XP.

Note: Windows 2000 does not support UPnP feature.

To discover your device, go to your Desktop and click **My Network Places**.

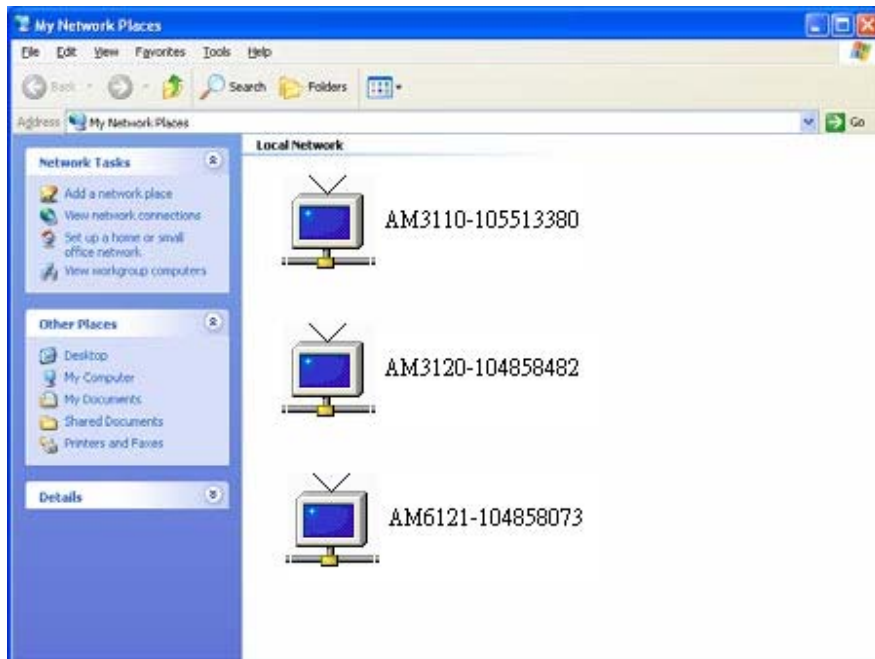

Click the targeted **Device**. Then Internet Explorer will connect to this Network Camera automatically.

Install the Device behind a NAT

Router

Once installed, the device is accessible on your LAN. To access the device from the Internet you must configure your broadband router to allow incoming data traffic to the device. If the device is installed on the LAN with a router, then it may get a dynamic IP address from the DHCP server. However, if the device wants to be accessed from the WAN, its IP address needs to be setup as fixed IP, also the port forwarding or Virtual Server function of router needs to be setup.

However, if your NAT router supports UPnP feature, it can be very easy to achieve NAT traversal automatically. To do this, enable the NAT-traversal feature, which will attempt to automatically configure the router to allow access to the camera.

Installing the device with an UPnP router on your network is an easy 3-step procedure:

- (1) Enable UPnP option of your NAT router
- (2) Enable UPnP NAT traversal option of the Network Camera
- (3) Access your Network Camera by DIPS

(1) Enable UPnP option of your NAT router

To use UPnP IGD function (NAT traversal), you need to make sure the UPnP function is enabled in your router. Most new home routers should support this function. Some of routers are default enable and others are not. Please check user's manual of your NAT router for detail.

(2) Enable UPnP NAT traversal option of the Network Camera

Refer to **Setting → Network → UPnP** page for detail NAT traversal setting.

(3) Access your Network Camera by DIPS

Refer to **Setting → System → System** page for detail DIPS information.

Access the device from the Internet Explorer for the first time

1. Start the web browser on the computer and type the IP address of the Camera you want to monitor as below:

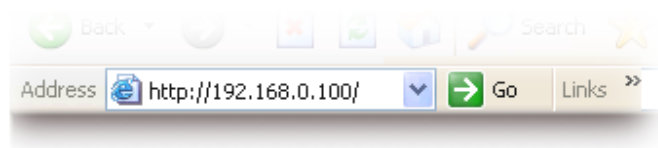

The Login Window of the Camera is prompted:



2. Type in your login name and password under "USERNAME" and "PASSWORD" textbox.

For the first time use (default value), input the

User Name: **admin**

Password:

That's, type in "**admin**" on the "USERNAME" as a default name and leave PASSWORD textbox blank. Click "OK" button to start the main menu.

3. According your browser's security setting, the IE Web Page may prompt the "Security Warning" window. If so, select "Yes" to install and run the ActiveX control into your PC. Otherwise, the system will load the ActiveX silently.
4. After the ActiveX control was installed and ran, the first image will be displayed.



Logging in as an User

If you log in the Camera as an ordinary User, "Setting" function will be not accessible.

Logging in as an Administrator

If you log in the Camera as the Administrator, you can perform all the settings provided by the device.

Operating the Network Camera

Start-up screen will be as follow no matter an ordinary users or an administrator.

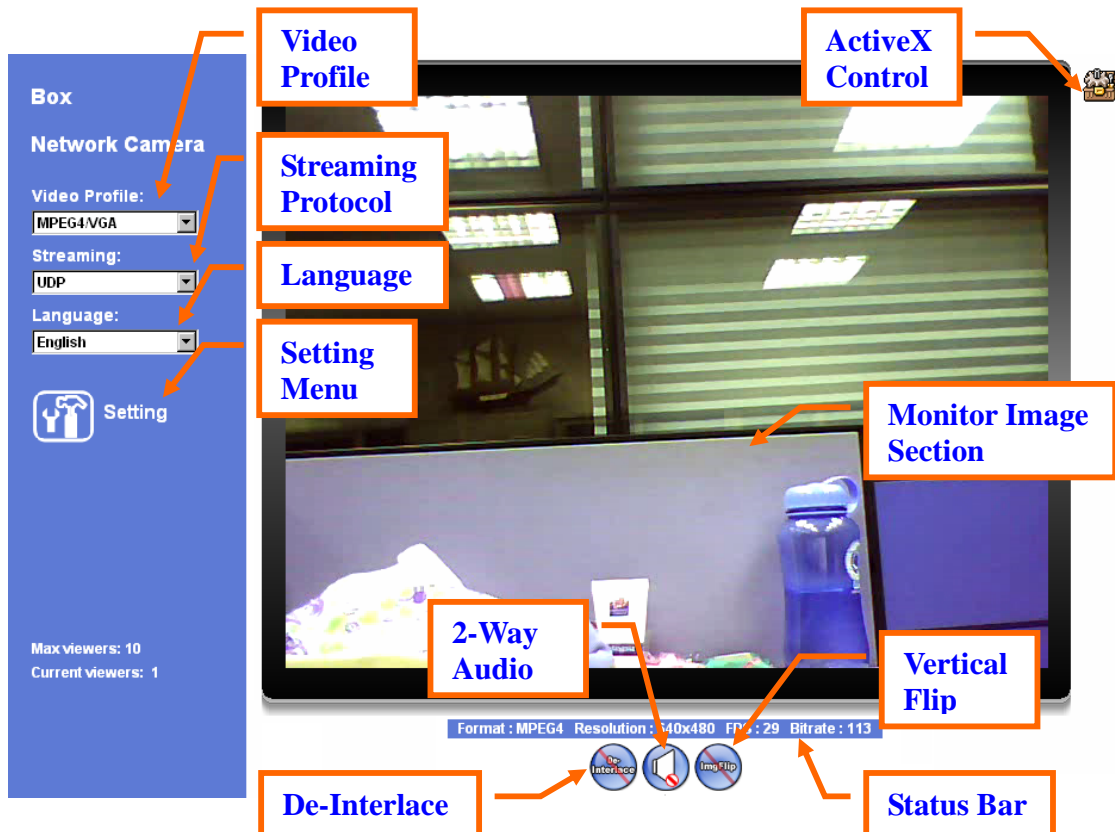

Monitor Image Section

The image shot by the device is shown here. The date and time are displayed at the top of the window.

Video Profile

The device supports either mega-pixel or multi-profile mode for both MPEG4 and JPEG simultaneously. User can chose the proper and/or preferred profile which is listed here.

Streaming Protocol

User can select proper streaming protocol according to networking environment.

Language

The device could provide multiple languages to meet customer's requirement.

De-Interlace

The device also supports de-interlace function inside ActiveX. User can chose to enable or disable this function by toggling the icon below.



: Disable de-interlace function.



: Enable de-interlace function.

2-Way Audio

The device supports 2-way audio function. User can chose to enable or disable this function by toggling the icon below.



: Disable audio uploading function.



: Enable audio uploading function.

Vertical Flip

According to camera position, user might need this function to correct the view angle avoiding upside down. User can chose to enable or disable this function by toggling the icon below.



: Disable vertical flip function.



: Enable vertical flip function.

Status Bar

Shows information of the connected device such as encoder format, image resolution, frame per second, and bitrate.

ActiveX Control

The plug-in ActiveX control supports a lot of functions by clicking the left mouse button. Note that this feature only supports on the ActiveX control within Microsoft® Internet Explorer.

On the ActiveX control icon, click the LeftMouseButton, then a menu pop-up. This menu provides features that are unique to the ActiveX control. These features include:

- *“Digital Zoom”*,
- *“Record”*,
- *“Snapshot”*,
- *“Voice”*,
- *“Statistics”*,
- *“About”*

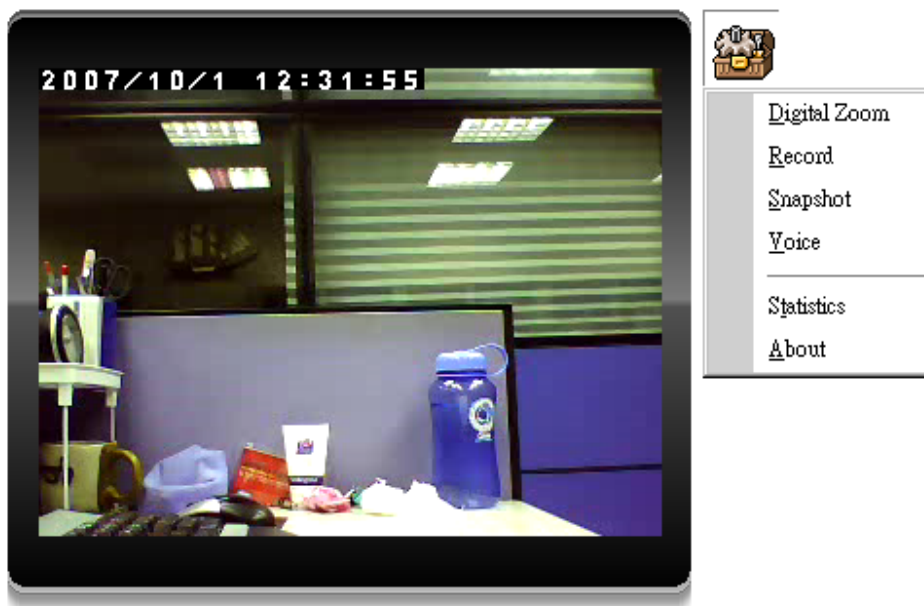

Digital Zoom



Click **Digital Zoom** to activate this function as above. User can drag or scale the box over the video to adjust zoom ratio and position.

Record

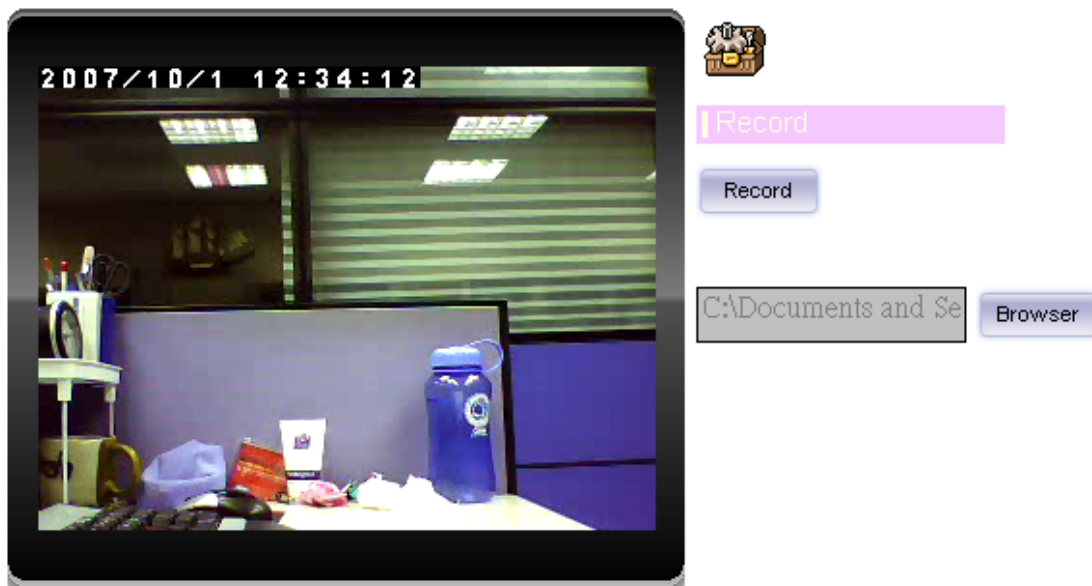

Click **Record** to activate this function. Press **Record** button to start recording. The video file is saved as ASF format into your local PC. While you want to stop it, press **Stop** to stop recording. Select **Browser**, the pop-up window to select the save path and file name prefix, select **OK** to continue.

After stop recording, list the files, this file is named as Video_yyyymmddhhmmss.asf

The ASF files can be display by the standard Windows Media Player, but it needs the DixectX 9.0 or later version to be installed.

Snapshot

Click **Snapshot** to activate this function. Press **Snapshot** button to take a picture. The image file is saved as JPEG format into your local PC. Select **Browser**, the pop-up window to select the save path and file name prefix, select **OK** to continue.

If you like to retrieve the saved image, select the file to display the saved image by using any one of graph editing tools.

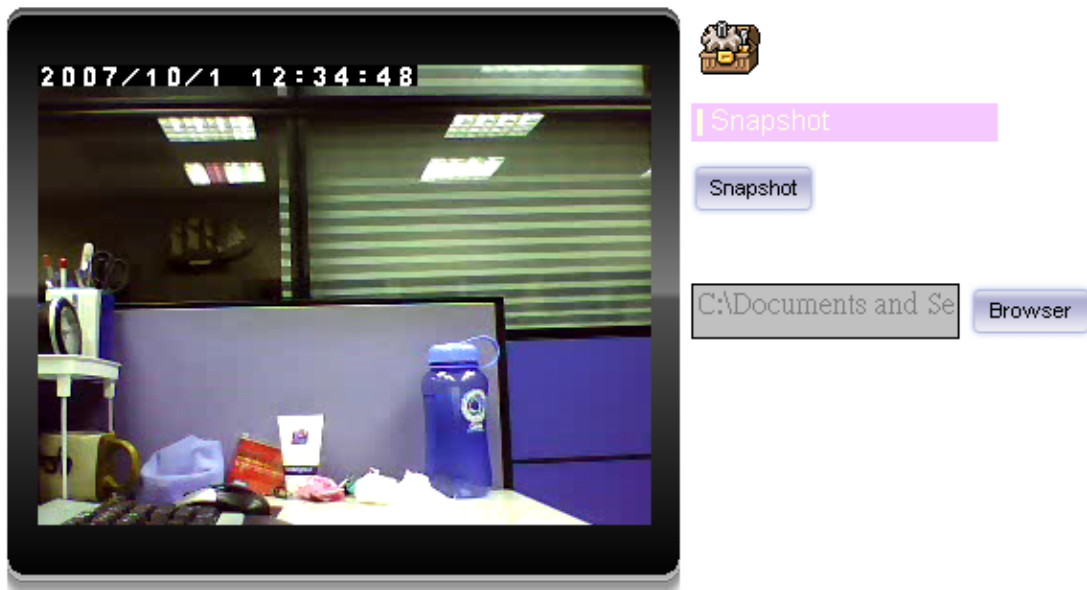

Voice

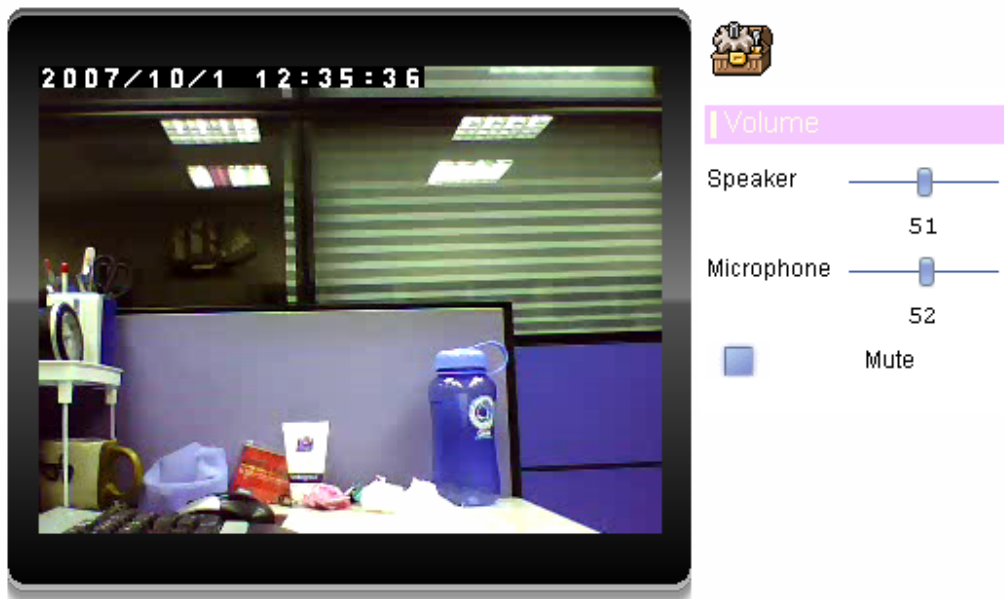

Click **Volume** to activate this function. There are two control bars for speaker and microphone volume respectively. Scroll these control bars to adjust the audio attribute. Check the volume mute will mute the speaker output.

Statistics

Click **Statistics** to activate this function. A window will be popup to show the statistics information of the streaming status. **Note** that this information is the statistics between the device and your local PC.

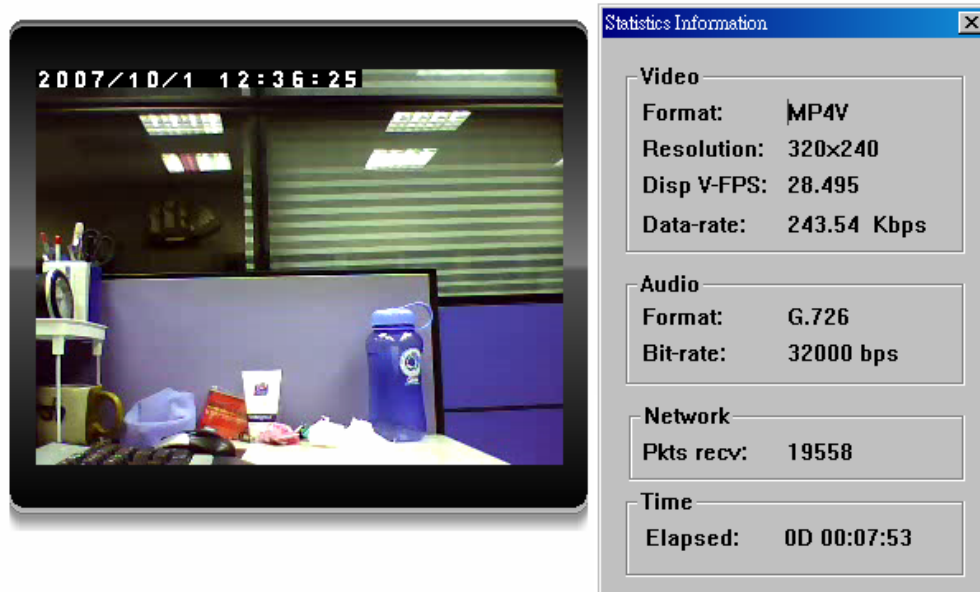

About

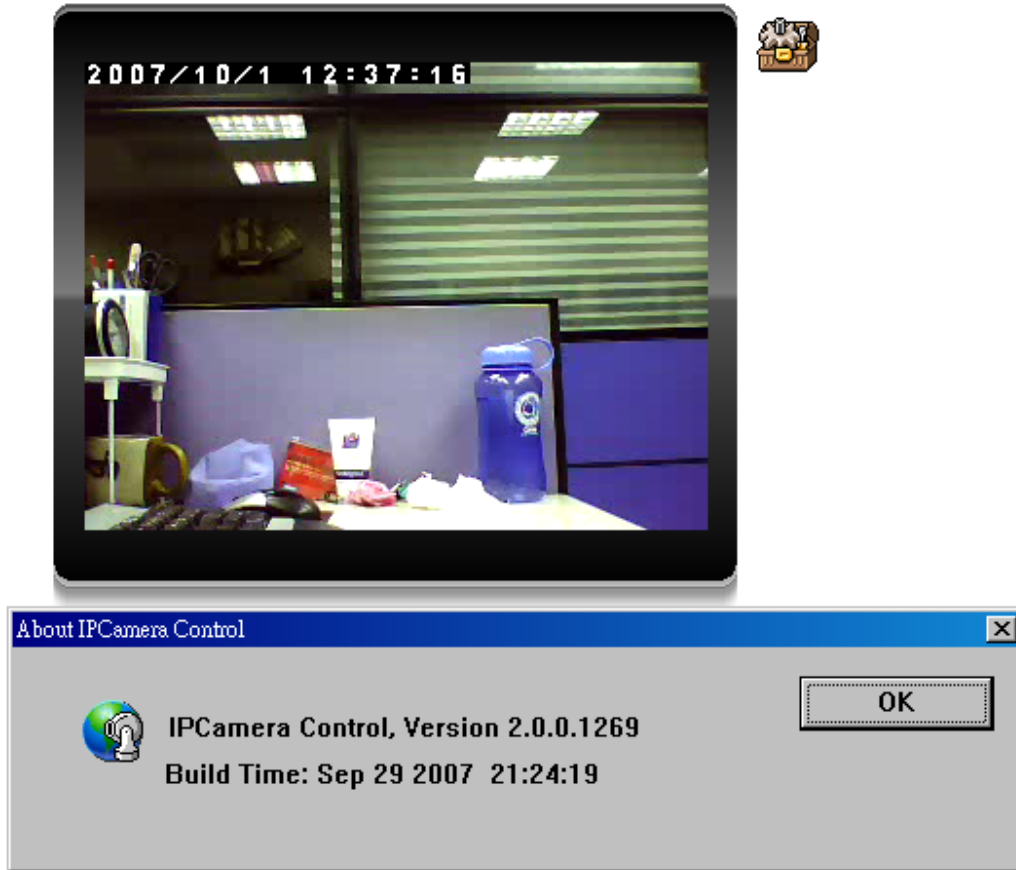

Click **About** to show this ActiveX information.

Administering the Device

System Setting

This function is only available for user logged into Camera as administrator.

Click on each menu name to display its setting page.

Item	Action
Network	Configure Network settings such as DHCP, DDNS, 3GPP, PPPoE and UPnP
Camera	Adjust camera parameters
System	Configure system information, date & time, maintenance, and view system log file.
Video	Configure bit rate and frame rate of video profiles
Audio	Configure audio parameters, 2-way audio
User	Setup user name, password and login privilege
E-Mail	Setup E-Mail configuration
Object Detection	Setup Object detection
Event Server	Setup FTP/TCP/HTTP server for event
Event Schedule	Configure the schedule while event triggered

Network: Configure Network settings

Use this menu to configure the network to connect the device and the clients.

Network

This section provides the menu for connecting the device through Ethernet cable.

Network DDNS PPPoE Streaming UPNP IP Filter IP Notification

MAC Address 00:0E:AE:A0:00:2F

Obtain IP address automatically (DHCP)

IP Address 192.168.0.77 Test

Subnet Mask 255.255.255.0

Gateway 192.168.0.254

Obtain DNS from DHCP

Primary DNS 168.95.1.1

Secondary DNS

HTTP Port 8081 (1 to 65535)

OK Cancel

MAC address:

Displays the Ethernet MAC address of the device. Note that user can not change it.

Obtain IP address automatically (DHCP):

DHCP: Stands for Dynamic Host Configuration Protocol.

Enable this checked box when a DHCP server is installed on the network to issue IP address assignment. With this setting, the IP address is assigned automatically. If this device can not get an IP address within limited tries, the device will assign a default IP address, 192.168.0.100, by itself as the default IP address.

IP address, Subnet mask, and Gateway:

If you do not select **Obtain an IP address automatically**, then you need to enter these network parameters manually.

Obtain DNS from DHCP:

DNS: Stands for Domain Name System.

Enable this checked box when a DHCP server is installed on the network and provide DNS service.

Primary DNS and Secondary DNS:

If you do not select **Obtain DNS from DHCP**, then you need to enter these parameters manually.

HTTP Port:

The device supports two HTTP ports. The first one is default port 80 and this port is fixed.

This port is very useful for Intranet usage. The second HTTP port is changeable. Users could assign the second port number of http protocol, and the WAN users should follow the port number to login. If the http port is not assigned as 80, users have to add the port number in back of IP address. For example: <http://192.168.0.100:8080>.

Therefore, the user can access the device by either

<http://xx.xx.xx.xx/>, or

<http://xx.xx.xx.xx:xxxx/> to access the device.

If multiple devices are installed on the LAN and also required to be accessed from the WAN, then the **HTTP Port** can be assigned as the virtual server port mapping to support multiple devices.

Click "OK" to save and enable the setting.

DDNS service

DDNS: Stands for Dynamic Domain Name Server

Your Internet Service Provider (ISP) provides you at least one IP address which you use to connect to the Internet. The address you get may be static, meaning it never changes, or dynamic, meaning it's likely to change periodically. Just how often it changes, depends on your ISP. A dynamic IP address complicates remote access since you may not know what your current WAN IP address is when you want to access your device over the Internet. One of the possible solutions to the dynamic IP address problem comes in the form of a dynamic DNS service.

A dynamic DNS service is unique because it provides a means of updating your IP address so that your listing will remain current when your IP address changes. There are several excellent DDNS services available on the Internet. One such service you can use is www.DynDNS.org. You'll need to register with the service and set up the domain name of your choice to begin using it. Please refer to the home page of the service for detailed instructions or refer to Appendix H for more information.

If your device is connected to xDSL directly, you might need this feature. However, if your device is behind a NAT router, you will not need to enable this feature because your NAT router should take care of this job. As to xDSL environment, most of the users will use dynamic IP addresses. If users want to set up a web or a FTP server, then the Dynamic Domain Name Server is necessary.

Network **DDNS** PPPoE Streaming UPNP IP Filter IP Notification

DDNS Disable Enable

Server Name

DDNS Host (1 ~ 30 Digits)

User Name (< 21 Digits)

Password (< 21 Digits)

DDNS:

To enable or disable the DDNS service here.

Server name:

Choose the built-in DDNS server.

DDNSHost:

The domain name is applied of this device.

User name:

The user name is used to log into DDNS.

Password:

The password is used to log into DDNS.

PPPoE

PPPoE:

PPPoE: Stands for Point to Point Protocol over Ethernet

A standard builds on Ethernet and Point-to-Point network protocol. It allows your device with xDSL or cable connects with broadband network directly, then your device can dial up and get a dynamic IP address. For more PPPoE and Internet configuration, please consult your dealer or ISP.

The device can directly connect to the xDSL, however, it should be setup on a LAN environment to program the PPPoE information first, and then connect to the xDSL modem. Power on again, then the device will dial on to the ISP connect to the WAN through the xDSL modem.

The procedures are

- Connect to a LAN by DHCP or Fixed IP
- Access the device, enter **Setting** → **Network** → **PPPoE** as below

Network DDNS **PPPoE** Streaming UPNP IP Filter IP Notification

PPPoE Disable Enable

User Name (< 21 Digits)

Password (< 21 Digits)

IP Address

Subnet Mask

Gateway

Status Disconnect

OK Cancel

PPPoE:

To enable or disable the PPPoE service here.

User name:

Type the user name for the PPPoE service which is provided by the ISP.

Password:

Type the password for the PPPoE service which is provided by the ISP.

IP address, Subnet mask, and Gateway (read only):

Shows the IP information got from PPPoE server site.

Status:

Shows the Status of PPPoE connection.

Streaming

RTSP is a streaming control protocol, and a starting point for negotiating transports such as RTP, multicast and Unicast, and for negotiating codecs. RTSP can be considered a "remote control" for controlling the media stream delivered by a media server. RTSP servers typically use RTP as the protocol for the actual transport of audio/video data.

RTSP Port:

Choose the RTSP port. The RTSP protocol allows a connecting client to start a video stream. Enter the RTSP port number to use. The default value is 554.

RTP Port:

Specify the range of transmission port number of video stream. The default range is 50000 to 50999. User can specify a number between 1024 and 65535.

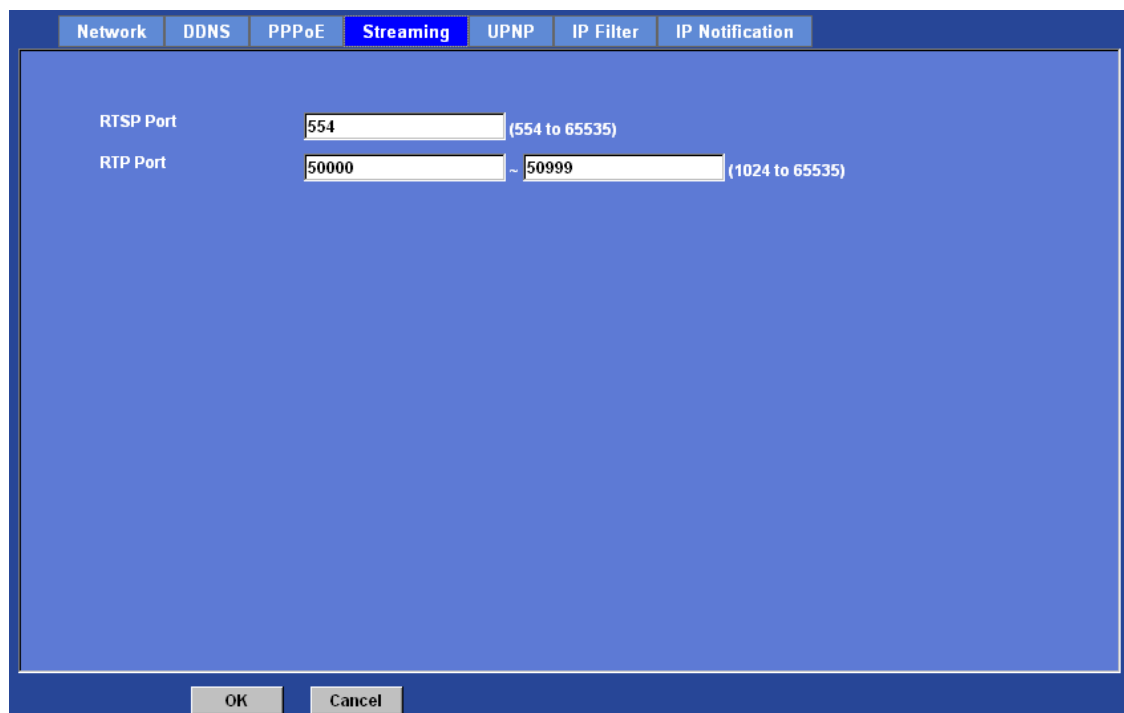

The screenshot shows a configuration window with a blue background and a dark blue border. At the top, there is a horizontal menu with tabs: Network, DDNS, PPPoE, Streaming (highlighted in blue), UPnP, IP Filter, and IP Notification. Below the menu, there are two input fields. The first is labeled "RTSP Port" and contains the value "554", with a range "(554 to 65535)" to its right. The second is labeled "RTP Port" and contains the range "50000 ~ 50999", with a range "(1024 to 65535)" to its right. At the bottom of the window, there are two buttons: "OK" and "Cancel".

UPnP

UPnP is short for Universal Plug and Play, which is a networking architecture that provides compatibility among networking equipment, software, and peripherals. This device is an UPnP enabled Network Camera. If your operating system is UPnP enabled,

the device will automatically be detected and a new icon will be added to "My Network Places." If you do not want to use the UPnP functionality, it can be disabled.

In addition, this device also provides UPnP IGD function for NAT traversal easily. Use NAT traversal when your device is located on an intranet (LAN) and you wish to make it available from the other (WAN) side of a NAT router. With NAT traversal properly configured, all HTTP traffic to an external HTTP port in the NAT router will be forwarded to the device.

The screenshot shows the UPnP configuration page. The top navigation bar includes tabs for Network, DDNS, PPPoE, Streaming, UPnP (selected), IP Filter, and IP Notification. The main content area is blue and contains the following settings:

- UPnP:** Radio buttons for Disable and Enable.
- Friendly Name:** AM6121-v3-N-104858073
- UPnP NAT Traversal:** Radio buttons for Disable and Enable.
- Port Range:** Input fields for 32768 and 65535, with a note (1 ~ 65535).
- External IP Address:** An empty input field with (readonly) text.

At the bottom of the page are two buttons: OK and Cancel.

UPnP:

To enable or disable the UPnP service here.

Friendly Name:

Shows the friendly name of this device here.

UPnP NAT Traversal

When enabled, the device will attempt to configure port mapping in a NAT router on your network, using UPnP™. **Note** that UPnP™ must be enabled in the NAT router first.

Port Range:

The port range will open in NAT router.

External IP address:

Show the IP address and port for WAN access through Internet. If NAT traversal is configured successfully, user can use this IP address and port to access this device.

IP Filter

You can enter different user's IP address which are allowing enter or denying by the device.

IP Filter:

To enable or disable the IP filter function here.

IP Filter Policy:

Choose the filter policy where is denying or allowing.

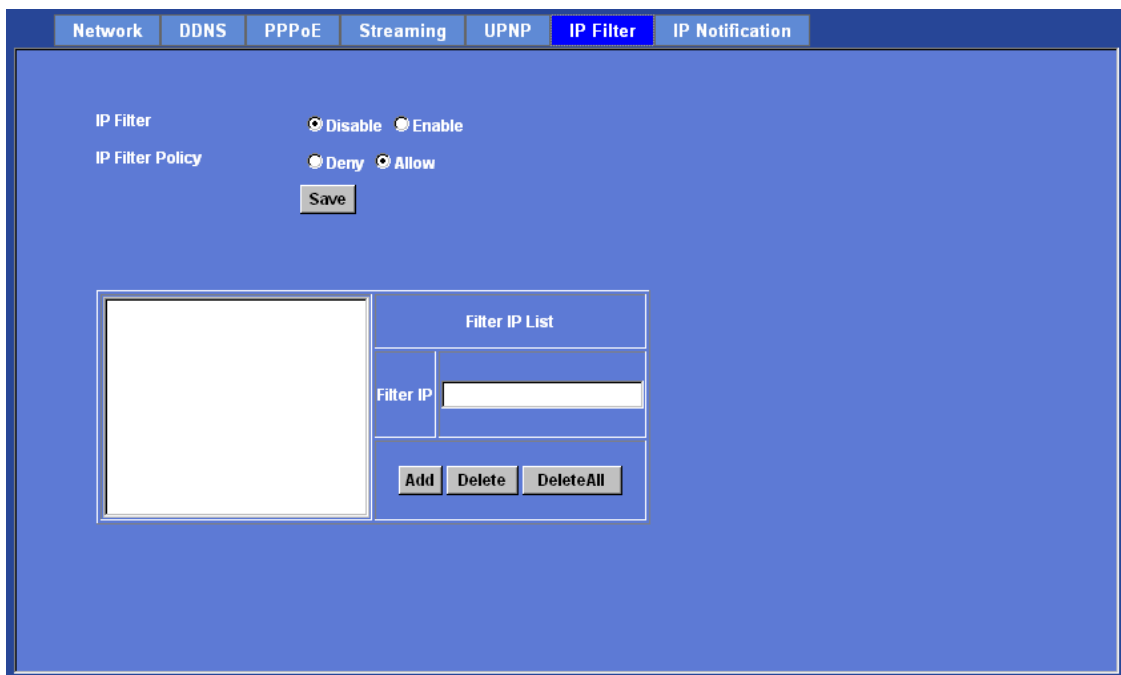

The screenshot shows a web interface for configuring the IP Filter. At the top, there is a navigation bar with tabs for Network, DDNS, PPPoE, Streaming, UPNP, IP Filter (selected), and IP Notification. The main content area has a blue background. On the left, there are two sections: 'IP Filter' with radio buttons for 'Disable' (selected) and 'Enable', and 'IP Filter Policy' with radio buttons for 'Deny' and 'Allow' (selected). Below these is a 'Save' button. In the center, there is a 'Filter IP List' section. It consists of a large empty table on the left and a form on the right. The form has a 'Filter IP' input field and three buttons: 'Add', 'Delete', and 'DeleteAll'.

IP Notification

In case the IP address is changed, system is able to send out an email to alert someone if the function is enabled.

SMTP Notification (e-mail):

If enable this function, then the "Send to" and "Subject" fields need to be filled.

Send To:

Type the receiver's e-mail address. This address is used for reply mail.

Subject:

Type the subject/title of the E-mail.

Network DDNS PPPoE Streaming UPNP IP Filter **IP Notification**

SMTP Notification(email) Disable Enable

Send To

Subject

TCP Notification Disable Enable

TCP Server

TCP Port (1 ~ 65535)

Message:

HTTP Notification Disable Enable

URL (<60 Digits)

HTTP Login Name (<21 Digits)

HTTP Login Password (<21 Digits)

Proxy Address

Proxy Port (1 ~ 65535)

Proxy Login Name (<21 Digits)

Proxy Login Password (<21 Digits)

Custom parameters:

Message:

OK Cancel

TCP Notification:

If enable this function, then the “**TCP Server**“, “**TCP Port**“, and “**Message**” fields need to be filled.

TCP Server:

Type the server name or the IP address of the TCP server.

TCP Port:

Set port number of TCP server.

Message:

The message will be sent to FTP server.

HTTP Notification:

If enable this function, then the fields below need to be filled.

URL:

Type the server name or the IP address of the HTTP server.

HTTP Login name:

Type the user name for the HTTP server.

HTTP Login Password:

Type the password for the HTTP server.

Proxy Address:

Type the server name or the IP address of the HTTP Proxy.

Proxy Port:

Set port number of Proxy.

Proxy Login name:

Type the user name for the HTTP Proxy.

Proxy Login Password:

Type the password for the HTTP Proxy.

Custom parameter:

User can set specific parameters to HTTP server.

Message:

The message will be sent to HTTP server.

Camera: Adjust Camera parameters

Use this menu to set the functions of the camera parameters of the device.

Picture

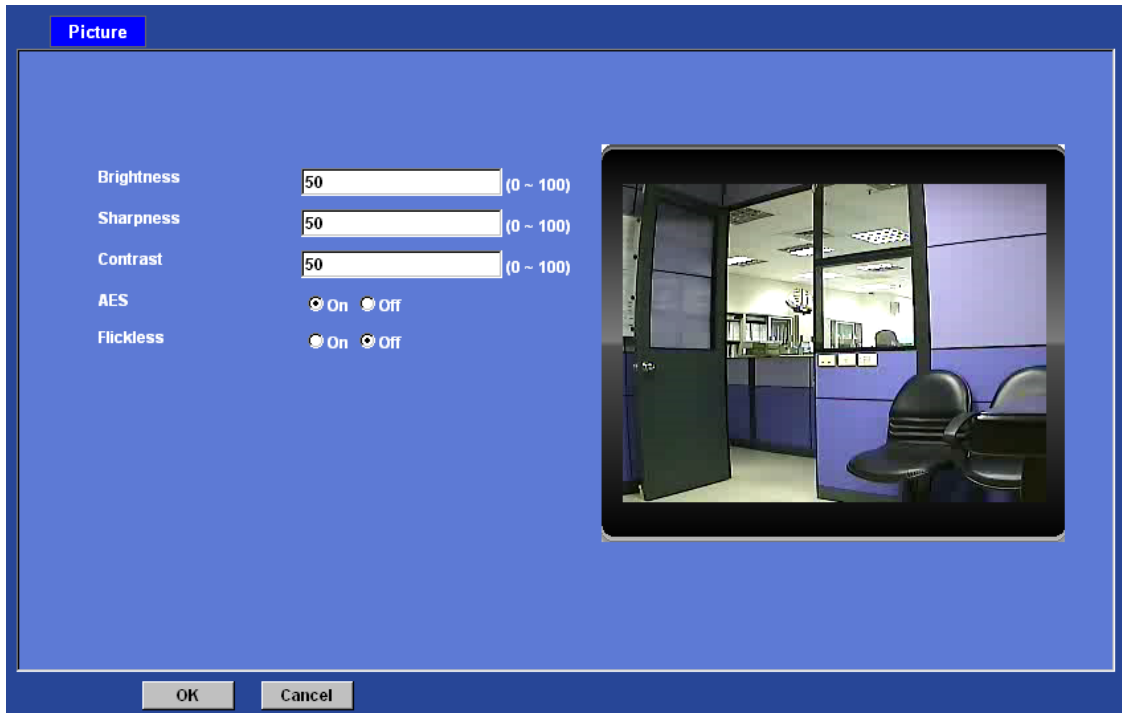

Brightness:

Large value will brighten camera.

Sharpness:

Large value will sharpen camera.

Contrast:

Large value will contrast camera heavily.

AES:

Enable or disable AES mode of CCD module.

Flickless:

Enable or disable Flickless mode of CCD module.

System: Configure and maintain system

Use this menu to perform the principal settings of the device.

System:

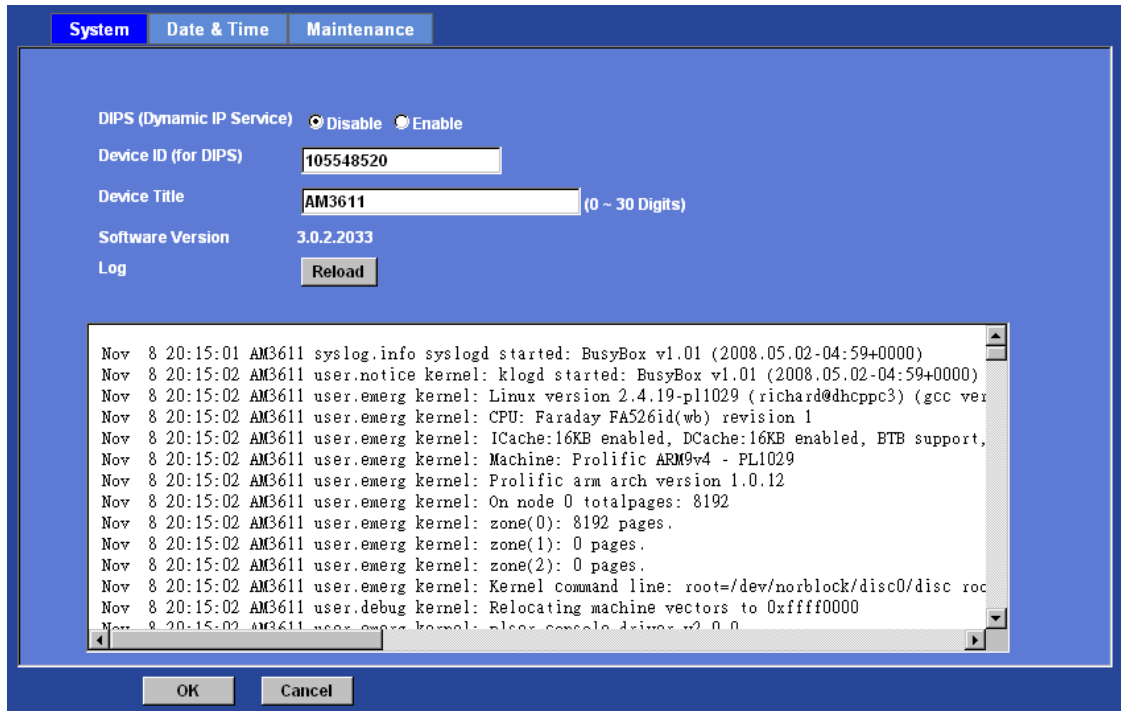

DIPS (Dynamic IP Service):

To enable or disable the DIPS® (Dynamic IP Service) function.

Device ID (for DIPS):

It's a unique number of each device for identification and this ID is used for DIPS.

In the Appendix H, it describes how to locate your device from Internet by DDNS service. However, we provide another easier way to do the same job called Dynamic IP Service, DIPS®.

To use this service, just follow four steps below:

- (1) Enable DIPS function of the device
- (2) Check your Device ID from this page. This is a unique number for each device.
- (3) If your device is behind a NAT router, please configure your device properly. You could refer to section "Install the Camera behind a NAT Router" above. You only need to do this job one time.
- (4) Check the web site: <http://www.a-mtk.com/>

You can find web page as below:



Enter your Device Number and press “OK” button.

Then, a new web page will pop up and link to your device accordingly.

You will see that DIPS is a much easier service than DDNS.

Device Title:

You can enter the name of this unit here. It's very useful to identify the specific device from multiple units. The information will be shown on IPWizard once the device is found.

Software Version:

This information shows the software version of the device.

Log:

User can check the system log information of the device, including the *Main Info*, *Appended Info*, *Operator IP*, and so on ...

Reload:

Click this button; user can refresh the log information of the device.

Date & Time

You can setup the device or make it synchronized with PC or remote NTP server. Also, you may select your time zone in order to synchronize time locally.

Server Date & Time:

Displays the date and time of the device.

PC Time:

Displays the date and time of the connected PC.

Adjust:

- Synchronize with PC:

Click this option to enable time synchronization with PC time.

- Manual setting:

Click this option to set time and date manually.

- Synchronize with NTP:

Click this option if you want to synchronize the device's date and time with those of time server called NTP server (Network Time Protocol).

NTP Server: Type the host name or IP address or domain name of the NTP server.

NTP sync. Interval: Select an interval between 1 and 23 hours at which you want to adjust the device's time referring to NTP server

Time zone:

Set the time difference from Greenwich Mean Time in the area where the device is installed.

Daylight Saving:

Disable or enable the daylight saving adjustment.

The screenshot shows a web interface for configuring the date and time. At the top, there are three tabs: 'System', 'Date & Time' (which is selected), and 'Maintenance'. The main content area is blue and contains the following settings:

- Server Date & Time:** 2007-10-01 17:06:55
- PC Time:** 2007-10-1 17:7:58
- Adjust:** Three radio buttons are present: 'Synchronize with PC' (selected), 'Manual setting : Date : 2007-8-20 Time : 00:00:00', and 'Synchronize with NTP'.
- NTP Server:** time.stdtime.gov.tw (with a 'Test' button next to it)
- NTP Sync. Interval:** 23 hour (dropdown menu)
- Timezone:** GMT+08 (Beijing, Hong Kong, Shanghai, Taipei) (dropdown menu)
- Daylight Saving:** Disable (selected) and Enable (radio buttons)
- Daylight Saving StartTime:** Jan 1 00:00:00
- Daylight Saving StopTime:** Jan 1 00:00:00
- Daylight Saving Offset:** 00:00:00

At the bottom of the page, there are two buttons: 'OK' and 'Cancel'.

Maintenance

Hard Factory Default (Include the network setting):

Recall the device hard factory default settings. Note that click this button will reset all device's parameters to the factory settings (including the IP address).

Factory Default (Except the network setting):

The unit is restarted and most current settings are reset to factory default values. This action will not reset the network setting.

Backup Setting:

To take a backup of all of the parameters, click this button. If necessary, it will then be possible to return to the previous settings, if settings are changed and there is unexpected behavior.

Restore Setting:

Click the "**Browse**" button to locate the saved backup file and then click the "**Restore Setting**" button. The settings will be restored to the previous configuration.

The screenshot shows a web interface with a blue header and a white content area. The header has three tabs: "System", "Date & Time", and "Maintenance" (which is selected). The content area contains several settings, each with a corresponding button:

- Hard Factory Default (Include the network setting)**: A button labeled "Hard Factory Default".
- Factory Default (Except the network setting)**: A button labeled "Factory Default".
- Backup Setting**: A button labeled "Backup Setting".
- Restore Setting**: A text input field, a "Browse" button, a "Restore Setting" button, and a "Reset" button.
- Firmware Upgrade**: A text input field, a "Browse" button, a "Firmware Upgrade" button, and a "Reset" button.
- System Restart**: A button labeled "Restart".

At the bottom of the page, there are two buttons: "OK" and "Cancel".

Firmware Upgrade:

The device supports new firmware upgrade (the software that controls the operation in the device). Please contact your dealer for the latest version if necessary.

Download the latest firmware file from our website or your dealer. Unzip this firmware file to binary file and store it into your PC. Then follow the steps as bellows carefully:

1. Close all other application programs which are not necessary for firmware update.

2. Make sure that only you access this device while firmware updating.

3. Disable Motion Detection function.

4. Click "**Browse**" button. Select the Firmware binary file. (**Note that it must make sure that the Firmware only applies to this device, once update, it will be burned into FLASH ROM of system.**)

5. Once the firmware file was selected, click "**Firmware Upgrade**" button.

6. The upgrade progress information will be displayed. Once the uploading process completed, the device will reboot the system automatically.

7. Please wait for timer countdown, and then you can use IPWizard to search the device again.

Warning!!! The download firmware procedure can not be interrupted. If the power and/or network connection are broken during the download procedure, it might possibly cause serious damage to the device.

Strongly suggest that DO NOT upgrade firmware via Wireless LAN due to high error rate possibly and don't allow any other clients to access this unit during updating procedure.

Be aware that you should not turn off the power during updating the firmware and wait for finish message.

Furthermore, the firmware upgrade procedure always is risk and do not try to upgrade new firmware if it's not necessary.

System Restart:

The device is restarted without changing any of the network settings. It means the IP address of the device will not change after firmware upgrade.

Video: Configure profile

This device provides 4 video profiles as below to support different request to each client simultaneously. Each user can choose his preferred video profile as his request independently.

Common

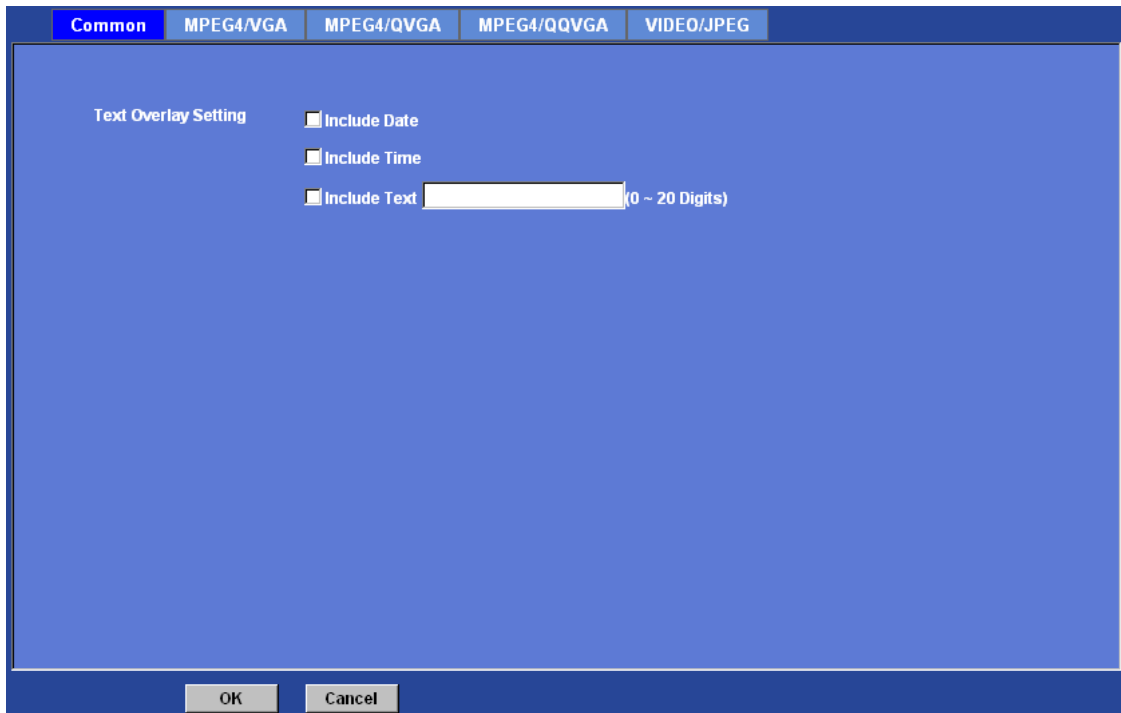

Text Overlay Setting:

There are some important information can be embedded into image, including date, time, and/or text.

Video Profile:

User can only choose either Multi-profile or Mega-pixel mode. Multi-profile mode can serve MPEG4/VGA, MPEG4/QVGA, MPEG4/QQVGA and one JPEG streams simultaneously. On the other hand, Mega-pixel mode can serve MPEG4/Mega and JPEG/Mega dual streams simultaneously.

MPEG4/VGA

Video Type:

It's a MPEG4 mode in this profile.

Resolution:

It's VGA mode (640x480) in this profile.

Rate Control:

Defines the rate control method of this profile. There are two options: Constant Bit Rate (CBR) or Variable Bit Rate (VBR). For CBR, the video bit rate is between 384kbps and 4096kbps. User can set the desired bit rate to match the limitation of bandwidth. For VBR, user should choose the quality level to set the video quality rather than bit rate. The quality level is between 1 and 100. The higher value is the better quality.

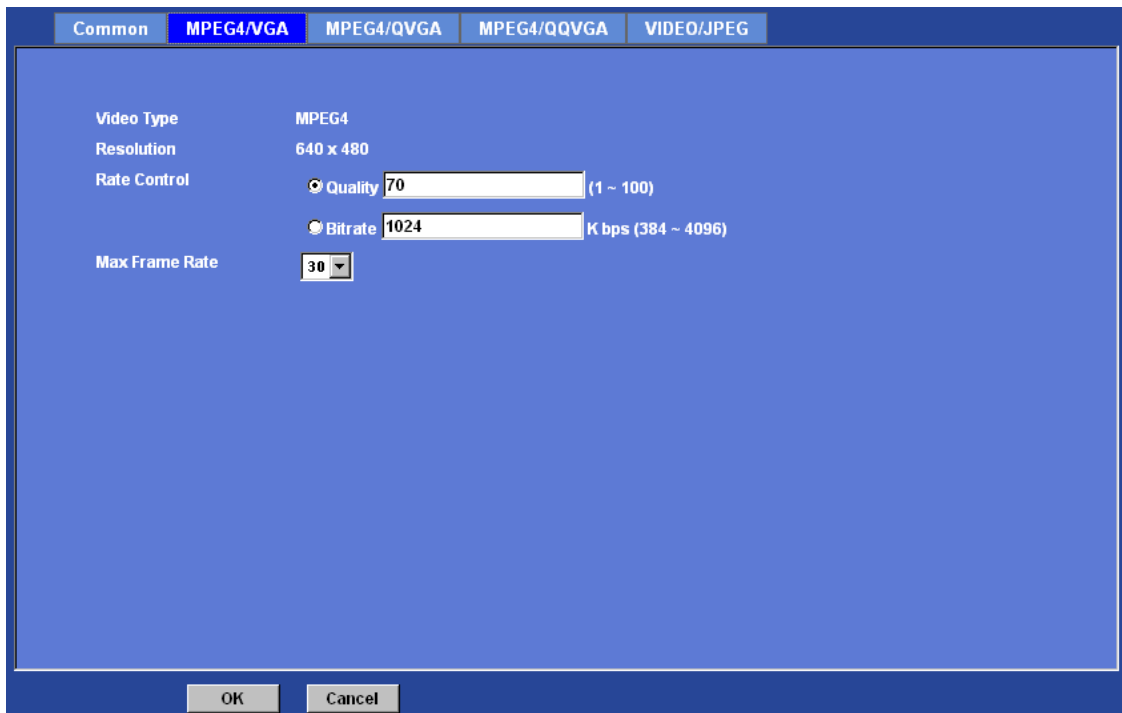

Max Frame Rate:

Defines the targeted frame rate of this profile. For example, set the frame rate to 15 fps, then the image will be updated for 15 frames per second as possible. User need to set reasonable max frame rate versus video quality under the limited bandwidth.

MPEG4/QVGA

Video Type:

It's a MPEG4 mode in this profile.

Resolution:

It's QVGA mode (320x240) in this profile.

Rate Control:

Defines the rate control method of this profile. There are two options: Constant Bit Rate (CBR) or Variable Bit Rate (VBR). For CBR, the video bit rate is between 128kbps and 1024kbps. User can set the desired bit rate to match the limitation of bandwidth. For VBR, user should choose the quality level to set the video quality rather than bit rate. The quality level is between 1 and 100. The higher value is the better quality.

The screenshot shows a configuration window with a blue background and a dark blue border. At the top, there are five tabs: 'Common', 'MPEG4/VGA', 'MPEG4/QVGA' (which is selected and highlighted in blue), 'MPEG4/QQVGA', and 'VIDEO/JPEG'. Below the tabs, the following settings are visible:

- Video Type:** MPEG4
- Resolution:** 320 x 240
- Rate Control:** Two radio buttons are present. The first is selected and labeled 'Quality' with a text input field containing '80' and '(1 ~ 100)' to its right. The second is labeled 'Bitrate' with a text input field containing '512' and 'K bps (128 ~ 1024)' to its right.
- Max Frame Rate:** A dropdown menu showing '30'.

At the bottom of the window, there are two buttons: 'OK' and 'Cancel'.

Max Frame Rate:

Defines the targeted frame rate of this profile. For example, set the frame rate to 15 fps, then the image will be updated for 15 frames per second as possible. User need to set reasonable max frame rate versus video quality under the limited bandwidth.

MPEG4/QQVGA

Video type:

It's a MPEG4 mode in this profile.

Resolution:

It's QQVGA mode (160x120) in this profile.

Rate Control:

Defines the rate control method of this profile. There are two options: Constant Bit Rate (CBR) or Variable Bit Rate (VBR). For CBR, the video bit rate is between 24kbps and 320kbps. User can set the desired bit rate to match the limitation of bandwidth. For VBR, user should choose the quality level to set the video quality rather than bit rate. The

quality level is between 1 and 100. The higher value is the better quality.

Max Frame Rate:

Defines the targeted frame rate of this profile. For example, set the frame rate to 15 fps, then the image will be updated for 15 frames per second as possible. User need to set reasonable max frame rate versus video quality under the limited bandwidth.

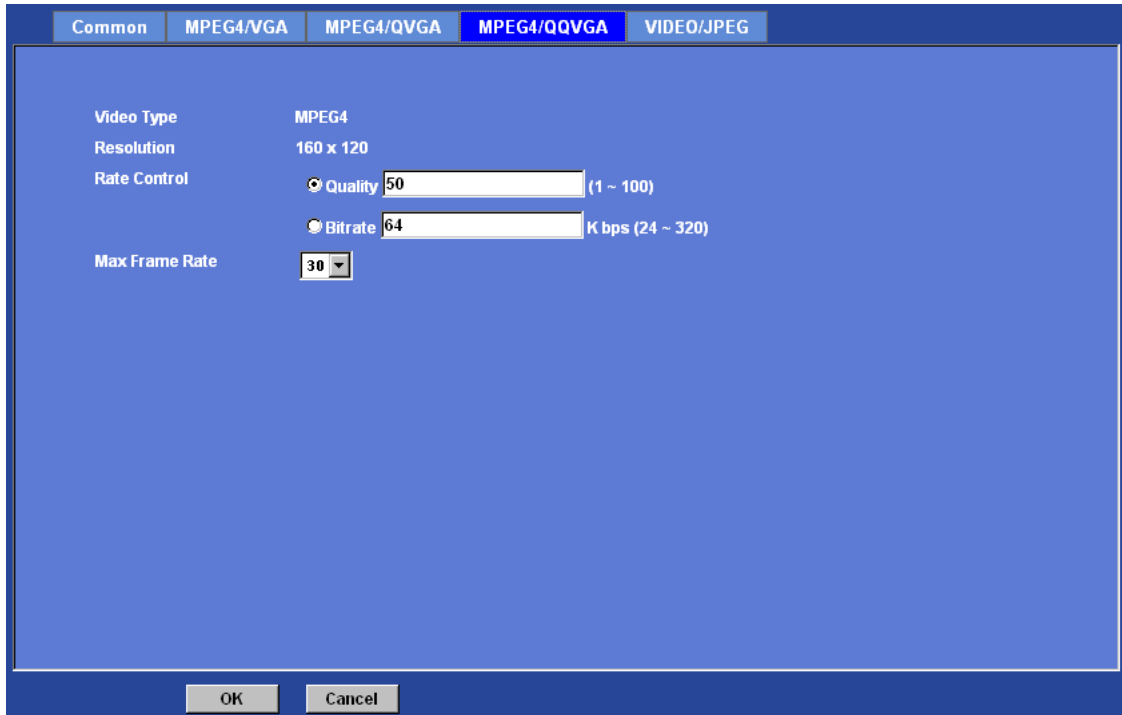

Video/JPEG

Video type:

It's JPEG mode in this profile.

Resolution:

User can select VGA, QVGA, or QQVGA mode as the resolution of this JPEG profile.

Rate Control:

The quality level is between 1 and 100. The higher value is the better quality.

Max Frame Rate:

Defines the targeted frame rate of this profile. For example, set the frame rate to 15 fps, then the image will be updated for 15 frames per second as possible. User need to set reasonable max frame rate versus video quality under the limited bandwidth.

The screenshot shows a configuration window with a blue background and a dark blue border. At the top, there are five tabs: 'Common', 'MPEG4/VGA', 'MPEG4/QVGA', 'MPEG4/QQVGA', and 'VIDEO/JPEG'. The 'VIDEO/JPEG' tab is selected and highlighted in a darker blue. Below the tabs, the following settings are visible:

- Video Type:** JPEG
- Resolution:** 640x480 (dropdown menu)
- Rate Control:** Quality 50 (input field) (1 ~ 100)
- Max Frame Rate:** 5 (dropdown menu)

At the bottom of the window, there are two buttons: 'OK' and 'Cancel'.

Audio: Audio parameters

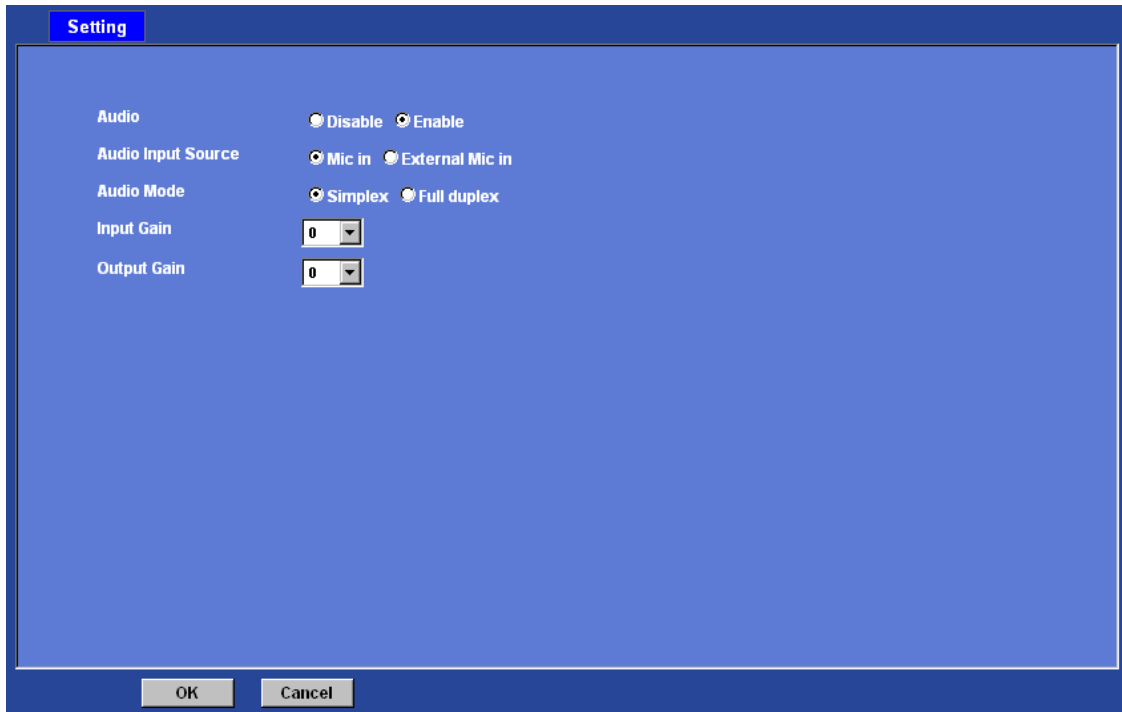

Audio:

To enable or disable audio function

Audio Input Source:

To select audio source from built-in MIC or external MIC.

Audio Mode:

To select Simplex or Full duplex (2-way audio) mode

Input Gain:

To adjust gain of input audio

Output Gain:

To adjust gain of output audio

User: Manage user name, password and login privilege

Use this menu to add, update, or remove the usernames and passwords of the Administrator and viewer.

Setting

Viewer login Anonymous Only users in database

User Name	Access Right	User List	
admin	administrator	User name	<input type="text"/> (1 ~ 20 Digits)
		Password	<input type="text"/> (0 ~ 12 Digits)
		Verify password	<input type="text"/> (0 ~ 12 Digits)
		Accee right	<input type="radio"/> Administrator <input checked="" type="radio"/> Viewer
		<input type="button" value="add"/> <input type="button" value="update"/> <input type="button" value="remove"/>	

Viewer login:

Select "Anonymous" to allow any one viewing the video once connected. Otherwise, only users in database can view the video after login.

Access right:

Administrator can access every function in this device. However, Viewers only can view the video and access limited function.

Add, update, and remove of Users account:

Manage the user's account of viewer user.

E-Mail: Setup E-Mail configuration

You may setup SMTP mail parameters for further operation of Event Schedule. That's, if users want to send the alarm message out, it will need to configure parameters here and also add at least one event schedule to enable event triggering.

The screenshot shows a configuration window titled "Setting" with a blue background. It contains the following fields and controls:

- SMTP Server:** A text input field followed by a "Test" button.
- SMTP Port:** A text input field containing the value "25".
- SMTP Authentication:** Two radio buttons, "Disable" (which is selected) and "Enable".
- Authentication User Name:** A text input field with a character limit of "< 64 Digits".
- Authentication Password:** A text input field with a character limit of "< 21 Digits".
- E-mail To:** A text input field.
- E-mail From:** A text input field.
- E-mail Subject:** A text input field with a character limit of "< 64 Digits".

At the bottom of the window are two buttons: "OK" and "Cancel".

SMTP Server:

Type the SMTP server name or the IP address of the SMTP server.

Test:

Send a test mail to mail server to check this account is available or not.

SMTP Port:

Set port number of SMTP service.

SMTP Authentication:

Select the authentication required when you send an e-mail.

Disable: if no authentication is required when an e-mail is sent.

Enable: if authentication is required when an e-mail is sent.

Authentication User name:

Type the user name for the SMTP server if **Authentication** is **Enable**.

Authentication Password:

Type the password for the SMTP server if **Authentication** is **Enable**.

E-mail To:

Type the receiver's e-mail address.

E-mail From:

Type the sender's E-mail address. This address is used for reply e-mails.

E-mail Subject:

Type the subject/title of the e-mail.

Object detection: Setup Object detection

Use this menu to specify motion detection window 1 to window 4 and set the conditions for detection while observing a captured image.



Add and Del:

To add or delete the motion windows. User can specify up to 4 Included and/or Excluded windows to monitor the video captured by this device. By dragging mouse on the image, you can change the position and size of the selected motion window accordingly.

Included or Excluded Window:

These windows can be specified as Included or Excluded type.

Included windows target specific areas within the whole video image

Excluded windows define areas within an Include window that should be ignored (areas outside Include windows are automatically ignored)

Name:

Name of the specified motion window.

Object Size:

Defines the object size of motion detection. The higher object size will only larger objects trigger motion detection. The lower object size will even small objects trigger motion detection too. Generally speaking, the smaller size will be easier to trigger event.

Sensitivity

Defines the sensitivity value of motion detection. The higher value will be more sensitivity.

Event Server: Setup FTP/TCP/HTTP server configuration

FTP Server

You may setup FTP parameters for further operation of Event Schedule. That's, if users want to send the alarm message to an FTP server, it will need to configure parameters here and also add at least one event schedule to enable event triggering as SMTP.

Name:

User can specify multiple FTP paths as wish. Therefore, user needs to specify a name for each FTP setting.

FTP Server:

Type the server name or the IP address of the FTP server.

Test:

Check the FTP server whether this account is available or not.

FTP Login name:

Type the user name for the FTP server.

FTP Login Password:

Type the password for the FTP server.

FTP Port:

Set port number of FTP service.

FTP Path:

Set working directory path of FTP server.

FTP Passive Mode:

Select passive or active mode connecting to FTP server.

TCP Server

In addition to send video file to FTP server, the device also can send event message to specified TCP server.

Name	TCP Server	TCP Port
------	------------	----------

Name (<21 Digits)

TCP Server

TCP Port (1 ~ 65535)

Name:

User can specify multiple TCP servers as wish. Therefore, user needs to specify a name for each TCP server setting.

TCP Server:

Type the server name or the IP address of the TCP server.

TCP Port:

Set port number of TCP server.

HTTP Server

The device also can send event message to specified HTTP server.

Name	Proxy Address
------	---------------

Name	<input type="text"/>	(<21 Digits)
URL	<input type="text" value="http://"/>	(<60 Digits) <input type="button" value="Test"/>
HTTP Login Name	<input type="text"/>	(<21 Digits)
HTTP Login Password	<input type="text"/>	(<21 Digits)
Proxy Address	<input type="text"/>	
Proxy Login Name	<input type="text"/>	(<21 Digits)
Proxy Login Password	<input type="text"/>	(<21 Digits)
Proxy Port	<input type="text"/>	(1 ~ 65535)

Name:

User can specify multiple HTTP servers as wish. Therefore, user needs to specify a name for each HTTP server setting.

URL:

Type the server name or the IP address of the HTTP server.

Test:

Check the HTTP server whether it is available or not.

HTTP Login name:

Type the user name for the HTTP server.

HTTP Login Password:

Type the password for the HTTP server.

Proxy Address:

Type the server name or the IP address of the HTTP Proxy.

Proxy Login name:

Type the user name for the HTTP Proxy.

Proxy Login Password:

Type the password for the HTTP Proxy.

Proxy Port:

Set port number of Proxy.

Event Schedule: Configure the event schedule

This menu is used to specify the schedule of Events and activate the some actions provided by this device.

Name	Enable	Type	Weekday	Start	Duration	Trigger by	Action

Name:

Enable: Yes No

Type: Event Trigger Schedule Trigger

Enable Time: Sun Mon Tue Wed Thu Fri Sat
Start from: , Duration: (max 168:00 hours)

Trigger by: Sensor Motion Area

Action: Voice Alert, Duration (Seconds)
 Alarm Out, Duration (Seconds)
 Send FTP
 Send TCP
 Send HTTP
 Send E-Mail

Name:
Name of the Event or Schedule.

Enable:
Enable or disable this Event or Schedule.

Type:
Event trigger or Schedule trigger.

Enable Time:
Define the feasible time slot.

Trigger by:
Select the triggered sources.

Action:
Define the actions once event triggered.

Appendix A: Restore Factory Default Settings

There is a button hidden in the pinhole on the rear panel. This button is used to restore the all factory default settings. Sometimes restarting the device will make the system back to a normal state. However, if the system still got problems after restart, user can restore the factory default settings and install it again.

Restore the device:

1. Insert the paper clip or other suitable tool to press and hold the button down continuously.
2. Hold it least 3 seconds and release the tool. Then the device has been restored to default settings and reboot again.

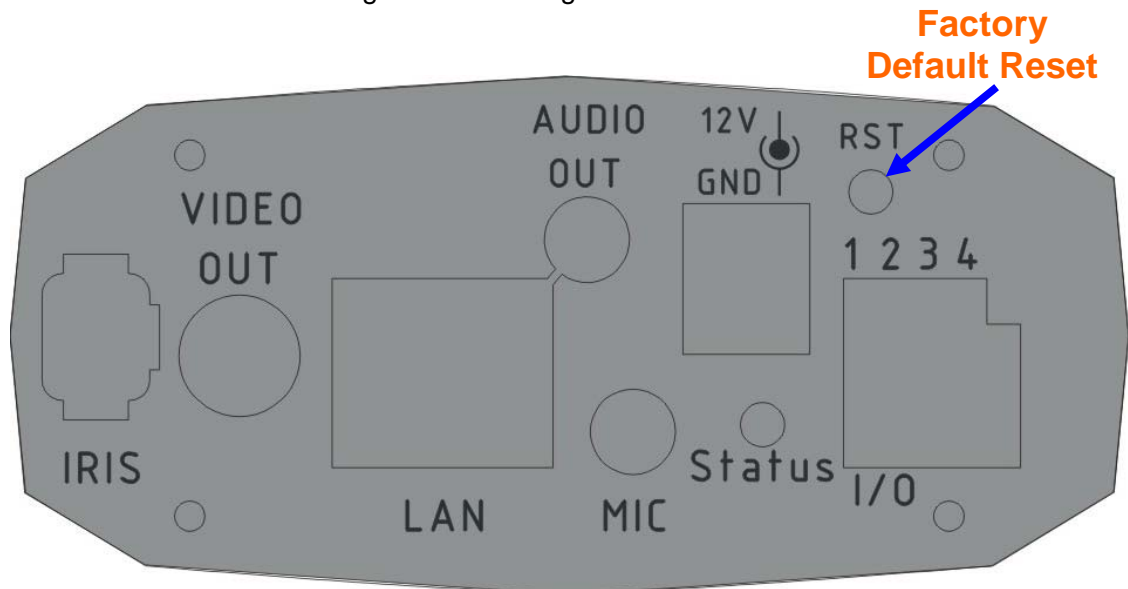

Note: Restoring the factory default setting will lose the all previous settings included IP address forever. User needs to run the IPWizard program to search the device and configure it to let the device work properly again.

Appendix B: Alarm I/O Connector

Interfacing to the External I/O

Some features of the Camera can be activated by an external sensor that senses physical changes in the area device is monitoring. These changes can include intrusion detection or certain physical change in the monitored area. For examples, the external sensor can be a door switch or an infrared motion detector. These devices are customer provided, and are available from dealers who carry surveillance and security products. Electrically, they must be able to provide a momentary contact closure.

This device provides a general I/O terminal block with one digital input and one output for device control. Pin 2 and 3 can be connected to an external sensor. The input voltage will be monitored from the initial state 'LOW'. If the external sensor need 12VDC power, then it can connect to Pin1(50mA maximum). The Alarm Output of pin 3 and 4 can be used to turn on or off the external device.

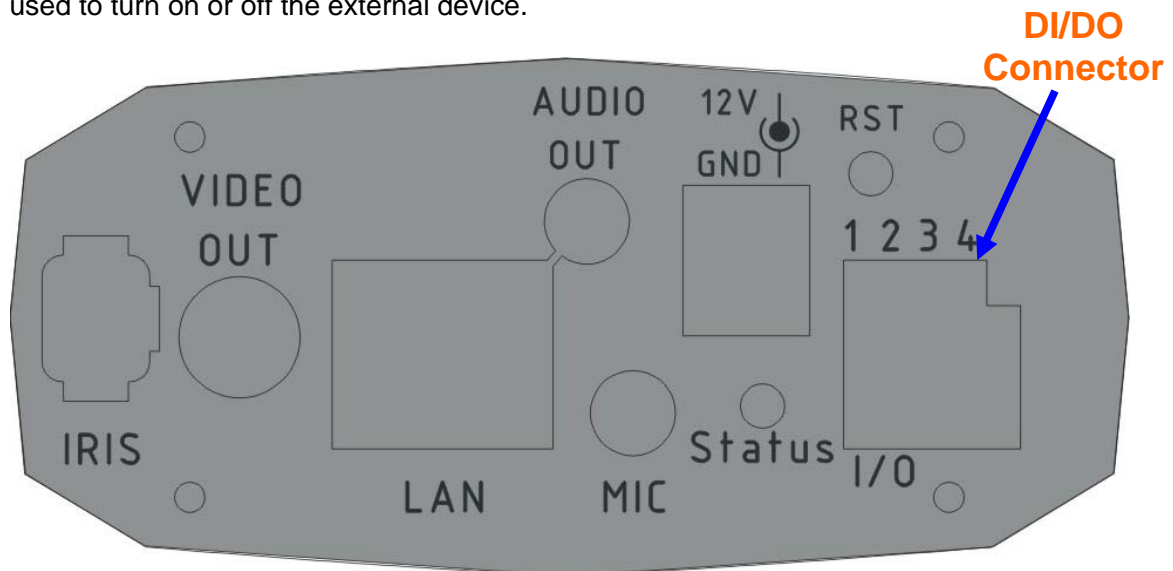

Pin	Function
1	12VDC power supply (50mA maximum)
2	Alarm Input
3	GND
4	Alarm Output

Explanation of External I/O Circuit Diagram Example

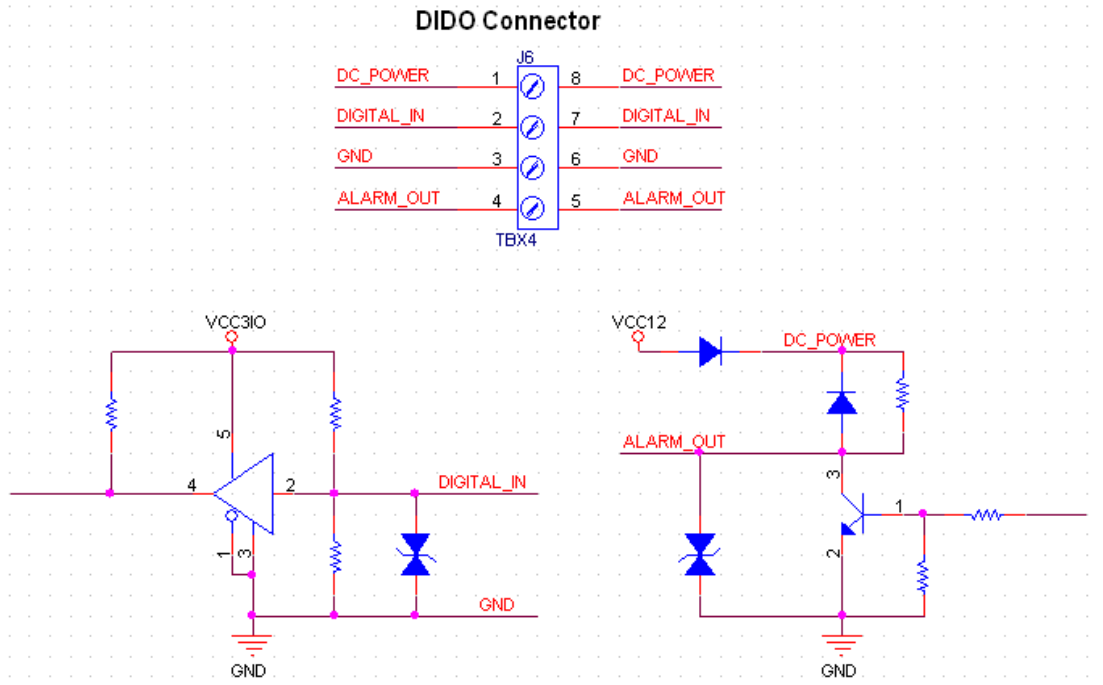

CAUTION!

- THE LOW VOLTAGE/CURRENT CIRCUITS AND HIGH VOLTAGE/ CURRENT CIRCUITS ARE IN THE VIDEDO SERVER CIRCUIT. THE QUALIFIED ELECTRICIAN SHOULD DO THE WIRING NOT BY YOURSELF. INCORRECT WIRING COULD DAMAGE VIDEDO SERVE. YOU COULD RECEIVE THE FATAL ELECTRIC SHOCK.
- THE EXTERNAL I/O IS NOT CAPABLE OF CONNECTING DIRECTLY TO DEVICES THAT REQUIRE LARGE AMOUNTS OF CURRENT. IN SOME CASES, A CUSTOM INTERFACE CIRCUIT (CUSTOMER PROVIDED) MAY HAVE TO BE USED. SERIOUS DAMAGE TO VIDEDO SERVE MAY RESULT IF A DEVICE IS CONNECTED TO THE EXTERNAL I/O THAT EXCEEDS ITS ELECTRICAL CAPABILITY.

Appendix C: Troubleshooting & Frequently Asked Questions

Question	Answer or Resolution
Features	
The video and audio codec is adopted in the device.	The device utilizes MPEG4 and JPEG dual compression to providing high quality images. Where MPEG4 is a standard for video compression and JPEG is a standard for image compression. The audio codec is defined as AMR for 3GPP and G.726 for RTSP streaming.
The maximum number of users access the device simultaneously.	The maximum number of users is limited to 10. However, it also depends on the total bandwidth accessed to this device from clients. The maximum data throughput of the device is around 20~30Mbps for UDP mode and 8~10Mbps for HTTP mode. Therefore, the actual number of connected clients is varying by streaming mode, settings of resolution, codec type, frame rate and bandwidth. Obviously, the performance of the each connected client will slow down when many users are logged on.
The device can be used outdoors or not.	The device is not weatherproof. It needs to be equipped with a weatherproof case for outdoors using. However, equipped with a weatherproof case might disable the audio function of the device.
Install this device	
Status LED does not light up.	<ul style="list-style-type: none"> • Check and confirm that the DC power adaptor, included in packaged, is used. Secure the power connector and re-power it on again. • If the problem is not solved, the device might be faulty. Contact your dealer for further help.
The network cabling is required for the device.	The device uses Category 5 UTP cable allowing 10 and/or 100 Base-T networking.
The device will be installed and work if a firewall exists on the network.	If a firewall exists on the network, port 80 is open for ordinary data communication. The HTTP port and RTSP port need to be opened on the firewall or NAT router.
The username and password for the first time or after factory default reset	Username = admin and leave password blank. Note that it's all case sensitivity.
Forgot the username and password	Follow the steps below. 1. Restore the factory default setting by press pressing and

	<p>holding down more than 3 seconds on the device.</p> <p>2. Reconfigure the device.</p>
Forgot the IP address of the device.	Check IP address of device by using the IPWizard.exe program or by UPnP discovery.
IPWizard program cannot find the device.	<ul style="list-style-type: none"> • Re-power the device if cannot find the unit within 1 minutes. • Do not connect device over a router. IPWizard program cannot detect device over a router. • If IP address is not assigned to the PC which running IPWizard program, then IPWizard program cannot find device. Make sure that IP address is assigned to the PC properly. • Antivirus software on the PC might interfere with the setup program. Disable the firewall of the antivirus software during setting up this device. • Check the firewall setting of your PC or Notebook.
Internet Explorer does not seem to work well with the device	Make sure that your Internet Explorer is version 6.0 or later. If you are experiencing problems, try upgrading to the latest version of Microsoft's Internet Explorer from the Microsoft webpage.
IPWizard program fails to save the network parameters.	<ul style="list-style-type: none"> • Network may have trouble. Confirm the parameters and connections of the device.
Access this device	
Cannot access the login page and other web pages of IR Network Camera from Internet Explorer	<ul style="list-style-type: none"> • Maybe the IP Address of the IR Network Camera is already being used by another device or computer. To confirm this possible problem, disconnect the IR Network Camera from the network first, and then run the PING utility to check it out. • Maybe due to the network cable. Try correcting your network cable and configuration. Test the network interface by connecting a local computer to the IR Network Camera via a crossover cable. • Make sure the Internet connection and setting is ok. • Make sure enter the IP address of Internet Explorer is correct. If IR Network Camera has a dynamic address, it may have changed since you last checked it. • Network congestion may prevent the web page appearing quickly. Wait for a while. <p>The IP address and Subnet Mask of the PC and IR Network Camera must be in the same class of the private IP address on the LAN.</p> <ul style="list-style-type: none"> • Make sure the http port used by the IR Network Camera, default=80, is forward to the IR Network Camera's private IP address. • The port number assigned in your IR Network Camera might not be available via Internet. Check your ISP for available port. • The proxy server may prevent you from connecting directly to IR Network Camera, set up not to use the proxy server. • Confirm that Default Gateway address is correct. • The router needs Port Forwarding feature. Refer to your

	<p>router's manual for details.</p> <ul style="list-style-type: none"> • Packet Filtering of the router may prohibit access from an external network. Refer to your router's manual for details. • Access IR Network Camera from the Internet with the global IP address of the router and port number of IR Network Camera. • Some routers reject the global IP address to access IR Network Camera on the same LAN. Access with the private IP address and correct port number of IR Network Camera. • When you use DDNS, you need to set Default Gateway and DNS server address. • If it's not working after above procedure, reset IR Network Camera to default setting and installed it again. • If the problem is not solved, the IR Network Camera might be faulty. Contact your dealer for further help.
Image or video does not appear in the main page.	<ul style="list-style-type: none"> • The first time the PC connects to IR Network Camera, a pop-up Security Warning window will appear to download ActiveX Controls. When using Windows 2000 or Windows XP, log on with an appropriate account that is authorized to install applications. • Network congestion may prevent the Image screen from appearing quickly. You may choose lower resolution to reduce the required bandwidth.
Check the device's ActiveX is installed on your computer	<p>Go to C:\Windows\Downloaded Program Files and check to see if there is an entry for the file "IPCamera Control". The status column should show "Installed". If the file is not listed, make sure your Security Settings in Internet Explorer are configured properly and then try reloading the device's home page. Most likely, the ActiveX control did not download and install correctly. Check your Internet Explorer security settings and then close and restart Internet Explorer. Try to browse and log in again.</p>
Internet Explorer displays the following message: "Your current security settings prohibit downloading ActiveX controls".	<p>Setup the IE security settings or configure the individual settings to allow downloading and scripting of ActiveX controls.</p>
The device work locally but not externally.	<ul style="list-style-type: none"> • Might be caused from the firewall protection. Check the Internet firewall with your system or network administrator. The firewall may need to have some settings changed in order for the device to be accessible outside your LAN. • Make sure that the device isn't conflicting with any other web server running on your LAN. • Check the configuration of the router settings allow the device to be accessed outside your local LAN. • Check the bandwidth of Internet connection. If the Internet bandwidth is lower than target bit rate, the video streaming will not work correctly.
The unreadable	<p>Use the operating system of the selected language. Set the</p>

characters are displayed.	Encoding or the Character Set of the selected language on the Internet Explorer.
Frame rate is slower than the setting.	<ul style="list-style-type: none"> • The traffic of the network and the object of the image affect the frame rate. The network congestion causes frame rate slower than the setting. • Check the bandwidth of Internet connection. If the Internet bandwidth is lower than target bit rate, the video streaming will not work correctly. • Ethernet switching hub can smooth the frame rate.
Blank screen or very slow video when audio is enabled.	<ul style="list-style-type: none"> • Your connection to the device does not have enough bandwidth to support a higher frame rate for the streamed image size. Try reducing the video streaming size to 160x120 or 320x240 and/or disabling audio. • Audio will consume 32 kbps. Disable audio to improve video. Your Internet connection may not have enough bandwidth to support streaming audio from the device.
Image Transfer on e-mail or FTP does not work.	<ul style="list-style-type: none"> • Default Gateway and DNS server address should be set up correctly. • If FTP does not work properly, ask your ISP or network administrator about the transferring mode of FTP server.
Pan/Tilt does not work. (including Click to Center and Preset Positioning)	<ul style="list-style-type: none"> • Click [Refresh] on the Internet Explorer when the communication stops with the device. The image will refresh. • Other clients may be operating Pan/Tilt. • Pan/Tilt operation has reached the end of corner.
Pan/Tilt does not work smoothly.	There may be a slight delay when you are using the Pan/Tilt feature in conjunction with streaming audio and video. If you find that there is a significant delay while panning or tilting the camera, try disabling the audio streaming and/or reducing the video streaming size.
Video quality of the device	
The focus on the Camera is bad.	<ul style="list-style-type: none"> • The lens is dirty or dust is attached. Fingerprints, dust, stain, etc. on the lens can degrade the image quality.
The color of the image is poor or strange.	<ul style="list-style-type: none"> • Adjust White Balance. • To insure the images you are viewing are the best they can be, set the Display property setting (color quality) to 16bit at least and 24 bit or higher if possible within your computer. • The configuration on the device image display is incorrect. You need to adjust the image related parameters such as brightness, contrast, hue and sharpness properly.
Image flickers.	<ul style="list-style-type: none"> • Wrong power line frequency makes images flicker. Make sure the 50 or 60Hz format of your device. • If the object is dark, the image will flicker. Make the condition around the Camera brighter.
Noisy images occur.	The video images might be noisy if the device is located in a very low light environment. Make the condition around the camera brighter or turn the IR LED on.
Miscellaneous	
Can not play the recorded ASF file	Have installed Microsoft®'s DirectX 9.0 or later and use the Windows Media Player 9 or later to play the ASF filed recorded by the device.

Appendix D: PING IP Address

The PING (stands for Packet Internet Groper) command is used to detect whether a specific IP address is accessible by sending a packet to the specific address and waiting for a reply. It's also a very useful tool to confirm the device installed or if the IP address conflicts with any other devices over the network.

If you want to make sure the IP address of the device, utilize the PING command as follows:

- Start a DOS window.
- Type ping x.x.x.x, where x.x.x.x is the IP address of the device.

The replies, as illustrated below, will provide an explanation to the problem.

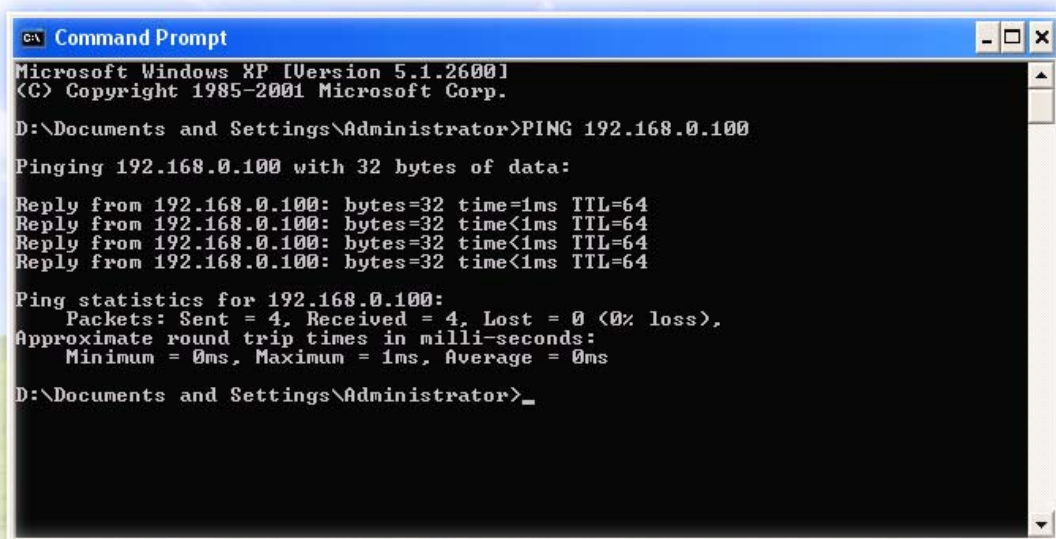

```
GA Command Prompt
Microsoft Windows XP [Version 5.1.2600]
(C) Copyright 1985-2001 Microsoft Corp.

D:\Documents and Settings\Administrator>PING 192.168.0.100

Pinging 192.168.0.100 with 32 bytes of data:

Reply from 192.168.0.100: bytes=32 time=1ms TTL=64
Reply from 192.168.0.100: bytes=32 time<1ms TTL=64
Reply from 192.168.0.100: bytes=32 time<1ms TTL=64
Reply from 192.168.0.100: bytes=32 time<1ms TTL=64

Ping statistics for 192.168.0.100:
    Packets: Sent = 4, Received = 4, Lost = 0 (0% loss),
    Approximate round trip times in milli-seconds:
        Minimum = 0ms, Maximum = 1ms, Average = 0ms

D:\Documents and Settings\Administrator>_
```

If you want to detect any other devices conflicts with the IP address of Network Camera, also can utilize the PING command but you must disconnect the device from the network first.

Appendix E: Bandwidth Estimation

The frame rate of video transmitted from the device depends on connection bandwidth between client and server, video resolution, codec type, and quality setting of server. Here is a guideline to help you roughly estimate the bandwidth requirements form your device.

The required bandwidth depends on content of video source. The slow motion video will produce smaller bit rate generally and fast motion will produce higher bit rate vice versa. Actual results generated by the device may be varying.

Image Resolution	Average range of Data Sizes for JPEG mode	Average bit rate for MPEG4 mode
160 x 120 (QQVGA)	3 ~ 6k byte per frame	64kbps~256kbps @ 30fps
320 x 240 (QVGA)	8 ~ 20k byte per frame	256kbps~768kbps @ 30fps
640 x 480 (VGA)	20 ~ 50K byte per frame	512kbps~2048kbps @ 30fps
1280 x 1024 or 1024x768	100 ~ 220k byte per frame	512kbps~4096kbps @ 15fps

Note: Audio streaming also takes bandwidth around 32kbps. Some xDSL/Cable modem upload speeds could not even reach up to 128 kbps. Thus, you may not be able to receive good quality video while also streaming audio on a 128 kbps or lower connection. Even though the upload speed is more than 128kbps, for optimal video performance, disabling audio streaming will get better video performance.

Appendix F: Specifications

Camera	Specification
Image Device	HQ1 1 /3" Color SONY Super HAD CCD
Effective Pixels	NTSC:811(H) × 508(V) PAL:795(H) × 596(V)
Horizontal Resolution	540 TV Lines
Lens	6mm fixed focal / CS mount
Scanning Frequency	NTSC : 15,734 Hz (H) , 60 Hz (V) PAL : 15,625 Hz (H) , 50 Hz (V)
Signal to Noise	More than d0 dB (AGC off)
IP Module	
Video Encoder	MPEG4 and JPEG simultaneously and multi-profile
Video Resolution	4 profiles simultaneously - MPEG4 VGA - MPEG4 QVGA - MPEG4 QQVGA - JPEG VGA/ QVGA/ QQVGA (selectable)
Video Resolution	Up to 30fps @ 160x120 Up to 30fps @ 320x240 Up to 30fps @ 640x480
Audio Encoder	RTSP: G.711, G.726 3GPP: AMR
Networking Protocol	TCP/IP, HTTP, SMTP, FTP, NTP, DNS, DDNS, DHCP, UPnP™, RTSP, PPPoE, 3GPP
Browser	Microsoft® Internet Explorer 6.0 or later
Operating System	Windows® 2000, XP, Vista
Security	2 Levels, Administrator or Viewer / IP filter
Ethernet	10/100M auto negotiation
WLAN	802.11b/g (Wireless model only)
RAM	32MB SDRAM
Flash	4MB NOR Flash Memory
Indication LED	Two-Color LED
DI/DO	1xDI / 1xDO
Microphone	Built-in and external
Audio Interface	Audio line out (line level)
Power Supply	12V DC external power adapter
Power Consumption	4.5W max (with WLAN) or 3.5W max (without WLAN)

Network Camera User's Guide

Operating Temperature	0°C to 50°C (32°F to 104°F)
Operating Humidity	10% ~ 80%

Appendix G: Configure Port Forwarding Manually

The device can be used with a router. If the device wants to be accessed from the WAN, its IP address needs to be setup as fixed IP address, also the port forwarding or Virtual Server function of router needs to be setup. This device supports UPnP traversal function. Therefore, user could use this feature to configure port forwarding of NAT router first. However, if user needs to configure port forwarding manually, please follow the steps as below:

Manually installing the device with a router on your network is an easy 3–step procedure as following:

- (1) Assign a local/fixed IP address to your device
- (2) Access the Router with Your Web browser
- (3) Open/Configure Virtual Server Ports of Your Router

(1) Assign a local/fixed IP address to your device

The device must be assigned a local and fixed IP Address that allows it to be recognized by the router. Manually setup the device with a fixed IP address, for example, *192.168.0.100*.

(2) Access the Router with Your Web browser

The following steps generally apply to any router that you have on your network. The D-Link DI-624 is used as an example to clarify the configuration process. Configure the initial settings of the router by following the steps outlined in the router's **Quick Installation Guide**.

If you have cable or DSL service, you will most likely have a dynamically assigned WAN IP Address. 'Dynamic' means that your router's WAN IP address can change from time to time depending on your ISP. A dynamic WAN IP Address identifies your router on the public network and allows it to access the Internet. To find out what your router's WAN IP Address is, go to the **Status** screen on your router and locate the WAN information for your router. As shown on the following page the WAN IP Address will be listed. This will be the address that you will need to type in your web browser to view your camera over the Internet. Be sure to uncheck the **Reset IP address at next boot** button at the top of the screen after modifying the IP address. Failure to do so will reset the IP address when you restart your computer.

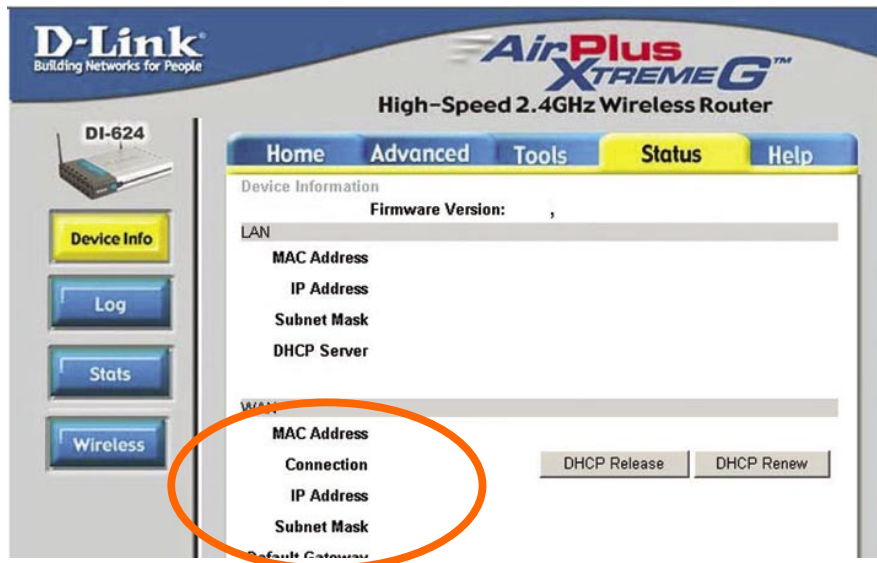

Your WAN IP Address will be listed here.

Note: Because a dynamic WAN IP can change from time to time depending on your ISP, you may want to obtain a Static IP address from your ISP. A Static IP address is a fixed IP address that will not change over time and will be more convenient for you to use to access your camera from a remote location. If you could not get a Static IP address from your ISP, the DIPS™ or DDNS is a solution alternatively. Please refer to Appendix G for more information.

(3) Open/set Virtual Server Ports to enable remote image viewing

The firewall security features built into the router and most routers prevent users from accessing the video from the device over the Internet. The router connects to the Internet over a series of numbered ports. The ports normally used by the device are blocked from access over the Internet. Therefore, these ports need to be made accessible over the Internet. This is accomplished using the **Virtual Server** function on the router. The Virtual Server ports used by the camera must be opened through the router for remote access to your camera. Virtual Server is accessed by clicking on the **Advanced** tab of the router screen.

Follow these steps to configure your router's Virtual Server settings

- Click **Enabled**.
- Enter a unique name for each entry.
- Select **Both** under **Protocol Type (TCP and UDP)**
- Enter your camera's local IP Address (e.g., **192.168.0.100**, for example) in the **Private IP** field.

- If you are using the default camera port settings, enter **80** into the **Public** and **Private Port** section, click **Apply**.
- **Scheduling** should be set to **Always** so that the camera images can be accessed at any time.

A check mark appearing before the entry name will indicate that the ports are enabled.

Important: Some ISPs block access to port 80. Be sure to check with your ISP so that you can open the appropriate ports accordingly. If your ISP does not pass traffic on port 80, you will need to change the port the camera uses from 80 to something else, such as 8080. Not all routers are the same, so refer to your user manual for specific instructions on how to open ports.

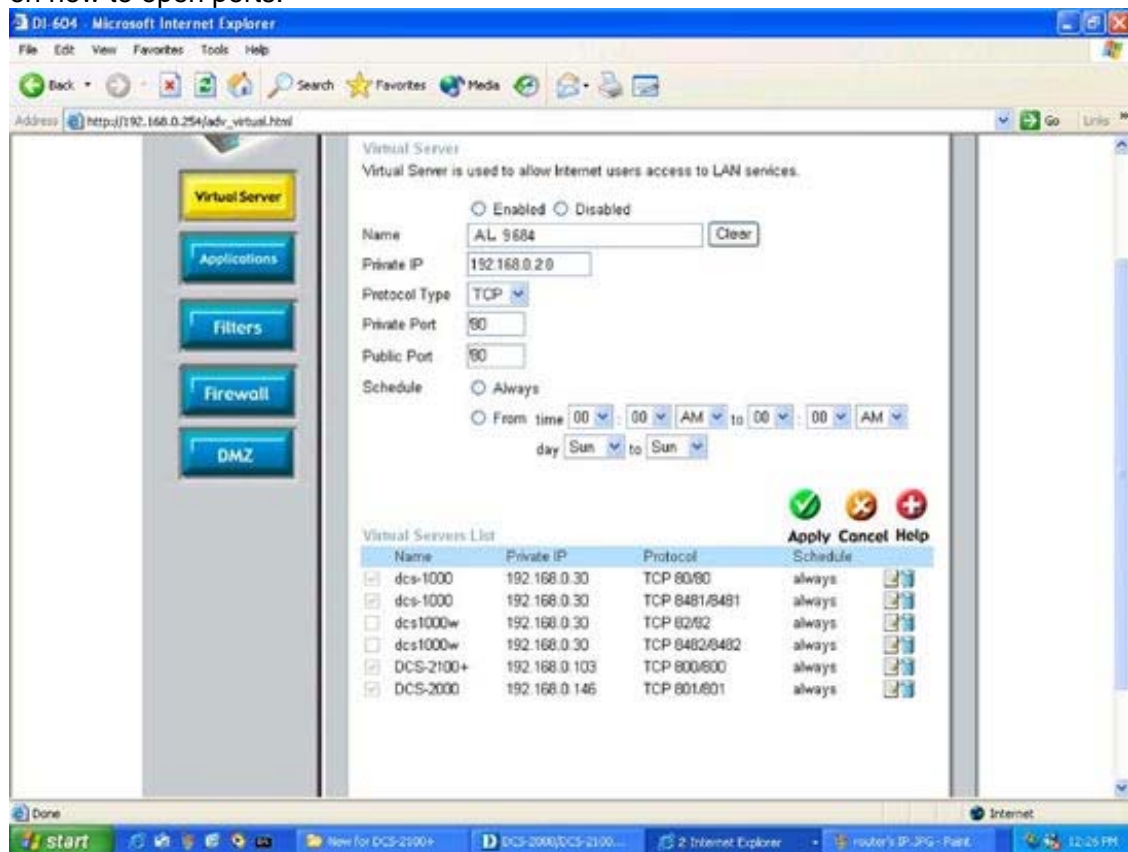

Enter valid ports in the **Virtual Server** section of your router. Please make sure to check the box on this line to enable settings. Then the device can be access from WAN by the router's WAN IP Address.

By now, you have finished your entire PC configuration for this device.

Appendix H: DDNS Application

1. Preface

If you have a Cable modem or xDSL, this is a great way to host your own Networked Device or other TCP/IP Service. Get your own domain like www.yourname.com, www.yourname.com.tw etc. (Note: This domain must be registered with Internic via registration authorities such as Network Solutions, DirectNIC, Register.com etc). Your domain name's dynamic IP address is automatically tracked by a DDNS server.

Host your own Networked Device and much more no matter what your computer's IP address may be and even if you have dialup, DSL or cable modem internet connection where your computer's IP address changes all the time!! DDNS service supports all top level domain names including but not limited to .com, .net, .org, .to, .uk etc.

2. Ethernet Network Environment

Normally, DDNS service is only necessary for the users that could only obtain dynamic IP addresses. As to the users that could obtain the static valid IP address, they do not usually have to apply the DDNS service. Before we decide if DDNS is necessary for the users, we have to check what kind of Ethernet network environment we have to install our Networked Device on.

(1) Environment of Fixed Valid IP Network

If users could obtain valid IP addresses, they could save the effort to apply DDNS service. Because the IP address in this environment is fixed, users could input the IP address or domain name of demo site directly in the IE browser.

(2) Environment of Dynamic IP Network

If users is under an environment of dynamic IP network (Dial-up xDSL), they have to apply a domain name in advance. Then apply DDNS service. Finally setup the necessary information of DDNS and PPPoE of the Networked Device in order to let the outside administrator be able to access through internet.

3. Application Steps—DDNS & Domain Name

- (1). Visit the following web site: <http://www.dyndns.org/>
- (2). Click "Account"



(3). After the columns show up at the left side, click “[Create Account](#)”.

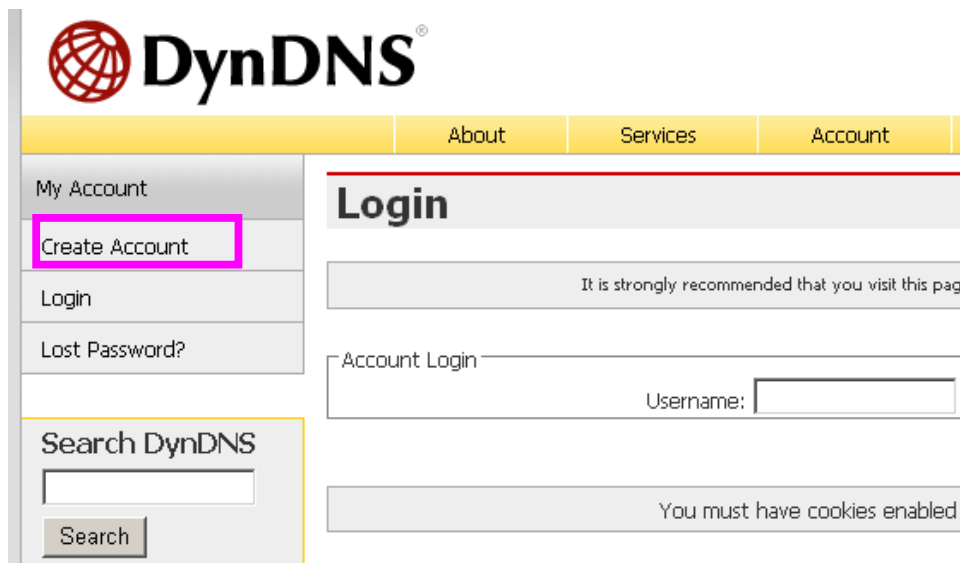

- (4). Fill the application agreement and necessary information.
- Username
 - E-mail address and confirmation
 - Password and confirmation
 - Submit all the input information and finish creating an account

Terms of Service

Please read the acceptable use policy (AUP) and accept it prior to creating your account. Also acknowledge that you may only have one (1) free account, and that creation of multiple free accounts will result in the deletion of all of your accounts.

Policy Last Modified: February 6, 2006

1. ACKNOWLEDGMENT AND ACCEPTANCE OF TERMS OF SERVICE

All services provided by Dynamic Network Services, Inc. ("DynDNS") are provided to you (the "Member") under the Terms and Conditions set forth in this Acceptable Use Policy ("AUP") and any other operating rules and policies set forth by DynDNS. The AUP comprises the entire agreement between the Member and DynDNS and supersedes all prior agreements between the parties regarding the subject matter contained herein. BY COMPLETING THE REGISTRATION PROCESS AND CLICKING THE "Accept" BUTTON, YOU ARE INDICATING YOUR AGREEMENT TO BE BOUND BY ALL OF THE TERMS AND CONDITIONS OF THE AUP.

2. DESCRIPTION OF SERVICE

I agree to the AUP:

I will only create one (1) free account:

← Click these two options

Next Step

After you click "Create Account", we will create your account and send you an e-mail to the address you provided. Please follow the instructions in that e-mail to confirm your account. You will need to confirm your account within 48 hours or we will automatically delete your account. (This helps prevent unwanted robots on our systems)

Create Account

- (5). Check your e-mail mailbox. There will be an e-mail with a title "Your DynDNS Account Information". Click the hyperlink address to confirm the DDNS service that you just applied. Then DDNS you applied activated.

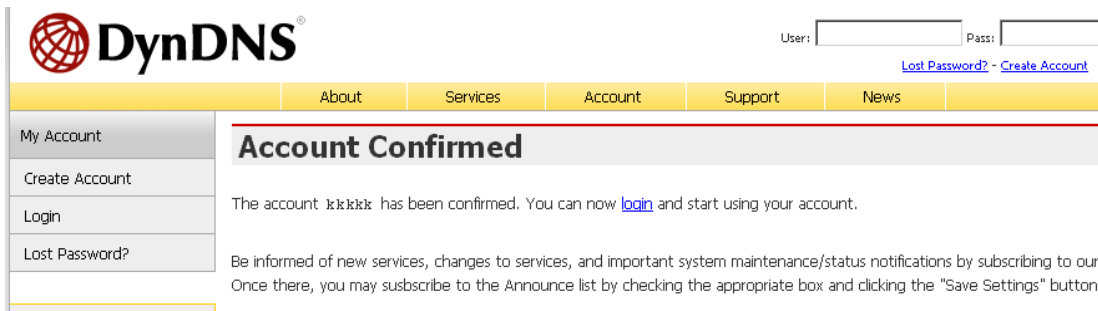
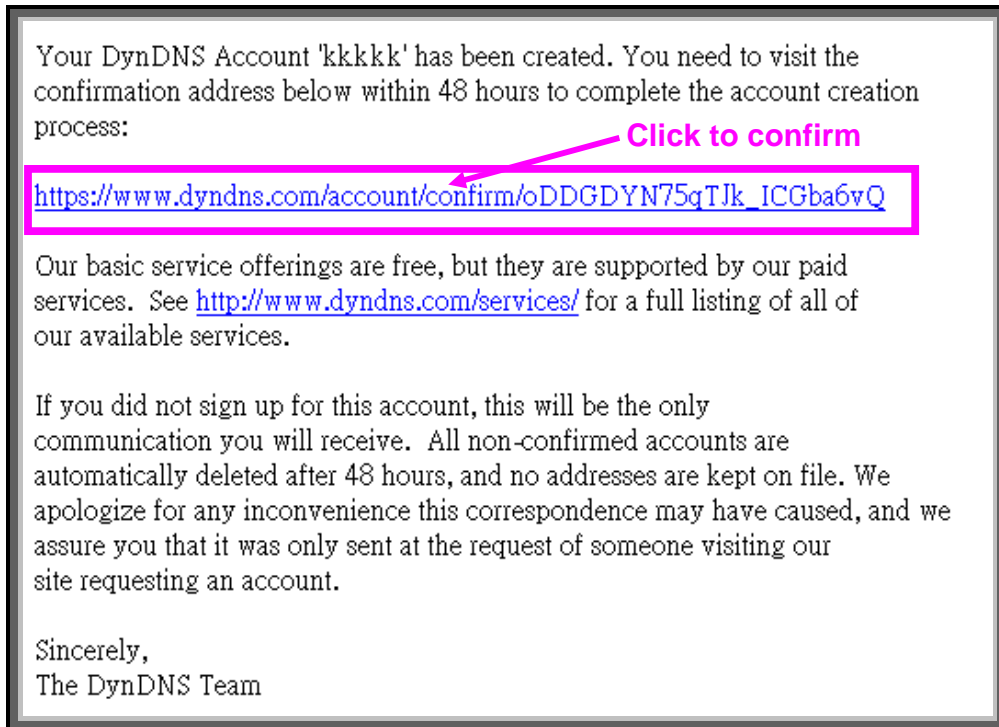

(6). Enter the web page <http://www.dyndns.org/> again. Input your username and password that you just applied to login administration interface of DDNS server.



(7). If the correct username and password are input, you can see the following picture at the top-right of the login page.

(8). Click the "Services".

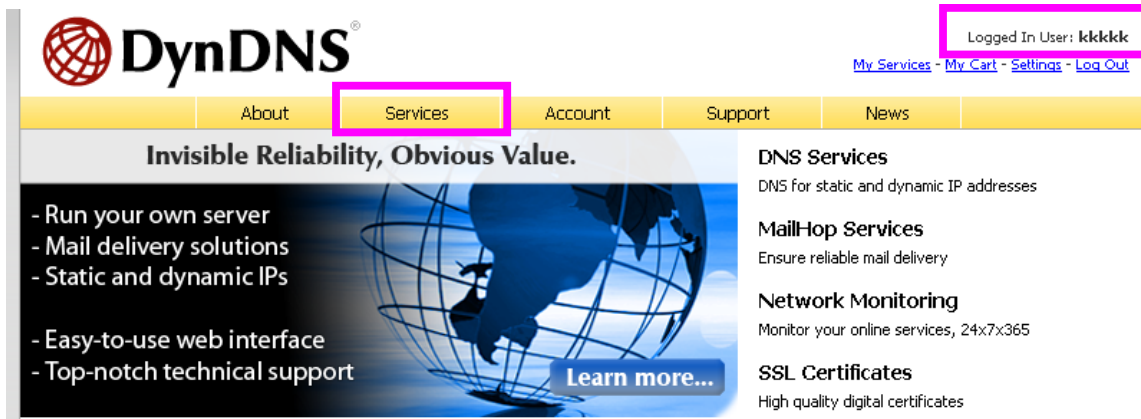

(9). Click the "Dynamic DNS".

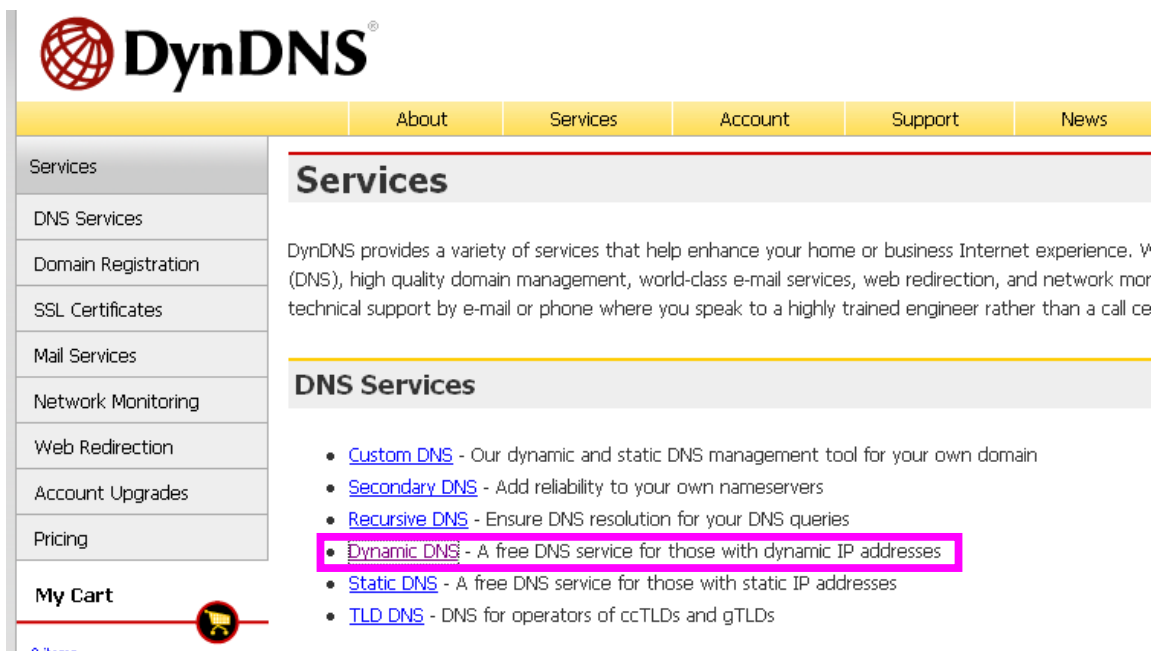

(10). Click the "Create Hosts".

Dynamic DNSSM

The free Dynamic DNS service allows you to alias a dynamic IP address to a static hostname in any of the [many domains](#) we offer, allowing your computer to be more easily accessed from various locations on the Internet. We provide this service, for up to five (5) hostnames, free to the Internet community.

The Dynamic DNS service is ideal for a home website, file server, or just to keep a pointer back to your home PC so you can access those important documents while you're at work. Using one of the available third-party [update clients](#) you can keep your hostname always pointing to your IP address, no matter how often your ISP changes it. No more fumbling to find that piece of paper where you wrote down your IP address, or e-mailing all your friends every time it changes. Just tell them to visit [yourname.dyndns.org](#) instead!

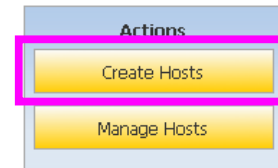

(11). We could create a domain name without any charge at this step. First, we input the host name. (Pink No.1) Then we pick a domain that is easy to remember. (Pink No.2) Finally, click the "Add Host" to submit the domain name information. (Pink No.3)

New Dynamic DNSSM Host

The form contains the following fields and controls:

- Hostname:** Input field with a pink arrow labeled '1' pointing to it.
- IP Address:** Input field.
- Enable Wildcard:** Check box (unchecked).
- Mail Exchanger (optional):** Input field.
- Domain Selection:** A dropdown menu with a pink arrow labeled '2' pointing to it. The selected option is 'dyndns.org'. Other visible options include dvrdns.org, dyn-o-saur.com, dynalias.com, dynalias.net, dynalias.org, dyndns.biz, dyndns.info, dyndns.tv, dyndns.ws, ftpaccess.cc, and game-host.org.
- Buttons:** 'Add Host' (with a pink arrow labeled '3' pointing to it) and 'Reset Form'.

4. Setup the DDNS and PPPoE of Networked Device

At last, users have to enter the web page of Networked Device and setup the necessary information of DDNS and PPPoE after the application of DDNS service. Please check the user manual to access the DDNS and PPPoE pages. After saving the modification, restart the device. The external users could browse the Networked Device by the input of their domain name.

Appendix I: Power Line Frequency

COUNTRY	VOLTAGE	FREQUENCY	COMMENTS
Argentina	220V	50 Hz	*Neutral and line wires are reversed from that used in Australia and elsewhere.
Australia	230V*	50 Hz	*Outlets typically controlled by adjacent switch. Though <i>nominal</i> voltage has been officially changed to 230V, 240V is within tolerances and commonly found.
Austria	230V	50 Hz	
Brazil	110/220V*	60 Hz	*127V found in states of Bahia, Paran?(including Curitiba), Rio de Janeiro, S 綉 Paulo and Minas Gerais (though 220V may be found in some hotels). Other areas are 220V only, with the exception of Fortaleza (240V).
Canada	120V	60 Hz	
China, People's Republic of	220V	50 Hz	
Finland	230V	50 Hz	
France	230V	50 Hz	
Germany	230V	50 Hz	
Hong Kong	220V*	50 Hz	
India	230V	50 Hz	
Italy	230V	50 Hz	
Japan	100V	50/60 Hz*	*Eastern Japan 50 Hz (Tokyo, Kawasaki, Sapporo, Yokohoma, and Sendai); Western Japan 60 Hz (Osaka, Kyoto, Nagoya, Hiroshima)
Malaysia	240V	50 Hz	
Netherlands	230V	50 Hz	
Portugal	230V	50 Hz	
Spain	230V	50 Hz	
Sweden	230V	50 Hz	
Switzerland	230V	50 Hz	
Taiwan	110V	60 Hz	
Thailand	220V	50 Hz	
United Kingdom	230V*	50 Hz	*Outlets typically controlled by adjacent switch. Though <i>nominal</i> voltage has been officially changed to 230V, 240V is within tolerances and commonly found.
United States of America	120V	60 Hz	

Appendix J: 3GPP

To use the 3GPP function, in addition to previous section, you might need more information or configuration to make this function work.

Note:

1. The camera must be set as Multi-profile mode, not Mega-pixel mode. Otherwise this device can not serve 3GPP stream.
2. To use the 3GPP function, it strongly recommends installing the Networked Device with a public and fixed IP address without any firewall protection.

RTSP Port:

Port 554 is the default for RTSP service. However, sometimes, some service providers change this port number for some reasons. If so, user needs to change this port accordingly.

Dialing procedure:

1. Choose a verified player (PacketVideo or Realplayer currently)
2. Use the following URL to access:

`rtsp://host/mpeg4/media.3gp`

Where *host* is the host name or IP address of the camera.

Compatible 3G mobile phone:

Please contact your dealer to get the approved list of compatible 3G phone.

Appendix K: Enable UPnP of Windows XP

Use the following steps to enable UPnP settings only if your operating system of PC is running Windows XP.

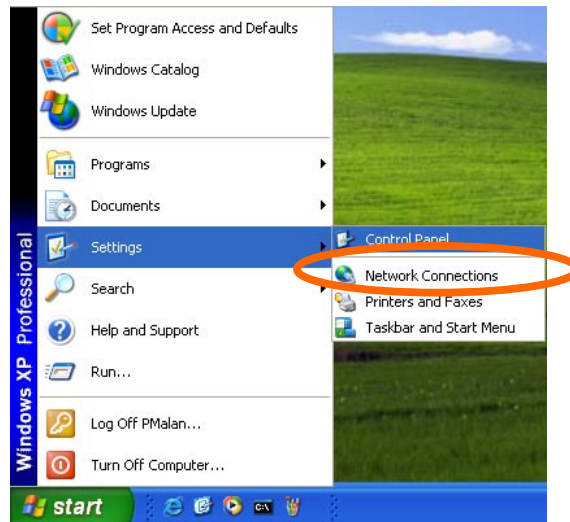

Go to **Start > Settings**.

Click **Control Panel**

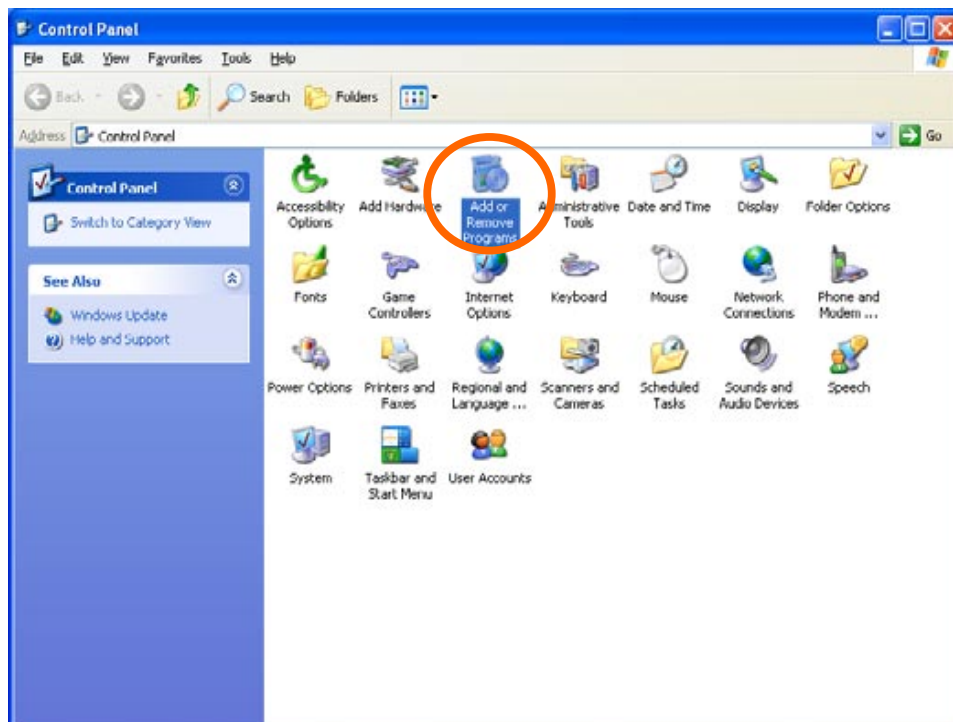

Click **Add or Remove Programs**

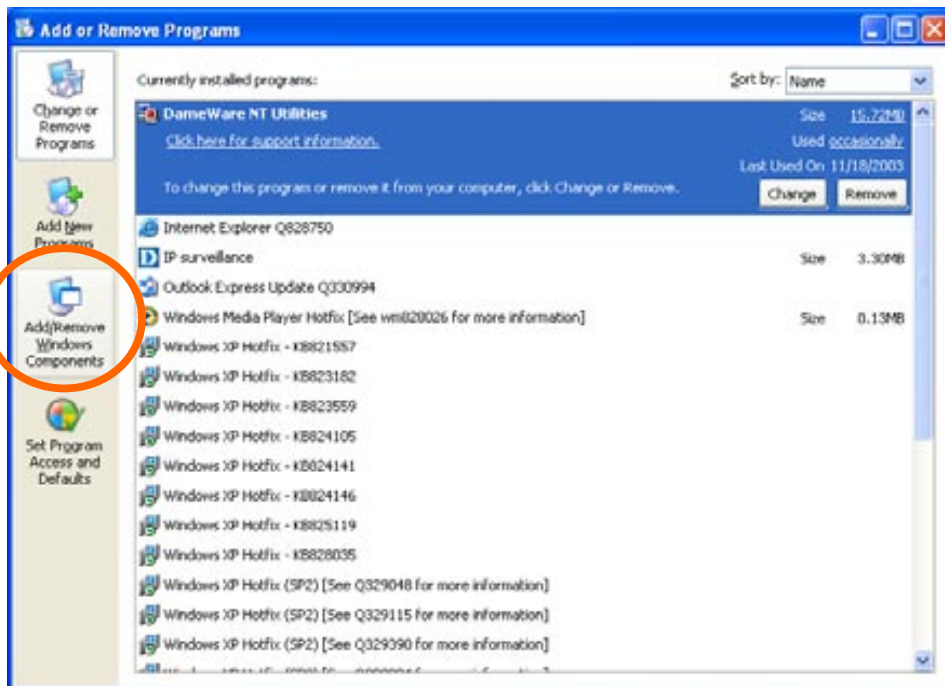

Click **Add/Remove Windows Components**

The following screen will appear:

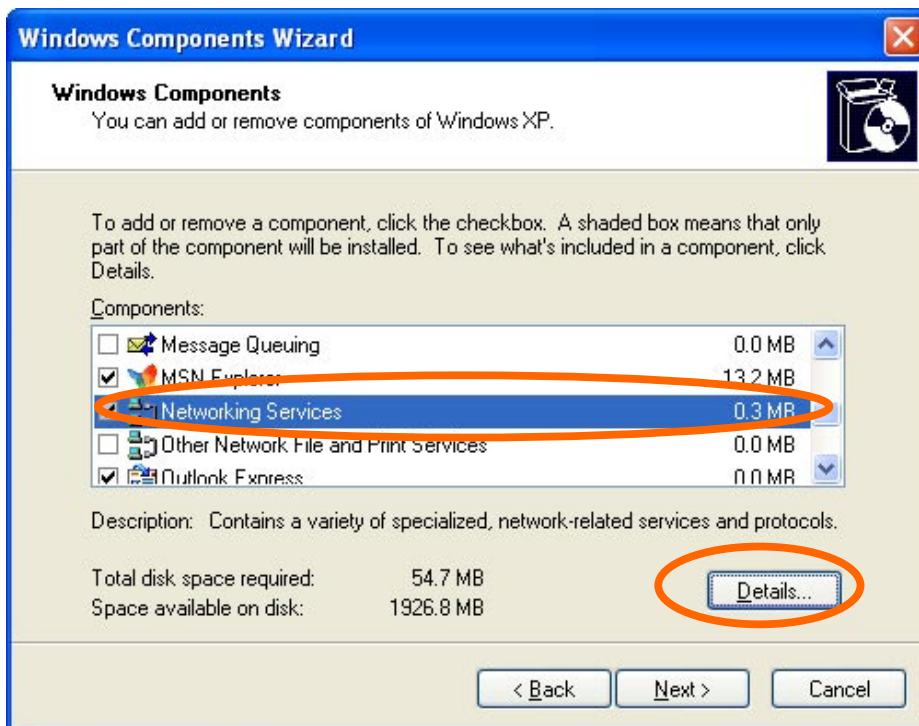

Select **Networking Services**

Click **Details**

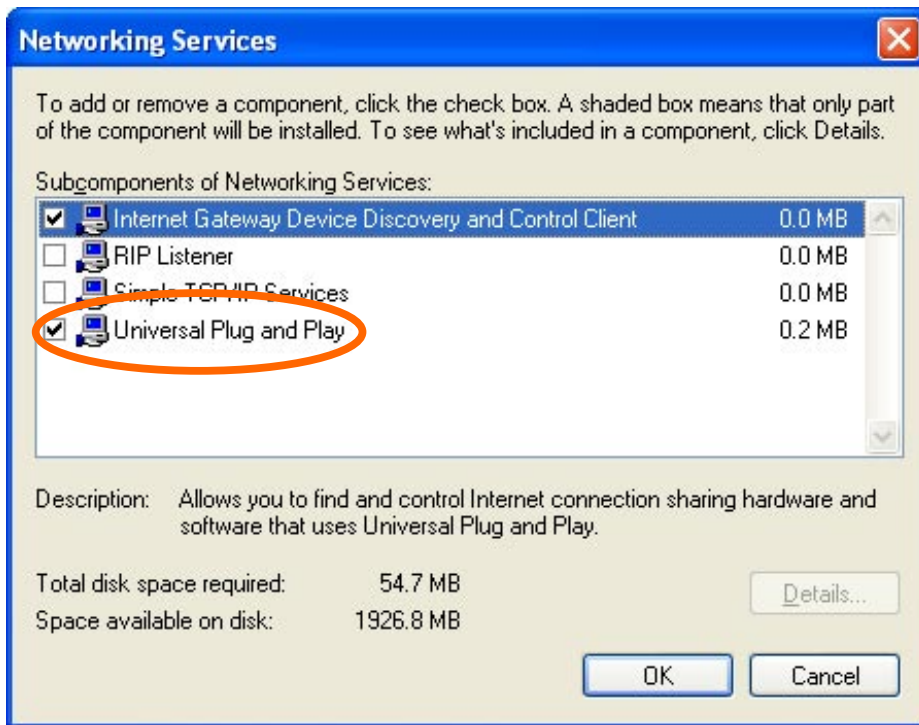

Select **Universal Plug and Play**

Click **Ok**

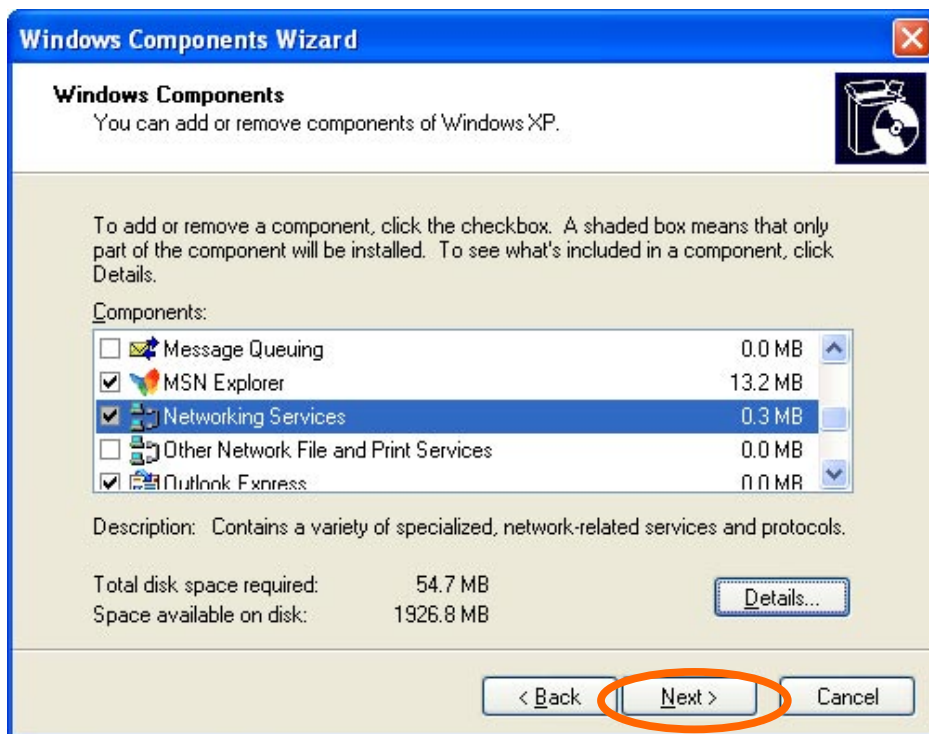

Click **Next**

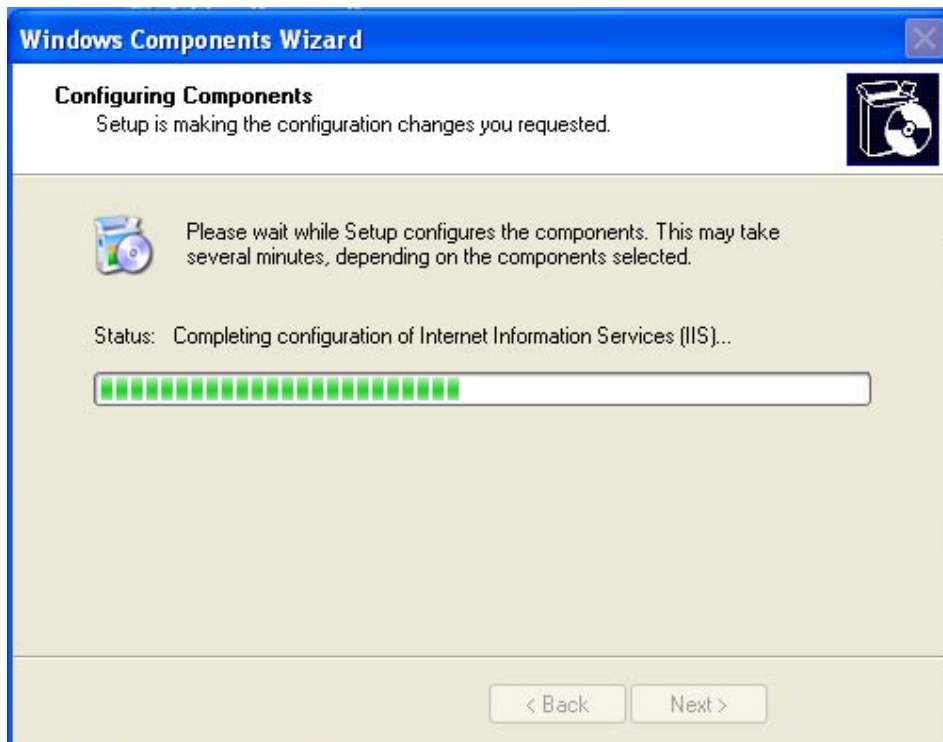

Please wait while Setup configures the components.



Click **Finish**

Free Manuals Download Website

<http://myh66.com>

<http://usermanuals.us>

<http://www.somanuals.com>

<http://www.4manuals.cc>

<http://www.manual-lib.com>

<http://www.404manual.com>

<http://www.luxmanual.com>

<http://aubethermostatmanual.com>

Golf course search by state

<http://golfingnear.com>

Email search by domain

<http://emailbydomain.com>

Auto manuals search

<http://auto.somanuals.com>

TV manuals search

<http://tv.somanuals.com>