



CCTV CAMERA

- Box Camera
- IR Camera
- Dome Camera
- Hidden Camera
- Board Camera



Box Camera Selection Guide

Picture	Model No.	Feature	Sensor	TVL	Min Illumination	Lens	Voltage	Page
	RYK-AF302A	Auto Focus Zoom 35x	1/4" CL WDR	470	0.01 Lux (Night / BW) 0.5 Lux (Day / Color)	35x Zoom (ICR)	DC	03
	RYK-AF301A		1/4" CL (EX-View)					
	RYK-AF204A	Auto Focus Zoom 22x	1/4" CL	330	0.1 Lux (Night / BW) 0.3 Lux (Day / Color)	22x Zoom (ICR)		05
	RYK-AF203A			330	0.3 Lux	22x Zoom		
	RYK-AF201A			470	0.7 Lux			
	RYK-AF202A			470	0.7 Lux			
	RYK-AF302	Auto Focus Zoom 35x	1/4" CL WDR	470	0.01 Lux (Night / BW) 0.5 Lux (Day / Color)	35x Zoom (ICR)	DC	04
	RYK-AF301		1/4" CL (EX-View)					
	RYK-200ZR	Auto Focus Zoom 22x	1/4" CL	330	0.1 Lux (Night / BW) 0.3 Lux (Day / Color)	22x Zoom (ICR)		06
	RYK-20AZR			330	0.3 Lux	22x Zoom		
	RYK-20AZ			470	0.7 Lux			
	RYK-200Z			470	0.7 Lux			
	RYK-491DR	WDR / ICR / OSD	1/3" CL	470	0.1 Lux (Night / BW) 0.001 Lux (DSS)	C/CS Mount	AC, Dual	07
	RYK-493DR	ICR / OSD Super HR	1/3" CL	550	0.05 Lux (Night / BW) 0.8 Lux (Day / Color)			08
	RYK-493DRX		1/3" CL (EX-View)		0.01 Lux (Night / BW) 0.5 Lux (Day / Color)			
	RYK-235LVR3	ICR / LED Vari-Focal	1/3" CL	380	0.2 Lux	Vari Focal (ICR)	DC, Dual	09
	RYK-232LVR3			470	0.3 Lux			
	RYK-475ZM3(ZM9)	Vari-Focal	1/3" CL	380	0.2 Lux	Vari Focal	AC, Dual	10
	RYK-472ZM3(ZM9)			470	0.3 Lux			
	RYK-775ZM3(ZM9)		1/3" BW	420	0.1 Lux			
	RYK-777ZM3(ZM9)			600	0.2 Lux			
	RYK-213F	Super HR	1/3" CL	550	0.2 Lux	C/CS Mount	DC	11
	RYK-413F							
	RYK-275F	Standard Type	1/3" CL	380	0.1 Lux	C/CS Mount	DC	11
	RYK-475F							
	RYK-272F			470	0.2 Lux		DC	
	RYK-472F							AC, Dual
	RYK-277F			1/4" CL	330		0.2 Lux	
	RYK-477F							AC, Dual
	RYK-575F	B/W DSP	1/3" BW	420	0.05 Lux		DC	
	RYK-775F							AC, Dual
	RYK-577F			600	0.1 Lux		DC	
	RYK-777F							AC, Dual
	RYK-572F	510	0.05 Lux	DC				
	RYK-772F				AC, Dual			
	RYK-573F						710	0.1 Lux
	RYK-773F				AC, Dual			
	RYK-264K	Mini Size All In One (Kit)	1/4" CL	330		0.5 Lux	Board Lens	DC
	RYK-569K		1/3" BW	400	0.3 Lux			

35x (ICR) Auto Focus Zoom Camera

Features

- Sony EX-View HAD CCD sensor
- 35x optical zoom, 16x digital zoom
- Day & Night (IR-Cut filter Removable, ICR)
- On Screen Display (OSD) set-up menu
- Built-in 5 keys to control zooming, focusing function and set-up menu adjustment
- Support functions: AI, AWB, AGC, BLC, FL, Positive / Negative, Auto Focus, Audio function
- Support YOKO / PELCO D&P / LG protocol

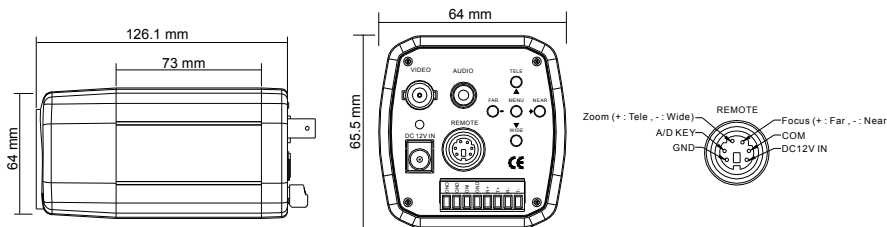

Option :



RYK-8340
Wire Remote Controller



RYK-8505L
IR Housing

Model Name	RYK-AF301A	RYK-AF302A
Image Device	1/4" Color Sony EX-View HAD (Hi-Res.)	1/4" Color Sony EX-View HAD (WDR, Hi-Res.)
Picture Elements	NTSC:768x494, PAL:752x582	
Resolution	470 TVL	
Min. Illumination	0.01 Lux (Night / BW), 0.5 Lux (Day / Color) / F1.6	
S/N Ratio	More than 48dB	
Electronic Shutter	NTSC:1/60~1/30,000, PAL:1/50~1/30,000	NTSC:1/60~1/50,000, PAL:1/50~1/50,000
Flickerless Mode	On / Off (NTSC:1/100, PAL:1/120)	
Iris Control	Auto / Manual	
Lens Furnished	35x (ICR) Auto Focus Zoom (3.6~126mm / F1.6~4.2), Video AF	
Digital Zoom Ratio	Basic 16x (Total Zoom Ratio 560x), 2x~16x variable	Basic 10x (Total Zoom Ratio 350x), 2x~10x variable
Min. Shutting Distance	0.01m (WIDE), 1.5m (TELE)	
Camera Control	RS-485 / RS-422 (option: RS-232)	
Remote Control	6-pin Circular Connect: Zoom, Focus, A/D key, DC12V IN	
Key Control	Tele (Up), Wide (Down), Near (+), Far (-), Menu	
Protocol	YOKO / PELCO D&P / LG	
Zoom Speed	8 / 11 / 14 sec mode	Slow / Normal / High
Zoom / Focus Preset	128 preset points	
Focus Mode	Auto / Manual / Push Auto	
On Screen Display	Set-up menu	
Negative / Positive	On / Off	
Wide Dynamic Range (WDR)	—	On / Off
Day & Night (ICR)	AE / Sensor / Day / Night / External	
Day & Night Control	Day & Night output / Day & Night External input	
Brightness Control	Manual	
Wide Burst	On / Off	—
White Balance	Auto / Hue / Indoor / Outdoor / Manual / Push Auto	
Gain Control	Auto / Manual	
Motion Detection	—	On / Off
Privacy Masking	—	8 free areas (Area size adjustable)
Back Light Comp.	On / Auto (Center / Up / Down / Left / Right) / Super / Off	
Sync. System	Internal	
Video Output	1 Vp-p / 75 Ohms	
Audio Output	2 Vp-p / 50 Ohms	—
Power Supply	DC12V ±10%	
Power Consumption	340mA max.	440mA max.
Operating Temp.	-10°C ~ 50°C	

35x (ICR) Auto Focus Zoom Module



Features

- Sony EX-View HAD CCD sensor
- 35x optical zoom, 16x digital zoom
- Day & Night (IR-Cut filter Removable, ICR)
- On Screen Display (OSD) set-up menu
- Camera control via RS-232 (TTL Level)
- Key control (Zooming function, Focusing function and set-up menu adjustment) via 6-pin Dry Contact Connector
- Support functions: AI, AWB, AGC, BLC, FL, Positive / Negative and Auto Focus
- Support YOKO / PELCD D&P / LG protocol

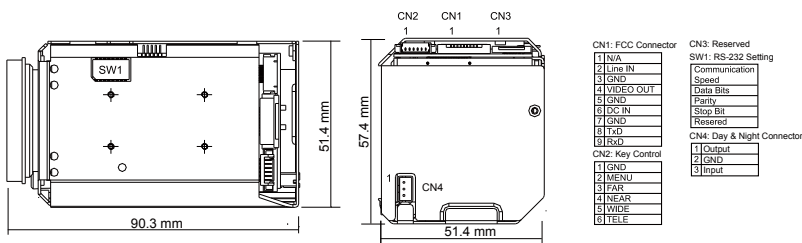

Model Name	RYK-AF301	RYK-AF302
Image Device	1/4" Color Sony EX-View HAD (Hi-Res.)	1/4" Color Sony EX-View HAD (WDR, Hi-Res.)
Picture Elements	NTSC:768x494, PAL:752x582	
Resolution	470 TVL	
Min. Illumination	0.01 Lux (Night / BW), 0.5 Lux (Day / Color) / F1.6	
S/N Ratio	More than 48dB	
Electronic Shutter	NTSC:1/60~1/30,000, PAL:1/50~1/30,000	NTSC:1/60~1/50,000, PAL:1/50~1/50,000
Flickerless Mode	On / Off (NTSC:1/100, PAL:1/120)	
Iris Control	Auto / Manual	
Lens Furnished	35x (ICR) Auto Focus Zoom (3.6~126mm / F1.6~4.2), Video AF	
Digital Zoom Ratio	Basic 16x (Total Zoom Ratio 560x), 2x~16x variable	Basic 10x (Total Zoom Ratio 350x), 2x~10x variable
Min. Shutting Distance	0.01m (WIDE), 1.5m (TELE)	
Camera Control	RS-232 (TTL Level)	
Remote Control	6-pin Dry Contact Connector: Tele, Wide, Near, Far, Menu, GND	
Protocol	YOKO / PELCO D&P / LG	
Zoom Speed	8 / 11 / 14 sec mode	Slow / Normal / High
Zoom / Focus Preset	128 preset points	
Focus Mode	Auto / Manual / Push Auto	
On Screen Display	Set-up menu	
Negative / Positive	On / Off	
Wide Dynamic Range (WDR)	—	On / Off
Day & Night (ICR)	AE / Sensor / Day / Night / External	
Day & Night Control	Day & Night output / Day & Night External input	
Brightness Control	Manual	
Wide Burst	On / Off	
White Balance	Auto / Hue / Indoor / Outdoor / Manual / Push Auto	
Gain Control	Auto / Manual	
Motion Detection	—	On / Off
Privacy Masking	—	8 free areas (Area size adjustable)
Back Light Comp.	On / Auto (Center / Up / Down / Left / Right) / Super / Off	
Sync. System	Internal	
Video Output	1 Vp-p / 75 Ohms	
Power Supply	DC12V ± 10%	
Power Consumption	340mA max.	440mA max.
Operating Temp.	-10°C ~ 50°C	

• Dry Contact is either open under normal status (Normal Open) or close to GND under active status (connected to GND).

22x (ICR) Auto Focus Zoom Camera



Features

- 22x optical zoom, 16x digital zoom
- Day & Night (option: IR-Cut filter Removable, ICR)
- On Screen Display (OSD) set-up menu
- Camera control via RS-485
- Support functions: AI, AWB, AGC, BLC, FL, Positive / Negative
- Support YOKO / PELCO D&P / LG protocol

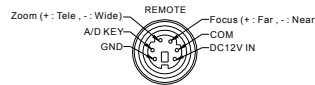
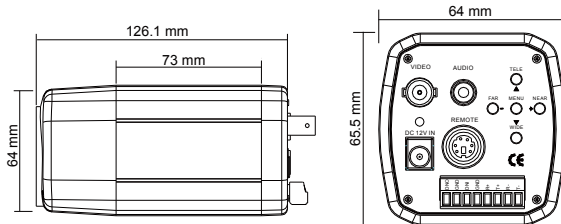

Option :



RYK-8340
Wire Remote Controller



RYK-8505L
IR Housing

Model No.	RYK-AF201A	RYK-AF202A	RYK-AF203A	RYK-AF204A
Image Device	1/4" Color Sony Super HAD	1/4" Color Sony Super HAD (Hi-Res.)	1/4" Color Sony Super HAD	1/4" Color Sony EX-View HAD (Hi-Res.)
Picture Elements	NTSC:510x492, PAL:500x582	NTSC:768x494, PAL:752x582	NTSC:510x492, PAL:500x582	NTSC:768x494, PAL:752x582
Resolution	330 TVL	470 TVL	330 TVL	470 TVL
Min. Illumination	0.3 Lux / F1.6	0.7 Lux / F1.6	0.1 Lux (Night / BW), 0.3 Lux (Day / Color) / F1.6	0.01 Lux (Night / BW), 0.5 Lux (Day / Color) / F1.6
S/N Ratio	More than 48dB			
Electronic Shutter	NTSC:1/60~1/30,000, PAL:1/50~1/30,000			
Flickerless Mode	On / Off (NTSC:1/100, PAL:1/120)			
Iris Control	Auto / Manual			
Lens Furnished	22x Auto Focus Zoom (3.9~85.8mm / F1.6~3.7)		22x (ICR) Auto Focus Zoom (3.9~85.8mm / F1.6~3.7)	
Digital Zoom Ratio	Basic 16x (Total Zoom Ratio 352x), 2x~16x variable			
Mini. Shutting Distance	0.01m (WIDE), 1.0m (TELE)			
Camera Control	RS-485 / RS-422 (option: RS-232)			
Remote Control	6-pin Circular Connect: Zoom, Focus, A/D key, DC12V IN			
Key Control	Tele (Up), Wide (Down), Near (+), Far (-), Menu			
Protocol	YOKO / PELCO D&P / LG			
Zoom Speed	5 / 7 / 9 sec mode			
Zoom / Focus Preset	128 preset points			
Focus Mode	Auto / Manual / Push Auto			
On Screen Display	Set-up menu			
Negative / Positive	On / Off			
Day& Night (ICR)	On / Off		AE / Sensor / Day / Night / External	
Color Control	On / Off		-	
Brightness Control	Manual			
Wide Burst	On / Off			
White Balance	Auto / Hue / Indoor / Outdoor / Manual / Push Auto			
Gain Control	Auto / Manual			
Back Light Comp.	On / Auto (Center / Up / Down / Left / Right) / Super / Off			
Sync. System	Internal / External Line Lock			
Video Output	1 Vp-p / 75 Ohms			
Power Supply	DC12V ± 10%			
Power Consumption	340mA max.			
Operating Temp.	-10°C ~ 50°C			



22x (ICR) Auto Focus Zoom Module



Features

- 22x optical zoom, 16x digital zoom
- Day & Night (option: IR-Cut filter Removable, ICR)
- On Screen Display (OSD) set-up menu
- Camera control via RS-232 (TTL Level)
- Support functions: AI, AWB, AGC, BLC, FL, Positive / Negative
- Support LG protocol



• RYK-20AZR/200ZR



• RYK-20AZ/200Z

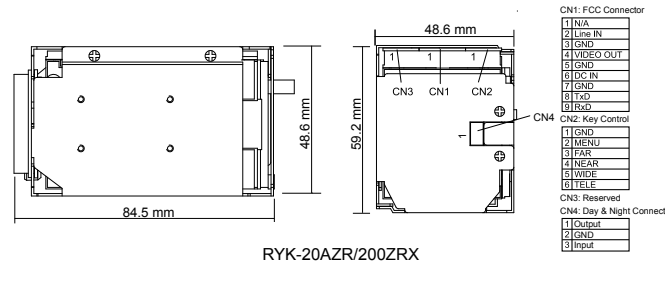
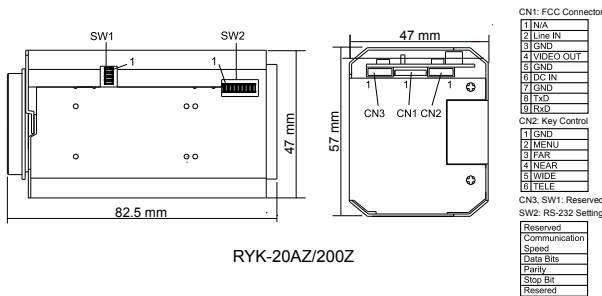

Model No.	RYK-20AZ	RYK-200Z	RYK-20AZR	RYK-200ZR
Image Device	1/4" Color Sony Super HAD	1/4" Color Sony Super HAD (Hi-Res.)	1/4" Color Sony Super HAD	1/4" Color Sony EX-View HAD (Hi-Res.)
Picture Elements	NTSC:510x492, PAL:500x582	NTSC:768x494, PAL:752x582	NTSC:510x492, PAL:500x582	NTSC:768x494, PAL:752x582
Resolution	330 TVL	470 TVL	330 TVL	470 TVL
Min. Illumination	0.3 Lux / F1.6	0.7 Lux / F1.6	0.1 Lux (Night / BW), 0.3 Lux (Day / Color) / F1.6	0.01 Lux (Night / BW), 0.5 Lux (Day / Color) / F1.6
S/N Ratio	More than 48dB			
Electronic Shutter	NTSC:1/60~1/30,000 , PAL:1/50~1/30,000			
Flickerless Mode	On / Off (NTSC:1/100, PAL:1/120)			
Iris Control	Auto / Manual			
Lens Furnished	22x Auto Focus Zoom (3.9~85.8mm / F1.6~3.7)		22x (ICR) Auto Focus Zoom (3.9~85.8mm / F1.6~3.7)	
Digital Zoom Ratio	Basic 16x (Total Zoom Ratio 352x), 2x~16x variable			
Mini. Shutting Distance	0.01m (WIDE), 1.0m (TELE)			
Camera Control	RS-232 (TTL Level)			
Remote Control	6-pin Dry Contact Connector: Tele, Wide, Near, Far, Menu, GND			
Protocol	LG			
Zoom Speed	5 / 7 / 9 sec mode			
Zoom / Focus Preset	128 preset points			
Focus Mode	Auto / Manual / Push Auto			
On Screen Display	Set-up menu			
Negative / Positive	On / Off			
Day & Night (ICR)	On / Off		AE / Sensor / Day / Night / External	
Color Control	On / Off		-	
Brightness Control	Manual			
Wide Burst	On / Off			
White Balance	Auto / Hue / Indoor / Outdoor / Manual / Push Auto			
Gain Control	Auto / Manual			
Back Light Comp.	On / Auto (Center / Up / Down / Left / Right) / Super / Off			
Sync. System	Internal / External Line Lock			
Video Output	1 Vp-p / 75 Ohms			
Power Supply	DC12V ± 10%			
Power Consumption	340mA max.			
Operating Temp.	-10°C ~ 50°C			

• Dry Contact is either open under normal status (Normal Open) or close to GND under active status (connected to GND).

Wide Dynamic Range (WDR) Camera



Features

- Camera with 1/3" Color Sony Vertical double-Density WD CCD
- High sensitivity, low smear, high anti-blooming and high S/N ratio
- IR-Cut filter Removable (ICR) provides change from color to B/W mode automatically or manually for day and night 24-hour surveillance
- On Screen Display (OSD) set-up menu
- Remote control via RS-485/422 (option: RS-232)
- Special functions: Flickerless, Mirror, Freeze, Line Lock, Positive / Negative, Camera ID, Camera Title, Privacy Masking, Digital Zoom, Digital Slow Shutter

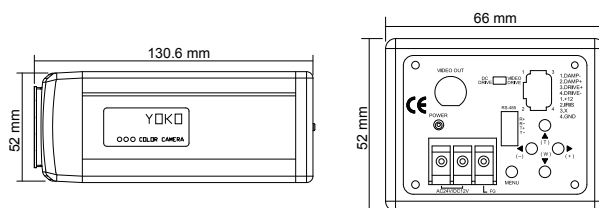

Controller :



RYK-8330
(RS-485)

Model No.	RYK-491DR
Image Device	1/3" Color Sony Vertical double-Density WD CCD (Hi-Res.)
Picture Elements	NTSC:768x494, PAL:752x582
Resolution	470 TVL
Min. Illumination	0.1 Lux (Night / BW), 0.001 Lux (DSS) / F1.2
S/N Ratio	More than 48dB
Electronic Shutter	NTSC:1/60~1/100,000, PAL:1/50~1/100,000
Flickerless Mode	On / Off (NTSC:1/100, PAL:1/120)
Iris Control	Video / DC Drive
Lens Mount	C / CS
Gamma	0.45
White Balance	Auto / Indoor / Outdoor / Manual / Push Auto
Gain Control	Auto / Manual
Back Light Comp.	On / Off (Level & Area adjustable)
Wide Dynamic Range (WDR)	On / Off (Level adjustable)
Day & Night (ICR)	AE / Sensor / Day / Night
Digital Zoom	3x
Camera ID	000~255
Camera Title	Up to 16 characters
Mirror	Off / Horizontal / Vertical / Rotate
Privacy Masking	8 free areas (Area size adjustable)
Freeze	On / Off
Positive / Negative	On / Off
Digital Slow Shutter (DSS)	Off, 2~20, 40, 80, 160 FLD
Remote Control	RS-485 / RS-422 (option: RS-232)
Protocol	YOKO / PELCO D&P / LG
Sync. System	Internal / External Line Lock
Video Output	1 Vp-p / 75 Ohms
Power Supply	DC12V/AC24V Dual (option: AC110~240V)
Power Consumption	Dual: 5.8W max., AC: 7W max.
Operating Temp.	-10°C ~ 50°C



Hi-Res. OSD Camera



Features

- Camera with 1/3" Color Sony Hi-Res. (550TVL) EX-View HAD
- High sensitivity, low smear, high anti-blooming and high S/N ratio
- IR-Cut filter Removable (ICR) provides change from color to B/W mode automatically or manually for day and night 24-hour surveillance
- On Screen Display (OSD) set-up menu
- Special functions: Flickerless, Mirror, Line Lock, Positive / Negative, Camera ID, Camera Title, Privacy Masking

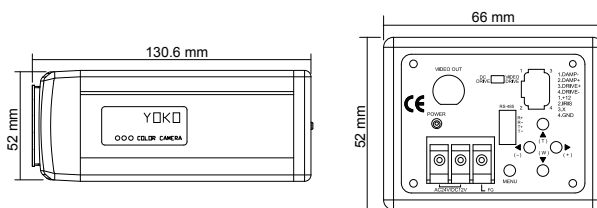

Controller :



RYK-8330
(RS-485)

Model No.	RYK-493DR	RYK-493DRX
Image Device	1/3" Color Sony Super HAD (Hi-Res.)	1/3" Color Sony EX-View HAD (Hi-Res.)
Picture Elements	NTSC:768x494, PAL:752x582	
Resolution	550 TVL	
Min. Illumination	0.05 Lux (Night / BW), 0.8 Lux (Day / Color) / F2.0	0.01 Lux (Night / BW), 0.5 Lux (Day / Color) / F2.0
S/N Ratio	More than 48dB	
Electronic Shutter	NTSC:1/60~1/100,000, PAL:1/50~1/100,000	
Flickerless Mode	On / Off (NTSC:1/100, PAL:1/120)	
Iris Control	Video / DC Drive	
Lens Mount	C / CS	
Gamma	0.45	
White Balance	Auto / Indoor / Outdoor / Manual / Push Auto	
Gain Control	Auto / Manual	
Back Light Comp.	On / Off (Level & Area adjustable)	
Day & Night (ICR)	AE / Sensor / Day / Night	
Camera ID	000~255	
Camera Title	Up to 16 characters	
Mirror	On / Off	
Privacy Masking	8 free areas (Area size adjustable)	
Positive / Negative	On / Off	
Remote Control	RS-485 / RS-422 (option: RS-232)	
Protocol	YOKO / PELCO D&P / LG	
Sync. System	Internal / External Line Lock	
Video Output	1 Vp-p / 75 Ohms	
Power Supply	DC12V/AC24V Dual (option: AC100~240V)	
Power Consumption	Dual: 4.1W max., AC: 4.9W max.	
Operating Temp.	-10°C ~ 50°C	

Vari-Focal IR Camera



Features

- Sony Super HAD CCD sensor
- Built-in Vari-Focal Lens
- Day & Night (IR-Cut filter Removable, ICR)
- DC or DC/AC Dual voltage
- Option Model:
 RYK-232VF3/235VF3 – without IR LED & ICR
 RYK-232VF9/235VF9 – without IR LED & ICR,
 9~22mm VF Lens

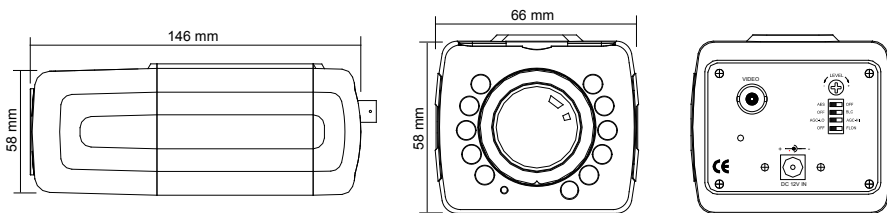

Model No.	RYK-235LVR3	RYK-232LVR3
Image Device	1/3" Color Sony Super HAD	1/3" Color Sony Super HAD (Hi-Res.)
Picture Elements	NTSC:510x492, PAL:500x582	NTSC:768x494, PAL:752x582
Resolution	380 TVL	470 TVL
Min. Illumination	0.2 Lux / F2.0 (Day), 0 Lux (IR On)	0.3 Lux / F2.0 (Day), 0 Lux (IR On)
S/N Ratio	More than 48dB	
Electronic Shutter	NTSC:1/60~1/100,000, PAL:1/50~1/110,000	
Flickerless Mode	On / Off (NTSC:1/100, PAL:1/120)	
Gamma	0.45	
Iris Control	DC Drive	
Lens Furnished	Vari-Focal 3.7~12mm (ICR) / F1.6~3.0, Wide: 71.6°x55.8°, Tele: 23.8°x17.9° (HxV)	
White Balance	Auto	
Gain Control	High / Low	
Back Light Comp.	On / Off	
Day & Night (ICR)	Auto	
Sync. System	Internal	
Video Output	1 Vp-p / 75 Ohms	
Audio Output	2 Vp-p / 50 Ohms (option)	
Infrared Luminary	10 pieces IR-LED	
Wavelength	850 nm	
Illuminate Distance	10 M	
Power Supply	DC12V ± 10% (option: DC12V/AC24V Dual)	
Power Consumption	DC	IR On: 320mA max., IR Off: 160mA max.
	DUAL	IR On: DC12V/320mA, AC24V/4.0W max. IR Off: DC12V/180mA, AC24V/3.2W max.
Operating Temp.	-10°C ~ 50°C	



Vari-Focal Camera



Features

- Sony Super HAD CCD sensor
- Built-in 3.7~12mm / 9.0~22mm Vari-Focal Lens
- AC or DC/AC Dual voltage

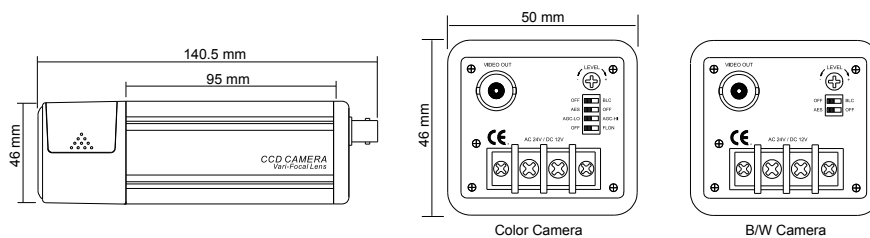

Model No.	RYK-475ZM3	RYK-472ZM3	RYK-775ZM3	RYK-777ZM3
	RYK-475ZM9	RYK-472ZM9	RYK-775ZM9	RYK-777ZM9
Image Device	1/3" Color Sony Super HAD	1/3" Color Sony Super HAD (Hi-Res.)	1/3" B/W Sony Super HAD	1/3" B/W Sony Super HAD (Hi-Res.)
Picture Elements	NTSC:510x492, PAL:500x582	NTSC:768x494, PAL:752x582	EIA:510x492, CCIR:500x582	EIA:768x494, CCIR:752x582
Resolution	380 TVL	470 TVL	420 TVL	600 TVL
Min. Illumination	0.2 Lux / F2.0	0.3 Lux / F2.0	0.1 Lux / F2.0	0.2 Lux / F2.0
S/N Ratio	More than 48dB			
Electronic Shutter	NTSC:1/60~1/100,000, PAL:1/50~1/110,000		EIA:1/60~1/100,000, CCIR:1/50~1/110,000	
Flickerless Mode	On / Off (NTSC:1/100, PAL:1/120)		-	
Gamma	0.45			
Iris Control	DC Drive			
Lens Furnished	ZM3 model: Vari-Focal 3.7~12mm / F1.6~3.0, Wide: 71.6°x55.8°, Tele: 23.8°x17.9° (HxV) ZM9 model: Vari-Focal 9.0~22mm / F2.0~360, Wide:29.2°x21.7°, Tele:13.0°x9.7° (HxV)			
White Balance	Auto		-	
Gain Control	High / Low		Auto	
Back Light Comp.	On / Off			
Sync. System	Internal			
Video Output	1 Vp-p / 75 Ohms			
Power Supply	AC100~240V (option: AC24V, AC110V, DC12V/AC24V Dual)			
Power Consumption	3.3W max.	4.6W max.	3.1W max.	3.3W max.
Operating Temp.	-10°C ~ 50°C			

Color CCD Camera

Features

- Sony Super HAD CCD sensor
- Hi-Res. 550 TVL
Improvement of color-rolling suppression
(for RYK-213F/413F)
- Video / DC Drive
- DC, AC or DC/AC Dual voltage



• RYK-275F / 272F / 277F



• RYK-213F

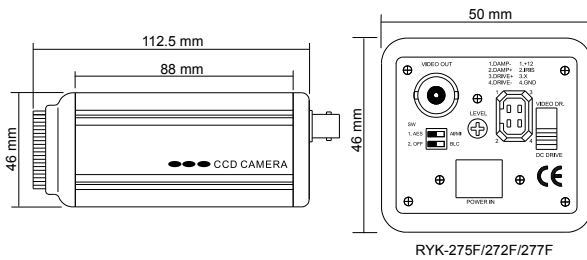

RYK-275F/272F/277F

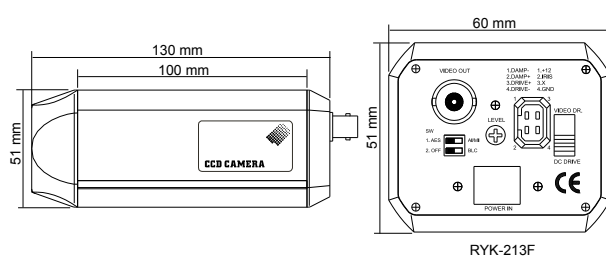

RYK-213F

Model No.	DC	RYK-275F	RYK-272F	RYK-213F
	AC	RYK-475F	RYK-472F	RYK-413F
Image Device		1/3" Color Sony Super HAD	1/3" Color Sony Super HAD (Hi-Res.)	1/3" Color Sony Super HAD (Hi-Res.)
Picture Elements		NTSC:510x492, PAL:500x582	NTSC:768x494, PAL:752x582	NTSC:768x494, PAL:752x582
Resolution		380 TVL	470 TVL	550 TVL
Min. Illumination		0.1 Lux / F1.2	0.2 Lux / F1.2	0.2 Lux / F1.2
S/N Ratio		More than 48dB		
Electronic Shutter		NTSC:1/60~1/100,000, PAL:1/50~1/110,000		
Gamma		0.45		
Iris Control		Video / DC Drive		
Lens Mount		C / CS		
White Balance		Auto		
Gain Control		Auto		
Back Light Comp.		On / Off		
Sync. System		Internal		
Video Output		1 Vp-p / 75 Ohms		
Audio Output		2 Vp-p / 50 Ohms (option, for DC type only)		
Power Supply	DC	DC12V ± 10%		
	AC	AC24V, AC110V, AC100~240V, DC12V/AC24V Dual (option)		
Power	DC	225mA max.	125mA max.	175mA max.
Consumption	AC	3.2W max.	2.5W max.	3.2W max.
Operating Temp.		-10°C ~ 50°C		

Series Model:

Model No.	Description
RYK-277F	1/4" Color Sony Super HAD, 330 TVL, 0.2 Lux / F1.2, DC12V (option: Audio function)
RYK-477F	1/4" Color Sony Super HAD, 330 TVL, 0.2 Lux / F1.2, AC or DC12V/AC24V Dual (option)



B/W CCD Camera

Features

- Sony Super HAD CCD sensor
- Employs DSP IC for image control
Provide high resolution, sharpness image quality
(for RYK-572F/772F/573F/773F)
- Video / DC Drive
- DC, AC or DC/AC Dual voltage

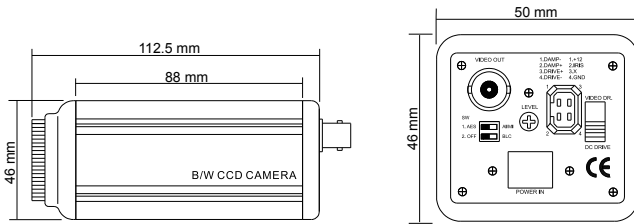

Model No.	DC	RYK-575F	RYK-577F	RYK-572F	RYK-573F
	AC	RYK-775F	RYK-777F	RYK-772F	RYK-773F
Image Device		1/3" B/W Sony Super HAD	1/3" B/W Sony Super HAD (Hi-Res.)	1/3" B/W Sony Super HAD (DSP IC)	1/3" B/W Sony Super HAD (Hi-Res., DSP IC)
Picture Elements		EIA:510x492, CCIR:500x582	EIA:768x494, CCIR:752x582	EIA:510x492, CCIR:500x582	EIA:768x494, CCIR:752x582
Resolution		420 TVL	600 TVL	510 TVL	710 TVL
Min. Illumination		0.05 Lux / F1.2	0.1 Lux / F1.2	0.05 Lux / F1.2	0.1 Lux / F1.2
S/N Ratio		More than 48dB			
Electronic Shutter		EIA:1/60~1/100,000, CCIR:1/50~1/110,000			
Gamma		0.45			
Iris Control		Video / DC Drive			
Lens Mount		C / CS			
Gain Control		Auto			
Back Light Comp.		On / Off			
Sync. System		Internal			
Video Output		1 Vp-p / 75 Ohms			
Audio Output		2 Vp-p / 50 Ohms (option, for DC type only)			
Power Supply	DC	DC12V ± 10%			
	AC	AC24V, AC110V, AC100~240V, DC12V/AC24V Dual (option)			
Power	DC	110mA max.	138mA max.	109mA max.	115mA max.
Consumption	AC	2.0W max.	2.5W max.	2.5W max.	2.6W max.
Operating Temp.		-10°C ~ 50°C			

Camera Kit

Features

- Sony Super HAD CCD sensor
- Camera kit with mini size
- Built-in Audio function
- Furnished with lens and mounting bracket

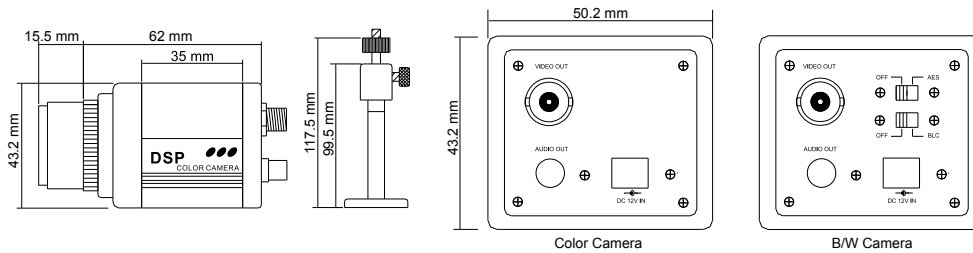

Model No.	RYK-264K	RYK-569K
Image Device	1/4" Color Sony Super HAD	1/3" B/W CCD
Picture Elements	NTSC:510x492, PAL:500x582	EIA:510x492, CCIR:500x582
Resolution	330 TVL	400 TVL
Min. Illumination	0.5 Lux / F2.0	0.3 Lux / F2.0
S/N Ratio	More than 48dB	
Electronic Shutter	NTSC:1/60~1/100,000, PAL:1/50~1/110,000	EIA:1/60~1/120,000, CCIR:1/50~1/120,000
Gamma	0.45	
Lens Furnished	Board Lens 3.6mm / F2.0 (option:3.5~8mm / F1.4~C), CS mount	
White Balance	Auto	—
Gain Control	Auto	
Back Light Comp.	—	On / Off
Sync. System	Internal	
Video Output	1 Vp-p / 75 Ohms	
Audio Output	2 Vp-p / 50 Ohms	
Mounting Bracket	Metal	
Power Supply	DC12V ± 10%	
Power Consumption	117mA max.	100mA max.
Operating Temp.	-10°C ~ 50°C	

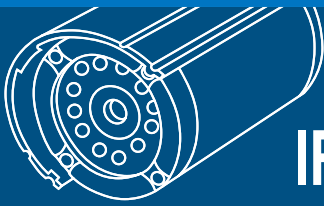

IR Camera Selection Guide

Picture	Model No.	Sensor	Illuminate Distance	IR-LED	IP	TVL	Min Illumination	Lens	Voltage	Page		
	RYK-2F49L5	1/3" CL	50M	84	66	380	0.2 Lux	Board Lens	DC, AC	15		
	RYK-2F85L5					470	0.3 Lux					
	RYK-3F41L5	1/3" BW				420	0.1 Lux					
	RYK-3F43L5					600	0.2 Lux					
	RYK-2V87C	1/3" CL	40M	56	66	380	0.1 Lux	Board Lens	DC, AC	16		
	RYK-2V85C	1/3" BW DSP (EX-View)				420						
		1/3" CL				470						
		1/3" BW DSP (EX-View)				420						
	RYK-2R49VF3(VF9)	1/3" CL	20M	24	66	380	0.2 Lux	Vari Focal	DC	17		
	RYK-2R85VF3(VF9)					470	0.3 Lux					
	RYK-2R49XVR3	1/3" CL (EX-View)				380	0.05 Lux	Vari Focal (ICR)				
	RYK-2R85XVR3					470	0.15 Lux					
	RYK-2L49	1/3" CL	20M	24	67	380	0.2 Lux	Board Lens	DC, AC	18		
	RYK-2L85					470	0.3 Lux					
	RYK-3L41	1/3" BW				420	0.1 Lux					
	RYK-3L43					600	0.2 Lux					
	RYK-2Q49L2	1/3" CL	20M	24	66	380	0.2 Lux	Board Lens	DC, AC	19		
	RYK-2Q49L3		30M	36								
	RYK-2Q85L2		20M	24								
	RYK-2Q85L3		30M	36								
	RYK-3Q41L2	1/3" BW	20M	24		420	0.1 Lux					
	RYK-3Q41L3		30M	36								
	RYK-3Q43L2		20M	24								
	RYK-3Q43L3		30M	36								
	RYK-2B49	1/3" CL	10M	12	67	380	0.2 Lux	Board Lens	DC	20		
	RYK-2B85										470	0.3 Lux
	RYK-3B41	1/3" BW									420	0.1 Lux
	RYK-3B43										600	0.2 Lux
	RYK-2A47L	1/4" CL	10M	8	—	330	0.5 Lux	Board Lens	DC	21		

50M IR Camera



Features

- Built-in 84 pieces IR-LED
- Effective range up to 50M
- Weatherproofing criterion IP 66
- AC type (option)

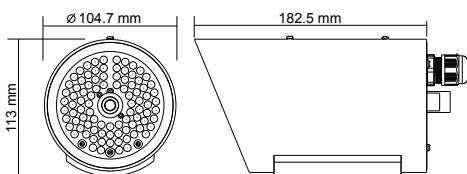

RKY-8800/8801
Infrared Illuminator

Model No.	RKY-2F49L5	RKY-2F85L5	RKY-3F41L5	RKY-3F43L5
Image Device	1/3" Color Sony Super HAD	1/3" Color Sony Super HAD (Hi-Res.)	1/3" B/W Sony Super HAD	1/3" B/W Sony Super HAD (Hi-Res.)
Picture Elements	NTSC:510x492, PAL:500x582	NTSC:768x494, PAL:752x582	EIA:510x492, CCIR:500x582	EIA:768x494, CCIR:752x582
Resolution	380 TVL	470 TVL	420 TVL	600 TVL
Min. Illumination	0.2 Lux / F2.0 (Day), 0 Lux (IR On)	0.3 Lux / F2.0 (Day), 0 Lux (IR On)	0.1 Lux / F2.0 (Day), 0 Lux (IR On)	0.2 Lux / F2.0 (Day), 0 Lux (IR On)
S/N Ratio	More than 48dB			
Electronic Shutter	NTSC:1/60~1/100,000, PAL:1/50~1/110,000		EIA:1/60~1/100,000, CCIR:1/50~1/110,000	
Gamma	0.45			
Lens Furnished	Board Lens 12mm / F2.0 (option:16mm)			
White Balance	Auto		—	
Gain Control	Auto			
Sync. System	Internal			
Video Output	1 Vp-p / 75 Ohms			
Infrared Luminary	84 pieces IR-LED			
Wavelength	850 nm			
Illuminate Distance	50 M			
Waterproofing Criterion	IP 66			
Power Supply	DC12V ± 10%, AC24V, AC100~240V (option)			
Power Consumption	IR On: 1458mA max. IR Off: 125mA max.	IR On: 1050mA max. IR Off: 200mA max.	IR On: 1450mA max. IR Off: 117mA max.	IR On: 1450mA max. IR Off: 117mA max.
Operating Temp.	-10°C ~ 50°C			

■ Infrared Illuminator Model:

Model No.	Description
RKY-8800	30M Infrared Illuminator, Built-in 98 pieces IR-LED, IP 66, DC or AC voltage (option)
RKY-8801	50M Infrared Illuminator, Built-in 98 pieces IR-LED, IP 66, DC or AC voltage (option)

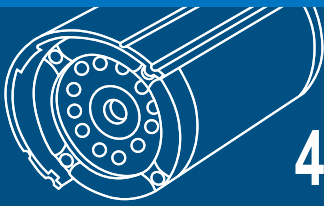

40M IR Camera



Features

- Dual CCD (Color & B/W) camera are exchanged automatically in day time and night time
- Hi-Res. color camera for day time to provide true color and clear picture, EX-View BW camera for night time to enhance sensitivity of low light
- Built-in 56 pieces IR-LED
- Effective range up to 40M
- Weatherproofing criterion IP 66
- AC type (option)

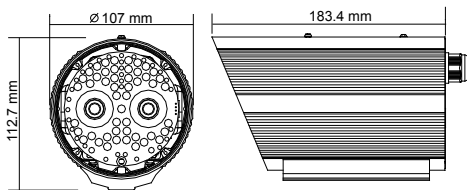

Model No.		RYK-2V87C	RYK-2V85C
Image Device	Color	1/3" Color Sony Super HAD	1/3" Color Sony Super HAD (Hi-Res.)
	B/W	1/3" B/W Sony EX-View HAD	1/3" B/W Sony EX-View HAD
Picture Elements		NTSC/EIA:510x492, PAL/CCIR:500x582	NTSC/EIA:768x494, PAL/CCIR:752x582
Resolution	Color	380 TVL	470 TVL
	B/W	420 TVL	420 TVL
Min. Illumination		0.1 Lux / F 2.0 (Day), 0 Lux (IR On)	
S/N Ratio		More than 48dB	
Electronic Shutter		NTSC/EIA:1/60~1/30,000, PAL/CCIR:1/50~1/30,000	
Gamma		0.45	
Lens Furnished		Board Lens 8mm / F2.0 (option:12mm)	
White Balance		Auto	
Gain Control		Auto	
Sync. System		Internal	
Video Output		1 Vp-p / 75 Ohms	
Infrared Luminary		56 pieces IR-LED	
Wavelength		850 nm	
Illuminate Distance		40 M	
Waterproofing Criterion		IP 66	
Power Supply		DC12V±10%, AC24V, AC100~240V (option)	
Power Consumption		IR On: 700mA max. / IR Off: 140mA max.	
Operating Temp.		-10°C ~ 50°C	

20M Vari-Focal IR Camera



Features

- Built-in 24 pieces IR-LED
- Effective range up to 20M
- Built-in Vari-Focal Lens
- Day & Night (option: IR-Cut filter Removable, ICR)
- Weatherproofing criterion IP 66

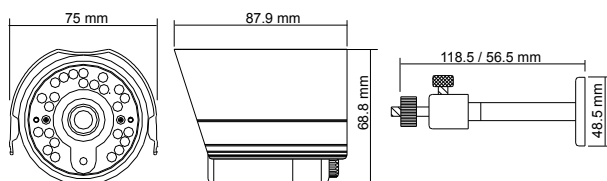

Model No.	RYK-2R49VF3(VF9)	RYK-2R49XVR3	RYK-2R85VF3(VF9)	RYK-2R85XVR3
Image Device	1/3" Color Sony Super HAD	1/3" Color Sony EX-View HAD	1/3" Color Sony Super HAD (Hi-Res.)	1/3" Color Sony EX-View HAD (Hi-Res.)
Picture Elements	NTSC:510x492, PAL:500x582		NTSC:768x494, PAL:752x582	
Resolution	380 TVL		470 TVL	
Min. Illumination	0.2 Lux / F2.0 (Day), 0 Lux (IR On)	0.05 Lux / F2.0 (Day), 0 Lux (IR On)	0.3 Lux / F2.0 (Day), 0 Lux (IR On)	0.15 Lux / F2.0 (Day), 0 Lux (IR On)
S/N Ratio	More than 48dB			
Electronic Shutter	NTSC:1/60~1/100,000, PAL:1/50~1/110,000			
Gamma	0.45			
Lens Furnished	VF3 model : Vari-Focal 3.7~12mm / F1.6~3.0, Wide:71.6°x55.8°, Tele:23.8°x17.9° (HxV) VF9 model : Vari-Focal 9.0~22mm / F2.0~3.6, Wide:29.2°x21.7°, Tele:13.0°x9.7° (HxV) VR3 model : Vari-Focal 3.7~12mm (ICR) / F1.6~3.0, Wide:71.6°x55.8°, Tele:23.8°x17.9° (HxV)			
White Balance	Auto			
Gain Control	Auto			
Sync. System	Internal			
Video Output	1 Vp-p / 75 Ohms			
Infrared Luminary	24 pieces IR-LED			
Wavelength	850 nm			
Illuminate Distance	20 M			
Waterproofing Criterion	IP 66			
Power Supply	DC12V ± 10%			
Power Consumption	IR On: 430mA max. / IR Off: 210mA max.		IR On: 400mA max. / IR Off: 180mA max.	
Operating Temp.	-10°C ~ 50°C			

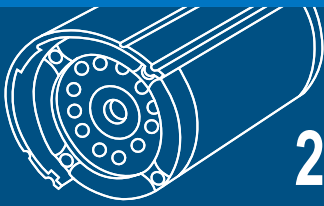

20M IR Camera



Features

- Built-in 24 pieces IR-LED
- Effective range up to 20M
- Weatherproofing criterion IP 67
- AC type (option)

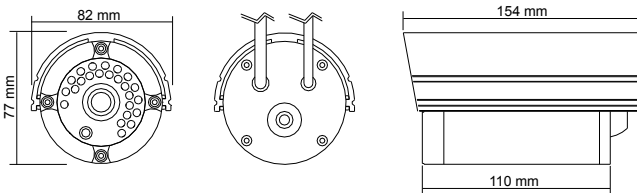

Model No.	RYK-2L49	RYK-2L85	RYK-3L41	RYK-3L43
Image Device	1/3" Color Sony Super HAD	1/3" Color Sony Super HAD (Hi-Res.)	1/3" B/W Sony Super HAD	1/3" B/W Sony Super HAD (Hi-Res.)
Picture Elements	NTSC:510x492, PAL:500x582	NTSC:768x494, PAL:752x582	EIA:510x492, CCIR:500x582	EIA:768x494, CCIR:752x582
Resolution	380 TVL	470 TVL	420 TVL	600 TVL
Min. Illumination	0.2 Lux / F2.0 (Day), 0 Lux (IR On)	0.3 Lux / F2.0 (Day), 0 Lux (IR On)	0.1 Lux / F2.0 (Day), 0 Lux (IR On)	0.2 Lux / F2.0 (Day), 0 Lux (IR On)
S/N Ratio	More than 48dB			
Electronic Shutter	NTSC:1/60~1/100,000, PAL:1/50~1/110,000		EIA:1/60~1/100,000, CCIR:1/50~1/110,000	
Gamma	0.45			
Lens Furnished	Board Lens 3.6mm / F2.0 (option:4.3/6/8/12/16mm)			
White Balance	Auto		—	
Gain Control	Auto			
Sync. System	Internal			
Video Output	1 Vp-p / 75 Ohms			
Infrared Luminary	24 pieces IR-LED			
Wavelength	850 nm			
Illuminate Distance	20 M			
Waterproofing Criterion	IP 67			
Power Supply	DC12V ± 10% (option: AC24V, AC110~240V)			
Power Consumption	IR On: 567mA max. IR Off: 125mA max.	IR On: 420mA max. IR Off: 200mA max.	IR On: 542mA max. IR Off: 108mA max.	IR On: 542mA max. IR Off: 117mA max.
Operating Temp.	-10°C ~ 50°C			

20M / 30M IR Camera



Features

- Built-in 24 / 36 pieces IR-LED
- Effective range up to 20M / 30M
- Weatherproofing criterion IP 66
- AC type (option)

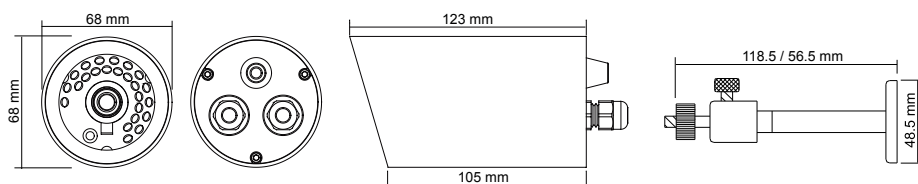

Model No.	RYK-2Q49L2		RYK-2Q85L2		RYK-3Q41L2		RYK-3Q43L2	
	RYK-2Q49L3		RYK-2Q85L3		RYK-3Q41L3		RYK-3Q43L3	
Image Device	1/3" Color Sony Super HAD		1/3" Color Sony Super HAD (Hi-Res.)		1/3" B/W Sony Super HAD		1/3" B/W Sony Super HAD (Hi-Res.)	
Picture Elements	NTSC:510x492, PAL:500x582		NTSC:768x494, PAL:752x582		EIA:510x492, CCIR:500x582		EIA:768x494, CCIR:752x582	
Resolution	380 TVL		470 TVL		420 TVL		600 TVL	
Min. Illumination	0.2 Lux / F2.0 (Day), 0 Lux (IR On)		0.3 Lux / F2.0 (Day), 0 Lux (IR On)		0.1 Lux / F2.0 (Day), 0 Lux (IR On)		0.2 Lux / F2.0 (Day), 0 Lux (IR On)	
S/N Ratio	More than 48dB							
Electronic Shutter	NTSC:1/60~1/100,000, PAL:1/50~1/110,000				EIA:1/60~1/100,000, CCIR:1/50~1/110,000			
Gamma	0.45							
Lens Furnished	L2 model: Board Lens 3.6mm / F2.0 (option:4.3/6/8/12/16mm) L3 model: Board Lens 6.0mm / F2.0 (option:8/12/16mm)							
White Balance	Auto				—			
Gain Control	Auto							
Sync. System	Internal							
Video Output	1 Vp-p / 75 Ohms							
Infrared Luminary	L2 model: 24 pieces, L3 model: 36 pieces							
Illuminate Distance	L2 model: 20M, L3 model: 30M							
Wavelength	850 nm							
Waterproofing Criterion	IP 66							
Power Supply	DC12V±10% (option: AC24V, AC110~240V)							
Power Consumption	L2	IR On: 567mA max. IR Off: 125mA max.	IR On: 420mA max. IR Off: 200mA max.	IR On: 542mA max. IR Off: 108mA max.	IR On: 542mA max. IR Off: 117mA max.			
	L3	IR On: 692mA max. IR Off: 125mA max.	IR On: 540mA max. IR Off: 200mA max.	IR On: 667mA max. IR Off: 108mA max.	IR On: 667mA max. IR Off: 117mA max.			
Operating Temp.	-10°C ~ 50°C							

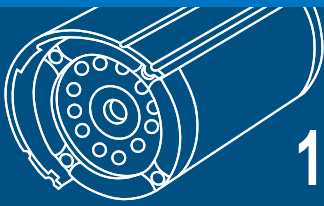

10M IR Camera



Features

- Built-in 12 pieces IR-LED
- Effective range up to 10M
- Weatherproofing criterion IP 67
(exclude Audio type)

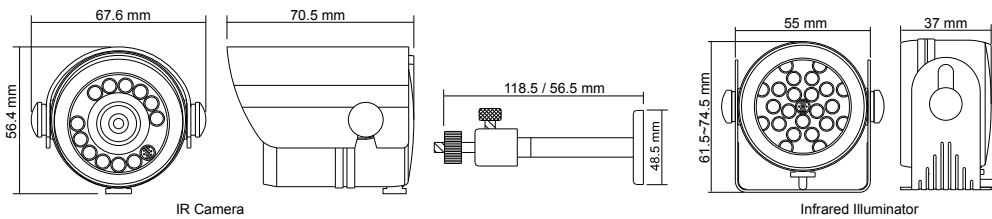

RYK-9041
Infrared Illuminator

Model No.	RYK-2B49	RYK-2B85	RYK-3B41	RYK-3B43
Image Device	1/3" Color Sony Super HAD	1/3" Color Sony Super HAD (Hi-Res.)	1/3" B/W Sony Super HAD	1/3" B/W Sony Super HAD (Hi-Res.)
Picture Elements	NTSC:510x492, PAL:500x582	NTSC:768x494, PAL:752x582	EIA:510x492, CCIR:500x582	EIA:768x494, CCIR:752x582
Resolution	380 TVL	470 TVL	420 TVL	600 TVL
Min. Illumination	0.2 Lux / F2.0 (Day), 0 Lux (IR On)	0.3 Lux / F2.0 (Day), 0 Lux (IR On)	0.1 Lux / F2.0 (Day), 0 Lux (IR On)	0.2 Lux / F2.0 (Day), 0 Lux (IR On)
S/N Ratio	More than 48dB			
Electronic Shutter	NTSC:1/60~1/100,000, PAL:1/50~1/110,000		EIA:1/60~1/100,000, CCIR:1/50~1/110,000	
Gamma	0.45			
Lens Furnished	Board Lens 3.6mm / F2.0 (option:4.3/6/8/12/16mm)			
White Balance	Auto		—	
Gain Control	Auto			
Sync. System	Internal			
Video Output	1 Vp-p / 75 Ohms			
Audio Output	2 Vp-p / 50 Ohms (option)			
Infrared Luminary	12 pieces IR-LED			
Wavelength	850 nm			
Illuminate Distance	10 M			
Waterproofing Criterion	IP 67			
Power Supply	DC12V ± 10%			
Power Consumption	IR On: 292mA max. IR Off: 117mA max.	IR On: 230mA max. IR Off: 150mA max.	IR On: 283mA max. IR Off: 117mA max.	
Operating Temp.	-10°C ~ 50°C			

■ Infrared Illuminator Model:

Model No.	Description
RYK-9041	10M Infrared Illuminator, Built-in 24 pieces IR-LED, IP 67, DC voltage

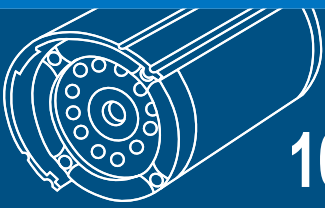

10M IR Camera



Features

- Built-in 8 pieces IR-LED
- Effective range up to 10M
- DC voltage
- Indoor use
- Built-in mounting bracket and connecting cable

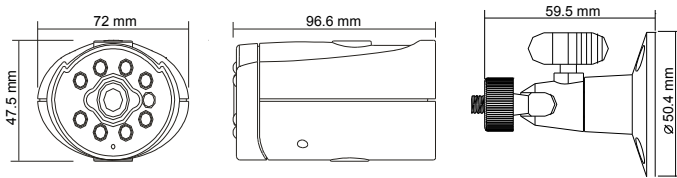

Model Name	RYK-2A47L
Image Device	1/4" Color Sony Super HAD
Picture Elements	NTSC:510x492, PAL:500x582
Resolution	330 TVL
Min. Illumination	0.5 Lux / F2.0 (Day), 0 Lux (IR On)
S/N Ratio	More than 48dB
Electronic Shutter	NTSC:1/60~1/100,000, PAL:1/50~1/110,000
Gamma	0.45
Lens Furnished	Board Lens 3.6mm / F2.0 (option:4.3/6/8/12mm)
White Balance	Auto
Gain Control	Auto
Sync. System	Internal
Video Output	1 Vp-p / 75 Ohms
Audio Output	2 Vp-p / 50 Ohms (option)
Infrared Luminary	8 pieces IR-LED
Wavelength	850 nm
Illuminate Distance	10 M
Power Supply	DC12V ± 10%
Power Consumption	IR On: 250mA max. / IR Off: 125mA max.
Operating Temp.	-10°C ~ 50°C

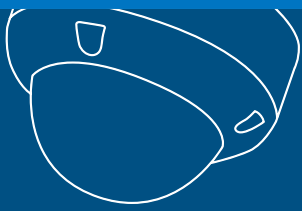

Dome Camera Selection Guide

Picture	Model No.	Feature	Sensor	TVL	Min Illumination	Lens	Voltage	Page	
	RYK-2E00(A&B)	Outdoor Speed Dome	1/4" CL	470	0.7 Lux	22x Zoom	DC, AC	23	
	RYK-2E01(A&B)	Outdoor Speed Dome ICR		1/4" CL (EX-View)	330	0.1 Lux (Night / BW) 0.3 Lux (Day / Color)			22x Zoom (ICR)
	RYK-2E02(A&B)		0.01 Lux (Night / BW) 0.5 Lux (Day / Color)		35x Zoom (ICR)				
	RYK-2E03(A&B)								
	RYK-2E00	Indoor Speed Dome	1/4" CL	470	0.7 Lux	22x Zoom	DC	24	
	RYK-2E01	Indoor Speed Dome ICR		1/4" CL (EX-View)	330	0.1 Lux (Night / BW) 0.3 Lux (Day / Color)			22x Zoom (ICR)
	RYK-2E02		0.01 Lux (Night / BW) 0.5 Lux (Day / Color)		35x Zoom (ICR)				
	RYK-2E03								
	RYK-2E49	Pan / Tilt	1/3" CL	380	0.2 Lux	Board Lens	DC	26	
	RYK-2E85			470	0.3 Lux				
	RYK-2S90LVR3	Vandal-proof WDR / ICR / LED	1/3" CL	470	0.1 Lux (Night / BW) 0.001 Lux (DSS)	Vari Focal (ICR)	DC	27	
	RYK-2S90LVF3	Vandal-proof WDR / LED				Vari Focal			
	RYK-2S49LVF3	Vandal-proof LED							380
	RYK-2S85LVF3	470				0.3 Lux			
	RYK-2S49LVR3	Vandal-proof ICR / LED	1/3" CL (EX-View)	380	0.05 Lux	Vari Focal (ICR)			28
	RYK-2S85LVR3	470		0.15 Lux					
	RYK-2H49LVF3/1	Vandal-proof LED	1/3" CL	380	0.2 Lux	Vari Focal	DC	29	
	RYK-2H85LVF3/1	470		0.3 Lux					
	RYK-2H49LVR3/1	Vandal-proof ICR / LED	1/3" CL (EX-View)	380	0.05 Lux	Vari Focal (ICR)			
	RYK-2H85LVR3/1	470		0.15 Lux					
	RYK-2H49L	Vandal-proof LED	1/3" CL	380	0.2 Lux	Board Lens			
	RYK-2H85L	470		0.3 Lux					
	RYK-2H49VF3(VF9)	Vandal-proof	1/3" CL	380	0.2 Lux	Vari Focal	DC, Dual	30	
	RYK-2H85VF3(VF9)			470	0.3 Lux				
	RYK-2H49			380	0.2 Lux	Board Lens			
	RYK-2H85			470	0.3 Lux				
	RYK-2K49LVF3/1	LED	1/3" CL	380	0.2 Lux	Vari Focal	DC	31	
	RYK-2K85LVF3/1	470		0.3 Lux					
	RYK-2K49LVR3/1	ICR / LED	1/3" CL (EX-View)	380	0.05 Lux	Vari Focal (ICR)			
	RYK-2K85LVR3/1			470	0.15 Lux				
	RYK-2G49L	LED	1/3" CL	380	0.2 Lux	Board Lens	DC	32	
	RYK-2G85L			470	0.3 Lux				
	RYK-3G41L		1/3" BW	420	0.1 Lux				
	RYK-3G43L			600	0.2 Lux				
	RYK-2G49VF3(VF9)	Standard Type	1/3" CL	380	0.2 Lux	Vari Focal	DC, Dual	33	
	RYK-2G85VF3(VF9)			470	0.3 Lux				
	RYK-2G49		1/3" CL	380	0.2 Lux	Board Lens			
	RYK-2G85			470	0.3 Lux				
	RYK-2449VF3(VF9)	Standard Type	1/3" CL	380	0.2 Lux	Vari Focal	DC	34	
	RYK-2485VF3(VF9)			470	0.3 Lux				
	RYK-2411		1/3" CL	380	0.2 Lux	Board Lens			
	RYK-2485			470	0.3 Lux				
	RYK-2J49	Vandal-proof Mini Size	1/3" CL	380	0.2 Lux	Board Lens	DC	35	
	RYK-2J85			470	0.3 Lux				
	RYK-3J41		1/3" BW	420	0.1 Lux				
	RYK-3J43			600	0.2 Lux				
	RYK-2311	Mini Size	1/3" CL	380	0.2 Lux	Board Lens	DC	35	
	RYK-2385			470	0.3 Lux				
	RYK-3341		1/3" BW	420	0.1 Lux				
	RYK-3343			600	0.2 Lux				

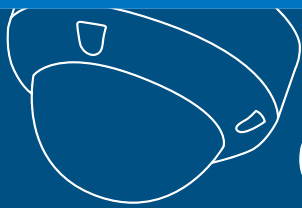

Outdoor Speed Dome Camera



Features

- 35x or 22x optical zoom, 16x digital zoom
- Day & Night (option: IR-Cut filter Removable, ICR)
- On Screen Display (OSD) set-up menu
- 128 present points
- Remote Control via RS-485 (by RYK-8330 control keyboard)
- IP 66 for outdoor, built-in Heater & Fan
- Wall / Pendant / Corner mount for choice

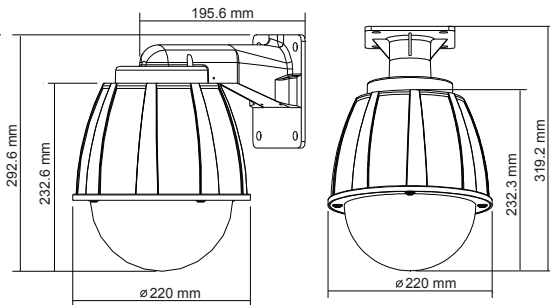

• Wall Mount (A type)

• Pendant Mount (B type)

Controller :



RYK-8330
(RS-485)

Option :



RYK-8728
Wall Mount



RYK-8729
Pendant Mount



RYK-8730
Corner Mount

Model No.	Wall	RYK-2E00A	RYK-2E01A	RYK-2E02A	RYK-2E03A
	Pendant	RYK-2E00B	RYK-2E01B	RYK-2E02B	RYK-2E03B
Image Device		1/4" Color Sony Super HAD (Hi-Res.)	1/4" Color Sony Super HAD	1/4" Color Sony EX-View HAD (Hi-Res.)	
Picture Elements		NTSC:768x494, PAL:752x582	NTSC:510x492, PAL:500x582	NTSC:768x494, PAL:752x582	
Resolution		470 TVL	330 TVL	470 TVL	
Min. Illumination		0.7 Lux / F1.6	0.1 Lux (Night / BW), 0.3 Lux (Day / Color) / F1.6~3.7	0.01 Lux (Night / BW), 0.5 Lux (Day / Color) / F1.6~3.7	
Electronic Shutter		NTSC:1/60~1/30,000, PAL:1/50~1/30,000			
Lens Furnished		22x Auto Focus Zoom (3.9~85.8mm / F1.6~3.7)	22x (ICR) Auto Focus Zoom (3.9~85.8mm / F1.6~3.7)	35x (ICR) Auto Focus Zoom (3.6~126mm / F1.6~4.2)	
Digital Zoom Ratio		Basic 16x (Total Zoom Ratio 352x), 2x~16x variable			Basic 16x (Total Zoom Ratio 560x), 2x~16x variable
Zoom Speed		5 sec			8 sec
Focus Mode		Auto / Manual / Push Auto			
Iris Control		Auto / Manual			
White Balance		Auto / Hue / Indoor / Outdoor / manual / Push Auto			
Day & Night (ICR)		—	AE / Sensor / Day / Night		
Gain Control		Auto / Manual			
Back Light Comp.		On / Off			
Pan / Tilt	Angle	Pan: 360°, Tilt: 0°~90°			
Control	Speed Control	Manual: Pan 1°~150° / sec, Tilt: 1°~100° / sec, Auto: Pan 1°~300° / sec, Tilt: 1°~200° / sec			
Preset Point		128 preset points			
Sequence		6			
Remote Control		RS-485			
Protocol		YOKO / PELCO D&P / LG			
On Screen Display		Set-up menu			
Auto Turn Around		Yes			
Alarm / Relay		6 / 1			
Sync. System		Internal			
Video Output		1 Vp-p / 75 Ohms			
Power Supply		DC12V ± 10% (option: AC24V)			
Power Consumption		DC: 2800mA max. / AC: 2400mA max.			
Operating Temp.		-10°C ~ 50°C			

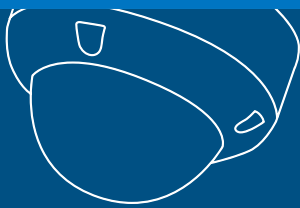

Indoor Speed Dome Camera



Features

- 35x or 22x optical zoom, 16x digital zoom
- Day & Night (option: IR-Cut filter Removable, ICR)
- On Screen Display (OSD) set-up menu
- 128 present points
- Remote Control via RS-485 (by RYK-8330 control keyboard)
- In-Ceiling or Surface installation application



• Surface



• In-ceiling

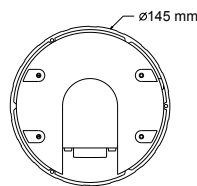
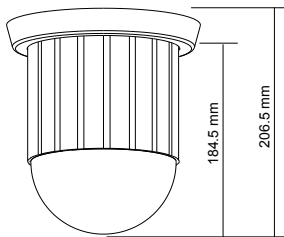

Embedded Mount

Controller :



RYK-8330
(RS-485)

Model No.	RYK-2E00	RYK-2E01	RYK-2E02	RYK-2E03
Image Device	1/4" Color Sony Super HAD (Hi-Res.)	1/4" Color Sony Super HAD	1/4" Color Sony EX-View HAD (Hi-Res.)	
Picture Elements	NTSC:768x494, PAL:752x582	NTSC:510x492, PAL:500x582	NTSC:768x494, PAL:752x582	
Resolution	470 TVL	330 TVL	470 TVL	
Min. Illumination	0.7 Lux / F1.6	0.1 Lux (Night / BW), 0.3 Lux (Day / Color) / F1.6~3.7	0.01 Lux (Night / BW), 0.5 Lux (Day / Color) / F1.6~3.7	
Electronic Shutter	NTSC:1/60~1/30,000, PAL:1/50~1/30,000			
Lens Furnished	22x Auto Focus Zoom (3.9~85.8mm / F1.6~3.7)	22x (ICR) Auto Focus Zoom (3.9~85.8mm / F1.6~3.7)	35x (ICR) Auto Focus Zoom (3.6~126mm / F1.6~4.2)	
Digital Zoom Ratio	Basic 16x (Total Zoom Ratio 352x), 2x~16x variable			Basic 16x (Total Zoom Ratio 560x), 2x~16x variable
Zoom Speed	5 sec			8 sec
Focus Mode	Auto / Manual / Push Auto			
Iris Control	Auto / Manual			
White Balance	Auto / Hue / Indoor / Outdoor / manual / Push Auto			
Day / Night (ICR)	—	AE / Sensor / Day / Night		
Gain Control	Auto / Manual			
Back Light Comp.	On / Off			
Pan / Tilt	Angle	Pan: 360°, Tilt: 0°~90°		
Control	Speed Control	Manual: Pan 1°~150° / sec, Tilt: 1°~100° / sec, Auto: Pan 1°~300° / sec, Tilt: 1°~200° / sec		
Preset Point	128 preset points			
Sequence	6			
Remote Control	RS-485			
Compatible Protocol	YOKO / PELCO D&P / LG			
On Screen Display	Set-up menu			
Auto Turn Around	Yes			
Alarm / Relay	6 / 1			
Sync. System	Internal			
Video Output	1 Vp-p / 75 Ohms			
Power Supply	DC12V±10%			
Power Consumption	1083mA max.			
Operating Temp.	-10°C ~ 50°C			

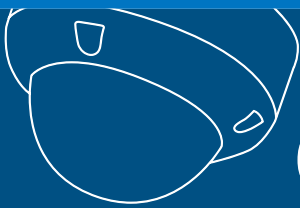

Control Keyboard

Features

- 3-AXIS Joystick for P/T/Z and simple manual operation
- Support CCTV system control
- Support 255 device on the control bus, included cameras or receivers
- One master controller can connect 31 slave controllers
- Control every function of cameras and P/T/Z Receivers on the control bus
- Remote control by RS-485
- User-friendly LCD display
- Protocol, communication parameter, controller ID and password via set-up menu



System Configuration

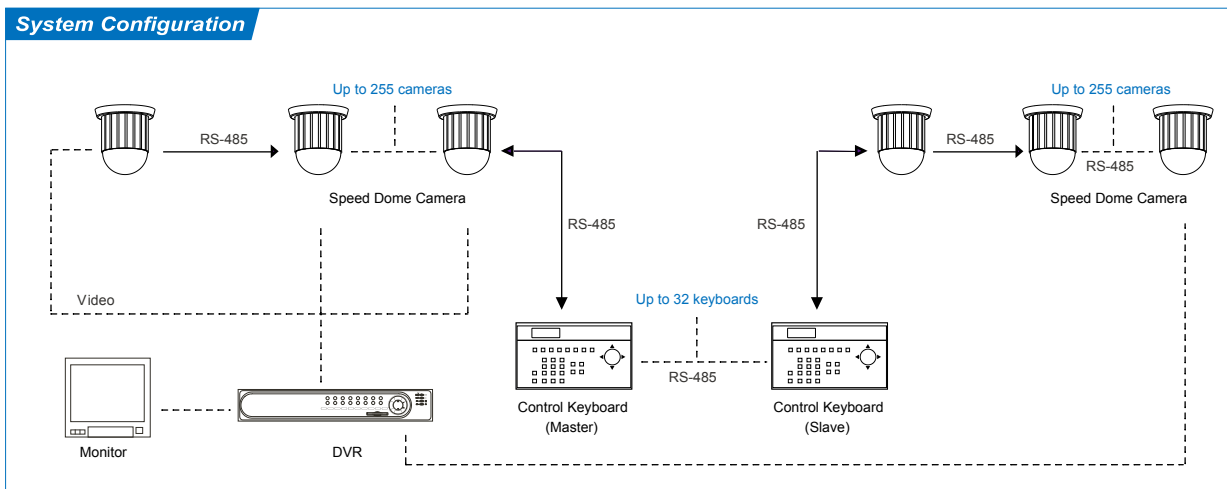

Model No.		RYK-8330
Control Device		255 device
Controller Interface		RS-485
Data Speed		9600bps
Pan/Tilt Control	Manual	Pan: Right / Left Tilt: Up / Down
	Auto	Pan: On / Off Sequence: On / Off
Lens Control	Zoom	Tele / Wide
	Focus	Near / Far / Auto
	Iris	On / Off / Auto
Camera Control	Preset Position	128 preset points
	Camera Setup	Available
Compatible Camera		Speed Dome, Zoom Camera with PELCO Protocol
Power Supply		DC12V ± 10%
Power Consumption		167mA max.
Operating Temp.		-10°C ~ 40°C
Dimensions (WxHxD)		269x190x53 mm

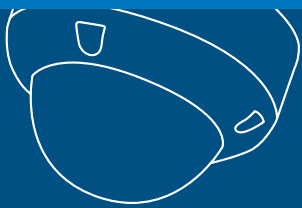

Mini Pan/Tilt Dome Camera

PATENT

Features

- Auto travel function
- Support 6 preset groups (up to 16 preset points)
- Remote control via RS-485 interface
- Built-in 1 alarm input
- Using IR wireless control kit can control up to 9 devices, Using control keyboard can control up to 15 devices
- Patent on special struction for reliability of continuous turning



Dome Camera

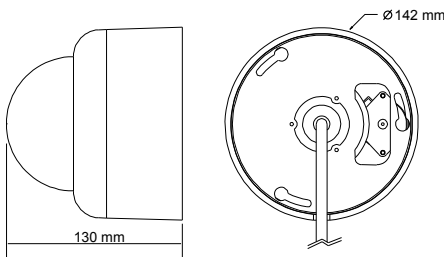
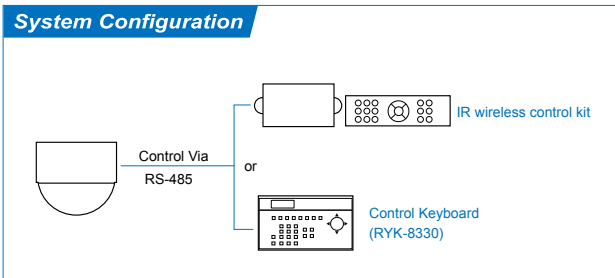

▪ **Controller :**



RYK-8330
(RS-485)

▪ **Option :**



RYK-8719-3
L Type Bracket

Model No.	RYK-2E49	RYK-2E85
Image Device	1/3" Color Sony Super HAD	1/3" Color Sony Super HAD (HI-Res.)
Picture Elements	NTSC:510x492, PAL:500x582	NTSC:768x494, PAL:752x582
Resolution	380 TVL	470 TVL
Min. Illumination	0.2 Lux / F2.0	0.3 Lux / F2.0
Electronic Shutter	NTSC:1/60~1/100,000, PAL:1/50~1/110,000	
Lens	Board Lens 3.6mm / F2.0 (option:2.5/4.3/6/8/12/16mm)	
White Balance	Auto	
Gain Control	Auto	
Back Light Comp.	Yes	
Pan / Tilt Control	Angle	Pan 0°~340°, Tilt: 0°~80°
	Speed Control	Manual: Pan 1°~150° / sec, Tilt: 1°~100° / sec Auto: Pan 1°~300° / sec, Tilt: 1°~200° / sec
Alarm Input	Adjustable N.C. / N.O. property via dip-switch	
Controller Interface	RS-485	
Remote Control	IR wireless control Kit (option: Control Keyboard)	
Preset Point	16 preset points	
Control Command	PELCO D&P protocol	
Sync. System	Internal	
Video Output	1 Vp-p / 75 Ohms	
Power Supply	DC12V ± 10%	
Power Consumption	1000mA max.	
Operating Temp.	-10°C ~ 40°C	

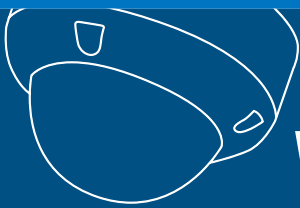

WDR IR Dome Camera

Features

- Rugged and Vandal-proof
- Built-in Vari-Focal DC Drive Lens
- Day & Night (option: IR-Cut filter Removable, ICR)
- 3-Axis Mechanism for free lens rotation
- On Screen Display (OSD) set-up menu
- Special functions: Flickerless, Mirror, Freeze, Line Lock, Positive / Negative, Camera ID, Camera Title, Privacy Masking, Digital Zoom, Digital Slow Shutter, RS-485
- Built-in 24 pieces IR-LED
- Effective range up to 20M
- Weatherproofing criterion IP 66

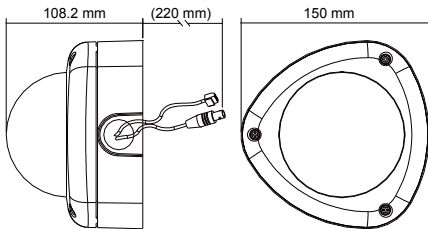

CN1		OSD Button	
1	GND	1	UP (Tele)
2	VRI In	2	MENU (+)
3	DC In	3	RIGHT (+)
4	GND	4	LEFT (-)
5	VIDEO Out	5	DOWN (Wide)
6	GND		
CN2 (RS-485)		CN2 (RS-232 option)	
1	R +	1	RD
2	R -	2	GND
3	T +	3	RD
4	T -	4	GND

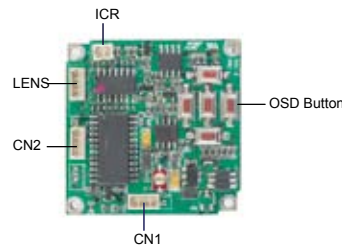

Option :



RYK-8719-3
L Type Bracket

Model No.	RYK-2S90LVF3	RYK-2S90LVR3
Image Device	1/3" Color Sony Vertical double-Density WD CCD (Hi-Res.)	
Picture Elements	NTSC:768x494, PAL:752x582	
Resolution	470 TVL	
Min. Illumination	0.1 Lux (Night / BW), 0.001 Lux (DSS) / F1.2, 0 Lux (IR On)	
S/N Ratio	More than 48dB	
Electronic Shutter	NTSC:1/60~1/100,000, PAL:1/50~1/100,000	
Flickerless Mode	On / Off (NTSC:1/100, PAL:1/120)	
Lens Furnished	Vari-Focal 3.7~12mm / F1.6~3.0, Wide:71.6°×55.8°, Tele:23.8°×17.9° (H×V)	Vari-Focal 3.7~12mm (ICR) / F1.6~3.0, Wide:71.6°×55.8°, Tele:23.8°×17.9° (H×V)
Gamma	0.45	
White Balance	Auto / Indoor / Outdoor / Manual / Push Auto	
Gain Control	Auto / Manual	
Back Light Comp.	On / Off (Level & Area adjustable)	
Wide Dynamic Range (WDR)	On / Off (Level adjustable)	
Day & Night (ICR)	AE / Day / Night	AE / Sensor / Day / Night
Digital Zoom	3x	
Camera ID	000~255	
Camera Title	Up to 16 characters	
Mirror	Off / Horizontal / Vertical / Rotate	
Privacy Masking	8 free areas (Area size adjustable)	
Freeze	On / Off	
On Screen Display	Set-up menu	
Positive / Negative	POSE / NEGA	
Digital Slow Shutter (DSS)	Off, 2~20, 40, 80, 160 FLD	
Remote Control	RS-485 / RS-422 (option: RS-232)	
Protocol	YOKO / PELCO D&P / LG	
Sync. System	Internal / External Line Lock	
Video Output	1 Vp-p / 75 Ohms	
Infrared Luminary	24 pieces IR-LED	
Wavelength	850 nm	
Illumination Distance	20 M	
Power Supply	DC12V ± 10%	
Power Consumption	IR On: 600mA max. / IR Off: 117mA max.	
Operating Temp.	-10°C ~ 50°C	

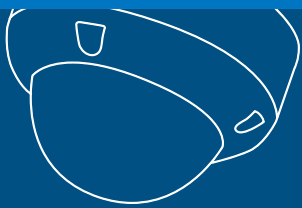

IR Vandal-proof Dome Camera

Features

- Rugged and Vandal-proof
- Built-in Vari-Focal DC Drive Lens
- Day & Night (option: IR-Cut filter Removable, ICR)
- 3-Axis Mechanism for free lens rotation
- Built-in 24 pieces IR-LED
- Effective range up to 20M
- Weatherproofing criterion IP 66



Dome Camera

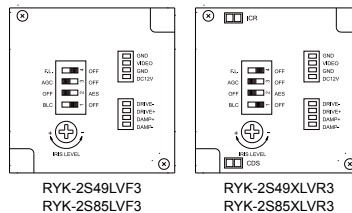
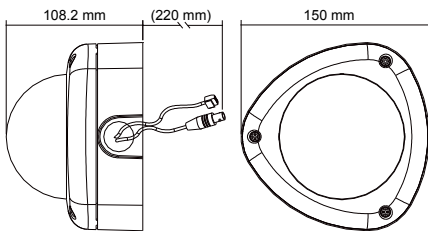

Option :



RYK-8719-3
L Type Bracket

Model No.	RYK-2S49LVF3	RYK-2S85LVF3	RYK-2S49XLVR3	RYK-2S85XLVR3
Image Device	1/3" Color Sony Super HAD	1/3" Color Sony Super HAD (Hi-Res.)	1/3" Color Sony EX-View HAD	1/3" Color Sony EX-View HAD (Hi-Res.)
Picture Elements	NTSC:510x492, PAL:500x582	NTSC:768x494, PAL:752x582	NTSC:510x492, PAL:500x582	NTSC:768x494, PAL:752x582
Resolution	380 TVL	470 TVL	380 TVL	470 TVL
Min. Illumination	0.2 Lux / F2.0 (Day), 0 Lux (IR On)	0.3 Lux / F2.0 (Day), 0 Lux (IR On)	0.05 Lux / F2.0 (Day), 0 Lux (IR On)	0.15 Lux / F2.0 (Day), 0 Lux (IR On)
S/N Ratio	More than 48dB			
Electronic Shutter	NTSC:1/60~1/100,000, PAL:1/50~1/110,000			
Flickless Mode	On/Off (NTSC:1/100, PAL:1/120)			
Gamma	0.45			
Iris Control	DC Drive			
Lens Furnished	Vari-Focal 3.7~12mm / F1.6~3.0, Wide:71.6°x55.8°, Tele:23.8°x17.9° (HxV)		Vari-Focal 3.7~12mm (ICR) / F1.6~3.0, Wide:71.6°x55.8°, Tele:23.8°x17.9° (HxV)	
White Balance	Auto			
Gain Control	High / Low			
Back Light Comp.	On / Off			
Sync. System	Internal			
Video Output	1 Vp-p / 75 Ohms			
Infrared Luminary	24 pieces IR-LED			
Wavelength	850 nm			
Illumination Distance	20 M			
Power Supply	DC12V ± 10%			
Power Consumption	IR On: 425mA max. IR Off: 117mA max.	IR On: 400mA max. IR Off: 200mA max.	IR On: 425mA max. IR Off: 117mA max.	IR On: 400mA max. IR Off: 200mA max.
Operating Temp.	-10°C ~ 50°C			

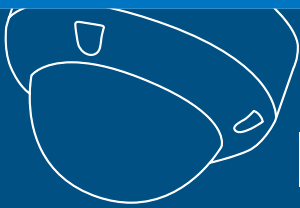

IR Vandal-proof Dome Camera

Features

- Rugged and Vandal-proof
- Built-in Vari-Focal or Board Lens
- Day & Night (option: IR-Cut filter Removable, ICR)
- 3-Axis Mechanism for free lens rotation
- Built-in 24 pieces IR-LED
- Effective range up to 20M
- Weatherproofing criterion IP 66

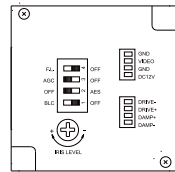
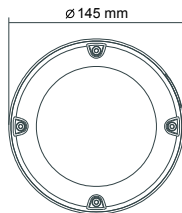
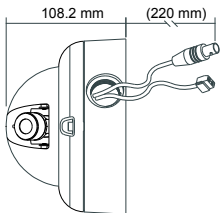

RYK-2H49LVF3/1
RYK-2H85LVF3/1

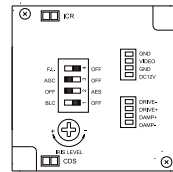

RYK-2H49XLVR3/1
RYK-2H85XLVR3/1

Option :



RYK-8719-3
L Type Bracket

Model No.	RYK-2H49LVF3/1	RYK-2H85LVF3/1	RYK-2H49XLVR3/1	RYK-2H85XLVR3/1
	RYK-2H49L	RYK-2H85L		
Image Device	1/3" Color Sony Super HAD	1/3" Color Sony Super HAD (Hi-Res.)	1/3" Color Sony EX-View HAD	1/3" Color Sony EX-View HAD (Hi-Res.)
Picture Elements	NTSC:510x492, PAL:500x582	NTSC:768x494, PAL:752x582	NTSC:510x492, PAL:500x582	NTSC:768x494, PAL:752x582
Resolution	380 TVL	470 TVL	380 TVL	470 TVL
Min. Illumination	0.2 Lux / F2.0 (Day), 0 Lux (IR On)	0.3 Lux / F2.0 (Day), 0 Lux (IR On)	0.05 Lux / F2.0 (Day), 0 Lux (IR On)	0.15 Lux / F2.0 (Day), 0 Lux (IR On)
S/N Ratio	More than 48dB			
Electronic Shutter	NTSC:1/60~1/100,000, PAL:1/50~1/110,000			
Flickless Mode	On/Off (NTSC:1/100, PAL:1/120)			
Gamma	0.45			
Iris Control	DC Drive (for VF3, VR3 model)			
Lens Furnished	VF3 model : Vari-Focal 3.7~12mm / F1.6~3.0, Wide:71.6°x55.8°, Tele:23.8°x17.9° (HxV) Other model: Board Lens 3.6mm / F2.0 (option:2.5/4.3/6/8/12/16mm)		Vari-Focal 3.7~12mm (ICR) / F1.6~3.0, Wide:71.6°x55.8°, Tele:23.8°x17.9° (HxV)	
White Balance	Auto			
Gain Control	High / Low (for VF3, VR3 model), Auto (for other model)			
Back Light Comp.	On / Off			
Sync. System	Internal			
Video Output	1 Vp-p / 75 Ohms			
Infrared Luminary	24 pieces IR-LED			
Wavelength	850 nm			
Illumination Distance	20 M			
Power Supply	DC12V ± 10%			
Power Consumption	IR On: 400mA max. IR Off: 117mA max.	IR On: 400mA max. IR Off: 200mA max.	IR On: 400mA max. IR Off: 117mA max.	IR On: 400mA max. IR Off: 200mA max.
Operating Temp.	-10°C ~ 50°C			

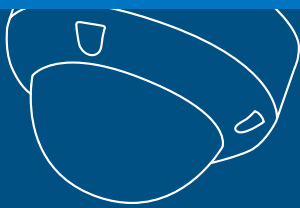

Medium Vandal-proof Dome Camera



Features

- Rugged and Vandal-proof
- Built-in Vari-Focal Lens / Board Lens
- 3-Axis Mechanism for free lens rotation
- Weatherproofing criterion IP 66



Dome Camera

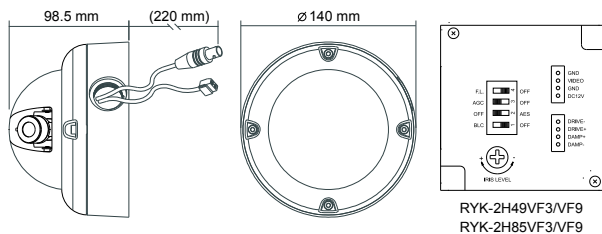

Option :



RYK-8719-3
L Type Bracket

Model No.	RYK-2H49VF3(VF9)	RYK-2H85VF3(VF9)
	RYK-2H49	RYK-2H85
Image Device	1/3" Color Sony Super HAD	1/3" Color Sony Super HAD (Hi-Res.)
Picture Elements	NTSC:510x492, PAL:500x582	NTSC:768x494, PAL:752x582
Resolution	380 TVL	470 TVL
Min. Illumination	0.2 Lux / F2.0	0.3 Lux / F2.0
S/N Ratio	More than 48dB	
Electronic Shutter	NTSC:1/60~1/100,000, PAL:1/50~1/110,000	
Flickerless Mode	On / Off (NTSC:1/100, PAL:1/120)	
Gamma	0.45	
Iris Control	DC Drive (for VF3, VF9 model)	
Lens Furnished	VF3 model : Vari-Focal 3.7~12mm / F1.6~3.0, Wide:71.6°x55.8°, Tele:23.8°x17.9° (HxV) VF9 model : Vari-Focal 9.0~22mm / F2.0~360, Wide:29.2°x21.7°, Tele: 13.0°x9.7° (HxV) Other model: Board Lens 3.6mm / F2.0 (option:2.5/4.3/6/8/12/16mm)	
White Balance	Auto	
Gain Control	High / Low (for VF3, VF9 model), Auto (for other model)	
Back Light Comp.	On / Off (for VF3, VF9 model), Auto (for other model)	
Sync. System	Internal	
Video Output	1 Vp-p / 75 Ohms	
Power Supply	DC12V±10% (option: DC12V/AC24V Dual)	
Power Consumption	180mA max.	240mA max.
Operating Temp.	-10°C ~ 50°C	

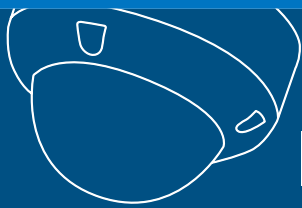

IR Dome Camera



Features

- Built-in Vari-Focal DC Drive Lens
- Day & Night (option: IR-Cut filter Removable, ICR)
- 3-Axis Mechanism for free lens rotation
- Built-in 24 pieces IR-LED
- Effective range up to 20M

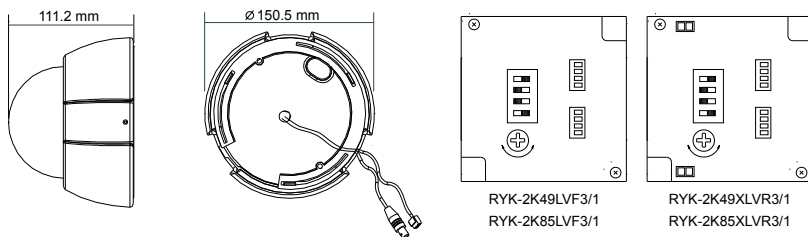

Option :



Model No.	RYK-2K49LVF3/1	RYK-2K85LVF3/1	RYK-2K49XLVR3/1	RYK-2K85XLVR3/1
Image Device	1/3" Color Sony Super HAD	1/3" Color Sony Super HAD (Hi-Res.)	1/3" Color Sony EX-View HAD	1/3" Color Sony EX-View HAD (Hi-Res.)
Picture Elements	NTSC:510x492, PAL:500x582	NTSC:768x494, PAL:752x582	NTSC:510x492, PAL:500x582	NTSC:768x494, PAL:752x582
Resolution	380 TVL	470 TVL	380 TVL	470 TVL
Min. Illumination	0.2 Lux / F2.0 (Day), 0 Lux (IR On)	0.3 Lux / F2.0 (Day), 0 Lux (IR On)	0.05 Lux / F2.0 (Day), 0 Lux (IR On)	0.15 Lux / F2.0 (Day), 0 Lux (IR On)
S/N Ratio	More than 48dB			
Electronic Shutter	NTSC:1/60~1/100,000, PAL:1/50~1/110,000			
Flickless Mode	On/Off (NTSC:1/100, PAL:1/120)			
Gamma	0.45			
Iris Control	DC Drive			
Lens Furnished	Vari-Focal 3.7~12mm / F1.6~3.0, Wide:71.6°x55.8°, Tele:23.8°x17.9° (HxV)		Vari-Focal 3.7~12mm (ICR) / F1.6~3.0, Wide:71.6°x55.8°, Tele:23.8°x17.9° (HxV)	
White Balance	Auto			
Gain Control	High / Low			
Back Light Comp.	On / Off			
Sync. System	Internal			
Video Output	1 Vp-p / 75 Ohms			
Infrared Luminary	24 pieces IR-LED			
Wavelength	850 nm			
Illumination Distance	20 M			
Power Supply	DC12V ± 10%			
Power Consumption	IR On: 425mA max. IR Off: 117mA max.	IR On: 400mA max. IR Off: 200mA max.	IR On: 425mA max. IR Off: 117mA max.	IR On: 400mA max. IR Off: 200mA max.
Operating Temp.	-10°C ~ 50°C			

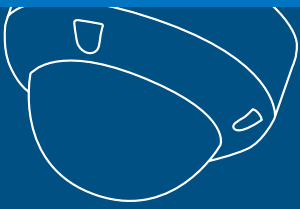

IR Space Dome Camera



Features

- Sony Super HAD CCD sensor
- Built-in 24 pieces IR-LED
- 3-Axis Mechanism for free lens rotation (option)
- Effective range up to 20M

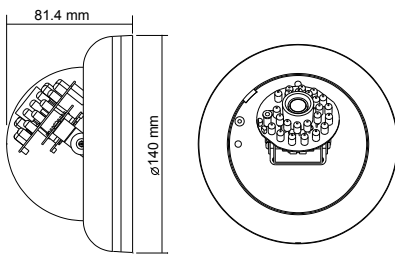

Option :



RYK-8719-3
L Type Bracket

Model No.	RYK-2G49L	RYK-2G85L	RYK-3G41L	RYK-3G43L
Image Device	1/3" Color Sony Super HAD	1/3" Color Sony Super HAD (Hi-Res.)	1/3" B/W Sony Super HAD	1/3" B/W Sony Super HAD (Hi-Res.)
Picture Elements	NTSC:510x492, PAL:500x582	NTSC:768x494, PAL:752x582	EIA:510x492, CCIR:500x582	EIA:768x494, CCIR:752x582
Resolution	380 TVL	470 TVL	420 TVL	600 TVL
Min. Illumination	0.2 Lux / F2.0 (Day), 0 Lux (IR On)	0.3 Lux / F2.0 (Day), 0 Lux (IR On)	0.1 Lux / F2.0 (Day), 0 Lux (IR On)	0.2 Lux / F2.0 (Day), 0 Lux (IR On)
S/N Ratio	More than 48dB			
Electronic Shutter	NTSC:1/60~1/100,000, PAL:1/50~1/110,000		EIA:1/60~1/100,000, CCIR:1/50~1/110,000	
Gamma	0.45			
Lens Furnished	Board Lens 3.6mm / F2.0 (option:4.3/6/8/12mm)			
White Balance	Auto		—	
Gain Control	Auto			
Sync. System	Internal			
Video Output	1 Vp-p / 75 Ohms			
Infrared Luminary	24 pieces IR-LED			
Wavelength	850 nm			
Illuminate Distance	20 M			
Power Supply	DC12V ± 10%			
Power Consumption	IR On: 400mA max. IR Off: 120mA max.	IR On: 420mA max. IR Off: 200mA max.	IR On: 375mA max. IR Off: 110mA max.	IR On: 375mA max. IR Off: 120mA max.
Operating Temp.	-10°C ~ 50°C			

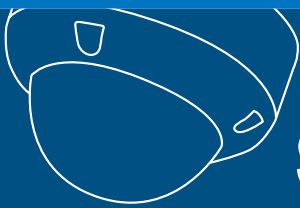

Space Dome Camera



Features

- Sony Super HAD CCD sensor
- Built-in Vari-Focal Lens / Board Lens
- 3-Axis Mechanism for free lens rotation
- DC or DC/AC Dual voltage

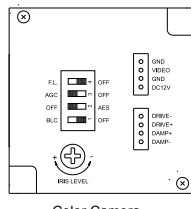
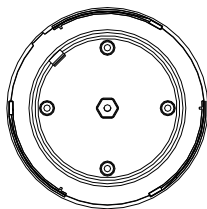
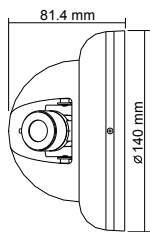

Color Camera

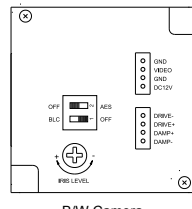

B/W Camera

Option :



RYK-8719-3
L Type Bracket

Model No.	RYK-2G49VF3(VF9)	RYK-2G85VF3(VF9)	RYK-3G41VF3(VF9)	RYK-3G43VF3(VF9)
	RYK-2G49	RYK-2G85	RYK-3G41	RYK-3G43
Image Device	1/3" Color Sony Super HAD	1/3" Color Sony Super HAD (Hi-Res.)	1/3" B/W Sony Super HAD	1/3" B/W Sony Super HAD (Hi-Res.)
Picture Elements	NTSC:510x492, PAL:500x582	NTSC:768x494, PAL:752x582	EIA:510x492, CCIR:500x582	EIA:768x494, CCIR:752x582
Resolution	380 TVL	470 TVL	420 TVL	600 TVL
Min. Illumination	0.2 Lux / F2.0	0.3 Lux / F2.0	0.1 Lux / F2.0	0.2 Lux / F2.0
S/N Ratio	More than 48dB			
Electronic Shutter	NTSC:1/60~1/100,000, PAL:1/50~1/110,000		EIA:1/60~1/100,000, CCIR:1/50~1/110,000	
Flickerless Mode	On / Off (for VF3, VF9 model)		—	
Gamma	0.45			
Iris Control	DC Drive (for VF3, VF9 model)			
Lens Furnished	VF3 model : Vari-Focal 3.7~12mm / F1.6~3.0, Wide: 71.6°x55.8°, Tele: 23.8°x17.9° (HxV) VF9 model : Vari-Focal 9.0~22mm / F2.0~360, Wide:29.2°x21.7°, Tele: 13.0°x9.7° (HxV) Other model : Board Lens 3.6mm / F2.0 (option:2.5/4.3/6/8/12/16mm)			
White Balance	Auto		—	
Gain Control	High / Low (for VF3, VF9 model) Auto (for other model)		Auto	
Back Light Comp.	On / Off			
Video Output	1 Vp-p / 75 Ohms			
Power Supply	DC12V ± 10% (option: DC12V/AC24V Dual)			
Power Consumption	150mA max.	200mA max.	120mA max.	130mA max.
Operating Temp.	-10°C ~ 50°C			

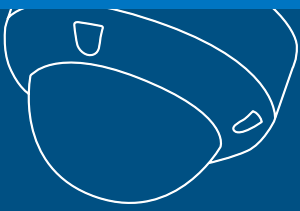

Medium Dome Camera



Features

- Sony Super HAD CCD sensor
- Built-in Vari-Focal Lens / Board Lens
- 3-Axis Mechanism for free lens rotation
- DC voltage



Dome Camera

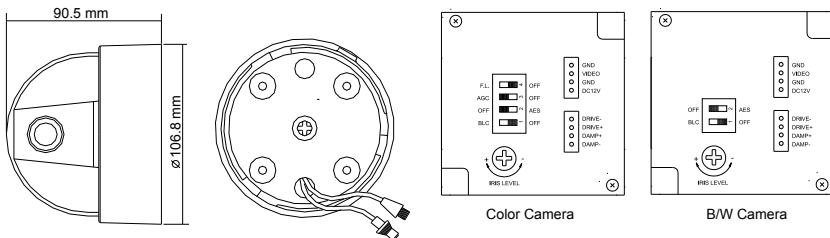

Model No.	RYK-2449VF3(VF9)	RYK-2485VF3(VF9)	RYK-3441VF3(VF9)	RYK-3443VF3(VF9)
	RYK-2411	RYK-2485	RYK-3441	RYK-3443
Image Device	1/3" Color Sony Super HAD	1/3" Color Sony Super HAD (Hi-Res.)	1/3" B/W Sony Super HAD	1/3" B/W Sony Super HAD (Hi-Res.)
Picture Elements	NTSC:510x492, PAL:500x582	NTSC:768x494, PAL:752x582	EIA:510x492, CCIR:500x582	EIA:768x494, CCIR:752x582
Resolution	380 TVL	470 TVL	420 TVL	600 TVL
Min. Illumination	0.2 Lux / F2.0	0.3 Lux / F2.0	0.1 Lux / F2.0	0.2 Lux / F2.0
S/N Ratio	More than 48dB			
Electronic Shutter	NTSC:1/60~1/100,000, PAL:1/50~1/110,000		EIA:1/60~1/100,000, CCIR:1/50~1/110,000	
Flickerless Mode	On / Off (for VF3, VF9 model)		-	
Gamma	0.45			
Iris Control	DC Drive (for VF3, VF9 model)			
Lens Furnished	VF3 model : Vari-Focal 3.7~12mm / F1.6~3.0, Wide:71.6°x55.8°, Tele:23.8°x17.9°(HxV) VF9 model : Vari-Focal 9.0~22mm / F2.0~360, Wide:29.2°x21.7°, Tele: 13.0°x9.7° (HxV) Other model : Board Lens 3.6mm / F2.0 (option:2.5/4.3/6/8/12/16mm)			
White Balance	Auto		-	
Gain Control	High / Low (for VF3, VF9 model) Auto (for other model)		Auto	
Back Light Comp.	On / Off			
Video Output	1 Vp-p / 75 Ohms			
Audio Output	2 Vp-p / 50 Ohms (option)			
Power Supply	DC12V ± 10%			
Power Consumption	142mA max.	110mA max.	133mA max.	142mA max.
Operating Temp.	-10°C ~ 50°C			

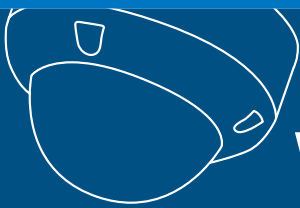

Vandal-proof / Mini Dome Camera



Features

- Sony Super HAD CCD sensor
- Built-in Board Lens
- 3-Axis Mechanism for free lens rotation (option for normal mini type)
- DC voltage



• Vandal-proof



• Normal mini

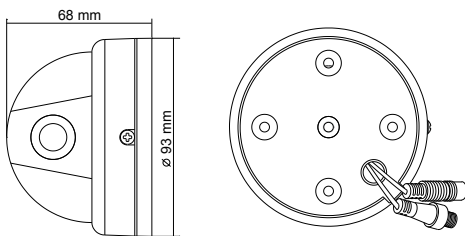

Vandal-proof

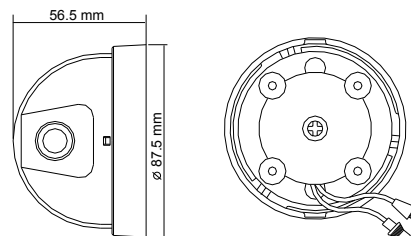

Normal mini

Model No.	Vandal proof	RYK-2J49	RYK-2J85	RYK-3J41	RYK-3J43
	Normal mini	RYK-2311	RYK-2385	RYK-3341	RYK-3343
Image Device		1/3" Color Sony Super HAD	1/3" Color Sony Super HAD (Hi-Res.)	1/3" B/W Sony Super HAD	1/3" B/W Sony Super HAD (Hi-Res.)
Picture Elements		NTSC:510x492, PAL:500x582	NTSC:768x494, PAL:752x582	EIA:510x492, CCIR:500x582	EIA:768x494, CCIR:752x582
Resolution		380 TVL	470 TVL	420 TVL	600 TVL
Min. Illumination		0.2 Lux / F2.0	0.3 Lux / F2.0	0.1 Lux / F2.0	0.2 Lux / F2.0
S/N Ratio		More than 48dB			
Electronic Shutter		NTSC:1/60~1/100,000, PAL:1/50~1/110,000		EIA:1/60~1/100,000, CCIR:1/50~1/110,000	
Gamma		0.45			
Lens Furnished		Board Lens 3.6mm / F2.0 (option:2.5/4.3/6/8/12/16mm)			
White Balance		Auto		—	
Gain Control		Auto			
Sync. System		Internal			
Video Output		1 Vp-p / 75 Ohms			
Audio Output		2 Vp-p / 50 Ohms (option, for RYK-2311/2385/3341/3343)			
Power Supply		DC12V ± 10%			
Power Consumption		117mA max.	110mA max.	100mA max.	108mA max.
Operating Temp.		-10°C ~ 50°C			

■ Series Model:

Model No.	Description
RYK-2335	1/4" Color Sony Super HAD, 330 TVL, 0.5 Lux
RYK-3363	1/3" B/W CCD, 400 TVL, 0.3 Lux

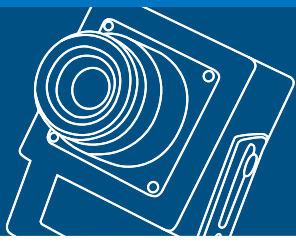

Hidden Camera Selection Guide

Picture	Model No.	Feature	Sensor	TVL	Min Illumination	Lens	Voltage	Page		
	RYK-CA04	Vehicle Rearview	1/4" CL	330	0.5 Lux	Board Lens	DC	37		
	RYK-2767	Mini Bullet	1/3" CL	380	0.4 Lux	Board Lens	DC	38		
	RYK-2768					Cone Lens				
	RYK-2739	Bullet	1/4" CL	330	0.5 Lux	Board Lens	DC	38		
	RYK-3753		1/3" BW	420	0.1 Lux					
	RYK-3755			600	0.2 Lux					
	RYK-2D55A	Ultra-Mini	1/3" CL	380	0.4 Lux	Board Lens	DC	39		
	RYK-2D56A					Cone Lens				
	RYK-2849	Mini	1/3" CL	380	0.2 Lux	Board Lens	DC	39		
	RYK-2850					Pinhole Lens				
	RYK-2847		1/4" CL	330	0.5 Lux	Board Lens				
	RYK-2848					Pinhole Lens				
	RYK-3841		1/3" BW	420	0.1 Lux	Board Lens				
	RYK-3842					Pinhole Lens				
	RYK-3843					600			0.2 Lux	Board Lens
	RYK-3844									Pinhole Lens
	RYK-3863		400	0.3 Lux	Board Lens					
	RYK-3864				Pinhole Lens					
	RYK-2512(S)	PIR	1/3" CL	380	0.2 Lux	Cone Lens	DC	40		
	RYK-2585(S)			470	0.3 Lux					
	RYK-3542(S)		1/3" BW	420	0.1 Lux					
	RYK-3544(S)			600	0.2 Lux					
	RYK-2611	Smoke Detector	1/3" CL	380	0.2 Lux	Cone Lens	DC	41		
	RYK-2685			470	0.3 Lux					
	RYK-3641		1/3" BW	420	0.1 Lux					
	RYK-3643			600	0.2 Lux					
	RYK-2C54	Mini Dome	1/3" CL	380	0.4 Lux	Cone Lens	DC	42		
	RYK-3C76		1/3" BW	420	0.1 Lux					



Vehicle Rearview Camera



Features

- Sony Super HAD CCD sensor
- Built-in Wide Angle Lens
- Weatherproofing Criterion IP66
- DC voltage

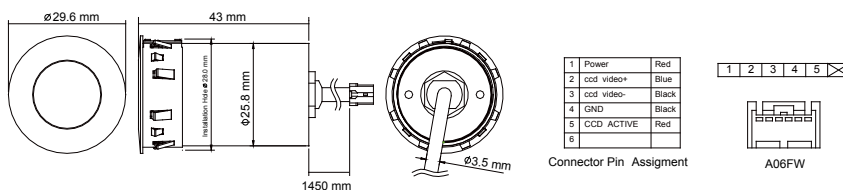

Model Name	RYK-CA04
Image Device	1/4" Color Sony Super HAD
Picture Elements	NTSC:510x492
Resolution	330 TVL
Min. Illumination	0.5 Lux / F2.8
S/N Ratio	More than 48dB
Electronic Shutter	NTSC:1/60~1/100,000
Gamma	0.45
Lens Furnished	Board Lens 1.9mm / F2.8
White Balance	Auto
Gain Control	Auto
View Angle	157° (Diagnol)
Sync. System	Internal
Video Output	1 Vp-p / 75 Ohms, A06FW Connector
Power Supply	DC12V ± 10%
Power Consumption	115mA max.
Operating Temp.	-20°C ~ 70°C

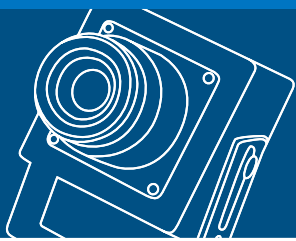

Bullet Camera



Features

- Sony Super HAD CCD sensor
- Built-in Board Lens / Cone Lens
- Weatherproof
(for Board Lens type)



• Bullet

• Mini Bullet

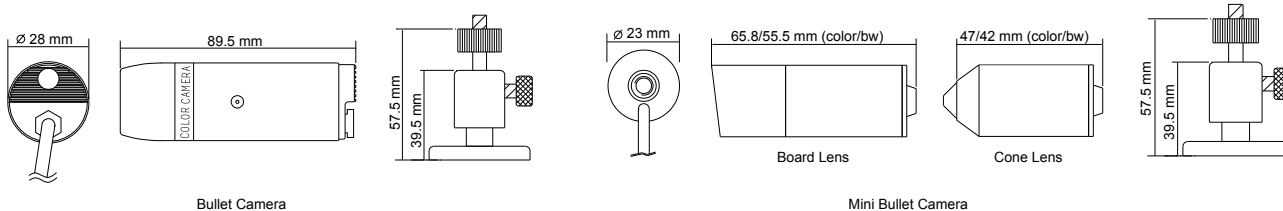

Bullet Camera

Mini Bullet Camera

Model No.	RYK-2767/2768	RYK-2739	RYK-3753	RYK-3755
Description	Mini Bullet		Bullet	
Image Device	1/3" Color CCD	1/4" Color Sony Super HAD	1/3" B/W Sony Super HAD	1/3" B/W Sony Super HAD (Hi-Res.)
Picture Elements	NTSC:512x492, PAL:512x582	NTSC:510x492, PAL:500x582	EIA:510x492, CCIR:500x582	
Resolution	380 TVL	330 TVL	420 TVL	600 TVL
Min. Illumination	0.4 Lux / F2.0	0.5 Lux / F2.0	0.1 Lux / F2.0	0.2 Lux / F2.0
S/N Ratio	More than 48dB			
Electronic Shutter	NTSC:1/60~1/100,000, PAL:1/50~1/100,000	NTSC:1/60~1/100,000, PAL:1/50~1/110,000	EIA:1/60~1/100,000, CCIR:1/50~1/110,000	
Gamma	0.45			
Lens Furnished	RYK-2767/2739/3753/3755: Board Lens 3.6mm / F2.0 (option:6/8/12mm) RYK-2768 : Cone Lens 3.8mm / F2.0			
White Balance	Auto		—	
Gain Control	Auto			
Sync. System	Internal			
Video Output	1 Vp-p / 75 Ohms			
Audio Output	—	2 Vp-p / 50 Ohms (option)		
Power Supply	DC12V ± 10%			
Power Consumption	100mA max.	117mA max.	108mA max.	133mA max.
Operating Temp.	-10°C ~ 50°C			



Mini Camera

Features

- Ultra-mini and compact size
- Built-in Board Lens / Pinhole Lens / Cone Lens
- DC voltage
- Furnished with U type holder and cable



• Mini



• Ultra-mini

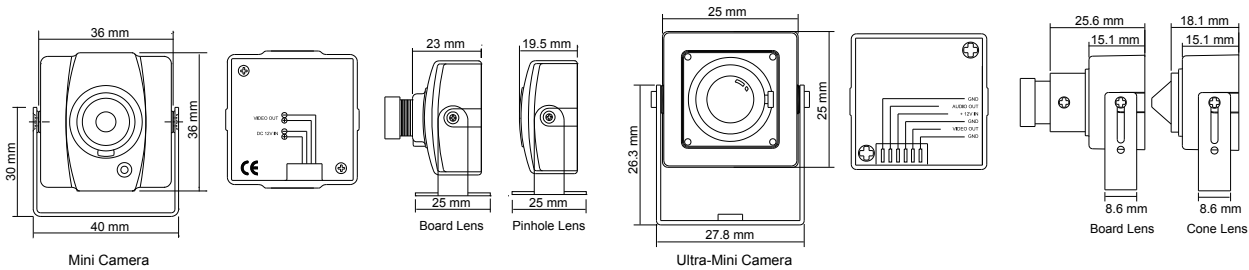

Model No.	RYK-2D55A	RYK-2849	RYK-2847	RYK-3841	RYK-3843
	RYK-2D56A	RYK-2850	RYK-2848	RYK-3842	RYK-3844
Description	Ultra mini camera		Mini camera		
Image Device	1/3" Color CCD	1/3" Color Sony Super HAD	1/4" Color Sony Super HAD	1/3" B/W Sony Super HAD	1/3" B/W Sony Super HAD (Hi-Res.)
Picture Elements	NTSC:512x492, PAL:512x582	NTSC:510x492, PAL:500x582	NTSC:510x492, PAL:500x582	NTSC:510x492, PAL:500x582	EIA:768x494, CCIR:752x582
Resolution	380 TVL	380 TVL	330 TVL	420 TVL	600 TVL
Min. Illumination	0.4 Lux / F2.0	0.2 Lux / F2.0	0.5 Lux / F2.0	0.1 Lux / F2.0	0.2 Lux / F2.0
S/N Ratio	More than 48dB				
Electronic Shutter	NTSC:1/60~1/100,000, PAL:1/50~1/100,000	NTSC:1/60~1/100,000, PAL:1/50~1/110,000		EIA:1/60~1/100,000, CCIR:1/50~1/110,000	
Gamma	0.45				
Lens Furnished	RYK-2D55A/2849/2847/3841/3843: Board Lens 3.6mm / F2.0 (option:2.5/4.3/6/8/12/16mm) RYK-2850/2848/3842/3844 : Pinhole Lens 3.7mm / F2.0 (option:4.3mm) RYK-2D56A : Cone Lens 3.8mm / F2.0				
White Balance	Auto			—	
Gain Control	Auto				
Sync. System	Internal				
Video Output	1 Vp-p / 75 Ohms				
Audio Output	RYK-2D55A/2D56A: 2 Vp-p / 50 Ohms, Other model: 2 Vp-p / 50 Ohms (option)				
Power Supply	DC12V ± 10%				
Power Consumption	125mA max.	117mA max.		108mA max.	
Operating Temp.	-10°C ~ 50°C				

Series Model:

Model No.	Description
RYK-3863	1/3" B/W CCD, 400 TVL, 0.3 Lux, Board Lens 3.6mm / F2.0, DC12V
RYK-3864	1/3" B/W CCD, 400 TVL, 0.3 Lux, Pinhole Lens 3.7mm / F2.0, DC12V

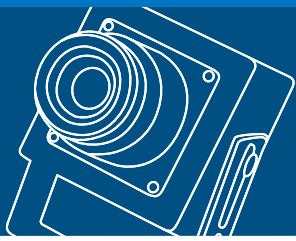

PIR Camera

Features

- Sony Super HAD CCD sensor
- Built-in Cone Lens
- Built-in PIR sensor board for motion detection and relay control output (option)

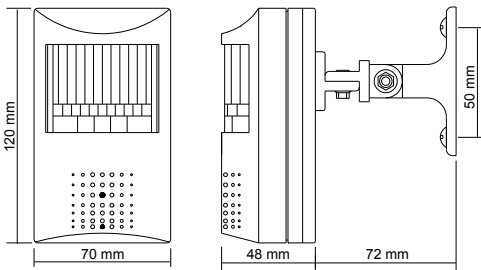

Model No.	RYK-2512	RYK-2585	RYK-3542	RYK-3544
Image Device	1/3" Color Sony Super HAD	1/3" Color Sony Super HAD (Hi-Res.)	1/3" B/W Sony Super HAD	1/3" B/W Sony Super HAD (Hi-Res.)
Picture Elements	NTSC:510x492, PAL:500x582	NTSC:768x494, PAL:752x582	EIA:510x492, CCIR:500x582	EIA:768x494, CCIR:752x582
Resolution	380 TVL	470 TVL	420 TVL	600 TVL
Min. Illumination	0.2 Lux / F2.0	0.3 Lux / F2.0	0.1 Lux / F2.0	0.2 Lux / F2.0
S/N Ratio	More than 48dB			
Electronic Shutter	NTSC:1/60~1/100,000, PAL:1/50~1/110,000		EIA:1/60~1/100,000, CCIR:1/50~1/110,000	
Gamma	0.45			
Lens Furnished	Cone Lens 3.7mm / F2.0			
White Balance	Auto		-	
Gain Control	Auto			
Sync. System	Internal			
Video Output	1 Vp-p / 75 Ohms			
Audio Output	2 Vp-p / 50 Ohms (option)			
Power Supply	DC12V ± 10%			
Power Consumption	200mA max.	110mA max.	142mA max.	150mA max.
Operating Temp.	-10°C ~ 50°C			

■ Series Model (for "S" model: RYK:2512S/2585S/3542S/3544S)

PIR N.C/N.O Relay Output	AC125V / 1A, DC30V / 2A
PIR N.C/N.O Relay Alarm Time	2~40 sec (adjustable)
PIR Detection Angle	Hor.=100° / Ver.=45°
PIR Max. Detection Range	10 M



Smoke Detector Camera

Features

- Sony Super HAD CCD sensor
- Built-in Cone Lens 3.7 mm
- DC voltage

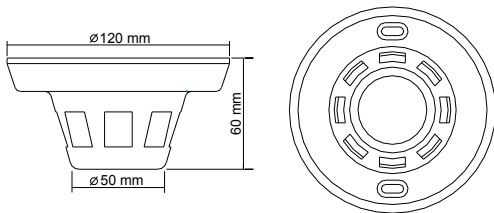

Model No.	RYK-2611	RYK-2685	RYK-3641	RYK-3643
Image Device	1/3" Color Sony Super HAD	1/3" Color Sony Super HAD (Hi-Res.)	1/3" B/W Sony Super HAD	1/3" B/W Sony Super HAD (Hi-Res.)
Picture Elements	NTSC:510x492, PAL:500x582	NTSC:768x494, PAL:752x582	EIA:510x492, CCIR:500x582	EIA:768x494, CCIR:752x582
Resolution	380 TVL	470 TVL	420 TVL	600 TVL
Min. Illumination	0.2 Lux / F2.0	0.3 Lux / F2.0	0.1 Lux / F2.0	0.2 Lux / F2.0
S/N Ratio	More than 48dB			
Electronic Shutter	NTSC:1/60~1/100,000, PAL:1/50~1/110,000		EIA:1/60~1/100,000, CCIR:1/50~1/110,000	
Gamma	0.45			
Lens Furnished	Cone Lens 3.7mm / F2.0			
White Balance	Auto		—	
Gain Control	Auto			
Sync. System	Internal			
Video Output	1 Vp-p / 75 Ohms			
Audio Output	2 Vp-p / 50 Ohms (option)			
Power Supply	DC12V ± 10%			
Power Consumption	142mA max.	110mA max.	117 mA max.	
Operating Temp.	-10°C ~ 50°C			

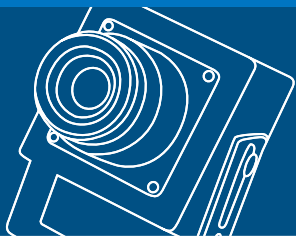

Mini Dome Camera

Features

- Sony Super HAD CCD sensor
- Built-in Cone Lens 3.7 mm
- In-ceiling or Surface installation application
- Aluminum casing

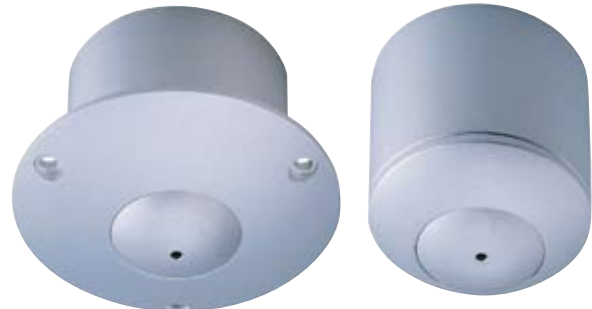

• In-ceiling

• Surface

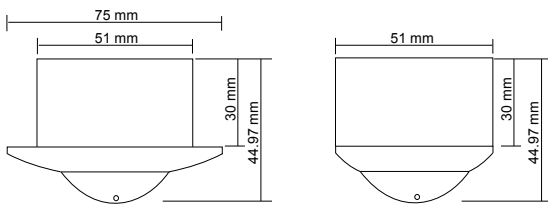

Model No.	RYK-2C54	RYK-3C76
Image Device	1/3" Color Sony Super HAD	1/3" B/W Sony Super HAD
Picture Elements	NTSC:510x492, PAL:500x582	EIA:510x492, CCIR:500x582
Resolution	380 TVL	420 TVL
Min. Illumination	0.4 Lux / F2.0	0.1 Lux / F2.0
S/N Ratio	More than 48 dB	
Electronic Shutter	NTSC:1/60~1/100,000, PAL:1/50~1/110,000	EIA:1/60~1/100,000, CCIR:1/50~1/110,000
Gamma	0.45	
Lens Mount	Cone Lens 3.7mm / F2.0	
White Balance	Auto	—
Gain Control	Auto	
Sync. System	Internal	
Video Output	1 Vp-p / 75 Ohms	
Power Supply	DC12V ± 10%	
Power Consumption	117mA max.	100mA max.
Operating Temp.	-10°C ~ 50°C	



Board Camera Selection Guide

Picture	Model No.	Sensor	Dimensions	TVL	Min Illumination	Lens	Voltage	Page
	RYK-2090VF3	1/3" CL	38x38 (Three Boards)	470	0.1 Lux (Night / BW) 0.001 Lux (DSS)	Vari Focal	DC	44
	RYK-2090VR3					Vari Focal (ICR)		
	RYK-2085	1/3" CL	32x32 (Double Boards)	470	0.3 Lux	Board Lens	DC	45
	RYK-2086					Pinhole Lens		
	RYK-2083			550	0.4 Lux	Board Lens		
	RYK-2084					Cone Lens		
	RYK-2069	1/3" CL	32x32	380	0.2 Lux	Board Lens		
	RYK-2070					Cone Lens		
	RYK-2071	1/4" CL		330	0.5 Lux	Board Lens		
	RYK-2072					Cone Lens		
	RYK-2065	1/4" CL	22x26	380	0.4 Lux	Board Lens		
	RYK-2066					Cone Lens		
	RYK-3041	1/3" BW	32x32	420	0.1 Lux	Board Lens	DC	46
	RYK-3042					Pinhole Lens		
	RYK-3043			600	0.2 Lux	Board Lens		
	RYK-3044					Pinhole Lens		
	RYK-3063			400	0.3 Lux	Board Lens		
	RYK-3064					Pinhole Lens		



WDR Board Camera



Features

- Camera with 1/3" Color Sony Vertical double-Density WD CCD
- High sensitivity, low smear, high anti-blooming and high S/N ratio
- IR Cut filter Removable (ICR) provides change from color to B/W mode automatically or manually for day and night 24-hour surveillance
- On Screen Display (OSD) set-up menu
- Remote control via RS-485/422 (option:RS-232)
- Special functions: Flickerless, Mirror, Freeze, Line Lock, Positive / Negative, Camera ID, Camera Title, Privacy Masking, Digital Zoom, Digital Slow Shutter
- Built-in Vari Focal Lens (DC Drive)

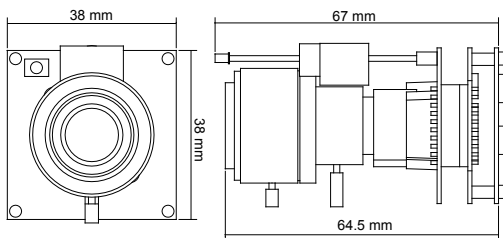

CN1		OSD Button	
1	GND	1	UP (Tele)
2	VRI In	2	MENU
3	DC In	3	RIGHT (+)
4	GND	4	LEFT (-)
5	VIDEO Out	5	DOWN (Wide)
6	GND		

CN2 (RS-485)		CN2 (RS-232,option)	
1	R +	1	RD
2	R -	2	GND
3	T +	3	RD
4	T -	4	GND

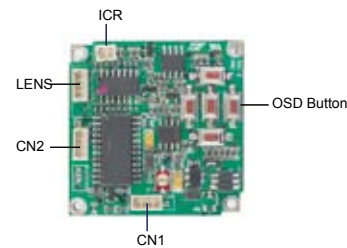

Model No.	RYK-2090VF3	RYK-2090VR3
Image Device	1/3" Color Sony Vertical double-Density WD CCD (Hi-Res.)	
Picture Elements	NTSC:768x494, PAL:752x582	
Resolution	470 TVL	
Min. Illumination	0.1 Lux (Night / BW), 0.001 Lux (DSS) / F1.2	
S/N Ratio	More than 48dB	
Electronic Shutter	NTSC:1/60~1/100,000, PAL:1/50~1/100,000	
Flickerless Mode	On / Off (NTSC:1/100, PAL:1/120)	
Lens Furnished	Vari-Focal 3.7~12mm / F1.6~3.0, Wide:71.6°x55.8°, Tele:23.8°x17.9° (HxV)	Vari-Focal 3.7~12mm (ICR) / F1.6~3.0, Wide:71.6°x55.8°, Tele:23.8°x17.9° (HxV)
Gamma	0.45	
White Balance	Auto / Indoor / Outdoor / Manual / Push Auto	
Gain Control	Auto / Manual	
Back Light Comp.	On / Off (Level & area adjustable)	
Wide Dynamic Range (WDR)	On / Off (Level adjustable)	
Day & Night (ICR)	AE / Day / Night	AE / Sensor / Day / Night
Digital Zoom	3x	
Camera ID	000~255	
Camera Title	Up to 16 characters	
Mirror	Off / Horizontal / Vertical / Rotate	
Privacy Masking	8 free areas (Area size adjustable)	
Freeze	On / Off	
Positive / Negative	POSI / NEGA	
Digital Slow Shutter (DSS)	Off, 2~20, 40, 80, 160 FLD	
Remote Control	RS-485 / RS-422 (option: RS-232)	
Protocol	YOKO / PELCO D&P / LG	
Sync. System	Internal / External Line Lock	
Video Output	1 Vp-p / 75 Ohms	
Power Supply	DC12V ± 10%	
Power Consumption	300mA max.	
Operating Temp.	-10°C ~ 50°C	
Dimensions (mm)	38x38 (Three Boards)	



Color Board Camera



• 22x26mm



• 32x32mm



• 32x32mm
(Double Boards)

Lens Option :



• Board Lens
(2.5/3.6/4.3/6/8/12/16mm)



• Pinhole Lens
(3.7/5.5mm)



• Cone Lens
(3.7mm)

Model No.	RYK-2069	RYK-2085	RYK-2083	RYK-2071	RYK-2065
	RYK-2070	RYK-2086	RYK-2084	RYK-2072	RYK-2066
Image Device	1/3" Sony Super HAD	1/3" Sony Super HAD (Hi-Res.)		1/4" Sony Super HAD	1/4" CCD
Picture Elements	NTSC:510x492, PAL:500x582	NTSC:768x494, PAL:752x582		NTSC:510x492, PAL:500x582	NTSC:512x492, PAL:512x582
Resolution	380 TVL	470 TVL	550 TVL	330 TVL	380 TVL
Min. Illumination	0.2 Lux / F2.0	0.3 Lux / F2.0	0.4 Lux / F2.0	0.5 Lux / F2.0	0.4 Lux / F2.0
S/N Ratio	More than 48dB				
Electronic Shutter	NTSC:1/60~1/100,000, PAL:1/50~1/110,000				NTSC:1/60~1/100,000, PAL:1/50~1/100,000
Flickerless Mode	—	On / Off		—	
Gamma	0.45				
Iris Control	—	Video Drive		—	
Lens Furnished	RYK-2086 : Pinhole Lens 5.5 mm / F3.5 (option:3.7mm) RYK-2066 : Cone Lens 3.8mm / F2.0 RYK-2070/2084/2072 : Cone Lens 3.7mm / F2.0 Other model : Board Lens 3.6mm / F2.0 (option:2.5/4.3/6/8/12/16mm)				
White Balance	Auto				
Gain Control	Auto	High / Low		Auto	
Back Light Comp.	—	On / Off		—	
Sync. System	Internal				
Video Output	1 Vp-p / 75 Ohms				
Audio Output	2 Vp-p / 50 Ohms (option)				—
Power Supply	DC12V ± 10%				
Power Consumption	117 mA max.	110mA max.	167mA max.	117mA max.	117mA max.
Operating Temp.	-10°C ~ 50°C				
Dimensions (mm)	32x32	32x32 (Double Boards)		32x32	22x26



B/W Board Camera

Pin Assignment :

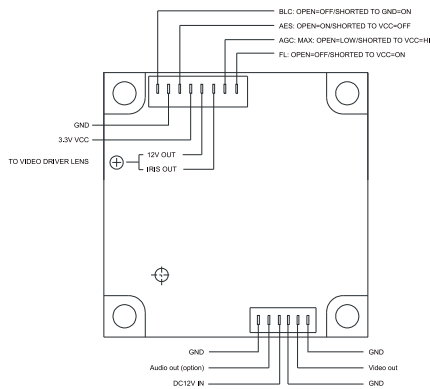

• RYK-2083/2085

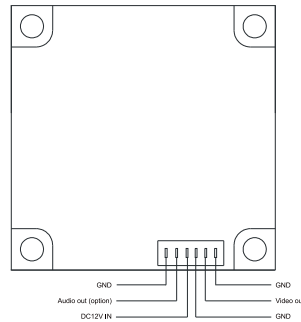

• RYK-2069/2071/BW type

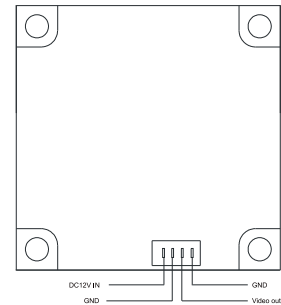

• RYK-2065

Model No.	RYK-3041	RYK-3043	RYK-3063
	RYK-3042	RYK-3044	RYK-3064
Image Device	1/3" Sony Super HAD	1/3" Sony Super HAD (Hi-Res.)	1/3" CCD
Picture Elements	EIA:510x492, CCIR:500x582	EIA:768x494, CCIR:752x582	EIA:510x492, CCIR:500x582
Resolution	420 TVL	600 TVL	400 TVL
Min. Illumination	0.1 Lux / F2.0	0.2 Lux / F2.0	0.3 Lux / F2.0
S/N Ratio	More than 48dB		
Electronic Shutter	EIA:1/60~1/100,000, CCIR:1/50~1/110,000		
Gamma	0.45		
Lens Furnished	RYK-3041/3043/3063: Board Lens 3.6mm / F2.0 (option:2.5/4.3/6/8/12/16mm) RYK-3042/3044/3064: Pinhole Lens 5.5mm / F3.5 (option:3.7mm)		
Gain Control	Auto		
Sync. System	Internal		
Video Output	1 Vp-p / 75 Ohms		
Audio Output	2 Vp-p / 50 Ohms (option)		
Power Supply	DC12V ± 10%		
Power Consumption	108mA max.		
Operating Temp.	-10°C ~ 50°C		
Dimensions (mm)	32x32		



DVR & NETWORK

- Digital Video Recorder
- Portable Security Recorder
- IP Camera
- Video Server
- Video Processor



DVR & Network Selection Guide

DVR

Picture	Model No.	Compression	Recording (NTSC)		Audio	Motion Detection	PTZ Control	Network	I / O	Backup	HDD	Page
			Frame Rate	Resolution								
	RYK-9334	MPEG4	120 IPS	704x480	Yes	Yes	Yes	Yes	4 / 1	USB Stick CD / DVD Writer (option)	3.5" IDE HDDx2	49
	RYK-9338		120 IPS	704x240					8 / 1			
	RYK-9348		240 IPS	352x240					8 / 1			
	RYK-9336	MPEG4	120 IPS	704x480	Yes	Yes	Yes	Yes	16 / 1	USB Stick CD / DVD Writer (option)	3.5" IDE HDDx4	50
	RYK-9346		240 IPS	704x240								
	RYK-9356		480 IPS	352x240								
	RYK-9317	MPEG4	480 IPS	360x240	Yes	Yes	Yes	Yes	16 / 1	USB Stick CD-RW / DVD±RW (option)	3.5" IDE HDDx4	51
	RYK-9309		240 IPS	720x240					720x480			
	RYK-9305	MPEG4	120 IPS	352x240 704x240 704x480	Yes	Yes	Yes	Yes	4 / 1	USB Stick CD-RW (option)	3.5" IDE HDDx3	52
	RYK-9320	MPEG4	60 IPS	352x240	—	Yes	—	Option	4 / 1	VCR	3.5" IDE HDDx1	53
	RYK-9324				Yes					CF Card	3.5" IDE HDDx1 (Removable)	
	RYK-9326	MPEG4	60 IPS	352x240 704x240	Yes	Yes	—	Option	16 / 1	CF Card	3.5" IDE HDDx1 (Removable)	54
	RYK-9327								8 / 1			
	RYK-9816	MJPEG	60 IPS	704x240	Yes	Yes	—	Option	16 / 1	CF Card	3.5" IDE HDDx1 (Removable)	55
	RYK-9817								8 / 1			
	RYK-9810	MJPEG	120 IPS	640x224	—	Yes	—	—	4 / 1	CF Card	3.5" IDE HDDx1 (Removable)	56
	RYK-9811				Yes							
	RYK-9820	MJPEG	120 IPS	640x224	—	Yes	—	Option	4 / 1	VCR	3.5" IDE HDDx1	57
	RYK-9807											

PSR

Picture	Model No.	Compression	Camera	Storage	Display	Wireless	Power Supply	Page
	RYK-9103	MPEG4	CMOS Camera	Built-in Flash Memory	—	—	4xAA Batteries AC100~240V / DC12V	58
	RYK-9109	MPEG4	CMOS Camera	SD Card	—	—	4xAA Batteries AC100~240V / DC12V	59
	RYK-9122	MPEG4	—	SD Card	—	—	2xAA Batteries AC100~240V / DC5V	60
	RYK-9121K	MPEG4	Wireless CMOS Camera	CF Card	2.5" TFT LCD	2.4 GHz	4xAA Batteries AC100~240V / DC12V	61
	RYK-9107	MPEG4	CMOS Camera	SD Card	2.5" TFT LCD	—	Rechargeable Li-ion Battery AC100~240V / DC5V	62

Network Product

Picture	Model No.	Compression	Recording (NTSC)		Camera	Audio	Motion Detection	PTZ Control	Network	I / O	Page
			Frame Rate	Resolution							
	RYK-IP2280(W)	MPEG4	30 IPS	640x480	1/4" CMOS	Yes	Yes	—	Yes	—	63
	RYK-IP1130(W)	MPEG4	30 IPS	640x480	1/6" CMOS	Yes	Yes	—	Yes	—	64
	RYK-IP3400(W/E)	MPEG4 / MJPEG Dual Codec	30 IPS	720x480	1/3" Sony CCD	Yes	Yes	—	Yes	1 / 1	65
	RYK-IP185	MJPEG	20 IPS	640x480	1/3" Sony CCD	Yes	Yes	Yes	Yes	1 / 1	
	RYK-VS110(W/E)	MPEG4 / MJPEG Dual Codec	30 IPS	720x480	—	Yes	Yes	Yes	Yes	1 / 1	66
	RYK-9909	MJPEG	20 IPS	640x480	—	Yes	Yes	Yes	Yes	1 / 1	

4CH/8CH MPEG4 Multiplex Network DVR

Features

- MPEG4 compression for DVR recording and web transmission
- Graphic OSD and mouse control
- Live display, record, backup, playback and network access at the same time
- CD / DVD writer (selectable) and USB device backup
- Remote view and manage through 16CH client software and IE browser
- Audio recording
- Motion detection with area selecting and sensitivity adjusting by each camera
- Remote controller
- Email notification
- Control all functions of PTZ camera
- TCP/IP, DDNS, DHCP, PPPoE network connection
- System auto recovery after power reconnected
- Watermark proof
- Motion / manual / continuous / alarm recording
- Multi-language OSD



Model No.	RYK-9334		RYK-9338		RYK-9348	
Video	Format	NTSC / EIA or PAL / CCIR				
	Compression	MPEG4				
	Input	4 CH, BNC		8 CH, BNC		
	Loop Output	-		Option		
	Main Output	1 CH, BNC				
	VGA	Option				
	Spot Output	1 CH, RCA				
Audio	Input	4 CH, RCA				
	Output	1 CH, RCA				
Display	Resolution	720x480 (NTSC), 720x576 (PAL)				
	Frame Rate	Max. 120 / 100 IPS (NTSC / PAL)		Max. 240 / 200 IPS (NTSC / PAL)		
	Division	Single, Quad, Sequence		Single, Split (4,9), Sequence		
Recording	Resolution	704x480, 704x240, 352x240 (NTSC), 704x576, 704x288, 352x288 (PAL)				
	Frame Rate	120 IPS@CIF		120 IPS@CIF		240 IPS@CIF
	Quality	Highest, Medium, Low				
	Pre Alarm	Max. 120 frames				
	Post Alarm	5 ~240 seconds				
	Mode	Manual / Schedule / Event (Motion Detection / Video loss / Sensor)				
	WaterMark	Yes				
Storage	HDD	2x3.5" IDE HDD (Max. 750GB)				
	Option	SATA converter				
	Requirement	5400 ~ 7200RPM, 45MHz DMA, EIDE compatible, Faster than 9.0ms avg.				
Alarm	Input	4 (NO / NC programmable)		8 (NO / NC programmable)		
	Output	1 Relay with NO / NC contact				
	Triggered Mode	Motion Detection, Video Loss, Sensor Input, Power Failure				
	Action	Recording, Relay Output, Sound Alert				
Network	Protocol	TCP/IP, SMTP, HTTP, DHCP, PPPoE, DDNS				
	Remote	View, Search, Recording & Control by Client Program or IE Browser				
Backup Device	USB (Flash Memory, USB HDD), CD / DVD writer (option)					
PTZ Camera	Support					
Backup File Format	MPEG4 compression, AVI file format					
Multi-Language	English, Traditional Chinese, German, French, Italian, Spanish					
Search Method	By Date, Time, Event					
Serial Connectors	USBx3, RS-232C, RS-485					
Power Supply	AC100~240V 50/60 Hz, DC12V					
Weight	Approx. 3.6 Kg (without HDD)					
Dimensions (WxHxD)	430x70x310 mm					
Operating Environment	30 ~ 80% RH, 5°C ~ 40°C (41°F ~ 104°F)					

■ IPS: Images Per Second

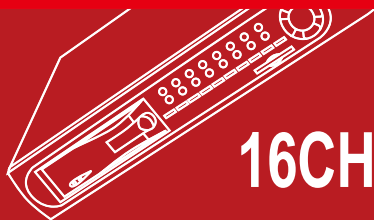

16CH MPEG4 Multiplex Network DVR

Features

- MPEG4 compression for DVR recording and web transmission
- Graphic OSD and mouse control
- Live display, record, backup, playback and network access at the same time
- CD/DVD writer (selectable) and USB device backup
- Remote view and manage through 16CH client software and IE browser
- Audio recording and 2-way audio conference
- Motion detection with area selecting and sensitivity adjusting by each camera
- Remote controller
- Email notification
- Control all functions of PTZ camera
- TCP/IP, DDNS, DHCP, PPPoE network connection
- System auto recovery after power reconnected
- Watermark proof
- Motion / manual / continuous / alarm recording
- Multi-language OSD



Model No.	RYK-9336		RYK-9346		RYK-9356	
Video	Format	NTSC / EIA or PAL / CCIR				
	Compression	MPEG4				
	Input	16 CH, BNC				
	Loop Output	Option				
	Main Output	1 CH, BNC				
	VGA	Option				
	Spot Output	1 CH, RCA				
Audio	Input	4 CH, RCA				
	Output	1 CH, RCA				
	Remote	2-way audio conference				
Display	Resolution	720x480 (NTSC), 720x576 (PAL)				
	Frame Rate	Max. 480 / 400 IPS (NTSC / PAL)				
	Division	Single, Split (4,9,16), Sequence				
Recording	Resolution	704x480, 704x240, 352x240 (NTSC), 704x576, 704x288, 352x288 (PAL)				
	Frame Rate	120 IPS@CIF	240 IPS@CIF		480 IPS@CIF	
	Quality	High / Middle / Low				
	Pre Alarm	Max. 120 frames				
	Post Alarm	5 ~240 seconds				
	Mode	Manual / Schedule / Event (Motion Detection / Video loss / Sensor)				
	WaterMark	Yes				
Storage	HDD	4x3.5" IDE HDD (Max. 750GB)				
	Option	SATA converter				
	Requirement	5400 ~ 7200RPM, 45MHz DMA, EIDE compatible, Faster than 9.0ms avg.				
Alarm	Input	16 (NO / NC programmable)				
	Output	4 Relay with NO / NC contact				
	Triggered Mode	Motion Detection, Video Loss, Sensor Input, Power Failure				
	Action	Recording, Relay Output, Sound Alert				
Network	Protocol	TCP/IP, SMTP, HTTP, DHCP, PPPoE, DDNS				
	Remote	View, Search, Recording & Control by Client Program or IE Browser				
Backup Device	USB (Flash Memory, USB HDD), CD / DVD writer (option)					
PTZ Camera	Support					
Backup File Format	MPEG4 compression, AVI file format					
Multi-Language	English, Traditional Chinese, German, French, Italian, Spanish					
Search Method	By Date, Time, Event					
Serial Connectors	USBx3, RS-232C, RS-485					
Power Supply	AC100~240V 50/60 Hz, DC12V					
Weight	Approx. 8 Kg (without HDD)					
Dimensions (WxHxD)	430x90x425 mm					
Operating Environment	30 ~ 80% RH, 5°C ~ 40°C (41°F ~ 104°F)					

■ IPS: Images Per Second

8CH/16CH MPEG4 Multiplex Network DVR

Features

- Real-time recording as MPEG4 compression
- Simultaneously operate of live, recording, playback, backup, network and copy
- 4 channels audio recording with 1 channel output
- 4 IDE HDDs support
- 3 USB 2.0 ports for USB mouse, system upgrade
- Built-in DVD±RW / CD-RW (option)
- TCP/IP, Dynamic IP, DHCP support
- S-video, Spot monitor output, VGA option
- Pre / Post-Alarm recording (5 / 60 seconds)
- Control PTZ camera through RS-485
- Remote controller
- AVI file converter

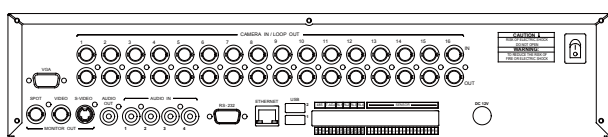

RYK-9317

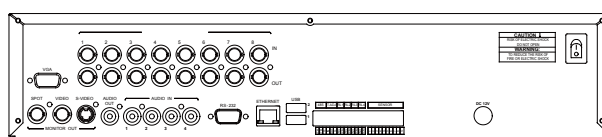

RYK-9309

Model No.		RYK-9317	RYK-9309
Video	Format	NTSC / EIA or PAL / CCIR	
	Compression	MPEG4	
	Input	16 CH, BNC	8 CH, BNC
	Loop Output	16 CH, BNC	8 CH, BNC
	Main Output	1 CH, BNC 1 CH, VGA (Analogue non-interlaced RGB, compatible with TFT LCD supports 50Hz mode in PAL) (option)	
Audio	Spot Output	1 CH, BNC	
	Input	4 CH, RCA	
Display	Output	1 CH, RCA	
	Resolution	720x480 (NTSC), 720x576 (PAL)	
	Frame Rate	Max. 480 / 400 IPS (NTSC / PAL)	Max. 240 / 200 IPS (NTSC / PAL)
Recording	Division	Single, Sequence, Multiple (4,9,16), Digital zoom x2, Freeze	
	Resolution	360x240, 720x240, 720x480 (NTSC), 360x288, 720x288, 720x576 (PAL)	
	Frame Rate	Max. 480 / 400 IPS (NTSC / PAL)	Max. 240 / 200 IPS (NTSC / PAL)
	Quality	Superfine / Fine / Low	
	Pre / Post Alarm Recording	5 secs (Pre), 60 secs (Post), programmable per camera	
HDD	Mode	Manual / Schedule / Event (Motion Detection / Video Loss / Sensor)	
	Water Mark	Support	
	Basic Storage Requirement	4x3.5" IDE HDD (Max. 750GB) 5400 ~ 7200RPM, 45MHz DMA, EIDE compatible, Faster than 9.0ms avg.	
Alarm	Input	16 (NO / NC programmable)	8 (NO / NC programmable)
	Output	4 Relay, Terminal Block	
	Triggered Mode	Motion Detection, Video Loss, Sensor Input, Power Failure, HDD Error	
Network	Action	Recording, Relay Output, Sound Alert, E-mail	
	Protocol	10/100 BaseT Ethernet, TCP/IP, DHCP, DNS, SMTP, HTTP	
Backup Device	Remote	View, Search, Recording & Control by Client Program / IE Browser	
PTZ Camera		USB Stick / CD-RW / DVD±RW (option)	
Backup File Format		Support (Up to 16 models)	
Multi-Language		Proprietary, AVI	
Search Method		English, Chinese, Japanese, Korean, Spanish, Polish, Russian, Turkish, French, German	
Serial Connectors		By Date, Time, Event, Block, File, Bookmark, Log File	
Power Supply		USB 2.0x3, RS-232C, RS-422 / RS-485	
Weight		AC100~240V 50/60 Hz, DC12V / 10A	
Dimensions (WxHxD)		Approx. 8 Kg (without HDD)	
Operating Environment		430x90x425 mm	
		30 ~ 80% RH, 5°C ~ 40°C (41°F ~ 104°F)	

■ IPS: Images Per Second

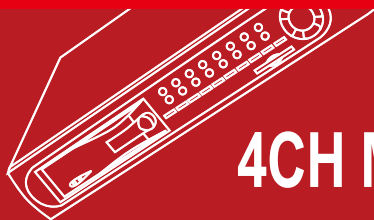

4CH MPEG4 Triplex Network DVR

Features

- Real-time recording as MPEG4 compression
- Simultaneously operate of live, recording, playback and network
- 4 channels audio recording, remote 2-way audio conference
- 3 IDE HDDs support (option)
- 1 USB port for USB backup (Flash Memory, USB HDD)
- Built-in CD-RW (option)
- TCP/IP, Static IP, Dynamic IP, DHCP, DDNS support
- Spot monitor output, VGA option
- Pre / Post-Alarm recording (5 seconds / 3 minutes)
- Control PTZ camera through RS-485
- Remote controller
- AVI file backup

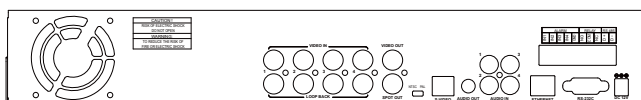

Model No.	RYK-9305	
Video	Format	NTSC / EIA or PAL / CCIR
	Compression	MPEG4
	Input	4 CH, BNC
	Loop Output	4 CH, BNC
	Main Output	1 CH, BNC / 1 CH, S-Video / VGA (option)
Audio	Spot Output	1 CH, BNC
	Input	4 CH, RCA
	Output	1 CH, RCA
	Remote	2-way audio conference
Display	Resolution	720x480 (NTSC), 720x576 (PAL)
	Frame Rate	Max. 120 / 100 IPS (NTSC / PAL)
	Division	Single, Quad, Sequence
Recording	Resolution	352x240, 704x240, 704x480 (NTSC), 352x288, 704x288, 704x576 (PAL)
	Frame Rate	120, 60, 30 IPS (NTSC), 100, 50, 25 IPS (PAL)
	Quality	Highest, High, Medium, Low, Lowest
	Pre / Post Alarm Recording	5 secs (Pre), 3 mins (Post), programmable per camera
	Mode	Manual / Schedule / Event (Motion Detection / Video Loss / Sensor)
HDD	Basic Storage	2x3.5" IDE HDD (Max. 750GB) with CD-RW or 3x3.5" IDE HDD (Max. 750GB) without CD-RW
	Requirement	5400 ~ 7200RPM, 45MHz DMA, EIDE compatible, Faster than 9.0ms avg.
Alarm	Input	4 (NO / NC programmable)
	Output	1 Relay with NO / NC contact: DC30V / 1A, AC125V / 0.5A resistive
	Triggered Mode	Motion Detection, Video Loss, Sensor Input, Power Failure, HDD Error
	Action	Recording, Relay Output, Sound Alert
Network	Protocol	10/100 BaseT Ethernet, TCP/IP, DHCP, DDNS
	Remote	View, Search, Recording & Control by Client Program or IE Browser
Backup Device	USB (Flash Memory, USB HDD) / CD-RW (option)	
PTZ Camera	Support (Up to 18 models)	
Backup File Format	AVI, JPG, BMP	
Multi-Language	English	
Search Method	By Date, Time, Event	
Serial Connectors	USBx1, RS-232C, RS-485	
Power Supply	AC100~240V 50/60 Hz, DC12V / 5A	
Weight	Approx. 4.1 Kg (without HDD)	
Dimensions (WxHxD)	430x70x310 mm	
Operating Environment	30 ~ 80% RH, 5°C ~ 40°C (41°F ~ 104°F)	

■ IPS: Images Per Second

4CH MPEG4 Network DVR

Features

- System auto detection (NTSC / PAL)
- Recording mode: manual / continuous / motion detection / alarm (RYK-9324)
- Max. 60 images per second recording
- Option: TCP/IP network connection
- System auto recovery after power reconnected
- HDD viewer
- RYK-9324: Alarm Input / Output
 - CF card backup as ASF file format
 - 1CH Audio recording
 - VGA Display (option)



• RYK-9320



• RYK-9324

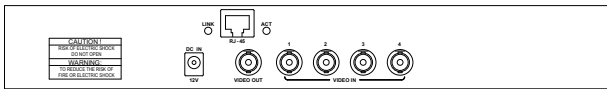

RYK-9320N

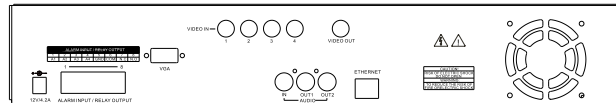

RYK-9324N

Model No.		RYK-9320	RYK-9324
Video	Format	NTSC / EIA or PAL / CCIR	
	Compression	MPEG4	
	Input	4 CH, BNC	
	Output	1 CH BNC	1 CH BNC, 1 CH VGA (option)
Audio	Input	—	1 CH, RCA
	Output	—	2 CH, RCA
Display	Resolution	720x480 (NTSC), 720x576 (PAL)	
	Frame Rate	120 / 100 IPS (NTSC / PAL)	
	Division	Single, Quad, Sequence	
	Recording	Resolution	352x240 (NTSC), 352x288 (PAL)
Recording	Frame Rate	Max. 60 / 50 IPS (NTSC / PAL)	
	Quality	High / Medium / Low	
	Mode	Manual / Schedule / Alarm / Motion Detection	
	HDD	Basic Storage	1x3.5" IDE HDD (Max. 750GB)
Alarm	Input / Output	—	4 / 1 (NO / NC programmable)
	Triggered Mode	Motion Detection, Video Loss	Motion Detection, Video Loss, Sensor Input
	Action	Recording, Sound Alert	Recording, Relay Output, Sound Alert
Network	IE Support	Option	
	Ethernet	10 / 100 BaseT Ethernet (RJ-45)	
	Protocol	TCP/IP, PPPoE, DDNS, SMTP, ICMP, ARP	
Post Alarm		1 ~ 60 sec	
Search Method		By Date, Time	
Motion Detection		Detect area selectable and sensitivity adjustable	
Password Protection		Yes	
Backup Device		VCR	CF-Card (ASF File format), VCR
Power Supply		AC100~240V 50/60 Hz, DC12V / 2.5A	AC100~240V 50/60 Hz, DC12V / 4.2A
Weight		3.0 Kg (without HDD)	3.6 Kg (without HDD)
Dimensions (WxHxD)		320x45x270 mm	430x70x316 mm
Operating Environment		30 ~ 80% RH, 5°C ~ 40°C (41°F ~ 104°F)	

■ IPS: Images Per Second

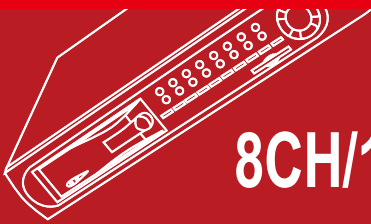

8CH/16CH MPEG4 Network DVR

Features

- System auto detection (NTSC / PAL)
- Recording mode: manual / continuous / motion detection / alarm
- Alarm Input / Output
- Max. 60 images per second recording
- 750GB HDD support
- CF card backup as ASF file format
- TCP/IP network connection (option)
- System auto recovery after power reconnected
- HDD viewer

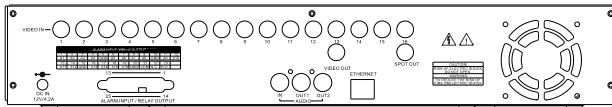

RYK-9326N

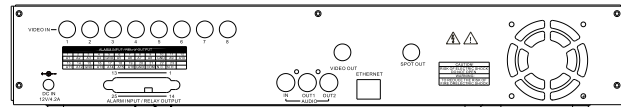

RYK-9327N

Model No.		RYK-9326	RYK-9327
Video	Format	NTSC / EIA or PAL / CCIR	
	Compression	MPEG4	
	Input	16 CH, BNC	8 CH, BNC
	Output	1 CH BNC, 1CH SPOT BNC	
Audio	Input	1 CH, RCA	
	Output	2 CH, RCA	
Display	Resolution	720x480 (NTSC), 720x576 (PAL)	
	Frame Rate	8 CH mode: 240 / 200 IPS (NTSC / PAL) 16 CH mode: 120 / 100 IPS (NTSC / PAL)	240 / 200 IPS (NTSC / PAL)
	Division	Single, Sequence, Spit (4,9,16)	Single, Sequence, Spit (4,9)
Recording	Resolution	704x240 (NTSC), 704x288 (PAL)	
	Frame Rate	Max. 60 / 50 IPS (NTSC / PAL)	
	Quality	High / Medium / Low	
	Mode	Manual / Schedule / Alarm / Motion Detection	
HDD	Basic Storage	1x3.5" IDE HDD (Removable, Max. 750GB)	
Alarm	Input / Output	16 / 1 (NO / NC programmable)	8 / 1 (NO / NC programmable)
	Triggered Mode	Motion Detection, Video Loss, Sensor Input	
	Action	Recording, Relay Output, Sound Alert	
Network	IE Support	Option	
	Ethernet	10 / 100 BaseT Ethernet (RJ-45)	
	Protocol	TCP/IP, PPPoE, DDNS, SMTP, ICMP, ARP	
Post Alarm		1 ~ 60 sec	
Search Method		By Date, Time	
Motion Detection		Detect area selectable and sensitivity adjustable	
Password Protection		Yes	
Backup Device		CF-Card (ASF File format), VCR	
Power Supply		AC100~240V 50/60 Hz, DC12V / 4.2A	
Weight		3.6 Kg (without HDD)	
Dimensions (WxHxD)		430x70x316 mm	
Operating Environment		30 ~ 80% RH, 5°C ~ 40°C (41°F ~ 104°F)	

■ IPS: Images Per Second

8CH/16CH MJPEG Network DVR

Features

- System auto detection (NTSC / PAL)
- Recording mode: manual / continuous / motion detection / alarm
- Alarm Input / Output
- Max. 60 images per second recording
- 750GB HDD support
- CF card backup as ASF file format
- TCP/IP network connection (option)
- System auto recovery after power reconnected
- HDD viewer

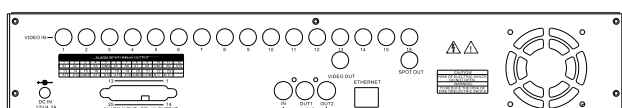

RYK-9816N

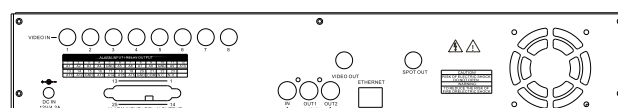

RYK-9817N

Model No.		RYK-9816	RYK-9817
Video	Format	NTSC / EIA or PAL / CCIR	
	Compression	MJPEG	
	Input	16 CH, BNC	8 CH, BNC
	Output	1 CH BNC, 1 CH SPOT BNC	
Audio	Input	1 CH, RCA	
	Output	2 CH, RCA	
Display	Resolution	720x480 (NTSC), 720x576 (PAL)	
	Frame Rate	8 CH mode: 240 / 200 IPS (NTSC / PAL) 16 CH mode: 120 / 100 IPS (NTSC / PAL)	240 / 200 IPS (NTSC / PAL)
	Division	Single, Sequence, Spit (4,9,16)	Single, Sequence, Spit (4,9)
Recording	Resolution	Max. 704x240 (NTSC), 704x288 (PAL)	
	Frame Rate	Max. 60 / 50 IPS (NTSC / PAL)	
	Quality	High / Medium / Low	
	Mode	Manual / Schedule / Alarm / Motion Detection	
HDD	Basic Storage	1x3.5" IDE HDD (Removable, Max. 750GB)	
Alarm	Input / Output	16 / 1 (NO / NC programmable)	8 / 1 (NO / NC programmable)
	Triggered Mode	Motion Detection, Video Loss, Sensor Input	
	Action	Recording, Relay Output, Sound Alert	
Network	IE Support	Option	
	Ethernet	10 / 100 BaseT Ethernet (RJ-45)	
	Protocol	TCP/IP, PPPoE, DDNS, SMTP, ICMP, ARP	
Post Alarm		1 ~ 60 sec	
Search Method		By Date, Time	
Motion Detection		Detect area selectable and sensitivity adjustable	
Password Protection		Yes	
Backup Device		CF-Card (AVI File format), VCR	
Power Supply		AC100~240V 50/60 Hz, DC12V / 4.2A	
Weight		3.6 Kg (without HDD)	
Dimensions (WxHxD)		430x70x316 mm	
Operating Environment		30 ~ 80% RH, 5°C ~ 40°C (41°F ~ 104°F)	

■ IPS: Images Per Second

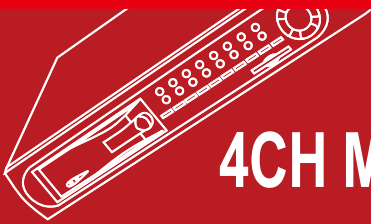

4CH MJPEG Network DVR

Features

- System auto detection (NTSC / PAL)
- Motion Detection recording
- Alarm Input / Output
- Quad and each record image size
- Max. 120 images per second recording
- 500GB HDD support
- Removable HDD
- CF card backup
- TCP/IP network connection with DHCP and Dynamic DNS support (option)

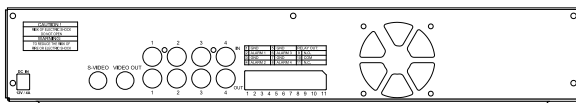

RYK-9810

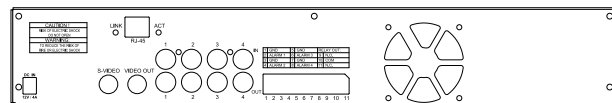

RYK-9811

Model No.		RYK-9810	RYK-9811
Video	Format	NTSC / EIA or PAL / CCIR	
	Compression	MJPEG	
	Input	4 CH, BNC	
	Output	1 CH BNC, 1 CH S-Video	
Display	Resolution	720x480 (NTSC), 720x576 (PAL)	
	Frame Rate	Max. 120 / 100 IPS (NTSC / PAL)	
	Division	Single, Quad, Sequence	
Recording	Resolution	Max. 640x224 (NTSC), 640x272 (PAL)	
	Frame Rate	Max.120 IPS@CIF / 100 IPS@CIF (NTSC / PAL)	
	Quality	High / Normal / Low	
	Mode	Manual / Schedule / Alarm / Motion Detection	
HDD	Basic Storage	1x3.5" IDE HDD (Removable, Max. 500GB)	
Alarm	Input / Output	4 / 1	
	Triggered Mode	Motion Detection, Video Loss, Sensor Input	
	Action	Recording, Relay Output, Sound Alert	
Network	Ethernet	—	10/100 BaseT Ethernet (RJ-45)
	Protocol	—	TCP/IP, PPPoE, DDNS, SMTP, ICMP, ARP
Post Alarm		1 ~ 60 sec	
Search Method		By Date, Time, Event	
Motion Detection		Detect area selectable and sensitivity adjustable	
Backup Device		CF-Card, HDD, VCR	
Power Supply		AC100~240V 50/60 Hz, DC12V / 5A	
Weight		3 Kg (without HDD)	
Dimensions (WxHxD)		430x70x316 mm	
Operating Environment		30 ~ 80% RH, 5°C ~ 40°C (41°F ~ 104°F)	

■ IPS: Images Per Second

4CH MJPEG Network DVR

Features

- System auto detection (NTSC / PAL)
- 4 Alarm Input / 1 Relay Output
- Max. 120 images per second recording
- Quad and each record image size
- Various recording modes of manual, schedule, alarm and motion detection
- 500GB HDD support
- Removable HDD (option)
- TCP/IP network connection with DHCP and Dynamic DNS support (option)

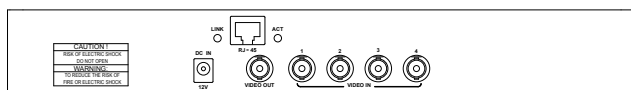

RYK-9820N

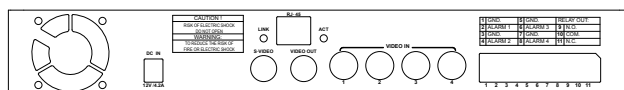

RYK-9807N

Model No.		RYK-9820	RYK-9807
Video	Format	NTSC / EIA or PAL / CCIR	
	Compression	MJPEG	
	Input	4 CH, BNC	
	Output	1 CH BNC	1 CH BNC, 1 CH S-Video
Display	Resolution	720x480 (NTSC), 720x576 (PAL)	
	Frame Rate	Max. 120 / 100 IPS (NTSC / PAL)	
	Division	Single, Quad	
Recording	Resolution	Max. 640x224 (NTSC), 640x272 (PAL)	
	Frame Rate	Max. 120 / 100 IPS (NTSC / PAL)	
	Quality	High / Normal / Low	
	Mode	Manual / Schedule / Motion Detection	Manual / Schedule / Alarm / Motion Detection
HDD	Basic Storage	1x3.5" IDE HDD (Max. 500GB)	
Alarm	Input / Output	—	4 / 1 (NO / NC programmable)
	Triggered Mode	Motion Detection, Video Loss	Motion Detection, Video Loss, Sensor Input
	Action	Recording, Sound Alert	Recording, Relay Output, Sound Alert
Network	IE Support	Option	
	Ethernet	10/100 BaseT Ethernet (RJ-45)	
	Protocol	TCP/IP, PPPoE, DDNS, SMTP, ICMP, ARP	
Post Alarm		1 ~ 60 sec	
Search Method		By Date, Time, Event	
Motion Detection		Detect area selectable and sensitivity adjustable	
Power Supply		AC100~240V 50/60 Hz, DC12V / 2.5A	AC100~240V 50/60 Hz, DC12V / 4.2A
Weight		3 Kg (without HDD)	
Dimensions (WxHxD)		320x45x270 mm	
Operating Environment		30 ~ 80% RH, 5°C ~ 40°C (41°F ~ 104°F)	

■ IPS: Images Per Second

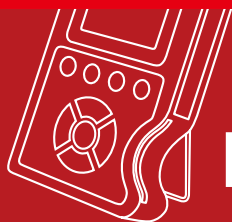

Digital Video Capture Camera

Features

- Portable and compact size
- Built-in Hi-Resolution Camera
- Continuous and Motion Detection recording
- Three level image quality adjustable
- Built-in Flash Memory (Capacity option)
- DC12V or 4xAA Batteries
- User-friendly front panel design



Storage Capacity :

Unit: minutes

Quality Level	640x480@12 IPS	320x240@30 IPS
High	125	220
Medium	240	270
Low	400	550

(Approx. for recording motion movie with 512MB memory)

Model No.	RYK-9103	
Image Device	1/4" Color CMOS sensor	
Video Format	NTSC / PAL	
S/N Ratio	46dB	
Electronic Shutter	1/60~1/15,000	
Lens Furnished	Cone Lens 3.8mm / F2.0	
White Balance	Auto	
Gain Control	Auto	
Video Compression	MPEG4	
Recording	Resolution	VGA (640x480)@12 IPS / QVGA (320x240)@30 IPS
	Quality	High / Medium / Low
	Mode	Continuous, Motion Detection
Storage Capacity	Built-in Flash Memory (512MB/1GB/2GB/4GB, option)	
Memory Full	Selectable Function: Full Stop / Overwrite	
Playback Mode	Forward / Rewind: x1 / x4 / x8 / x16 / x32, Pause and Step	
Search Method	By Date, Time	
Motion Detection	Full Screen / Adjustable Detect sensitivity rate 1~99	
On Screen Display	Mode / Date / Time / Status / Set-up Menu	
Video Output	1 Vp-p / 75 Ohms	
Power Supply	DC12V / AC110V or DC12V / AC230V (option) or 4xAA Batteries	
Power Consumption	2.0W max.	
Dimensions (WxHxD)	100x70x35.7 mm	

■ IPS: Images Per Second

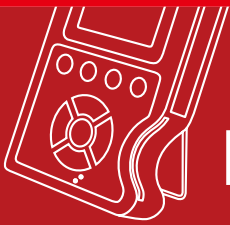

Digital Video Capture Camera

Features

- MPEG4 compression
- Portable and compact size
- Built-in Hi-Resolution Camera
- Continuous and Motion Detection recording
- Three level image quality adjustable
- Support SD card
- DC12V or 4xAA Batteries
- User-friendly front panel design



Storage Capacity :

Unit: minutes

Quality Level	640x480@12 IPS	320x240@30 IPS
High	125	220
Medium	240	270
Low	400	550

(Approx. for recording motion movie with 512MB Card)

Model No.	RYK-9109	
Image Device	1/6" Color CMOS sensor	
Video Format	NTSC / PAL	
S/N Ratio	45dB	
Electronic Shutter	Auto	
Lens Furnished	Board Lens 3.62mm / F2.8	
White Balance	Auto	
Gain Control	Auto	
Video Compression	MPEG4	
Recording	Resolution	VGA (640x480)@12 IPS / QVGA (320x240)@30 IPS
	Quality	High / Medium / Low
	Mode	Continuous, Motion Detection
Storage Capacity	Secure Digital (SD) Card	
Memory Full	Selectable Function: Full Stop / Overwrite	
Playback Mode	Forward / Rewind: x1 / x4 / x8 / x16 / x32, Pause and Step	
Search Method	By Date, Time	
Motion Detection	Full Screen/ Adjustable Detection Sensitivity	
On Screen Display	Mode / Date / Time / Status	
Video Output	1 Vp-p / 75 Ohms	
Power Supply	DC12V/AC110V or DC12V/AC230V (option) or 4xAA Batteries	
Power Consumption	2.0W max.	
Dimensions (WxHxD)	82x134x71 mm	

■ IPS: Images Per Second

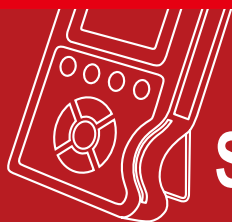

SecuMate Mini Portable Security Recorder

Features

- MPEG4 compression
- Portable and compact size
- Video loss auto detection
- Audio recording
- Adjustable sensitivity and area selectable for motion detection
- Three levels image quality
- Backup ASF file format with time stamp
- Record mode: Manual / Continuous / Motion Detection
- Independent frame rate for each recording mode
- Support SD card
- DC5V or 2xAA Batteries



Storage Capacity :

Unit: minutes

Quality Level	704x240@24 IPS	352x240@30 IPS
High	64	160
Medium	128	320
Low	192	480

(Approx. for recording motion movie with 1GB Card)

Model No.		RYK-9122
Video	System	NTSC / PAL with Video Loss Auto Detection
	Codec	MPEG4-SP ASF File Format
	Recording Frame Rate	704x480@12 IPS, 352x240@30 IPS (NTSC) 704x560@10 IPS, 352x280@25 IPS (PAL)
	Recording Quality	High / Medium / Low
	Recording Date / Time	Overlay with Video Images in ASF File
	Input	1 CH, Phone Jack
Audio	Output	1 CH, Phone Jack
	Sampling Rate	44.1 KHz
	Codec	G.726 / 32 kbps
	Input	1 CH, Phone Jack
Storage Media	Output	1 CH, Phone Jack
	Storage Media	Secure Digital (SD) Card
	Recording Mode	Schedule / Motion Detection / Manual
	Motion Detection Setting	Multiple Blocks and adjustable sensitivity
	Playback Function	Play / Fast Forward / Fast Rewind / Pause / Step Forward / Step Rewind
	Playback Speed	x1 / x2 / x4 / x8 / x16 / x32
	Power Supply	AC100~240V 50/60 Hz, DC5V / 1A or AAx2 Batteries Rechargeable Ni-MH / Alkaline Battery / CR-V3 / RCR-V3
	Power Consumption	2.5W max.
	Weight	150 g (without Battery)
	Dimensions (WxHxD)	65x90x27 mm
Operating Environment	30~80% RH, 5°C ~ 40°C (41°F ~ 104°F)	

■ IPS: Images Per Second

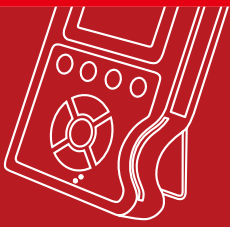

SecuMate Portable Security Recorder

Features

- MPEG4 video and audio
- CF card plug and record function
- Wireless camera for both day and night use
- Motion Detection and schedule recording
- Built-in 2.5" color LCD
- Package include: Portable MPEG4 DVR, Wireless IR Camera



Storage Capacity :

Unit: minutes

Quality Level	704x240@12 IPS	352x240@30 IPS	352x240@15 IPS
High	160	160	320
Medium	320	320	640
Low	480	480	960

(Approx. for recording motion movie with 1GB Card)

Application :



Baby Monitor



Access Control



Anti-burglar

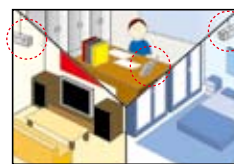

Home Surveillance

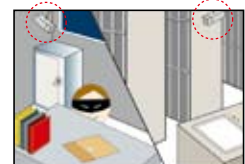

Asset Security

RYK-9121K

Portable MPEG4 DVR

Video	System	NTSC / PAL
	Codec	MPEG4-SP ASF File Format
	Recording Frame Rate	1-30 IPS (adjustable)
	Resolution	704x240, 352x240 (NTSC) 704x288, 352x288 (PAL)
	Input	1 CH, Phone Jack
	Output	1 CH, Phone Jack
Audio	Codec	G.726 / 32 Kbps
	Input	1 CH, Phone Jack
	Output	1 CH, Phone Jack
Video Quality Level		High / Medium / Low
Storage Media		Compact Flash (CF) Card
Recording Mode		Manual / Schedule / Motion Detection
Recording Detection Setting		Detect Area / Sensitivity
Event Search Function		Property and first image of selected file is displayed
Playback Speed		X1 / x2 / x4 / x8 / x16 / x32
TFT LCD Panel		2.5"
Speaker		Built-in
Power Supply		AC100~240V 50/60 Hz, DC12V / 1A or AAx4 Batteries
Dimensions (WxHxD)		142.5x91x30 mm

Wireless IR Camera

Image Device	1/3" Color CMOS
Lens Furnished	Board Lens 3.6mm / F2.0
White Balance	Auto
Infrared Luminary	8 pieces IR-LED
Illuminate Distance	5 M
Power Supply	AC100~240V 50/60 Hz, DC12V
Operating Environment	80%RH, -10°C ~ 50°C (14°F ~ 122°F)
Dimensions (WxHxL)	72x47.5x96.6 mm

■ IPS: Images Per Second

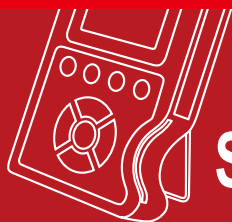

SecuMate Pro Portable Security Recorder

Features

- 2.5" LCD panel for instant view
- Built-in camera with 6 pieces IR LED
- Remote controller of the system
- Rechargeable battery for mobile usage
- Able to power the external cameras
- Stores images as ASF file format in SD card and can be downloaded to PC via USB connection
- Recording mode: manual / continuous / motion detection / alarm
- Audio record and playback using internal microphone, speaker and earphone
- Multi-language OSD: English, Tradition Chinese, German, Spanish, Italian, French and Japanese



Storage Capacity :

Unit: minutes

Quality Level	640x480@12 IPS	320x240@30 IPS
High	155	150
Medium	280	380
Low	340	600

(Approx. for recording motion movie with 1GB Card)

Model No.		RYPK-9107
Video	System	NTSC / PAL with Video Loss Auto Detection
	Codec	MPEG4-SP ASF File Format
	Recording Frame Rate	Max. 320x240@30 IPS / 640x480@12 IPS
	Recording Quality	High / Medium / Low
	Recording Mode	Manual / Schedule (Alarm / Motion Detection / Continuous)
	Time Stamp	Overlay with Video Images in ASF File
	Input	1 CH, Phone Jack
Audio	Output	1 CH, Phone Jack
	Sampling Rate	44.1 KHz
	Codec	G.726 / 32 kbps
	Input	1 CH, Phone Jack
	Output	1 CH, Phone Jack
Device	Microphone / Speaker / Earphone	
Storage Media	Secure Digital (SD) Card	
Serial Port	USB 1.1 (Ready-Only)	
Motion Detection Setting	Multiple Blocks and adjustable sensitivity	
Event Search Function	Property and first image of selected file is displayed	
Playback Function	Play / Fast Forward / Fast Rewind / Pause / Step Forward / Step	
Playback Speed	x1 / x2 / x4 / x8 / x16 / x32	
Power Supply	DC5V / 1A, Rechargeable Li-ion Battery	
Weight	175 g	
Dimensions (WxHxD)	86x55x22.5 mm	
Operating Environment	30~80% RH, 5°C ~ 40°C (41°F ~ 104°F)	

OPTIONAL FUNCTION

Camera	Sensor	1/6" Color CMOS Sensor
	Effective Picture	VGA (H/V: 640x480)
	S/N Ratio	46dB
	Lens	Cone Lens 3.62mm / F2.8
	Infrared Luminary	6 pieces IR-LED
	Infrared Wavelength	850nm
Remote Control	2.4GHz Transmission	
LCD	2.5" Color TFT-LCD	

■ IPS: Images Per Second

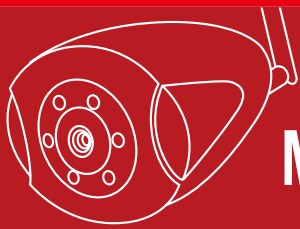

MPEG4 Pan/Tilt IP Camera

Features

- MPEG4 Compression, up to 30 IPS@VGA
- Support Preset / Auto-pan Pan/Tilt IP Camera
- Support Motion Detection
- Support 2 Way Audio & Wireless (option) & IR LED for Day and Night (option)
- SD Card for local storage
- Support 3GPP (RTP / RTSP) and 2.5G mobile phone
- QoS to guarantee system stability at 64K bandwidth
- Easy to install and configure

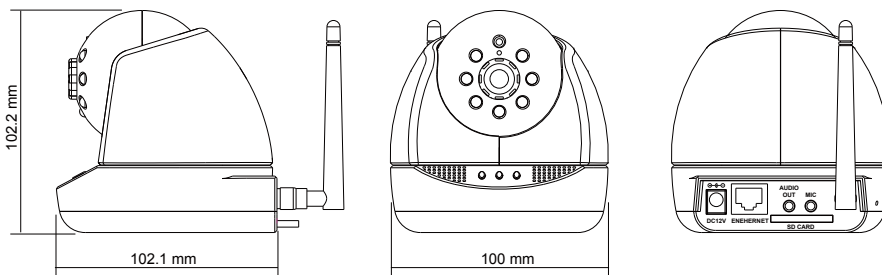

Model No.		RYK-IP2280(W)
Camera	Image Sensor	1/4" 640x480 Color CMOS sensor
	AES / AWB / AGC	Yes
	Flip / Mirror	Yes
	Lens	3.6mm / F2.0, Diag. FOV = 69°
	Filter	Day & Night
Pan / Tilt	IR LED	7 pieces Auto Detect (option)
	Pan	350° (+175° ~ -175°)
	Tilt	125° (+90° ~ -35°)
	Auto Pan	Yes
Audio	Auto Patrol	Yes
	Built in MIC	Yes
Video	Audio Out Terminal	Yes (2 way audio)
	Encoder	MPEG4 30 IPS@VGA
	Resolution	VGA / QVGA / QQVGA
	Frame Rate	1~30 IPS / 1~5 IPS for 3GPP
	Quality	Variable Bit Rate / Constant Bit Rate
	Date / Time	Overlay with video image
Motion Detection	Detection Window	3 adjustable windows
	Sensitivity	Adjustable for each detection window
	Action	SD storage / Email / FTP
Viewer	IE Browser	Live View / Set up / Record
	16CH Viewer	Live View / Record for 1~16CH
	Mobile Phone	Live View for 3G or 2.5G mobile phone
Network	Ethernet	10/100 BaseT Ethernet (RJ-45)
	Wireless	802.11 b/g 2.4GHz (Option)
	Auto Reconnection	Yes
	Protocol	UPnP, TCP/IP, HTTP, DNS, SMTP, FTP, NTP, DHCP, PPPoE, DDNS, RTP/RTSP
Storage Media		SD Card (FAT16/32 SD2.0)
Power Supply		DC12V
SDK		Support SDK for SI integration
Weight		400 g (with Wireless / IR-LED)
Dimensions (WxHxD)		100x102.2x102.1 mm
Operating Environment		30%~80% RH, 5°C~ 45°C (41°F ~ 113°F)

■ IPS: Images Per Second

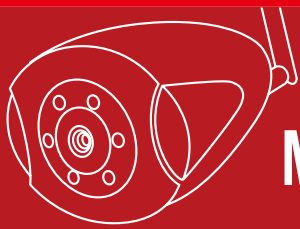

MPEG4 / MJPEG IP Camera

Features

- MPEG4 / MJPEG Dual Codec Video Compression
- Sony 1/3" CCD image sensor
- Support low level and hi level SDK for SI integration
- Excellent image quality with up to 25 / 30 IPS at D1
- Live Video via 2.5G / 3G mobile phone surveillance application
- Support Motion Detection
- Superior low light performance up to 0.1Lux / F1.2

■ 16CH Recording Software (for RYK-IP3400(W/E)):



RYK-IP3400(W/E)



RYK-IP185

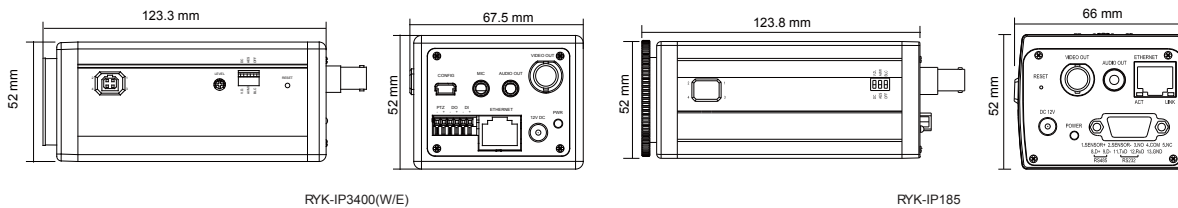

RYK-IP3400(W/E)

RYK-IP185

Model No.		RYK-IP3400(W/E)	RYK-IP185
Camera	Image Sensor	1/3" Color Sony Super CCD sensor	
	AES / AWB / AGC	Yes	
	Resolution	NTSC: 510x492, PAL: 500x582	
	Min. Illumination	0.1 lux / F1.2	
	Iris Control	Video / DC Drive	
	Lens Mount	C / CS mount	
	Back Light Comp.	On / Off	
Video	Resolution	720x480 (NTSC), 720x576 (PAL)	640x480 (NTSC), 704x576 (PAL)
	Frame Rate	Max. 30 / 25 IPS (NTSC / PAL)	Max 20 / 15 IPS (NTSC / PAL)
	Compression	Dual Codec (MPEG4 / MJPEG)	MJPEG
	Output	1 CH, BNC	
Audio	Input	Built-in Microphone	
	Output	1CH, Phone Jack	1CH, RCA
	Compression	ADPCM / GSM-AMR / MP3	AC-97
Software	Schedule	Yes	
	Motion Detection	Yes	
	16CH	Yes	Option
Alarm	Input / Output	1 / 1	
	Triggered mode	Motion Detection / Sensor Input	
	Action	Digital Output, E-mail, FTP	Relay Output, E-mail, FTP
Network	Ethernet	10/100 BaseT Ethernet (RJ-45)	
	Wireless	802.11 b/g 2.4GHz (option)	—
	PoE	Option	—
	Auto Reconnection	Yes	
	Protocol	TCP/IP, FTP, SMTP, DNS, DDNS, DHCP, HTTP and PPPoE	TCP/IP, SMTP, FTP, NTP, DNS, DDNS and PPPoE
Motion Detection	Yes		
Serial Connectors	RS-485, USB, Ethernet		RS-232, RS-485, Ethernet
Pan / Tilt / Zoom Control	PELCO D&P		
SDK Support	Yes		
Power Supply	DC12V / 2A		DC12V / 0.5A
Dimensions (WxHxD)	68x52x123 mm		66x52x124 mm
Operating Environment	85% RH, 0°C~45°C (32°F ~ 113°F)		30~80% RH, 5°C~45°C (41°F ~ 113°F)

■ IPS: Images Per Second

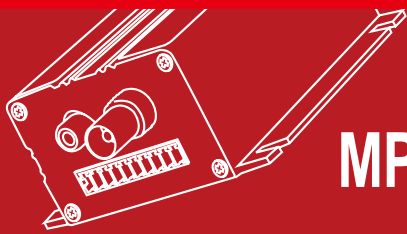

MPEG4 / MJPEG Video Server

Features

- MPEG4 / MJPEG Dual Codec Compression
- Two Way Audio communication
- Support SD card for local Storage
- Support low level and high level SDK for SI integration
- Support USB for easy IP configuration
- Excellent image quality with up to 25 / 30 IPS at D1



RYK-VS110(W/E)



RYK-9909

■ 16CH Recording Software (for RYK-VS110(W/E)):

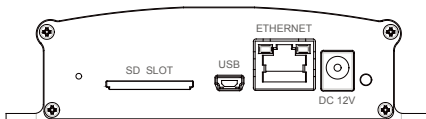

RYK-VS110(W/E)

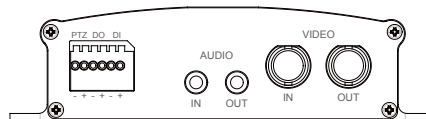

RYK-9909

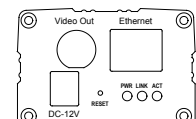
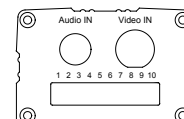

Model No.		RYK-VS110(W/E)	RYK-9909
Video	Frame Rate	Max 30 / 25 IPS (NTSC / PAL)	Max 20 / 15 IPS (NTSC / PAL)
	Compression	Dual Codec (MPEG4 / MJPEG)	MJPEG
	Input		1 CH, BNC
	Output		1 CH, BNC
Audio	Input	1 CH, Phone Jack	1 CH, RCA
	Output	1 CH, Phone Jack	—
	Compression	ADPCM / MP3 (Audio Out)	AC-97
Software	Schedule		Yes
	Motion Detection		Yes
	16CH	Yes	Option
Alarm	Input / Output		1/1
	Triggered mode		Motion Detection / Sensor Input
	Action	Digital Output, E-mail, FTP, SD Card	Relay Output, E-mail, FTP
Network	Ethernet		10 / 100 Baset Ethernet (RJ-45)
	Wireless	802.11 b/g 2.4GHz (option)	—
	PoE	Option	—
	Auto Reconnection		Yes
	Protocol	TCP/IP, FTP, SMTP, DNS, DDNS, DHCP, HTTP and PPPoE	
Storage Media		SD Card (FAT16/32 SD2.0)	—
Motion Detection		Yes	
Serial Connectors		RS-485, USB, Ethernet	RS-232, RS-485, Ethernet
Pan / Tilt / Zoom Control		PELCO D&P	
Power Supply		DC12V / 1A	DC12V / 0.5A
Dimensions (WxHxD)		103x32x138 mm	64x40x100 mm
Operating Environment		85% RH, 0°C~45°C (41°F ~ 113°F)	30~80% RH, 5°C~45°C (41°F ~ 113°F)

■ IPS: Images Per Second

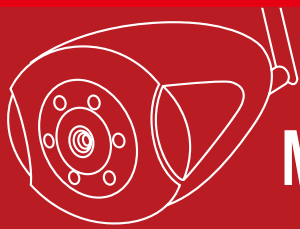

MPEG4 IP Camera

Features

- MPEG4 Compression, up to 30 IPS@VGA
- Support Wireless & 2 Way Audio (option)
- SD Card for local storage
- Support 3GPP (RTP / RTSP)
- Support Day and Night mode
- IP Display on LCD for easy installation / management
- Easy Zoom In / Out by mouse control
- IR LED schedule / manual setting
- QoS to guarantee system stability at 64K bandwidth

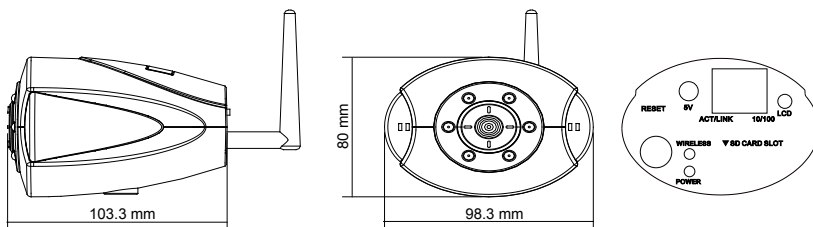

Model No.		RYK-IP1130(W)
Camera	Image Sensor	1/6" 640x480 Color CMOS sensor
	AES / AWB / AGC	Yes
	Flip / Mirror	Yes
	Lens	3.62mm / F2.8, Diag. FOV = 66.12°
	Filter	Day & Night
Audio (Option)	Built in MIC	Yes
	Audio Out Terminal	Yes
Video	Encoder	MPEG4 30 IPS@VGA
	Resolution	VGA / QVGA / QQVGA
	Frame Rate	1~30 IPS / 1~5 IPS for 3GPP
	Quality	Variable Bit Rate / Constant Bit Rate
	Date / Time	Overlay with video image
Motion Detection	Detection Window	3 adjustable windows
	Sensitivity	Adjustable for each detection window
	Action	SD storage / Email / FTP
Viewer	IE Browser	Live View / Set up / Record
	16CH Viewer	Live View / Record
	Mobile phone	Live View for 3G or 2.5G mobile phone
Network	Ethernet	10/100 BaseT Ethernet (RJ-45)
	Wireless	Option (802.11 b/g 2.4GHz)
	Auto Reconnection	Yes
	Protocol	HTTP, SMTP, FTP, DHCP, PPPoE, DDNS
LCD	Yes (96x32, Display network status)	
Storage Media	SD Card (FAT16/32 SD1.0) for Motion Detection Storage	
Power Supply	DC5V / 1A	
SDK	Support SDK for SI integration	
Weight	167 g (with Wireless / Audio model)	
Dimensions (WxHxD)	98.3x80x103.3 mm	
Operating Environment	30%~80% RH, 5°C~ 45°C (41°F ~ 113°F)	

■ IPS: Images Per Second

Quad Processor

Features

- Real time refresh rate
- User-friendly front panel design and OSD set-up menu
- A smart automatic switcher allows random sequences and dwell time programming (except RYK-9003)



• RYK-9003



• RYK-9015

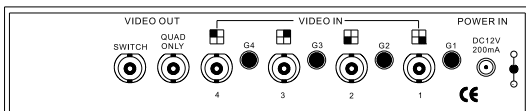

RYK-9003

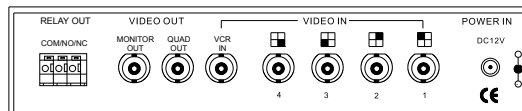

RYK-9015

Model No.	RYK-9015	RYK-9003
Description	Color Quad Processor	B/W Quad Processor
Channel	4 channels	
Video Format	NTSC / PAL (Auto detect)	—
Refresh Rate	NTSC:60 fields/sec, PAL:50 fields/sec	EIA:60 fields/sec, CCIR:50 fields/sec
Resolution (HxV)	NTSC:860x525, PAL:860x625	EIA:640x480, CCIR:640x576
Video Format	Full screen / Quad /Auto Switch / PIP / POP	Full Screen / Quad /Auto Switch
Title/Time Generator	8 characters for each channel, Real-Time-Clock	—
Picture quality adjustable	Brightness, Contrast, Chroma, Sharpness, Hue	—
Motion Detection	Yes	—
Buzzer	Video Loss & Motion Detection Alarm (Alarm time adjustable)	—
Freeze	Yes (Hold time adjustable)	—
Zoom Display	2x2 Zoom in Playback and Freeze	—
Video Input	4 Cameras, 1 VCR	4 Cameras
Video Output	1 Monitor, 1 Quad	1 Monitor, 1 Quad
Alarm Output	1 Relay Out (NC or NO)	—
Power Source	DC12V ± 10%	
Power Consumption	6W max.	3W max.
Dimension (WxHxD)	220x44x210 mm	

Multiplexer

Features

- Full Duplex allows recording and playback simultaneously
- Real time refresh rate
- User-friendly front panel design and OSD set-up menu
- A smart automatic switcher allows random sequences and dwell time programming



• RYK-9509



• RYK-9516

Multi Screen Display :

9 CH Multiplexer

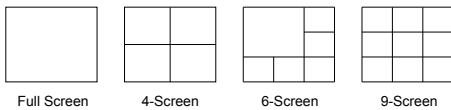

16 CH Multiplexer

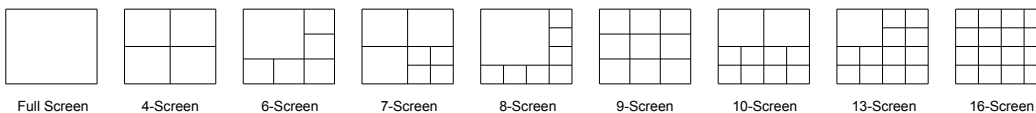

Model No.	RYK-9509	RYK-9516
Channel	9 channels	16 channels
Video Format	NTSC / PAL (Auto detect)	
Refresh Rate	NTSC:60 fields/sec, PAL:50 fields/sec	
Resolution (HxV)	NTSC:860x525, PAL:860x625	
Video Format	Full Screen / Auto Switch / Multi Screen (4,6,9)	Full Screen / Auto Switch / Multi Screen (4,6,7,8,9,10,13,16)
Title Generator	8 characters for each channel	7 characters for each channel
Time Generator	Built-in real time clock	
Picture Quality Adjustable	Brightness, Contrast, Chroma, Sharpness	
Motion Detection	Yes	
Buzzer	Video Loss & Motion Detection Alarm	
Freeze	Yes	
Zoom Display	2x2 Zoom in Playback and Freeze	
Rec. & Playback Mode	Field or Frame mode	
Video Input	9 Cameras, 1 REC	16 Cameras, 1 REC
Video Output	1 Monitor, 1 Call Monitor, 1 REC	
Alarm Input	9 Inputs	16 Inputs
Power Source	DC12V ± 10%	
Power Consumption	10W max.	18W max.
Dimensions (WxHxD)	432x44x270 mm	



ACCESSORIES

- Video Transceiver / Receiver
- CCTV Lens
- Monitor
- Housing
- Bracket

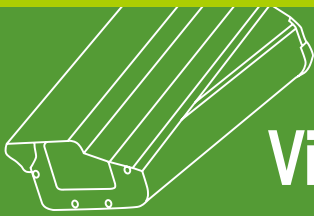

Video Transceiver / Receiver

Features

- Compact design
- Cost savings reduced need for costly coaxial cable
- Less down time - quicker moves, adds and changes
- Neater wiring - eliminates bulky cables in the office environment



• RYK-8334T

• RYK-8334R

• RYK-8335



• RYK-8337

Model No.	RYK-8335	RYK-8337	RYK-8334T	RYK-8334R
Description	UTP Passive Transceiver / Receiver	UTP Passive Receiver	UTP Active Transceiver Module	UTP Active Receiver Module
Video Transceiver	1 port	8 port	1 port	1 port
Transmission Distance	Max. 1000 FT / 750 FT (When used with DVR)		Max. 12000 FT (B/W) / 9000 FT (Color)	
Power In	None required		DC12~24V or AC	
Video In / Out	BNC male connector			
Video Format	RS 170, NTSC, PAL, CCIR or SECAM			
Operation Frequency Range	DC to 10 MHz			
Twisted Pair Connector	2 pin connector	8 pin connector	2 pin connector	
Common Mode Rejection	70 dB			
Wire Type	UTP Category 2, 3, 4, 5, 5e or 6 ; 12~24 AWG or Heavier			
Dimensions (WxHxD)	45.9x30.8x25.4 mm	313x44x255 mm	107.6x62.3x31.2 mm	

Accessories

CCTV Lens (1/3" CS Mount)

Model No.	Focal Length	Aperture	Angle of View	Remark
RYKL2520	2.5 mm	F2.0	Hor. 104°	Fixed Iris
RYKL3620A	3.6 mm	F2.0	Hor. 72°	Fixed Iris
RYKL4320A	4.3 mm	F2.0	Hor. 60°	Fixed Iris
RYKL0620A	6.0 mm	F2.0	Hor. 43°	Fixed Iris
RYKL0820A	8.0 mm	F2.0	Hor. 33°	Fixed Iris
RYKL1220A	12 mm	F2.0	Hor. 22°	Fixed Iris
RYKL1625	16 mm	F2.5	Hor. 19°	Fixed Iris



Monitor

Model No.	Description
RYK-8110	Color 10" Monitor, NTSC/PAL Auto-switch, With Y/C RGB H+V, Composite video input
RYK-8111H	Color 14" Monitor, NTSC/PAL Auto-switch, With Y/C RGB H+V, composite video input (Hi-Res.)
RYK-8112	Color 20" Monitor, NTSC/PAL Auto-switch, With Y/C RGB H+V, composite video input
RYK-8101	B/W 9" Monitor, Composite video input
RYK-8102	B/W 12" Monitor, Composite video input
RYK-8103	B/W 15" Monitor, Composite video input
RYK-8104	B/W 20" Monitor, Composite video input



• RYK-8111



• RYK-8103

Bracket

Model No.	Description
RYK-8701	Bracket 165 mm (Ivory)
RYK-8704	Bracket 115 mm (Black)
RYK-8704-4	Bracket 115mm (Ivory)
RYK-8704-2	Extender 10 cm for RYK-8704 (Black or Ivory)
RYK-8704-3	L Type Extender 10 cm for RYK-8704 (Black or Ivory)
RYK-8708	Bracket for Housing 285 mm (Ivory)
RYK-8719-3	L Type Bracket for Dome Camera



• RYK-8701

• RYK-8704/8704-4



• RYK-8719-3



• RYK-8704-2/8704-3

• RYK-8708

Housing

Model No.	Description
RYK-8501	Outdoor Housing 330x103x98 mm
RYK-8505	Outdoor Housing 395x145x105 mm
RYK-8505H	RYK-8505 W / Heater
RYK-8505F	RYK-8505 W / Fan
RYK-8505HF	RYK-8505 W / Heater+Fan
RYK-8505L	RYK-8505 W / Heater+Fan+IR LED 20M, DC12V 900mA



• RYK-8501



• RYK-8505



• RYK-8505L



• R190009

• R190051

• R190050

• R190001

• R190002

• R106005

• R106006-1

• R420401-1

• RYK-8312

• R140000

• R413017

Accessories

Model No.	Description	Model No.	Description
R190001	Board Lens 2.5mm / F2.5	R190051	Pinhole Lens 3.7mm / F3.5
R190002	Board Lens 3.6mm / F2.0	R106005	Mount for Board Lens
R190003	Board Lens 4.3mm / F2.0	R106006-1	Mount for Pinhole Lens
R190004	Board Lens 6.0mm / F2.0	R140000	CS Mount
R190005	Board Lens 8.0mm / F2.0	R413017	DC+BNC+RCA Connector Cable 25cm
R190006	Board Lens 12mm / F2.5	R413020	DC+BNC Connector Cable 25cm
R190009	Cone Lens 3.7mm / F2.0	R420401-1	Auto Iris Pin (Male)
R190050	Pinhole Lens 5.5mm / F3.5	RYK-8312	Audio Board

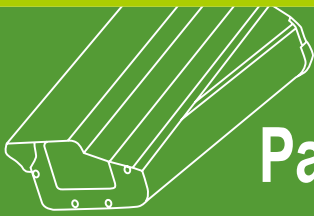

Packing Measurement

Item No.	Measurement				N.W.	G.W.
	PCS	CTN	cm	Cuft	Kg	Kg
RYK-AF301A/AF302A/AF201A/AF202A/AF203A/AF204A	70	1	47x33x24	1.31	17	18
RYK-AF301/AF302/20AZ/200Z/20AZR/200ZR	70	1	47x33x24	1.31	17	18
RYK-491DR	20	1	49x43x22	1.64	15	16
RYK-493DR/493DRX	20	1	49x43x22	1.64	14	15
RYK-235LVR3/232LVR3	20	1	49x43x22	1.64	13	14
RYK-475ZM3(ZM9)/472ZM3(ZM9)/775ZM3(ZM9)/777ZM3(ZM9)	20	1	49x43x22	1.64	14	15
RYK-213F/413F	20	1	49x43x22	1.64	11	12
RYK-275F/272F/277F/575F/577F/572F/573F	50	1	34x32x34	1.31	12	13
RYK-475F/472F/477F	20	1	34x32x34	1.31	15	16
RYK-775F/777F/772F/773F	20	1	34x32x34	1.31	13	14
RYK-264/569K	50	1	44x19x45	1.33	16	17
RYK-2F49L5/2F85L5/3F41L5/3F43L5/8800/8801	6	1	27x51x47	2.29	17	18
RYK-2R49VF3(VF9)/2R85VF3(VF9)/2R49XVR3(VF9)/2R85XVR3	20	1	49x43x22	1.64	13	14
RYK-2L49L2/2L85L3/3L41/3L43	12	1	61x44x27	2.55	18	19
RYK-2Q49L2(L3)/2Q85L2(L3)/3Q41L2(L3)/3Q43L2(L3)	20	1	42x26x44	1.70	11	12
RYK-2B49/2B85/3B41/3B43	50	1	44x19x45	1.33	15	16
RYK-9041	50	1	44x19x45	1.33	10	11
RYK-2A47L	70	1	47x33x24	1.31	17	18
RYK-2E00/2E01/2E02/2E03	2	1	51x35x35	2.21	9	10
RYK-8330	5	1	55x45x30	2.62	11	12
RYK-2E49/2E85	8	1	51x48x41	3.54	11	12
RYK-2S90LVF3(VR3)/2S49LVF3/2S85LVF3/2S49XLVR3/2S85XLVR3	8	1	61x44x27	2.56	11	12
RYK-2H49LVF3/1/2H85LVF3/1/2H49XLVR3/1/2H85XLVR3/1	10	1	61x44x27	2.56	25	26
RYK-2H49L/2H85L	10	1	61x44x27	2.56	25	26
RYK-2H49VF3(VF9)/2H85VF3(VF9)	10	1	61x44x27	2.56	24	25
RYK-2H49/2H85	10	1	61x44x27	2.56	23	24
RYK-2K49LVF3/1/2K85LVF3/1/2K49XLVR3/1/2K85XLVR3/1	12	1	61x44x27	2.56	8	9
RYK-2G49L/2G85L/3G41L/3G43L	20	1	51x35x35	2.21	11	12
RYK-2G49VF3(VF9)/2G85VF3(VF9)/ 3G41VF3(VF9)/3G43VF3(VF9)	20	1	51x35x35	2.21	10	11
RYK-2G49/2G85/3G41/3G43	20	1	51x35x35	2.21	9	10
RYK-2449VF3(VF9)/2485VF3(VF9)/ 3441VF3(VF9)/3443VF3(VF9)	30	1	39x26x54	1.93	11	12
RYK-2411/2485/3441/3443	30	1	39x26x54	1.93	10	11
RYK-2J49/2J85/3J41/3J43	30	1	39x26x54	1.93	21	22
RYK-2311/2385	63	1	51x35x35	2.21	13	14
RYK-3341/3343/2335/3363	63	1	51x35x35	2.21	12	13
RYK-2767/2768	50	1	44x19x45	1.33	7	8
RYK-2739/3753/3755	50	1	44x19x45	1.33	15	16
RYK-2D55A/2D56A	150	1	34x32x34	1.31	14	15
RYK-2849/2850/2847/2848	50	1	44x19x45	1.33	6	7
RYK-3841/3842/3843/3844/3863/3864	50	1	44x19x45	1.33	5	6
RYK-2512(S)/2585(S)/3542(S)/3544(S)	20	1	42x26x44	1.70	6	7
RYK-2611/2685/3641/3643	30	1	39x26x54	1.93	7	8
RYK-2C54/3C76	50	1	44x19x45	1.33	11	12
RYK-2090VF3(VR3)/2069/2070/2071/2072/2065/2066/3041/3042/3043/3044/3063/3064	150	1	32x32x33	1.19	5	6
RYK-2085/2086	150	1	32x32x33	1.19	7	8
RYK-2083/2084	150	1	32x32x33	1.19	6	7
RYK-9317/9309	2	1	51x36x54	3.50	19	20
RYK-9305	4	1	57x55x40	4.42	20	21
RYK-9324/9327/9326/9810/9811/9817/9816	4	1	57x55x40	4.42	18	19
RYK-9320/9820/9807	5	1	56x49x38	3.68	19	20
RYK-9103/9122	20	1	42x26x44	1.70	14	15
RYK-9121K	10	1	61x44x27	2.55	18	19
RYK-IP185	16	1	42x26x44	1.70	15	16
RYK-9909	32	1	50x35x52	3.21	16	17
RYK-9015/9003	10	1	47x26x35	1.51	14	15
RYK-9509/9516	6	1	44x33x49	2.51	21	22
RYK-8335	60	1	34x32x34	1.31	7	8
RYK-8337	7	1	51x35x35	2.21	13	14
RYK-8334T/8334R	20	1	49x43x22	1.64	13	14
RYKL2520/1625	400	1	42x26x44	1.70	18	19
RYKL3620A/4320A/0620A/0820A/1220A	400	1	42x26x44	1.70	12	13
RYK-8110	1	1	36x39x24	1.19	9	10
RYK-8111H	1	1	36x37x34	1.60	16	17
RYK-8112	1	1	59x56x52	6.07	24	25
RYK-8101	2	1	51x23x24	1.00	13	14
RYK-8102	1	1	39x39x40	2.15	10	11
RYK-8103	1	1	36x34x37	1.60	14	15
RYK-8104	1	1	47x45x36	2.69	20	21
RYK-8701	50	1	41x44x35	2.23	8	9
RYK-8704/8704-4	100	1	38x20x29	0.78	8	9
RYK-8708	20	1	49x44x32	2.44	11	12
RYK-8719-3	24	1	52x41x50	3.76	16	17
RYK-8501	15	1	42x42x58	3.61	20	21
RYK-8505/8505H/8505F/8505HF/8505L	12	1	45x43x49	3.35	20	21
R190001/R190002/R190003/R190004/R190005/R190006/R190009/R190050/R190051	1000	1	23x28x27	0.61	5	6
413017	500	1	47x32x26	1.91	14	15
413020	500	1	47x32x26	1.91	10	11

Free Manuals Download Website

<http://myh66.com>

<http://usermanuals.us>

<http://www.somanuals.com>

<http://www.4manuals.cc>

<http://www.manual-lib.com>

<http://www.404manual.com>

<http://www.luxmanual.com>

<http://aubethermostatmanual.com>

Golf course search by state

<http://golfingnear.com>

Email search by domain

<http://emailbydomain.com>

Auto manuals search

<http://auto.somanuals.com>

TV manuals search

<http://tv.somanuals.com>