

SAMSUNG TECHWIN



SALES NETWORK

• SAMSUNG TECHWIN CO., LTD.

145-3, Sangdaewon-dong, Jungwon-gu, Seongnam-si, Gyeonggi-do, 462-120, Korea
TEL : +82-31-740-8151-8158 FAX : +82-31-740-8145

• SAMSUNG OPTO-ELECTRONICS UK, LTD.

Samsung House, 1000 Hillswood Drive, Hillswood Business Park Chertsey, Surrey KT16 0PS
TEL : +44-1932-45-5308 FAX : +44-1932-45-5325

www.samsungtechwin.com
www.samsungcctv.com

P/No. : Z6806-0820-01C
VAN 08_03

Download from www.Somanuals.com. All Manuals Search And Download.



Break through
the **D**arkness!



High Resolution Day & Night IR Camera SIR-4150 User's Manual

Thank you for purchasing a SAMSUNG CCD CAMERA.
Before attempting to connect or operate this product,
please read these instructions carefully and save this manual for future use.

ENGLISH

Before operating the camera, confirm the camera model and proper input power voltage. In order to that you can understand this manual thoroughly, we'll introduce our model description.

■ SIR-4150 SERIES

- NTSC MODELS
SIR-4150N

- PAL MODELS
SIR-4150P

■ MODEL DESCRIPTION

- SIR-4150 X

└── SIGNAL SYSTEM

- SIGNAL SYSTEM
N --> NTSC MODEL
P --> PAL MODEL



The lightning flash with an arrowhead symbol, within an equilateral triangle is intended to alert the user to the presence of uninsulated "dangerous voltage" within the product's enclosure that may be of sufficient magnitude to constitute a risk of electric shock to persons.



The exclamation point within an equilateral triangle is intended to alert the user to the presence of important operating and maintenance (servicing) instructions in the literature accompanying the appliance.

INFORMATION - This equipment has been tested and found to comply with limits for a Class A digital device, pursuant to part 15 of the FCC Rules. These limits are designed to provide reasonable protection against harmful interference when the equipment is operated in a commercial environment. This equipment generates, uses, and can radiate radio frequency energy and, if not installed and used in accordance with the instruction manual, may cause harmful interference to radio communications.

Operation of this equipment in a residential area is likely to cause harmful interference in which case the user will be required to correct the interference at his own expense.

WARNING - Changes or modifications not expressly approved by the manufacturer could void the user's authority to operate the equipment.

CAUTION : To prevent electric shock and risk of fire hazards:

- ◆ Do NOT use power sources other than that specified.
- ◆ Do NOT expose this appliance to rain or moisture.

This installation should be made by a qualified service person and should conform to all local codes.

Contents

Features	6	Operating Your Camera	18
Warnings & cautions	7	■ Menu	18
Components and Accessories	10	■ Settings	19
Overview	11	• LENS (Adjusting to the brightness level)	21
■ Front	11	• SHUTTER (condition and speed control)	22
■ Bottom	12	• WHITE BALANCE control	22
■ Back	13	• BACKLIGHT (Backlight Compensation)	24
Adjust to lens	14	• AGC (Auto Gain Control)	25
■ Ajust to Lens's ZOOM and Focus	14	• SSNR (Samsung Super Noise Reduction)	26
Connection	15	• SENS UP (Low illuminance)	27
■ Connecting to a monitor	15	• SPECIAL	28
■ Connecting to power	16	• EXIT	34
■ RS-485 Communication control	17	Troubleshooting	35
		Specifications	36

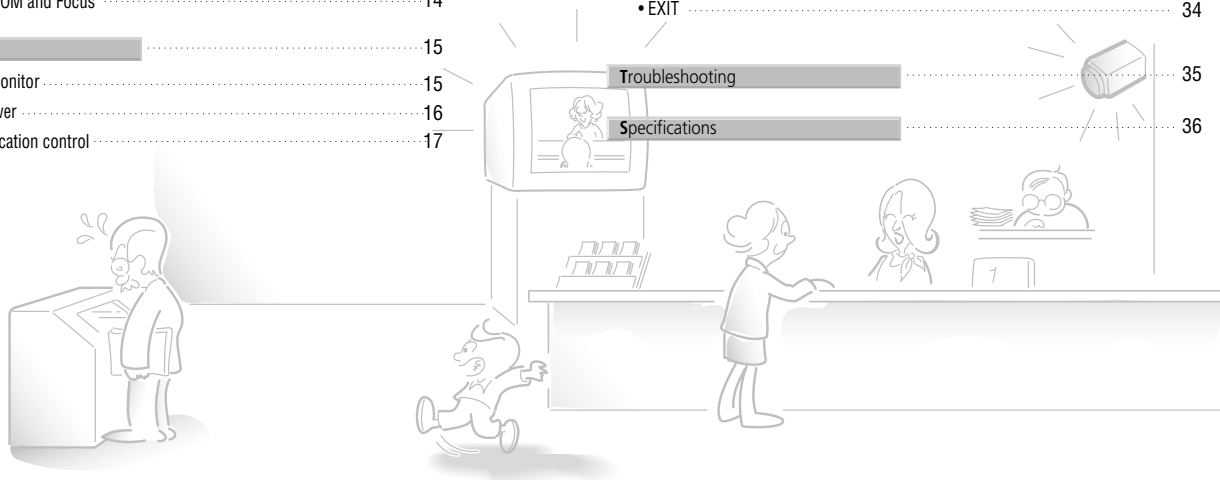

Features

Ultra High Sensitivity

The built-in high sensitivity COLOR CCD enables a clear image even in 0Lux(B/W, IR-LED ON) or lower illumination.

High Resolution

Featuring 520TV line horizontal resolution in color mode and 570TV line horizontal resolution in BW mode. The camera features Sony's 410,000 pixel CCD and capture clean, noiseless high-quality image

DAY&NIGHT(ICR)

This camera has a function that automatically selects the mode that is appropriate for daytime or night-time conditions. The COLOR mode operates in daytime conditions to provide optimum colors, and BW mode operates in night-time conditions to enhance the definition of the image.

SSNR (Samsung Super Noise Reduction)

By using built-in SSNR Chip manufactured by SAMSUNG TECHWIN, the amount of low illuminance noise has been significantly reduced, and the signal-to-noise ratio (S/N) as well as horizontal resolution have been improved, resulting in a clear and sharp image display even in the dark.

Outdoor Visibility range 30M

If B/W mode, IR-LED is lighted, 0 Luxes' Outdoor visibility range 30 M guarantees is available.

IRMODE Function

This function that prevent short distance saturation in case of IR LED is lighted, discrimination of subject does possibility within 3 M

RS-485 Function

Use RS485 communication and OSD menu control does possibility to remote.

IP65 Approved/Dust and Rain Resistant

With dust and rain resistant design, the camera can be installed outside under building eaves or places that are exposed to the dust and rain.

PRIVACY Masking Function

The PRIVACY masking function conceals the areas you do not wish to appear on the screen.

Additional Function

SENS-UP, MIRROR, SHARPNESS, MOTION DET. functions are also available.



Samsung Techwin cares for the environment at all product manufacturing stages to preserve the environment, and is taking a number of steps to provide customers with more environment-friendly products. The Eco mark represents Samsung Techwin's will to create environment-friendly products, and indicates that the product satisfies the EU RoHS Directive.

Warnings & Cautions

This information is provided to ensure your safety and to prevent any losses, financial or otherwise. Please read it carefully and use the product accordingly.

* For product inquiries, please contact the retail shop where you bought the camera. The use of equipment such as an aerial ladder while providing after-sales service shall be at your expense.

Notes

- SIR-4150 does not need special Housing because it is Housing built-in type. Please remove front glass certainly in case of installation on outdoors style Housing inside.

Warning/Attention/Special Mark Messages



Ignoring this information may result in material loss and/or serious personal injuries including death.



Indicates "Never Allowed."



Indicates "No Disassembling."



Indicates "Must Observe."



Correct Disposal of This Product (Waste Electrical & Electronic Equipment)

(Applicable in the European Union and other European countries with separate collection systems)

This marking shown on the product or its literature, indicates that it should not be disposed with other household wastes at the end of its working life. To prevent possible harm to the environment or human health from uncontrolled waste disposal, please separate this from other types of wastes and recycle it responsibly to promote the sustainable reuse of material resources.

Household users should contact either the retailer where they purchased this product, or their local government office, for details of where and how they can take this item for environmentally safe recycling.

Business users should contact their supplier and check the terms and conditions of the purchase contract. This product should not be mixed with other commercial wastes for disposal.

Precautions

Do not install under extreme temperature conditions.



Use only under temperature conditions between -10°C and $+50^{\circ}\text{C}$. Provide good ventilation when using in high temperature conditions.

Do not install in high humidity environment.



May lower image quality.

Do not drop the camera or subject it to physical shock.



May cause a product malfunction.

Never keep the camera face to strong light directly.



May damage the CCD.

Do not install under unstable lighting conditions.

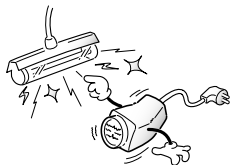

Severe lighting changes or flickering may hinder normal camera operation.

Avoid touching the camera lens.



The lens is the most important component of the camera. Be careful not to smear it with fingerprints.

Do not expose the camera to radioactivity.



Radioactivity exposure may damage the CCD.

Notes

- Exposure to a spotlight or an object emitting strong light may cause smear or blooming.
- Ensure that the power source complies with normal specifications before supplying it to the camera.
- In case of IR LED has been lighted, do not lighten directly eye.

Components and Accessories

1. High Resolution Day&Night IR Camera
SIR-4150



2. CAMERA HOOD



3. HOOD ADAPTOR(2EA)



4. USER'S MANUAL



5. DC 12V/4A ADAPTOR

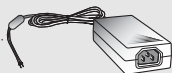

6. POWER CABLE

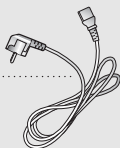

Overview

FRONT

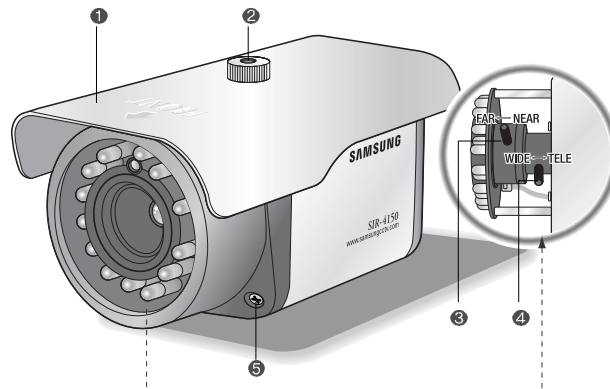

1 Hood

2 Hood adaptor

Fixing the hood onto the camera

3 Focus lever

Set focus of lens by turn the focus lever

4 Zoom lever

Set zoom magnification of lens by turn the zoom lever

5 Front cover fixing screw



Notes

- Adjust to the zoom & focus lever, and then use after fixate turning lever to clockwise.
- When you adjust to the ZOOM & FOCUS of the lens, Please loosen the Front cover fixing screw and separate Front cover from the camera.

Overview

BOTTOM

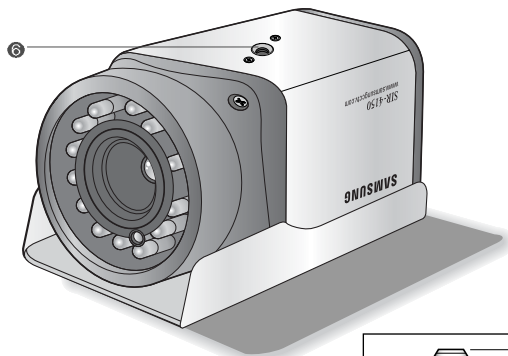

6 Mounting bracket screw hole

Please use the screw hole when fixing the camera onto the mounting bracket.
Please use the clamp screw as specified below.

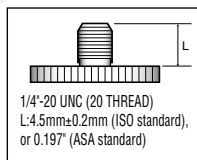

*The mounting bracket can be separated and attached to the top of the camera.

In this instance please do not tighten the screw to a depth of more than 4mm, otherwise serious damage can occur to the inside of the camera.



Note

- This camera package does not include the mounting bracket. Please refer to the user's manual for installation of the mounting bracket.

BACK

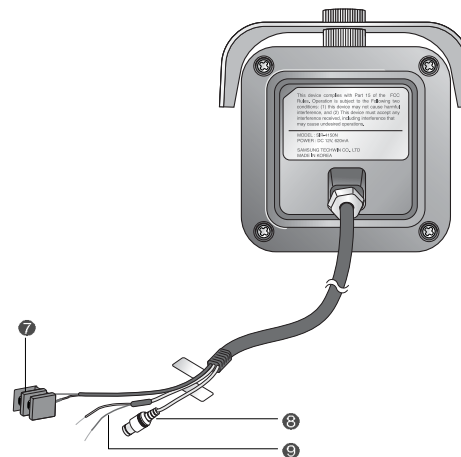

7 Power input terminal

8 Video output terminal

9 RS-485 control terminal

Adjust to Lens

Adjust to the lens's zoom and focus.

1. Please loosen a front cover fixing screw with picture and separate cover
2. Please unlock the Zoom or Focus lever to release it.
3. Adjust the zoom or focus lever by moving it to WIDE(NEAR)or TELE(FAR) position.
4. After adjustment, tighten the zoom or focus lever, taking care that the adjusted position does not change.
5. Please close cover and tighten the front cover fixing screw.

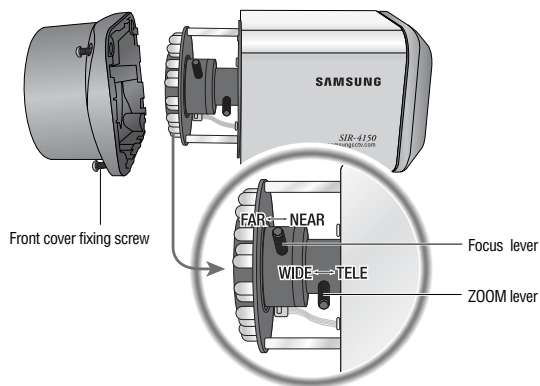

Note

- If front cover fixing screw do not pinch, it is not waterproof.

Connection

Connecting to Monitor

Please connect the video output terminal located on the back of the camera to the monitor.

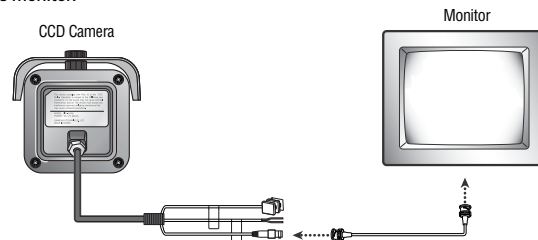

- The connection method varies depending on the type of monitor and accessories. Please refer to the user's manual for each instrument.
- Please turn off the power when connecting.
- Please select Hi-Z on the 75Ω/Hi-Z switch for the intermediate video TV set and select 75Ω for the Intermediate device as shown in the picture below.

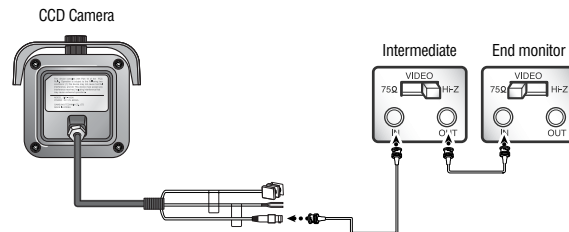

Connecting to Power

The recommended adaptor specification for SIR-4150N/P is DC 12V/4A.
Please check the standard power requirement before connecting to power.

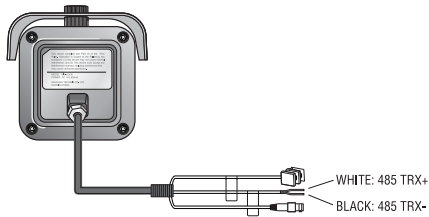

When the resistance value of copper wire is at [20°C(68°F)]

Copper wire size(AWG)	#24(0.22mm ²)	#22(0.33mm ²)	#20(0.52mm ²)	#18(0.83mm ²)
Resistance value(Ω/m)	0.078	0.050	0.030	0.018
Voltage drop(V/m)	0.028	0.018	0.011	0.006

- As shown in the table above, voltage decreases as the wire gets longer. Therefore use of an excessively long adaptor output line for connection to the camera may affect the performance of the camera.

※ Standard voltage for camera operation : DC 12V±10%

※ There may be some deviation in voltage drop depending on the type of wire and the manufacturer.



Note

- Please must be used adaptor that meets the standard requirement.
- Please connect the power after installation.

RS-485 communication control

Connecting to RS-485 CONTROL TERMINAL

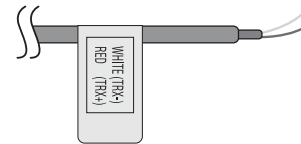

CONTROL TERMINAL	SPEC
WHITE (TRX+)	RS-485 +
BLACK (TRX-)	RS-485 -

Using a RS-485 communication, it will be able to control the OSD menu at the SAMSUNG TECHWIN System Controller or DVR.

- (1) The case which it controls from the PC

Using a RS-485 converter, It connects to RS-485 CONTROL TERMINAL outside camera and serial cable

EX) SERIAL PORT OF THE PC(COM1) — SERIAL CABLE -- RS-485 CONVERTER
-- RS-485 CONTROL TERMINAL

- (2)The case which it controls from the DVR or System Controller

It connects the RS-485 CONTROL TERMINAL in the connection terminal of 485 control boards which are connected with the DVR or System Controller.

485 CONTROL BOARD CONNECTION TERMINAL	RS-485 CONTROL TERMINAL
(+)CONNECTION TERMINAL	WHITE (TRX+)
(-)CONNECTION TERMINAL	BLACK (TRX-)



Notes

- When you construct external control systems for a camera control, please use to the PELCO-D PROTOCOL.
- When you connecting to RS-485 CONTROL TERMINAL, please peel off the outer skin inside the RS-485 CONTROL TERMINAL.

Operating Your Camera

Menu

SETUP menu			
LENS	• DC		
SHUTTER (condition and speed control)	• ----	• FLK	
WHITE BALANCE control	• ATW	• AWC	• MANUAL
BACKLIGHT (Backlight compensation)	• OFF • HIGH	• LOW	• MIDDLE
AGC (Auto Gain control)	• OFF	• NORMAL	• HIGH
SSNR (Samsung super noise reduction)	• OFF • HIGH	• LOW	• MIDDLE
SENS-UP (Low illuminance)	• OFF	• AUTO	
SPECIAL	• CAMERA ID • MOTION DET • COMM ADJ • IRMODE • RETURN	• DAYNIGHT • PRIVACY • IMAGE ADJ • RESET	
EXIT			

Settings

Settings can be made using the RS-485 communication. Please refer 14 pages (RS-485 communication control) and connect to the RS-485 control terminal (TRX+, TRX-)

1. When use SCC-3100A PELCO-D Protocol setting method

< SETUP SYSTEM MENU >

- ① PTZ selection : PTZ SETUP2 selection → 1) MODEL: PTZ ID, PELCO-D Protocol selection.
- ② CONTROLLER selection : SERIAL selection → 1. BAUD, 2. DATA, 3. STOP BIT, 4. PARITY setting

* OSD button : Display OSD menu on the monitor or there is a sub-menu which can be selected by pressing OSD button.

* JOYSTICK : It can move menu cursor by upside, downward, the left side and the right side . Joystick do Up/Down/Right/Left button functions according to 4 directions that move.

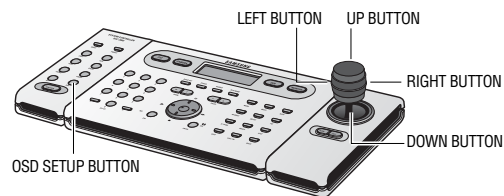

Notes

- Please set RS-485 communication setting of controller and camera equally.

Operating Your Camera

1. Please press the SETUP button.

- Settings can now be made. The SETUP menu is displayed on the monitor.

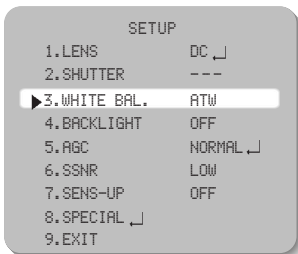

2. Please select any function you wish to activate by using the UP and DOWN buttons.

- The arrow can be moved up or down by using the UP and DOWN buttons. Please position the arrow to point to the function you wish to operate.

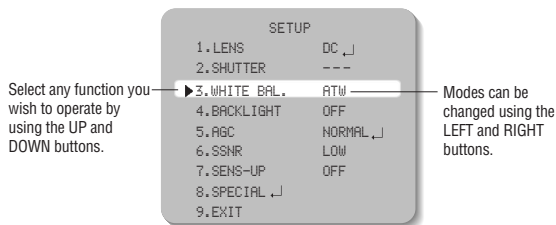

3. Please press the LEFT or RIGHT button if you wish to change mode.

- When the LEFT or RIGHT button is pressed, available values and modes are displayed in order. Please keep pressing the button until you get to the mode you wish to operate.

4. Please select 'EXIT' and then press the SETUP button to finish the setting.



Note

- If \leftarrow appears at the mode you wish to operate, it means that there is a sub-menu which can be selected by pressing the SETUP button.
- If $---$ appears at the mode item, it means that there is no mode available to be selected.

LENS (Adjusting to the brightness level)

This function is used to adjust the brightness of the screen.

1. When the SETUP menu is displayed on the screen, please position the arrow to point to 'LENS' by using the UP and DOWN buttons.
2. Using the SETUP button, you can control the brightness of the screen.

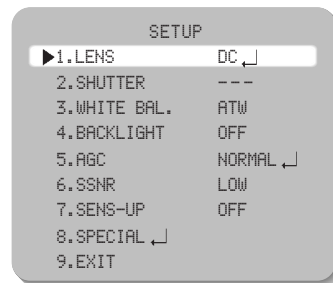

3. Please press the SETUP button if you wish to return to the previous menu.

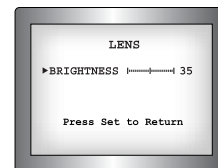

Operating Your Camera

SHUTTER (condition and speed control)

Because SIR-4150 uses built-in dc lens, shutter speed is fixed at 1/60 basically.

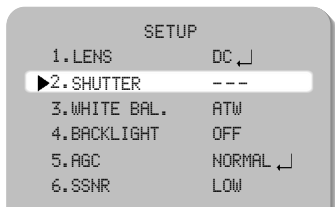

- ▶ --- : Shutter speed is fixed at 1/60(1/50)
- ▶ **FLK** : Please select 'FLK' mode when flickering occurs on the screen, due to an imbalance between illumination and frequency.
NTSC Model : 1/100, PAL MODEL : 1/120

WHITE BALANCE control

The screen color can be adjusted by using the WHITE BALANCE function.

1. Please position the arrow to point to 'WHITE BAL' on the SETUP menu by using the UP and DOWN buttons.
2. Please select the mode you wish to operate by pressing the LEFT or RIGHT button.

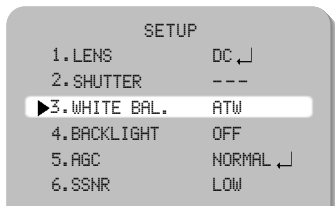

※ Please select one of the 3 modes below.

- ▶ **ATW(Auto Tracking White Balance)** : This mode can be used within the color temperature range 1,800K ~ 10,500K (Ex. fluorescent light, outdoor, sodium vapor lamp or inside tunnels)
- ▶ **AWC(Auto White Balance Control)** : Please press the SETUP button while the camera is directed at a piece of white paper to obtain the optimum state under current illumination. If the environment including the light source is changed, you have to adjust the white balance again.
- ▶ **MANUAL** : The manual adjustment mode enables finer adjustment. Please select ATW or AWC first. Please change to manual adjustment mode and press the SETUP button. Please set the appropriate color temperature, and then increase or decrease the red and blue color values while monitoring the color changes on the object.



Note

- Under the following conditions the WHITE BALANCE function may not operate properly. In such cases, please select the AWC mode.
 1. When the object's surroundings have a very high color temperature. (Ex. a clear sky and sunset)
 2. When the object's surroundings are dark.
 3. If the camera directly faces a fluorescent light or is installed in a place where there are considerable changes in illumination, the WHITE BALANCE function may become unstable.

Operating Your Camera

BACKLIGHT (Backlight Compensation)

When there is a strong backlight behind the object, clear images of the background as well as the object can still be obtained by using the BACKLIGHT function.

1. Please position the arrow to point to 'BACKLIGHT' on the SETUP menu by using the UP and DOWN buttons.
2. Please select the mode you wish to operate by pressing the LEFT or RIGHT button.

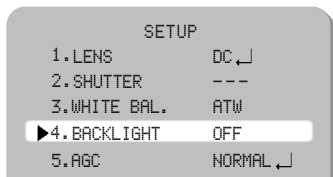

▶HIGH/MIDDLE/LOW :

You can adjust the sensitivity of BLC and BLC window's size and position. So that, it can achieve BLC function efficiently regardless of position of subject.



▶OFF : BLC function doesn't operate.



BACKLIGHT ON

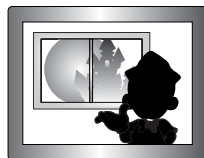

BACKLIGHT OFF



Note

- When BW mode at night-time, BLC does not operate.

AGC (Auto Gain Control)

1. Please position the arrow to point to 'AGC' on the SETUP menu by using the UP and DOWN buttons.
2. Please select the mode you wish to operate by pressing the LEFT or RIGHT button. As the level of gain increases, the screen gets brighter and the level of noise also increases.

▶HIGH : The gain increases or decreases within the range of 6dB ~ 34dB.

▶NORMAL : The gain increases or decreases within the range of 6dB ~ 30dB.

▶OFF : The gain is fixed at 6dB.

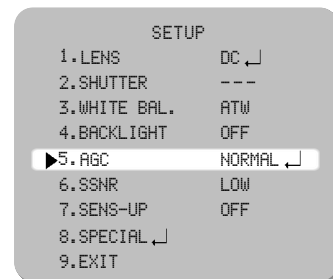

3. Please press the SETUP button. The BRIGHTNESS can be adjusted within the range of 1~70.



4. Please press the SETUP button when all the settings are complete.

Operating Your Camera

SSNR (Samsung Super Noise reduction)

The background noise in the low light level decreases automatically as the level of gain changes.

1. Please position the arrow to point to 'SSNR' on the SETUP menu by using the UP and DOWN buttons.
2. Please select the mode you wish to operate by pressing the LEFT or RIGHT button.

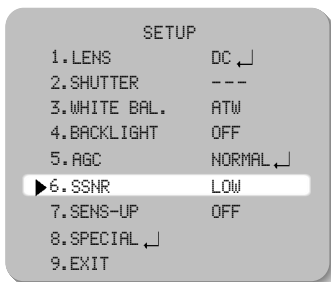

- ⊖OFF : There is no reduction in noise level.
- ⊖LOW : There is a small reduction in noise level with almost no ghost image.
- ⊖MIDDLE : The most effective mode. There is a sufficient reduction in noise levels without causing much ghost imaging.
- ⊖HIGH : The level of noise is reduced greatly, however there is an increase in ghost imaging.

Note

- When AGC is turned off, SSNR does not operate.

SENS UP (Low illuminance)

SENS UP helps maintain a bright, clear screen image by automatically detecting changes in the level of light in low light level conditions.

1. Please position the arrow to point to 'SENS UP' on the SETUP menu by using the UP and DOWN buttons.
2. Please select the mode you wish to operate by pressing the LEFT or RIGHT button.
 - ⊖AUTO : Low light level auto mode
 - ⊖OFF : The function does not operate.

Note

- When SHUTTER is in the manual mode, SENS UP does not operate.
- When AGC is turned off, SENS UP does not operate.

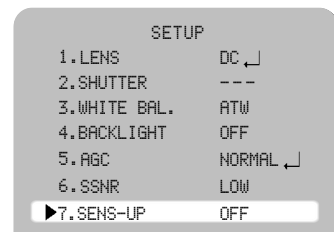

3. Please press the SETUP button when all the settings are complete.

Note

- The maximum storage magnification in low light level can be adjusted by pressing the SETUP button in 'AUTO' mode.(X2~X128)
- As the magnification increases, the screen gets brighter; moving object gets more afterimage.
- If storage magnification is increased while SENS UP is operating, it may cause noise, and spots may appear; however this is normal.

Operating Your Camera

SPECIAL

1. Please position the arrow to point to 'SPECIAL' on the SETUP menu by using the UP and DOWN buttons.
2. Please select the mode you wish to operate by pressing the UP or DOWN button.

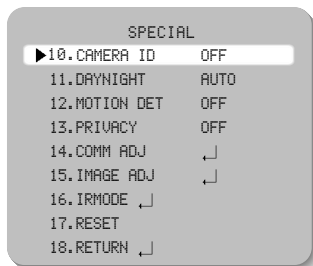

🔊 **CAMERA ID** : If the ID is input, the camera ID appears on the monitor.

- 1) Please position the arrow to point to 'CAMERA ID' by using the UP or DOWN button.
- 2) Please select 'ON' by pressing the LEFT or RIGHT button.

Note

- If 'OFF' is selected, the ID does not appear on the monitor even if it has been input.

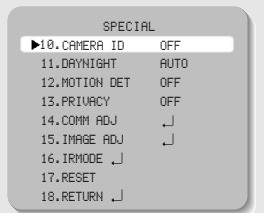

- 3) Please press the SETUP button.

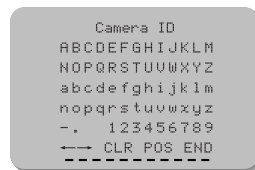

- 4) Up to 15 letters can be used for the ID.

- ① Please move the cursor to the letter you wish to choose by using the UP and DOWN button.

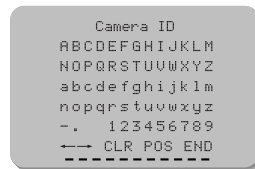

- ② Select an ID from A,B~Y,Z, a,b~y,z, 0,1~8,9 by using the UP, DOWN, LEFT and RIGHT buttons.
- ③ Please lock in the letters by using the SETUP button.
 - When the letter is locked in, the cursor moves to the next space.
- ④ Please repeat the above to input the ID.

Note

- **If the wrong name has been input....**
If you press the SETUP button after moving the cursor to CLR, all the letters will be erased. If you want to correct a letter, please move the cursor to the arrow at the bottom left of the screen and press 'SET'.
Please position the cursor above the letter you wish to correct, and then move the cursor onto the letter you wish to choose and press the SETUP button.

Operating Your Camera

5) When a name has been chosen, please select a position for the name display.

- 1) Please move the cursor onto 'POS' and then press the SETUP button.

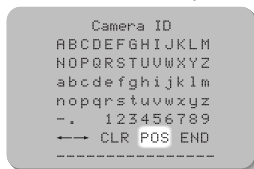

- 2) The name will appear at the top left hand corner.



- 3) Please find the position you wish to display the name by using the 4 directional buttons, and then press the SETUP button.



6) Please select 'END' and then press the SETUP button to complete ID input.

➤ **DAY&NIGHT (ICR TYPE)** : Select from COLOR, B/W or AUTO modes.

- AUTO: According to the input luminance level, IR Cut Filter is automatically switched to the appropriate mode for daytime or night-time. The COLOR mode is operated for daytime, and it converts to BW mode for night-time



- COLOR : COLOR mode
- B/W : BW mode. Please press SETUP button to turn on or off the burst signal on BW mode.



Note

- If AGC is OFF, you can't select AUTO mode and B/W mode. When DayNight mode is set to Auto under the condition which the strong IR light is flickering periodically, a malfunction of IR-Cut filter may occur.

➤ **MOTION DETECTION** :

This product has a feature that allows you to observe movements of objects in 4 different areas on the screen, and the words 'MOTION DETECTED' appear on the screen when movement is detected; hence a single individual can conduct supervision efficiently. The camera detects an object's movement by sensing disparity of outline, and level of brightness and color.

- Please press the SETUP button.
 - OFF : MOTION DETECTION mode is cancelled.
 - ON : Any motion in the selected areas is observed.
- Please select the area you wish to observe from the 3 areas in AREA SEL mode.
- Please select ON mode for the chosen area.

Operating Your Camera

- Please adjust the size of the area to be observed by using the UP, DOWN, LEFT or RIGHT button.

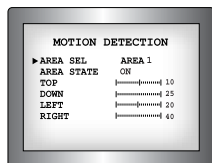

- Please press the SETUP button to save the changes and complete the setting.



Note

- There is no 'MD' output signal. 'MD' is on screen display only words.

PRIVACY : Mask privacy area you do not wish to appear on the screen.

- OFF : Cancels the PRIVACY mode.
- ON : Operates the PRIVACY mode.
- Please press the SETUP button.
- Please select the area you do not wish to appear from the 4 areas in AREA SEL mode.
- Please select ON mode for the chosen area.
- Please adjust the size of the area to be concealed by using the UP, DOWN, LEFT or RIGHT button.

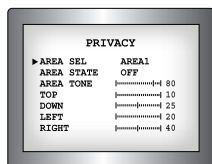

COM ADJ :

When wish to control CAMERA by external communication control device, it is function that set up CAMERA's communication states and protocol.

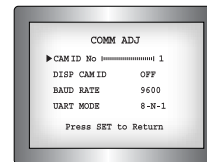

- CAM ID : Assign ID number to the camera. It is restricted available to set ID from 1~255
- DISP CAMID : Displays CAM ID on the top left of the screen.
- BAUD RATE : Configure baud rate from 9600bps, 19200bps, 38400bps, 57600bps.
- UART MODE: Configure parity bit to NONE,EVEN, or ODD. Data bit is set to 8bit and stop bit to 1bit.
- END



Note

- Please set CAM ID of CAMERA and external communication control device equally.

IMAGE ADJ : Includes image quality or special function factors.

- MIRROR : Sets a horizontal image inversionj.

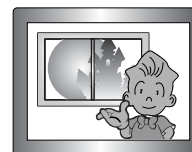

MIRROR ON

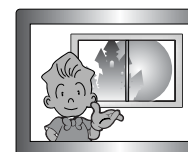

MIRROR OFF

- **SHARPNESS** : The outline of the video image becomes cleaner and more distinctive as the level of SHARPNESS increases. If the level goes up excessively, however, it may affect the video image and generate noise.

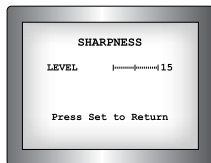

- **IRMODE** : If IR LED turned on at night, this function prevents phenomenon that screen center is saturated according to size of window that set. So the identification of the subject is possible within short distance 3M

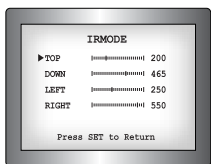

- **RESET** : Returns to the level which was set by the manufacturer for shipment.
- **RETURN** : Returns to the SETUP menu.

EXIT

Saves all the setting menus and then exits.

If there are problems in operation, please refer to the items below. If the problem persists, please contact the agent you purchased this product from.

Problem	Solution
Nothing appears on the screen.	<ul style="list-style-type: none"> • Please check the power connection. • Please check the video signal line connection.
The video image is not clear.	<ul style="list-style-type: none"> • Please check if the lens is clean. Please clean the lens with a clean cloth or brush. • Please adjust the contrast feature of the monitor. • Please make sure that the screen is not exposed directly to a bright light. Please move the camera if necessary.
The screen is dark.	<ul style="list-style-type: none"> • Please adjust the contrast feature of the monitor. • If you have an intermediate device, set the 75Ω/ Hi-z properly, and check the terminals.
There is a problem with the camera operation. The camera surface is too hot and black stripes appear on the screen.	<ul style="list-style-type: none"> • Please check if an appropriate power source to the camera complies with the manufacturer's standard requirement, or if the voltage keeps changing.
Color are not quite right	<ul style="list-style-type: none"> • Please check the 'WHITE BAL' setting
DAY&NIGHT(AUTO, B/W) mode doesn't Operate.	<ul style="list-style-type: none"> • Please check if the AGC menu is set to the OFF position.
SENS-UP function doesn't operate.	<ul style="list-style-type: none"> • Please check if the AGC menu is set to the OFF position.
IR-LED isn't lighted.	<ul style="list-style-type: none"> • Isn't DAYNIGHT function setting up the color mode? • Please change the AUTO or B/W mode.
OSD control doesn't operate.	<ul style="list-style-type: none"> • Please confirm whether communication setting method and RS485 control terminal connection fit.

Specifications

		SIR-4150N	SIR-4150P	
C C D	POWER	DC12V±10%, 460mA/ 5.5W(LED ON)		
	Sensor	1/3 inch, Sony Super HAD CCD		
	Total Pixels	811(H) x 508(V)	795(H) x 596(V)	
	Effective Pixels	768(H) x 494(V)	752(H) x 582(V)	
S Y N C	Scanning System	2:1 Interlace		
	Synchronization	Internal Fixed		
E L E C T R I C A L	Frequency	H:15.734 KHz, V :59.94 Hz	H: 15.625 KHz, V: 50.00 Hz	
	Resolution	520 Lines(Color) / 570 Lines(B/W)		
	Video Output	CVBS : 1.0Vp-p/75Ω		
	S/N (Y signal)	50 dB (AGC Off/Weight ON)		
	Min.	LED ON	0 Lux	
	Illumination	LED OFF	0.3 Lux(Color), 0.002(Sens-up) @F1.2	
	Visibility Range (IR LED ON)	Indoor - Outdoor : 30m (IR LED number: 24EA)		
	Water Resistance	IP65		
	Day & Night(ICR)	AUTO/ COLOR / B/W		
	Gain Control	NORMAL/HIGH/OFF Selectable		
	White Balance	ATW/1800°K ~ 10,500°K/AWC/Manual		
	Electronic shutter speed	1/60 Fixed / Flickerless	1/50 Fixed / Flickerless	
	Back Light Compensation	LOW/MIDDLE/HIGH/OFF Selectable		
	SSNR	LOW/MIDDLE/HIGH/OFF Selectable		
	Sens-Up	AUTO/OFF (selectable limit X2 _X128)		
	O.S.D	RS485 Control		
	Camera Title	OFF/ON (Displayed 15 characters)		
	Camera ID	255 ID Selectable		
	Motion Detection	ON/OFF (4 Programmable Zone)		
	Communication	RS-485(9600, 19200, 38400 and 57600bps is selectable) Pelco-D Protocol is available		
Mirror	ON/OFF			
Privacy	ON/OFF (4 Programmable Zone)			
Sharpness	ON/OFF (Level Adjustable)			
LENS	X2.5 Vari-Focal Lens (F1.2, f= 3.8mm ~ 9.5 mm)			
Operating Temperature/Humidity	-10°C to +50°C / 30% to 80%			
Dimension	74(W) x 74(H) x 134.5(D)mm			
Weight	585g			

DECLARATION OF CONFORMITY

Application of Council Directive(s) 89 / 336 / EEC
 Manufacturer's Name SAMSUNG TECHWIN CO., LTD
 Manufacturer's Address SAMSUNG TECHWIN CO., LTD
42, SUNGJU-DONG CHANGWON-CITY,
KYUNGNAM, KOREA, 641-120

European Representative Name _____
 European Representative Address _____
 Equipment Type/Environment CCTV Camera
 Model Name SIR-4150P

Beginning Serial NO. S7090001
 Year of Manufacture 2007. 09. 01
 Conformance to EN 50081-1:1992
EMC-Directive 89/336 EEC and 92/31/EEC
EN 50130-4:1996

We, the undersigned, hereby declare that the equipment specified above conforms to the above Directive(s).

Manufacturer	SAMSUNG TECHWIN CO., LTD	Legal Representative in Europe
Signature	<i>Han Seug Kim</i>	Signature
Full Name	HAN SEUG KIM	Full Name
Position	QUALITY CONTROL MANAGER	Position
Place	CHANGWON, KOREA	Place
Date	2007. 9. 1	Date

MEMO

A large, empty rectangular box with rounded corners, intended for writing a memo. The box is outlined in a thin grey line and is positioned on the left side of the page, below the 'MEMO' header.

Free Manuals Download Website

<http://myh66.com>

<http://usermanuals.us>

<http://www.somanuals.com>

<http://www.4manuals.cc>

<http://www.manual-lib.com>

<http://www.404manual.com>

<http://www.luxmanual.com>

<http://aubethermostatmanual.com>

Golf course search by state

<http://golfingnear.com>

Email search by domain

<http://emailbydomain.com>

Auto manuals search

<http://auto.somanuals.com>

TV manuals search

<http://tv.somanuals.com>