

Micro HI-FI Component System

Operating Instructions

Owner's Record

The model and serial numbers are located on the rear of the unit. Record these numbers in the space provided below. Refer to them whenever you call upon your Sony dealer regarding this product.

Model No. _____ Serial No. _____



S-master
Digital Amplifier



Bluetooth[™]

SIRIUS
R E A D Y



CMT-HX7BT

© 2007 Sony Corporation

WARNING

To reduce the risk of fire or electric shock, do not expose this apparatus to rain or moisture.

CAUTION

The use of optical instruments with this product will increase eye hazard.

Notice for the customers in the U.S.A.

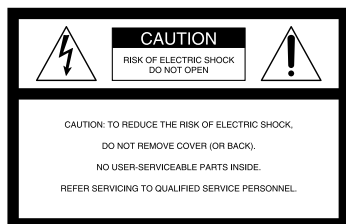

This symbol is intended to alert the user to the presence of uninsulated “dangerous voltage” within the product’s enclosure that may be of sufficient magnitude to constitute a risk of electric shock to persons.



This symbol is intended to alert the user to the presence of important operating and maintenance (servicing) instructions in the literature accompanying the appliance.

Note to CATV system installer:

This reminder is provided to call the CATV system installer’s attention to Article 820-40 of the NEC that provides guidelines for proper grounding and, in particular, specifies that the cable ground shall be connected to the grounding system of the building, as close to the point of cable entry as practical.

The following FCC statement applies only to the version of this model manufactured for sale in the U.S.A. Other versions may not comply with FCC technical regulations.

WARNING

This equipment has been tested and found to comply with the limits for a Class B digital device, pursuant to Part 15 of the FCC Rules. These limits are designed to provide reasonable protection against harmful interference in a residential installation. This equipment generates, uses and can radiate radio frequency energy and, if not installed and used in accordance with the instructions, may cause harmful interference to radio communications. However, there is no guarantee that interference will not occur in a particular installation. If this equipment does cause harmful interference to radio or television reception, which can be determined by turning the equipment off and on, the user is encouraged to try to correct the interference by one or more of the following measures:

- Reorient or relocate the receiving antenna.
- Increase the separation between the equipment and receiver.
- Connect the equipment into an outlet on a circuit different from that to which the receiver is connected.
- Consult the dealer or an experienced radio/TV technician for help.

CAUTION

You are cautioned that any changes or modifications not expressly approved in this manual could void your authority to operate this equipment.

This equipment must not be co-located or operated in conjunction with any other antenna or transmitter.

This equipment complies with FCC radiation exposure limits set forth for uncontrolled equipment and meets the FCC radio frequency (RF) Exposure Guidelines in Supplement C to OET65.

This equipment has a very low RF energy level that is deemed to comply with FCC radio frequency (RF) Exposure Guidelines in Supplement C to OET65 without maximum permissive exposure evaluation (MPE). But it is desirable that it should be installed and operated with at least 20cm and more between the radiator and person's body (excluding extremities: hands, wrists, feet and legs).

Note on DualDiscs

A DualDisc is a two sided disc product which mates DVD recorded material on one side with digital audio material on the other side. However, since the audio material side does not conform to the Compact Disc (CD) standard, playback on this product is not guaranteed.

Music discs encoded with copyright protection technologies

This product is designed to playback discs that conform to the Compact Disc (CD) standard. Recently, various music discs encoded with copyright protection technologies are marketed by some record companies. Please be aware that among those discs, there are some that do not conform to the CD standard and may not be playable by this product.

- The Bluetooth word mark and logos are owned by the Bluetooth SIG, Inc. and any use of such marks by Sony Corporation is under license. Other trademarks and trade names are those of their respective owners.
- MPEG Layer-3 audio coding technology and patents licensed from Fraunhofer IIS and Thomson.
- The XM name and related logos are registered trademarks of XM Satellite Radio Inc.
- (c) 2006 SIRIUS Satellite Radio Inc. "SIRIUS" and the SIRIUS dog logo are registered trademarks of SIRIUS Satellite Radio Inc.
- TM and [®] marks are omitted in this manual.

Table of Contents

Guide to parts and controls	5
Information on the display.....	9

Getting Started

Hooking up the system securely.....	10
Setting the clock	13

Basic Operations

Playing a CD/MP3 disc	14
Listening to the radio	15
Using the Bluetooth function.....	18
Using optional audio components.....	24
Adjusting the sound	24
Changing the display	25

Other Operations

Creating your own program (Program Play).....	26
Presetting radio stations	27
Using the Timers.....	28

Others

Troubleshooting.....	29
Messages.....	32
Precautions.....	33
Specifications	35
Bluetooth wireless technology	36
Playable Bluetooth devices	38

Guide to parts and controls

This manual mainly explains operations using the remote, but the same operations can also be performed using the buttons on the unit having the same or similar names.

Unit (HCD-HX7/Compact Disc Receiver)

Front panel

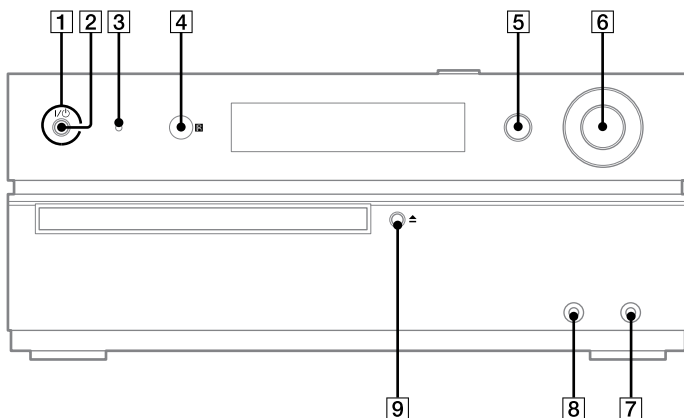

Top panel

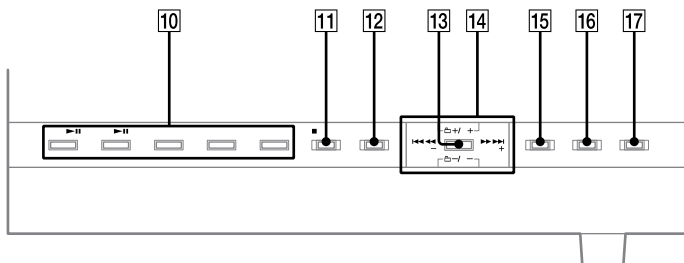

Continued

Remote (RM-SCR32)

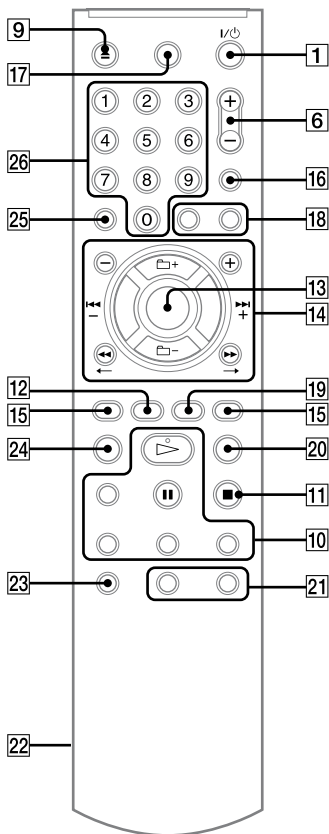

1
I/O (power) button (page 13, 28, 31)
Press to turn on the system.

2
STANDBY indicator (page 25, 29)
Lights up when the system is turned off.

3
BLUETOOTH indicator (page 22, 23)

Lights up when the Bluetooth function is active.

4
Remote sensor (page 29)

5
BLUETOOTH OPR button (page 20, 22, 23)

Press to make a connection, disconnection, or pairing with a Bluetooth device.

6
Unit: VOLUME control (page 14, 15, 16, 20, 23, 24)



Remote: VOLUME +/- button (page 14, 15, 16, 20, 23, 24)
Turn or press to adjust the volume.

7
AUDIO IN jack (page 24)

Connect to an optional audio component.

8
PHONES jack

Connect the headphones.

9
Unit:  (open/close) button (page 14)
Remote: OPEN/CLOSE  button (page 14)
Press to open or close the disc tray.

10

Playback buttons and function buttons

Unit: BLUETOOTH ►|| (play/pause) button (page 19, 20)

Press to select the Bluetooth function.
Press to start or pause playback of the music on the Bluetooth device (Bluetooth mobile phone, etc.).

Unit: CD ►|| (play/pause) button (page 14)

Press to select the CD function.
Press to start or pause playback of a disc.
Remote: CD button (page 14)
Press to select the CD function.

Remote: ► (play) button, || (pause) button

Press to start or pause playback.

TUNER/BAND button (page 15, 16)

Press to select the TUNER function.
Press to switch among FM, AM, XM and SIRIUS band.

AUDIO IN button (page 24)

Press to select the AUDIO IN function.

FUNCTION button (page 22, 23)

Press to select the function.

11

Unit: ■/CANCEL (stop/cancel) button (page 14, 15, 19, 20, 22)

Remote: ■ (stop) button (page 14, 15, 19, 20, 22)

Press to stop playback.
Press to cancel search.

12

SEARCH button (page 14)

Press to enter or exit search mode.

13

ENTER button (page 13, 16, 26, 27, 28)

Press to enter the settings.

14

◀◀/▶▶ (go back/go forward) button (page 14, 20, 26)

Press to select a track or file.

Unit: TUNE +/- (tuning) button (page 15, 16)

Remote: +/- (tuning) button (page 15, 16, 27)

Press to tune in the desired station.

📁 +/- (select folder) button (page 14, 26)

Press to select a folder.

Unit: CAT +/- (category) button (page 16)

Remote: CATEGORY +/- button (page 16)

Press to select a satellite radio category.

◀◀/▶▶ (rewind/fast forward) button (page 14, 20)

Press to find a point in a track or file.

15

PLAY MODE/TUNING MODE button (page 14, 15, 16, 26, 27)

Press to select the play mode of a CD or MP3 disc.

Press to select the tuning mode.

16

Sound buttons (page 24)

Unit: DSGX button

Remote: EQ button

Press to select the sound effect.

Continued 

17

DISPLAY button (page 20, 25)

Press to change the information on the display.

18

Satellite radio buttons

XM button (page 16)

Press to select XM band.

SIRIUS button (page 16)

Press to select SIRIUS band.

19

TUNER MEMORY button (page

27)

Press to preset the radio station.

20

FM MODE button (page 15)

Press to select the FM reception mode (monaural or stereo).

21

CLOCK/TIMER SELECT button

(page 28)

CLOCK/TIMER SET button (page

13, 28)

Press to set the clock and the Play Timer.

22

Battery compartment lid

(page 11)

23

SLEEP button (page 28)

Press to set the Sleep Timer.

24

REPEAT button (page 14)

Press to listen to a disc, a single track or file repeatedly.

25

CLEAR button (page 17, 20, 22, 26)

Press to delete a pre-programmed track or file.

Press to delete a SIRIUS Parental Lock password entry.

Press to erase the pairing registration information of the Bluetooth device.

26

Number buttons (page 14, 16, 19)

Press to select a track, file or satellite channel.

Press to enter a SIRIUS Parental Lock password.

Press to enter a Bluetooth passcode.

Information on the display

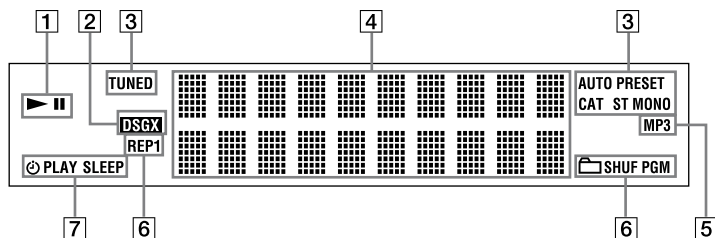

1

Play/Pause

5

Audio format

2

DSGX (page 24)

6

Play mode (page 14)

3

Tuner reception mode (page 15)

7

Timer (page 28)

Tuner reception (page 15)

4

Text information

Getting Started

Hooking up the system securely

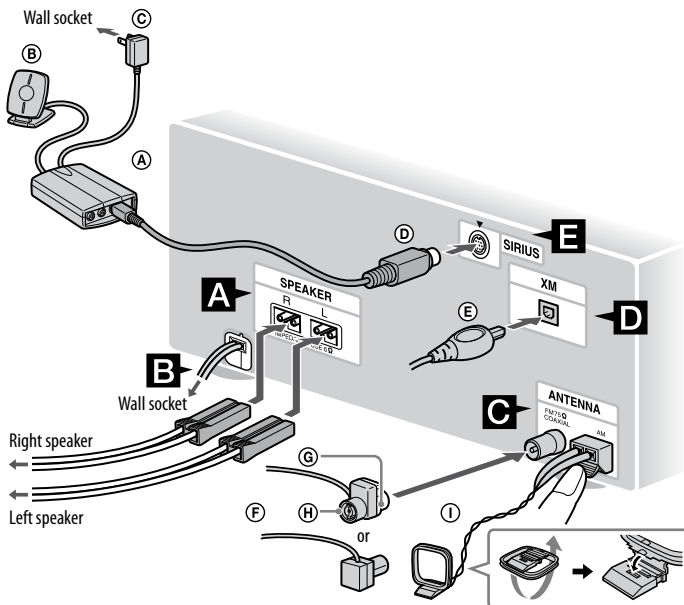

- (A) SiriusConnect Home tuner (not supplied)
 - (B) Satellite Radio Home Antenna (not supplied)*
 - (C) AC power adaptor (not supplied)*
 - (D) DIN cable (not supplied)*
 - (E) XM Mini-Tuner and Home Dock (not supplied)
 - (F) FM lead antenna (Extend it horizontally.)
 - (G) White side for North American model
 - (H) Brown side for other regions
 - (I) AM loop antenna
- * Supplied with SiriusConnect Home tuner

A Speakers

B Power

Connect the power cord to a wall socket. If the plug does not fit the wall socket, detach the supplied plug adaptor (only for models equipped with an adaptor).

C FM/AM antennas

Find a location and an orientation that provide good reception, and then set up the antenna. Keep the antennas away from the speaker cords and the power cord to avoid picking up noise.

D XM antenna

Connect the XM Mini-Tuner and Home Dock. For details, see “To receive the XM Satellite Radio” (page 12).

E SIRIUS Tuner

Connect the SiriusConnect Home tuner. When you use the SiriusConnect Home tuner with this system, be sure to connect the AC power adaptor supplied with the tuner to a wall socket. For details, see “To receive the SIRIUS Satellite Radio” (page 12).

Keep the SiriusConnect Home tuner, antenna, and AC power adaptor away from the speaker cords and the power cord to avoid picking up noise.

When carrying this system

- 1 Remove a disc to protect the CD mechanism.
- 2 Press CD **10** to select the CD function.
- 3 Hold down SEARCH **12** on the unit, and press I/⏻ **1** on the unit until “STANDBY” appears.
- 4 After “LOCK” appears, unplug the power cord.

Speaker pads

Attach the supplied speaker pads to the bottom of the speakers to prevent slipping.

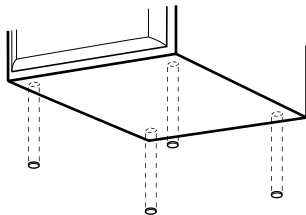

To use the remote

Slide and remove the battery compartment lid **22**, and insert the two supplied R6 (size AA) batteries, **+** side first, matching the polarities shown below.

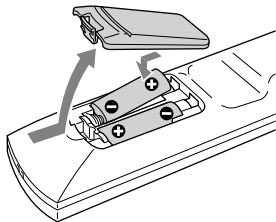

Notes

- With normal use, the batteries should last for about six months.
- Do not mix an old battery with a new one or mix different types of batteries.
- If you do not use the remote for a long period of time, remove the batteries to avoid damage from battery leakage and corrosion.

Continued 

To receive the XM Satellite Radio

ABOUT XM SATELLITE RADIO

XM offers over 170 digital radio channels: the most commercial-free music channels, premier news, sports, talk, and traffic and weather in 21 metro markets. XM's on-air hosts broadcast live from studios in Washington, D.C., New York City and Nashville.

For more information or to subscribe in the US, visit xmradio.com or call Listener Care at 1-800-XMRADIO (1-800-967-2346).

XM READY® LEGAL

XM monthly service subscription sold separately. XM Mini-Tuner and Home Dock required (each sold separately) to receive XM service. Installation costs and other fees and taxes, including a one-time activation fee may apply. Subscription fee is consumer only. All fees and programming subject to change. Channels with frequent explicit language are indicated with an XL. Channel blocking is available for XM radio receivers by calling 1-800-XMRADIO (1-800-967-2346). For a full listing of the XM commercial-free channels and advertising supported channels, visit lineup.xmradio.com. Subscriptions subject to Customer Agreement available at xmradio.com. XM service only available in the 48 contiguous United States. XM Satellite Radio and XM Ready are trademarks of XM Satellite Radio Inc. (C)2006 XM Satellite Radio Inc. All rights reserved.

XM READY® SUBSCRIPTIONS

Once you have installed the XM Mini-Tuner Dock, inserted the XM Mini-Tuner, connected the XM Dock to your XM Ready® home audio system, and installed the antenna, you are ready to subscribe and begin receiving XM programming. There are three places to find your eight character XM Radio ID: on the XM Mini-Tuner, on the XM Mini-Tuner package, and on XM Channel 0. Record the Radio ID in the following eight squares for reference.

□	□	□	□	□	□	□	□
---	---	---	---	---	---	---	---

Note: The XM Radio ID does not use the letters "I", "O", "S" or "F". Activate your XM Satellite Radio service in the U.S. online at <http://activate.xmradio.com> or call 1-800-XMRADIO (1-800-967-2346). You will need a major credit card. XM will send a signal from the satellites to activate the full channel lineup.

Activation normally takes 10 to 15 minutes, but during peak busy periods you may need to keep your XM Ready home audio system on for up to an hour. When you can access the full channel lineup on your XM Ready home audio system you are done.

To receive the SIRIUS Satellite Radio

SIRIUS Satellite Radio: The Best Radio On Radio

SIRIUS brings all your favorite entertainment including 100% commercial-free music, plus superior sports coverage, uncensored talk and comedy, world-class entertainment, news, weather and more for your car, home or office.

Sirius is available in the US for subscribers with addresses in the continental US and is available in Canada for subscribers with a Canadian address. Required subscription plus compatible SiriusConnect Home Tuner with antenna are required and sold separately. SIRIUS Programming is subject to change. Visit sirius.com or siriuscanada.ca for the most complete and up-to-date channel lineup and product information. "SIRIUS" and the SIRIUS dog logo and related marks are trademarks of Sirius Satellite Radio Inc. All rights reserved.

To Subscribe to SIRIUS Satellite Radio

Purchase and connect a SiriusConnect Home Tuner to your Sirius Ready home audio system. You are then ready to activate and subscribe to Sirius by either calling 1.888.539.SIRIUS (7474) or log on to sirius.com. It is that easy.

Setting the clock

Use buttons on the remote to set the clock.

- 1 Press I/⏻ [1] to turn on the system.
- 2 Press CLOCK/TIMER SET [21].
If the current mode appears on the display, press I◀◀/▶▶I [14] repeatedly to select "CLOCK SET?" and then press ENTER [13].
- 3 Press I◀◀/▶▶I [14] repeatedly to set the hour, and then press ENTER [13].
- 4 Use the same procedure to set the minutes.
The clock settings are lost when you disconnect the power cord or if a power failure occurs.

To display the clock when the system is off

Press DISPLAY [17]. The clock is displayed for about 8 seconds.

Basic Operations

Playing a CD/MP3 disc

- 1 Select the CD function.
Press CD [10].
- 2 Place a disc.
Press OPEN/CLOSE ▲ [9], and place a disc with the label side up on the disc tray.

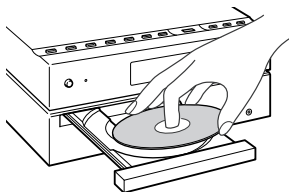

To close the disc tray, press OPEN/CLOSE ▲ [9] again.
Do not force the disc tray closed with your finger, as this may damage the unit.

- 3 Start playback.
Press ► (or CD ►|| on the unit) [10].
- 4 Adjust the volume.
Press VOLUME +/- (or turn the VOLUME control on the unit) [6].

Other operation

To	Press
Pause playback	(or CD ► on the unit) [10]. To resume play, press the button again.
Stop playback	■ [11].
Select a folder on an MP3 disc	📁 +/- [14].
Select a track or file	◀◀/▶▶ [14] (or the number buttons [26], then press ENTER [13]).
Select a folder and file on an MP3 disc while viewing folder and file names on the display	SEARCH [12]. Press ◀◀/▶▶ [14] to select the desired folder, then press ENTER [13]. Press ◀◀/▶▶ [14] to select the desired file, then press ENTER [13].
Find a point in a track or file	Hold down ◀◀/▶▶ [14] during playback, and release the button at the desired point.
Select Repeat Play	REPEAT [24] repeatedly until "REP" or "REP1" appears.

To change the play mode

Press PLAY MODE [15] repeatedly while the player is stopped. You can select normal play ("📁*" for all MP3 files in the folder on the disc), shuffle play ("SHUF" or "📁 SHUF*"), or program play ("PGM").

* When playing a CD-DA disc, 📁 (SHUF) Play performs the same operation as normal (shuffle) play.

Notes on Repeat Play

- All tracks or files on a disc are played repeatedly up to five times.
- "REP1" indicates that a single track or file is repeated until you stop it.

Notes on playing MP3 discs

- Do not save other types of files or unnecessary folders on a disc that has MP3 files.
- Folders that have no MP3 files are skipped.
- MP3 files are played back in the order that they are recorded onto the disc.
- The system can only play MP3 files that have a file extension of “.MP3”.
- If there are files on the disc that have the “.MP3” file extension, but that are not MP3 files, the unit may produce noise or may malfunction.
- The maximum number of:
 - folders is 255 (including the root folder).
 - MP3 files is 511.
 - MP3 files and folders that can be contained on a single disc is 512.
 - folder levels (the tree structure of files) is 8.
- Compatibility with all MP3 encoding/writing software, recording device, and recording media cannot be guaranteed. Incompatible MP3 discs may produce noise or interrupted audio or may not play at all.

Notes on playing multisession discs

- If the disc begins with a CD-DA (or MP3) session, it is recognized as a CD-DA (or MP3) disc, and other sessions are not played back.
- A disc with a mixed CD format is recognized as a CD-DA (audio) disc.

Listening to the radio

Listening to FM or AM

- 1 Select “FM” or “AM.”
Press TUNER/BAND **[10]** repeatedly.
- 2 Select the tuning mode.
Press TUNING MODE **[15]** repeatedly until “AUTO” appears.
- 3 Tune in the desired station.
Press +/- (or TUNE +/- on the unit) **[14]**. Scanning stops automatically when a station is tuned in, and then “TUNED” and “ST” (for stereo programs only) appear.

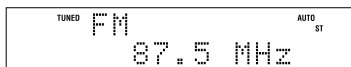

- 4 Adjust the volume.
Press VOLUME +/- (or turn the VOLUME control on the unit) **[6]**.

To stop automatic scanning

Press **[11]**.

To tune in a station with a weak signal

If “TUNED” does not appear and the scanning does not stop, press TUNING MODE **[15]** repeatedly until “AUTO” and “PRESET” disappear, and then press +/- (or TUNE +/- on the unit) **[14]** repeatedly to tune in the desired station.

To reduce static noise on a weak FM stereo station

Press FM MODE **[20]** repeatedly until “MONO” appears to turn off stereo reception.

Continued

Listening to satellite radio

You can operate and listen to XM or SIRIUS satellite radio by connecting an optional antenna or tuner. Before using the system, connect the XM Mini-Tuner and Home Dock or the SiriusConnect Home tuner to the system. See “Hooking up the system securely” (page 10) for details about connection.

- 1** Select “XM” or “SIRIUS.”
Press XM or SIRIUS **[18]** (or TUNER/BAND **[10]** repeatedly).
- 2** Select the All Channel mode.
Press TUNING MODE **[15]** repeatedly until “CAT” and “PRESET” disappear.
- 3** Tune in the desired channel.
Press +/- (or TUNE +/- on the unit) **[14]** repeatedly.
- 4** Adjust the volume.
Press VOLUME +/- (or turn the VOLUME control on the unit) **[6]**.

To select a channel by Category mode

- 1** Press XM or SIRIUS **[18]** (or TUNER/BAND **[10]** repeatedly).
- 2** Press TUNING MODE **[15]** repeatedly until “CAT” appears.
- 3** Press CATEGORY +/- (or CAT +/- on the unit) **[14]** repeatedly.
- 4** Press +/- (or TUNE +/- on the unit) **[14]** repeatedly.

To select a channel using the number buttons

Enter the 3 digits of the desired channel using the number buttons **[26]**, then press ENTER **[13]**.

To check your XM Radio ID or SIRIUS ID number

Press the number button 0 **[26]**, then press ENTER **[13]** to select channel 0.

Notes

- If you select a channel using the number buttons **[26]** in Category mode, the tuning mode changes automatically to All Channel mode.
- You cannot select a SIRIUS channel using +/- (or TUNE +/- on the unit) **[14]** if the Parental Lock is set for the channel.

Restricting access to specific channels (SIRIUS only)

— Parental Lock

You can restrict access to certain channels using your own password. The password is set to “0000” as the default. Change the password before you use this function for the first time (see “To change the password”).

- 1** Select “SIRIUS.”
Press SIRIUS **[18]** (or TUNER/BAND **[10]** repeatedly).
- 2** Tune in the desired channel (see “Listening to satellite radio”).
- 3** Press TUNER MEMORY **[19]** repeatedly until “Lock?” appears, then press ENTER **[13]**.
“Enter Code” appears.
- 4** Enter your 4-digit password using the number buttons **[26]**.
“Complete!” appears and the Parental Lock is set.

To delete the numbers you have entered

Press CLEAR **[25]** repeatedly.

To change the password

- 1 Press SIRIUS **[18]** (or TUNER/BAND **[10]** repeatedly) to select "SIRIUS."
- 2 Press TUNER MEMORY **[19]** repeatedly until "Edit Code?" appears, then press ENTER **[13]**.
"OLD Code" appears.
- 3 Enter your current 4-digit password using the number buttons **[26]**.
"NEW Code" appears.
- 4 Enter a new 4-digit password using the number buttons **[26]**.
- 5 To confirm your new password, re-enter it using the number buttons **[26]**.
"Complete!" appears and the new password is set.

To listen to the locked channels

- 1 Press SIRIUS **[18]** (or TUNER/BAND **[10]** repeatedly) to select "SIRIUS."
- 2 Select a locked channel you want to listen to using the number buttons **[26]**.
"Enter Code" appears.
- 3 Enter your 4-digit password using the number buttons **[26]**.
The channel is tuned in.

To remove the Parental Lock

- 1 When the locked channel is tuned in, press TUNER MEMORY **[19]** repeatedly until "Unlock?" appears.
- 2 Press ENTER **[13]**.
"Complete!" appears and the channel is unlocked.

Notes

- When you select a channel using +/- (or TUNE +/- on the unit) **[14]** in All Channel mode or Category mode, locked channels are skipped.
- The display will return to the original indication if you press **[11]** or if no entry is made for a set period of time after you have been prompted to enter the password.
- When the system is reset to the factory settings, the Parental Lock password returns to the default ("0000"), but Parental Lock settings are not removed.
- You cannot preset locked channels.
- If you set the Parental Lock for a preset channel, the preset information for that channel returns to the default.
- You cannot set the Parental Lock for channels 0 or 184.

Using the Bluetooth function

This system supports Bluetooth A2DP and AVRCP profiles. For details on Bluetooth wireless technology, see “Bluetooth wireless technology” (page 36).

Check the websites below for the latest information about compatible devices.

For customers in the U.S.A.:

<<http://www.sony.com/shelfsupport>>

For customers in Canada:

English <<http://www.sony.ca/ElectronicsSupport/>>

French <<http://fr.sony.ca/ElectronicsSupport/>>

For customers in Europe:

<<http://sonydigital-link.com/dna>>

For customers in Latin America:

<<http://www.sony-latin.com/pa/info>>

For customers in Asia and Oceania:

<<http://www.css.ap.sony.com/>>

Listening to music of a Bluetooth mobile phone or Bluetooth device

You can listen to music from your Bluetooth mobile phone or Bluetooth device over a wireless connection.

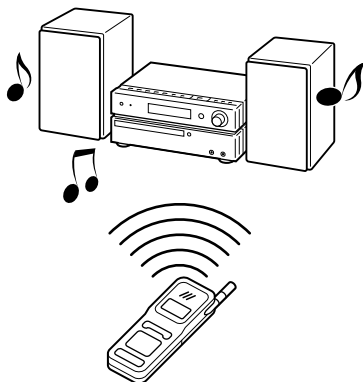

Follow the procedure below to listen to music from Bluetooth devices with this system.

Pairing this system with a Bluetooth device



Connecting to registered devices



Playing music of a Bluetooth device

For details about the operations of the Bluetooth device, also refer to the operation manual supplied with your Bluetooth device.

Pairing this system with a Bluetooth device

Pairing is an operation where Bluetooth devices register with each other beforehand. Use the procedure below to pair the system with your Bluetooth device. Once a pairing operation is performed, it does not need to be performed again. If pairing is already completed, proceed to “Playing music of a Bluetooth device” (page 20).

- 1 Place the Bluetooth device to be connected to this system within 1 meter of the system.
- 2 Select the Bluetooth function.
Press **BLUETOOTH**  **[10]** on the unit.
- 3 Operate the Bluetooth device and perform the pairing operation.

For details about the operations of the Bluetooth device, refer to the operation manual supplied with your Bluetooth device.

When searching for this system with the Bluetooth device, a list of the devices found may appear in the Bluetooth device display depending on the type of Bluetooth device. This system appears as “CMT-HX7BT.”

When establishing a connection with this system, select the audio profile (A2DP, AVRCP) at the Bluetooth device. If the Bluetooth device does not support the AVRCP profile, you cannot perform playback or other operations with the system (page 20).

4 Enter the passcode.

Passcode entry may be required depending on the type of Bluetooth device.

When “PIN?” and a countdown appear, enter the passcode at the system as follows:



Press the number buttons **[26]** (or **[+/-]** and **[<<]/>>]** **[14]** on the unit to enter the same passcode that was entered at the Bluetooth device, and then press **ENTER** **[13]**.

Once pairing is completed and the connection is established, the system display changes as follows:
“Connect” → Name of the Bluetooth device

To cancel passcode entry partway

Press **[11]**.

Notes

- “Passcode” may be called “Passkey,” “PIN code,” “PIN number” or “Password,” etc. depending on the device.
- This system only supports numerical passcodes up to 4 digits.
- The pairing standby status of the system is cancelled after about 30 seconds. If pairing is not successful, redo the procedure from step 1.
- While connected to a Bluetooth device, this system cannot be detected and a connection cannot be established from another Bluetooth device.

Continued 

To erase all the pairing registration information

- 1 Press **BLUETOOTH** [10] on the unit.
When the system is connected with a Bluetooth device (when the Bluetooth device name or other information appears in the system display), press and hold **BLUETOOTH OPR** [5] on the unit for about 2 seconds to put the system in Bluetooth standby mode.
- 2 Press **CLEAR** [25].
“Delete?” appears.
- 3 Press **ENTER** [13].
“Complete!” appears and all the pairing information is erased.

Note

In order to connect with a Bluetooth device after performing this operation, you must enter the passcode again.

Playing music of a Bluetooth device

You can operate a Bluetooth device by connecting the system and a Bluetooth device using AVRCP. If the system is not connected with a Bluetooth device using AVRCP, “Not in Use” appears when you operate the system.

- 1 Select the Bluetooth function.
Press **BLUETOOTH** [10] on the unit.
- 2 Establish a connection from the Bluetooth device.
For details about the operations of the Bluetooth device, refer to the operation manual supplied with your Bluetooth device.
Once the connection is established, the system display changes as follows: “Connect” → Name of the Bluetooth device

- 3 Start playback.
Press (or **BLUETOOTH** on the unit) [10].
Depending on the Bluetooth device, you may need to start up the AV software of the Bluetooth device beforehand.

- 4 Adjust the volume.
Press **VOLUME +/-** (or turn the **VOLUME** control on the unit) [6].

To check the address of a connected Bluetooth device

Press **DISPLAY** [17] while the Bluetooth device name appears in the system display.
The Bluetooth device address appears for 8 seconds.

To cancel the connection with a Bluetooth device

Press and hold **BLUETOOTH OPR** [5] on the unit for about 2 seconds until “Disconnect” appears, or until the information on the display (device name, etc.) disappears.

Other operation

To	Press
Pause playback	(or BLUETOOTH on the unit) [10].
Stop playback	[11].
Select a file	[14].
Find a point in a file	Hold down [14].

Note

These operations may not be available for certain Bluetooth devices. In addition, the actual operations may differ depending on the connected Bluetooth device.

Notes on connections with Bluetooth devices

- If you cannot connect with a paired Bluetooth device, perform the pairing operation between the system and the Bluetooth device again.
- Depending on the type of Bluetooth device, you can adjust the volume using the controls of the Bluetooth device.
- When BLUETOOTH ►|| 10 on the unit is pressed while connected to Bluetooth headphones, it may take some time until a connection is made to the system from another Bluetooth device.

Listening to music on this system using Bluetooth headphones

You can listen to music played on this system using your Bluetooth headphones over a wireless connection.

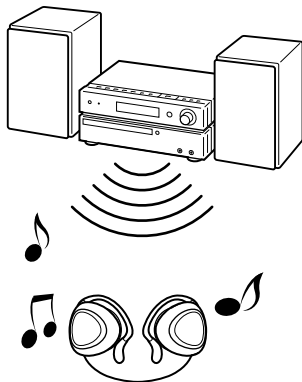

Follow the procedure below to listen to music on this system with Bluetooth headphones.

Pairing this system with Bluetooth headphones



Connecting to registered headphones



Playing music on this system

For details about the operations of the Bluetooth headphones, also refer to the operation manual supplied with your Bluetooth headphones.

Continued 

Pairing this system with Bluetooth headphones

Pairing is an operation where Bluetooth devices register with each other beforehand. Use the procedure below to pair the system with your Bluetooth headphones. Once a pairing operation is performed, it does not need to be performed again. If pairing is already completed, proceed to “Playing music on this system” (page 23).

1 Select a function other than the Bluetooth function.

Press FUNCTION **[10]** repeatedly.

2 Place the Bluetooth headphones to be connected to this system within 1 meter of the system.

3 Put the Bluetooth headphones in pairing mode.

For details about the operations of the Bluetooth headphones, refer to the operation manual supplied with your Bluetooth headphones.

4 Press and hold BLUETOOTH OPR **[5]** on the unit for about 7 seconds until the BLUETOOTH indicator **[3]** flashes.

Sound output from the speakers is stopped.

5 Enter the passcode.

Follow the same procedure as in step 4 of “Pairing this system with a Bluetooth device” (page 19).

Once pairing is completed and the connection is established, the system display changes as follows:
“Connect” → Name of the Bluetooth device

To cancel passcode entry partway

Press **[11]**.

Notes

- “Passcode” may be called “Passkey,” “PIN code,” “PIN number” or “Password,” etc. depending on the device.
- This system only supports numerical passcodes up to 4 digits.
- The pairing standby status of the system is cancelled after about 30 seconds. If pairing is not successful, redo the procedure from step 1.
- While connected to a Bluetooth device, this system cannot be detected and a connection cannot be established from another Bluetooth device.
- Pairing may not be possible if other Bluetooth devices are present around the system. In this case, turn off the other Bluetooth devices.

To erase all the pairing registration information

1 Press BLUETOOTH **[10]** on the unit.

When the system is connected with a Bluetooth device (when the Bluetooth device name or other information appears in the system display), press and hold BLUETOOTH OPR **[5]** on the unit for about 2 seconds to put the system in Bluetooth standby mode.

2 Press CLEAR **[25]**. “Delete?” appears.

3 Press ENTER **[13]**. “Complete!” appears and all the pairing information is erased.

Note

To connect with Bluetooth headphones after performing this operation, you must enter the passcode again.

Playing music on this system

You can operate this system with Bluetooth headphones by connecting the system and Bluetooth headphones using AVRCP.

1 Select a function other than the Bluetooth function.

Press FUNCTION [10] repeatedly.

2 Establish a connection with the Bluetooth headphones.

Press and hold BLUETOOTH OPR [5] on the unit for about 2 seconds until the BLUETOOTH indicator [3] lights up, then release the button.

If more than one Bluetooth device that has been connected in the past is present around the system, the system attempts to connect with up to 3 most recently connected devices. (Connection is attempted with up to 3 devices in order from the most recently connected device, and the attempts end when a connection is established.)

Once the connection is established, the system display changes as follows: "Connect" → Name of the Bluetooth device

3 Start playback of the music for the function selected in step 1.

Depending on the type of Bluetooth headphones, you can operate this system (playback, volume control, etc.) using the headphone's controls.

For details about the operations of the Bluetooth headphones, refer to the operation manual supplied with your Bluetooth headphones.

4 Adjust the volume.

Press VOLUME +/- (or turn the VOLUME control on the unit) [6].

To cancel the connection with Bluetooth headphones

Press and hold BLUETOOTH OPR [5] on the unit for about 2 seconds until the BLUETOOTH indicator [3] turns off.

Notes

- If you cannot connect with paired Bluetooth headphones, perform the pairing operation between the system and the Bluetooth headphones again.
- When the system is changed to a function other than the Bluetooth function and BLUETOOTH OPR [5] on the unit is pressed while connected to a Bluetooth device, it may take some time until a connection is made with the Bluetooth headphones.
- This system stores separate volume settings for when listening through the speakers or PHONES jack [8] on the unit, or when listening through Bluetooth headphones.

Using optional audio components

- 1 Connect additional audio component to the AUDIO IN jack [7] on the unit using an audio analog cord (not supplied).
- 2 Turn down the volume.
Press VOLUME – (or turn the VOLUME control on the unit) [6].
- 3 Select the AUDIO IN function.
Press AUDIO IN [10].
- 4 Start playing the connected component.
- 5 Adjust the volume.
Press VOLUME +/- (or turn the VOLUME control on the unit) [6].

Adjusting the sound

To add a sound effect

To	Press
Generate a more dynamic sound (Dynamic Sound Generator X-tra)	DSGX [16] on the unit.
Set the sound effect	EQ [16] repeatedly to select “BASS” or “TREBLE,” and then press +/- [14] repeatedly to adjust the level.

Changing the display

To	Press
Change information on the display ¹⁾²⁾	DISPLAY [17] repeatedly when the system is on.
Check the clock when the system is off	DISPLAY [17] when the system is off ³⁾ . The clock is displayed for 8 seconds.

- ¹⁾ For example, you can view CD/MP3 disc information, such as the track or file number or folder name during normal play, or the total playing time while the player is stopped. You can also view XM or SIRIUS radio information, such as the channel name, song title and artist name.
- ²⁾ When the system and a Bluetooth device are connected using the Bluetooth function, you can view the Bluetooth device address.
- ³⁾ The STANDBY indicator [2] on the unit lights up when the system is off.

Notes on the display information

- Characters that cannot be displayed appear as “_”.
- The following are not displayed:
 - total playing time for a CD-DA disc depending on the play mode.
 - total playing time and remaining playing time for an MP3 disc.
- The following are not displayed correctly:
 - folder and file names that do not follow either the ISO9660 Level 1, Level 2 or Joliet in the expansion format.
- The following is displayed:
 - ID3 tag information for MP3 files when ID3 version 1 and version 2 tags are used (up to 62 characters).

Other Operations

Creating your own program

(Program Play)

- 1 Press CD **[10]** to select the CD function.
- 2 Press PLAY MODE **[15]** repeatedly until "PGM" appears while the system is stopped.
- 3 Press **◀◀/▶▶** **[14]** repeatedly until the desired track or file number appears.

When programming files, press **📁 +/-** **[14]** repeatedly to select the desired folder, and then select the desired file.

Example: When programming tracks on a CD



Selected track or file number

Total playing time of program (including selected track or file)

- 4 Press ENTER **[13]** to add the track or file to the program.

"- . -" appears when the total program time exceeds 100 minutes for a CD, or when you select a CD track whose number is 21 or over, or when you select an MP3 file.

- 5 Repeat steps 3 through 4 to program additional tracks or files, up to a total of 25 tracks or files.

- 6 To play your program of tracks or files, press **▶** **[10]**.

The program remains available until you open the disc tray. To play the same program again, press **▶** **[10]**.

To cancel Program Play

Press PLAY MODE **[15]** repeatedly until "PGM" disappears while the system is stopped.

To delete the last track or file of the program

Press CLEAR **[25]** while the system is stopped.

Presetting radio stations

You can preset your favorite radio stations and tune them in instantly by selecting the corresponding preset number.

Use buttons on the remote to preset stations.

1 Tune in the desired station (see “Listening to the radio” (page 15)).

2 Press TUNER MEMORY [19].

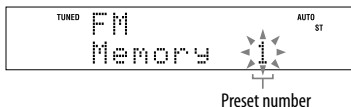

3 Press +/- [14] repeatedly to select your desired preset number.

If another station is already assigned to the selected preset number, the station is replaced by the new stations.

4 Press ENTER [13].

5 Repeat steps 1 through 4 to store other stations.

You can preset up to 20 FM, 10 AM, 20 XM and 20 SIRIUS stations. The preset stations are retained for about half a day even if you disconnect the power cord or if a power failure occurs.

6 To call up a preset radio station, press TUNING MODE [15] repeatedly until “PRESET” appears, and then press +/- [14] repeatedly to select the desired preset number.

Notes on presetting XM or SIRIUS stations

- You cannot preset XM or SIRIUS stations except when you receive the station.
- You cannot operate CATEGORY +/- (or CAT +/- on the unit) [14] in preset tuning mode.
- If you select a channel using the number buttons [26] in preset tuning mode, the tuning mode changes automatically to All Channel mode.

Using the Timers

The system offers two timer functions. If you use the Play Timer with the Sleep Timer, the Sleep Timer has priority.

Sleep Timer:

You can fall asleep to music. This function works even if the clock is not set.

Press SLEEP [23] repeatedly.

If you select "AUTO," the system automatically turns off after the current disc stops or in 100 minutes.

Play Timer:

You can wake up to CD or tuner at a preset time. Use buttons on the remote to control the Play Timer. Make sure you have set the clock.

1 Prepare the sound source.

Prepare the sound source, and then press VOLUME +/- [6] to adjust the volume.

To start from a specific track or file, create your own program (page 26).

2 Press CLOCK/TIMER SET [21].

3 Press [14] repeatedly to select "PLAY SET?," and then press ENTER [13].

"ON TIME" appears, and the hour indication flashes.

4 Set the time to start playing.

Press [14] repeatedly to set the hour, and then press ENTER [13]. The minute indication flashes. Use the procedure above to set the minutes.

5 Use the same procedure as in step 4 to set the time to stop playing.

6 Select the sound source.

Press [14] repeatedly until the desired sound source appears, and then press ENTER [13]. The display shows the timer settings.

7 Press I/⏻ [1] to turn off the system.

The system turns on 15 seconds before the preset time. If the system is on at the preset time, the Play Timer will not play.

Note

Before the system is turned off, if a connection is made with the Bluetooth headphones, sounds played by the Play Timer may be output to the Bluetooth headphones.

To activate or check the timer again

Press CLOCK/TIMER SELECT [21], press [14] repeatedly until "PLAY SEL?" appears, and then press ENTER [13].

To cancel the timer

Repeat the same procedure as above until "TIMER OFF?" appears, and then press ENTER [13].

To change the setting

Start over from step 1.

Tip

The Play Timer setting remains as long as the setting is not canceled manually.

Troubleshooting

- 1 Make sure the power cord and speaker cords are correctly and firmly connected.
- 2 Find your problem in the checklist below, and take the indicated corrective action.
If the issue persists, contact your nearest Sony dealer.

If the STANDBY indicator flashes

Immediately unplug the power cord, and check the following items.

- If your system has a voltage selector, is the voltage selector set to the correct voltage?
- Are you using only the supplied speakers?
- Is anything blocking the ventilation holes on the top or back of the system?

After the STANDBY indicator **2** stops flashing, reconnect the power cord, and turn on the system. If the issue persists, contact your nearest Sony dealer.

General

Sound comes from one channel, or the left and right volumes are unbalanced.

- Place the speakers as symmetrically as possible.
- Connect only the supplied speakers.

Severe hum or noise.

- Move the system away from sources of noise.
- Connect the system to a different wall socket.
- Install a noise filter (available separately) to the power cord.

There is no sound.

- If the BLUETOOTH indicator **3** is lit or flashing when a function other than the Bluetooth function is selected, no sound is heard through the speakers or PHONES jack **8**. Press and hold BLUETOOTH OPR **5** for about 2 seconds until the BLUETOOTH indicator **3** turns off.

The remote does not function.

- Remove any obstacles between the remote and the remote sensor **4** on the unit, and position the unit away from fluorescent lights.
- Point the remote at the system's sensor.
- Move the remote closer to the system.

The STANDBY indicator **2** remains lit after unplugging the power cord.

- The STANDBY indicator **2** may not turn off immediately after unplugging the power cord. This is not a malfunction. The indicator will turn off after about 40 seconds.

CD/MP3 player

The sound skips, or the disc will not play.

- Wipe the disc clean, and replace it.
- Move the system to a location away from vibration (for example, on top of a stable stand).
- Move the speakers away from the system, or place them on separate stands. At high volume, speaker vibration may cause the sound to skip.

Continued 

Play does not start from the first track.

- Press PLAY MODE [15] repeatedly until both “PGM” and “SHUF” disappear to return to normal play.

Starting playback takes more time than usual.

- The following discs take a longer time to start playback.
 - a disc recorded with a complicated tree structure.
 - a disc recorded in multisession mode.
 - a disc that has not been finalized (a disc to which data can be added).
 - a disc that has many folders.

Bluetooth device

Pairing cannot be done.

- Move the Bluetooth device closer to the system.
- Pairing may not be possible if other Bluetooth devices are present around the system. In this case, turn off the other Bluetooth devices.

Connection is not possible.

- The Bluetooth device you attempted to connect does not support the A2DP and AVRCP profiles, and cannot be connected with the system.
- Enable the Bluetooth function of the Bluetooth device.
- The pairing registration information has been erased. Perform the pairing operation again.
- While connected to a Bluetooth device, this system cannot be detected and a connection cannot be established from another Bluetooth device.

The sound skips or fluctuates, or the connection is lost.

- The system and the Bluetooth device are too far apart.
- If there are obstacles between the system and your Bluetooth device, remove or avoid the obstacles.
- If there is equipment that generates electromagnetic radiation, such as a wireless LAN, other Bluetooth device, or a microwave oven nearby, move them away.

The sound of your Bluetooth device cannot be heard on this system.

- Turn up the volume on your Bluetooth device first, and then adjust the volume using VOLUME +/- [6].

Severe hum or noise

- If there are obstacles between the system and your Bluetooth device, remove or avoid the obstacles.
- If there is equipment that generates electromagnetic radiation, such as a wireless LAN, other Bluetooth device, or a microwave oven nearby, move them away.
- Turn down the volume of the connected Bluetooth device.

The sound from the Bluetooth headphones is distorted.

- Turn down the volume of the system using VOLUME - [6]. If your headphones have a volume control, also adjust the volume using the headphone's volume control.
- Press DSGX [16] on the unit repeatedly until “DSGX OFF” appears.
- Press EQ [16] repeatedly to select “BASS” or “TREBLE,” and then press - [14] repeatedly to turn down the level.

Tuner

Severe hum or noise, or stations cannot be received. ("TUNED" or "ST" flashes on the display.)

- Connect the antenna properly.
- Find a location and an orientation that provide good reception, and then set up the antenna again.
- Keep the antennas, SiriusConnect Home tuner, and AC adaptor away from the speaker cords and the power cord to avoid picking up noise.
- Connect a commercially available external antenna.
- Consult your nearest Sony dealer if the supplied AM antenna has come off the plastic stand.
- Turn off nearby electrical equipment.

The system cannot receive satellite channels at all.

- Check that the XM Mini-Tuner and Home Dock or the SiriusConnect Home tuner are connected properly.
- The receiving condition is not good. Move the antenna to the place where the condition is good.
- Check that you subscribed to the desired satellite radio service (see page 12).

To change the AM tuning interval

The AM tuning interval is factory-preset to 9 kHz (or 10 kHz, for some areas). Use buttons on the unit to change the AM tuning interval.

- 1 Tune in any AM station, and then turn off the system.
- 2 While holding down TUNER/BAND **[10]**, press I/⏻ **[1]**.
All the AM preset stations are erased. To reset the interval to the factory preset, repeat the procedure.

To improve tuner reception

Turn off CD player power by using the CD power management function. By default, CD power is turned on.

- 1 Press FUNCTION **[10]** repeatedly to select the CD function, and then turn off the system.
- 2 After "STANDBY" stops flashing, press I/⏻ **[1]** on the unit while holding down ■/CANCEL **[11]** on the unit. "CD POWER OFF" appears. With CD player power turned off, disc access time is increased. To turn on CD player power, repeat the procedure until "CD POWER ON" appears.

To reset the system to factory settings

If the system still does not operate properly, reset the system to factory settings.

Use buttons on the unit to reset the system to its factory default settings.

- 1 Disconnect and reconnect the power cord, and then turn on the system.
- 2 Press ■/CANCEL **[11]**, DSGX **[16]** and I/⏻ **[1]** at the same time.
All user-configured settings, such as preset radio stations, SIRIUS Parental Lock password, timer, and the clock, are deleted.

Messages

CD/MP3 player, Tuner

Complete! The preset operation ended normally.

Invalid: You pressed an invalid button.

LOCKED: The disc tray does not open. Contact your nearest Sony dealer.

No Disc: There is no disc in the system, or you have loaded a disc that cannot be played.

No Step: All of the programmed tracks or files have been erased.

Over: You have reached the end of the disc while pressing ►► [14] during playback or pause.

Push SELECT! You tried to set the clock or timer during timer operation.

Push STOP! You pressed PLAY MODE [15] during playback.

Reading: The system is reading information of the disc. Some buttons are not available.

SET CLOCK! You tried to select the timer when the clock is not set.

SET TIMER! You tried to select the timer when the Play Timer is not set.

Step Full! You tried to program more than 26 tracks or files (steps).

TIME NG! The Play Timer start and end times are set to the same time.

XM

ANTENNA: The XM Mini-Tuner and Home Dock are not connected. Check all the connections, and then turn the system on again.

CH -- --: You have entered an invalid channel number. The channel to be tuned-in is void due to the change by the broadcast service, or the receiving condition is not good.

LOADING: The system have not finished receiving the entire audio data or text information. Some buttons are not available.

NO SIGNAL: The receiving condition is not good. Try moving the antenna to another location. Make sure the antenna points south. For details about the antenna location, see the instructions supplied with the XM Mini-Tuner and Home Dock.

OFF AIR: The channel is not broadcasted now.

UPDATING: You have not subscribed for XM or the channel is not authorized. You need to subscribe for XM.

-- -- -- --: There is no text information or time information in the channel. This is not an error. The text information may not be displayed depending on the system condition, for example, right after the system has received a channel.

SIRIUS

ANTENNA: The antenna is not connected properly. Check the connection between the SiriusConnect Home tuner and the antenna.

Acquiring: The receiving condition is not good. Try moving the antenna to another location. For details about the antenna location, see the instructions supplied with the SiriusConnect Home tuner.

Call 888-539-SIRI: You have not subscribed for the selected channel.

CHK SIRIUS: The SiriusConnect Home tuner is not connected properly. Check all the connections, and then turn the system on again. Also make sure if the AC adaptor supplied with the SiriusConnect Home tuner is connected to a wall socket.

Invalid: You have entered an invalid channel number. The channel to be tuned-in is void due to the change by the broadcast service, or the receiving condition is not good.

SUB UPDT: You have not subscribed for SIRIUS or the channel is not authorized. You need to subscribe for SIRIUS.

UPDATING: Channel information or SiriusConnect Home tuner firmware is being updated.

-----: There is no text information or time information in the channel. This is not an error. The text information may not be displayed depending on the system condition, for example, right after the system has received a channel.

Bluetooth device

Connect: Bluetooth communication was established.

Disconnect: Communication with a Bluetooth device was cut off for some reason, or Bluetooth communication was ended.

No Device: A pairable Bluetooth device was not found, or connection was not possible.

Not in Use: The system is not connected with a Bluetooth device using AVRCP.

PIN?: The system is asking for the passcode. For details, see "Using the Bluetooth function" (page 18).

Please Wait: The system is readying for usage of a Bluetooth device.

Precautions

Discs that this system CAN play

- Audio CD
- CD-R/CD-RW (audio data/MP3 files)

Discs that this system CANNOT play

- CD-ROM
- CD-R/CD-RW other than those recorded in music CD format or MP3 format conforming to ISO9660 Level 1/Level 2, Joliet or multisession
- CD-R/CD-RW recorded in multisession that have not ended by "closing the session"
- CD-R/CD-RW of poor recording quality, CD-R/CD-RW that have scratches or are dirty, or CD-R/CD-RW recorded with an incompatible recording device
- CD-R/CD-RW which is finalized incorrectly
- Discs containing files other than MPEG 1 Audio Layer-3 (MP3) files
- Discs of non-standard shape (for example, heart, square, star)
- Discs that have adhesive tape, paper, or sticker attached to them
- Rental or used discs with attached seals where the glue extends beyond the seal
- Discs that have labels printed using ink that feels tacky when touched

Notes on discs

- Before playing, wipe the disc with a cleaning cloth from the center out to the edge.
- Do not clean discs with solvents, such as benzine thinner, or commercially available cleaners or anti-static spray intended for vinyl LPs.
- Do not expose discs to direct sunlight or heat sources such as hot air ducts, nor leave it in a car parked in direct sunlight.

Continued 

On safety

- Completely disconnect the power cord (mains lead) from the wall socket (mains) if it is not going to be used for an extended period of time. When unplugging the unit, always grip the plug. Never pull the cord itself.
- Should any solid object or liquid get into the system, unplug the system, and have it checked by qualified personnel before operating it again.
- The AC power cord can be changed only by a qualified service facility.

On placement

- Do not place the system in an inclined position or in locations that are extremely hot, cold, dusty, dirty, or humid or lacking adequate ventilation, or subject to vibration, direct sunlight or a bright light.
- Be careful when placing the unit or speakers on surfaces that have been specially treated (for example, with wax, oil, polish) as staining or discoloration of the surface may result.
- If the system is brought directly from a cold to a warm location or is placed in a very damp room, moisture may condense on the lens inside the CD player, and cause the system to malfunction. In this situation, remove the disc, and leave the system turned on for about an hour until the moisture evaporates.

On heat buildup

- Heat buildup on the unit during operation is normal and is not cause for alarm.
- Do not touch the cabinet if it has been used continuously at a high volume because the cabinet may have become hot.
- Do not obstruct the ventilation holes.

On the speaker system

This speaker system is not magnetically shielded, and the picture on nearby TV sets may become magnetically distorted. In this situation, turn off the TV, wait 15 to 30 minutes, and turn it back on. If there is no improvement, move the speakers far away from the TV.

Cleaning the cabinet

Clean this system with a soft cloth slightly moistened with a mild detergent solution. Do not use any type of abrasive pad, scouring powder, or solvent, such as thinner, benzene, or alcohol.

Specifications

Main unit (HCD-HX7/Compact Disc Receiver)

AUDIO POWER SPECIFICATIONS
POWER OUTPUT AND TOTAL HARMONIC DISTORTION:

(The United States model only)

With 6 ohm loads, both channels driven, from 120 — 10,000 Hz; rated 50 watts per channel minimum RMS power, with no more than 10% total harmonic distortion from 250 milliwatts to rated output.

Amplifier section

Continuous RMS power output (reference): 50 + 50 watts (6 ohms at 1 kHz, 10% THD)

Inputs:

AUDIO IN (stereo mini jack): voltage 250 mV, impedance 47 kilohms

Outputs:

PHONES (stereo mini jack): accepts headphones of 8 ohms or more
SPEAKER: accepts impedance of 6 ohms

Bluetooth section

Communication system:

Bluetooth Standard version 2.0

Output:

Bluetooth Standard Power Class 2

Maximum communication range:

Line of sight approx. 10 m¹⁾

Frequency band:

2.4 GHz band (2.4000 GHz — 2.4835 GHz)

Modulation method:

FHSS

Compatible Bluetooth profiles²⁾:

A2DP (Advanced Audio Distribution Profile)

AVRCP (Audio Video Remote Control Profile)

Supported codecs:

Receive: SBC (Sub Band Codec), MP3
Transmit: SBC (Sub Band Codec)

- ¹⁾ The actual range will vary depending on factors such as obstacles between devices, magnetic fields around a microwave oven, static electricity, reception sensitivity, antenna's performance, operating system, software application, etc.
- ²⁾ Bluetooth standard profiles indicate the purpose of Bluetooth communication between devices.

CD player section

System: Compact disc and digital audio system

Laser Diode Properties

Emission duration: continuous

Laser Output*: Less than 44.6μW

* This output is the value measurement at a distance of 200mm from the objective lens surface on the Optical Pick-up Block with 7mm aperture.

Frequency response: 20 Hz — 20 kHz

Signal-to-noise ratio: More than 90 dB

Dynamic range: More than 90 dB

Tuner section

FM stereo, FM/AM superheterodyne tuner

FM tuner section:

Tuning range: 87.5 — 108.0 MHz (100 kHz step)

Antenna: FM lead antenna

Antenna terminals: 75 ohms unbalanced

Intermediate frequency: 10.7 MHz

AM tuner section:

Tuning range:

530 — 1,710 kHz (with 10 kHz tuning interval)

531 — 1,710 kHz (with 9 kHz tuning interval)

Antenna: AM loop antenna, external antenna terminal

Intermediate frequency: 450 kHz

Speaker (SS-CHX7)

Speaker system: 2-way, 2-unit, bass-reflex type

Speaker units: Woofer 12 cm, cone type, Tweeter 4 cm, cone type

Nominal impedance: 6 ohms

Dimensions (w/h/d): Approx. 145 × 260 × 200 mm

Mass: Approx. 2.2 kg net per speaker

Continued 

General

Power requirements: 120 V AC, 60 Hz

Power consumption: 40 watts

Dimensions (w/h/d) (excl. speakers):

Approx. 285 × 120 × 215 mm

Mass (excl. speakers): 2.6 kg

Supplied accessories: Remote Commander (RM-SCR32) (1), R6 (Size AA) batteries (2), AM loop antenna (1), FM lead antenna (1), Speaker pads (8)

Design and specifications are subject to change without notice.



- Standby power consumption: 0.5 W
- Halogenated flame retardants are not used in the certain printed wiring boards.

Bluetooth wireless technology

Bluetooth wireless technology is a short-range wireless technology linking digital devices, such as personal computers and digital still cameras. Using the Bluetooth wireless technology, you can operate the units involved within a range of about 10 meters.

The Bluetooth wireless technology is commonly used between two devices, but a single device can be connected to multiple devices.

You do not need wires to get connected as you do with a USB connection, and you do not need to place the devices face to face as you do with wireless infrared technology. You can use the technology with one Bluetooth device in your bag or pocket.

Bluetooth wireless technology is a global standard supported by thousands of companies. These companies produce products that meet the global standard.

Supported Bluetooth version and profiles

Profile refers to a standard set of capabilities for various Bluetooth product capabilities. This system supports the following Bluetooth version and profiles.

Supported Bluetooth version:

Bluetooth Standard version 2.0

Supported Bluetooth profiles:

A2DP (Advanced Audio Distribution Profile)

AVRCP (Audio Video Remote Control Profile)

Effective communication range

Bluetooth devices should be used within approximately 10 meters (unobstructed distance) of each other. The effective communication range may become shorter under the following conditions.

- When a person, metal object, wall or other obstruction is between the devices with a Bluetooth connection
- Locations where a wireless LAN is installed
- Around microwave ovens that are in use
- Locations where other electromagnetic waves occur

Effects of other devices

Bluetooth devices and wireless LAN (IEEE 802.11b/g) use the same frequency band (2.4 GHz). When using your Bluetooth device near a device with wireless LAN capability, electromagnetic interference may occur. This could result in lower data transfer rates, noise, or inability to connect. If this happens, try the following remedies:

- Try connecting this system and Bluetooth mobile phone or Bluetooth device when you are at least 10 meters away from the wireless LAN equipment.
- Turn off the power to the wireless LAN equipment when using your Bluetooth device within 10 meters.

Effects on other devices

The radio waves broadcast by this system may interfere with the operation of some medical devices. Since this interference may result in malfunction, always turn off the power on this system, Bluetooth mobile phone and Bluetooth device in the following locations:

- In hospitals, on trains, in airplanes, at gas stations, and any place where flammable gasses may be present
- Near automatic doors or fire alarms

Notes

- This system supports security functions that comply with the Bluetooth specification as a means of ensuring security during communication using Bluetooth technology. However, this security may be insufficient depending on the setting contents and other factors, so always be careful when performing communication using Bluetooth technology.
- Sony cannot be held liable in any way for damages or other loss resulting from information leaks during communication using Bluetooth technology.
- Bluetooth communication is not necessarily guaranteed with all Bluetooth devices that have the same profile as this system.
- Bluetooth devices connected with this system must comply with the Bluetooth specification prescribed by the Bluetooth SIG, Inc., and must be certified to comply. However, even when a device complies with the Bluetooth specification, there may be cases where the characteristics or specifications of the Bluetooth device make it impossible to connect, or may result in different control methods, display or operation.
- Noise may occur or the audio may cut off depending on the Bluetooth device connected with this system, the communications environment, or surrounding conditions.

Playable Bluetooth devices

You can check the websites below for the Bluetooth compatible devices.

For customers in the U.S.A.:

<<http://www.sony.com/shelfsupport>>

For customers in Canada:

English <<http://www.sony.ca/ElectronicsSupport/>>

French <<http://fr.sony.ca/ElectronicsSupport/>>

For customers in Europe:

<<http://sonydigital-link.com/dna>>

For customers in Latin America:

<<http://www.sony-latin.com/pa/info>>

For customers in Asia and Oceania:

<<http://www.css.ap.sony.com/>>

Free Manuals Download Website

<http://myh66.com>

<http://usermanuals.us>

<http://www.somanuals.com>

<http://www.4manuals.cc>

<http://www.manual-lib.com>

<http://www.404manual.com>

<http://www.luxmanual.com>

<http://aubethermostatmanual.com>

Golf course search by state

<http://golfingnear.com>

Email search by domain

<http://emailbydomain.com>

Auto manuals search

<http://auto.somanuals.com>

TV manuals search

<http://tv.somanuals.com>