

SONY®

4-128-304-11(2)

Mini HI-FI Component System

Operating Instructions

LBT-ZX99i

LBT-ZX66i



©2009 Sony Corporation

Download from www.somanuals.com. All Manuals Search And Download.

WARNING

To reduce the risk of fire or electric shock, do not expose this apparatus to rain or moisture.

To reduce the risk of fire, do not cover the ventilation opening of the apparatus with newspapers, tablecloths, curtains, etc.

Do not place the naked flame sources such as lighted candles on the apparatus.

To reduce the risk of fire or electric shock, do not expose this apparatus to dripping or splashing, and do not place objects filled with liquids, such as vases, on the apparatus.

Do not expose batteries or apparatus with battery-installed to excessive heat such as sunshine, fire or the like.

Do not install the appliance in a confined space, such as a bookcase or built-in cabinet.

As the main plug is used to disconnect the unit from the mains, connect the unit to an easily accessible AC outlet. Should you notice an abnormality in the unit, disconnect the main plug from the AC outlet immediately.

Excessive sound pressure from earphones and headphones can cause hearing loss.

The unit is not disconnected from the AC power source (mains) as long as it is connected to the wall socket, even if the unit itself has been turned off.

CAUTION

The use of optical instruments with this product will increase eye hazard.

For customer in the United States

Owner's Record

The model and serial numbers are located on the rear of the unit. Record these numbers in the space provided below. Refer to them whenever you call upon your Sony dealer regarding this product.

Model No. _____ Serial No. _____



This symbol is intended to alert the user to the presence of uninsulated "dangerous voltage" within the product's enclosure that may be of sufficient magnitude to constitute a risk of electric shock to persons.



This symbol is intended to alert the user to the presence of important operating and maintenance (servicing) instructions in the literature accompanying the appliance.

The following FCC statement applies only to the version of this model manufactured for sale in the U.S.A. Other versions may not comply with FCC technical regulations.

NOTE

This equipment has been tested and found to comply with the limits for a Class B digital device, pursuant to Part 15 of the FCC Rules. These limits are designed to provide reasonable protection against harmful interference in a residential installation. This equipment generates, uses, and can radiate radio frequency energy and, if not installed and used in accordance with the instructions, may cause harmful interference to radio communications. However, there is no guarantee that interference will not occur in a particular installation.

If this equipment does cause harmful interference to radio or television reception, which can be determined by turning the equipment off and on, the user is encouraged to try to correct the interference by one or more of the following measures:

- Reorient or relocate the receiving antenna.
- Increase the separation between the equipment and receiver.
- Connect the equipment into an outlet on a circuit different from that to which the receiver is connected.
- Consult the dealer or an experienced radio/TV technician for help.

CAUTION

You are cautioned that any changes or modification not expressly approved in this manual could void your authority to operate this equipment.

Important Safety Instructions

- 1) Read these instructions.
- 2) Keep these instructions.
- 3) Heed all warnings.
- 4) Follow all instructions.
- 5) Do not use this apparatus near water.
- 6) Clean only with dry cloth.
- 7) Do not block any ventilation openings. Install in accordance with the manufacturer's instructions.

- 8) Do not install near any heat sources such as radiators, heat registers, stoves, or other apparatus (including amplifiers) that produce heat.
- 9) Do not defeat the safety purpose of the polarized or grounding-type plug. A polarized plug has two blades with one wider than the other. A grounding type plug has two blades and a third grounding prong. The wide blade or the third prong are provided for your safety. If the provided plug does not fit into your outlet, consult an electrician for replacement of the obsolete outlet.
- 10) Protect the power cord from being walked on or pinched particularly at plugs, convenience receptacles, and the point where they exit from the apparatus.
- 11) Only use attachments/accessories specified by the manufacturer.
- 12) Use only with the cart, stand, tripod, bracket, or table specified by the manufacturer, or sold with the apparatus. When a cart is used, use caution when moving the cart/apparatus combination to avoid injury from tip-over.



- 13) Unplug this apparatus during lightning storms or when unused for long periods of time.
- 14) Refer all servicing to qualified service personnel. Servicing is required when the apparatus has been damaged in any way, such as power-supply cord or plug is damaged, liquid has been spilled or objects have fallen into the apparatus, the apparatus has been exposed to rain or moisture, does not operate normally, or has been dropped.

Continued 

Note on DualDiscs

A DualDisc is a two sided disc product which mates DVD recorded material on one side with digital audio material on the other side. However, since the audio material side does not conform to the Compact Disc (CD) standard, playback on this product is not guaranteed.

Music discs encoded with copyright protection technologies

This product is designed to play back discs that conform to the Compact Disc (CD) standard. Recently, various music discs encoded with copyright protection technologies are marketed by some record companies. Please be aware that among those discs, there are some that do not conform to the CD standard and may not be playable by this product.

Note on Multi Session disc

When you play back Multi Session discs with different formats for each session, the format of the first session is recognized as the disc type. Tracks in the second and subsequent sessions are played back if they are the same formats as the first session.

MPEG Layer-3 audio coding technology and patents licensed from Fraunhofer IIS and Thomson.

iPod is a trademark of Apple Inc., registered in the U.S. and other countries.

About this manual

The instructions in this manual are for models LBT-ZX99i and LBT-ZX66i. In this manual, the LBT-ZX99i is used for illustration purposes unless stated otherwise.

The LBT-ZX99i consists of:

- Unit HCD-ZX99i
- Speaker System
 - Front speakers SS-ZX99i
 - Surround speakers SS-ZX99i

The LBT-ZX66i consists of:

- Unit HCD-ZX66i
- Speaker System
 - Front speakers SS-ZX66i

Table of Contents

About this manual	4
Guide to parts and controls	6

Getting Started

Hooking up the system.....	11
Positioning the speakers.....	15
Setting the clock.....	16

Basic Operations

Playing a CD/MP3 disc.....	17
Listening to the radio	19
Playing the iPod	20
Using optional components.....	22
Adjusting the sound	22
Creating a party atmosphere	23
(LBT-ZX99i only)	
Selecting the speaker setting	25
(LBT-ZX99i only)	
Enhancing the video game sound	25
— Game Sync	
Mixing video game sound with other sound source	26
— Game Mixing	
Changing the display.....	26
Viewing information in the display	28

Other Operations

Creating your own program	29
— Program Play	
Presetting radio stations	30
Creating your own sound effect.....	31
Singing along	32
Using the timer	32

Additional Information

Troubleshooting	34
Messages	37
Precautions	38
Specifications	39
Compatible iPod models with this system.....	42
Index.....	43

Guide to parts and controls

This manual mainly explains operations using the buttons on the unit, but the same operations can also be performed using the buttons on the remote having the same or similar names.

Unit

- Front view

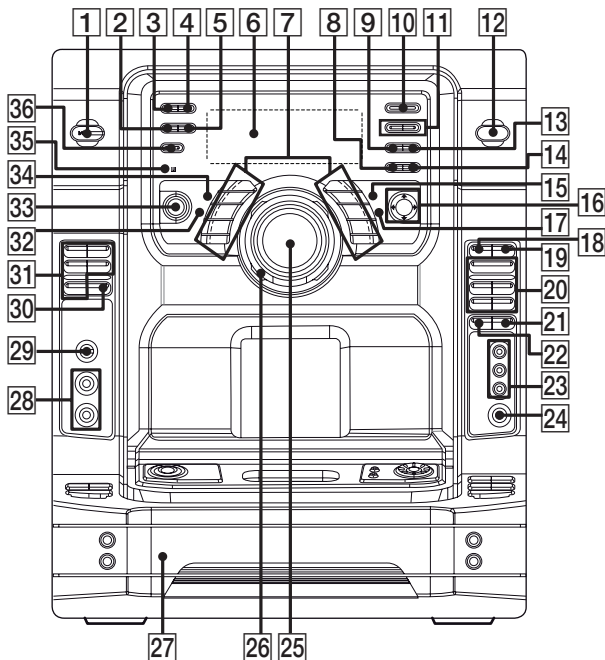

- Top view

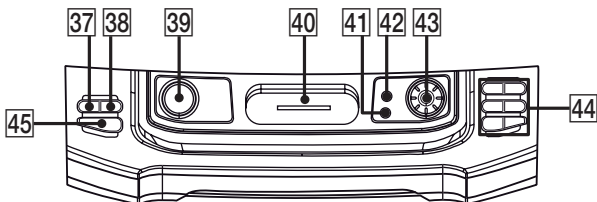

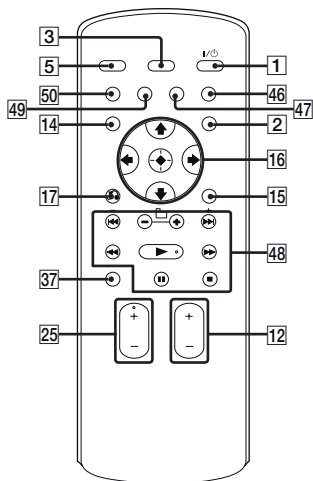











Remote RM-AMU008

- 1** I/⏻ (on/standby) (pages 13, 14, 16, 20, 34, 37)
Press to turn the system on or off.
- 2** TIMER MENU (pages 16, 32)
Press to set the clock and the timers.
- 3** DISPLAY (pages 16, 21, 27, 28)
Press to change the information in the display.
- 4** ILLUMINATION (page 26)
Press to select the power illuminator.
- 5** SLEEP (page 32)
Press to set the Sleep Timer.
- 6** Display (pages 10, 26, 28, 37)
- 7** Preset Effect buttons (SALSA/REGGAE/POP/SAMBA/TANGO/ROCK/JAZZ/DANCE/MOVIE/GAME) (page 22)
Press to select preset effect.
- 8** AMP MENU (pages 23, 27, 31)
Press to display the menu to operate the system.
- 9** FM MODE (pages 20, 37)
Press to select the FM monaural or stereo reception.
- 10** TUNER/BAND (page 19)
Press to select AM or FM band.
- 11** TUNING +/- (pages 19, 30)
Press to tune in a radio station.
- 12** Unit: FUNCTION (pages 14, 17, 22, 29)
Remote: FUNCTION +/- (pages 17, 19, 22, 29)
Press to select a function.
- 13** TUNING MODE (pages 19, 31, 37)
Press to select the tuning mode.
- 14** TUNER MEMORY (page 30)
Press to preset a radio station.
- 15** TOOL MENU (page 21)
Press to return to previous menu of the iPod.
- 16** ⬆/⬇/⬅/➡ (pages 16, 21, 23, 27, 31, 32)
Push to select the menu items of the system and iPod.
- Unit: ENTER (pages 16, 21, 23, 27, 29, 30, 31, 32)
Remote: Ⓢ (pages 16, 21, 29, 30, 32)
Press to enter the settings.
- 17** Unit: RETURN (page 21)
Remote: Ⓜ RETURN (page 21)
Press to return to previous menu of the iPod.
- 18** iPod (page 20)
Press to select iPod function.
- 19** PHONO (page 22)
Press to select PHONO function.

Continued ➤



- 20** Operation buttons for iPod function:
▶|| (play/pause) (pages 20, 21)
 Press to start or pause playback.
- ◀◀/▶▶** (rewind/fast forward) (page 21)
 Press to find a point in a track.
- ◀◀/▶▶** (go backward/go forward) (page 21)
 Press to select a track.
- 21** GAME MIXING (page 26)
 Press to select the level of the GAME input.
- 22** GAME (pages 22, 25)
 Press to select the GAME function.
- 23** GAME INPUT VIDEO jack (pages 13, 22)
 GAME INPUT AUDIO L/R jacks (pages 13, 22)
 Connect to an optional video game player.
- 24** PHONES jack (pages 34, 39)
 Connect the headphones.
- 25** Unit: VOLUME +/- (pages 17, 19, 20, 22, 32, 34)
 Turn to adjust the volume.
- Remote: VOLUME +/- (pages 17, 19, 20, 22, 32, 34)
 Press to adjust the volume.
- 26** Power illuminator (page 26)
- 27** Disc tray (pages 10, 14, 17, 35, 37)
- 28** MIC 1/MIC 2 jack (pages 32, 34, 39)
 Connect an optional microphone.
- 29** MIC LEVEL (pages 32, 34)
 Turn to adjust the microphone volume.
- 30** PLAY MODE (pages 18, 36, 37)
 Press to select the play mode of CD function.
- 31** DISC 1 ~ 5 (pages 17, 29)
 Press to select a disc.
 Press to switch to CD function from other function.
- 32** USER EQ (page 31)
 Press to select the preset user equalizer.
- 33** X-GROOVE (page 22)
 Press to reinforce the bass.
- 34** SURROUND (page 22)
 Press to select the surround effect.
- 35** IR Receptor (page 35)
- 36** EFFECT ON/OFF (page 22)
 Press to activate or deactivate the preset effect.
- 37** DISC SKIP (pages 14, 17, 29)
 Press to select next disc.
- 38** EX-CHANGE (page 17)
 Press to exchange other discs during playback.
- 39** (LBT-ZX99i only)
 SOUND FLASH (page 24)
 Press and hold to select "SOUND FLASH" effect.
- 40** iPod connector (pages 13, 20)
 Place an optional iPod on the connector to listen to audio contents stored in the iPod.

- 41** (LBT-ZX99i only)
MODE (page 23)
 When X-ROUND is set to on, press to select X-ROUND mode.
 (LBT-ZX99i only)
SPEAKERS (page 25)
 When X-ROUND is set to off, press to select speaker setting.
- 42** (LBT-ZX99i only)
X-ROUND ON/OFF (pages 23, 25)
 Press to activate or deactivate X-ROUND mode.
- 43** (LBT-ZX99i only)
JOG (page 24)
 Turn to select X-ROUND setting.
 Turn to select SOUND FLASH speed.
- 44** Operation buttons for CD function:
 +/- (pages 17, 29)
 Press to select a folder of MP3 files.
 (rewind/fast forward) (page 17)
 Press to fast forward or rewind.
 (go backward/go forward) (page 17)
 Press to select a track.
 (play/pause) (pages 17, 27, 29, 35)
 Press to start or pause playback.
 (stop) (pages 17, 19)
 Press to stop playback.
- 45**  **OPEN/CLOSE** (pages 14, 17, 35)
 Press to open or close the disc tray.
- 46** **EQ** (pages 22, 31)
 Press to select a preset sound effect.
- 47** **CLEAR** (page 30)
 Press to delete the last step from the program list.
- 48** Operation buttons on remote:
 +/- (tuning) (pages 19, 30)
 Press to tune in a radio station.
 +/- (pages 17, 29)
 Press to select a folder of MP3 files.
 (go backward/go forward) (pages 17, 21)
 Press to select a track.
 (rewind/fast forward) (pages 17, 21)
 Press to fast forward or rewind.
 * (play) (pages 17, 20, 29, 35)
 Press to start playback.
 (pause) (pages 17, 21)
 Press to pause playback.
 (stop) (pages 17, 19)
 Press to stop playback.
- 49** **REPEAT/FM MODE** (pages 17, 37)
 Press to change the Repeat Play setting of CD function.
 Press to select the FM monaural or stereo reception.
- 50** **PLAY MODE/TUNING MODE** (pages 18, 19, 29, 31, 36, 37)
 Press to select the play mode of CD function.
 Press to select the tuning mode.
- * The VOLUME + and  buttons have tactile dots. Use the tactile dots as references when operating the system.

Continued 

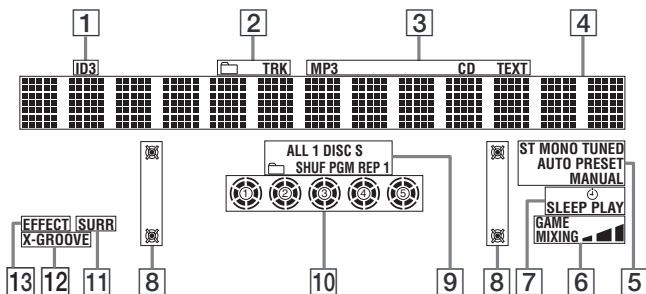
- Display



- 1 Lights up when the MP3 file contains ID3 tag information.
- 2 “TRK” lights up when a file name is displayed. “” lights up when a folder name is displayed.
- 3 Indicates the type of disc or file that the system recognized.
- 4 Displays the current status and information (page 28).
- 5 Indicators for the TUNER function (pages 19, 30).
- 6 Indicators for the level of the Game Mixing (page 26).
- 7 Lights up when the timer is set (page 32).
- 8 (LBT-ZX99i only)
Lights up according to the speaker system setting.
- 9 Indicates the selected play mode for CD function (pages 18, 28).
- 10 Indicators for the disc tray (page 17). “” lights up when the disc is selected. “” lights up when there is a disc on the disc tray. “1”, “2”, “3”, “4” and “5” light up when the system is turned on.
- 11 Lights up when the surround effect is activated (page 22).
- 12 Lights up when the X-GROOVE effect is activated (page 22).
- 13 Lights up when the sound effect is activated (page 22).

Hooking up the system

– Rear panel

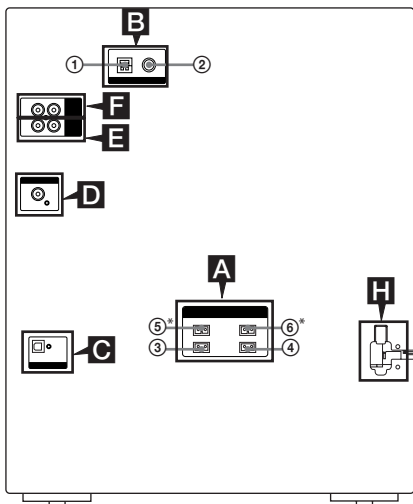

– Front panel

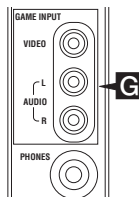

- ① To AM loop antenna
- ② To FM lead antenna
- ③ To front speaker (right)
- ④ To front speaker (left)
- ⑤ To surround speaker (right)
- ⑥ To surround speaker (left)

* LBT-ZX99i only.

A Speakers

The speaker connectors are color-coded with their respective speaker terminals on the unit.

Front speakers (LBT-ZX99i only)

Connect the speaker cords to the SPEAKER FRONT (SPEAKER A) terminals.

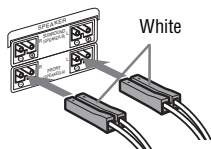

(LBT-ZX66i only)

Connect the speaker cords to the SPEAKER terminals.

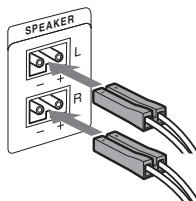

Continued

Tip

Connect the speaker cords to the terminals on the front speakers.

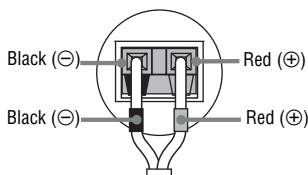

Surround speakers (LBT-ZX99i only)

Connect the speaker cords to the SPEAKER SURROUND (SPEAKER B) terminals and to the terminals on the speakers as shown in the tip above.

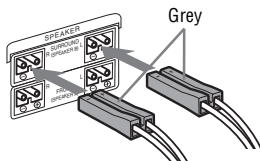

Notes

- Be sure to use only the supplied speakers.
- Be sure to connect the speakers securely and correctly. When connecting speaker cords, insert the connector straight into the terminals.

B Antennas

Find a location and an orientation that provide good reception, and then set up the antennas.

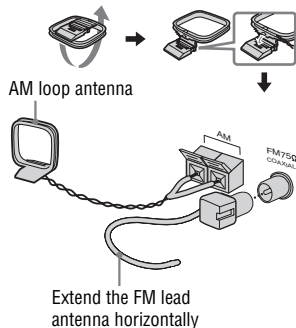

Note

Keep the antennas away from the speaker cords and the power cord to avoid picking up noise.

C CD DIGITAL OUT jack

Use a digital optical cable (square, not supplied) to connect the digital input of the optional MD deck to this jack. You can then record digital audio from this system.

Note

There is no digital audio output from this jack during playback of MP3 files.

D VIDEO OUT jack

Use a video cable (not supplied) to connect the video input of TV to this jack.

E PHONO IN L/R jacks

Use an audio cord (not supplied) to connect the audio output of the turntable to these jacks. You can then output audio through this system.

F PC IN L/R jacks

Use an audio cord (not supplied) to connect the audio output of the computer to these jacks. You can then output audio through this system.

G GAME INPUT jacks

GAME INPUT VIDEO jack

Use a video cable (not supplied) to connect the video output of the optional video game player to this jack. You can then output video through this system.

Note

The video game player image may appear on the TV screen even if the system is turned off.

GAME INPUT AUDIO L/R jacks

Use an audio cord (not supplied) to connect the audio output of the optional video game player to these jacks. You can then output audio through this system.

H Power

Connect the power cord to a wall outlet. The demonstration appears in the display. When you press I/⏻, the system turns on and the demonstration automatically ends.

Using the iPod

Insert the iPod Dock Adapter (not supplied) into the iPod connector before use.

Use a Dock Adapter supplied with your iPod. Otherwise, a compatible Dock Adapter will need to be purchased separately from Apple Inc.

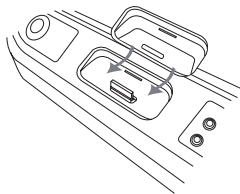

To remove the iPod Dock Adapter, pull it up with your fingernail or a flat object using the slot inside the adapter.

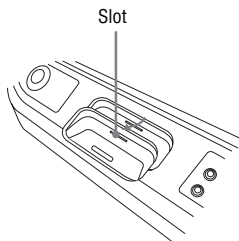

Using the remote

Slide and remove the battery compartment lid, and insert the two supplied R6 (size AA) batteries, \ominus side first, matching the polarities shown below.

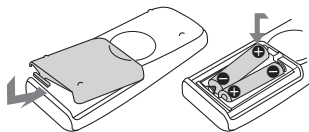

Notes

- If you do not use the remote for a long period of time, remove the batteries to avoid possible damage from battery leakage and corrosion.
- With normal use, the batteries should last for about six months. When the remote no longer operates the system, replace both batteries with new ones.
- Batteries installed devices shall not be exposed to excessive heat such as sunshine, fire or the like.

Attaching the speaker pads

Attach the supplied speaker pads at each corner on the bottom of the speakers to stabilize the speakers and to prevent them from slipping.

(LBT-ZX99i only)

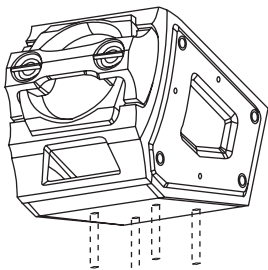

(LBT-ZX66i only)

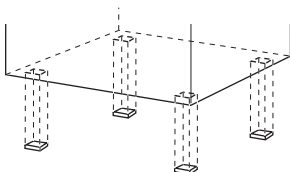

When carrying the unit

Do the following procedure to protect the disc mechanism.

Use the buttons on the unit for the operation.

- 1 Press **I/⏻** to turn on the system.
- 2 Press **FUNCTION** repeatedly to select "CD".
- 3 Press **▲ OPEN/CLOSE** to open the disc tray and remove the disc. If there are more than one disc in the disc tray, press **DISC SKIP** to remove the discs.
- 4 Press **▲ OPEN/CLOSE** again to close the disc tray. Wait until "CD No Disc" appears in the display.
- 5 Hold down **DISC SKIP** and then press **I/⏻** until "STANDBY" appears in the display. Then, "MECHA LOCK" appears in the display.
- 6 Unplug the AC power cord.

Note

Before carrying the unit, be sure to disconnect the iPod.

(LBT-ZX99i only)

When carrying the front and surround speakers

Do not carry the front and surround speakers by their sub panel.

Otherwise, the speakers may be damaged.

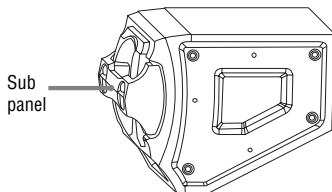

Positioning the speakers

You can place your speakers as shown below.

- Ⓐ Front speaker (left)
- Ⓑ Front speaker (right)
- Ⓒ Surround speaker (left)
- Ⓓ Surround speaker (right)
- Ⓔ Unit

LBT-ZX99i only

There are two ways to place the front speakers and the surround speakers.

Example 1: Place the surround speakers on the top of the front speakers as shown below.

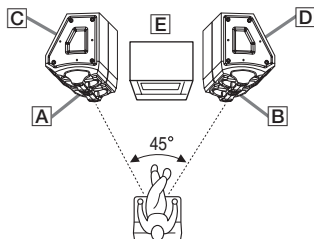

Example 2: Place the speakers at an equal distance from your listening position as shown below.

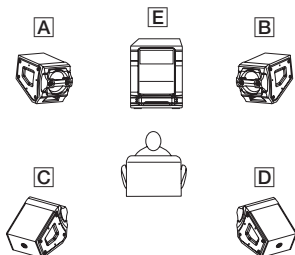

LBT-ZX66i only

Place the front speakers at an angle of 45 degrees from your listening position.

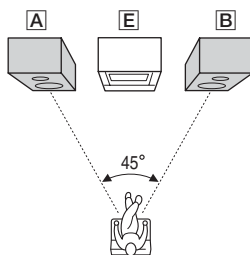

Setting the clock

1 Press I/⏻ to turn on the system.

2 Press **TIMER MENU**.

The hour indication flashes in the display.

If “PLAY SET?” flashes in the display, press **▲** or **▼** repeatedly to select “CLOCK SET?”, then press **ENTER** (or **⊕** on the remote).

3 Press **▲** or **▼** repeatedly to set the hour.

4 Press **ENTER** (or **⊕** on the remote).

The minute indication flashes in the display.

5 Press **▲** or **▼** repeatedly to set the minute.

6 Press **ENTER** (or **⊕** on the remote).

The clock starts functioning.

Note

The clock settings are canceled when you disconnect the power cord or if a power failure occurs.

To display the clock when the system is off

Press **DISPLAY** repeatedly until the clock is displayed. The clock is displayed for a few seconds (except when iPod is connected).

When an iPod is connected, the display will change to clock automatically. For details, see page 27.

Basic Operations

Playing a CD/MP3 disc

- 1 Press **FUNCTION** (or **FUNCTION +/-** on the remote) repeatedly to select “CD”.
- 2 Press **▲ OPEN/CLOSE**.
- 3 Load a disc with the label side facing up on the disc tray.

When you playback an 8 cm disc such as a CD single, place it on the inner circle of the tray

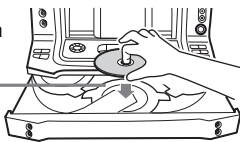

To load additional discs, press **DISC SKIP** to rotate the disc tray.

- 4 Press **▲ OPEN/CLOSE** to close the disc tray.

Do not forcibly push the disc tray to close it as this may cause a malfunction.

- 5 Press **▶||** (or **▶** on the remote) to start playback.
- 6 Turn **VOLUME +/-** (or press **VOLUME +/-** on the remote) to adjust the volume.

Other operations

To	Do this
Stop playback	Press ■ .
Pause playback	Press ▶ (or on the remote). Press ▶ (or on the remote) again to resume playback.

To	Do this
Select a track or file	Press ◀◀ or ▶▶ repeatedly during playback.
Select a folder on an MP3 disc	Press □ +/- repeatedly.
Find a point in a track or file ¹⁾	Press and hold down ◀◀ or ▶▶ during playback and release it at the point you want to resume playback. Use button on the remote for this operation while playing an MP3 file.
Playback all the tracks or files on the disc(s) or in the folder ²⁾ repeatedly ³⁾ (Repeat Play)	Press REPEAT/FM MODE on the remote repeatedly during playback until “REP” lights up in the display.
Playback a single track or file repeatedly ⁴⁾ (Repeat Play)	Press REPEAT/FM MODE on the remote repeatedly during playback until “REP 1” lights up in the display.
Select a disc when playback is stopped	Press one of the DISC 1 ~ 5 buttons or DISC SKIP .
Switch to CD function from another source and start playback automatically ⁵⁾	Press one of the DISC 1 ~ 5 buttons (Automatic Source Selection).
Exchange other discs while playing	Press EX-CHANGE . The disc tray slides out. Then press DISC SKIP to select the disc you want to exchange.

¹⁾ The elapsed playing time may not be displayed correctly depending on the MP3 files.

²⁾ When “**□**” or “**□ SHUF**” is selected for MP3 files.

Continued 

- 3) Playback repeatedly up to five times.
 You cannot select "REP" and "ALL DISCS SHUF" at the same time.
- 4) A track or file is played back repeatedly until you stop playback.
- 5) Only when there is a disc in disc tray.



* Shuffle Play mode will change to Normal Play mode each time you turn on the system. Each time you perform Shuffle Play, the playing order may differs.

Tip

You can not change the play mode during playback. To change the play mode, press **■** to stop playback.

To change the play mode

Press PLAY MODE repeatedly when playback is stopped. You can select the following play mode.

Select	To play back
ALL DISCS (Normal Play)	The tracks or files on all discs in original order.
1 DISC (Normal Play)	The tracks or files on the disc you have selected in original order.
 (Normal Play)	The MP3 files in the folder on the disc you have selected in original order. For AUDIO CDs, this play mode performs the same operation as "1 DISC" play mode.
ALL DISCS SHUF* (Shuffle Play)	The tracks or files on all discs in random order.
1 DISC SHUF* (Shuffle Play)	The tracks or files on the disc you have selected in random order.
 SHUF* (Shuffle Play)	The MP3 files in the folder on the disc you have selected in random order. For AUDIO CDs, this play mode performs the same operation as "1 DISC SHUF" play mode.
PGM (Program Play)	The tracks on all discs in the order you want them to be played back (see "Creating your own program" on page 29).

Notes on playing discs

- This system can playback MP3 files in the format of MPEG 1 Audio Layer 3, MPEG 2 Audio Layer 3 and MPEG 2.5 Audio Layer 3.
- This system can playback Multi Session discs when an MP3 file is located in the first session. Any subsequent MP3 files, recorded in the later sessions, can also be played back.
- The following discs/situations can increase the time it takes to start playback:
 - a disc recorded with a complicated tree structure.
 - a disc recorded in Multi Session.
 - a disc to which data can be added (non-finalized disc).
 - when the files in another folder have just been played back.
- When the disc is loaded, the system reads all the files on that disc. If there are many folders or non-MP3 files on the disc, it may take a longer time for playback to begin or for the next MP3 file to start playback.
- MP3 files are played back in the order that they are recorded onto the disc.
- You are recommended not to save other types of files or unnecessary folders on a disc that has MP3 files.
- The system can only play back MP3 files with the extension ".mp3".
- Attempting to play back non-MP3 format files that have the extension ".mp3" may result in noise or malfunction.
- A folder that does not include an MP3 file is skipped.
- The system can recognize the maximum of
 - 150 folders (including the root folder).
 - 300 MP3 files.
- Depending on the encoding/writing software, recording device, or the recording media used to record an MP3 file, you may encounter problems such as can not play back, sound interruptions and noise.

Tips

- When switching to “CD” function from “TUNER” function by pressing **▶||**, a longer time may be required to access the disc. In this case, set “CD POWER ON” by CD power manage function (page 20).
- If you press **▶||** while the system is turned off, the system turns on automatically and “CD” function is selected. Then, playback starts if there is a disc in the disc tray (One Touch Play).

Listening to the radio

- 1 Press TUNER/BAND (or FUNCTION +/- on the remote) repeatedly to select FM or AM band.**
- 2 Press TUNING MODE repeatedly until “AUTO” lights up in the display.**
- 3 Press TUNING +/- (or +/- on the remote).**

Scanning stops automatically when a station is tuned in and “TUNED” lights up in the display. When a FM stereo program is tuned in, “ST” lights up in the display.

Note

If “TUNED” does not light up and scanning does not stop, see “To improve tuner reception” below.

- 4 Turn VOLUME +/- (or press VOLUME +/- on the remote) to adjust the volume.**

To stop automatic scanning

Press ENTER (or **⊕** on the remote).

To improve tuner reception

When the tuner reception is poor, set the CD power manage function to “CD POWER OFF”.

The default setting is “CD POWER ON”. Use buttons on the unit for the operation.

- 1 Press FUNCTION repeatedly to select “CD”.**
- 2 Press I/⏻ to turn off the system.**
- 3 Press I/⏻ while holding down ■.**
The system turns on automatically. “CD POWER OFF” appears in the display.

Continued 

To set CD power on

Repeat the procedure above and “CD POWER ON” appears in the display.

Notes

- When “CD POWER OFF” is selected, disc access time is increased.
- You cannot change the CD power manage setting in Power Saving Mode (page 27).

To change the AM tuning interval

The factory setting for AM tuning interval is 10 kHz.

Use the buttons on the unit for the operation.

- 1 Press TUNER/BAND repeatedly to select AM band.
- 2 Press I/⏻ to turn off the system.
- 3 When demonstration appears, hold down TUNING MODE and then press I/⏻.

The system turn on automatically. “AM 9K STEP” or “AM 10K STEP” appears in the display.

When you change the interval, all the AM preset stations are erased.

Tip

To improve broadcast reception, adjust the supplied antennas, or connect an external antenna.

To reduce static noise on a weak FM stereo station

Press FM MODE repeatedly until “MONO” lights up in the display. There will be no stereo effect, but the reception will improve.

Playing the iPod

You can listen to audio contents stored in the iPod on this system.

- 1 Press iPod.
- 2 Place the iPod.

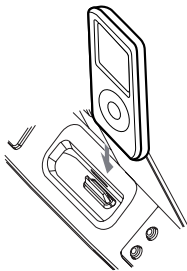

- 3 Press ►|| (or ► on the remote) to start playback.
- 4 Turn VOLUME +/- (or press VOLUME +/- on the remote) to adjust the volume.

Notes

- When you connect an iPod to the unit, the iPod is automatically turned on if the system is turned on.
- When placing or removing the iPod, handle the iPod in the same angle as that of the iPod connector on the unit and do not twist or sway the iPod to prevent connector damage.
- Do not carry the unit with an iPod set on the connector. Doing so may cause a malfunction.
- When placing or removing the iPod, brace the unit with one hand and take care not to press the controls of the iPod by mistake.
- Before disconnecting the iPod, pause playback.
- Depending on the connected iPod, you may not be able to use ◀◀ or ▶▶ while playing video. In this case, you can fast rewind or fast forward by holding down ◀◀◀ or ▶▶▶.
- To change the volume level, use VOLUME +/--. The volume level does not change even if adjusted on the iPod.
- This iPod connector is designed for iPod only. You cannot connect any other portable audio players.

- To use an iPod, refer to the operating instructions of your iPod.
- Sony cannot accept responsibility in the event that data recorded to iPod is lost or damaged when using an iPod with this unit.
- Some iPod operations may not be performed using buttons on the unit or remote.
- Depending on the connected iPod, operations may differ.

Other operations

You can control your iPod with the following buttons on the remote or unit.

To	Do this
Pause playback	Press ▶ (or on the remote). Press ▶ (or on the remote) again to resume playback.
Select a track or chapter of audiobook/podcast	Press ◀◀ or ▶▶ repeatedly.
Fast forward or fast rewind Play	Hold down ◀◀ or ▶▶ during playback, then release it at the point you want.
Select the iPod menu item	Press TOOL MENU or ◀ or RETURN (or ↶ RETURN on the remote). You can return to the previous menu or select a menu of the iPod.
Note You can confirm menu and item selections on the iPod screen during operation	
Scroll up/down the iPod menus	Press ▲/▼ repeatedly.
Choose the select item	Press ENTER (or ▶ or ⊕ on the remote).

Tips

- If you press **▶||** while the system is turned off, the system turns on automatically and “iPod” function is selected. Then, playback starts if there is an iPod connected to the iPod dock (One Touch Play). However, depending on the status of the connected iPod, the iPod may not be playback.
- The following buttons on the unit or remote have the similar function with the buttons on the iPod (except iPod Touch).

Buttons on the unit or remote	Buttons on the iPod which have similar function
-------------------------------	---

▶ (or ▶ or on the remote)	▶
---	------------

◀◀/▶▶	◀◀/▶▶
--------------	--------------

TOOL MENU or RETURN (or ↶ RETURN on the remote) or ◀	MENU
---	-------------

ENTER (or ⊕ on the remote)	Center button.
--	-----------------------

- Press and hold **▲** or **▼** on the unit or remote has the similar function of turning the Click Wheel on the iPod clockwise or counterclockwise.
- Be sure that the iPod is not playing when using the One Touch Play.

To use the system as a battery charger

You can use the system as a battery charger for the iPod when the system is on or off.

The charging begins when the iPod is placed on the iPod connector. The charging status appears in the iPod screen and when the system is off the display of the unit change to clock. For details, refer to the operating instructions of your iPod.

To stop charging the iPod

Remove the iPod. If you stop charging the iPod when the system is off, press **DISPLAY** repeatedly until the display is turned off (Power Saving mode).

Using optional components

1 Connect an optional component:

Optional components	Connect to	Cord used (not supplied)
Turntable	PHONO IN L/R jacks	Audio analog cord
Computer	PC IN L/R jacks	Audio analog cord
Video game player	GAME INPUT VIDEO jack	Video cord
	GAME INPUT AUDIO L/R jacks	Audio analog cord

2 Turn **VOLUME +/-** counterclockwise (or press **VOLUME -** on the remote) to turn down the volume.

3 To listen to a connected optional component, press **FUNCTION** (or **FUNCTION +/-** on the remote) repeatedly to select **"PHONO"**, **"PC"** or **"GAME"**.

You can also press PHONO or GAME to select the function.

4 Start playing the connected component.

5 Turn **VOLUME +/-** (or press **VOLUME +/-** on the remote) to adjust the volume.

Adjusting the sound

To add a sound effect

To	Do this
Reinforce the bass and create a more powerful sound	Press X-GROOVE repeatedly to select "X-GROOVE ON"*.
Select the surround effect	Press SURROUND repeatedly to select "SURROUND ON".
Select the preset sound effect	Press one of the Preset Effect buttons (or EQ repeatedly on the remote) to select the preset effect you want. The preset effect name appears in the display. "SURR" lights up in the display if you select an effect with surround effects. To cancel the effect, press EFFECT ON/OFF repeatedly to select "EFFECT OFF".

* The volume switches to power mode and the equalizer curve changes.

Enhancing the MP3 file sound quality

You can enhance the MP3 file sound quality during playback.

- 1 Press AMP MENU repeatedly to select "MP3 BOOSTER".
The last selected MP3 booster setting appears in the display.
- 2 Press ◀ or ▶ repeatedly to select the setting you want.
The display changes as follows:
BOOSTER OFF ↔ BOOSTER ON
- 3 Press ENTER.

Notes

- You can only listen to MP3 Booster effect during playback of MP3 files.
- MP3 Booster effect will reset to "BOOSTER ON" each time you turn on the system.

Creating a party atmosphere

(LBT-ZX99i only)

You can create a party environment by using X-ROUND for "moving" sound effect or/and SOUND FLASH for flashing effect.

To enjoy the X-ROUND mode, place your front and surround speakers at an equal distance from your listening position (see Example 2 of "Positioning the speakers for LBT-ZX99i only" on page 15).

Moving sound effect

— X-ROUND

- 1 Press X-ROUND ON/OFF repeatedly until the X-ROUND ON/OFF button lights up.
The last selected X-ROUND mode appears in the display.
- 2 Press MODE repeatedly to select the X-ROUND mode you want.
The display changes cyclically as follows:
MANUAL WAVE → MANUAL FADER → MANUAL BAL → AUTO WAVE → AUTO FADER → AUTO BAL → RANDOM POS → TWISTER

Select	To output sound
MANUAL WAVE, AUTO WAVE	In circular motion around the room
MANUAL FADER, AUTO FADER	Back and forth between the front speakers and surround speakers

Continued 

Select	To output sound
MANUAL BAL, AUTO BAL	Back and forth between the left speakers and right speakers
RANDOM POS	In random position
TWISTER	In circular motion like “twister”

To change the sound movement

Turn the JOG to change the sound movement from one speaker to another speaker during MANUAL WAVE, MANUAL FADER and MANUAL BAL.

To change the speed of sound movement

Turn the JOG to change the speed of the sound movement during AUTO WAVE, AUTO FADER and AUTO BAL.

To cancel the X-ROUND effect

Press X-ROUND ON/OFF repeatedly until “X-ROUND OFF” appears in the display. The X-ROUND ON/OFF button lights off.

Notes

- If you cannot get the sound effect you want, check the speaker connections.
- When the headphones are connected to the PHONES jack, X-ROUND mode is automatically changed to “X-ROUND OFF” and you cannot change this setting.

Flashing sound effect

— SOUND FLASH

With the flash function, you can flash the sound output. The sound cuts off periodically.

Hold down SOUND FLASH during playback

The flashing effect is activated.

To cancel the flashing effect

Release SOUND FLASH.

To change the flash speed

Hold down SOUND FLASH and turn the JOG clockwise or counterclockwise to change the flash speed (1 ~ 20).

Tips

- You can activate the X-ROUND and SOUND FLASH effect simultaneously.
- The power illuminator will synchronize with the selected SOUND FLASH effect.

Selecting the speaker setting

(LBT-ZX99i only)

You can select the speakers which you want the sound to be output.

1 Press X-ROUND ON/OFF repeatedly to select “X-ROUND OFF”.

The X-ROUND button lights off.

2 Press SPEAKERS.

Each time you press the button, the corresponding speaker indicators light up and the display changes cyclically as follow:

SPEAKERS A → SPEAKERS B →
SPEAKERS A+B

To select	Display
The front speakers	SPEAKERS A
The surround speakers	SPEAKERS B
Both the front and surround speakers	SPEAKERS A+B

Notes

- When X-ROUND mode is selected, the speaker system setting automatically changes to SPEAKERS A+B.
- When the headphones are connected to the PHONES jack, the speaker system setting is automatically changed to “SPEAKERS A+B” and you cannot change this setting.

Enhancing the video game sound

— Game Sync

You need to connect a video game player (see “Hooking up the system” on page 11).

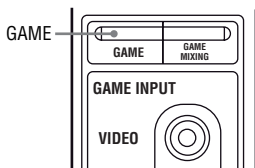

Press GAME.

The GAME function and the “GAME” preset effect is selected automatically.

Tips

- If you press GAME while the system is turned off, the system turns on automatically and GAME is selected as the function.
- You can also press FUNCTION (or FUNCTION +/- on the remote) repeatedly to select “GAME”.

Mixing video game sound with other sound source

— Game Mixing

You can mix the sound from the component connected to the GAME INPUT jacks with another function such as CD, radio, computer, iPod or turntable connected to this system.

1 Select the source sound you want.

2 Press **GAME MIXING**.

Each time you press the button, the level of the game sound changes cyclically as follows:

MIXING LOW → MIXING MID →
MIXING HIGH → MIXING OFF

Tip

The GAME MIXING indicator lights up in the display while Game Mixing is activated and it will remain active while the power is on even if the function is changed.

Changing the display

Changing the power illuminator

You can select the power illuminator as you want.

Press ILLUMINATION repeatedly to select the power illuminator you want when the system is turned on.

Each time you press the button, the power illuminator changes cyclically as follows:

PATTERN 1 → PATTERN 2 →
PATTERN 3 → PATTERN 4 →
PATTERN OFF

When X-ROUND mode is selected (LBT-ZX99i only)

Each time you press the button, the power illuminator changes cyclically as follows:

X-PATTERN* ↔ PATTERN OFF

* The power illuminator will synchronize with the selected X-ROUND effect.

Notes

- When you turn VOLUME +/- (or press VOLUME +/- on the remote), power illuminator shows the current volume level.
- During the demonstration display, you can turn on or off power illuminator by pressing ILLUMINATION.

Changing the spectrum analyzer display

- 1** Press **AMP MENU** repeatedly to select **“SPECTRUM”**.

The last selected spectrum appears in the display.

- 2** Press **←** or **→** repeatedly to select the setting you want.

The display changes cyclically as follows:

SPECTRUM 1 → SPECTRUM 2 →
SPECTRUM 3 → SPECTRUM 4 →
SPECTRUM OFF

When X-ROUND mode is selected (LBT-ZX99i only)

The display changes as follows:

X-POSITION* ↔ SPECTRUM OFF

- * The spectrum analyzer display will synchronize with the selected X-ROUND effect.

- 3** Press **ENTER**.

Adjusting the brightness of the display

- 1** Press **AMP MENU** repeatedly to select **“DIMMER”**.

The last selected dimmer appears in the display.

- 2** Press **←** or **→** repeatedly to select the setting you want.

The display changes cyclically as follows:

DIMMER 1 → DIMMER 2 →
DIMMER 3*

* DIMMER 3 is the darkest.

- 3** Press **ENTER**.

Changing the display mode

Press **DISPLAY** repeatedly while the system is turned off.

You can select the following display mode.

Demonstration¹⁾

The display changes and the indicators flash even when the system is turned off.

No display (Power Saving Mode)¹⁾²⁾

The display is turned off to conserve power. The timer and clock continue to operate.

Clock

The clock is displayed. The clock display automatically turns to Power Save Mode after a few seconds. However, the display returns to clock display when you connect an iPod.³⁾

¹⁾ When an iPod is connected, the display change to clock. If you remove the iPod, the display changes to Power Saving Mode after a few seconds.

²⁾ You cannot perform the following operations during Power Saving Mode:

- Setting the clock (page 16).
- Changing the AM tuning interval (page 20).
- Turning on the system by pressing the function buttons or **▶II**.
- Changing “CD POWER” setting (page 19).

³⁾ The clock is displayed continuously while the iPod is being charged. To turn off the clock display, press **DISPLAY** (see “To stop charging the iPod” (page 21)).

Viewing information in the display

You can check the playing time and remaining time of the current file or current disc. When a CD-TEXT disc or a disc with MP3 files is loaded, you can check the information stored on the disc, such as the titles. When the system detects CD-TEXT discs, "CD-TEXT" lights up in the display.

Checking the remaining time

Press DISPLAY repeatedly during playback.

Each time you press the button, the display changes cyclically as follows:
Playing time of the current file →
Remaining time of the current file¹⁾ →
Remaining time of the current disc²⁾ →
Title of the current file³⁾ → Title of the current folder (for a few seconds)⁴⁾ →
Clock display¹²⁾ (for 8 seconds) → Effect status (for 8 seconds)

Checking the total playing time

Press DISPLAY repeatedly when playback is stopped (except for Program Mode).

Each time you press the button, the display changes cyclically as follows:
Total number of files⁵⁾ or folders⁶⁾ or the total playing time⁷⁾ → Title of current folder⁵⁾ or title of current disc⁸⁾ → Clock display¹²⁾ (for 8 seconds) → Effect status (for 8 seconds)

Press DISPLAY repeatedly when playback is stopped during Program Play and there is a program.

Each time you press the button, the display changes cyclically as follows:
The last file number of the program and the total playing time⁹⁾ → Total number of programmed files (for 8 seconds)¹⁰⁾ → Disc title¹¹⁾ → Clock display¹²⁾ (for 8 seconds) → Effect status (for 8 seconds)

- 1) "--:--" appears while an MP3 file is played back.
- 2) "--:--" appears in the following cases:
 - While an MP3 file is played back.
 - All play modes except "1 DISC" and "□".
- 3) Only for CD-TEXT disc and a disc with MP3 files.
When the CD-TEXT disc contains more than 20 files, the current file title is not displayed from file 21 onwards.
- 4) Only for disc with MP3 files.
- 5) For disc with MP3 files in "□" and "□ SHUF" modes.
- 6) For disc with MP3 files in play modes other than "□" and "□ SHUF".
- 7) For audio CDs.
- 8) For disc with MP3 files in play modes other than "□", "□ SHUF" and CD-TEXT discs.
- 9) "--:--" appears in the following cases:
 - When the audio CD contains 21 files or more, and the file number which exceeds 20 is selected.
 - When the total program exceeds 100 minutes.
 - When the program list contains MP3 files.
- 10) "NO STEP" appears if there is no program.
- 11) Only for CD-TEXT disc and a disc with MP3 files.
- 12) "--:--" appears in the display if you have not set the clock.

Note

Some characters may not be displayed for file title, folder title or disc title.

Other Operations

Creating your own program

— Program Play

You can make a program of up to 25 steps in the order you want them to be played back.

1 Press **FUNCTION** (or **FUNCTION +/-** on the remote) repeatedly until “CD” appears in the display.

2 When playback is stopped, press **PLAY MODE** repeatedly until “PGM” lights up in the display.

3 Press one of the **DISC 1 ~ 5** buttons or **DISC SKIP** to select a disc.

To program all the tracks on a disc at once:

Proceed to step 5 while “ALL” appears in the display.

To program all the MP3 files on a folder at once:

Press **[] +/-** repeatedly until the folder you want appears in the display, then proceed to step 5.

4 Select a track or file to program.

To program a track:

Press **◀◀** or **▶▶** repeatedly until the track number you want appears in the display.

To program an audio file:

Press **[] +/-** repeatedly until the folder you want appears in the display, then press **◀◀** or **▶▶** repeatedly until the file number you want appears in the display.

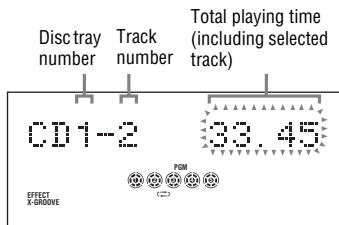

5 Press **ENTER** (or **+/-** on the remote).

The track(s) or file(s) is(are) programmed.

The program step number appears, followed by total playing time.

6 Program additional discs, tracks or files.

To program	Repeat steps
Other discs	3 and 5
Other tracks or files on the same disc	4 and 5
Other tracks or files on other discs	3 to 5
Other files on same folder	4 and 5 (without pressing [] +/-)
Other files on other folder	4 and 5

7 Press **▶||** (or **▶** on the remote).

Program Play starts.

Continued

Other operations

To	Do this
Cancel Program Play	When playback is stopped, press PLAY MODE repeatedly until "PGM" disappear from the display.
Delete the last step from the program list	Press CLEAR on the remote when playback is stopped.

Tips

- The program you made remains in the system's memory even after it has been played back. Press ►|| (or ► on the remote) to play back the same program again.
- If "--.--" appears instead of the total playing time during programming, this means:
 - you have programmed a file in an AUDIO CD with file number exceeds 20.
 - the total playing time has exceeded 100 minutes.
 - you have programmed an MP3 audio file.

Presetting radio stations

You can preset your favourite radio stations and tune them in instantly by selecting the corresponding preset number.

1 Tune in the station you want (see "Listening to the radio" (page 19)).

2 Press TUNER MEMORY.

A preset number flashes in the display. The stations are stored from preset number 1.

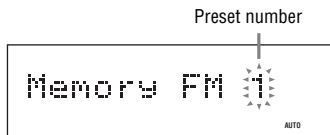

3 Press TUNING +/- (or +/- on the remote) repeatedly to select the preset number you want.

If another station is already assigned to the selected preset number, the station is replaced by the new stations.

4 Press ENTER (or + on the remote).

"Complete!" appears in the display. The station is stored.

5 Repeat steps 1 to 4 to store other stations.

You can preset up to 20 FM and 10 AM stations.

6 To call up a preset radio station, press TUNING MODE repeatedly until "PRESET" lights up in the display. Then, press TUNING +/- (or +/- on the remote) repeatedly to select the preset number you want.

To cancel presetting

Press TUNER MEMORY.

Creating your own sound effect

You can adjust the sound by raising or lowering the level of specific frequency band, then store the user equalizer in the memory.

Before adjustment, select the preset effect you want for your basic sound.

1 Press AMP MENU repeatedly to select "EQ EDIT".

2 Press ← or → repeatedly to select a frequency band, then press ↑ or ↓ repeatedly to adjust the level.

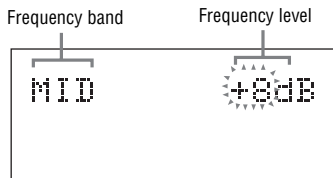

3 Press ENTER to save the user equalizer setting.

"USER EQ" appears on the display.
The user equalizer setting is saved.

To call up the user equalizer setting

Press USER EQ (or EQ on the remote repeatedly) to select "USER EQ".

Notes

- When you select certain preset effects, the surround effect may be canceled.
- When the surround effect is selected, "SURR" lights up in the display.

Singing along

You can sing along with any audio source that play back on this system.

1 Turn **MIC LEVEL** to **MIN** to reduce the microphone volume.

2 Connect an optional microphone to **MIC 1** or **MIC 2** jack.

Connect another optional microphone if you want to sing in duet.

3 Start playing the music and adjust the volume.

4 Turn **MIC LEVEL** to adjust the microphone volume.

If acoustic feedback (howling) occurs, reduce the volume, move the microphone away from the speakers, or change the direction of the microphone.

After you have finished, turn the **MIC LEVEL** to **MIN** and then disconnect the microphone from the **MIC 1** and/or **MIC 2** jack.

Using the timer

The system offers two timer functions.

Sleep Timer

You can set the system to turn off after a certain time, so that you can fall asleep to music.

Press SLEEP repeatedly.

The minute display (turn-off time) changes cyclically as follows:

SLEEP AUTO* → SLEEP 90min →
SLEEP 80min → ... → SLEEP 10min →
SLEEP OFF

* The system automatically turns off in 100 minutes or after the current disc finishes playing.

Tip

To check the remaining time, press **SLEEP** once. However, you can not check the remaining time if you select "AUTO".

Play Timer

You can wake up to music from disc, iPod or tuner at a preset timer.

Make sure you have set the clock.

1 Prepare the sound source and then use **VOLUME +/-** to adjust the volume.

2 Press **TIMER MENU**.

3 Press **▲** or **▼** repeatedly to select "PLAY SET?", then press **ENTER** (or **⊕** on the remote). "ON" appears and the hour indication flashes in the display.

4 Set the time to start playback.

Press **▲** or **▼** repeatedly to set the hour, then press ENTER (or **⊕** on the remote).

The minute indication flashes in the display. Use the procedure above to set the minute. "OFF" appears and the hour indication flashes in the display.

5 Set the time to stop playback using the same procedure as step 4.**6 Select the sound source.**

Press **▲** or **▼** repeatedly until the music source you want appears in the display, then press ENTER (or **⊕** on the remote). The display will show the timer settings.

7 Press I/⏻ to turn off the system.

The system turns on a few seconds before the preset time. If the system is on at the preset time, the Play Timer will not play.

Notes

- If you use the Play Timer and the Sleep Timer at the same time, the Sleep Timer has priority.
- The Play Timer will not be activated if the system is turned on or if "STANDBY" flashes in the display.
- The Play Timer setting remains as long as the setting is not canceled manually.
- Be sure that the iPod is not playing when using the Play Timer.
- The system turns on 30 seconds before the preset time.
- The Play Timer may not be activated depending on the status of the connected iPod or iPod touch.

Other operations

To	Do this
Check the setting	<ol style="list-style-type: none"> 1 Press TIMER MENU. "TIMER SELECT?" flashes in the display. 2 Press ENTER (or ⊕ on the remote). 3 Press ▲ or ▼ repeatedly to select "PLAY SELECT?", then press ENTER.
Change the setting	Start from step 1.
Cancel the Play Timer	<ol style="list-style-type: none"> 1 Press TIMER MENU. "TIMER SELECT?" flashes in the display. 2 Press ENTER (or ⊕ on the remote). 3 Press ▲ or ▼ repeatedly to select "TIMER OFF?", then press ENTER.

Additional Information

Troubleshooting

Should you encounter a problem with your system, do the following:

- 1 Make sure the power cord and speaker cords are connected correctly and firmly.
- 2 Find your problem in the troubleshooting checklist below and take the indicated corrective action.

If the problem persists after doing all of the above, consult your nearest Sony dealer.

Note that if service personnel changes some parts during repair, these parts may be retained.

When the I/⏻ indicator flashes

Immediately unplug the power cord and check the following items.

- Are the + and – speaker cords short-circuited?
- Are you using the supplied speakers?
- Is anything blocking the ventilation holes on the rear of the unit?

After checking the above items and fixing any problems, plug in the power cord again and turn on the system. If the I/⏻ indicator still flashes, or if the cause of the problem can not be found even after checking all the above items, consult your nearest Sony dealer.

General

The display starts flashing as soon as you plug in the power cord even though you have not turned on the system.

- The demonstration mode started. Press I/⏻ (page 13).

The clock or timer setting is canceled.

- The power cord is disconnected or a power failure occurred. Redo “Setting the clock” (page 16). If you have set the timer, redo “Using the timer” (page 32).

“--:--” appears in the display.

- The clock is not set. Set the clock (page 16).
- A power failure has occurred. Set the clock (page 16) and timer settings (page 32) again.

There is no sound.

- Turn VOLUME + clockwise (or press VOLUME + repeatedly on the remote).
- The headphones are connected to the PHONES jack.
- Check the speaker connections (page 11).
- Check the speaker system setting (page 25).

There is no microphone sound.

- Turn VOLUME +/- clockwise (or press VOLUME + repeatedly on the remote) or turn MIC LEVEL clockwise to adjust the microphone volume.
- Make sure the microphone is connected to the MIC 1 or MIC 2 jack correctly.

There is severe hum or noise.

- A TV or VCR is placed too close to the unit. Move the unit away from the TV or VCR.
- Move the unit away from the source of noise.
- Connect the unit to a different wall outlet.
- Install a noise filter (commercially available) to the power cord.
- Turn off surrounding electrical equipment.

The timer does not function.

- Check the timer setting and set the correct time (page 32).
- Cancel the Sleep Timer function (page 32).

The remote does not function.

- Remove the obstacles between the remote and the unit.
- Move the remote closer to the unit.
- Point the remote at the unit's sensor.
- Replace the batteries (R6/size AA).
- Move the unit away from the fluorescent light.

There is acoustic feedback.

- Reduce the volume.
- Move the microphone away from the speakers or change the direction of the microphone.

Speakers**Sound comes from one channel or unbalanced left and right volume.**

- Place the speakers as symmetrically as possible.
- Check that the speaker are connected securely and correctly.
- The source being played back is monaural.
- Turn off the X-ROUND effect (page 24).

Sound lacks bass.

- Check that the speaker's + and - terminals are connected correctly.

Disc player**The disc tray does not open and "LOCKED" appears in the display.**

- Consult your nearest Sony dealer or local authorized Sony service facility.



The disc tray does not close.

- Load the disc correctly.
- Always close the disc tray by pressing  OPEN/CLOSE. Do not forcibly push the disc tray to close it as this may cause a malfunction.

The disc does not eject.

- Consult your nearest Sony dealer.

Playback does not start.

- Open the disc tray and check whether a disc is loaded.
- Wipe the disc clean (page 38).
- Reload the disc.
- Load the disc that this system can play back (page 38).
- Load the disc on the disc tray with the label side facing up.
- Remove the disc and wipe away the moisture on the disc, then leave the system turned on for a few hours until the moisture evaporates.
- Press  (or  on the remote) to start playback.

Disc access takes a long time.

- Set "CD POWER ON" by CD power manage function (page 20).

The sound skips.

- Wipe the disc clean (page 38).
- Reload the disc.
- Move the unit to a place without vibration (e.g., on top of a stable stand).
- Move the speakers away from the unit, or place them on separate stands. When you listen to a track with bass sounds at high volume, the speaker vibration may cause the sound to skip.

Continued 

Playback does not start from the first track.

- The system is in Program Play or Shuffle Play mode. Press PLAY MODE repeatedly until “ALL DISCS”, “1 DISC” or “” lights up in the display.

The MP3 file can not be played back.

- The MP3 file is not recorded in a format that conforms to ISO9660 Level 1/ Level 2, or Joliet (expansion format).
- The MP3 file does not have the extension “.mp3”.
- The MP3 file in format other than MPEG 1, 2 and 2.5 Audio Layer 3 can not be played back.
- The system can play back to a depth of 8 folders only.
- The disc contains more than 150 folders.
- The disc contains more than 300 MP3 files.
- MP3 files in MP3 PRO format can not be played back.

The MP3 files take a longer time to play back than others.

- After the system reads all the files on the disc, playback may take more time than usual if:
 - the number of folders or files on the disc is very large.
 - the folder and file organization structure is very complex.

The folder name, track name, file name, ID3 tag and CD-TEXT characters do not appear properly.

- Use a disc that conforms to ISO9660 Level 1/Level 2, or Joliet (expansion format).
- The ID3 tag is not version 1 or version 2.
- The character code that can be displayed by this system are as follows:
 - Upper cases (A to Z)
 - Lower cases (a to z)
 - Numbers (0 to 9)
 - Symbols (<> * +, ? / [] \ _)Other characters may not be displayed correctly.

iPod

There is no sound.

- Make sure the iPod is connected securely.
- Make sure the iPod is playing music.
- Adjust the volume.
- Depending on the contents of the iPod, it may take time to start playback.
- You are using an unsupported iPod. See “Compatible iPod models with this system” (page 42) for the supported device types.

The sound is distorted.

- Reduce the volume.
- Set the “EQ” setting of the iPod to “Off” or “Flat”.

The iPod can not be charged.

- Make sure the iPod is connected securely.

Tuner

There is severe hum or noise. (“TUNED” or “ST” flashes in the display)

- Set the proper band and frequency (page 19).
- Connect the antenna properly (page 12).
- Find a place and an orientation that provide good reception, then set up the antenna again. If you can not obtain good reception, we recommend that you connect a commercially available external antenna.
- The supplied FM lead antenna receives signals along its entire length, so make sure you extend it fully.
- Locate the antennas as far away from the speaker cords as possible.
- Try turning off the surrounding electrical equipment.
- Set “CD POWER OFF” by CD power manage function (page 19).

A stereo FM program can not be received in stereo.

- Press FM MODE repeatedly until “MONO” disappears from the display.

Optional components

There is no sound.

- See general item “There is no sound.” (page 34) and check the condition of the system.
- Connect the component properly (page 11) while checking:
 - if the cords are connected properly.
 - if the cord plugs are firmly inserted all the way.
- Turn on the connected component.
- Refer to the operating instructions supplied with the connected component and start playing.

To reset the system to factory settings

If the system still does not operate properly after performing the above measures or other troubles not described above occur, reset the system as follows: Use the buttons on the unit for the operation.

- 1 Unplug the power cord.
- 2 Plug the power cord back in.
- 3 Press I/⏻ to turn on the system.
- 4 Press ►► (iPod), TUNING MODE and I/⏻ at the same time.
“COLD RESET” appears in the display.

The system is reset to the factory settings. You need to readjust all the settings you made, such as the preset stations, clock and timer.

Messages

One of the following messages may appear or flash in the display during operation.

No Disc

There is no disc on the disc tray or you have loaded a disc that can not be played back on this system.

Not in Use

You have pressed a button those operation is not allowed or invalid at that time.

OFF TIME NG!

The on time and off time of Play Timer is the same.

PUSH SELECT!

You tried to set the clock or timer during timer operation.

Push STOP!

You have pressed PLAY MODE during playback.

Reading

The system is reading information of the disc. Some buttons are not available.

NO STEP

You have cleared all the steps you programmed.

OVER

You have reached the end of the disc while pressing ►► during playback or pause.

Step Full!

You tried to program more than 25 steps.

Precautions

Discs that this system CAN play

- AUDIO CD
- CD-R/CD-RW (audio data/MP3 files)

Discs that this system CAN NOT play

- CD-ROM
- CD-R/CD-RW other than those recorded in music CD format or MP3 format conforming to ISO9660 Level 1/Level 2, Joliet
- CD-R/CD-RW recorded in multisession that have not ended by "closing the session"
- CD-R/CD-RW of poor recording quality, CD-R/CD-RW that have scratches or are dirty, or CD-R/CD-RW recorded with an incompatible recording device
- CD-R/CD-RW which is finalized incorrectly
- Disc containing files other than MPEG 1 Audio Layer-3 (MP3) files
- Discs of non-standard shape (for example, heart, square, star)
- Discs that have adhesive tape, paper, or sticker attached to them
- Rental or used discs with attached seals where the glue extends beyond the seal
- Discs that have labels printed using ink that feels tacky when touched

Notes on discs

- Before playing, wipe the disc with a cleaning cloth from the center out to the edge.
- Do not clean discs with solvents, such as benzene, thinner, or commercially available cleaners or anti-static spray intended for vinyl LPs.
- Do not expose discs to direct sunlight or heat sources such as hot air ducts, nor leave it in a car parked in direct sunlight.

On safety

- Completely disconnect the power cord (mains lead) from the wall socket (mains) if it is not going to be used for an extended period of time. When unplugging the unit, always grip the plug. Never pull the cord itself.
- Should any solid object or liquid get into the system, unplug the system, and have it checked by qualified personnel before operating it again.

- One blade of the plug is wider than other for the purpose of safety and will fit to the wall outlet only one way. If you are unable to insert the plug fully into the outlet, contact your dealer.
- The AC power cord can be changed only by a qualified service facility.

On placement

- Do not place the system in an inclined position or in locations that are extremely hot, cold, dusty, dirty, or humid or lacking adequate ventilation, or subject to vibration, direct sunlight or a bright light.
- Be careful when placing the unit or speakers on surfaces that have been specially treated (for example, with wax, oil, polish) as staining or discoloration of the surface may result.
- If the system is brought directly from a cold to a warm location or is placed in a very damp room, moisture may condense on the lens inside the unit, and cause the system to malfunction. In this situation, remove the disc, and leave the system turned on for about an hour until the moisture evaporates.

On heat buildup

- Heat buildup on the unit during operation is normal and is not a cause for alarm.
- Do not touch the cabinet if it has been used continuously at a high volume because the cabinet may have become hot.
- Do not obstruct the ventilation holes.

On the speaker system

This speaker system is not magnetically shielded, and the picture on nearby TV sets may become magnetically distorted. In this situation, turn off the TV, wait 15 to 30 minutes, and turn it back on. If there is no improvement, move the speakers far away from the TV.

Cleaning the cabinet

Clean this system with a soft cloth slightly moistened with a mild detergent solution. Do not use any type of abrasive pad, scouring powder, or solvent, such as thinner, benzene, or alcohol.

Specifications

AUDIO POWER SPECIFICATIONS

POWER OUTPUT AND TOTAL HARMONIC DISTORTION:

LBT-ZX99i USA model only

With 6-ohm loads, both channels driven, from 120 Hz – 10 kHz; rates 200 watts per channel minimum RMS power, with no more than 0.7% total harmonic distortion from 250 miliwatts to rated output.

LBT-ZX66i USA model only

With 6-ohm loads, per channel driven, from 120 Hz – 10 kHz; rates 220 watts per channel minimum RMS power, with no more than 0.7% total harmonic distortion from 250 miliwatts to rated output.

Amplifier section

LBT-ZX99i (HCD-ZX99i)

The following are measured at
AC 120 V, 60 Hz

Front/Surround speaker

Power output (rated):

270 W + 270 W (at 6 Ω , 1 kHz,
10% THD)

RMS output power (reference):

180 W \times 2 + 180 W \times 2 (6 Ω at 1 kHz,
10% THD)

LBT-ZX66i (HCD-ZX66i)

The following are measured at
AC 120 V, 60 Hz

Front speaker

Power output (rated):

280 W (at 6 Ω , 1 kHz, 10% THD)

RMS output power (reference):

210 W \times 2 (6 Ω at 1 kHz, 10% THD)

Inputs

PHONO IN L/R:

Sensitivity 3 mV, impedance
47 kilohms

MIC 1/MIC 2:

Sensitivity 1 mV, impedance
10 kilohms

GAME INPUT AUDIO L/R:

Sensitivity 250 mV, impedance
47 kilohms

GAME INPUT VIDEO:

1 Vp-p, 75 Ω

PC IN L/R:

Sensitivity 250 mV, impedance
47 kilohms

Outputs

PHONES:

accepts headphones of 8 Ω or more

VIDEO OUT:

max. output level 1 Vp-p, load
impedance 75 ohms

Disc player section

System

Compact disc and digital audio system

Laser

Semiconductor laser

(λ = 780 nm)

Emission duration: continuous

Laser Output

Max. 44.6 μ W*

* This output is the value measured at a distance of 200 mm from the objective lens surface on the Optical Pick-up Block with 7 mm aperture.

Frequency response

2 Hz – 20 kHz (\pm 1.0 dB)

Wave length

780 – 790 nm

Signal-to-noise ratio

More than 90 dB

Dynamic range

More than 90 dB

CD DIGITAL OUT OPTICAL:

Wave length 660 nm, output level
–18 dBm

Continued 

Tuner section

FM stereo, FM/AM superheterodyne tuner

FM tuner section

Tuning range

87.5 – 108.0 MHz (100 kHz step)

Antenna

FM lead antenna

Antenna terminals

75 ohms unbalanced

Intermediate frequency

10.7 MHz

AM tuner section

Tuning range

530 – 1,710 kHz (with the interval set at 10 kHz)

531 – 1,710 kHz (with the interval set at 9 kHz)

Antenna

AM loop antenna

Antenna terminals

External antenna terminal

Intermediate frequency

450 kHz

iPod section

DC5V 500 mA MAX

Speakers

For LBT-ZX99i

Front/Surround speaker (SS-ZX99i)

Speaker system

2-way, Bass reflex

Speaker unit

Woofers: 220 mm (8 ³/₄ inches), cone type

Tweeter: 50 mm (2 inch), cone type × 2

Rated impedance

6 ohms

Dimensions (w/h/d)

Approx. 308 × 365 × 480 mm

(12 ¹/₄ × 14 ³/₈ × 19 inches)

Mass

Approx. 8.7 kg (19 lb 3 oz) net per speaker

For LBT-ZX66i

Front speaker (SS-ZX66i)

Speaker system

3-way BUILT-IN SW, Bass reflex

Speaker unit

Super Woofer/Woofers: 170 mm

(6 ³/₄ inches)/170 mm (6 ³/₄ inches), cone type

Tweeter: 25 mm (1 inch), horn type

Rated impedance

6 ohms

Dimensions (w/h/d)

Approx. 250 × 530 × 362 mm

(9 ⁷/₈ × 20 ⁷/₈ × 14 ³/₈ inches)

Mass

Approx. 9.5 kg (20 lb 16 oz) net per speaker

General

Power requirements

120 V AC, 60 Hz

Power consumption

LBT-ZX99i (American model):

400 W

LBT-ZX66i (American model):

230 W

LBT-ZX66i (Canadian model):

240 VA

Dimensions (w/h/d) (Approx.)

HCD-ZX99i/HCD-ZX66i

361.4 × 435.5 × 454.6 mm

(14 1/4 × 17 1/4 × 18 inches)

Mass (Approx.)

HCD-ZX99i: 19.0 kg (41 lb 15 oz)

HCD-ZX66i: 14.6 kg (32 lb 4 oz)

Supplied accessories

Remote Commander (1)

R6 (size AA) batteries (2)

AM loop antenna (1)

FM lead antenna (1)

Speaker pads:

- LBT-ZX99i only (16)

- LBT-ZX66i only (8)

Speaker cords:

- LBT-ZX99i only

- grey (10 m) (39 3/8 ft) (2)

- white (3 m) (11 7/8 ft) (2)

- LBT-ZX66i only

- 3 m (11 7/8 ft) (2)

Design and specifications are subject to change without notice.

- Standby power consumption: 0.5 W
- Halogenated flame retardants are not used in the certain printed wiring boards.

Compatible iPod models with this system

You can use the following iPod models on this system. Update your iPod with the latest software before using it.



iPod touch
2nd generation



iPod nano
4th generation
(video)



iPod touch
1st generation



iPod nano
3rd generation
(video)



iPod classic



iPod nano
2nd generation
(aluminum)



iPod
5th generation
(video)



iPod nano
1st generation



iPod
4th generation
(color display)



iPod
4th generation



iPod mini

Notes

- This unit is designed for iPod only. You can not connect any other portable audio players.
- Sony can not accept responsibility in the event that data recorded to iPod is lost or damaged when using an iPod connected to this unit.
- Use a Dock Adapter supplied with your iPod. Otherwise, a compatible Dock Adapter will need to be purchased separately from Apple Inc.
- This product has been designed specifically to work with iPod and has been certified to meet Apple performance standards.
- This unit is not compatible with iPhone.

Index

B

Batteries 13

C

CD power manage function 19

COLD RESET 37

Compatible iPod models with
this system 42

D

Demonstration 13, 27

Display 10

Display mode 27

F

FM MODE 20

G

Game Mixing 26

Game Sync 25

H

Handling discs 38

Hooking up the system 11

I

iPod

Playing 20

Using 13

M

MP3 BOOSTER 23

Multi Session 4

N

Non-playable disc 38

Normal Play 18

P

Play mode 18

Playable disc 38

Power Saving Mode 27

Preset effect 22

Presetting radio station 30

Program Play 29

R

Radio station 19

Remote 7

Repeat Play 17

S

Shuffle Play 18

SOUND FLASH 24

T

Timer

Play Timer 32

Sleep Timer 32

U

User equalizer 31

X

X-ROUND 23



* 4 1 2 8 3 0 4 1 1 * (2)

Free Manuals Download Website

<http://myh66.com>

<http://usermanuals.us>

<http://www.somanuals.com>

<http://www.4manuals.cc>

<http://www.manual-lib.com>

<http://www.404manual.com>

<http://www.luxmanual.com>

<http://aubethermostatmanual.com>

Golf course search by state

<http://golfingnear.com>

Email search by domain

<http://emailbydomain.com>

Auto manuals search

<http://auto.somanuals.com>

TV manuals search

<http://tv.somanuals.com>