

HOME AUDIO SYSTEM

Operating Instructions

Getting Started

Disc/USB Playback

USB Transfer

Tuner

Bluetooth

Sound Adjustment

Other Operations

Additional Information

WARNING

To reduce the risk of fire or electric shock, do not expose this apparatus to rain or moisture.

To reduce the risk of fire, do not cover the ventilation opening of the appliance with newspapers, tablecloths, curtains, etc.

Do not expose the appliance to naked flame sources (for example, lighted candles).

To reduce the risk of fire or electric shock, do not expose this appliance to dripping or splashing, and do not place objects filled with liquids, such as vases, on the appliance.

As the main plug is used to disconnect the unit from the mains, connect the unit to an easily accessible AC outlet. Should you notice an abnormality in the unit, disconnect the main plug from the AC outlet immediately.

Do not install the appliance in a confined space, such as a bookcase or built-in cabinet. Do not expose batteries or appliances with battery-installed to excessive heat, such as sunshine and fire.

The unit is not disconnected from the mains as long as it is connected to the AC outlet, even if the unit itself has been turned off.

This equipment has been tested and found to comply with the limits set out in the EMC Directive using a connection cable shorter than 3 meters.

CAUTION

The use of optical instruments with this product will increase eye hazard.



This appliance is classified as a CLASS 1 LASER product. This marking is located on the rear exterior.

When unpacking or handling a big and/or heavy speaker, be sure to handle the unit with two or more persons. Dropping the unit may cause personal injury and/or property damage.

For customers in the United States

Owner's Record

The model and serial numbers are located on the rear of the unit. Record these numbers in the space provided below. Refer to them whenever you call upon your Sony dealer regarding this product.

Model No. _____

Serial No. _____



This symbol is intended to alert the user to the presence of uninsulated "dangerous voltage" within the product's enclosure that may be of sufficient magnitude to constitute a risk of electric shock to persons.



This symbol is intended to alert the user to the presence of important operating and maintenance (servicing) instructions in the literature accompanying the appliance.

Important Safety Instructions

- 1) Read these instructions.
- 2) Keep these instructions.
- 3) Heed all warnings.
- 4) Follow all instructions.
- 5) Do not use this apparatus near water.
- 6) Clean only with dry cloth.

- 7) Do not block any ventilation openings. Install in accordance with the manufacturer's instructions.
- 8) Do not install near any heat sources such as radiators, heat registers, stoves, or other apparatus (including amplifiers) that produce heat.
- 9) Do not defeat the safety purpose of the polarized or grounding-type plug. A polarized plug has two blades with one wider than the other. A grounding type plug has two blades and a third grounding prong. The wide blade or the third prong are provided for your safety. If the provided plug does not fit into your outlet, consult an electrician for replacement of the obsolete outlet.
- 10) Protect the power cord from being walked on or pinched particularly at plugs, convenience receptacles, and the point where they exit from the apparatus.
- 11) Only use attachments/accessories specified by the manufacturer.
- 12) Use only with the cart, stand, tripod, bracket, or table specified by the manufacturer, or sold with the apparatus. When a cart is used, use caution when moving the cart/apparatus combination to avoid injury from tip-over.



- 13) Unplug this apparatus during lightning storms or when unused for long periods of time.
- 14) Refer all servicing to qualified service personnel. Servicing is required when the apparatus has been damaged in any way, such as power-supply cord or plug is damaged, liquid has been spilled or objects have fallen into the apparatus, the apparatus has been exposed to rain or moisture, does not operate normally, or has been dropped.

The following FCC statement applies only to the version of this model manufactured for sale in the U.S.A. Other versions may not comply with FCC technical regulations.

NOTE:

This equipment has been tested and found to comply with the limits for a Class B digital device, pursuant to Part 15 of the FCC Rules. These limits are designed to provide reasonable protection against harmful interference in a residential installation. This equipment generates, uses and can radiate radio frequency energy and, if not installed and used in accordance with the instructions, may cause harmful interference to radio communications. However, there is no guarantee that interference will not occur in a particular installation. If this equipment does cause harmful interference to radio or television reception, which can be determined by turning the equipment off and on, the user is encouraged to try to correct the interference by one or more of the following measures:

- Reorient or relocate the receiving antenna.
- Increase the separation between the equipment and receiver.
- Connect the equipment into an outlet on a circuit different from that to which the receiver is connected.
- Consult the dealer or an experienced radio/TV technician for help.

CAUTION

You are cautioned that any changes or modifications not expressly approved in this manual could void your authority to operate this equipment.

Properly shielded and grounded cables and connectors must be used for connection to host computers and/or peripherals in order to meet FCC emission limits.

This equipment must not be co-located or operated in conjunction with any other antenna or transmitter.

This equipment complies with FCC radiation exposure limits set forth for an uncontrolled environment and meets the FCC radio frequency (RF) Exposure Guidelines in Supplement C to OET65. This equipment has very low levels of RF energy that it deemed to comply without maximum permissive exposure evaluation (MPE). But it is desirable that it should be installed and operated keeping the radiator at least 20 cm or more away from person's body (excluding extremities: hands, wrists, feet and ankles).

For customers in Europe



Disposal of Old Electrical & Electronic Equipment (Applicable in the European Union and other European countries with separate collection systems)

This symbol on the product or on its packaging indicates that this product shall not be treated as household waste. Instead it shall be handed over to the applicable collection point for the recycling of electrical and electronic equipment. By ensuring this product is disposed of correctly, you will help prevent potential negative consequences for the environment and human health, which could otherwise be

caused by inappropriate waste handling of this product. The recycling of materials will help to conserve natural resources. For more detailed information about recycling of this product, please contact your local Civic Office, your household waste disposal service or the shop where you purchased the product.



Disposal of waste batteries (applicable in the European Union and other European countries with separate collection systems)

This symbol on the battery or on the packaging indicates that the battery provided with this product shall not be treated as household waste.

On certain batteries this symbol might be used in combination with a chemical symbol. The chemical symbols for mercury (Hg) or lead (Pb) are added if the battery contains more than 0.0005% mercury or 0.004% lead. By ensuring these batteries are disposed of correctly, you will help prevent potentially negative consequences for the environment and human health which could otherwise be caused by inappropriate waste handling of the battery. The recycling of the materials will help to conserve natural resources. In case of products that for safety, performance or data integrity reasons require a permanent connection with an incorporated battery, this battery should be replaced by qualified service staff only.

To ensure that the battery will be treated properly, hand over the product at end-of-life to the applicable collection point for the recycling of electrical and electronic equipment.

For all other batteries, please view the section on how to remove the battery from the product safely. Hand the battery over to the applicable collection point for the recycling of waste batteries.

For more detailed information about recycling of this product or battery, please contact your local Civic Office, your household waste disposal service or the shop where you purchased the product.

Notice for customers: The following information is only applicable to equipment sold in countries applying EU Directives.

This product has been manufactured by or on behalf of Sony Corporation, 1-7-1 Konan Minato-ku Tokyo, 108-0075 Japan. Inquiries related to product compliance based on European Union legislation shall be addressed to the authorized representative, Sony Deutschland GmbH, Hedelfinger Strasse 61, 70327 Stuttgart, Germany. For any service or guarantee matters, please refer to the addresses provided in the separate service or guarantee documents.

Hereby, Sony Corp., declares that this equipment is in compliance with the essential requirements and other relevant provisions of Directive 1999/5/EC. For details, please access the following URL:

<http://www.compliance.sony.de/>



For customers in Australia



Disposal of Old Electrical & Electronic Equipment (Applicable in the European Union and other European countries with separate collection systems)

License and Trademark Notice

- “WALKMAN” and “WALKMAN” logo are registered trademarks of Sony Corporation.
- MPEG Layer-3 audio coding technology and patents licensed from Fraunhofer IIS and Thomson.
- Windows Media is either a registered trademark or trademark of Microsoft Corporation in the United States and/or other countries.
- This product is protected by certain intellectual property rights of Microsoft Corporation. Use or distribution of such technology outside of this product is prohibited without a license from Microsoft or an authorized Microsoft subsidiary.
- The *Bluetooth*® word mark and logos are registered trademarks owned by Bluetooth SIG, Inc. and any use of such marks by Sony Corporation is under license. Other trademarks and trade names are those of their respective owners.
- The N Mark is a trademark or registered trademark of NFC Forum, Inc. in the United States and in other countries.
- Android is a trademark of Google Inc.
- All other trademarks and registered trademarks are of their respective holders. In this manual, ™ and ® marks are not specified.

Table of Contents

Guide to parts and controls..... 7

Getting Started

Hooking up the system
securely..... 10
Positioning the speakers 12
Setting the clock 12

Disc/USB Playback

Playing a disc..... 12
Before using the USB device
with this system 13
Playing a USB device..... 13
Searching a track or audio file
(Track Search) 14
Using play mode..... 14

USB Transfer

Transferring music..... 16

Tuner

Listening to the radio..... 19

Bluetooth

About the *Bluetooth* wireless
technology 20
Listening to music wirelessly on
a *Bluetooth* device 20
Setting the *Bluetooth* audio
codecs 23
Setting/Canceling *Bluetooth*
standby mode..... 24

Sound Adjustment

Adjusting the sound 24
Creating your own sound
effect 25
Creating a party atmosphere
(DJ EFFECT)..... 25

Other Operations

Singing along..... 26
Changing the illumination
pattern and color 26
Using the timers..... 26
Changing the display 27
Using optional equipment..... 28
Deactivating the buttons on the
unit (Child Lock) 28
Setting/Canceling the automatic
standby function
(For European model only)..... 29

Additional Information

Playable discs 29
Websites for compatible
devices 30
Troubleshooting..... 30
Messages..... 35
Precautions..... 36
Specifications..... 37

Guide to parts and controls

This manual mainly explains operations using the remote control, but the same operations can also be performed using the buttons on the unit having the same or similar names.

Unit

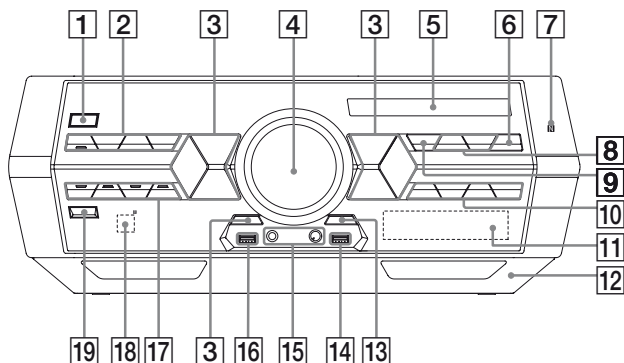

Remote control RM-AMU163

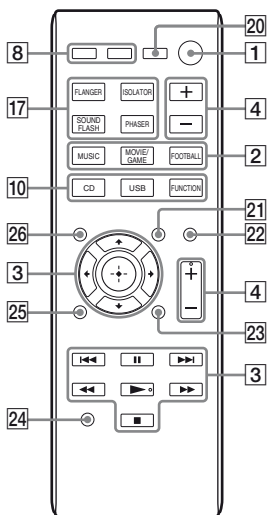

1 I/⏻ (on/standby)

Turn on the system, or set it to standby mode.

2 MUSIC, MOVIE/GAME, FOOTBALL

Select the preset sound effect (page 24).

Unit: BASS BAZUCA (page 24)

Press to select the BASS BAZUCA effect.

Hold down to select the BASS CUT effect.

3 ↕/➔/⏪/➔

Select the menu items.

 +/- (select folder)

Select a folder on an MP3 disc or a USB device.

⏮/⏭ (rewind/fast forward)

Hold down to find a point in a track or file during playback.

⏮/⏭ (go back/go forward)

Select a track or file.

TUNING+/-

Tune to the station you want.

■ (stop)

Stop playback.

Press twice to cancel resume playback of the USB device.

Unit: ENTER

Remote control: 

Enter the settings.

Unit: ▶|| (play/pause)

Remote control: ▶ (play)*, || (pause)

Start or pause playback.

To resume playback, press ▶|| or ▶.

4 **Unit: VOLUME/DJ CONTROL**

Adjust the volume.

Adjust the DJ EFFECT level (page 25).

You cannot use this knob to adjust the volume when the DJ EFFECT is activated.

Remote control: VOLUME +/-*

Adjust the volume.

Remote control: DJ CONTROL +/-

Adjust the DJ EFFECT level.

5 **Disc tray**

6  **OPEN/CLOSE**

Insert or eject a disc.

7  **(N-Mark) (page 21)**

Near Field Communication (NFC) touchpoint indication.

8 **LED PATTERN (page 26)**

Change the illumination pattern on the speakers and the unit.

LED COLOR (page 26)

Change the illumination color on the speakers and the unit.

9 **OPTIONS**

Enter or exit options menu.



10 **CD**

Select the CD function.

Unit: USB/USB SELECT

Remote control: USB

Select the USB function.

Select the USB device connected to the  A or  B port during USB function.

Unit: TUNER/BAND

Select the TUNER function.

Select the FM or AM band during TUNER function.

Unit: AUDIO IN

Select the TV/DVD/SAT or PC/
GAME function.

Remote control: FUNCTION

Select a function.

11 Display panel

12 Bottom panel (page 11)

13 REC TO USB B

Transfer onto the optional USB
device which is connected to the ψ B
port.

14 ψ B (REC/PLAY) (USB) port

Connect and transfer to an optional
USB device.

15 MIC jack

Connect a microphone.

MIC LEVEL (MIN/MAX)

Adjust the microphone volume.

16 ψ A (PLAY) (USB) port

Connect an optional USB device.

17 FLANGER, ISOLATOR, SOUND FLASH, PHASER (page 25)

Select the DJ EFFECT type.

18 Remote control sensor

19 BLUETOOTH (page 20, 22)

Press to select *Bluetooth* function.
Hold down to activate *Bluetooth*
pairing during *Bluetooth* function.

20 SLEEP (page 26)

Set the Sleep Timer.

21 REPEAT/FM MODE

Listen to a disc, a USB device, a
single track or file repeatedly
(page 15).
Select the FM reception mode
(monaural or stereo) (page 19).

22 DISPLAY

Change the information on the display
panel.

23 SEARCH/TUNER MEMORY

Enter or exit search mode.
Preset the radio station (page 19).

24 CLEAR

Delete the last step from the program
list.

25 TIMER MENU (page 12, 26)

Set the clock and the timers.

26 PLAY MODE/TUNING MODE

Select the play mode of an AUDIO
CD, MP3 disc or a USB device
(page 14).

Select the tuning mode (page 19).

* The VOLUME + and ► buttons have a
tactile dot. Use the tactile dot as a
reference when operating the system.

Hooking up the system securely

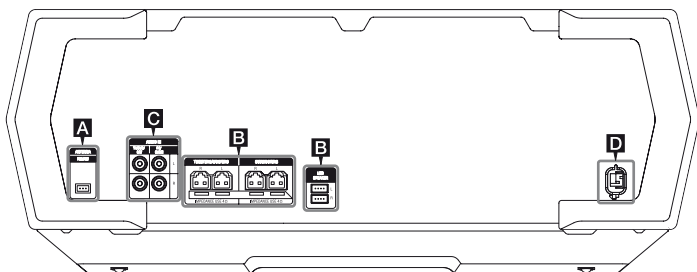

A Antennas

Find a location and an orientation that provide good reception when you set up the antennas.

Keep the antennas away from the speaker cords, the power cord and the USB cable to avoid picking up noise.

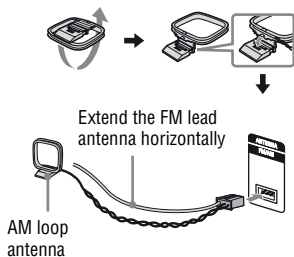

B Speakers

– TWEETERS/WOOFERS and SUBWOOFERS terminals

The speaker connectors are color-coded with their respective speaker terminals on the unit.

Example:

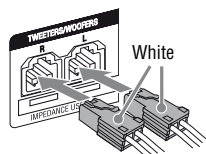

Notes

- Be sure to use only the supplied speakers.
- When connecting speaker cords, insert the connector straight into the terminals.

– LED SPEAKER terminals

Connect the LED SPEAKER connector of the speaker to this terminal.

The lighting on the speakers will react according to the music source. You can select the illumination pattern and color according to your preference (page 26).

Example:



C AUDIO IN jacks

Use an audio cord (not supplied) to connect to the audio output jacks of the following equipment. The sound is output through this system.

– TV/DVD/SAT L/R

Connect to a TV or an audio/video equipment.

– PC/GAME L/R

Connect to a computer or gaming device.

D Power

Plug the power cord into a wall socket. The demonstration appears in the display panel. Press **I/⏻** to turn on the system and the demonstration automatically ends. If the supplied adaptor on the plug does not fit your wall outlet, detach it from the plug (only for models equipped with an adaptor).

Inserting batteries

Insert the two supplied R6 (size AA) batteries, matching the polarities shown below.

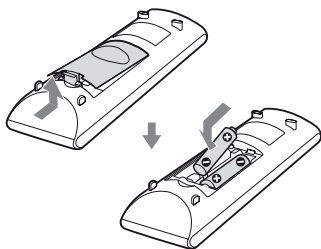
**Notes**

- Do not mix an old battery with a new one or mix different types of batteries.
- If you do not use the remote control for a long period of time, remove the batteries to avoid damage from battery leakage and corrosion.

Attaching the bottom panel

You can attach the supplied bottom panel to the bottom of the main unit to raise the front panel and to ease the operations.

- 1 Insert the hooks of the bottom panel to the catcher holes on the bottom of the main unit.**

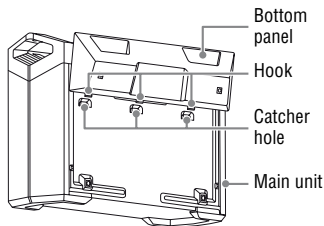

- 2 Insert the pins of the bottom panel to the catcher holes. Then, push the bottom panel until it locks into the main unit.**

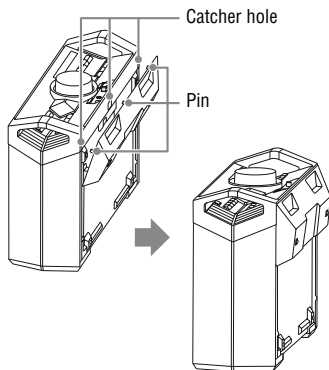

Positioning the speakers

To obtain optimum performance from the system, we recommend you to place the speakers as shown below.

- (A) Unit
- (B) Speaker (left)
- (C) Speaker (right)

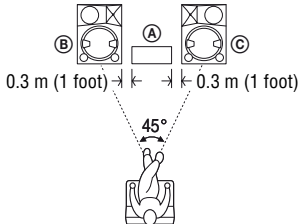

Setting the clock

You cannot set the clock in Power Saving Mode.

- 1** Press **I/⏻** to turn on the system.
- 2** Press **TIMER MENU**.
If "PLAY SET" appears in the display panel, press **↑/↓** repeatedly to select "CLOCK SET", then press **⊕**.
- 3** Press **↑/↓** repeatedly to set the hour, then press **⊕**.
- 4** Press **↑/↓** repeatedly to set the minutes, then press **⊕**.

Disc/USB Playback

Playing a disc

- 1** Press **CD**.
- 2** Press **⏪ OPEN/CLOSE** on the unit.
- 3** Load a disc with the label side facing up on the disc tray.

When you play back an 8 cm disc such as a CD single, place it on the inner circle of the tray

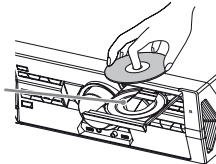

- 4** Press **⏪ OPEN/CLOSE** on the unit to close the disc tray.

Do not forcibly push the disc tray to close it as this may cause a malfunction.

- 5** Press **▶** to start playback.

Before using the USB device with this system

Check the websites for the information about compatible USB devices (page 30).

To select the playback source or transferring destination (USB memory select)

If the USB device has more than one memory (for example, internal memory and a memory card), you can select which memory to use as a playback source or transferring destination.

Use the buttons on the unit to perform this operation.

Note

You cannot select a memory during playback or transfer. Make sure to select a memory before starting playback or transfer.

- 1 Press **USB/USB SELECT** repeatedly until “USB A” or “USB B” lights up in the display panel.
- 2 Connect the USB device to the ψ A or ψ B port.
- 3 Press **OPTIONS** when playback is stopped.
- 4 Press \uparrow/\downarrow to select “USB MEM SEL”, then press **ENTER**.
- 5 Press \uparrow/\downarrow to select the memory you want, then press **ENTER**.

Playing a USB device

The audio formats that can be played back by this system are as follows:

- MP3: file extension “.mp3”
- WMA: file extension “.wma”
- AAC: file extension “.m4a”, “.mp4” or “.3gp”

If the audio files have the above file extension but are not the respective formats, the system may produce noise or may malfunction.

- 1 Press **USB** repeatedly until “USB A” or “USB B” lights up in the display panel.
- 2 Connect a USB device to the ψ A or ψ B port.

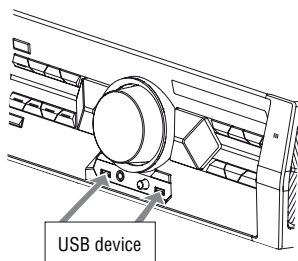

Note

You can use a USB adaptor (not supplied) to connect the USB device to the unit if the USB device cannot be plugged into the ψ port.

- 3 Press **▶**.

The audio files are played back in different orders depending on the play mode.

Searching a track or audio file

(Track Search)

1 Press SEARCH.

“SEARCH” lights up in the display panel.

2 (Audio files only)

Press \uparrow/\downarrow to select the folder you want, then press \odot or \blacktriangleright .

3 Press \uparrow/\downarrow to select the track or audio file you want, then press

\odot or \blacktriangleright .

The selected track or audio file starts playback.

Notes on disc

- (For AUDIO CD) This system can recognize up to 99 tracks.
- (For MP3 discs) This system can recognize up to
 - 999 folders (including root folder).
 - 999 MP3 files.
 - 250 MP3 files in a folder.
 - 8 folders levels (tree structure of files).
- CD-TEXT information is not supported.

Notes on USB device

- This system can recognize up to
 - 250 audio files in a folder.
 - 3,000 audio files in a USB device.
 - 1,000 folders in a USB device (including root folder).

Using play mode

Playing in original order (Normal Play)

Press PLAY MODE repeatedly when playback is stopped.

When playing a disc

- (blank): play a disc
- FLDR*: play all audio files in the folder on the disc

* When playing an AUDIO CD, “FLDR” performs the same operation as “(blank)” play mode.

When playing a USB device

- ALL USB: play all USB devices
- 1 USB: play a USB device
- FLDR: play all audio files in the folder on the USB device

Playing in random order (Shuffle Play)

Press PLAY MODE repeatedly when playback is stopped.

When playing a disc

- SHUF: shuffle a disc
- FLDR SHUF*: shuffle all audio files in the folder on the disc

* When playing an AUDIO CD, “FLDR SHUF” performs the same operation as “SHUF” play mode.

When playing a USB device

- ALL USB SHUF: shuffle all USB devices
- 1 USB SHUF: shuffle a USB device
- FLDR SHUF: shuffle all audio files in the folder on the USB device

Note

When you turn off the system, the selected Shuffle Play is cleared and the play mode returns to Normal Play.

Creating your own program (Program Play)

You can make a program of up to 25 steps in the order you want them to be played back.

1 For CD function:

Press CD to select CD function.

For USB function:

Press USB repeatedly to select the USB device you want.

2 When playback is stopped, press PLAY MODE repeatedly until "PGM" lights up in the display panel.

3 (Audio files only)

Press +/- repeatedly to select a folder.

If you want to program all files in the folder, press .

4 Press repeatedly to select the track or audio file you want, then press .

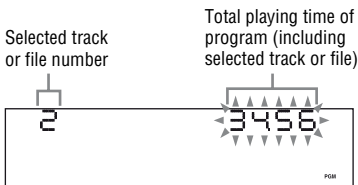

"--.--" appears when the total playing time exceeds 100 minutes for an AUDIO CD or when you program an audio file.

5 Repeat steps 3 to 4 to program additional tracks or audio files.

6 Press to start Program Play.

To delete the last step from the program list

Press CLEAR when playback is stopped.

To cancel Program Play

When playback is stopped, press PLAY MODE repeatedly until "PGM" disappear from the display panel.

Notes

- (CD function only) The program list is cleared when you open the disc tray.
- (USB function only) The program list is cleared when you:
 - perform the erase operation.
 - remove the USB device.
 - switch the USB memory select.

Playing repeatedly (Repeat Play)

Press REPEAT repeatedly.

- : repeat all tracks or audio files on a folder/disc/USB device
- 1 : repeat a track or audio file

Notes on the USB device

- The playback order for the system may differ from the playback order of the connected digital music player.
- You cannot erase audio files and folders in Shuffle Play or Program Play.

Transferring music

You can transfer music from a sound source to a USB device connected to the Ψ B port.

The audio format of files transferred by this system is MP3. However, you can also transfer WMA and AAC files from USB A.

Notes

- Do not remove the USB device during transfer or erase operations. Doing so may corrupt the data on the USB device or damage the USB device itself.
- MP3/WMA/AAC files are transferred with the same bit rate as the original files.
- When transferring from an AUDIO CD, TUNER, TV/DVD/SAT or PC/GAME function, you may select the bit rate before transferring.
- USB transfer and erase operations are disabled while the disc tray is open.

Note on copyright-protected content

The transferred music is limited to private use only. Use of the music beyond this limit requires permission of the copyright holders.

To select the playback source or transferring destination (USB memory select)

See page 13.

To select the bit rate

You can select a higher bit rate to transfer music with better quality. Use the buttons on the unit to perform this operation.

1 Press **OPTIONS**.

2 Press \uparrow/\downarrow repeatedly to select “REC BIT RATE”, then press **ENTER**.

3 Press \uparrow/\downarrow repeatedly to select the bit rate you want, then press **ENTER**.

- 128 KBPS: encoded MP3 tracks have smaller file size and lower audio quality.
- 256 KBPS: encoded MP3 tracks have bigger file size but higher audio quality.

Transferring music from a disc or USB device

You can easily transfer all the music on a disc or USB A to USB B (Synchronized Transfer). You can also transfer a single track or audio file during playback (REC1 Transfer).

Use the buttons on the unit to perform this operation.

1 Connect a transferable USB device to the Ψ B port as shown below.

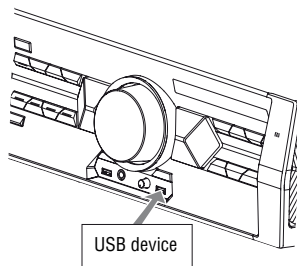

Note

You can use a USB adaptor (not supplied) to connect the USB device to the unit if the USB device cannot be plugged into the Ψ port.

2 For disc:

Press CD and then load the disc.

For USB:

Press USB/USB SELECT repeatedly until "USB A" lights up in the display panel and then connect a USB device you want to transfer to ψ A port.

3 For Synchronized Transfer:

When playback is stopped, press PLAY MODE on the remote control repeatedly to select the play mode you want.

Notes

- If you start transferring in Shuffle Play ("FLDR SHUF"), the selected play mode changes to "FLDR" automatically.
- If you start transferring in Shuffle Play (except "FLDR SHUF"), Repeat Play or Program Play with no steps, the selected play mode changes to Normal Play automatically.

For REC1 Transfer:

Select the track or audio file you want to transfer then start playback.

4 Press REC TO USB B.

"PUSH ENTER" appears in the display panel.

5 Press ENTER.

The transfer starts when "DON'T REMOVE" appears in the display panel.

For Synchronized Transfer:

When the transfer is completed, the transfer source and the USB device stop automatically.

For REC1 Transfer:

When the transfer is completed, the disc or the USB device continues to play.

Transferring analog audio (Analog Transfer)

You can transfer sound from an analog audio source (other than CD, USB or Bluetooth function) to a USB device. Use the buttons on the unit to perform this operation.

1 Connect a transferable USB device to the ψ B port (page 16).

2 Press TUNER/BAND or AUDIO IN repeatedly to select the source you want to transfer.

3 Press REC TO USB B.

"PUSH ENTER" appears in the display panel.

4 Press ENTER.

The transfer starts when "DON'T REMOVE" appears in the display panel.

5 Start playback the source.

To stop transferring

Press \blacksquare .

To create a new MP3 file

Press REC TO USB B during Analog Transfer.

"NEW TRACK" appears in the display panel.

A new MP3 is also created automatically after approximately 1 hour of transfer.

Notes

- When a new MP3 file is created, transfer is disabled for the time being.
- If you press REC TO USB B again after a few seconds, a new MP3 file can be created.

Erasing audio files or folders from the USB device

Use the buttons on the unit to perform this operation.

1 Press **USB/USB SELECT** repeatedly until **“USB A”** or **“USB B”** lights up in the display panel when playback is stopped.

2 Press **◀◀/▶▶** or **☐ +/-** repeatedly to select the audio file or folder.

3 Press **OPTIONS**.

4 Press **↑/↓** to select **“USB ERASE”**, then press **ENTER**.
“FOLDER ERASE” or “TRACK ERASE” appears in the display panel.

5 Press **ENTER**.
“COMPLETE” appears in the display panel.

Folder and file generation rules

When transferring onto a USB device, a “MUSIC” folder is created directly below the “ROOT”. Folders and files are generated within this “MUSIC” folder as follows according to the transferring method and source.

Synchronized Transfer

Source	Folder name	File name
Audio files	Same as the source	
AUDIO CD	“CDDA0001”*	“TRACK001”*

REC1 Transfer

Source	Folder name	File name
Audio files	“REC1-MP3”	Same as the source
AUDIO CD	“REC1-CD”	“TRACK001”*

Analog Transfer

Source	Folder name	File name
FM	“TUFM0001”*	“TRACK001”*
AM	“TUAM0001”*	
TV/DVD/ SAT	“EXTD0001”*	
PC/GAME	“EXPG0001”*	

* Folder and file numbers are assigned serially thereafter.

Notes on transferring

- While transferring (except analog transfer), no sound is output.
- CD-TEXT information is not transferred in the created MP3 files.
- The transfer stops automatically if:
 - the USB device runs out of space during transfer.
 - the number of audio files and folders on the USB device reaches the limit.
- If a folder or file that you are trying to transfer already exists on the USB device with the same name, a sequential number is added after the name without overwriting the original folder or file.
- You cannot perform the following operations during transfer:
 - Eject the disc.
 - Select another track or file.
 - Pause playback or find a point in the track or file.
 - Change the function or tuner band.
- When transferring music to a Walkman® using “Media Manager for WALKMAN”, be sure to transfer in MP3 format.
- When connecting a Walkman® to the system, be sure to connect after the display “Creating Library” or “Creating Database” on the Walkman® has disappeared.

Listening to the radio

1 Press **FUNCTION** repeatedly to select **FM** or **AM** band.

2 For automatic scanning:

Press **TUNING MODE** repeatedly until “**AUTO**” lights up in the display panel. Then, press **TUNING+/-**. Scanning stops automatically when a station is tuned in. “**TUNED**” and “**ST**” (for FM stereo programs only) light up in the display panel. If “**TUNED**” does not light up and scanning does not stop, press **■** to stop scanning. Then, perform manual tuning (below).

For manual tuning:

Press **TUNING MODE** repeatedly until “**AUTO**” and “**PRESET**” disappear from the display panel. Then, press **TUNING+/-** repeatedly to tune to the station you want.

Note

When you tune to an FM station that provides RDS services, information such as the service name or station name is provided by broadcasts. You can check the RDS information by pressing **DISPLAY** repeatedly.

Tip

To reduce static noise on a weak FM stereo station, press **FM MODE** repeatedly until “**MONO**” lights up in the display panel.

To change the AM tuning interval (Except for European model)

The default setting for AM tuning interval is 9 kHz (or 10 kHz for some areas). You cannot change the AM tuning interval in Power Saving Mode.

Use the buttons on the unit to perform this operation.

1 Press **TUNER/BAND** repeatedly to select **AM** band.

2 Press **I/⏻** to turn off the system.

3 While holding down **OPTIONS**, press **I/⏻**. “**AM 9K STEP**” or “**AM 10K STEP**” appears in the display panel. When you change the interval, all the **AM** preset stations are erased.

Presetting radio stations

You can store up to 20 **FM** and 10 **AM** stations as your favorite stations.

1 Tune to the station you want.

2 Press **TUNER MEMORY**.

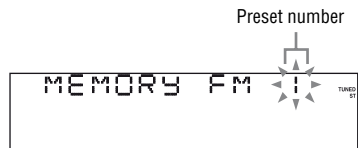

3 Press **TUNING+/-** repeatedly to select the preset number you want, then press **⊕**.

“**COMPLETE**” appears in the display panel. The station is stored.

To tune to a preset station

Press **TUNING MODE** repeatedly until “**PRESET**” lights up in the display panel. Then, press **TUNING+/-** repeatedly to select the preset number you want.

About the *Bluetooth* wireless technology

Bluetooth wireless technology is a short-range wireless technology that enables wireless data communication between digital devices. *Bluetooth* wireless technology operates within a range of about 10 meters (33 feet).

Supported *Bluetooth* version, profiles and codecs

Supported *Bluetooth* version:

- *Bluetooth* Standard version 3.0 + EDR (Enhanced Data Rate)

Supported *Bluetooth* profiles:

- A2DP (Advanced Audio Distribution Profile)
- AVRCP 1.3 (Audio Video Remote Control Profile)

Supported *Bluetooth* codecs:

- SBC (Sub Band Codec)
- AAC (Advanced Audio Coding)

Listening to music wirelessly on a *Bluetooth* device

You can listen to music from your *Bluetooth* device over a wireless connection.

Check the websites for the information about compatible *Bluetooth* devices (page 30).

About the BLUETOOTH indicator

The BLUETOOTH indicator lights up or flashes in blue to show the *Bluetooth* status.

System status	Indicator status
<i>Bluetooth</i> standby	Flashes slowly
<i>Bluetooth</i> pairing	Flashes quickly
<i>Bluetooth</i> connecting	Flashes
<i>Bluetooth</i> connection is established	Lights up

Pairing this system with a *Bluetooth* device

Pairing is an operation where *Bluetooth* devices register with each other beforehand. Once a pairing operation is performed, it does not need to be performed again. If your device is an NFC-compatible smartphone, the manual pairing procedure is not necessary.

- 1 Place the *Bluetooth* device within 1 meter (3 feet) from the system.**
- 2 Press BLUETOOTH on the unit to select *Bluetooth* function.**
“BLUETOOTH” appears in the display panel.

Note

If the system is connected to a *Bluetooth* device, press BLUETOOTH to disconnect the *Bluetooth* device.

- 3 Hold down BLUETOOTH on the unit for 2 seconds or more.**
“PAIRING” flashes in the display panel.

4 Perform the pairing procedure on the *Bluetooth* device.

For details, refer to the operating instructions of your *Bluetooth* device.

5 Select the model number of the unit on the display of the *Bluetooth* device.

For example, select “SONY:SHAKE-5”.

If passkey is required on the *Bluetooth* device, enter “0000”.

6 Perform the *Bluetooth* connection on the *Bluetooth* device.

When pairing is completed and the *Bluetooth* connection is established, *Bluetooth* device name appears in the display panel.

Depending on the *Bluetooth* device, connection may start automatically after pairing is completed.

You can check the *Bluetooth* device address by pressing DISPLAY repeatedly.

Notes

- You can pair up to 9 *Bluetooth* devices. If the 10th *Bluetooth* device is paired, the least recently connected device will be replaced by the new one.
- “Passkey” may be called “Passcode”, “PIN code”, “PIN number” or “Password”, etc., depending on the device.
- The pairing standby status of the system is canceled after about 5 minutes. If pairing is not successful, repeat from step 1.
- While connected to a *Bluetooth* device, this system cannot be detected and connection cannot be established from another *Bluetooth* device which is never paired before.
- If you want to pair with another *Bluetooth* device, repeat steps 1 to 6.

To cancel pairing operation

Hold down BLUETOOTH on the unit for 2 seconds or more until “BLUETOOTH” appears in the display panel.

Connecting with a smartphone by one touch (NFC)

By touching the system with an NFC-compatible smartphone, the system is turned on in *Bluetooth* function automatically, and then proceeds to complete pairing and the *Bluetooth* connection automatically.

What is “NFC”?

NFC (Near Field Communication) is a technology enabling short-range wireless communication between various devices, such as mobile phones and IC tags. Thanks to the NFC function, data communication can be achieved easily just by touching the designated touchpoint on the NFC-compatible devices.

1 Download and install the app “NFC Easy Connect”.

Download the free Android app from Google Play by searching for “NFC Easy Connect” or access it by using the two-dimensional code below. Data communication fees may be charged.

Two-dimensional code* for direct access

* Use a two-dimensional code reader app.



Notes

- The app may not be available in some countries/regions.
- Depending on your smartphone, you can use the NFC function without installing the app. In this case, the operations and specifications may be different. For details, refer to the operating instructions of your smartphone.

Compatible smartphones

Smartphones with a built-in NFC function (OS: Android 2.3.3 or later, excluding Android 3.x)

2 Start the app “NFC Easy Connect” on the smartphone.

Make sure that the application screen is displayed.

3 Touch the smartphone to the N-Mark on the system until the smartphone vibrates.

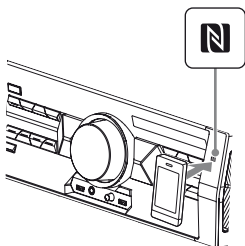

Complete the connection by following the instructions displayed on the smartphone.

When the *Bluetooth* connection is established, the BLUETOOTH indicator stops flashing and remains light up. *Bluetooth* device name appears in the display panel.

You can switch the sound source from the smartphone to another NFC-compatible *Bluetooth* device.

For details, refer to the operating instructions of your *Bluetooth* device.

Tip

If pairing and the *Bluetooth* connection fail, do the following.

- Relaunch “NFC Easy Connect” and move the smartphone slowly over the N-Mark.
- Remove the case from the smartphone if using a commercially available smartphone case.

Playing music from a *Bluetooth* device

You can operate a *Bluetooth* device by connecting the system and a *Bluetooth* device using AVRCP.

Check the following before playing music:

- The *Bluetooth* function of the *Bluetooth* device is turned on.
- Pairing has been completed.

■ For a *Bluetooth* device

1 Press BLUETOOTH on the unit to select *Bluetooth* function.

“BLUETOOTH” appears in the display panel.

2 Establish connection with the *Bluetooth* device.

The last connected *Bluetooth* device will be connected automatically. Perform the *Bluetooth* connection from the *Bluetooth* device if the device is not connected.

Once the connection is established, the *Bluetooth* device name appears in the display panel.

3 Press ►.

- Depending on the *Bluetooth* device,
- you may have to press ► twice.
 - you may need to start playback of an audio source on the *Bluetooth* device.

Notes

- When the system is not connected to any *Bluetooth* device, the system will connect and playback from the last connected *Bluetooth* device automatically when you press ►.
- If you try to connect another *Bluetooth* device to the system, the current connected *Bluetooth* device will be disconnected.

■ For an NFC-compatible smartphone

Touch the smartphone to the N-Mark on the system to establish the *Bluetooth* connection.

Start playback of an audio source on the smartphone. For details on playback, refer to the operating instructions of your smartphone.

To disconnect the *Bluetooth* device

■ For a *Bluetooth* device

Press BLUETOOTH on the unit. “BLUETOOTH” appears in the display panel.

Depending on the *Bluetooth* device, the *Bluetooth* connection may be canceled automatically when you stop playback.

■ For an NFC-compatible smartphone

Touch the smartphone to the N-Mark on the system again.

Erasing all the pairing registration information

Use the buttons on the unit to perform this operation.

1 Press BLUETOOTH to select *Bluetooth* function.

“BLUETOOTH” appears in the display panel.

If the system is connected to a *Bluetooth* device, the *Bluetooth* device name appears in the display panel. Press BLUETOOTH to disconnect the *Bluetooth* device.

2 Hold down OPTIONS and PHASER for about 3 seconds.

“PAIR HISTORY” and “CLEAR” appear in the display panel and all the pairing information is erased.

Setting the *Bluetooth* audio codecs

You can select the *Bluetooth* audio codecs when the connected *Bluetooth* device supports Advanced Audio Coding (AAC).

- 1 Press OPTIONS on the unit.
- 2 Press \uparrow/\downarrow repeatedly to select “BT AAC”, then press \oplus .
- 3 Press \uparrow/\downarrow repeatedly to select “BT AAC ON” or “BT AAC OFF”.
 - BT AAC ON: Advanced Audio Coding (AAC) is selected if the *Bluetooth* device supports AAC.
 - BT AAC OFF: Sub Band Codec (SBC) is selected.

Notes

- You can enjoy high quality sound if the AAC is selected. In case you cannot listen to AAC sound from your device, select “BT AAC OFF”.
- If you change this setting while the system is connected to a *Bluetooth* device, the *Bluetooth* device will be disconnected. To connect to the *Bluetooth* device, perform the *Bluetooth* connection again.

Setting/Canceling *Bluetooth* standby mode

The system goes into *Bluetooth* standby mode and waits for a *Bluetooth* connection, even when the system is turned off.

- 1 Press **OPTIONS** on the unit.**
- 2 Press **↕/↔** repeatedly to select “**BT STANDBY**”, then press **+**.**
- 3 Press **↕/↔** repeatedly to select “**ON**” or “**OFF**”.**
- 4 Press **I/⏻** to turn off the system.**

When *Bluetooth* standby mode is set to on, the system will turn on automatically when you establish the *Bluetooth* connection from the *Bluetooth* device.

Note

The system will not enter *Bluetooth* standby mode if you erase the pairing information.

Sound Adjustment

Adjusting the sound

To	Do this
Reinforce the bass and create a more powerful sound	Press BASS BAZUCA on the unit.
Reduce the bass sound (BASS CUT)	Hold down BASS BAZUCA on the unit for 2 seconds or more. To cancel the BASS CUT effect, press BASS BAZUCA again.
Notes	
<ul style="list-style-type: none">• The BASS BAZUCA indicator flashes when BASS CUT effect is turned on.• The BASS CUT effect is turned off automatically when you turn off the system.	
Select a preset sound effect	Press MUSIC, MOVIE/ GAME or FOOTBALL . To cancel preset sound effect, press MUSIC repeatedly to select “ FLAT ”.

Creating your own sound effect

You can raise or lower the levels of specific frequency bands and then store the setting in the memory as “USER EQ”.

- 1 Press **OPTIONS** on the unit.
- 2 Press **↑/↓** repeatedly to select “EQ EDIT”, then press **⊕**.
- 3 Press **↑/↓** repeatedly to adjust the equalizer level, then press **⊕**.

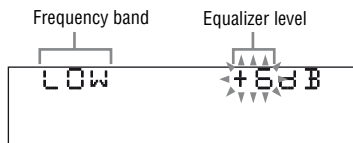

- 4 Repeat step 3 to adjust the level of other frequency bands and surround effect.

The user equalizer setting is stored when “USER EQ” appears in the display panel.

To bring up the user equalizer setting

Press **MUSIC** repeatedly to select “USER EQ”.

Creating a party atmosphere

(DJ EFFECT)

- 1 Press the following button to select the effect type.

The selected button lights up and the effect is activated.

- **FLANGER**: Create a deep flanging effect that is similar to the roar of a jet plane.
- **ISOLATOR**: Isolate a specific frequency band by adjusting the other frequency bands. For example, when you want to focus on vocal and etc.
- **SOUND FLASH**: Flash the sound output. The sound cuts off periodically.
- **PHASER**: Create a series of peaks and troughs in the frequency spectrum, like a sweeping effect.

- 2 Press **DJ CONTROL +/-** to adjust the effect level.

To turn off the effect

Press the selected effect button again.

Notes

- The **DJ EFFECT** is automatically turned off when you turn off the system or change the function or tuner band.
- If you activate the **DJ EFFECT** during transfer, the sound effect will not be transferred onto the USB device.
- You cannot use **VOLUME/DJ CONTROL** on the unit to adjust the volume when the **DJ EFFECT** is activated. Press **VOLUME +/-** on the remote control to adjust the volume.

Other Operations

Singing along

You can sing along with any audio source that played back on this system.

- 1 Turn MIC LEVEL to MIN to reduce the microphone volume level.**
- 2 Connect a microphone to the MIC jack on the unit.**
- 3 Start playing the music and adjust the volume.**
- 4 Turn MIC LEVEL to adjust the microphone volume.**

If acoustic feedback (howling) occurs, reduce the volume, move the microphone away from the speakers, or change the direction of the microphone.

After you have finished, disconnect the microphone.

Note

The sound from the microphone will not be transferred onto the USB device during USB transferring.

Changing the illumination pattern and color

Press LED PATTERN or LED COLOR to select the illumination pattern or color.

Press LED PATTERN or LED COLOR to show current setting. Press again to change the illumination pattern or color on the unit and the speakers instantaneously.

To turn off the illumination, press LED PATTERN repeatedly to select "PATTERN OFF".

Using the timers

The system offers three timer functions. You cannot activate both the Play Timer and the Recording Timer at the same time. If you use either with the Sleep Timer, the Sleep Timer has priority.

Sleep Timer

You can fall asleep when listening to music. The system turns off after the preset time.

Press SLEEP repeatedly.

To cancel Sleep Timer, press SLEEP repeatedly to select "SLEEP OFF".

Tip

To check the remaining time before the system turns off, press SLEEP.

Play Timer/Recording Timer

Make sure you have set the clock.

Play Timer:

You can wake up to disc, tuner or USB device at a preset time.

Recording Timer:

You can transfer music from a preset radio station into a USB device at a specified time.

1 For Play Timer:

Prepare the sound source, then press VOLUME +/- to adjust the volume. To start from a specific track or file, create your own program (page 15).

For Recording Timer:

Tune to the preset radio station (page 19).

2 Press TIMER MENU.

3 Press \uparrow/\downarrow repeatedly to select “PLAY SET” or “REC SET”, then press \oplus .

4 Set the time to start playback or transferring.

Press \uparrow/\downarrow repeatedly to set the hour/minute, then press \oplus .

5 Use the same procedure as in step 4 to set the time to stop playback or transferring.

6 Press \uparrow/\downarrow repeatedly to select the sound source you want, then press \oplus .

For Recording Timer:

Connect a transferable USB device to the ψ B port.

7 Press I/power to turn off the system.

To check the timer setting or activate the timer again

- 1 Press TIMER MENU.
“TIMER SELECT” flashes in the display panel.
- 2 Press \oplus .
- 3 Press \uparrow/\downarrow repeatedly to select “PLAY SELECT” or “REC SELECT”, then press \oplus .

To cancel the timer

Repeat the same procedure as above and select “TIMER OFF” in step 3, and then press \oplus .

Notes

- The system turns on before the preset time. If the system is turned on at the preset time or if “STANDBY” flashes in the display panel, the Play Timer and the Recording Timer will not play or transfer.
- Do not operate the system from the time the system turns on until the playback or transfer starts.

Changing the display

Changing the display mode

Press DISPLAY repeatedly while the system is turned off.

Demonstration

The display changes and the indicator flashes even when the system is turned off.

No display (Power Saving Mode)

The display is turned off to conserve power. The timer and clock continue to operate.

Clock

The clock display automatically turns on Power Saving Mode after a few seconds.

Changing the spectrum pattern of the display panel

- 1 Press OPTIONS on the unit.
- 2 Press \uparrow/\downarrow repeatedly to select “SPECTRUM”, then press \oplus .
- 3 Press \uparrow/\downarrow repeatedly to select the spectrum pattern you want, then press \oplus .

To exit the options menu, press OPTIONS on the unit.

Viewing information in the display panel

Press DISPLAY repeatedly when the system is turned on.

You can view the information as follows:

- For AUDIO CD:
 - The elapsed playing time and remaining playing time during playback.
 - The total playing time when playback is stopped.
- For audio files:
 - The elapsed playing time, file name and folder name.
 - The title, artist and album information.

Note

The elapsed playing time of an audio file encoded using a VBR (variable bit rate) is not displayed correctly.

Using optional equipment

- 1 Press VOLUME – repeatedly until “VOLUME MIN” appears in the display panel.**
- 2 Connect an optional equipment (page 10).**
- 3 Press FUNCTION repeatedly to select the function which corresponds to the connected equipment.**
- 4 Start playing the connected equipment.**
- 5 Press VOLUME + repeatedly to adjust the volume.**

Note

(For European model only)

The system may enter standby mode automatically if the volume level of the connected equipment is too low. Adjust the volume level of the equipment. To turn off automatic standby function, see “Setting/ Canceling the automatic standby function” (page 29).

Deactivating the buttons on the unit

(Child Lock)

You can deactivate the buttons on the unit (except I/⏻) for preventing misoperation, such as child mischief.

Hold down ■ on the unit for more than 5 seconds.

“CHILD LOCK” and “ON” appear in the display panel.

You can only operate the system using the buttons on the remote control.

To cancel, hold down ■ on the unit for more than 5 seconds until “CHILD LOCK” and “OFF” appear in the display panel.

Note

Child Lock function will be canceled when you disconnect the power cord.

Setting/Canceling the automatic standby function

(For European model only)

This system is equipped with an automatic standby function. With this function, the system enters standby mode automatically in about 30 minutes when there is no operation or audio signal output.

By default, the automatic standby function is turned on.

- 1 Press **OPTIONS** on the unit.**
- 2 Press **↕/↔** repeatedly to select “**AUTO STANDBY**”, then press **+**.**

- 3 Press **↕/↔** repeatedly to select “**ON**” or “**OFF**”.**

Notes

- The message “**AUTO STANDBY**” flashes in the display about 2 minutes before entering standby mode.
- The automatic standby function does not work during tuner function.
- The system may not enter standby mode automatically in the following cases:
 - when an audio signal is detected.
 - during playback of audio files.
 - while the preset Play Timer, Recording Timer or Sleep Timer is in process.

Additional Information

Playable discs

- AUDIO CD
- CD-R/CD-RW
 - audio data
 - MP3 files that conforms to ISO9660 Level 1/Level 2, or Joliet (expansion format).

Notes

- MP3 (MPEG 1 Audio Layer-3) is a standard format defined by ISO (International Organization for Standardization) which compresses audio data. MP3 files must be in MPEG 1 Audio Layer-3 format.
- The system can only play back MP3 files that have a file extension of “.mp3”.

Discs that cannot be played back

- CD-ROM
- CD-R/CD-RW which has the following conditions:
 - Recorded in MP3 PRO format
 - Recorded in multisession that have not ended by “closing the session”
 - Recorded with an incompatible recording device
 - Poor recording quality
 - Scratches or dirty
 - Finalized incorrectly
- Discs of non-standard shape (e.g., heart, square, star and etc.)
- Discs that have adhesive tape, paper, or sticker attached to them
- Rental or used discs with attached seals where the glue extends beyond the seal
- Discs that have labels printed using ink that feels tacky when touched

Note on DualDiscs

A DualDiscs is a two sided disc product which mates DVD recorded material on one side with digital audio material on the other side. However, since the audio material side does not conform to the Compact Disc (CD) standard, playback on this product is not guaranteed.

Music discs encoded with copyright protection technologies

This product is designed to play back discs that conform to the Compact Disc (CD) standard. Recently, various music discs encoded with copyright protection technologies are marketed by some record companies. Please be aware that among those discs, there are some that do not conform to the CD standard and may not be playable by this product.

Notes on playing multisession discs

- This system can play back multisession discs when an MP3 file is contained in the first session. Any subsequent MP3 files recorded in later sessions can also be played back (If later sessions contain AUDIO CD format, the system cannot play back this multisession discs).
- If the first session is recorded in AUDIO CD format, only the first session will be played back.

Websites for compatible devices

Check the websites below for the latest information about compatible USB and *Bluetooth* devices.

For customers in Latin America:

<<http://esupport.sony.com/LA>>

For customers in the United States:

<<http://www.esupport.sony.com/>>

For customers in Europe:

<<http://support.sony-europe.com/>>

For customers in other countries/regions:

<<http://www.sony-asia.com/support>>

Troubleshooting

Should you encounter a problem with your system, find your problem in the troubleshooting checklist below and take the corrective action.

If the problem persists, consult your nearest Sony dealer.

Note that if the service personnel changes some parts during repair, these parts may be retained.

If “PROTECT EXX” (X is a number) appears in the display panel

Immediately unplug the power cord, and check the following items.

- Are you using only the supplied speakers?
- Is anything blocking the ventilation holes of the unit?

After checking the above items and fixing any problems, plug in the power cord again and turn on the system. If the issue persists, consult your nearest Sony dealer.

General

The system has entered standby mode.

- This is not a malfunction. The system enters standby mode automatically in about 30 minutes when there is no operation or audio signal output (page 29).

The clock or timer setting is canceled.

- The power cord is disconnected or a power failure occurred. Set the clock (page 12) and timer (page 26) again.

There is no sound.

- Adjust the volume.
- Check the speaker connections (page 10).
- Check the connection of the optional equipment, if any (page 10).
- Turn on the connected equipment.
- There is no audio output during Recording Timer.

There is no microphone sound.

- Adjust the microphone volume.
- Make sure the microphone is connected to the MIC jack correctly.
- Make sure the microphone is turned on.

There is severe hum or noise.

- Move the system away from sources of noise.
- Connect the system to a different wall outlet.
- Install a noise filter (commercially available) to the power cord.
- Turn off surrounding electrical equipment.

The timer does not function.

- Check the timer setting and set the correct time (page 26).
- Cancel the Sleep Timer function (page 26).

The remote control does not function.

- Remove the obstacles between the remote control and the unit.
- Move the remote control closer to the unit.
- Point the remote control at the unit's sensor.
- Replace the batteries (R6/size AA).
- Move the unit away from the fluorescent light.

There is acoustic feedback.

- Reduce the volume.
- Move the microphone away from the speakers or change the direction of the microphone.

“CHILD LOCK” appears when you press any button on the unit.

- Set the Child Lock function to off (page 28).

Speakers

Sound comes from one channel or unbalanced left and right volume.

- Place the speakers as symmetrically as possible.
- Check that the speakers are connected securely and correctly.
- The source being played back is monaural.

There is no sound from a specific speaker.

- Check that the speaker is connected securely and correctly.

Disc player

The disc tray does not open and “LOCKED” appears in the display panel.

- Consult your nearest Sony dealer or local authorized Sony service facility.

The disc tray does not close.

- Load the disc correctly.

The disc does not eject.

- You cannot eject the disc during CD-USB Synchronized Transfer or REC1 Transfer. Press ■ to cancel the transfer, then press ▲ OPEN/CLOSE on the unit to eject the disc.
- Consult your nearest Sony dealer.

Playback does not start.

- Wipe the disc clean (page 36).
- Reload the disc.
- Load the disc that this system can play back (page 29).
- Remove the disc and wipe away the moisture on the disc, then leave the system turned on for a few hours until the moisture evaporates.

The sound skips.

- Wipe the disc clean (page 36).
- Reload the disc.
- Move the unit to a place with no vibration (e.g., on top of a stable stand).
- Move the speakers away from the unit, or place them on separate stands. When you listen to a track with bass sounds at high volume, the speaker vibration may cause the sound to skip.

Playback does not start from the first track.

- Set the play mode to Normal Play (page 14).

The folder name, track name, file name and ID3 tag characters do not appear properly.

- The ID3 tag is not Version 1(1.0/1.1) and Version 2(2.2/2.3).
- The character code that can be displayed by this system are as follows:
 - Upper cases (A to Z)
 - Numbers (0 to 9)
 - Symbols (<> * +, [] \ _)Other characters appear as “_”.

USB device

Transferring results in an error.

- You are using an unsupported USB device. Check the information on the websites about compatible USB devices (page 30).
- The USB device is not formatted correctly. Refer to the operating instructions of the USB device on how to format.
- Turn off the system and remove the USB device. If the USB device has a power switch, turn the USB device off and then on again after removing it from the system. Then perform transferring again.

- If the transferring and erase operations are repeated multiple times, the file structure within the USB device becomes fragmented. Refer to the operating instructions supplied with the USB device on how to deal with this problem.
- The USB device was disconnected or the power was turned off during transferring. Delete the partially-transferred file, and perform transferring again. If this does not fix the problem, the USB device may be broken. Refer to the operating instructions of the USB device on how to deal with this problem.

Audio files or folders on the USB device cannot be erased.

- Check if the USB device is write-protected.
- The USB device was disconnected or the power was turned off during the erase operation. Delete the partially-erased file. If this does not fix the problem, the USB device may be broken. Refer to the operating instructions of the USB device on how to deal with this problem.

There is no sound.

- The USB device is not connected correctly. Turn off the system and reconnect the USB device, then turn on the system and check if “USB A” or “USB B” lights up in the display panel.

There is noise, skipping, or distorted sound.

- You are using an unsupported USB device. Check the information on the websites about compatible USB devices (page 30).
- Turn off the system and reconnect the USB device, then turn on the system.
- The music data itself contains noise, or the sound is distorted. Noise may have entered during the transferring process. Delete the file, and try transferring again.

- The bit rate used when encoding audio files was low. Send audio files with higher bit rate to the USB device.

“READING” is displayed for an extended time, or it takes a long time before playback starts.

- The reading process can take a long time in the following cases.
 - There are many folders or files on the USB device (page 14).
 - The file structure is extremely complex.
 - The memory capacity is excessive.
 - The internal memory is fragmented.

“OVER CURRENT” appears.

- A problem has been detected with the level of electrical current from the ψ A port or ψ B port. Turn off the system and remove the USB device from the port. Make sure there is no problem with the USB device. If this display pattern persists, contact your nearest Sony dealer.

Erroneous display.

- The data stored in the USB device may have been corrupted, perform the transferring again.
- The character code that can be displayed by this system are as follows:
 - Upper cases (A to Z)
 - Numbers (0 to 9)
 - Symbols (< > * +, [] \ _)
 Other characters appear as “_”.

The USB device is not recognized.

- Turn off the system and reconnect the USB device, then turn on the system.
- Check the information on the websites about compatible USB devices (page 30).
- The USB device does not work properly. Refer to the operating instructions of the USB device on how to deal with this problem.

Playback does not start.

- Turn off the system and reconnect the USB device, then turn on the system.
- Check the information on the websites about compatible USB devices (page 30).

Playback does not start from the first file.

- Set the play mode to Normal Play (page 14).

Audio file cannot be played back.

- USB device formatted with file systems other than FAT16 or FAT32 are unsupported.*
- A WMA audio file that is the WMA DRM, WMA Lossless, or WMA PRO format cannot be played back.
- An AAC audio file that is the AAC DRM or AAC Lossless format cannot be played back.
- AAC audio files encoded at 96 kHz cannot be played back.
- In case multiple partitions exist in USB device that is being used, files may not be played back.
- The system can play back to a depth of 8 folders only.
- Files that are encrypted or protected by passwords and etc. cannot be played back.
- Files with DRM (Digital Rights Management) copyright protection cannot be played back by this system.
- The MP3 PRO audio file can be played back as MP3 audio file.

* This system supports FAT16 and FAT32, but some USB device may not support all of these FAT. For details, refer to the operating instructions of each USB device or contact the manufacturer.

Tuner

Severe hum or noise, or stations cannot be received. ("TUNED" or "ST" flashes in the display panel.)

- Connect the antenna properly.
- Change antenna location and its orientation to obtain good reception.
- Connect a commercially available external antenna.
- Consult your nearest Sony dealer if the supplied AM antenna has come off from the plastic stand.
- Turn off surrounding electrical equipment.

Bluetooth device

Pairing cannot be done.

- Move the *Bluetooth* device closer to the system.
- Pairing may not be possible if other *Bluetooth* devices are present around the system. In this case, turn off the other *Bluetooth* devices.
- Make sure the correct passkey was entered at the *Bluetooth* device.

Connection is not possible.

- The *Bluetooth* device you attempted to connect does not support the A2DP profile, and cannot be connected with the system.
- Enable the *Bluetooth* function of the *Bluetooth* device.
- Establish a connection from the *Bluetooth* device.
- The pairing registration information has been erased. Perform the pairing operation again.
- While connected to a *Bluetooth* device, this system cannot be detected and a connection cannot be established from another *Bluetooth* device which is never paired before.
- Erase the pairing registration information of the *Bluetooth* device (page 23) and perform the pairing operation again (page 20).

The sound skips or fluctuates, or the connection is lost.

- The system and the *Bluetooth* device are too far apart.
- If there are obstacles between the system and your *Bluetooth* device, remove or avoid the obstacles.
- If there is equipment that generates electromagnetic radiation, such as a wireless LAN, other *Bluetooth* device, or a microwave oven nearby, move them away.

The sound of your *Bluetooth* device cannot be heard on this system.

- Increase the volume on your *Bluetooth* device first, and then adjust the volume using VOLUME +/-.

There is severe hum, noise or distorted sound.

- If there are obstacles between the system and your *Bluetooth* device, remove or avoid the obstacles.
- If there is equipment that generates electromagnetic radiation, such as a wireless LAN, other *Bluetooth* device, or a microwave oven nearby, move them away.
- Turn down the volume of the connected *Bluetooth* device.

To reset the system

If the system still does not operate properly, reset the system to factory default settings. Use the buttons on the unit to perform this operation.

- 1 Unplug and plug the power cord back in.
- 2 Press **I/⏻** to turn on the system.
- 3 Hold down **■** and LED COLOR at the same time for about 3 seconds. "RESET" appears in the display panel. All user-configured settings, such as preset radio stations, timer, and the clock are reset to factory default setting.

Messages

One of the following messages may appear or flash in the display panel during operation.

CANNOT PLAY

A disc that cannot be played back was inserted.

DEVICE ERROR

The USB device could not be recognized or an unknown device is connected.

DEVICE FULL

The memory of the USB device is full.

FATAL ERROR

The USB device was removed during transfer or erase operation, and may have been damaged.

FOLDER FULL

You cannot transfer onto the USB device because the number of folder has reached its maximum.

NO DEVICE

No USB device is connected.

NO DISC

There is no disc on the disc tray.

NO MEMORY

The memory selected for playback or transfer has no memory media inserted in the USB device.

NO STEP

All of the programmed steps have been erased.

NO TRACK

No playable file is loaded in the system.

NOT IN USE

You tried to perform a specific operation under conditions where that operation is prohibited.

NOT SUPPORTED

An unsupported USB device is connected, or the USB device is connected through a USB hub.

OFF TIME NG

The on time and off time of Play Timer or Recording Timer is the same.

PROTECTED

The USB device is write-protected.

PUSH STOP

You tried to perform an operation that can be performed only when the playback is stopped.

READING

The system is reading information of the disc or USB device. Some operations are not available.

REC ERROR

The transfer did not start, stopped partway, or otherwise could not be performed.

STEP FULL

You tried to program more than 25 steps.

TRACK FULL

You cannot transfer onto the USB device because the number of file has reached its maximum.

UNLOCKED

The disc theft-preventive function is released.

Precautions

When carrying the unit

Perform the following procedure to protect the disc mechanism. Use the buttons on the unit to perform this operation.

- 1 Press I/⏻ to turn on the system.
- 2 Press CD.
- 3 Remove the disc.
Press ▲ OPEN/CLOSE to open and close the disc tray.
Wait until "NO DISC" appears in the display panel.
- 4 Hold down CD and FLANGER for 3 seconds.
"MECHA LOCK" appears in the display panel.
- 5 Unplug the power cord.

Notes on discs

- Before playing, wipe the disc with a cleaning cloth from the center outward to the edge.
- Do not clean discs with solvents, such as benzine, thinner, or commercially available cleaners or anti-static spray intended for vinyl LPs.
- Do not expose discs to direct sunlight or heat sources such as hot air ducts, nor leave it in a car parked in direct sunlight.

On safety

- Completely disconnect the power cord (mains lead) from the wall outlet (mains) if it is not going to be used for an extended period of time. When unplugging the unit, always grip the plug. Never pull the cord itself.
- Should any solid object or liquid get into the system, unplug the system, and have it checked by qualified personnel before operating it again.
- (For customers in United States only)
One blade of the plug is wider than other for the purpose of safety and will fit to the wall outlet only one way. If you are unable to insert the plug fully into the outlet, contact your dealer.
- AC power cord must be changed only at the qualified service shop.

On placement

- Do not place the system in an inclined position or in locations that are extremely hot, cold, dusty, dirty, or humid or lacking adequate ventilation, or subject to vibration, direct sunlight or a bright light.
- Be careful when placing the unit or speakers on surfaces that have been specially treated (for example, wax, oil, polish) as staining or discoloration of the surface may result.
- If the system is brought directly from a cold to a warm location or is placed in a very damp room, moisture may condense on the lens inside the unit, and cause the system to malfunction. In this situation, remove the disc, and leave the system turned on for about an hour until the moisture evaporates.

On heat buildup

- Heat buildup on the unit during operation is normal and is not a cause for alarm.
- Do not touch the cabinet if it has been used continuously at a high volume because the cabinet may have become hot.
- Do not obstruct the ventilation holes.

On the speaker system

This speaker system is not magnetically shielded, and the picture on nearby TV sets may become magnetically distorted. In this situation, turn off the TV, wait 15 to 30 minutes, and turn it back on. If there is no improvement, move the speakers far away from the TV.

Cleaning the cabinet

Clean this system with a soft cloth slightly moistened with a mild detergent solution. Do not use any type of abrasive pad, scouring powder, or solvent, such as thinner, benzine, or alcohol.

On Bluetooth Communication

- *Bluetooth* devices should be used within approximately 10 meters (33 feet) (unobstructed distance) of each other. The effective communication range may become shorter under the following conditions.
 - When a person, metal object, wall or other obstruction is between the devices with a *Bluetooth* connection
 - Locations where a wireless LAN is installed
 - Around microwave ovens that are in use
 - Locations where other electromagnetic waves occur

- *Bluetooth* devices and wireless LAN (IEEE 802.11b/g) use the same frequency band (2.4 GHz). When using your *Bluetooth* device near a device with wireless LAN capability, electromagnetic interference may occur. This could result in lower data transfer rates, noise, or inability to connect. If this happens, try the following remedies:
 - Try connecting this system and *Bluetooth* device when you are at least 10 meters (33 feet) away from the wireless LAN equipment.
 - Turn off the power to the wireless LAN equipment when using your *Bluetooth* device within 10 meters (33 feet).
- The radio waves broadcast by this system may interfere with the operation of some medical devices. Since this interference may result in malfunction, always turn off the power on this system and *Bluetooth* device in the following locations:
 - In hospitals, on trains, in airplanes, at gas stations, and any place where flammable gases may be present
 - Near automatic doors or fire alarms
- This system supports security functions that comply with the *Bluetooth* specification as a means of ensuring security during communication using *Bluetooth* technology. However, this security may be insufficient depending on the setting contents and other factors, so always be careful when performing communication using *Bluetooth* technology.
- Sony cannot be held liable in any way for damages or other loss resulting from information leaks during communication using *Bluetooth* technology.
- *Bluetooth* communication is not necessarily guaranteed with all *Bluetooth* devices that have the same profile as this system.
- *Bluetooth* devices connected with this system must comply with the *Bluetooth* specification prescribed by the Bluetooth SIG, Inc., and must be certified to comply. However, even when a device complies with the *Bluetooth* specification, there may be cases where the characteristics or specifications of the *Bluetooth* device make it impossible to connect, or may result in different control methods, display or operation.
- Noise may occur or the audio may cut off depending on the *Bluetooth* device connected with this system, the communications environment, or surrounding conditions.

Specifications

AUDIO POWER SPECIFICATIONS

POWER OUTPUT AND TOTAL HARMONIC DISTORTION: (USA model only)

With 4 ohm loads, both channels driven, from 120 – 10,000 Hz; rated 150 watts per channel minimum RMS power, with no more than 0.7% total harmonic distortion from 250 milliwatts to rated output.

Amplifier section

The following are measured at USA model:

AC 120 V, 60 Hz

Mexican model:

AC 120 V – 240 V, 60 Hz

European model:

AC 220 V – 240 V, 50/60 Hz

Other models:

AC 120 V – 240 V, 50/60 Hz

Tweeters/woofers

Power Output (rated):

350 W + 350 W (at 4 ohms, 1 kHz, 1% THD)

RMS output power (reference):

600 W + 600 W (per channel at 4 ohms, 1 kHz)

Subwoofers

Power Output (rated):

350 W + 350 W (at 4 ohms, 100 Hz, 1% THD)

RMS output power (reference):

600 W + 600 W (per channel at 4 ohms, 100 Hz)

Inputs

TV/DVD/SAT (AUDIO IN) L/R

Voltage 2 V, impedance 47 kilohms

PC/GAME (AUDIO IN) L/R

Voltage 2 V, impedance 47 kilohms

MIC

Sensitivity 1 mV, impedance 10 kilohms

♣ A (USB), ♣ B (USB) port: Type A

USB section

Supported bit rate

WMA:

48 kbps – 192 kbps, VBR, CBR

AAC:

48 kbps – 320 kbps, VBR, CBR

Sampling frequencies

WMA: 44.1 kHz

AAC: 44.1 kHz

Supported USB device

Mass Storage Class

Maximum current

500 mA

Disc/USB section

Supported bit rate

MPEG1 Layer-3:

32 kbps – 320 kbps, VBR

MPEG2 Layer-3:

8 kbps – 160 kbps, VBR

MPEG1 Layer-2:

32 kbps – 384 kbps, VBR

Sampling frequencies

MPEG1 Layer-3:

32 kHz/44.1 kHz/48 kHz

MPEG2 Layer-3:

16 kHz/22.05 kHz/24 kHz

MPEG1 Layer-2:

32 kHz/44.1 kHz/48 kHz

Disc player section

System

Compact disc and digital audio system

Laser Diode Properties

Emission Duration: Continuous

Laser Output*: Less than 44.6 μ W

* This output is the value measurement at a distance of 200 mm from the objective lens surface on the Optical Pick-up Block with 7 mm aperture.

Frequency response

20 Hz – 20 kHz

Signal-to-noise ratio

More than 90 dB

Dynamic range

More than 88 dB

Tuner section

FM stereo, FM/AM superheterodyne tuner

Antenna:

FM lead antenna

AM loop antenna

FM tuner section

Tuning range

USA model:

87.5 MHz – 108.0 MHz (100 kHz step)

Other models:

87.5 MHz – 108.0 MHz (50 kHz step)

AM tuner section

Tuning range

European model:

531 kHz – 1,602 kHz (9 kHz step)

Other models:

531 kHz – 1,710 kHz (9 kHz step)

530 kHz – 1,710 kHz (10 kHz step)

Bluetooth section

Communication system

Bluetooth Standard version 3.0 + EDR (Enhanced Data Rate)

Output

Bluetooth Standard Power Class 2

Maximum communication range

Line of sight approx. 10 m¹)

Frequency band

2.4 GHz band (2.4000 GHz – 2.4835 GHz)

Modulation method

FHSS (Freq Hopping Spread Spectrum)

Compatible *Bluetooth* profiles²)

A2DP (Advanced Audio Distribution Profile)

AVRCP 1.3 (Audio Video Remote Control Profile)

Supported codecs

SBC (Sub Band Codec)

AAC (Advanced Audio Coding)

- 1) The actual range will vary depending on factors such as obstacles between devices, magnetic fields around a microwave oven, static electricity, reception sensitivity, antenna's performance, operating system, software application, etc.
- 2) *Bluetooth* standard profiles indicate the purpose of *Bluetooth* communication between devices.

Speakers

Speaker system

3-way, Bass reflex

Speaker unit

Woofers: 200 mm (8 in), cone type

Tweeters: 25 mm (1 in), horn type

Subwoofers: 350 mm (14 in), cone type

Rated impedance

4 ohms

Dimensions (w/h/d) (Approx.)

490 mm × 660 mm × 360 mm

(19 3/8 in × 26 in × 14 1/4 in)

Mass (Approx.)

26.5 kg (58 lb 7 oz)

Quantity: 2 pieces

General

Power requirements

USA model:

AC 120 V, 60 Hz

Mexican model:

AC 120 V – 240 V, 60 Hz

European model:

AC 220 V – 240 V, 50/60 Hz

Other models:

AC 120 V – 240 V, 50/60 Hz

Power consumption

370 W (0.5 W at the Power Saving mode)

Dimensions (w/h/d) (excl. speakers)

(Approx.)

505 mm × 160 mm × 350 mm

(20 in × 6 3/8 in × 13 7/8 in)

Mass (excl. speakers) (Approx.)

6.0 kg (13 lb 4 oz)

Supplied accessories

Remote control (1)

R6 (Size AA) batteries (2)

FM lead/AM loop antenna (1)

Bottom panel (1)

Design and specifications are subject to change without notice.

<http://www.sony.net/>



©2013 Sony Corporation Printed in Malaysia

* 4 4 6 2 8 1 6 1 2 * (1)

Free Manuals Download Website

<http://myh66.com>

<http://usermanuals.us>

<http://www.somanuals.com>

<http://www.4manuals.cc>

<http://www.manual-lib.com>

<http://www.404manual.com>

<http://www.luxmanual.com>

<http://aubethermostatmanual.com>

Golf course search by state

<http://golfingnear.com>

Email search by domain

<http://emailbydomain.com>

Auto manuals search

<http://auto.somanuals.com>

TV manuals search

<http://tv.somanuals.com>