

Wireless Speaker System

Operating Instructions



SRS-BT100

WARNING

To reduce the risk of fire or electric shock, do not expose this apparatus to rain or moisture.

To reduce the risk of electrical shock, do not open the cabinet. Refer servicing to qualified personnel only.

Do not install the appliance in a confined space, such as a bookcase or built-in cabinet.

To reduce the risk of fire, do not cover the ventilation opening of the apparatus with newspapers, tablecloths, curtains, etc.

Do not place the naked flame sources such as lighted candles on the apparatus.

To reduce the risk of fire or electric shock, do not expose this apparatus to dripping or splashing, and do not place objects filled with liquids, such as vases, on the apparatus.

As the main plug is used to disconnect the unit from the mains, connect the unit to an easily accessible AC outlet. Should you notice an abnormality in the unit, disconnect the main plug from the AC outlet immediately.



Hereby, Sony Corp., declares that this equipment is in compliance with the essential requirements and other relevant provisions of Directive 1999/5/EC.

For details, please access the following URL:
<http://www.compliance.sony.de/>

Use of this radio equipment is not allowed in the geographical area within a radius of 20km from the centre of Ny-Alesund, Svalbard in Norway.

On Copyrights and Licenses

The Bluetooth word mark and logos are owned by the Bluetooth SIG, Inc. and any use of such marks by Sony Corporation is under license. Other trademarks and trade names are those of their respective owners.

MPEG Layer-3 audio coding technology and patents licensed from Fraunhofer IIS and Thomson.



Disposal of Old Electrical & Electronic Equipment (Applicable in the European Union and other European countries with separate collection systems)

This symbol on the product or on its packaging indicates that this product shall not be treated as household waste. Instead it shall be handed over to the applicable collection point for the recycling of electrical and electronic equipment. By ensuring this product is disposed of correctly, you will help prevent potential negative consequences for the environment and human health, which could otherwise be caused by inappropriate waste handling of this product. The recycling of materials will help to conserve natural resources. For more detailed information about recycling of this product, please contact your local Civic Office, your household waste disposal service or the shop where you purchased the product.

Notice for the customer in the countries applying EU Directives

The manufacturer of this product is Sony Corporation, 1-7-1 Konan, Minato-ku, Tokyo, Japan. The Authorized Representative for EMC and product safety is Sony Deutschland GmbH, Hedelfinger Strasse 61, 70327 Stuttgart, Germany. For any service or guarantee matters please refer to the addresses given in separate service or guarantee documents.

Table Of Contents

Features	4
Using the Bluetooth connection	5
Unpacking	6
Location and Function of Parts	7
Power Sources	8
Using the Bluetooth Connection	9
On pairing	9
On indicators	9
Pairing with a source device	10
Listening to the sound	11
Using by Connecting with a Cord	13
Hooking up the speaker	13
Listening to the sound	14
Precautions	15
Troubleshooting	17
Common	17
When using the Bluetooth connection	17
Initializing This Unit	18
What is Bluetooth technology?	19
Specifications	20

Features

This unit is a wireless speaker system that uses Bluetooth™ wireless technology.

- Enjoy music wirelessly from Bluetooth™ Stereo enabled music players, mobile phones and PC's.*
- Bluetooth Version 2.0 + EDR (Enhanced Data Rate) for higher quality audio with less interference.
- Powerful sound with 30W amplifiers and MegaBass.
- Wireless volume control with AVRCP volume Up/Down compatible devices.
- Includes one analog input for direct connection from music players and other audio devices.
- Magnetically-shielded design for use near your TV or monitor.

Enjoying listening to sound wirelessly by connecting Bluetooth wireless technology

You can enjoy listening to sound wirelessly by connecting Bluetooth supported devices (such as a mobile phone, digital music player, digital music player connected to a Bluetooth transmitter, or personal computer)* to the unit. The unit receives stereo audio signals from the source device.

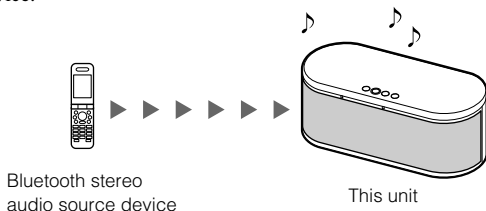

Enjoying listening to sound by connecting by wiring an audio device to the INPUT jack

You can enjoy listening to the sound from a device connected to the INPUT jack.

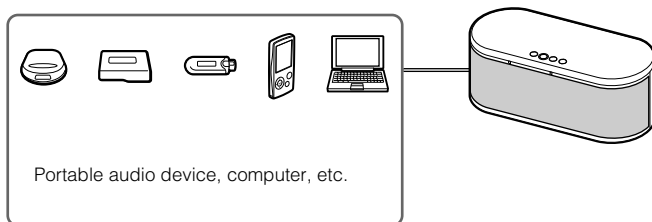

* Bluetooth devices to be connected with this unit are required to support A2DP (Advanced Audio Distribution Profile).

Using the Bluetooth connection

In the example below, we explain how to receive the sound played on a Bluetooth mobile phone with the sound playback function and listen to the sound on this unit.

Pairing

Enables a Bluetooth mobile phone and this unit to recognize one another.

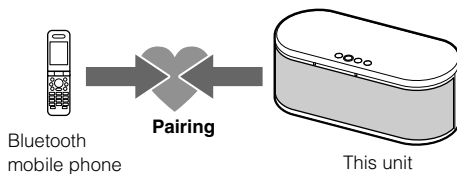

For more details, see pages 9 and 10.



Bluetooth connection

Operate the Bluetooth mobile phone to make the Bluetooth connection.

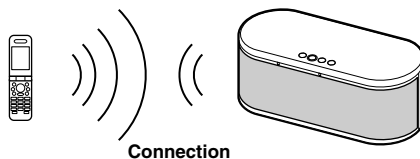

Listening to the sound

Enjoy listening to the sound played on the Bluetooth mobile phone through this unit.

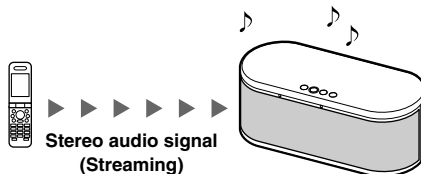

For more details, see page 11.

Unpacking

Check that you have the following items:

- Wireless Speaker System (1)
- AC power adaptor (1)
- AC power cord (1)
- Operating Instructions (1)

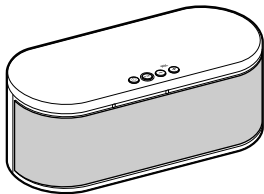

Location and Function of Parts

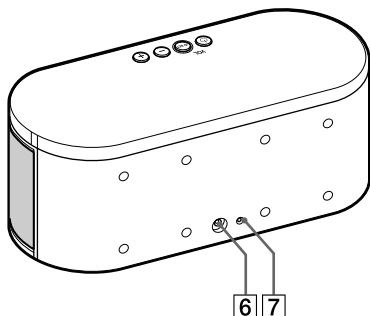
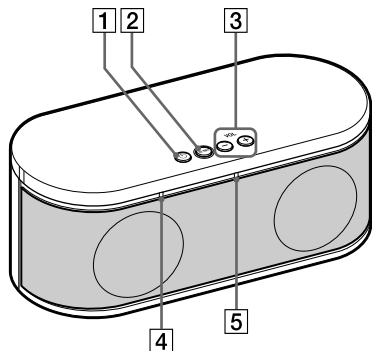

- 1**  **(power) button**
Press to turn on the unit. Press and hold to turn off the unit.
- 2** **ID SET (pairing) button**
For pairing with other Bluetooth device.
- 3** **VOLUME +/- buttons**
Adjust the volume.
A beep sounds when the volume is set to minimum or maximum.
- 4** **Power indicator (green)**
- 5** **Communication status indicator (blue)**
- 6** **DC IN 12 V jack**
Connects the supplied AC power adaptor.
- 7** **INPUT (audio input) jack**
Connects to headphone jack of a computer, portable audio device, etc.

Power Sources

Connect the supplied AC power adaptor to the unit.

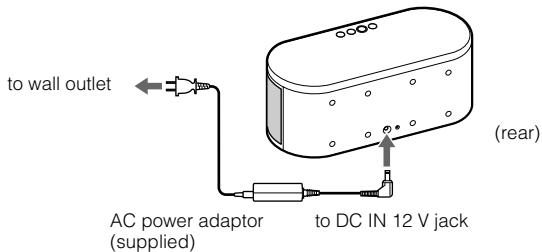

Note

When connecting or disconnecting the AC power adaptor, turn off the system beforehand. Otherwise, it may cause malfunction.

Note on the AC power adaptor

Use only the supplied AC power adaptor. Do not use any other AC power adaptor to avoid damaging the speaker.



Using the Bluetooth Connection

By using the Bluetooth connection, you can listen to the sound from a Bluetooth stereo audio source device with this unit wirelessly.

Example

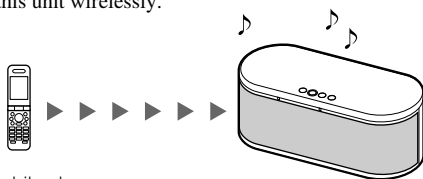

Bluetooth mobile phone or
other Bluetooth stereo audio
source device

This unit

Note

For details on how to operate the device to be connected, refer to the operating instructions supplied with the device.

On pairing

What is pairing?

Bluetooth devices need to be “paired” with each other beforehand. Once Bluetooth devices are paired, there is no need for pairing again, except in the following cases:

- Pairing information is deleted after repair, etc.
- This unit is paired with 9 or more devices.
This unit can be paired with up to 8 Bluetooth stereo audio source devices. If a new device is paired after 8 devices have been paired, the device whose latest connection time is the oldest among the 8 paired devices is replaced by the new one.
- This unit is initialized.
All pairing information is deleted (See page 18).

See page 10 on how to pair devices.

On indicators

Status	Power indicator (green)	Communication status indicator (blue)
Power on	Lights up	Off
Pairing mode	Flashes	Flashes
Connecting or communicating	Lights up	Lights up

Pairing with a source device

Check the following before operating the unit.

- This unit is connected to a power source.

1 Press and hold the ID SET button for 7 seconds or more.

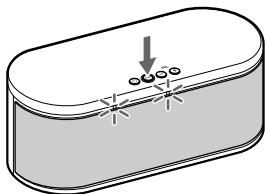

When the power indicator (green) and communication status indicator (blue) start flashing together, release the button. This unit enters pairing mode.

Note

Pairing mode is cancelled and this unit is turned off after about 5 minutes. If the pairing mode is cancelled while performing this procedure, start over from step 1.

2 Perform the pairing procedure on the Bluetooth stereo audio source device to detect this unit.

The list of detected devices appears on the display of the Bluetooth stereo audio source device.

This unit is displayed as “SRS-BT100.”

If “SRS-BT100” is not displayed, repeat from step 1.

Notes

- When pairing, be sure to place both the Bluetooth devices within 1 m of each other.
- Some devices cannot display the list of detected devices.

3 Select “SRS-BT100” shown in the display of the Bluetooth stereo audio source device.

4 If Passcode* input is required on the display of the Bluetooth stereo audio source device, input “0000.”

* Passcode may be called “Passkey,” “PIN code,” “PIN number,” or “Password.”

5 Start the Bluetooth connection from the Bluetooth device.

Some Bluetooth stereo audio source devices may connect with the unit automatically when pairing is complete.

When the Bluetooth connection is made properly, both the power indicator (green) and communication status indicator (blue) light up indicating that pairing is complete, and pairing information is memorized on this unit.

Note

If you turn off this unit or the Bluetooth stereo audio source device before the Bluetooth connection is complete, pairing information is not memorized and pairing will not be completed.

When pairing with a Bluetooth stereo audio source device that cannot display a list of detected devices or that has no display

You may pair the device by setting both this unit and the Bluetooth stereo audio source device to pairing mode. For details, refer to the operating instructions supplied with the device.

If pairing is not complete

Start over from step 1.

Tip

To pair with other Bluetooth devices, repeat steps 1 to 5 for each device.

Note

Passcode of this unit is fixed to "0000." This unit cannot be paired with a Bluetooth stereo audio source device whose Passcode is not "0000."

Listening to the sound

This unit supports SCMS-T content protection. You can enjoy music, etc., from a device such as a mobile phone or portable TV that supports SCMS-T content protection. Check the following before operating the unit.

- The Bluetooth stereo audio source device's Bluetooth function is on.
- Pairing of this unit and the Bluetooth stereo audio source device is complete.
- If you have been listening to the sound from a source device connected to the INPUT jack, stop playing on the device or turn off the device.

1 Press the button to turn on this unit.

2 Start the Bluetooth connection from the Bluetooth stereo audio source device.

3 Start playing on the Bluetooth stereo audio source device.

Note

If the source device has a bass boost function or equalizer function, set them to off. If these functions are on, sound may be distorted.

4 Adjust the volume.

Set the volume of the Bluetooth stereo audio source device to moderate level, and press the VOLUME +/- buttons on this unit.

Note

A beep sounds when the volume is set to minimum or maximum.

Notes

- In the following cases, you need to make the Bluetooth connection again.
 - The power of this unit does not turn on.
 - The power of the Bluetooth stereo audio source device does not turn on, or the Bluetooth function is off.
 - The Bluetooth function of this unit or the Bluetooth stereo audio source device is in sleep mode.
 - The Bluetooth connection is not made.
- When the sound of a Bluetooth stereo audio device is being reproduced using the Bluetooth connection (when both the power indicator (green) and communication status indicator (blue) light up), the sound from a device connected to the INPUT jack cannot be heard. Terminate Bluetooth connection to listen to the sound of a device connected to the INPUT jack.

To finish listening

Terminate the Bluetooth connection by any of the operations below.

- Operate the Bluetooth stereo audio source device to terminate the connection. For details, refer to the operating instructions supplied with the device.
- Turn off the Bluetooth stereo audio source device.
- Turn off this unit.

Tip

You can adjust the volume of this unit with the Bluetooth stereo audio source device supporting AVRCP (Audio/Visual Remote Control Profile) Volume UP/DOWN. For details, refer to the operating instructions supplied with the device.

Note

The volume of this unit may not be controlled as intended depending on the device.

Using by Connecting with a Cord

You can listen to the sound from a device connected to the INPUT jack.

Example

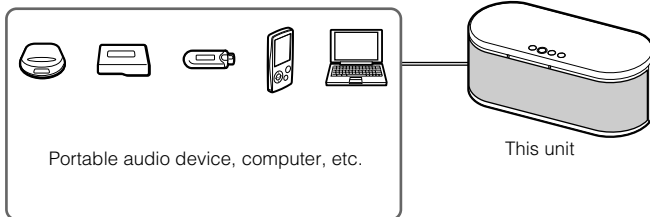

Note

For details on how to operate the device to be connected, refer to the operating instructions supplied with the device.

Hooking up the speaker

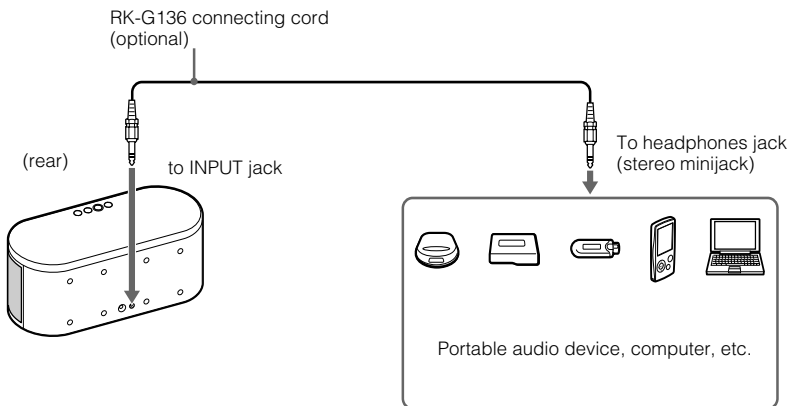

Connect the speaker to the source device.

When the system is connected to the monaural jack of the source device

The sound may not come through the right speaker. In such a case, use the optional* plug adaptor PC-236MS.

To connect to a stereo phone-type headphones jack

Use the optional connecting cord RK-G136 and plug adaptor PC-234S, or optional connecting cords RK-G136 and RK-G138.*

* The above optional accessories are not provided in some areas.

Listening to the sound

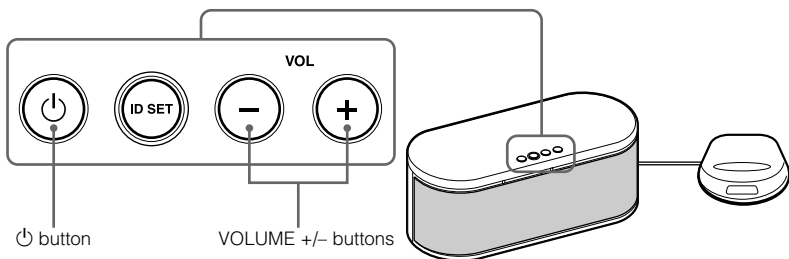

Check the following before operating the unit.

- If you have been listening to the sound from a Bluetooth stereo audio source device, terminate the Bluetooth connection.

1 Press the button to turn on this unit.

The power indicator (green) lights up.

2 Start playing on the source device.

3 Adjust the volume.

Set the volume of the source device to moderate level, and press the VOLUME +/- buttons on this unit.

Note

A beep sounds when the volume is set to minimum or maximum.

4 Press and hold the button to turn off this unit after using.

The power indicator goes off.

Notes

- If connecting the speaker to a device with a built-in radio or tuner, radio broadcasting cannot be received or sensitivity may be reduced significantly.
- If the source device has a bass boost function or equalizer function, set them to off. If these functions are on, sound may be distorted.
- If the source device's headphone output has a line switch, better sound will be heard if it is set to on. See the operating instructions of the source device.
- When the sound of a Bluetooth stereo audio device is being reproduced using the Bluetooth connection (when both the power indicator (green) and communication status indicator (blue) light up), the sound from a device connected to the INPUT jack cannot be heard. Terminate Bluetooth connection to listen to the sound of a device connected to the INPUT jack.

Precautions

On Bluetooth communication

- Bluetooth wireless technology operates within a range of about 10 meters. Maximum communication range may vary depending on obstacles (person, metal, wall, etc.) or electromagnetic environment.

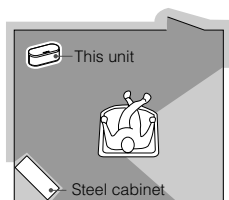

- The following conditions may affect the sensitivity of Bluetooth communication.
 - There is an obstacle such as a person, metal, or wall between this unit and Bluetooth device.
 - A device using the 2.4 GHz frequency, such as a wireless LAN device, cordless telephone, or microwave oven, is in use near this unit.
 - This unit is installed on a shelf made of steel.
- Because Bluetooth devices and wireless LAN (IEEE802.11b/g) use the same frequency, microwave interference may occur and resulting in communication speed deterioration, noise, or invalid connection if this unit is used near a wireless LAN device. In such a case, perform the following.
 - Use this unit at least 10 m away from the wireless LAN device.
 - If this unit is used within 10 m of a wireless LAN device, turn off the wireless LAN device.
 - Install this unit and Bluetooth device as near to each other as possible.

- Microwaves emitting from a Bluetooth device may affect the operation of electronic medical devices. Turn off this unit and other Bluetooth devices in the following locations, as it may cause an accident.
 - where inflammable gas is present, in a hospital, train, airplane, or a gas station
 - near automatic doors or a fire alarm
- This unit supports security capabilities that comply with the Bluetooth standard to provide a secure connection when the Bluetooth wireless technology is used, but security may not be enough depending on the setting. Be careful when communicating using Bluetooth wireless technology.
- We do not take any responsibility for the leakage of information during Bluetooth communication.
- Connection with all Bluetooth devices cannot be guaranteed.
 - A device featuring the Bluetooth function is required to conform to the Bluetooth standard specified by Bluetooth SIG, and be authenticated.
 - Even if the connected device conforms to the above mentioned Bluetooth standard, some devices may not be connected or work correctly, depending on the features or specifications of the device.
- Depending on the device to be connected, it may require some time to start communication.

Notes when using with a mobile phone

- You cannot use this unit to talk over the telephone, even if the Bluetooth connection between this unit and a mobile phone is made.
- For details on operation of your mobile phone when receiving a telephone call while transmitting the sound using the Bluetooth connection, refer to the operating instructions supplied with the mobile phone.

On safety

The nameplate indicating Sony trademark, model number and electrical rating is located on the bottom exterior of this unit.

- Before operating the system, be sure that the operating voltage of the system is identical with that of your local power supply.

Where purchased	Operating voltage
All countries/regions	100 – 240 V AC, 50/60 Hz

- Use only the supplied AC power adaptor.
- The unit is not disconnected from the mains as long as it is connected to the AC outlet, even if the unit itself has been turned off.

On placement

- Do not set the speaker in an inclined position.
- Do not leave the system in a location near heat sources, or in a place subject to direct sunlight, excessive dust, moisture, rain or mechanical shock.

On operation

- Do not open the cabinet. Refer servicing to qualified personnel only.
- Should any solid object or liquid fall into the system, have the system checked by qualified personnel before operating it any further.
- Although this system is magnetically shielded, do not leave recorded tapes, watches, personal credit cards, or floppy disks with magnetic coding in front of the system for an extended period of time.

On cleaning

Do not use alcohol, benzine, or thinner to clean the cabinet.

If the TV picture or monitor display is magnetically distorted

Although this system is magnetically shielded, there may be cases that the picture on some TV sets/personal computer sets may become magnetically distorted. In such a case, turn off the power of the TV set/personal computer set once, and after 15 to 30 minutes turn it on again. For the personal computer set, take the appropriate measures such as data storage before turning it off.

When there seems to be no improvement, locate the system further away from the TV set/personal computer set. Furthermore, be sure not to place objects in which magnets are attached or used near the TV set/personal computer set, such as audio racks, TV stands, toys etc. These may cause magnetic distortion to the picture due to their interaction with the system.

Others

- If you have any questions or problems concerning this unit that are not covered in this manual, please consult your nearest Sony dealer.
- Should any problem persist, consult your nearest Sony dealer.

Troubleshooting

If you run into any problems using this unit, use the following checklist. Should any problem persist, consult your nearest Sony dealer.

Common

No sound

- ➔ Check that both this unit and the source device are turned on.
- ➔ Turn up the volume of the unit.
- ➔ Turn up the volume of the source device as high as possible to the extent that sound is not distorted. For details on volume adjustment, refer to the operating instructions supplied with the device.
- ➔ Make sure all the connections have been correctly made.

Low sound level

- ➔ Turn up the volume of the source device as high as possible to the extent that sound is not distorted. For details on volume adjustment, refer to the operating instructions supplied with the device.
- ➔ Turn up the volume of the unit.

Distorted sound

- ➔ Turn down the volume of the source device to the point where the sound is no longer distorted. For details on volume adjustment, refer to the operating instructions supplied with the device.
- ➔ If the source device has a bass boosts function, set it to off.
- ➔ Turn down the volume of the unit.

There is hum or noise in the speaker output.

- ➔ Make sure all the connections have been correctly made.
- ➔ Make sure none of the audio devices are positioned too close to the TV set.

The brightness of the power indicator is unstable.

- ➔ The brightness of the power indicator may become unstable when the volume is turned up. This is not malfunction.

When using the Bluetooth connection

No sound

- ➔ Ensure that this unit is not too far from the Bluetooth stereo audio source device, or this unit is not receiving interference from a wireless LAN, other 2.4 GHz wireless device, or microwave oven.
- ➔ Check that the Bluetooth connection is made properly between this unit and the Bluetooth stereo audio source device.
- ➔ Pair this unit and the Bluetooth stereo audio source device again.

Sound skips or the correspondence distance is short.

- ➔ If a device that generates electromagnetic radiation, such as a wireless LAN, other Bluetooth device(s), or a microwave oven is nearby, move away from such sources.
- ➔ Remove any obstacle between this unit and other Bluetooth device or move away from the obstacle.
- ➔ Locate this unit and other Bluetooth device(s) as near as possible.
- ➔ Re-position this unit.
- ➔ Re-position other Bluetooth device.

Pairing cannot be done.



- ➔ Bring this unit and the Bluetooth device closer together.

Sound is delayed.

- ➔ If you watch a TV or a DVD through Bluetooth connection via this unit, sound may lag behind the picture.

Initializing This Unit

You can reset this unit to its default and delete all pairing information.

- 1 If this unit is turned on, press and hold the  button to turn off this unit.**
- 2 While holding the  button, press the ID SET button for 7 seconds or more.**

The power indicator (green) and the communication status indicator (blue) flash four times, and this unit is reset to the default setting. All pairing information is deleted.

What is Bluetooth technology?

Bluetooth wireless technology is a short-range wireless technology that enables wireless data communication between digital devices, such as a computer or digital camera. Bluetooth wireless technology operates within a range of about 10 meters. Connecting two devices as necessary is common, but some devices can be connected to multiple devices at the same time.*

You do not need to use a cable for connection since Bluetooth technology is a wireless technology, nor is it necessary for the devices to face one another, such is the case with infrared technology. For example, you can use such a device in a bag or pocket. Bluetooth technology is an international standard supported by thousands of companies all over the world, and employed by various companies worldwide.

* This unit cannot be connected to multiple devices at the same time.

Communication System and Compatible Bluetooth Profiles of this unit

Profile is standardization of the function for each Bluetooth device specification. This unit supports the following Bluetooth version and profiles:

Communication System: Bluetooth Specification version 2.0

Compatible Bluetooth Profiles:

- A2DP (Advanced Audio Distribution Profile)
- AVRCP (Audio/Visual Remote Control Profile) Volume UP/DOWN

Specifications

Speaker section

Speaker system

90 mm, Full range, magnetically shielded

Enclosure type

Bass reflex

Impedance

4 Ω

Rated input power

15 W

Maximum input power

30 W

Amplifier section

Rated output

15 W + 15 W (10% T.H.D., 1 kHz, 4 Ω)

Bass Boost

MEGA BASS

Audio input

Stereo minijack \times 1

Input impedance

4.7 k Ω (at 1 kHz)

General

Power

DC 12V (supplied AC power adaptor)

Dimensions (w/h/d)

Approx. 400 \times 160 \times 175 mm
(15 $\frac{3}{4}$ \times 6 $\frac{3}{8}$ \times 7 in.)

Mass

Approx. 2.5 kg (5 lb. 8 oz.)

Communication System

Bluetooth Specification version 2.0 + EDR

Output

Bluetooth Specification Power Class 2

Maximum communication range

Line of sight approx. 10 m (30 ft)^{*1}

Frequency band

2.4 GHz band (2.4000 GHz–2.4835 GHz)

Modulation method

FHSS

Compatible Bluetooth profiles^{*2}

A2DP (Advanced Audio Distribution Profile)
AVRCP (Audio/Visual Remote Control Profile)
Volume UP/DOWN

Supported codecs^{*3}

SBC^{*4}, MP3

Supported contents protection

SCMS-T

^{*1} The actual range will vary depending on factors such as obstacles between devices, magnetic fields around a microwave oven, static electricity, reception sensitivity, antenna's performance, operating system, software application, etc.

^{*2} Bluetooth standard profiles indicate the purpose of Bluetooth communication between devices.

^{*3} Codec: Audio signal compression and conversion format

^{*4} Subband Codec

Supplied accessories

AC power cord (1)
AC power adaptor (1)
Operating Instructions (1)

Optional accessories

Connecting cord RK-G136, RK-G138
Plug adaptor PC-234S, PC-236MS

The above optional accessories are not provided in some areas.

Design and specifications are subject to change without notice.

<http://www.sony.net/>

Printed in Malaysia



* 3 2 8 3 2 8 8 1 1 * (1)

Download from Www.Somanuals.com. All Manuals Search And Download.

Free Manuals Download Website

<http://myh66.com>

<http://usermanuals.us>

<http://www.somanuals.com>

<http://www.4manuals.cc>

<http://www.manual-lib.com>

<http://www.404manual.com>

<http://www.luxmanual.com>

<http://aubethermostatmanual.com>

Golf course search by state

<http://golfingnear.com>

Email search by domain

<http://emailbydomain.com>

Auto manuals search

<http://auto.somanuals.com>

TV manuals search

<http://tv.somanuals.com>