

Personal Audio System

Operating Instructions

ZS-2000

©2000 Sony Corporation

Download from [Www.Somanuals.com](http://www.Somanuals.com). All Manuals Search And Download.

Warning

To prevent fire or shock hazard, do not expose the player to rain or moisture.

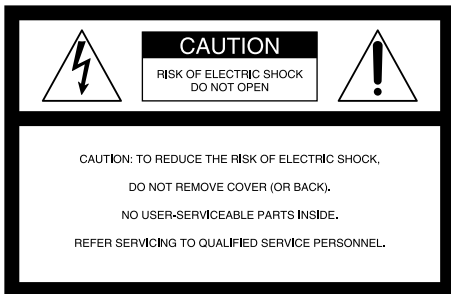

This symbol is intended to alert the user to the presence of uninsulated "dangerous voltage" within the product's enclosure that may be of sufficient magnitude to constitute a risk of electric shock to persons.



This symbol is intended to alert the user to the presence of important operating and maintenance (servicing) instructions in the literature accompanying the appliance.

CAUTION

The use of optical instruments with this product will increase eye hazard.

WARNING

Do not install the appliance in a confined space, such as a bookcase or built-in cabinet.

Information

For customers in the United States

This equipment has been tested and found to comply with the limits for a Class B digital device, pursuant to Part 15 of the FCC Rules. These limits are designed to provide reasonable protection against harmful interference in a residential installation. This equipment generates, uses and can radiate radio frequency energy and, if not installed and used in accordance with the instructions, may cause harmful interference to radio communications. However, there is no guarantee that interference will not occur in a particular installation. If this equipment does

cause harmful interference to radio or television reception, which can be determined by turning the equipment off and on, the user is encouraged to try to correct the interference by one or more of the following measures:

- Reorient or relocate the receiving antenna.
- Increase the separation between the equipment and receiver.
- Connect the equipment into an outlet on a circuit different from that to which the receiver is connected.
- Consult the dealer or an experienced radio/TV technician for help.

You are cautioned that any changes or modifications not expressly approved in this manual could void your authority to operate this equipment.

CAUTION

You can use this player on AC power source only. You cannot use it on batteries.

When you use this player for the first time, or when you have not used it for a long time, leave it connected to AC power source for about one hour to charge the built-in backup battery for the clock, timer, preset radio stations, etc. You can use the player during charging. The player will charge the battery automatically as long as it is connected to a power source.

When you disconnect the AC power cord after charging, be sure to turn the power off first. Once fully charged, the backup battery will last for about 30 minutes without being connected to any power sources.

If the stored data are erased, reenter them when you use the player again.

Owner's Record

The model number and the serial number are located at the bottom.

Record the serial number in the space provided below. Refer to these numbers whenever you call upon your Sony dealer regarding this product.

Model No. ZS-2000

Serial No. _____

Table of contents

Basic Operations

- 4 Playing a CD
 - 6 Listening to the radio
-

The CD Player

- 8 Using the display
- 9 Locating a specific track
- 10 Playing tracks repeatedly (Repeat Play)
- 11 Playing tracks in random order (Shuffle Play)
- 12 Creating your own program (Program Play)

The Radio

- 14 Presetting radio stations
- 16 Playing preset radio stations

The Audio Emphasis

- 17 Selecting the audio emphasis

The Timer

- 18 Setting the clock
- 19 Setting the time signal
- 21 Waking up to music
- 24 Falling asleep to music

Setting Up

- 25 Preparing the system
- 28 Saving power
- 29 Connecting optional components

Additional Information

- 31 Precautions
- 33 Troubleshooting
- 35 Specifications
- Back cover
- Index

Playing a CD

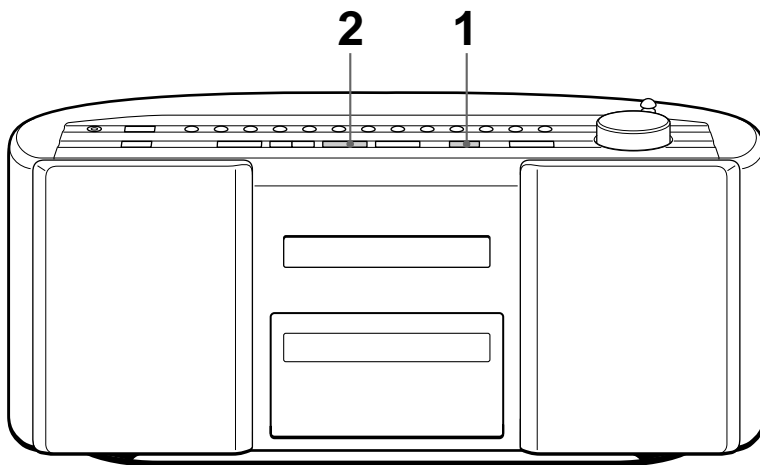

Connect the AC power cord to the wall outlet (see page 26).

1

CD OPEN/CLOSE



Press  CD OPEN/CLOSE (direct power-on) and place the CD on the CD tray until it clicks into place.

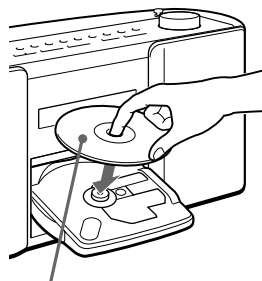

With the label side up

2



Press  (▶|| on the remote).
The CD tray closes and the player plays all the tracks once.

Display



Track number Playing time

Use these buttons for additional operations

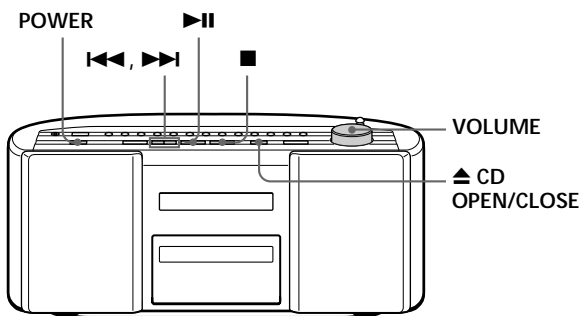
**Tip**

Next time you want to listen to a CD, just press **▶||**. The player turns on automatically and starts playing the CD.

To	Do this
adjust the volume	Turn VOLUME toward + or - (press VOL +, - on the remote).
stop playback	Press ■ .
pause playback	Press ▶ (on the remote). Press again to resume play after pause.
go to the next track	Press ▶▶ .
go back to the previous track	Press ◀◀ .
remove the CD	Press ▲ CD OPEN/CLOSE .
turn on/off the player	Press POWER .

Listening to the radio

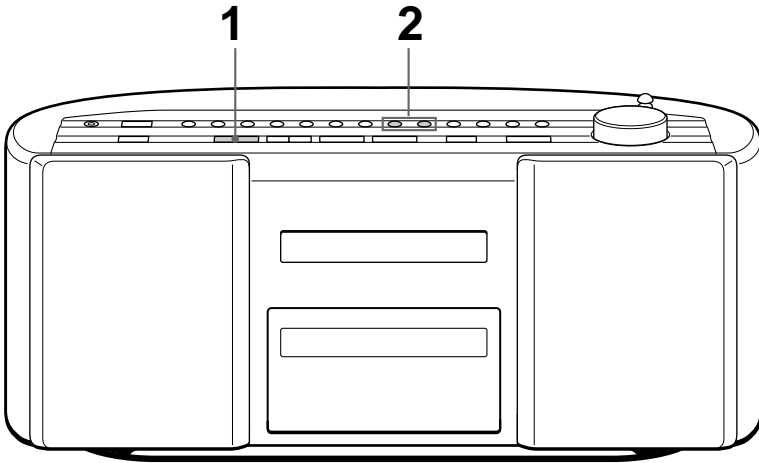

Connect the AC power cord to the wall outlet (see page 26).

1



Press RADIO BAND • AUTO PRESET until the band you want appears in the display (direct power-on).

Display

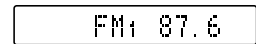

Each time you press the button, the band changes as follows: "FM1" → "FM2" → "AM"

2

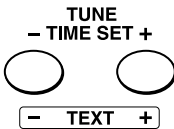

Hold down TUNE • TIME SET + or - (TUNE + or - on the remote) until the frequency digits begin to change in the display.

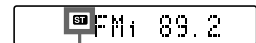

Indicates an FM stereo broadcast.

The player automatically scans the radio frequencies and stops when it finds a clear station.

If you cannot tune in a station, press the button repeatedly to change the frequency step by step.

Use these buttons for additional operations

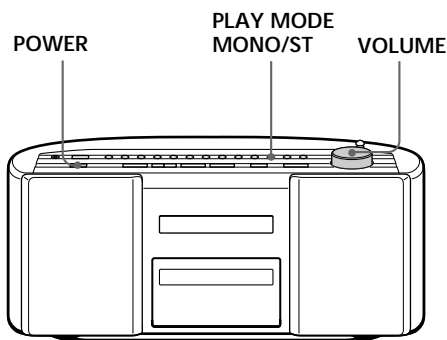

To	Do this
adjust the volume	Turn VOLUME toward + or - (press VOL +, - on the remote).
turn on/off the radio	Press POWER.

Tips

- The “FM1” and “FM2” bands have the same functions. You can store the stations you want separately in “FM1” and “FM2” (page 14).
- If the FM broadcast is noisy, press **PLAY MODE • MONO/ST** (MODE on the remote) until “Mono” appears in the display and the radio will play in monaural.
- Next time you want to listen to the radio, just press **RADIO BAND • AUTO PRESET**. The player turns on automatically and starts playing the previous station.

To improve broadcast reception

FM:

Reorient the antenna for FM.

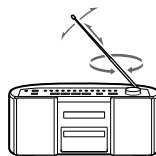
**AM:**

Keep the AM loop antenna as far as possible from the player and reorient it.

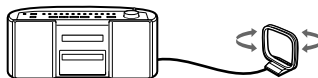

If the broadcast is still noisy, connect the external antenna (page 27).

Using the display

You can check information about the CD using the display.

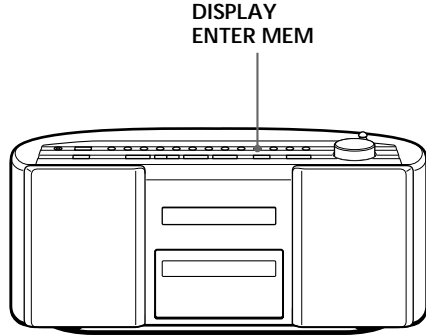

Checking the total track number and playing time

Press DISPLAY•ENTER MEM in stop mode.

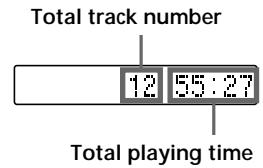

Checking the remaining time

Press DISPLAY•ENTER MEM while playing a CD.

To display	Press DISPLAY•ENTER MEM
the current track number and the remaining time on the current track*	once
the number of tracks left and remaining time on the CD	twice
the current track number and playing time	three times

* For a track whose number is more than 20 the remaining time appears as “- -:--”.

Locating a specific track

You can quickly locate any track using the number buttons. You can also find a specific point in a track while playing a CD.

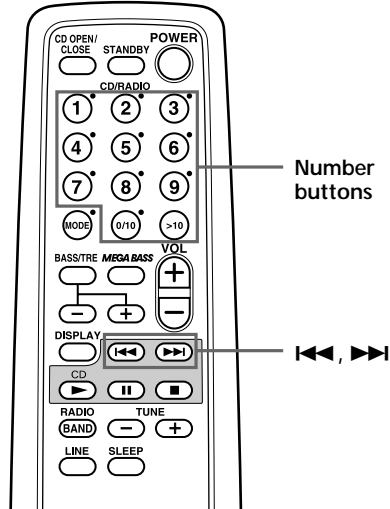

Note

You cannot locate a specific track if "SHUF" or "PGM" is lit in the display. Turn off the indication by pressing ■.

Tip

When you locate a track numbered over 10, press >10 first, then the corresponding number buttons.

Example:

To play track number 23, press >10 first, then 2 and 3.

To locate	Press
a specific track directly	number button of the track.
a point while listening to the sound	◀◀ or ▶▶ while playing and hold down until you find the point.
a point while observing the display	◀◀ or ▶▶ in pause and hold down until you find the point.

Playing tracks repeatedly

(Repeat Play)

You can play tracks repeatedly in normal, shuffle or program play modes (see pages 11 - 13).

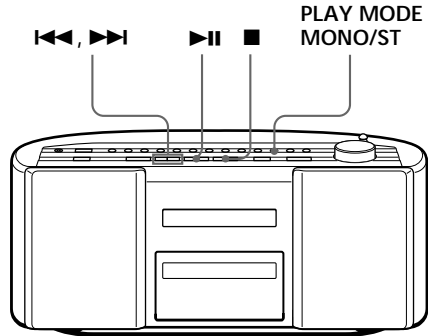

On the remote

- Use MODE to select “REP 1”, “REP ALL”, “REP” “SHUF” or “REP” “PGM”.
- When you’ve selected “REP 1”, use the number button to select the track.

1 Press ■.
“CD” appears in the display.

2 Proceed as follows:

To repeat	Do this
a single track	<ol style="list-style-type: none"> 1 Press PLAY MODE • MONO/ST until “REP 1” appears. 2 Select the track by pressing ◀◀ or ▶▶, then press ▶▶.
all the tracks	<ol style="list-style-type: none"> 1 Press PLAY MODE • MONO/ST until “REP ALL” appears. 2 Press ▶▶.
tracks in random order	<ol style="list-style-type: none"> 1 Press PLAY MODE • MONO/ST until “REP” and “SHUF” appear. 2 Press ▶▶.
programed tracks	<ol style="list-style-type: none"> 1 Press PLAY MODE • MONO/ST until “REP” and “PGM” appear. 2 Program tracks (see step 3 on page 12). 3 Press ▶▶.

To cancel Repeat Play

Press PLAY MODE • MONO/ST until “REP” disappears from the display.

Playing tracks in random order

(Shuffle Play)

You can play tracks in random order.

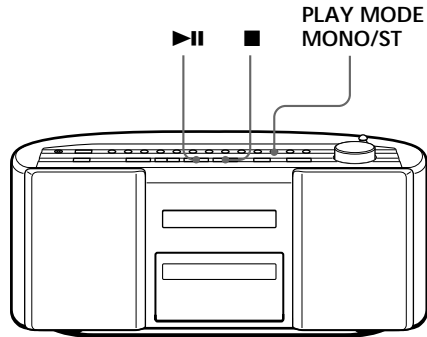

On the remote

- 1 Press ■.
- 2 Press MODE until "SHUF" appears in the display.
- 3 Press ▶.

- 1 Press ■.
"CD" appears in the display.
- 2 Press PLAY MODE•MONO/ST until "SHUF" appears in the display.
- 3 Press ▶||.

To cancel Shuffle Play

Press PLAY MODE•MONO/ST until "SHUF" disappears from the display.

Creating your own program

(Program Play)

You can arrange the playing order of up to 20 tracks on a CD.

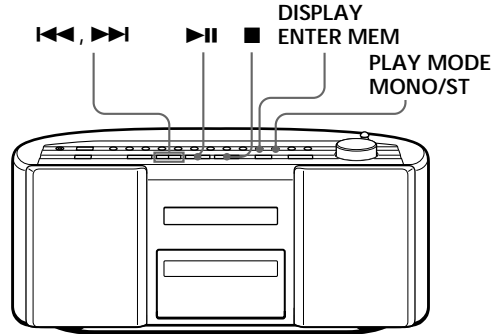

On the remote

- 1 Press ■.
- 2 Press MODE until "PGM" appears in the display.
- 3 Press the number buttons for the tracks you want to program in the order you want.
- 4 Press ▶.

- 1 Press ■.
"CD" appears in the display.
- 2 Press PLAY MODE • MONO/ST until "PGM" appears in the display.
- 3 Press I◀◀ or ▶▶I to select the track you want to program, and press DISPLAY • ENTER MEM.
Repeat this step.



Track number Playing order

- 4 Press ▶II.

Tip

You can play the same program again, since the program is saved until you open the CD tray.

To cancel Program Play

Press **PLAY MODE**•**MONO/ST** until “PGM” disappears from the display.

To check the order of tracks before play

Press **DISPLAY**•**ENTER MEM**.

Every time you press the button, the track number appears in the programmed order.

To change the current program

Press **■** once if the CD is stopped and twice if the CD is playing. The current program will be erased. Then create a new program following the programming procedure.

Presetting radio stations

You can store radio stations into the player's memory. You can preset up to 30 radio stations, 10 for each band in any order.

You can also label the preset stations.

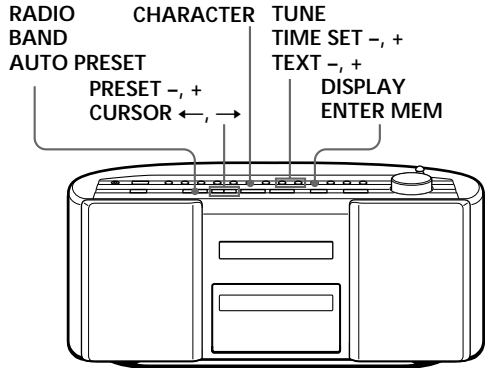

Tip

If you automatically preset the "FM1" or "FM2" band, 10 radio stations are stored in "FM1" band and 10 more radio stations are stored in "FM2" band.

1 Press RADIO BAND • AUTO PRESET until the band you want appears in the display.

2 Hold down RADIO BAND • AUTO PRESET for 2 seconds until "Auto" flashes in the display.

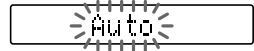

3 Press DISPLAY • ENTER MEM.

The stations are stored in memory from the lower frequencies to the higher ones.

To label the preset station

- 1 Press RADIO BAND • AUTO PRESET to select the band.
- 2 Press PRESET + or - until the preset number of the station you want to label appears in the display.
- 3 Do as steps 3 to 7 on page 15.

On the remote

- 1 Press BAND to select the band.
- 2 Press TUNE + or - to set the frequency to the station you want.
- 3 Press and hold the number button that you want to preset the new station on for 2 seconds.

If a station cannot be preset automatically

You need to preset a station with a weak signal manually. You can also label the preset station.

- 1 Press RADIO BAND • AUTO PRESET to select the band.
- 2 Tune in a station you want.
- 3 Hold down DISPLAY • ENTER MEM for 2 seconds until the preset number flashes in the display.
- 4 Press PRESET + or - until the preset number (1 to 10) you want for the station flashes in the display.
- 5 Press DISPLAY • ENTER MEM.
- 6 Input the name of the station (up to 8 characters).
 - ① Select a character by pressing TEXT + or -.
 - ② Press CURSOR → to make the cursor shift rightward.

Repeat steps ① and ②.

You can also use the following buttons:

Button to use	Function
CURSOR ←, →	Move the cursor leftward or rightward
CHARACTER	Each time you press the button, the character changes as follows: Upper case letters → Lower case letters → Numbers and symbols.

- 7 Press DISPLAY • ENTER MEM.

Playing preset radio stations

Once you've preset the stations, use the PRESET +, - on the remote to tune in your favorite stations.

RADIO
BAND
AUTO PRESET

PRESET -, +

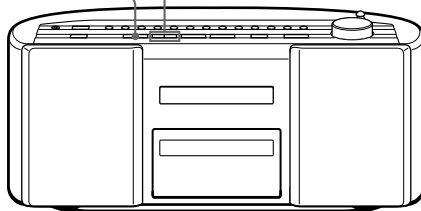

On the remote

- 1 Press BAND to select the band.
- 2 Press the number buttons to tune in the stored station.

- 1 Press RADIO BAND • AUTO PRESET to select the band.
- 2 Press PRESET + or - to display the preset number of the station you want.

FM1 P-05

Preset number



FM1 89.2

Selecting the audio emphasis

You can adjust the audio emphasis of the sound or the bass/treble sound you are listening to.

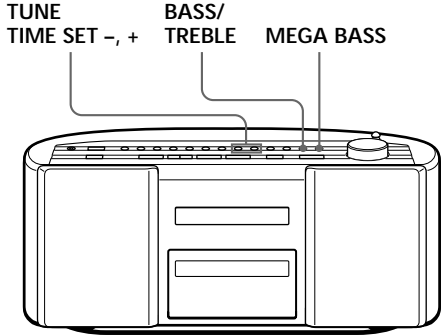

On the remote

- 1 Press BASS/TRE to select "BASS" or "TREBLE".
- 2 Adjust the bass or treble sound using BASS/TRE + or -.

Note

When the volume is too high, the sound adjustments may not be effective.

Reinforcing the bass sound

Press MEGA BASS.

"MEGA BASS" appears in the display. To return to normal sound, press the button again.

Adjusting the bass/treble sound

- 1 Press BASS/TREBLE to select "BASS" or "TREBLE".
- 2 Adjust the bass or treble sound using TUNE•TIME SET + or -.

You can adjust the sound level in the range of -5 to +5.

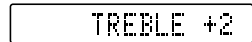

Setting the clock

“--:--” indication appears in the display until you set the clock.

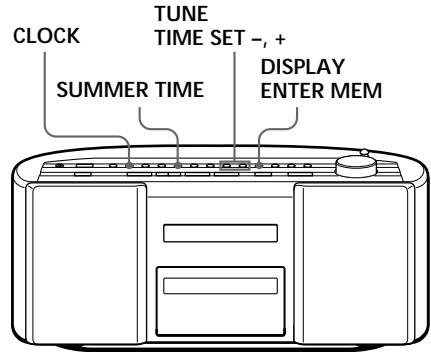

Tip

The time display system of this player is the 12-hour system.

1 Press and hold **CLOCK** until the hour digits flash.



2 Set the time.

① Press **TUNE•TIME SET +** or **-** to set the hour and press **DISPLAY•ENTER MEM**.



② Press **TUNE•TIME SET +** or **-** to set the minutes.



3 Press **DISPLAY•ENTER MEM**.

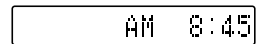

The clock starts from 00 seconds.

To change the display to the daylight saving time (summer time) indication

Press and hold **SUMMER TIME** for 2 seconds.

“Summer On” appears in the display for a few seconds.

To cancel the summer time indication

Press and hold **SUMMER TIME** again.

“Summer Off” appears in the display for a few seconds.

Setting the time signal

When the power is off, you can hear the time signal on this player. You can select the sound for the time signal. Make sure you have set the clock (see page 18).

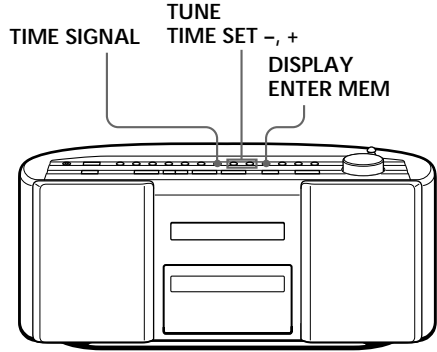

Note

The time signal does not sound when the player is turned on.

- 1 When the power is off, press TIME SIGNAL to display “TIME SIGNAL” indication.
Do the following operations by checking the display.

Display



- 2 Press TUNE•TIME SET + or - until the sound you want appears in the display, and press DISPLAY•ENTER MEM.

Display	Intervals
Wall Clock	Sounds on the hour the number of times corresponding to the hour and again on the half hour once (Example: Three times at 3:00 p.m. and again at 3:30 p.m. once).
Harp	Sounds on the hour once
Music Box	Sounds on the hour once
Chime	Sounds on the hour once
Organ	Sounds on the hour once

- 3 Press TUNE•TIME SET + or - to set the volume you want, and press DISPLAY•ENTER MEM.

continued

Setting the time signal (continued)

- 4** Press TUNE•TIME SET + or – to select the time for the time signal function to work, and then press DISPLAY•ENTER MEM.

Display	Time signal sounds
Off	Not at all
Every Hour	All day
Auto	7:00 a.m. - 10:00 p.m.
Once a Day*	Once a day

* If you selected “Wall Clock” in step 2, you cannot select “Once a Day”

- 5** If you selected “Once a Day” in step 4, set the time for the time signal to sound. (If you selected other items in step 4, omit this step.)

- ① Press TUNE•TIME SET + or – to set the hour and press DISPLAY•ENTER MEM.
- ② Press TUNE•TIME SET + or – to set the minutes and press DISPLAY•ENTER MEM.

To check the sound types (demonstration mode)

Press and hold TIME SIGNAL for about 2 seconds. You can hear the five types of sound once.

Waking up to music

You can wake up to music or a radio program at a preset time. Make sure you have set the clock (see page 18).

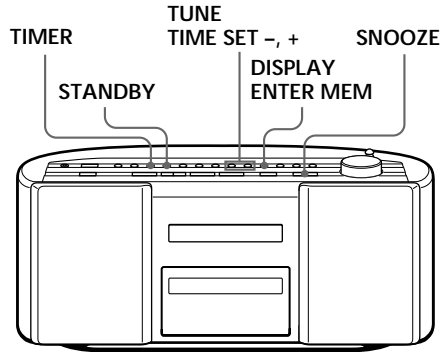

Before you begin, make sure the ⌚ (clock) indication is not lit in the display. If it is lit, press STANDBY.

1 Prepare the music source you want to play.

Source	Do this
CD	Insert a CD.
RADIO	Tune in a station.
LINE	Turn on the equipment connected to LINE IN.

2 Press TIMER to display the ⌚ indication.

Do the following operations by checking the display.



3 Press TUNE•TIME SET + or – until the music source you want to play (“CD”, “RADIO” or “LINE”) appears in the display, and press DISPLAY•ENTER MEM.

continued

Waking up to music (continued)

Tips

- To exit the standby mode, press **STANDBY** to make the ☺ indication disappear.
- The preset settings remain until you reset them.

4 Set the timer to the hour and the minutes you want the music to go on.

- ① Press **TUNE•TIME SET + or -** to set the hour and press **DISPLAY•ENTER MEM.**



- ② Press **TUNE•TIME SET + or -** to set the minutes and press **DISPLAY•ENTER MEM.**

5 Press **TUNE•TIME SET + or -** to set the volume you want, and press **DISPLAY•ENTER MEM.**



6 Press **STANDBY**.

The ☺ indication lights up and the power goes off; the player enters the standby mode.

At the preset time, the power will go on and music will play. Then the power will go off after 1 hour, and the player will enter the standby mode again.

To check/change the waking up timer settings

Press **TIMER**, then **DISPLAY•ENTER MEM.** Each time you press **DISPLAY•ENTER MEM**, a stored setting is displayed in the set order. To change the setting, display the setting you want to change and re-enter it.

To use the player before a timer playback starts

If you turn on the player, you can use it as usual (in case of the radio, if you listen to the station which is different from the one you tuned in step 1 on page 21, you will hear that station at the preset time). Turn off the player before the preset time.

Tip

Every time the player turns on using the SNOOZE function, the volume will be turned up one level.

To stop play

Turn off the power.

To doze for a few more minutes

Press SNOOZE.

“Snooze” appears in the display and the power goes off. The player turns on automatically after about 5 minutes. You can repeat this process by pressing SNOOZE.

To cancel the snooze function

Press POWER to turn on the power.

Falling asleep to music

You can set the player to turn off automatically after 10, 20, 30, 60, 90 and 120 minutes, allowing you to fall asleep while listening to music.

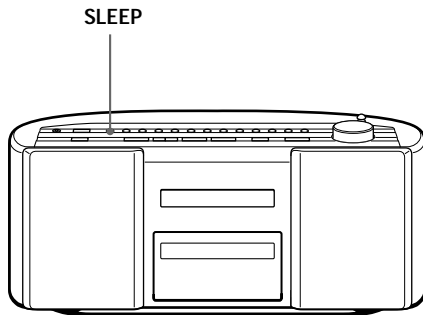

Tips

- The display window dims while the sleep timer is on.
- You can combine the wake up timer with the sleep timer. Set the wake up timer first (page 21), turn on the power, and then set the sleep timer.
- You can prepare the different music for the wake up timer and the sleep timer. However, you cannot store different radio stations.
- You can set different volume for the wake up timer and the sleep timer. For instance, you can sleep at lower volume and wake up at higher volume.

- 1** Play the music source you want.
- 2** Press SLEEP to display “SLEEP.”
- 3** Press SLEEP to select the minutes until the player goes off automatically.

Each time you press the button, the indication changes as follows:



“60” → “90” → “120” → no indication → “10” → “20” → “30”.

If 4 seconds have passed after you pressed SLEEP, the minutes in the display are stored in memory.

When the preset time has passed, music stops and the player goes off automatically.

To cancel the sleep function

Press SLEEP to make “SLEEP” disappear from the display.

To change the preset time

Do the steps 2 and 3 again.

Preparing the system

According to the illustrations, connect the cords firmly. Wrong connections cause malfunctions. Connect the AC power cord last.

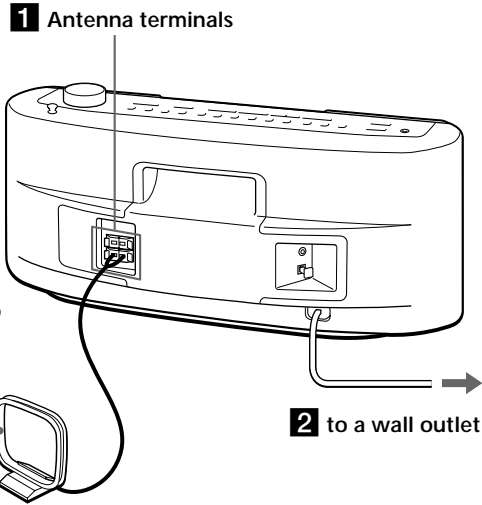

Note

Be sure to turn off the power of the player before connecting/disconnecting the AC power cord.

Note

Keep the AM loop antenna away as far as possible from the player. If you do not, noise may be heard.

1 Hooking up the antenna

- 1 Strip the coating from the end of the cable and twist the wires.

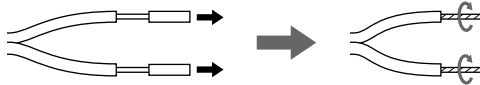

- 2 Connect the wires to the terminals.

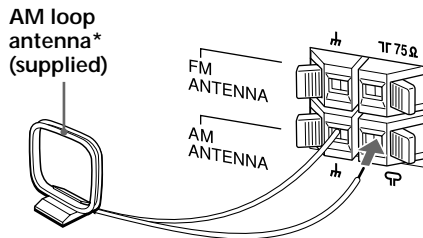

* Reorient the antenna to improve broadcast reception.

continued

Preparing the system (continued)

Tip

This unit is supplied with a different color speaker net. If you wish to change the color of your speaker, pull each corner of the speaker net toward yourself to remove the net. Then exchange it with the extra net.

Setting up the AM loop antenna

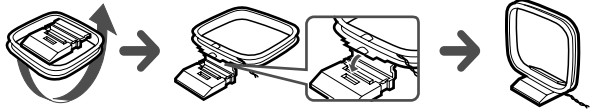

2 Connecting the AC power cord

Connect the AC power cord to the wall outlet.

3 Inserting batteries into the remote

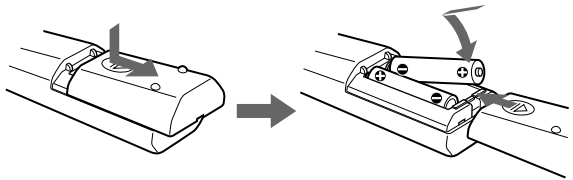

Insert two size AA (R6) batteries (not supplied)

Replacing batteries

With normal use, the batteries should last for about six months. When the remote no longer operates the player, replace all the batteries with new ones.

Important

When you use an outdoor antenna, be sure to connect the \hbar terminal to earth against lightning. To prevent a gas explosion, do not connect the ground wire to a gas pipe.

To improve the FM reception

Connect the FM outdoor antenna (not supplied). If you use a distributor, you can also use the TV antenna.

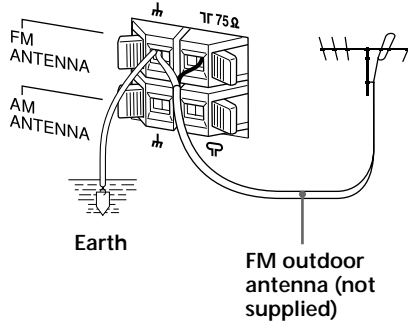
**To improve the AM reception**

Connect a 6- to 15-meter (20- to 50 feet) (not supplied) insulated wire to the AM ANTENNA terminal. Keep the wire as horizontal as possible near the window or outdoor. You do not need to disconnect the supplied AM loop antenna.

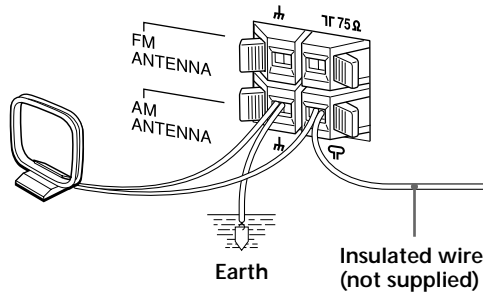

Saving power

Even when power is turned off, this player consumes about 5.6 W for time indication, timer operation, remote control reception. If you use the saving power function, you can reduce power consumption to less than 1 W.

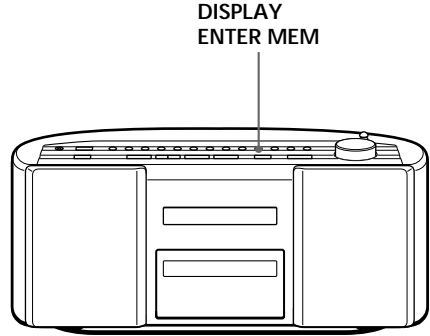

When the power is off, press and hold
DISPLAY • ENTER MEM for about 2 seconds.

The player enters the lower power consumption
standby mode.

To cancel the saving power

To make the time indication appear, press and hold
DISPLAY • ENTER MEM for about 2 seconds when the
power is off.

Connecting optional components

You can record a CD on a MiniDisc or enjoy the sound from a VCR, TV or MiniDisc player/recorder through the speakers of this player.

Be sure to turn off the power of each component before making connections.

For details, refer to the instruction manual of the component to be connected.

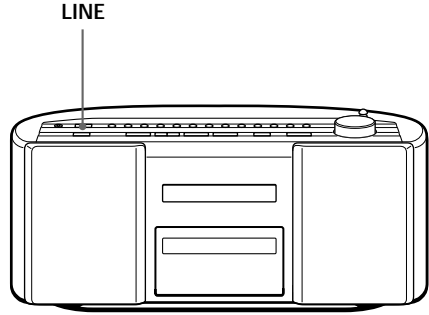

Note

Connect the cables firmly to avoid any malfunction.

Recording a CD on a MiniDisc recorder and DAT recorder

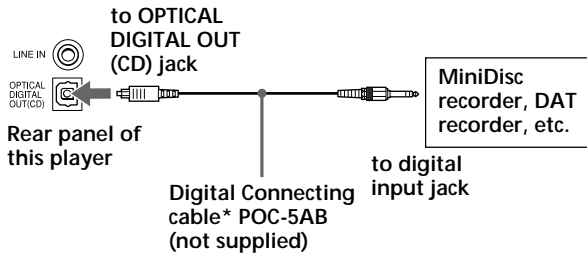

* Select a connecting cable depending on the type of the digital input jack of the recorder to be connected. For details, refer to the instruction manual of the component to be connected. The OPTICAL DIGITAL OUT (CD) jack of this player is square-shaped jack.

The type of the jack of the component to be connected	Model number of the connecting cable
Optical miniplug (MiniDisc recorder, etc.)	POC-5AB, POC-10AB, POC-15AB
L-type 7-pin connector (DAT recorder, etc.)	POC-DA12P
Square-shaped optical connector (MiniDisc recorder, DAT recorder, etc.)	POC-10A, POC-15A

continued

Connecting optional components (continued)

Notes

- As long as "CD" appears in the display, the optical digital output jack is in operation and the jack lights even if the CD is in stop mode.
- If you play a CD-ROM that is not for audio use, noise may be heard.

- 1** Remove the jack cover from the OPTICAL DIGITAL OUT (CD) jack of this player and connect the jack with the digital input jack of the MiniDisc recorder or other component using the digital connecting cable (not supplied) .
- 2** Turn on the power of this player and the connected component.
- 3** Make the connected component ready for recording.
- 4** Start playing a CD on this player.

Listening to TV, VCR and MiniDisc player/ recorder

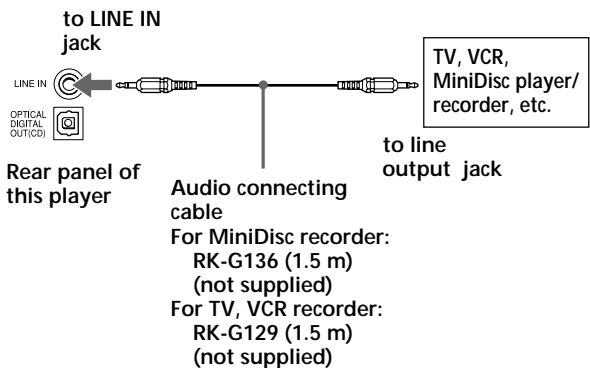

- 1** Connect the LINE IN jack of this player with the line output jack of the MiniDisc player or other component using the audio connecting cable (not supplied) .
 - 2** Turn on the power of this player and the connected component.
 - 3** Press LINE and start playing sound on the connected component.
- The sound from the connected component is output from the speakers.

Precautions

On safety

- As the laser beam used in the CD player section is harmful to the eyes, do not attempt to disassemble the casing. Refer servicing to qualified personnel only.
- Should any solid object or liquid fall into the player, unplug the player, and have it checked by qualified personnel before operating it any further.

On power sources

- The player is not disconnected from the AC power source (mains) as long as it is connected to the wall outlet, even if the player itself has been turned off.
- Unplug the player from the wall outlet when it is not be used for an extended period of time.
- When the batteries are not to be used, remove them to avoid damage that can be caused by battery leakage or corrosion.
- The nameplate indicating operating voltage, power consumption, etc. is located at the bottom.

On placement

- Do not leave the player in a location near heat sources, or in a place subject to direct sunlight, excessive dust or mechanical shock.
- Do not place the player on an inclined or unstable place.
- Do not place anything within 10 mm of the side of the cabinet. The ventilation holes must be unobstructed for the player to operate properly and prolong the life of its components.
- If the player is left in a car parked in the sun, be sure to choose a location in the car where the player will not be subjected to the direct rays of the sun.
- Since a strong magnet is used for the speakers, keep personal credit cards using magnetic coding or spring-wound watches away from the player to prevent possible damage from the magnet.

continued

Precautions (continued)

On operation

If the player is brought directly from a cold to a warm location, or is placed in a very damp room, moisture may condense on the lenses inside the CD player section. Should this occur, the player will not operate properly. In this case, remove the CD and wait about an hour for the moisture to evaporate.

Cleaning the cabinet

Clean the cabinet, panel and controls with a soft cloth slightly moistened with a mild detergent solution. Do not use any type of abrasive pad, scouring powder, or solvent, such as alcohol or benzine.

If you have any questions or problems concerning your player, please consult your nearest Sony dealer.

Notes on CDs

- Before playing, clean the CD with a cleaning cloth. Wipe the CD from the center out.



- Do not use solvents such as benzine, thinner, commercially available cleaners or anti-static spray intended for vinyl LPs.
- Do not expose the CD to direct sunlight or heat sources such as hot air ducts, nor leave it in a car parked in direct sunlight as there can be a considerable rise in temperature inside the car.
- Do not stick paper or sticker on the CD, nor scratch the surface of the CD.
- After playing, store the CD in its case.

If there is a scratch, dirt or fingerprints on the CD, it may cause tracking error.

Troubleshooting

	Symptom	Remedy
General	There is no audio.	<ul style="list-style-type: none">• Press POWER to turn on the player.• Connect the AC power cord to the wall outlet securely.• Adjust the volume.• Unplug the headphones when listening through speakers.
	Noise is heard.	<ul style="list-style-type: none">• Someone is using a portable telephone or other equipment that emits radio waves near the player. → Move the portable telephone, etc., away from the player.
	“No Disc” lights in the display even when a CD is in place.	<ul style="list-style-type: none">• Insert the CD with the label surface up.
CD Player	The CD does not play.	<ul style="list-style-type: none">• Make sure that the CD tray is closed.• Place the CD with the label surface up.• Clean the CD.• Take out the CD and leave the CD tray open for about an hour to dry moisture condensation.• Press ■ to switch the function of the player to “CD”.
	The sound drops out.	<ul style="list-style-type: none">• Reduce the volume.• Clean the CD, or replace it if the CD is badly damaged.• Place the player in a location free from vibration.• The sound may drop out or noise may be heard if the CD is recorded using a personal computer (CD-R, etc.).

continued

Troubleshooting (continued)

	Symptom	Remedy
Radio	The audio is weak or has poor quality.	<ul style="list-style-type: none"> • Move the player away from the TV. • If you are using the remote while listening to AM radio, noise may be heard. This is unavoidable.
	The audio is not stereo.	<ul style="list-style-type: none"> • Press PLAY MODE•MONO/ST on the player until "STEREO" appears.
	The picture of your TV becomes unstable.	<ul style="list-style-type: none"> • If you are listening to an FM program near the TV with an indoor antenna, move the player away from the TV.
Timer	The timer does not operate.	<ul style="list-style-type: none"> • Make sure the time on the clock is correct. • Check to see if the AC power had been cut off. • Make sure the ⌚ (clock) indication is displayed.
	The remote does not function.	<ul style="list-style-type: none"> • Replace all the batteries in the remote with new ones if they are weak. • Make sure that you are pointing the remote at the remote sensor on the player. • Remove any obstacles in the path of the remote and the player. • Make sure the remote sensor is not exposed to strong light such as direct sunlight or fluorescent lamp light. • Move closer to the player when using the remote.
Remote		

The player uses a built-in micro computer for its various operations. Due to change in power supply conditions, etc., operation may sometimes become unstable. After trying the above remedies, if the player still does not function properly, unplug the AC power cord. While keeping SNOOZE and CHARACTER pressed at the same time, plug the AC power cord again. If the problem persists, please consult your nearest Sony dealer.

Specifications

AUDIO POWER SPECIFICATIONS

POWER OUTPUT AND TOTAL HARMONIC DISTORTION

With 4-ohm loads, both channels driven from 150 - 15,000 Hz; rated 6.5 W per channel- minimum RMS power, with no more than 10 % total harmonic distortion in AC operation.

Other Specifications

CD player section

System

Compact disc digital audio system

Laser diode properties

Material: GaAlAs

Wave length: 780 nm

Emission duration: Continuous

Laser output: Less than 44.6 μ W (This output is the value measured at a distance of about 200 mm from the objective lens surface on the optical pick-up block with 7 mm aperture.)

Spindle speed

200 r/min (rpm) to 500 r/min (rpm) (CLV)

Number of channels

2

Frequency response

20 - 20,000 Hz +0.5/-0.7 dB

Wow and flutter

Below measurable limit

Radio section

Frequency range

FM: 87.6 - 108 MHz

AM: 530 - 1,710 kHz

Antennas

FM: Telescopic antenna

AM: Loop antenna

General

Speaker

Full range: 8 cm (3 1/4 in.) dia., 4 ohms, cone type x 2

Input

LINE IN jack (stereo minijack)

Minimum input level 250 mV

Outputs

Headphones jack (stereo minijack)

For 16 - 68 ohms impedance headphones
OPTICAL DIGITAL OUT (CD) (optical output connector)

Wavelength: 630 - 690 nm

Power requirements

For personal audio system:

120 V AC, 60 Hz

For remote control:

3 V DC, 2 size AA (R6) batteries

Power consumption

AC 30 W

Dimensions (incl. projecting parts)

approx. 470 \times 206.5 \times 145.5 mm (w/h/d)

(18 5/8 \times 8 1/4 \times 5 3/4 inches)

Mass

approx. 5 kg (11 lb.)

Supplied accessories

Remote control (1)

AM loop antenna (1)

Speaker nets (2)

Design and specifications are subject to change without notice.

Optional accessories

Sony MDR headphone series

Index

A

Audio emphasis 17

B

Batteries for remote 26

C

CD player 8

Cleaning

cabinet 32

Connecting

AC power cord 26

optional components
29

Creating your own program

12

D, E, F, G

Display 8

H

Hooking up

antenna 25

I, J, K

Improving reception 7

L

Listening

to the radio 6

to the TV, VCR and MD
player 30

Locating

a specific track 5, 9

M, N, O

MEGA BASS 17

P, Q

Playing

a CD 4

preset radio stations 16

tracks in random order 11

tracks repeatedly 10

Presetting radio stations 14

Program Play 12

R

Radio stations

playing 6

presetting 14

Recording

on an MD or a DAT 29

Repeat Play 10

S

Selecting

audio emphasis 17

Setting the clock 18

Setting the time signal 19

Setting up 25

Shuffle Play 11

SNOOZE 23

SUMMER TIME 18

T

Timer

Falling asleep to music
24

Waking up to music 21

Troubleshooting 33

U, V, W, X, Y, Z

Using the display 8

Free Manuals Download Website

<http://myh66.com>

<http://usermanuals.us>

<http://www.somanuals.com>

<http://www.4manuals.cc>

<http://www.manual-lib.com>

<http://www.404manual.com>

<http://www.luxmanual.com>

<http://aubethermostatmanual.com>

Golf course search by state

<http://golfingnear.com>

Email search by domain

<http://emailbydomain.com>

Auto manuals search

<http://auto.somanuals.com>

TV manuals search

<http://tv.somanuals.com>