

Multi Channel AV Receiver

Operating Instructions

STR-DE400

WARNING

To reduce the risk of fire or electric shock, do not expose this apparatus to rain or moisture.

To prevent fire, do not cover the ventilation of the apparatus with newspapers, table-cloths, curtains, etc. And don't place lighted candles on the apparatus.

To prevent fire or shock hazard, do not place objects filled with liquids, such as vases, on the apparatus.

Do not install the appliance in a confined space, such as a bookcase or built-in cabinet.

For customers in Europe

Disposal of Old Electrical & Electronic Equipment (Applicable in the European Union and other European countries with separate collection systems)



This symbol on the product or on its packaging indicates that this product shall not be treated as household waste. Instead it shall be handed over to the applicable collection point for the recycling of electrical and electronic equipment. By ensuring this product is disposed of correctly, you will help prevent potential negative consequences for the environment and human health, which could otherwise be caused by inappropriate waste handling of this product. The recycling of materials will help to conserve natural resources. For more detailed information about recycling of this product, please contact your local Civic Office, your household waste disposal service or the shop where you purchased the product.

About This Manual

- The instructions in this manual are for model STR-DE400. Check your model number by looking at the lower right corner of the front panel. In this manual, models of area code CEL is used for illustration purposes unless stated otherwise. Any difference in operation is clearly indicated in the text, for example, "Models of area code TW only".
- The instructions in this manual describe the controls on the supplied remote. You can also use the controls on the receiver if they have the same or similar names as those on the remote.

About area codes

The area code of the receiver you purchased is shown on the lower right portion of the rear panel (see the illustration below).

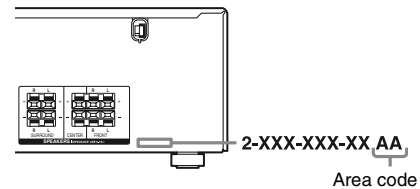

Any differences in operation, according to the area code, are clearly indicated in the text, for example, "Models of area code AA only".

This receiver incorporates Dolby* Digital and Pro Logic Surround and the DTS** Digital Surround System.

- * Manufactured under license from Dolby Laboratories. "Dolby", "Pro Logic", and the double-D symbol are trademarks of Dolby Laboratories.
- ** "DTS" and "DTS Digital Surround" are registered trademarks of Digital Theater Systems, Inc.

Table of Contents

Getting Started

Description and location of parts	4
1: Installing speakers	12
2: Connecting speakers	13
3a: Connecting the audio components	14
3b: Connecting the video components	16
4: Connecting the antennas	22
5: Preparing the receiver and the remote.....	23
6: Calibrating the appropriate settings automatically (AUTO CALIBRATION)	24
7: Adjusting the speaker levels and balance (TEST TONE).....	27

Playback

Selecting a component	28
Listening/Watching a component.....	30

Amplifier Operations

Navigating through menus	32
Adjusting the level (LEVEL menu)	35
Adjusting the tone (TONE menu)	36
Settings for the surround sound (SUR menu)	36
Settings for the tuner (TUNER menu)	37
Settings for the audio (AUDIO menu)	37
Settings for the system (SYSTEM menu)...	38
Calibrating the appropriate settings automatically (A. CAL menu)	41

Enjoying Surround Sound

Enjoying Dolby Digital and DTS Surround sound (AUTO FORMAT DIRECT)	42
Selecting a pre-programmed sound field.....	43
Using only the front speakers (2CH STEREO).....	46
Resetting sound fields to the initial settings.....	46

Tuner Operations

Listening to FM/AM radio	47
Storing FM stations automatically (AUTOBETICAL).....	48
(Models of area code CEL, CEK only)	
Presetting radio stations.....	49
Using the Radio Data System (RDS)	52
(Models of area code CEL, CEK only)	

Other Operations

Switching the audio input mode (INPUT MODE).....	53
Naming inputs	54
Changing the display	54
Using the Sleep Timer	55

Using the Remote

Changing button assignments.....	55
----------------------------------	----

Additional Information

Glossary	56
Precautions	57
Troubleshooting.....	58
Specifications	61
Index	Back cover

Description and location of parts

Front panel

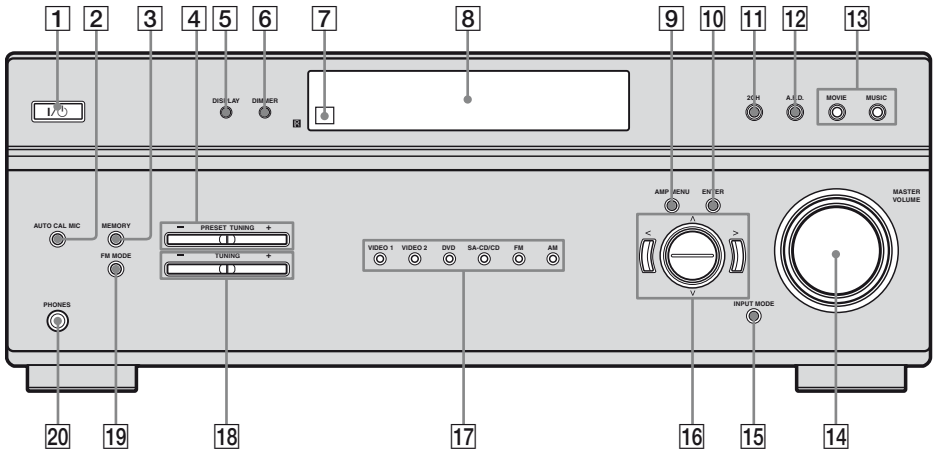

Name	Function
1 I/O	Press to turn the receiver on or off (page 23, 30, 31, 46, 48).
2 AUTO CAL MIC jack	Connects to the supplied ECM-AC2 optimizer microphone for the Auto Calibration function (page 24).
3 MEMORY	Press to store a station (page 49).
4 PRESET TUNING +/-	Press to select a preset station (page 50).
5 DISPLAY	Press to select information displayed on the display (page 52, 54).
6 DIMMER	Press to adjust the brightness of the display (page 41).
7 Remote sensor	Receives signals from remote commander.

Name	Function
8 Display	The current status of the selected component or a list of selectable items appears here (page 6).
9 AMP MENU	Press to display the menu of the receiver.
10 ENTER	Press to store a station or enter the selection when selecting the settings (page 27, 32, 51, 54).
11 2CH	Press to select 2CH STEREO mode (page 46).
12 A.F.D.	Press to select A.F.D. mode (page 42).
13 MOVIE, MUSIC	Press to select sound fields (MOVIE, MUSIC) (page 43).
14 MASTER VOLUME	Turn to adjust the volume level of all speakers at the same time (page 28, 29, 30, 31).

Name	Function
15 INPUT MODE	Press to select the input mode when the same components are connected to both digital and analog jacks (page 53).
16 </>/^/∨	After pressing AMP MENU (9), press < or > and ^ or ∨ to select the settings.
17 Input buttons	Press one of the button to select the component you want to use.
18 TUNING +/-	Press to scan a station (page 47, 50).
19 FM MODE	Press to select FM monaural or stereo reception.
20 PHONES jack	Connects to a headphone (page 59).

About the indicators on the display

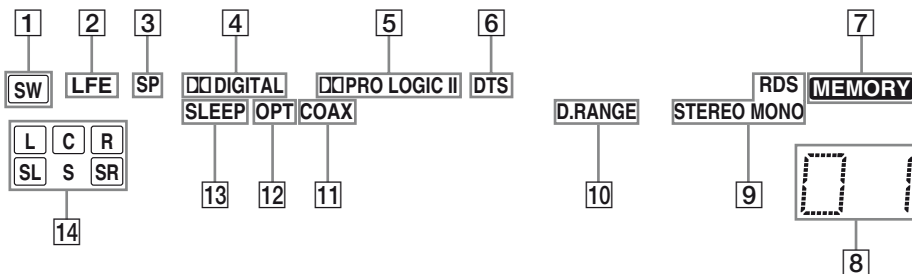

Name	Function
1 SW	Lights up when sub woofer selection is set to “YES” (page 34) and the audio signal is output from the SUB WOOFER jack.
2 LFE	Lights up when the disc being played back contains an LFE (Low Frequency Effect) channel and the LFE channel signal is actually being reproduced.
3 SP	Lights up when the receiver is turned on. This indicator does not light up if a headphone is connected to the PHONES jack.
4 DIGITAL	Lights up when Dolby Digital signals are input. Note When playing a Dolby Digital format disc, be sure that you have made digital connections and that INPUT MODE is not set to “ANALOG” (page 53).

Name	Function
5 PRO LOGIC (II)	Lights up when the receiver applies Pro Logic processing to 2 channel signals in order to output the center and surround channel signals. “DIGITAL PRO LOGIC II” lights up when the Pro Logic II Movie/Music decoder is activated. However, both indicators do not light up if both the center and surround speakers are set to “NO” and “A.F.D. AUTO”, “DOLBY PL”, “PLII MV”, or “PLII MS” is selected. Note Dolby Pro Logic and Dolby Pro Logic II decoding do not function for DTS format signals.
6 DTS	Lights up when DTS signals are input. Note When playing a DTS format disc, be sure that you have made digital connections and that INPUT MODE is not set to “ANALOG” (page 53).
7 MEMORY	Lights up when a memory function, such as Preset Memory (page 50), etc., is activated.
8 Preset station indicators	Lights up when using the receiver to tune in radio stations you have preset. For details on presetting radio stations, see page 49.

Name	Function
9 Tuner indicators	Lights up when using the receiver to tune in radio stations (page 47), etc. Note “RDS” appears for models of area code CEL, CEK only.
10 D.RANGE	Lights up when dynamic range compression is activated (page 33).
11 COAX	Lights up when INPUT MODE is set to “AUTO” and the source signal is a digital signal being input through the COAXIAL jack, or when INPUT MODE is set to “COAX IN” (page 53).
12 OPT	Lights up when INPUT MODE is set to “AUTO” and the source signal is a digital signal being input through the OPTICAL jack, or when INPUT MODE is set to “OPT IN” (page 53).
13 SLEEP	Lights up when the sleep timer is activated (page 55).
14 Playback channel indicators	The letters (L, C, R, etc.) indicate the channels being played back. The boxes around the letters vary to show how the receiver downmixes the source sound (based on the speaker settings). L Front Left R Front Right C Center (monaural) SL Surround Left SR Surround Right S Surround (monaural or the surround components obtained by Pro Logic processing) Example: Recording format (Front/ Surround): 3/2.1 Output channel: When surround speaker is set to “NO” (page 34) Sound Field: A.F.D. AUTO <div style="text-align: center;"> SW L C R SL SR </div>

Rear panel

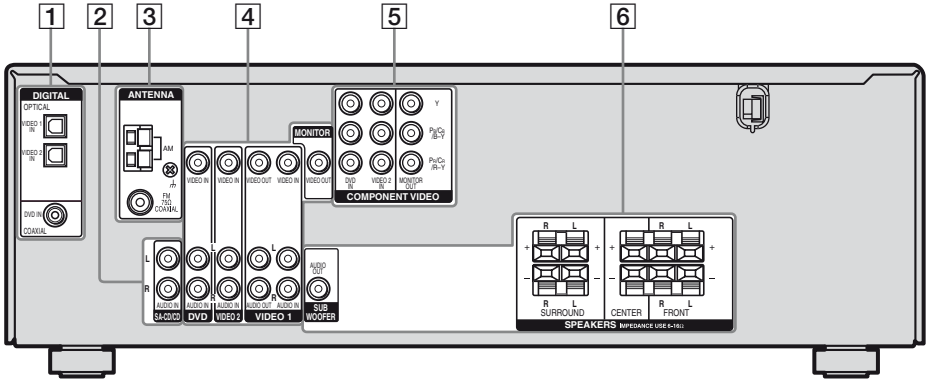

1 DIGITAL INPUT section



OPTICAL IN jack Connects to a DVD player, etc. The COAXIAL jack provides a better quality of loud sound (page 18, 20).



COAXIAL IN jack

2 AUDIO INPUT section



White (L) AUDIO IN/OUT jack Connects to an MD deck or CD player, etc. (page 15).



Red (R)

3 ANTENNA section



FM ANTENNA Connects to the FM wire antenna supplied with this receiver (page 22).



AM ANTENNA Connects to the AM loop antenna supplied with this receiver (page 22).

4 VIDEO/AUDIO INPUT/OUTPUT section



White (L) AUDIO IN/OUT jack Connects the video and audio jacks of a VCR or a DVD player (page 17, 18, 19, 20, 21).



Red (R)



Yellow VIDEO IN/OUT jack*

5 COMPONENT VIDEO INPUT/OUTPUT section



Green COMPONENT VIDEO INPUT/OUTPUT jack* Connects to a DVD player, TV, or a satellite tuner. You can enjoy high quality image (page 17, 19, 20).



Blue



Red

6 SPEAKER section



Connects to speakers (page 13).



Connects to sub woofer (page 13).

* You can watch the selected input image when you connect the MONITOR jack to a TV monitor (page 17).

Remote commander

You can operate the receiver with the supplied remote. You can also use the remote to control the Sony audio/video components that the remote is assigned to operate (page 55).



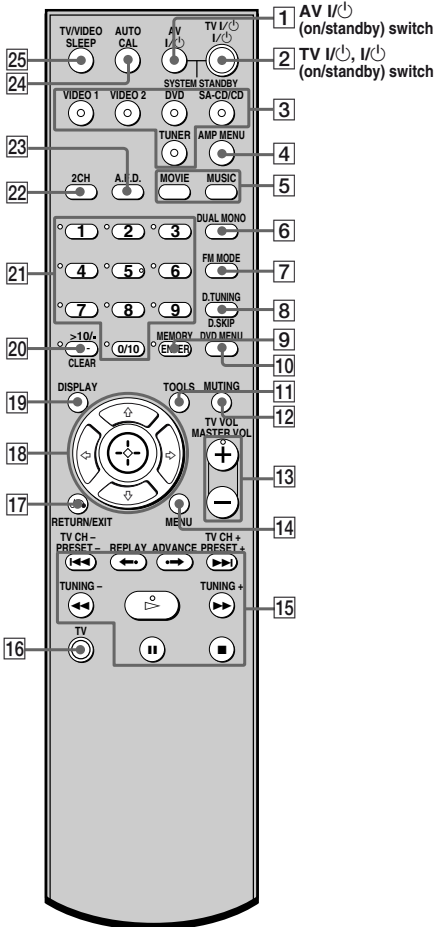



RM-AAU006



Name	Function
1 AV I/⏻	Press to turn on or off the Sony audio/video components that the remote is assigned to operate (page 55). If you press I/⏻ (2) at the same time, it will turn off the receiver and other components (SYSTEM STANDBY). Note The function of the AV I/⏻ switch changes automatically each time you press the input buttons (3).
2 TV I/⏻	Press TV I/⏻ and TV (16) at the same time to turn the TV on or off.
I/⏻	Press to turn the receiver on or off. To turn off all components, press I/⏻ and AV I/⏻ (1) at the same time (SYSTEM STANDBY).
3 Input buttons	Press one of the buttons to select the component you want to use. When you press any of the input buttons, the receiver turns on. The buttons are factory assigned to control Sony components as follows. You can change the button assignments following the steps in "Changing button assignments" on page 55.
Button	Assigned Sony component
VIDEO 1	VCR (VTR mode 3)
VIDEO 2	VCR (VTR mode 2)
DVD	DVD player
SA-CD/CD	Super Audio CD/CD player
TUNER	Built-in tuner
4 AMP MENU	Press to display the menu of the receiver. Then, use the control buttons to perform menu operations.
5 MOVIE, MUSIC	Press to select sound fields for movie or music.

continued

Name	Function
6 DUAL MONO	Press to select the language you want during digital broadcast.
7 FM MODE	Press to select FM monaural or stereo reception.
8 D.TUNING	Press to enter direct tuning mode.
D.SKIP	Press to skip disc of the CD player or DVD player (multi-disc changer only).
9 ENTER	Press to enter the value after selecting a channel, disc or track using the numeric buttons.
MEMORY	Press to store a station.
10 DVD MENU	Press to display the menu of the DVD player on the TV screen. Then, use the control buttons to perform menu operations.
11 TOOLS	Press to display options applicable to the entire disc (e.g. disc protection), recorder (e.g. audio settings during recording), or multiple items on a list menu (e.g. erasing multiple titles).
12 MUTING	Press to mute the sound.
13 TV VOL +^a/-	Press TV VOL +/- and TV (16) at the same time to adjust the TV volume level.
MASTER VOL +^a/-	Press to adjust the volume level of all speakers at the same time.
14 MENU	Press to display the menus of the VCR, DVD player, or satellite tuner on the TV screen. Then, use the control buttons to perform menu operations.

Name	Function
15 	Press to skip tracks of the CD player, DVD player, MD deck, or tape deck.
REPLAY  ADVANCE 	Press to replay the previous scene or fast forward the current scene of the VCR or DVD player.
	Press to – search tracks in the forward/backward direction of the DVD player. – fast forward/rewind of the VCR, CD player, MD deck, or tape deck.
	Press to start playback of the VCR, CD player, DVD player, MD deck, or tape deck.
II	Press to pause playback or recording of the VCR, CD player, DVD player, MD deck, or tape deck. (Also starts recording with components in recording standby.)
	Press to stop playback of the VCR, CD player, DVD player, MD deck, or tape deck.
TV CH +/-	Press TV CH +/- and TV (16) at the same time to select preset TV channels.
PRESET +/-	Press to select – preset stations. – preset channels of the VCR or satellite tuner.
TUNING +/-	Press to scan a station.
16 TV	To activate the buttons with orange printing, press TV and the button with orange printing simultaneously.
17 RETURN/EXIT 	Press to – return to the previous menu. – exit the menu while the menu or on-screen guide of the VCR, DVD player, or satellite tuner is displayed on the TV screen.

Name	Function
18 Control buttons	After pressing AMP MENU (4), DVD MENU (10), or MENU (14), press the control button ▲ , ▼ , ◀ or ▶ to select the settings. When you press DVD MENU or MENU, press the control button to enter the selection.
19 DISPLAY	Press to <ul style="list-style-type: none"> – select information displayed on the receiver's display (for TUNER input only). – select information displayed on the TV screen of the VCR, satellite tuner, CD player, DVD player, or MD deck.
20 -/--	Press -/-- and TV (16) at the same time to select the channel entry mode, either one or two digits of the TV.
>10/•	Press to select <ul style="list-style-type: none"> – track numbers over 10 of the VCR, satellite tuner, CD player or MD deck. – channel numbers of the Digital CATV terminal.
CLEAR	Press to <ul style="list-style-type: none"> – clear a mistake when you press the incorrect numeric button. – return to continuous playback, etc. of the satellite tuner or DVD player.
21 Numeric buttons (number 5^a)	Press to <ul style="list-style-type: none"> – preset/tune to preset stations. – select track numbers of the CD player, DVD player or MD deck. Press 0/10 to select track number 10. – select channel numbers of the VCR or satellite tuner. Press the numeric buttons and TV (16) at the same time to select the TV channels.
22 2CH	Press to select 2CH STEREO mode.
23 A.F.D.	Press to select A.F.D. mode.
24 AUTO CAL	Press to activate the Auto Calibration function.

Name	Function
25 TV/VIDEO	Press TV/VIDEO and TV (16) at the same time to select the input signal (TV input or video input).
SLEEP	Press to activate the Sleep Timer function and the duration which the receiver turns off automatically.

^{a)}The number 5, MASTER VOL +, TV VOL +, and  buttons have tactile dots. Use the tactile dots as references when operating the receiver.

Notes

- Some functions explained in this section may not work depending on the model.
- The above explanation is intended to serve as an example only. Therefore, depending on the component, the above operation may not be possible or may operate differently than described.

1: Installing speakers

To fully enjoy theater-like multi channel surround sound requires five speakers (two front speakers, a center speaker, and two surround speakers) and a sub woofer (5.1 channel).

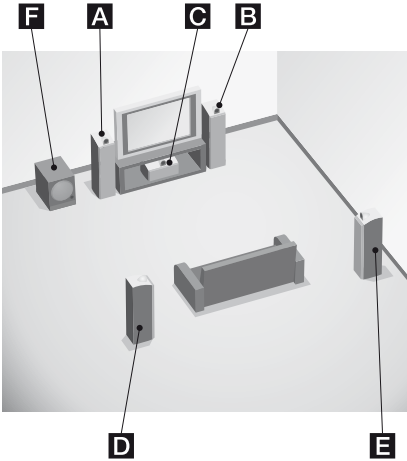

A Front speaker (L)

B Front speaker (R)

C Center speaker

D Surround speaker (L)

E Surround speaker (R)

F Sub woofer

Tip

Since the sub woofer does not emit highly directional signals, you can place it wherever you want.

2: Connecting speakers

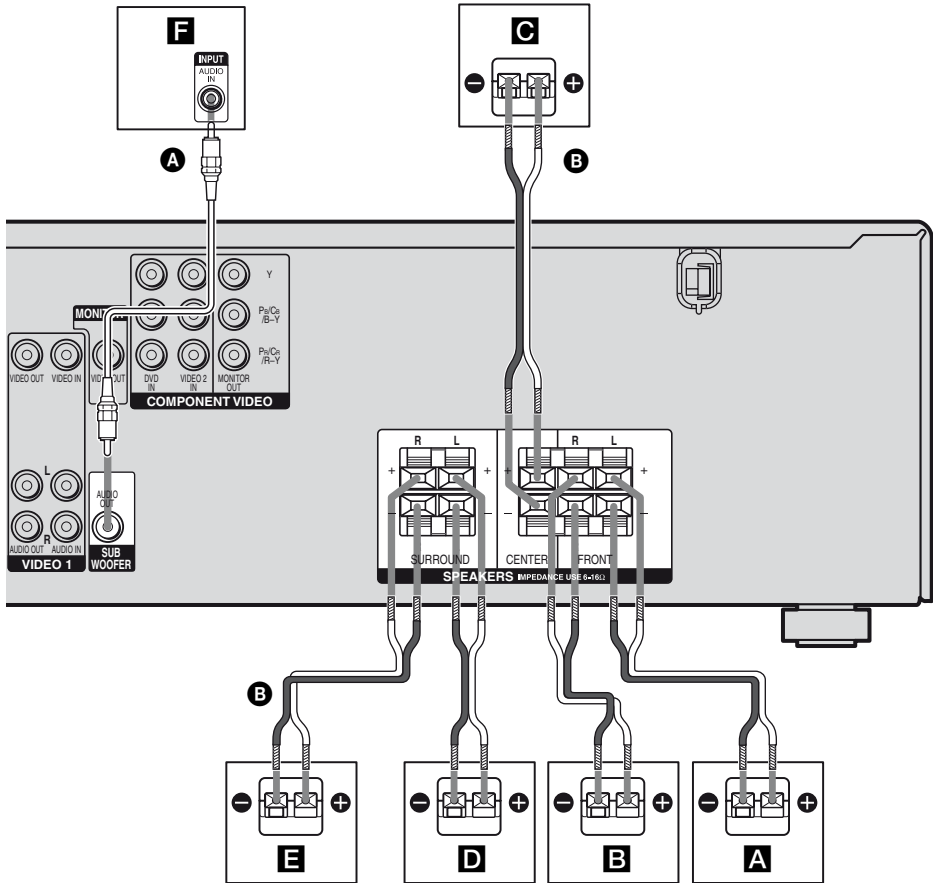

A Monaural audio cord (not supplied)

B Speaker cords (not supplied)

A Front speaker (L)

B Front speaker (R)

C Center speaker

D Surround speaker (L)

E Surround speaker (R)

F Sub woofer^{a)}

^{a)} When you connect a sub woofer with an auto standby function, turn off the function when watching movies. If the auto standby function is set to ON, it turns to standby mode automatically based on the level of the input signal to a sub woofer, then sound may not be output.

3a: Connecting the audio components

How to hook up your components

This section describes how to hook up your components to this receiver.

After hooking up all your components, proceed to “4: Connecting the antennas” (page 22).

Connecting audio components

The following illustration shows how to connect a component which has analog jacks such as Super Audio CD player or CD player.

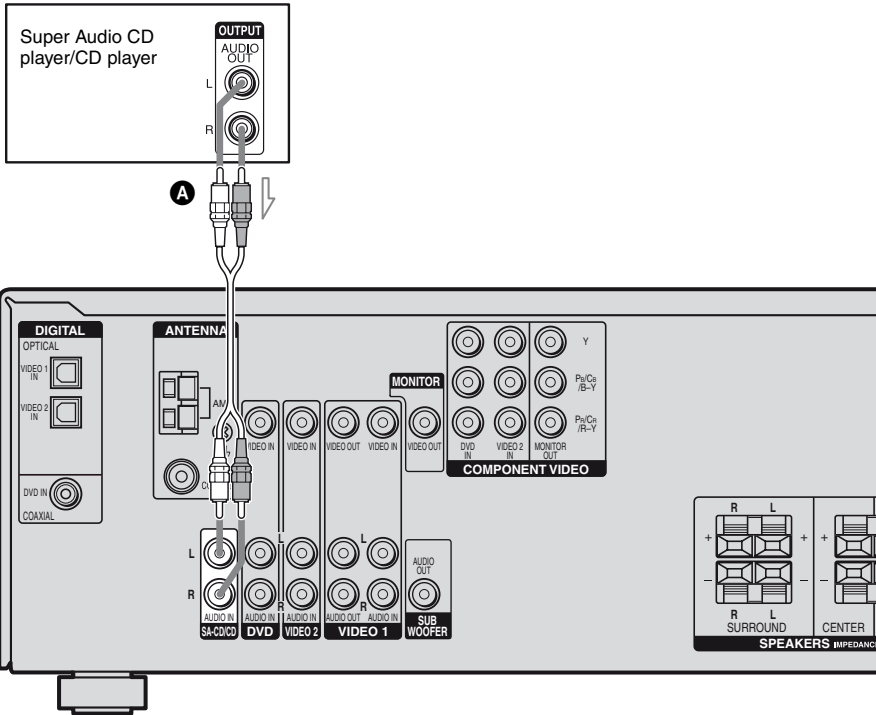

A Audio cord (not supplied)

3b: Connecting the video components

How to hook up your components

This section describes how to hook up your components to this receiver. Before you begin, refer to “Component to be connected” below for the pages which describe how to connect each component.

After hooking up all your components, proceed to “4: Connecting the antennas” (page 22).

Component to be connected

Component	Page
TV monitor	17
DVD player/DVD recorder	18
Satellite tuner	20
VCR	21

Video input/output jack to be connected

The image quality depends on the connecting jack. Refer to the illustration that follows. Select the connection according to the jacks on your components.

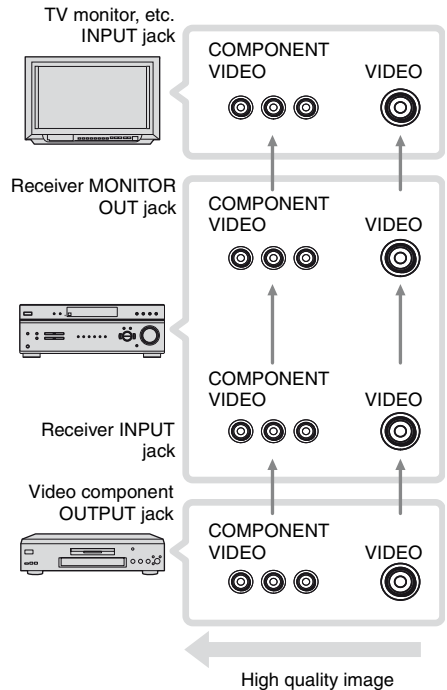

Notes

- Connect image display components such as a TV monitor or a projector to the MONITOR OUT jack on the receiver.
- Turn on the receiver when the video and audio of a playback component are being output to a TV through the receiver. If the power supply of the receiver is not on, neither video nor audio is transmitted.

Hooking up a TV monitor

The image from a visual component connected to this receiver can be displayed on a TV screen.

It is not necessary to connect all the cables. Connect video cords according to the jacks of your components.

Notes

- Connect image display components such as a TV monitor or a projector to the MONITOR OUT jack on the receiver.
- Turn on the receiver when the video and audio of a playback component are being output to a TV via the receiver. If the power supply of the receiver is not turned on, neither video nor audio is transmitted.

Tip

You can watch the selected input image when you connect the MONITOR OUT jack to a TV monitor.

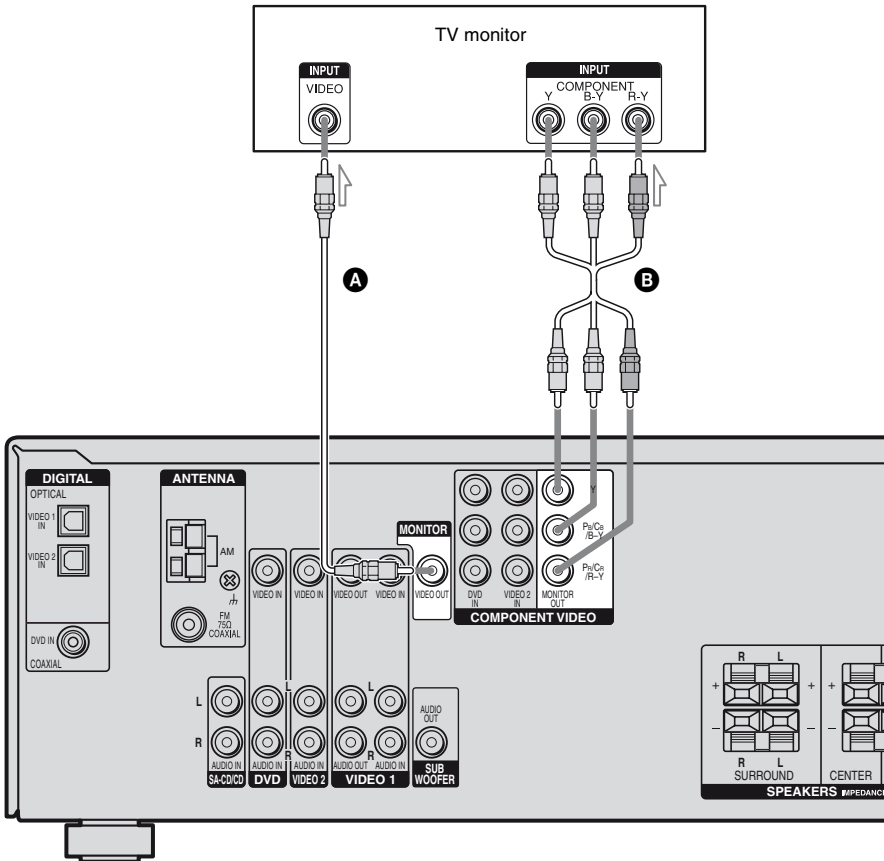

- A** Video cord (not supplied)
- B** Component video cord (not supplied)

Hooking up a DVD player/DVD recorder

The following illustration shows how to connect a DVD player/DVD recorder. It is not necessary to connect all the cables. Connect audio and video cords according to the jacks of your components.

① Connecting audio

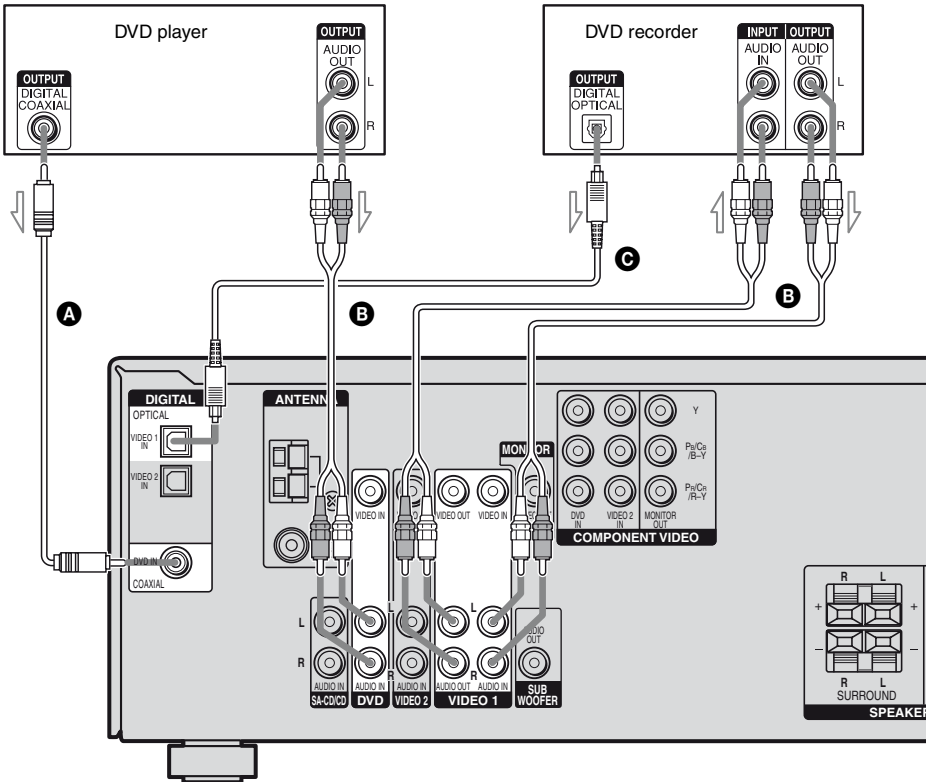

- Ⓐ Coaxial digital cord (not supplied)
- Ⓑ Audio cord (not supplied)
- Ⓒ Optical digital cord (not supplied)

Notes

- To input multi channel digital audio from the DVD player, set the digital audio output setting on the DVD player. Refer to the operating instructions supplied with the DVD player.
- When connecting optical digital cords, insert the plugs straight in until they click into place.
- Do not bend or tie optical digital cords.

Tip

All the digital audio jacks are compatible with 32 kHz, 44.1 kHz, 48 kHz, and 96 kHz sampling frequencies.

② Connecting video

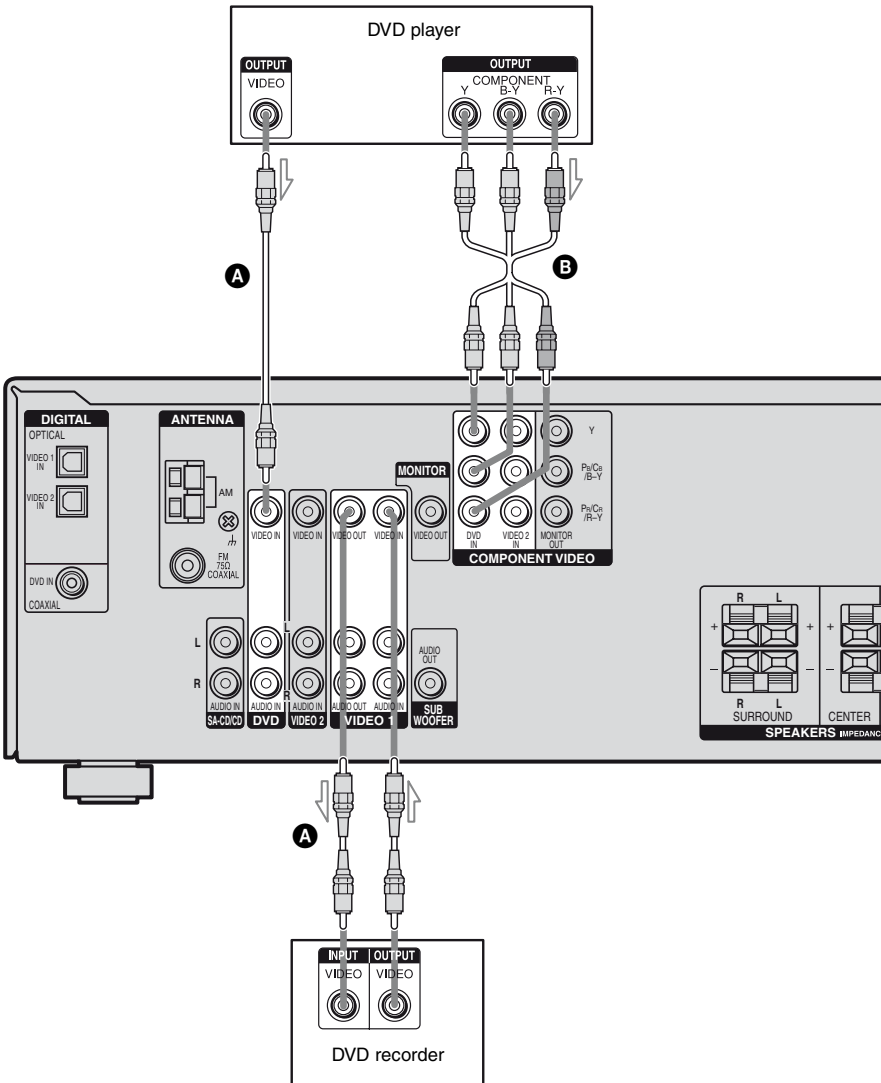

- A** Video cord (not supplied)
- B** Component video cord (not supplied)

If you connect a DVD recorder

- Be sure to change the factory setting of the VIDEO 1 input button on the remote so that you can use the button to control your DVD recorder. For details, see “Changing button assignments” (page 55).
- You can also rename the VIDEO 1 input so that it can be displayed on the receiver’s display. For details, see “Naming inputs” (page 54).

Hooking up a satellite tuner

The following illustration shows how to connect a satellite tuner.

It is not necessary to connect all the cables. Connect audio and video cords according to the jacks of your components.

Notes

- When connecting optical digital cords, insert the plugs straight in until they click into place.
- Do not bend or tie optical digital cords.

Tip

All the digital audio jacks are compatible with 32 kHz, 44.1 kHz, 48 kHz, and 96 kHz sampling frequencies.

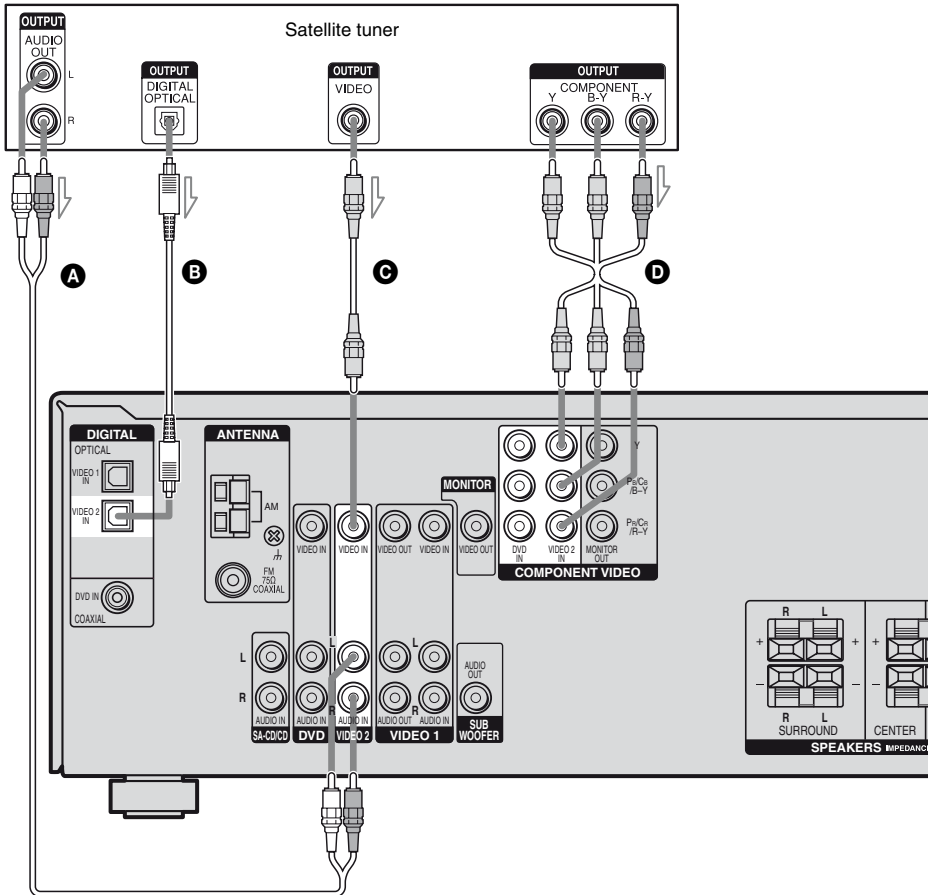

- A** Audio cord (not supplied)
- B** Optical digital cord (not supplied)
- C** Video cord (not supplied)
- D** Component video cord (not supplied)

Hooking up components with analog video and audio jack

The following illustration shows how to connect a component which has analog jacks such as a VCR, etc.

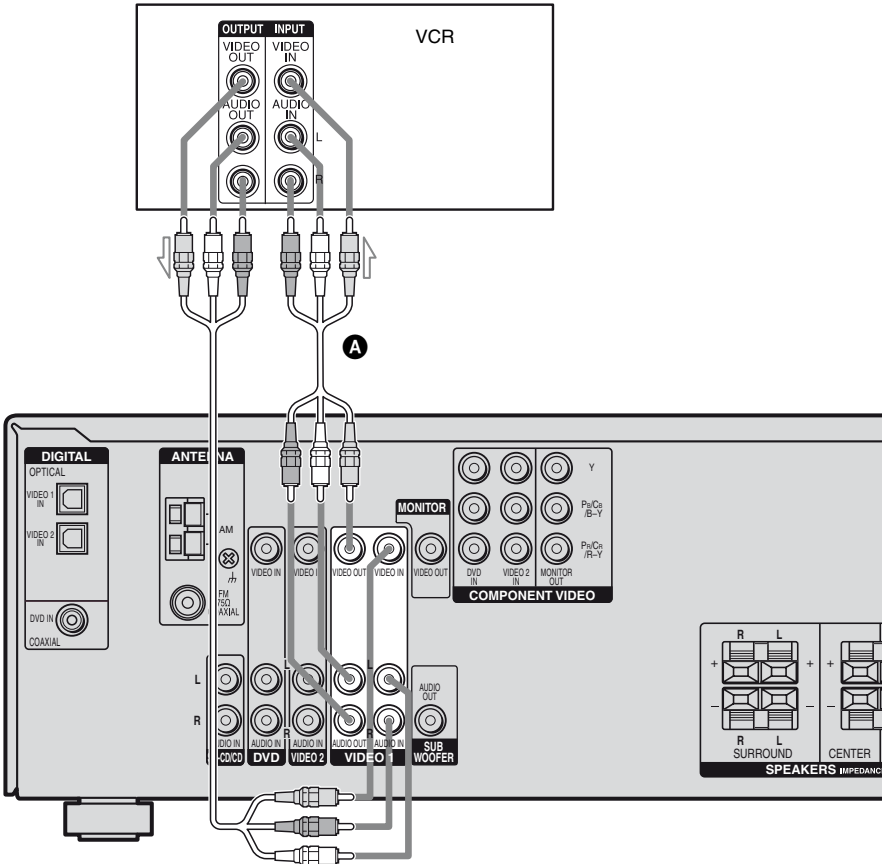

A Audio/video cord (not supplied)

4: Connecting the antennas

Connect the supplied AM loop antenna and FM wire antenna.

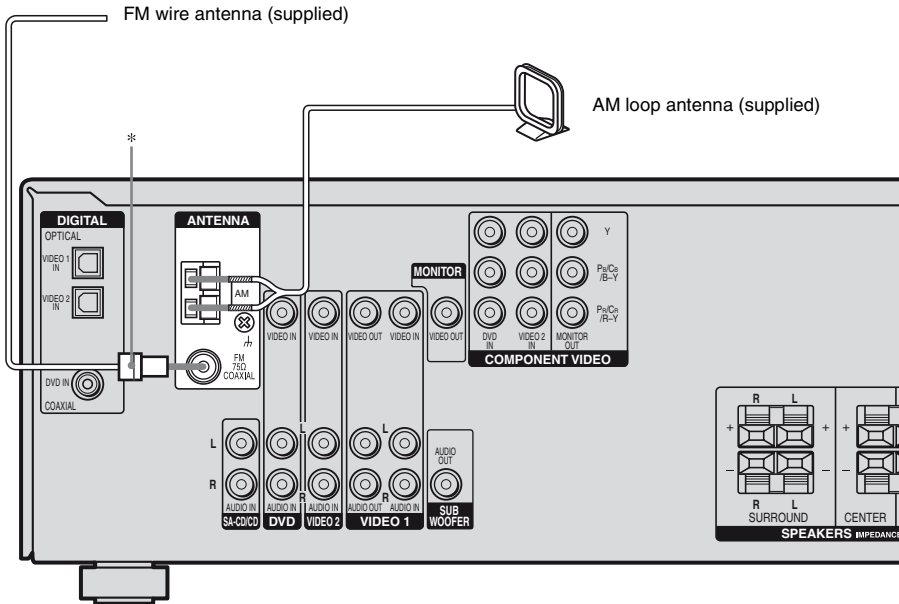

* The shape of the connector varies depending on the area code of this receiver.

Notes

- To prevent noise pickup, keep the AM loop antenna away from the receiver and other components.
- Be sure to fully extend the FM wire antenna.
- After connecting the FM wire antenna, keep it as horizontal as possible.

5: Preparing the receiver and the remote

Connecting the AC power cord

Connect the AC power cord to a wall outlet.

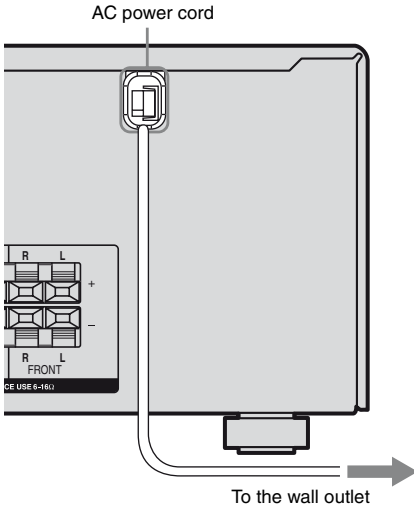

Note

Install this system so that the power cord can be unplugged from the wall socket immediately in the event of trouble.

Performing initial setup operations

Before using the receiver for the first time, initialize the receiver by performing the following procedure. This procedure can also be used to return settings you have made to their factory defaults.

Be sure to use the buttons on the receiver for this operation.

1,2

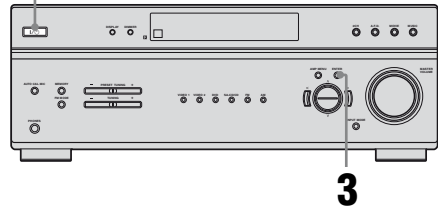

1 Press I/⏻ to turn off the receiver.

2 Hold down I/⏻ for 5 seconds. “PUSH” and “ENTER” appears on the display alternately.

3 Press ENTER.

After “CLEARING” appears on the display for a while, “CLEARED” appears.

The following items are reset to their factory settings.

- All settings in the LEVEL, TONE, SUR, TUNER, AUDIO and SYSTEM menus.
- The sound field memorized for each input and preset station.
- All sound field parameters.
- All preset stations.
- All index names for inputs and preset stations.
- MASTER VOLUME is set to “VOL MIN”.
- Input is set to “DVD”.

Inserting batteries into the remote

Insert two R6 (size-AA) batteries in the RM-AAU006 remote commander. Observe the correct polarity when installing batteries.

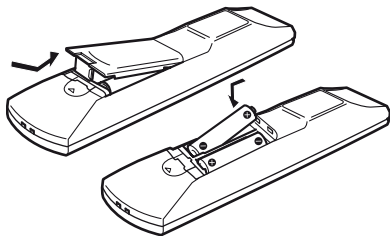

Notes

- Do not leave the remote in an extremely hot or humid place.
- Do not use a new battery with old ones.
- Do not mix alkaline batteries and other kinds of batteries.
- Do not expose the remote sensor to direct sunlight or lighting apparatuses. Doing so may cause a malfunction.
- If you do not intend to use the remote for an extended period of time, remove the batteries to avoid possible damage from battery leakage and corrosion.

Tip

Under normal conditions, the batteries should last for about 3 months. When the remote no longer operates the receiver, replace all the batteries with new ones.

6: Calibrating the appropriate settings automatically (AUTO CALIBRATION)

This receiver is equipped with D.C.A.C. (Digital Cinema Auto Calibration) Technology which allows you to perform automatic calibration as follows:

- Check the connection between each speaker and the receiver.
- Adjust the speaker level.
- Measure the distance of each speaker to your listening position.

You can also adjust the speaker levels and balance manually. For details, see “7: Adjusting the speaker levels and balance (TEST TONE)” (page 27).

Before you perform Auto Calibration

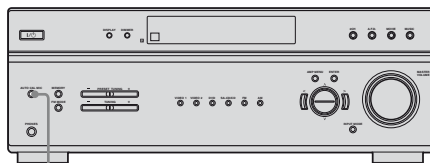

1

- 1** Connect the supplied ECM-AC2 optimizer microphone to the AUTO CAL MIC jack.
- 2** Place the optimizer microphone at your listening position.
- 3** Place the speakers so that the speakers are facing the optimizer microphone.

Tips

- You can also fix the optimizer microphone to a tripod (not supplied) and place the tripod at your listening position.
- Be sure to remove any obstacles in the path between the optimizer microphone and the speakers.
- When you face the speaker towards the optimizer microphone, you will get a more accurate measurement.

Performing Auto Calibration

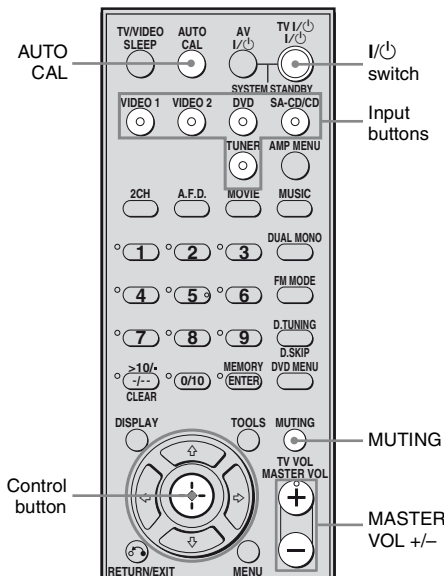

Press AUTO CAL.

The following appears on the display.

A.CAL [5] → A.CAL [4] → A.CAL [3] → A.CAL [2] → A.CAL [1]

The table below shows the display when measurement starts.

Measurement for	Display
Environment noise level	NOISE.CHK
Speaker connection	MEASURE and SP DET. appears alternately*
Speaker level	MEASURE and GAIN appears alternately*
Speaker distance	MEASURE and DISTANCE appears alternately*

* The corresponding speaker indicator lights up in the display during measurement.

When measurement ends, “COMPLETE” appears on the display and the settings are registered.

Notes

- Auto Calibration cannot detect the sub woofer. Therefore, all sub woofer settings will be maintained.
- You cannot select Auto Calibration when headphone is connected.
- The measurement process will take a few minutes to complete.

Tips

- When Auto Calibration starts:
 - Stand some distance from the speakers and the listening position to avoid measurement failure. This is because test signals are output from the speakers during measurement.
 - Avoid making noise to get a more accurate measurement.
- The Auto Calibration function will be canceled when you do the following during the measurement process:
 - Press I/O, input buttons or MUTING.
 - Change the volume level.
 - Press AUTO CAL again.

Error and warning codes

Error codes

When an error is detected during Auto Calibration, an error code will appear on the display cyclically after each measurement process as follows:

Error code → blank display → (error code → blank display)^{a)} → PUSH → blank display → ENTER

^{a)} Appears when there are more than one error code.

To rectify the error

- 1 Record down the error code.
- 2 Press the control button.
You can also use ENTER on the receiver.
- 3 Press I/⏻ to turn off the receiver.
- 4 Rectify the error.
For details, see “Error code and remedies” below.
- 5 Turn on the receiver and perform Auto Calibration again (page 25).

Error code and remedies

Error code	Explanation	Remedies
ERROR 10	The environment is too noisy.	Make sure the environment is quiet during Auto Calibration.
ERROR 11	The speakers are placed too near the optimizer microphone.	Place your speakers further away from the optimizer microphone.
ERROR 20	Front speakers are not detected or only one front speaker is detected.	Check the front speaker connection.
ERROR 21	Only one surround speaker is detected.	Check the surround speaker connection.

Warning codes

During Auto Calibration, the warning code provides information on the measurement result. The warning code will appear on the display cyclically as follows:

Warning code → blank display → (warning code → blank display)^{b)} → PUSH → blank display → ENTER

^{b)} Appears when there are more than one warning code.

You can choose to ignore the warning code as the Auto Calibration function will automatically adjust the settings. You can also change the settings manually.

To change the settings manually

- 1 Record down the warning code.
- 2 Press the control button.
You can also use ENTER on the receiver.
- 3 Press I/⏻ to turn off the receiver.
- 4 Follow the solution provided in the “Warning code and solution” below.
- 5 Turn on the receiver and perform Auto Calibration again (page 25).

Warning code and solution

Warning code	Explanation	Solution
WARN. 40	The environment is noisy.	Make sure the environment is quiet during Auto Calibration.
WARN. 60	The front speakers balance are out of range.	Reposition your front speakers. ^{c)}
WARN. 62	The center speaker level is out of range.	Reposition your center speaker. ^{d)}
WARN. 63	The surround left speaker level is out of range.	Reposition your surround left speaker. ^{e)}
WARN. 64	The surround right speaker level is out of range.	Reposition your surround right speaker. ^{f)}

Warning code	Explanation	Solution
WARN. 70	The front speakers distance are out of range.	Reposition your front speakers. ^{c)}
WARN. 72	The center speaker distance is out of range.	Reposition your center speaker. ^{d)}
WARN. 73	The surround left speaker distance is out of range.	Reposition your surround left speaker. ^{e)}
WARN. 74	The surround right speaker distance is out of range.	Reposition your surround right speaker. ^{f)}

^{c)} For details, refer “Front speaker distance” (page 39).

^{d)} For details, refer “Center speaker distance” (page 39).

^{e)} For details, refer “Surround left speaker distance” (page 40).

^{f)} For details, refer “Surround right speaker distance” (page 40).

7: Adjusting the speaker levels and balance (TEST TONE)

You can adjust the speaker levels and balance while listening to the test tone from your listening position.

Tip

The receiver employs a test tone with a frequency centered at 800 Hz.

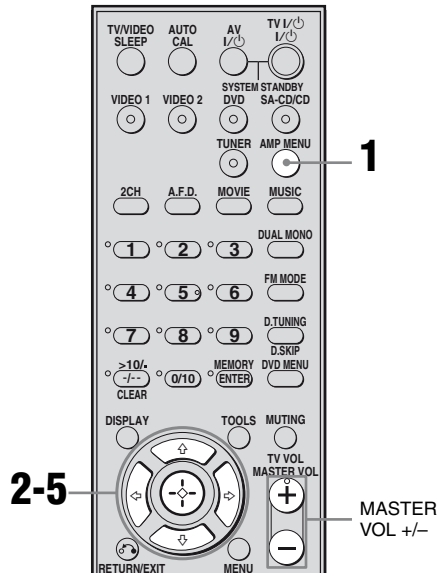

1 Press AMP MENU.

“1-LEVEL” appears on the display.

2 Press the control button or control button → to enter the menu.

You can also use ENTER or > on the receiver.

3 Press control button ↑/↓ repeatedly to select “T. TONE”.

You can also use ^ or v on the receiver.

continued

4 Press the control button or control button → to enter the parameter.

You can also use ENTER or > on the receiver.

5 Press control button ↕ repeatedly to select “T. TONE Y”.

You can also use Λ or V on the receiver. The test tone is output from each speaker in sequence as follows:
 Front left → Center → Front right → Surround right → Surround left → Sub woofer

6 Adjust the speaker levels and balance using the LEVEL menu so that the level of the test tone sounds the same from each speaker.

For details, see “Adjusting the level (LEVEL menu)” (page 35).

Tips

- To adjust the level of all speakers at the same time, press MASTER VOL +/- . You can also use MASTER VOLUME on the receiver.
- The adjusted value are shown on the display during adjustment.

7 Repeat steps 1 to 5 to select “T. TONE N”.

The test tone turns off.

Playback

Selecting a component

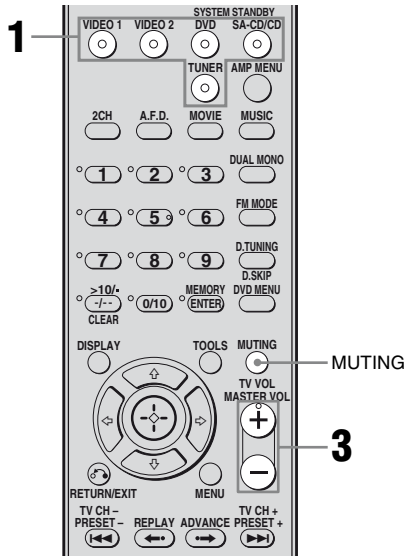

1 Press the input button to select a component.

The selected input appears on the display.

Selected input [Display]	Components that can be played back
VIDEO 1 or VIDEO 2 [VIDEO 1 or VIDEO 2]	VCR, etc., connected to the VIDEO 1 or VIDEO 2 jack
DVD [DVD]	DVD player, etc., connected to DVD jack
SA-CD/CD [SA-CD/CD]	Super Audio CD/CD player, etc., connected to the SA-CD/CD jack
TUNER [FM or AM band]	Built-in radio tuner

2 Turn on the component and start playback.

3 Press MASTER VOL +/- to adjust the volume.

You can also use MASTER VOLUME on the receiver.

To mute the sound

Press MUTING.

The muting function will be canceled when you do the following.

- Press MUTING again.
- Increase the volume.
- Turn off the receiver.

To avoid damaging your speakers

Before you turn off the receiver, be sure to turn down the volume level.

Listening/Watching a component

Listening to a Super Audio CD/CD

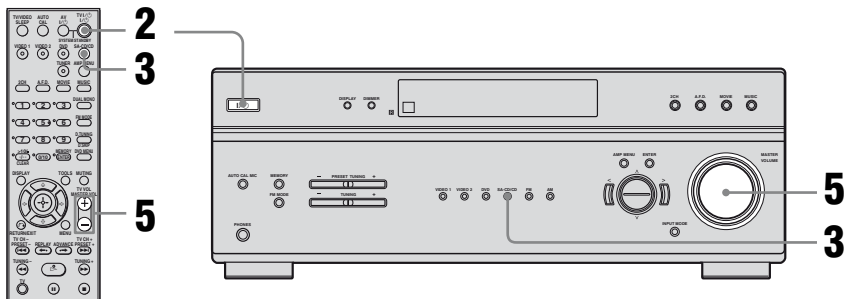

Notes

- The operation is described for a Sony Super Audio CD player.
- Refer to the operating instructions supplied with the Super Audio CD player or CD player.

Tips

- You can select the sound field to suit the music. Refer to page 43 for details.
Recommended sound fields:
Classical: HALL
Jazz: JAZZ
Live concert: CONCERT
- You can listen to the sound that was recorded in the 2 channel format from all speakers (multi channel). Refer to page 42 for details.

- 1** Turn on the Super Audio CD player/CD player, then place the disc on the tray.
- 2** Turn on the receiver.
- 3** Press SA-CD/CD.
- 4** Playback the disc.
- 5** Adjust to a suitable volume.
- 6** After you have finished listening to the Super Audio CD/CD, eject the disc and turn off the receiver and Super Audio CD player/CD player.

Watching a DVD

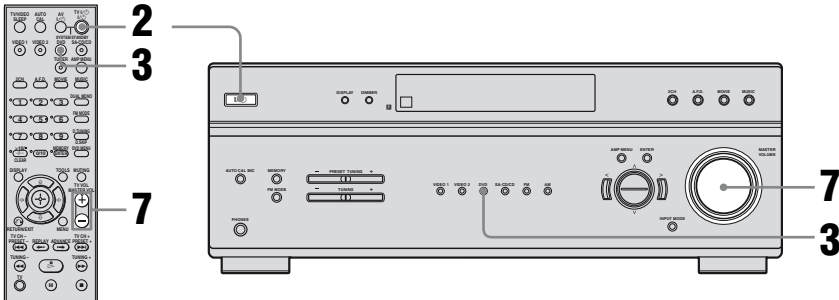

Notes

- Refer to the operating instructions supplied with the TV and DVD player.
- Check the following if you cannot listen to multi channel sound.
 - Be sure this receiver is connected to the DVD player via a digital connection.
 - Be sure the digital audio output of the DVD player is set up properly.

Tips

- Select the sound format of the disc to be played, if necessary.
- You can select the sound field to suit the movie/music. Refer to page 43 for details.
Recommended sound fields:
Movie: C.ST.EX
Music: CONCERT

- 1 Turn on the TV and DVD player.**
- 2 Turn on the receiver.**
- 3 Press DVD.**
- 4 Switch the input of the TV so that an image of the DVD is displayed.**
- 5 Set up the DVD player.**
Refer to “Quick Setup Guide” supplied with the receiver.
- 6 Playback the disc.**
- 7 Adjust to a suitable volume.**
- 8 After you have finished watching the DVD, eject the disc and turn off the receiver, TV and DVD player.**

Amplifier Operations

Navigating through menus

By using the amplifier menus, you can make various adjustments to customize the receiver.

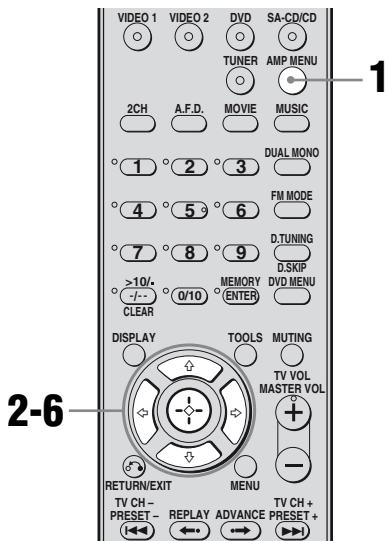

1 Press AMP MENU.

“1-LEVEL” appears on the display.

2 Press control button \uparrow/\downarrow repeatedly to select the menu you want.

You can also use \wedge or \vee on the receiver.

3 Press the control button or control button \rightarrow to enter the menu.

You can also use ENTER or $>$ on the receiver.

4 Press control button \uparrow/\downarrow repeatedly to select the parameter you want to adjust.

You can also use \wedge or \vee on the receiver.

5 Press the control button or control button \rightarrow to enter the parameter.

You can also use ENTER or $>$ on the receiver.

6 Press control button \uparrow/\downarrow repeatedly to select the setting you want.

You can also use \wedge or \vee on the receiver. The setting is entered automatically.

To return to the previous display

Press control button \leftarrow .

You can also use $<$ on the receiver.

To exit the menu

Press AMP MENU.

Note

Some parameters and settings may appear dimmed on the display. This means that they are either unavailable or fixed and unchangeable.

Overview of the menus

The following options are available in each menu. For details on navigating through menus, see page 32.

Menu [Display]	Parameters [Display]	Settings	Initial setting
LEVEL (35) [1-LEVEL]	Test tone ^{a)} [T. TONE]	T. TONE Y, T. TONE N	T. TONE N
	Front speaker balance ^{a)} [FRT BAL]	BAL. L +1 to BAL. L +8, BALANCE, BAL. R +1 to BAL. R +8	BALANCE
	Center speaker level [CNT LVL]	CNT -10 dB to CNT +10 dB (1 dB step)	CNT 0 dB
	Surround left speaker level [SL LVL]	SUR L -10 dB to SUR L +10 dB (1 dB step)	SUR L 0 dB
	Surround right speaker level [SR LVL]	SUR R -10 dB to SUR R +10 dB (1 dB step)	SUR R 0 dB
	Sub woofer level [SW LVL]	SW -10 dB to SW +10 dB (1 dB step)	SW 0 dB
	Dynamic range compressor ^{a)} [D. RANGE]	COMP. OFF, COMP. STD, COMP. MAX	COMP. OFF
TONE (36) [2-TONE]	Front speaker bass level [BASS LVL]	BASS -6 dB to BASS +6 dB (1 dB step)	BASS 0 dB
	Front speaker treble level [TRE LVL]	TRE -6 dB to TRE +6 dB (1 dB step)	TRE 0 dB
SUR (36) [3-SUR]	Sound field selection ^{a)} [S.F. SELECT]	2CH ST., A.F.D. AUTO, DOLBY PL, PLII MV, PLII MS, MULTI ST., C.ST.EX A, C.ST.EX B, C.ST.EX C, HALL, JAZZ, CONCERT	2CH ST. for: TUNER, SA-CD/CD; A.F.D. AUTO for: DVD, VIDEO 1, 2
	Effect level ^{a)} [EFFECT]	EFCT. MIN, EFCT. STD, EFCT. MAX	EFCT. STD
TUNER (37) [4-TUNER]	FM station receiving mode ^{a)} [FM MODE]	FM AUTO, FM MONO	FM AUTO
	Naming preset stations ^{a)} [NAME IN]		

Menu [Display]	Parameters [Display]	Settings	Initial setting
AUDIO (37) [5-AUDIO]	Digital audio input decoding priority ^{a)} [DEC. PRI.]	DEC. AUTO, DEC. PCM	DEC. AUTO for: VIDEO 1, 2; DEC. PCM for: DVD
	Digital broadcast language selection ^{a)} [DUAL]	DUAL M/S, DUAL M, DUAL S, DUAL M+S	DUAL M
	A/V Sync ^{a)} [A.V. SYNC.]	A.V.SYNC. Y, A.V.SYNC. N	A.V.SYNC. N
	Naming inputs ^{a)} [NAME IN]		
SYSTEM (38) [6-SYSTEM]	Sub woofer ^{a)} [SW SPK]	YES, NO	YES
	Front speakers ^{a)} [FRT SPK]	LARGE, SMALL	LARGE
	Center speakers ^{a)} [CNT SPK]	LARGE, SMALL, NO	LARGE
	Surround speakers ^{a)} [SUR SPK]	LARGE, SMALL, NO	LARGE
	Front speaker distance ^{a)} [FRT DIST.]	DIST. 1.0 m to DIST. 7.0 m (0.1 m step)	DIST. 3.0 m
	Center speaker distance ^{a)} [CNT DIST.]	DIST. 1.0 m to DIST. 7.0 m (0.1 m step)	DIST. 3.0 m
	Surround left speaker distance ^{a)} [SL DIST.]	DIST. 1.0 m to DIST. 7.0 m (0.1 m step)	DIST. 3.0 m
	Surround right speaker distance ^{a)} [SR DIST.]	DIST. 1.0 m to DIST. 7.0 m (0.1 m step)	DIST. 3.0 m
	Surround speaker position ^{a)} [SUR POS.]	SIDE/LO, SIDE/HI, BEHD/LO, BEHD/HI	SIDE/LO
	Speaker crossover frequency ^{a)} [CRS. FREQ]	CRS. > 40 Hz to CRS. > 160 Hz	CRS. > 100 Hz
	Brightness of the display ^{a)} [DIMMER]	0% dim, 40% dim, 70% dim	0% dim
	A. CAL (41) [7-A. CAL]	Auto Calibration ^{a)} [AUTO CAL.]	A.CAL YES, A.CAL NO

^{a)}For details, refer to the page in the parentheses.

Adjusting the level

(LEVEL menu)

You can use the LEVEL menu to adjust the balance and level of each speaker. These settings are applied to all sound fields. Select “1-LEVEL” in the amplifier menus. For details on adjusting the parameters, see “Navigating through menus” (page 32) and “Overview of the menus” (page 33).

LEVEL menu parameters

■ T. TONE (Test tone)

Lets you adjust the speaker levels and balance while listening to the test tone from your listening position. For details, see “7: Adjusting the speaker levels and balance (TEST TONE)” (page 27).

■ FRT BAL (Front speaker balance)

Lets you adjust the balance between front left and right speakers.

■ CNT LVL (Center speaker level)

■ SL LVL (Surround left speaker level)

■ SR LVL (Surround right speaker level)

■ SW LVL (Sub woofer level)

■ D. RANGE (Dynamic range compressor)

Lets you compress the dynamic range of the sound track. This may be useful when you want to watch movies at low volumes late at night. Dynamic range compression is possible with Dolby Digital sources only.

- COMP. OFF
The dynamic range is not compressed.
- COMP. STD
The dynamic range is compressed as intended by the recording engineer.
- COMP. MAX
The dynamic range is compressed dramatically.

Tip

Dynamic range compressor lets you compress the dynamic range of the soundtrack based on the dynamic range information included in the Dolby Digital signal. “COMP. STD” is the standard setting, but it only enacts light compression. Therefore, we recommend using the “COMP. MAX” setting. This greatly compresses the dynamic range and lets you view movies late at night at low volumes. Unlike analog limiters, the levels are predetermined and provide a very natural compression.

Adjusting the tone (TONE menu)

You can use the TONE menu to adjust the tonal quality (bass/treble level) of the front speakers. These settings are applied to all sound fields.

Select “2-TONE” in the amplifier menus. For details on adjusting the parameters, see “Navigating through menus” (page 32) and “Overview of the menus” (page 33).

TONE menu parameters

- **BASS LVL (Front speaker bass level)**
- **TRE LVL (Front speaker treble level)**

Settings for the surround sound (SUR menu)

You can use the SUR menu to select the sound field you want for your listening pleasure. Select “3-SUR” in the amplifier menus. For details on adjusting the parameters, see “Navigating through menus” (page 32) and “Overview of the menus” (page 33).

SUR menu parameters

■ **S.F. SELCT (Sound field selection)**

Lets you select the sound field you want. For details, see “Enjoying Surround Sound” (page 42).

Note

The receiver lets you apply the last selected sound field to an input whenever it is selected (Sound Field Link). For example, if you select HALL for the SA-CD/CD input, then change to a different input and then return to SA-CD/CD, HALL will automatically be applied again.

■ **EFFECT (Effect level)**

Lets you adjust the “presence” of the surround effect for sound fields selected with the MOVIE or MUSIC buttons and for “HP THEA” sound field.

- **EFCT. MIN**
The surround effect is minimum.
- **EFCT. STD**
The surround effect is standard.
- **EFCT. MAX**
The surround effect is maximum.

Settings for the tuner

(TUNER menu)

You can use the TUNER menu to set the FM station receiving mode and to name preset stations.

Select “4-TUNER” in the amplifier menus. For details on adjusting the parameters, see “Navigating through menus” (page 32) and “Overview of the menus” (page 33).

TUNER menu parameters

■ FM MODE (FM station receiving mode)

- FM AUTO

This receiver will decode the signal as stereo signal when the radio station is broadcast in stereo.

- FM MONO

This receiver will decode the signal as mono signal regardless of the broadcast signal.

■ NAME IN (Naming preset stations)

Lets you set the name of preset stations. For details, see “Naming preset stations” (page 51).

Settings for the audio

(AUDIO menu)

You can use the AUDIO menu to make settings for the audio to suit your preference.

Select “5-AUDIO” in the amplifier menus. For details on adjusting the parameters, see “Navigating through menus” (page 32) and “Overview of the menus” (page 33).

AUDIO menu parameters

■ DEC. PRI. (Digital audio input decoding priority)

Lets you specify the input mode for the digital signal input to the DIGITAL IN jacks.

- DEC. AUTO

Automatically switches the input mode between DTS, Dolby Digital, or PCM.

- DEC. PCM

PCM signals are given priority (to prevent interruption when playback starts).

However, when other signals are input, there may be no sound depending on the format.

In this case, set to “DEC. AUTO”.

Note

When set to “DEC. AUTO” and the sound from the digital audio jacks (for CD, etc.) is interrupted when playback starts, set to “DEC. PCM”.

■ DUAL (Digital broadcast language selection)

Lets you select the language you want to listen to during digital broadcast. This feature only functions for Dolby Digital sources.

- DUAL M/S (Main/Sub)
Sound of the main language will be output through the front left speaker and sound of the sub language will be output through the front right speaker simultaneously.
- DUAL M (Main)
Sound of the main language will be output.
- DUAL S (Sub)
Sound of the sub language will be output.
- DUAL M+S (Main + Sub)
Mixed sound of both the main and sub languages will be output.

■ A.V. SYNC. (A/V Sync)

- A.V.SYNC. Y (Yes) (Delay time: 68 ms)
The audio output is delayed so that the time gap between the audio output and visual display is minimized.
- A.V.SYNC. N (No) (Delay time: 0 ms)
The audio output is not delayed.

Notes

- This parameter is useful when you use a large LCD or plasma monitor or a projector.
- This parameter is valid only when you use a sound field selected with the 2CH or A.F.D. buttons.
- This parameter is not valid when PCM 96 kHz or DTS 2048 signals are input.

■ NAME IN (Naming inputs)

Lets you set the name of inputs. For details, see “Naming inputs” (page 54).

Settings for the system (SYSTEM menu)

You can use the SYSTEM menu to set the size and distance of the speakers connected to this system.

Select “6-SYSTEM” in the amplifier menus. For details on adjusting the parameters, see “Navigating through menus” (page 32) and “Overview of the menus” (page 33).

SYSTEM menu parameters

■ SW SPK (Sub woofer)

- YES
If you have connected a sub woofer, select “YES”.
- NO
If you have not connected a sub woofer, select “NO”. This activates the bass redirection circuitry and outputs the LFE signals from other speakers.

Tip

In order to take full advantage of the Dolby Digital bass redirection circuitry, we recommend setting the sub woofer’s cut off frequency as high as possible.

■ FRT SPK (Front speakers)

- LARGE
If you connect large speakers that will effectively reproduce bass frequencies, select “LARGE”. Normally, select “LARGE”. When the sub woofer is set to “NO”, the front speakers are automatically set to “LARGE”.
- SMALL
If the sound is distorted, or you feel a lack of surround effects when using multi channel surround sound, select “SMALL” to activate the bass redirection circuitry and output the front channel bass frequencies from the sub woofer. When the front speakers are set to “SMALL”, the center, and surround speakers are also automatically set to “SMALL” (unless previously set to “NO”).

■ CNT SPK (Center speaker)

- LARGE

If you connect a large speaker that will effectively reproduce bass frequencies, select “LARGE”. Normally, select “LARGE”. However, if the front speakers are set to “SMALL”, you cannot set the center speaker to “LARGE”.

- SMALL

If the sound is distorted, or you feel a lack of surround effects when using multi channel surround sound, select “SMALL” to activate the bass redirection circuitry and output the center channel bass frequencies from the front speakers (if set to “LARGE”) or sub woofer.

- NO

If you have not connected a center speaker, select “NO”. The sound of the center channel will be output from the front speakers.

■ SUR SPK (Surround speakers)

- LARGE

If you connect large speakers that will effectively reproduce bass frequencies, select “LARGE”. Normally, select “LARGE”. However, if the front speakers are set to “SMALL”, you cannot set the surround speakers to “LARGE”.

- SMALL

If the sound is distorted, or you feel a lack of surround effects when using multi channel surround sound, select “SMALL” to activate the bass redirection circuitry and output the surround channel bass frequencies from the sub woofer or other “LARGE” speakers.

- NO

If you have not connected surround speakers, select “NO”.

Tip

The “LARGE” and “SMALL” settings for each speaker determine whether the internal sound processor will cut the bass signal from that channel. When the bass is cut from a channel, the bass redirection circuitry sends the corresponding bass frequencies to the sub woofer or other “LARGE” speakers.

However, since bass sounds have a certain amount of directionality, it is best not to cut them, if possible. Therefore, even when using small speakers, you can set them to “LARGE” if you want to output the bass frequencies from that speaker. On the other hand, if you are using a large speaker, but prefer not to have bass frequencies output from that speaker, set it to “SMALL”.

If the overall sound level is lower than you prefer, set all speakers to “LARGE”. If there is not enough bass, you can use the tone to boost the bass levels. For details, see page 33.

■ FRT DIST. (Front speaker distance)

Lets you set the distance from your listening position to the front speakers (A). If both front speakers are not placed an equal distance from your listening position, set the distance as the average distance between the front speakers.

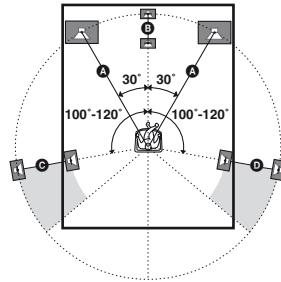

■ CNT DIST. (Center speaker distance)

Lets you set the distance from your listening position to the center speaker. Center speaker distance should be set from a distance equal to the front speaker distance (A) to a distance 1.5 meters closer to your listening position (B).

continued

■ SL DIST. (Surround left speaker distance)

Lets you set the distance from your listening position to the surround left speaker. Surround left speaker distance should be set from a distance equal to the front speaker distance (A) to a distance 4.5 meters closer to your listening position (C).

■ SR DIST. (Surround right speaker distance)

Lets you set the distance from your listening position to the surround right speaker. Surround right speaker distance should be set from a distance equal to the front speaker distance (A) to a distance 4.5 meters closer to your listening position (D).

Tip

The receiver lets you to input the speaker position in terms of distance. However, it is not possible to set the center speaker further than the front speakers.

Also, the center speaker cannot be set more than 1.5 meter closer from the front speakers.

Likewise, the surround speakers can not be set further away from the listening position than the front speakers. And they can be no more than 4.5 meter closer. This is because incorrect speaker placement is not conducive to the enjoyment of surround sound.

Please note that, setting the speaker distance closer than the actual location of the speakers will cause a delay in the output of the sound from that speaker. In other words, the speaker will sound like it is further away.

For example, setting the center speaker distance 1-2 meter closer than the actual speaker position will create a fairly realistic sensation of being “inside” the screen. If you cannot obtain a satisfactory surround effect because the surround speakers are too close, setting the surround speaker distance closer (shorter) than the actual distance will create a larger sound stage.

Adjusting these parameter while listening to the sound often results in much better surround sound. Give it a try!

■ SUR POS. (Surround speaker position)

Lets you specify the location of your surround speakers for proper implementation of the surround effects in the Cinema Studio EX modes (page 44). This setup item is not available when the surround speakers are set to “NO” (page 34).

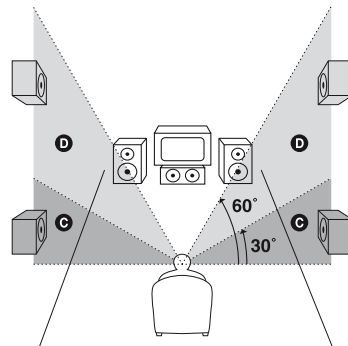
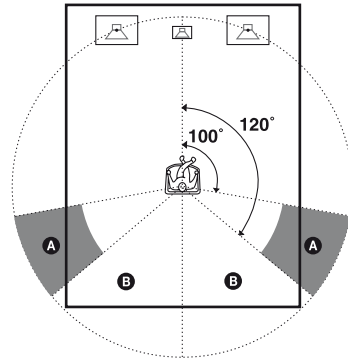

- **SIDE/LO**
Select if the location of your surround speakers corresponds to sections A and C.
- **SIDE/HI**
Select if the location of your surround speakers corresponds to sections A and D.
- **BEHD/LO**
Select if the location of your surround speakers corresponds to sections B and C.
- **BEHD/HI**
Select if the location of your surround speakers corresponds to sections B and D.

Tip

Surround speaker position is designed specifically for implementation of the Cinema Studio EX modes. For other sound fields, speaker position is not so critical.

Those sound fields were designed under the premise that the surround speakers would be located behind the listening position, but presentation remains fairly consistent even with the surround speakers positioned at a rather wide angle. However, if the speakers are pointing toward the listener from the immediate left and right of the listening position, the surround effects become unclear unless set to "SIDE/LO" or "SIDE/HI".

Nevertheless, each listening environment has many variables, such as wall reflections, and you may obtain better results using "BEHD/HI" if your speakers are located high above the listening position, even if they are located to the immediate left and right.

Therefore, although it may result in a setting contrary to the above explanation, we recommend that you playback multi channel surround encoded software and select the setting that provides a good sense of spaciousness and that best succeeds in forming a cohesive space between the surround sound from the surround speakers and the sound of the front speakers. If you are not sure which sounds best, select "BEHD/LO" or "BEHD/HI" and then use the speaker distance parameter and speaker level adjustments to obtain proper balance.

■ CRS. FREQ (Speaker crossover frequency)

Lets you set the bass crossover frequency of the speakers that have been set to "SMALL" on the SYSTEM menu. This setup item is only available when at least one speaker is set to "SMALL" and the corresponding speaker indicator flashes on the display.

■ DIMMER (Brightness of the display)

Lets you adjust the brightness in 3 steps.

Calibrating the appropriate settings automatically

(A. CAL menu)

For details, see "6: Calibrating the appropriate settings automatically (AUTO CALIBRATION)" (page 24).

Enjoying Dolby Digital and DTS Surround sound (AUTO FORMAT DIRECT)

The Auto Format Direct (A.F.D.) mode allows you to listen to higher fidelity sound and select the decoding mode for listening to a 2 channel stereo sound as multi channel sound.

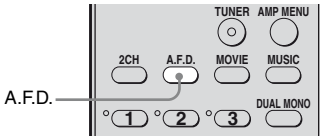

Press A.F.D. repeatedly to select the sound field you want.

For details, see “Types of A.F.D. mode” (page 42).

Types of A.F.D. mode

Decoding mode	A.F.D. mode [Display]	Multi channel audio after decoding	Effect
(Detecting automatically)	A.F.D. AUTO [A.F.D. AUTO]	(Detecting automatically)	Presents the sound as it was recorded/ encoded without adding any surround effects. However, this receiver will generate a low frequency signal for output to the sub woofer when there is no LFE signals.
Dolby Pro Logic	PRO LOGIC [DOLBY PL]	4 channel	Performs Dolby Pro Logic decoding. The source recorded in 2 channel format is decoded into 4.1 channels.
Dolby Pro Logic II	PRO LOGIC II MOVIE [PLII MV]	5 channel	Performs Dolby Pro Logic II Movie mode decoding. This setting is ideal for movies encoded in Dolby Surround. In addition, this mode can reproduce sound in 5.1 channel for watching videos of overdubbed or old movies.
	PRO LOGIC II MUSIC [PLII MS]	5 channel	Performs Dolby Pro Logic II Music mode decoding. This setting is ideal for normal stereo sources such as CDs.
(Multi Stereo)	MULTI STEREO [MULTI ST.]	(Multi Stereo)	Outputs 2 channel left/right signals from all speakers. However, sound may not be output from certain speakers depending on the speaker settings.

If you connect a sub woofer

This receiver will generate a low frequency signal for output to the sub woofer when there is no LFE signal, which is a low-pass sound effect output from a sub woofer to a 2 channel signal.

Note

Dolby Pro Logic and Dolby Pro Logic II decoding do not function for DTS format signals.

Selecting a pre-programmed sound field

You can take advantage of surround sound simply by selecting one of the receiver's pre-programmed sound fields. They bring the exciting and powerful sound of movie theaters and concert halls into your home.

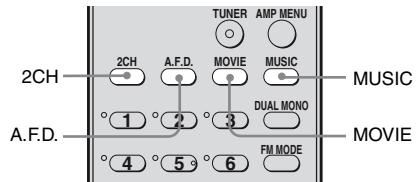

Press MOVIE repeatedly to select a sound field for movies or press MUSIC repeatedly to select a sound field for music.

For details, see "Types of sound field available" (page 44).

Types of sound field available

Sound field for	Sound field [Display]	Effect
Movie	CINEMA STUDIO EX A DCS [C.ST.EX A]	Reproduces the sound characteristics of the Sony Pictures Entertainment "Cary Grant Theater" cinema production studio. This is a standard mode, great for watching almost any type of movie.
	CINEMA STUDIO EX B DCS [C.ST.EX B]	Reproduces the sound characteristics of the Sony Pictures Entertainment "Kim Novak Theater" cinema production studio. This mode is ideal for watching science-fiction or action movies with lots of sound effects.
	CINEMA STUDIO EX C DCS [C.ST.EX C]	Reproduces the sound characteristics of the Sony Pictures Entertainment scoring stage. This mode is ideal for watching musicals or films where orchestra music is featured in the soundtrack.
Music	HALL [HALL]	Reproduces the acoustics of a classical concert hall.
	JAZZ CLUB [JAZZ]	Reproduces the acoustics of a jazz club.
	LIVE CONCERT [CONCERT]	Reproduces the acoustics of a 300-seat live house.
Headphone	HEADPHONE 2CH [HP 2CH]	This mode is selected automatically if you use headphone when 2 channel mode (page 46)/A.F.D. mode (page 42) is selected. Standard 2 channel stereo sources completely bypass the sound field processing and multi channel surround formats are downmixed to 2 channels.
	HEADPHONE THEATER DCS [HP THEA]	This mode is selected automatically if you use headphone when sound field for movie/music is selected. It allows you to experience a theater-like environment while listening through a pair of headphones.

About DCS (Digital Cinema Sound)

Sound fields with **DCS** mark use DCS technology.

DCS is a unique sound reproduction technology for home theater developed by Sony, in cooperation with Sony Pictures Entertainment, for enjoying the exciting and powerful sound of movie theaters at home. With this “Digital Cinema Sound” developed by integrating a DSP (Digital signal processor) and measured data, the ideal sound field intended by film makers can be experienced at home.

About CINEMA STUDIO EX modes

CINEMA STUDIO EX modes are suitable for watching motion picture DVDs (etc.), with multi channel surround effects. You can reproduce the sound characteristics of Sony Pictures Entertainment’s dubbing studio in your home.

The CINEMA STUDIO EX modes consist of the following three elements.

- Virtual Multi Dimension
Creates 5 sets of virtual speakers from a single pair of actual surround speakers.
- Screen Depth Matching
Creates the sensation that the sound is coming from inside the screen like in theaters.
- Cinema Studio Reverberation
Reproduces the type of reverberation found in theaters.





The CINEMA STUDIO EX modes integrate these three elements simultaneously.

Notes

- The effects provided by the virtual speakers may cause increased noise in the playback signal.
- When listening with sound fields that employ the virtual speakers, you will not be able to hear any sound coming directly from the surround speakers.
- This function does not work signals with a sampling frequency of more than 48 kHz.
- When one of the following sound fields is selected, no sound is output from the sub woofer if all the speakers are set to “LARGE” on the SYSTEM menu. However, the sound will be output from the sub woofer if the digital input signal contains LFE signals, or if the front or surround speakers are set to “SMALL”.
 - HALL
 - JAZZ
 - CONCERT

Tip

You can identify the encoding format of DVD software, etc., by looking at the logo on the package.

-  : Dolby Digital discs
-   : Dolby Surround encoded programs
-  : DTS Digital Surround encoded programs

To turn off the surround effect for movie/music

Press 2CH to select “2CH ST.” or press A.F.D. repeatedly to select “A.F.D. AUTO”.

Using only the front speakers (2CH STEREO)

In this mode, the receiver outputs the sound from the front left/right speakers only. There is no sound from the sub woofer. Standard 2 channel stereo sources completely bypass the sound field processing and multi channel surround formats are downmixed to 2 channel.

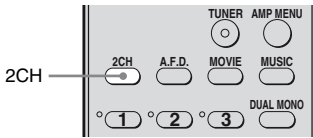

Press 2CH.

Note

No sound is output from the sub woofer in the 2CH STEREO mode. To listen to 2 channel stereo sources using the front left/right speakers and a sub woofer, select "A.F.D. AUTO" (page 42).

Resetting sound fields to the initial settings

Be sure to use the buttons on the receiver for this operation.

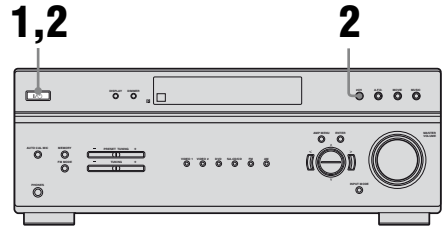

- 1 Press I/O to turn off the power.**
- 2 While holding down 2CH, press I/O.**

"S.F. CLR." appears on the display and all sound fields are reset to their initial setting.

Tuner Operations

Listening to FM/AM radio

You can listen to FM and AM broadcasts through the built-in tuner. Before operation, make sure you have connected the FM and AM antennas to the receiver (page 22).

Tip

The tuning scale differs depending on the area code as shown in the following table. For details on area codes, see page 2.

Area code	FM	AM
CEL, CEK, AU, TW, KR, TH6	50 kHz	9 kHz

Automatic tuning

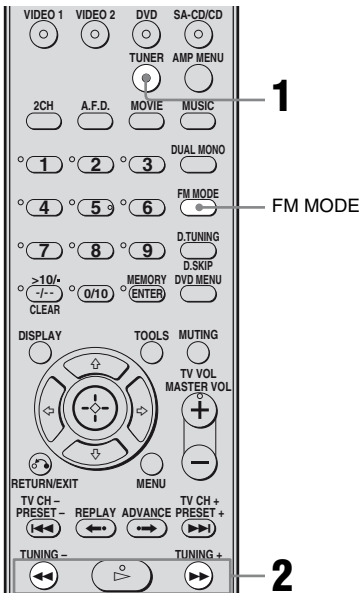

1 Press TUNER repeatedly to select the FM or AM band.

You can also use FM or AM on the receiver.

2 Press TUNING + or TUNING -.

Press TUNING + to scan from low to high; press TUNING - to scan from high to low.

The receiver stops scanning whenever a station is received.

In case of poor FM stereo reception

If the FM stereo reception is poor and “STEREO” flashes on the display, select monaural audio so that the sound will be less distorted.

Press FM MODE repeatedly until the “MONO” indicator lights up on the display. To return to stereo mode, press FM MODE repeatedly until the “MONO” indicator on the display do not light up.

Direct tuning

Enter the frequency of a station directly by using the numeric buttons.

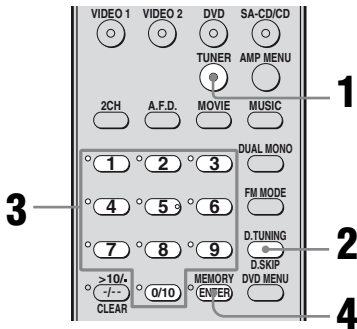

- 1 Press TUNER repeatedly to select the FM or AM band.**

You can also use FM or AM on the receiver.

- 2 Press D.TUNING.**

- 3 Press the numeric buttons to enter the frequency.**

Example 1: FM 102.50 MHz

Select 1 → 0 → 2 → 5 → 0

Example 2: AM 1,350 kHz

Select 1 → 3 → 5 → 0

If you have tuned in an AM station, adjust the direction of the AM loop antenna for optimum reception.

- 4 Press ENTER.**

If you cannot tune in a station

Make sure you have entered the right frequency. If not, repeat steps 2 to 4. If you still cannot tune in a station, the frequency is not used in your area.

Storing FM stations automatically (AUTOBETICAL)

(Models of area code CEL, CEK only)

This function lets you store up to 30 FM and FM RDS stations in alphabetical order without redundancy. Additionally, it only stores the stations with the clearest signals.

If you want to store FM or AM stations one by one, see “Presetting radio stations” (page 49). Be sure to use the buttons on the receiver for this operation.

1,2

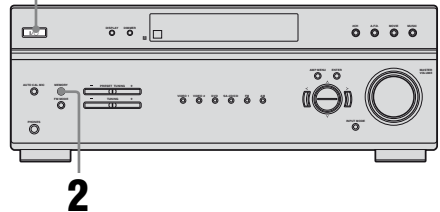

- 1 Press I/Power to turn off the receiver.**

2 Hold down MEMORY and press I/⏻ to turn the receiver back on.

“AUTO-BETICAL SELECT” appears on the display and the receiver scans and stores all the FM and FM RDS stations in the broadcast area.

For RDS stations, the tuner first checks for stations broadcasting the same program, then stores only the ones with the clearest signal. The selected RDS stations are sorted alphabetically by their Program Service name, then assigned a 2-character preset code. For more details on RDS, see page 52.

Regular FM stations are assigned 2-character preset codes and stored after the RDS stations.

When this process is finished, “FINISH” appears on the display momentarily and the receiver returns to normal operation.

Notes

- Do not press any button on the receiver or supplied remote during autobetical operation, except I/⏻.
- If you move to another area, repeat this procedure to store stations in your new area.
- For details on tuning the stored stations, see “Tuning to preset stations” (page 50).
- If you move the antenna after storing stations with this procedure, the stored settings may no longer be valid. If this happens, repeat this procedure to store the stations again.

Presetting radio stations

You can preset up to 30 FM stations and 30 AM stations. Then you can easily tune in the stations you often listen to.

Presetting radio stations

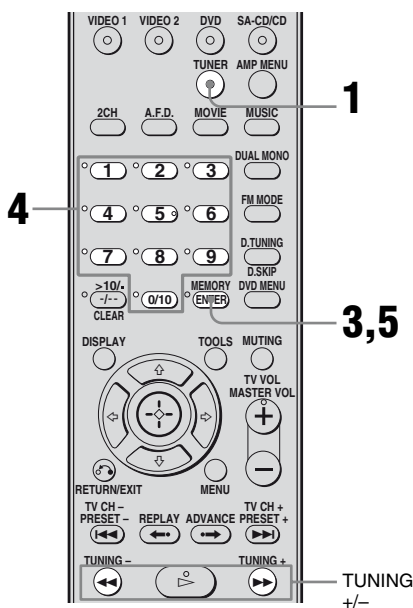

1 Press TUNER repeatedly to select the FM or AM band.

You can also use FM or AM on the receiver.

2 Tune in the station that you want to preset using Automatic Tuning (page 47) or Direct Tuning (page 48).

Switch the FM reception mode, if necessary (page 47).

continued

3 Press MEMORY.

“MEMORY” lights up for a few seconds. Perform steps 4 and 5 before “MEMORY” goes out.

4 Press the numeric buttons to select a preset number.

You can also press TUNING + or TUNING – repeatedly to select a preset number.

If “MEMORY” goes out before you select the preset number, start again from step 3.

5 Press ENTER.

The station is stored as the selected preset number.

If “MEMORY” goes out before you press MEMORY, start again from step 3.

6 Repeat steps 1 to 5 to preset another station.

Tuning to preset stations

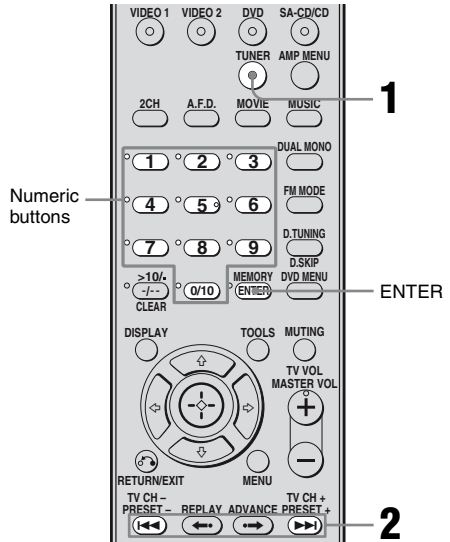

1 Press TUNER repeatedly to select the FM or AM band.

You can also use FM or AM on the receiver.

2 Press PRESET + or PRESET – repeatedly to select the preset station you want.

You can also use PRESET TUNING + or PRESET TUNING – on the receiver. Each time you press the button, you can select a preset station as follows:

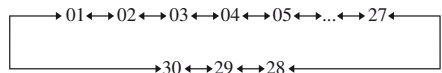

You can also press the numeric buttons to select the preset station you want. Then, press ENTER to enter the selection.

Naming preset stations

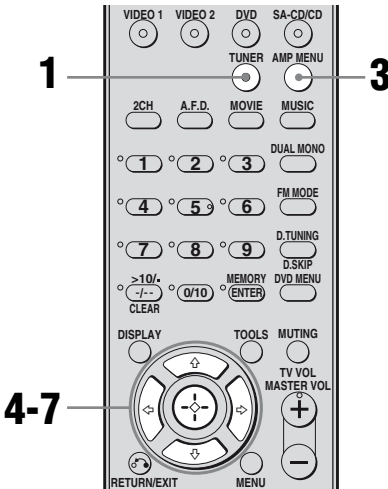

1 Press TUNER repeatedly to select the FM or AM band.

You can also use FM or AM on the receiver.

2 Tune in the preset station you want to create an index name for (page 50).

3 Press AMP MENU.

“1-LEVEL” appears on the display.

4 Press control button \uparrow/\downarrow repeatedly to select “4-TUNER”.

You can also use \wedge or \vee on the receiver.

5 Press the control button or control button \rightarrow to enter the menu.

You can also use ENTER or $>$ on the receiver.

6 Press control button \uparrow/\downarrow repeatedly to select “NAME IN”.

You can also use \wedge or \vee on the receiver.

7 Press the control button or control button \rightarrow to enter the parameter.

You can also use ENTER or $>$ on the receiver.

The cursor flashes and you can select a character. Follow the procedure given in “To create an index name” below.

To return to the previous display

Press control button \leftarrow .

You can also use $<$ on the receiver.

To create an index name

1 Use control button $\uparrow/\downarrow/\leftarrow/\rightarrow$ to create an index name.

You can also use \wedge or \vee and $<$ or $>$ on the receiver.

Press control button \uparrow/\downarrow to select a character, then press control button \leftarrow/\rightarrow to move the cursor to the next position.

If you made a mistake

Press control button \leftarrow/\rightarrow until the character you want to change flashes, then press control button \uparrow/\downarrow to select the correct character.

Tip

You can select the character type as follows by pressing control button \uparrow/\downarrow .
Alphabet (upper case) \rightarrow Numbers \rightarrow Symbols

2 Press the control button.

You can also use ENTER on the receiver.
The entered name is registered.

Note (Models of area code CEL, CEK only)

When you name an RDS station and tune in that station, the Program Service name appears instead of the name you entered. (You cannot change the Program Service name. The name you entered will be overwritten by the Program Service name.)

Using the Radio Data System (RDS)

(Models of area code CEL, CEK only)

This receiver also allows you to use RDS (Radio Data System), which enables radio stations to send additional information along with the regular program signal. You can display RDS information.

Notes

- RDS is operable only for FM stations.
- Not all FM stations provide RDS service, nor do they provide the same type of services. If you are not familiar with the RDS services in your area, check with your local radio stations for details.

Receiving RDS broadcasts

Simply select a station on the FM band using direct tuning (page 48), automatic tuning (page 47), or preset tuning (page 50).

When you tune in a station that provides RDS services, “RDS” lights up and the program service name appears on the display.

Note

RDS may not work properly if the station you tuned to is not transmitting the RDS signal properly or if the signal strength is weak.

Displaying RDS information

While receiving an RDS station, press **DISPLAY** repeatedly on the receiver.

Each time you press the button, RDS information on the display changes cyclically as follows:

Program Service name → Frequency → Program Type indication^{a)} → Radio Text indication^{b)} → Current Time indication (in 24-hour system mode) → Sound field currently applied

^{a)}Type of program being broadcast.

^{b)}Text messages sent by the RDS station.

Notes

- If there is an emergency announcement by government authorities, “ALARM” flashes in the display.
- When the message consists of 9 characters or more, the message scrolls across the display.
- If a station does not provide a particular RDS service, “NO XXXX” (such as “NO TEXT”) appears on the display.

Description of program types

Program type indication	Description
NEWS	News programs
AFFAIRS	Topical programs that expand on current news
INFO	Programs offering information on a wide spectrum of subjects, including consumer affairs and medical advice
SPORT	Sports programs
EDUCATE	Educational programs, such as “how-to” and advice programs
DRAMA	Radio plays and serials
CULTURE	Programs about national or regional culture, such as language and social concerns
SCIENCE	Programs about the natural sciences and technology

Program type indication	Description
VARIED	Other types of programs such as celebrity interviews, panel games, and comedy
POP M	Popular music programs
ROCK M	Rock music programs
EASY M	Easy Listening
LIGHT M	Instrumental, vocal, and choral music
CLASSICS	Performances of major orchestras, chamber music, opera, etc.
OTHER M	Music that does not fit into any categories above, such as Rhythm & Blues and Reggae
WEATHER	Weather information
FINANCE	Stock market reports and trading, etc.
CHILDREN	Programs for children
SOCIAL	Programs about people and the things that affect them
RELIGION	Programs of religious content
PHONE IN	Programs where members of the public express their views by phone or in a public forum
TRAVEL	Programs about travel. Not for announcements that are located by TP/TA.
LEISURE	Programs on recreational activities such as gardening, fishing, cooking, etc.
JAZZ	Jazz programs
COUNTRY	Country music programs
NATION M	Programs featuring the popular music of the country or region
OLDIES	Programs featuring oldies music
FOLK M	Folk music programs
DOCUMENT	Investigative features
NONE	Any programs not defined above

Other Operations

Switching the audio input mode (INPUT MODE)

You can select the audio input mode by setting the audio input mode when you connect components to both digital and analog audio input jacks on the receiver.

- 1 Press input buttons to select the input.**
- 2 Press INPUT MODE repeatedly on the receiver to select the audio input mode.**

The selected audio input mode appears on the display.

Audio input modes

- **AUTO IN**
Gives priority to digital audio signals when there are both digital and analog connections. If there are no digital audio signals, analog audio signals are selected.
- **COAX IN**
Specifies the digital audio signals input to the DIGITAL COAXIAL jack.
- **OPT IN**
Specifies the digital audio signals input to the DIGITAL OPTICAL jack.
- **ANALOG**
Specifies the analog audio signals input to the AUDIO IN (L/R) jacks.

Note

Some audio input modes may not be set up depending on the input.

Naming inputs

You can enter a name of up to 8 characters for inputs and display it on the receiver's display. This is convenient for labeling the jacks with the names of the connected components.

1 Press the input button to select the input you want to create an index name for.

2 Press AMP MENU.

"1-LEVEL" appears on the display.

3 Press control button \uparrow/\downarrow repeatedly to select "5-AUDIO".

You can also use \wedge or \vee on the receiver.

4 Press the control button or control button \rightarrow to enter the menu.

You can also use ENTER or $>$ on the receiver.

5 Press control button \uparrow/\downarrow to select "NAME IN".

You can also use \wedge or \vee on the receiver.

6 Press the control button or control button \rightarrow to enter the parameter.

You can also use ENTER or $>$ on the receiver.

The cursor flashes and you can select a character. Follow the procedure given in "To create an index name" (page 51).

To return to the previous display

Press control button \leftarrow .

You can also use $<$ on the receiver.

Changing the display

You can check the sound field, etc., by changing the information on the display. Be sure to use the buttons on the receiver for this operation.

Press DISPLAY repeatedly.

Each time you press the button, the display changes cyclically as follows.

All inputs except the FM and AM band

Index name of the input^{a)} \rightarrow Selected input
 \rightarrow Sound field currently applied

FM and AM band

Program Service name^{b)} or preset station name^{a)} \rightarrow Frequency \rightarrow Program Type indication^{b)} \rightarrow Radio Text indication^{b)} \rightarrow Current Time indication (in 24-hour system mode)^{b)} \rightarrow Sound field currently applied

^{a)} Index name appears only when you have assigned one to the input or preset station (page 51, 54). Index name does not appear when only blank spaces have been entered, or it is the same as the input name.

^{b)} During RDS reception only (models of area code CEL, CEK only) (page 52).

Using the Sleep Timer

You can set the receiver to turn off automatically at a specified time.

Press SLEEP repeatedly while the power is on.

Each time you press the button, the display changes cyclically as follows:

2-00-00 → 1-30-00 → 1-00-00 → 0-30-00
→ OFF

When Sleep Timer is being used, "SLEEP" lights up on the display.

Tip

To check the remaining time before the receiver turns off, press SLEEP. The remaining time appears on the display. If you press SLEEP again, the sleep timer will be canceled.

Using the Remote

Changing button assignments

You can change the factory settings of the input buttons to suit the components in your system. For example, if you connect a DVD recorder to the VIDEO 1 jacks on the receiver, you can set the VIDEO 1 button on this remote to control the DVD recorder.

1 Hold down the input button of which you want to change the assignment.

Example: Press VIDEO 1.

2 Referring to the table below, press the corresponding button for the category you want.

Example: Press 4.

Now you can use the VIDEO 1 button to control the DVD recorder.

Categories and the corresponding buttons

Categories	Press
VCR (command mode VTR 3) ^{a)}	1
VCR (command mode VTR 2) ^{a)}	2
DVD player/DVD recorder (command mode DVD1) ^{b)}	3
DVD recorder (command mode DVD3) ^{b)}	4
CD player	5
MD deck	6
Tape deck B	7
Tuner (this receiver)	8
DVR (Digital CATV terminal)	9
DSS (Digital Satellite Receiver)	0/10

^{a)} Sony VCRs are operated with a VTR 2 or VTR 3 setting which correspond to 8 mm and VHS respectively.

^{b)} Sony DVD recorders are operated with a DVD1 or DVD3 setting. For details, refer to the operating instructions supplied with the DVD recorders.

To clear all remote button assignments

Press I/⏪, AUTO CAL and MASTER VOL – at the same time.

The remote is reset to its factory settings.

Additional Information

Glossary

■ Component video

A format for transmitting video signal information consisting of three separate signals: luminance Y, chrominance Pb, and chrominance Pr. High quality pictures, such as DVD video or HDTV pictures, are transmitted more faithfully. The three jacks are color-coded green, blue and red.

■ Composite video

A standard format for transmitting video signal information. The luminance signal Y and chrominance signal C are combined and transmitted together.

■ Dolby Digital

Digital audio encoding/decoding technology developed by Dolby Laboratories, Inc. It consists of front (left/right), center, surround (left/right) and sub woofer channels. It is a designated audio standard for DVD-video and also known as 5.1ch surround. Since surround information is recorded and reproduced in stereo, more realistic sound with fuller presence is delivered than with Dolby surround.

■ Dolby Pro Logic II

This technology converts 2ch stereo recorded audio into 5.1ch for playback. There is a MOVIE mode for movies and MUSIC mode for stereo sources such as music. Old movies encoded in the traditional stereo format can be enhanced with 5.1ch surround sound.

■ Dolby Surround (Dolby Pro Logic)

Audio processing technology developed by Dolby Laboratories, Inc. Center and mono surround information is matrixed into two stereo channels. When reproduced, audio is decoded and output in 4ch surround sound. This is the most common audio processing method for DVD-video.

■ DTS Digital Surround

Digital audio encoding/decoding technology for theaters developed by Digital Theater Systems, Inc. It compresses audio less than Dolby Digital, delivering a higher quality sound reproduction.

■ Sampling frequency

To convert analog audio to digital, analog data should be quantified. This process is called sampling, and the number of times per second the analog data is quantified is called the sampling frequency. A standard music CD stores data quantified at 44,100 times per second, which is expressed as a sampling frequency of 44.1 kHz. Generally speaking, a higher sampling frequency means better sound quality.

Precautions

On safety

Should any solid object or liquid fall into the cabinet, unplug the receiver and have it checked by qualified personnel before operating it any further.

On power sources

- Before operating the receiver, check that the operating voltage is identical with your local power supply.
The operating voltage is indicated on the nameplate on the back of the receiver.
- The unit is not disconnected from the AC power source (mains) as long as it is connected to the wall outlet, even if the unit itself has been turned off.
- If you are not going to use the receiver for a long time, be sure to disconnect the receiver from the wall outlet. To disconnect the AC power cord, grasp the plug itself; never pull the cord.
- The AC power cord must be changed only at a qualified service shop.

On heat buildup

Although the receiver heats up during operation, this is not a malfunction. If you continuously use this receiver at a large volume, the cabinet temperature of the top, side and bottom rises considerably. To avoid burning yourself, do not touch the cabinet.

On placement

- Place the receiver in a location with adequate ventilation to prevent heat buildup and prolong the life of the receiver.
- Do not place the receiver near heat sources, or in a place subject to direct sunlight, excessive dust, or mechanical shock.
- Do not place anything on top of the cabinet that might block the ventilation holes and cause malfunctions.
- Do not place the receiver near equipment such as a television, VCR, or tape deck. (If the receiver is being used in combination with a television, VCR, or tape deck, and is placed too close to that equipment, noise may result, and picture quality may suffer. This is especially likely when using an indoor antenna. Therefore, we recommend using an outdoor antenna.)
- Use caution when placing the receiver on surfaces that have been specially treated (with wax, oil, polish, etc.) as staining or discoloration of the surface may result.

On operation

Before connecting other components, be sure to turn off and unplug the receiver.

On cleaning

Clean the cabinet, panel, and controls with a soft cloth slightly moistened with a mild detergent solution. Do not use any type of abrasive pad, scouring powder, or solvent, such as alcohol or benzine.

If you have any questions or problems concerning your receiver, please consult your nearest Sony dealer.

Troubleshooting

If you experience any of the following difficulties while using the receiver, use this troubleshooting guide to help you remedy the problem.

There is no sound, no matter which component is selected, or only a very low-level sound is heard.

- Check that the speakers and components are connected securely.
- Check that both the receiver and all components are turned on.
- Check that MASTER VOLUME is not set to "VOL MIN".
- Check that headphone is not connected.
- Press MUTING to cancel the muting function.
- Check that you have selected the correct component with the input buttons.
- The protective device on the receiver has been activated. Turn off the receiver, eliminate the short-circuit problem, and turn on the power again.

There is no sound from a specific component.

- Check that the component is connected correctly to the audio input jacks for that component.
- Check that the cord(s) used for the connection is (are) fully inserted into the jacks on both the receiver and the component.
- Check that you have selected the correct component with the input buttons.

There is no sound from one of the front speakers.

- Connect a pair of headphones to the PHONES jack to verify that sound is output from the headphones. If only one channel is output from the headphones, the component may not be connected to the receiver correctly. Check that all the cords are fully inserted into the jacks on both the receiver and the component. If both channels are output from the headphones, the front speaker may not be connected to the receiver correctly. Check the connection of the front speaker which is not outputting any sound.
- Make sure you have connected to both the L and R jacks of an analog component, and not only to either the L or R jack. Use an audio cord (not supplied).

There is no sound from analog 2 channel sources.

- Check that the INPUT MODE is not set to “COAX IN” or “OPT IN” for the selected input (page 53).

There is no sound from digital sources (from COAXIAL or OPTICAL input jack).

- Check that the INPUT MODE is not set to “ANALOG” (page 53). Check that the INPUT MODE is not set to “COAX IN” for the sources from the OPTICAL input jack, or to “OPT IN” for the sources from the COAXIAL input jack.

The left and right sounds are unbalanced or reversed.

- Check that the speakers and components are connected correctly and securely.
- Adjust the balance parameters using the LEVEL menu.

There is severe hum or noise.

- Check that the speakers and components are connected securely.
- Check that the connecting cords are away from a transformer or motor, and at least 3 m (10 feet) away from a TV set or fluorescent light.
- Move your audio components away from the TV.
- The plugs and jacks are dirty. Wipe them with a cloth slightly moistened with alcohol.

There is no sound, or only a very low-level sound is heard from the center/surround speakers.

- Select a CINEMA STUDIO EX mode (page 44).
- Adjust the speaker level (page 27).
- Make sure the center/surround speakers are set to either “SMALL” or “LARGE” (page 34).

There is no sound from the sub woofer.

- Check that the sub woofer is connected correctly and securely.
- Make sure you have turned on your sub woofer.
- Make sure the sub woofer is set to “YES” (page 34).
- There is no sound from the sub woofer depending on the sound field.

The surround effect cannot be obtained.

- Make sure the sound field function is on (press MOVIE, or MUSIC).
- Sound fields do not function for signals with a sampling frequency of more than 48 kHz.

Dolby Digital or DTS multi channel sound is not reproduced.

- Check that the DVD, etc. you are playing is recorded in Dolby Digital or DTS format.
- When connecting the DVD player, etc., to the digital input jacks of this receiver, check the audio setting (the settings for the audio output) of the connected component.

The FM reception is poor.

- Use a 75-ohm coaxial cable (not supplied) to connect the receiver to an outdoor FM antenna as shown below. If you connect the receiver to an outdoor antenna, ground it against lightning. To prevent a gas explosion, do not connect the ground wire to a gas pipe.

Outdoor FM antenna

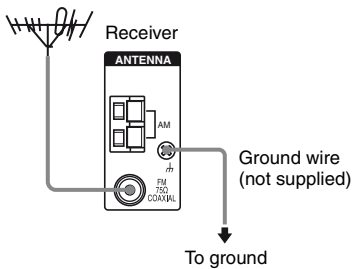

Radio stations cannot be tuned in.

- Check that the antennas are connected securely. Adjust the antennas and connect an external antenna, if necessary.
- The signal strength of the stations is too weak (when tuning in with automatic tuning). Use direct tuning.
- Make sure you set the tuning interval correctly (when tuning in AM stations with direct tuning).
- No stations have been preset or the preset stations have been cleared (when tuning by scanning preset stations). Preset the stations (page 49).
- Press DISPLAY repeatedly on the receiver so that the frequency appears on the display.

RDS does not work.*

- Make sure that you are tuned to an FM RDS station.
- Select a stronger FM station.

The RDS information that you want does not appear.*

- Contact the radio station and find out whether they actually provide the service in question. If so, the service may be temporarily out of order.

There is no picture or an unclear picture appears on the TV screen or monitor.

- Select the appropriate input using the input buttons.
- Set your TV to the appropriate input mode.
- Move your audio components away from the TV.
- Assign the component video input correctly.

Remote control

The remote does not function.

- Point the remote at the remote sensor on the receiver.
- Remove any obstacles in the path between the remote and the receiver.
- Replace all the batteries in the remote with new ones, if they are weak.
- Make sure you select the correct input on the remote.

* Models of area code CEL, CEK only.

Error messages

If there is a malfunction, the display shows a message. You can check the condition of the system by the message. Refer to the following table to solve the problem. If any problem persists, consult your nearest Sony dealer. If an error message appears while you perform Auto Calibration, see “Error and warning codes” (page 26) to solve the problem.

DEC. EROR

Appears when a signal the receiver cannot decode (ex. DTS-CD) is input and “DEC. PRI.” on the AUDIO menu is set to “DEC. PCM”. Set it to “DEC. AUTO” (page 34).

PROTECT

Irregular current is output from the receiver. The receiver will automatically turn off after a few seconds. Check the speaker connection and turn on the power again.

If you are unable to remedy the problem using the troubleshooting guide

Clearing the receiver’s memory may remedy the problem (page 23). However, note that all memorized settings will be reset to their factory settings and you will have to readjust all settings on the receiver.

If the problem persist

Consult your nearest Sony dealer. Note that if service personnel changes some parts during repair, these parts may be retained.

Reference sections for clearing the receiver’s memory

To clear	See
All memorized settings	page 23
Customized sound fields	page 46

Specifications

Amplifier section

Models of area code CEL, CEK, TW, AU
Stereo Power Output¹⁾, Reference Power Output¹⁾²⁾

6 ohms 20 Hz – 20 kHz, THD 0.09%

55 W + 55 W, 80 W/ch

6 ohms 1 kHz, THD 0.7%

90 W + 90 W, 100 W/ch

6 ohms 1 kHz, THD 10%

120 W + 120 W, 140 W/ch

Models of area code TH6

Stereo Power Output¹⁾, Reference Power Output¹⁾²⁾

6 ohms 20 Hz – 20 kHz, THD 0.09%

40 W + 40 W¹⁾,
35 W + 35 W³⁾, 60 W/ch

6 ohms 1 kHz, THD 0.7%

65 W + 65 W¹⁾,
60 W + 60 W³⁾, 80 W/ch

6 ohms 1 kHz, THD 10%

85 W + 85 W¹⁾,
75 W + 75 W³⁾, 100 W/ch

Models of area code KR

Stereo Power Output¹⁾, Reference Power Output¹⁾²⁾

6 ohms 20 Hz – 20 kHz, THD 0.09%

55 W + 55 W¹⁾,
50 W + 50 W³⁾, 80 W/ch

6 ohms 1 kHz, THD 0.7%

90 W + 90 W¹⁾,
80 W + 80 W³⁾, 100 W/ch

6 ohms 1 kHz, THD 10%

120 W + 120 W¹⁾,
100 W + 100 W³⁾,
140 W/ch

¹Measured under the following conditions:

Area code	Power requirements
CEL, CEK, KR, TH6	230 V AC, 50 Hz
AU	240 V AC, 50 Hz
TW	110 V AC, 60 Hz

²Reference power output for front, center and surround. Depending on the sound field settings and the source, there may be no sound output.

³Measured under the following conditions:

Area code	Power requirements
KR, TH6	220 V AC, 50 Hz

Frequency response

Analog 10 Hz – 70 kHz
+0.5/-2 dB (with sound field and tone bypassed)

Inputs

Analog Sensitivity: 800 mV/
50 kohms
S/N⁴: 96 dB
(A, 800 mV⁵)

Digital (Coaxial) Impedance: 75 ohms
S/N: 100 dB
(A, 20 kHz LPF)

Digital (Optical) S/N: 100 dB
(A, 20 kHz LPF)

Outputs (Analog)

AUDIO OUT Voltage: 800 mV/10 kohms
SUB WOOFER Voltage: 2 V/1 kohm

Tone

Gain levels ±6 dB, 1 dB step

⁴INPUT SHORT (with sound field and tone bypassed).

⁵Weighted network, input level.

FM tuner section

Tuning range 87.5 - 108.0 MHz
Intermediate frequency
10.7 MHz
Useable sensitivity 11.2 dBf, 1 µV/75 ohms
S/N
Mono/Stereo 76 dB/70 dB
Harmonic distortion at 1 kHz
Mono/Stereo 0.3%/0.5%
Separation 45 dB at 1 kHz
Frequency response 30 Hz – 15 kHz,
+0.5/-2 dB

AM tuner section

Tuning range

Area code	Tuning scale	
	10 kHz step	9 kHz step
CEL, CEK, AU, TW, KR, TH6	–	531 – 1,602 kHz

Intermediate frequency

450 kHz

Usable sensitivity 50 dB µ/m

Video section

Inputs/Outputs

Video: 1 V_{p-p}/75 ohms

COMPONENT VIDEO:

Y: 1 V_{p-p}/75 ohms

P_B/C_B/B-Y: 0.7 V_{p-p}/
75 ohms

P_R/C_R/R-Y: 0.7 V_{p-p}/
75 ohms

80 MHz HD Pass Through

General

Power requirements

Area code	Power requirements
CEL, CEK	230 V AC, 50/60 Hz
AU	240 V AC, 50 Hz
KR, TH6	220 – 230 V AC, 50/60 Hz
TW	110 V AC, 60 Hz

Power consumption

Area code	Power consumption
CEL, CEK, AU, KR	190 W
TH6	170 W
TW	400 W

Power consumption (during standby mode)

0.2 W

Dimensions (w/h/d) (Approx.)

430 × 145 × 300 mm
including projecting parts
and controls

Mass (Approx.) 7.8 kg

Supplied accessories

FM wire antenna (1)

AM loop antenna (1)

Remote commander RM-AAU006 (1)

R6 (size-AA) batteries (2)

Optimizer microphone ECM-AC2 (1)

For details on the area code of the component you are using, see page 2.
--

Design and specifications are subject to change without notice.

Index

Numerics

2 channel 46
2CH STEREO 46
5.1 channel 12

A

AUTO CALIBRATION 24
AUTO FORMAT DIRECT
(A.F.D.) 42
AUTOBETICAL 48

C

CD player
connecting 14
playback 30

D

Digital Cinema Sound
(DCS) 45
Dolby Digital 56
DTS 57
DVD player
hooking up 16
playback 31
DVD recorder
hooking up 16

E

Error messages 61

I

Initial setup 23
INPUT MODE 53

M

Menu
A. CAL 41
AUDIO 37
LEVEL 35
SUR 36
SYSTEM 38
TONE 36
TUNER 37
Muting 29

N

Naming 51, 54

R

RDS 52

S

Satellite tuner
hooking up 16
Selecting
component 28
sound field 43
Sleep Timer 55
Sound fields
resetting 46
selecting 43
Speakers
connecting 13
Super Audio CD player
connecting 14
playback 30

T

Tape deck
connecting 14
TEST TONE 27
Tuner
connecting 22
Tuning
automatically 47
directly 48
to preset stations 50
TV
hooking up 16

V

VCR
hooking up 16



* 2 6 8 0 0 0 9 1 2 * (1)

Free Manuals Download Website

<http://myh66.com>

<http://usermanuals.us>

<http://www.somanuals.com>

<http://www.4manuals.cc>

<http://www.manual-lib.com>

<http://www.404manual.com>

<http://www.luxmanual.com>

<http://aubethermostatmanual.com>

Golf course search by state

<http://golfingnear.com>

Email search by domain

<http://emailbydomain.com>

Auto manuals search

<http://auto.somanuals.com>

TV manuals search

<http://tv.somanuals.com>