

SONY

3-755-967-11(1)

MW/SW/FM Stereo PLL Synthesized Receiver

ICF-SW33

Operating instructions page 2

Before operating the unit, please read this manual thoroughly and retain it for future reference.

WARNING

English

To prevent fire or shock hazard, do not expose the unit to rain or moisture.

To avoid electrical shock, do not open the cabinet. Refer servicing to qualified personnel only.

For the Customers in U.S.A.

You are cautioned that any changes or modifications not expressly approved in this manual could void your authority to operate this equipment.

INFORMATION

This equipment has been tested and found to comply with the limits for a Class B digital device, pursuant to Part 15 of the FCC Rules. These limits are designed to provide reasonable protection against harmful interference in a residential installation. This equipment generates, uses, and can radiate radio frequency energy and, if not installed and used in accordance with the instructions, may cause harmful interference to radio communications. However, there is no guarantee that interference will not occur in a particular installation. If this equipment does cause harmful interference to radio or television reception, which can be determined by turning the equipment off and on, the user is encouraged to try to correct the interference by one or more of the following measures:

- Reorient or relocate the receiving antenna.
- Increase the separation between the equipment and receiver.
- Connect the equipment into an outlet on a circuit different from that to which the receiver is connected.
- Consult the dealer or an experienced radio/TV technician for help.

2

Table of Contents

Features	4
Precautions	5
Location of controls	8
Power sources	14
Setting the clock	19
Changing the MW channel step	29
Manual tuning	30
Scan tuning	34
Preset tuning	36
Using the standby function	38
Using the sleep function	43
Recording a broadcast	44
Troubleshooting guide	45
Specifications	48

Owner's Record

The model and serial numbers are located at the rear. Record the serial number in the space provided below. Refer to them whenever you call upon your Sony dealer regarding this product.

Model No. ICF-SW33 Serial No. _____

Features

- An MW/SW/FM stereo portable receiver with worldwide band coverage.
- Quartz controlled PLL (Phase Locked Loop) synthesizer system using a microcomputer makes pinpoint tuning easy.
- Worldtime clock for international use.
- Up to 5 local times in the world can be preset.
- Current time in some place in the world can be checked.
- 17 stations in total can be preset.
- The tuned frequency is digitally displayed to make searching of the desired station easier.
- You can preset a desired station to be received at a desired time.
- 2 buttons are equipped for 2 different time settings.
- The radio can be turned off automatically after about 60 minutes (Sleep timer).
- FM stereo reception through stereo earphones.

Precautions

- Operate the unit only on 4.5 V DC.
For battery operation, use three R6 (size AA) batteries.
For AC operation and car battery operation, use accessories recommended for the unit. Do not use any other type.
- The unit is not disconnected from the AC power source (mains) as long as it is connected to the wall outlet, even if the unit itself has been turned off.
- Disconnect the AC power adaptor (not supplied) from the wall outlet when the unit is not to be used for a long period of time.
- The nameplate indicating operating voltage, etc., is located on the rear of the unit.
- Use the unit within a temperature range of 0°C to 40°C (32°F to 104°F). If it is used in temperatures outside this range, an irregular display may appear on the display window. If it is used in temperatures lower than this range, the display may change very slowly. These irregularities will disappear and there will be no damage to the unit when the unit is used in its recommended temperature range.
- Do not leave the unit near heat sources, such as radiators or airduct, or in a place subject to direct sunlight, excessive dust, moisture, rain, mechanical vibration, or shock.
- Should any solid object or liquid fall into the unit, remove the batteries, and have the unit checked by qualified personnel before operating it any further.
- Since a strong magnet is used for the speaker, metallic objects such as pins, etc., may cling to the unit. Keep personal credit cards using magnetic coding, recorded tapes, and spring-wound watches away from the unit to prevent damage by the magnet.
- When the casing becomes soiled, clean it with a soft cloth dampened with a mild detergent solution. Never use abrasive cleansers or chemical solvents, as they may mar the case.

Precautions

- When there is lightning and you are using an external antenna, immediately disconnect the AC power adaptor (if connected) from the wall outlet. Never touch the antenna wire when there is lightning storm.
- In vehicles or in building, radio reception may be difficult or noisy. Try listening near a window.
- Never connect a ground wire to a gas pipe.

Note on the MW channel step

The MW channel step differs depending on areas. The channel step of this unit is factory-set to 10 kHz or to 9 kHz to match the frequency allocation system of the country as listed. You can change the channel step. (See "Changing the MW Channel Step" on page 29.)

Area	MW channel step
North and South American countries	10 kHz
Other countries	9 kHz

If you have any question or problem concerning your unit that is not covered in this manual, please consult your nearest Sony dealer.

Location of Controls

See the pages indicated in ● for details.

Front, Right Side and Upper Panel

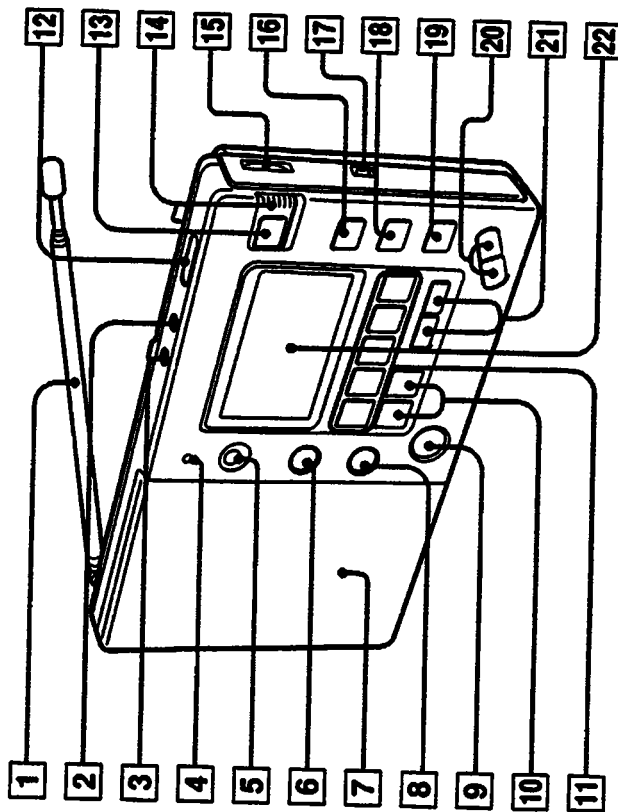

- 1 Telescopic antenna ●
- 2 HOME TIME SET button ●
- 3 BATT(battery)/DST(Daylight Saving Time) button ● ●
- 4 TUNE (tuning) indicator
Lights up when a station is tuned in.
- 5 KEY PROTECT button ●
- 6 ENTER button ● ●
- 7 Speaker
- 8 HOME/WORLD button ●
- 9 METER BAND/TIME ZONE button ●
- 10 STANDBY MEMORY S ●, S ● buttons ●
- 11 FREQ(frequency)/CITY MEMORY PRESET buttons ● ● ●
- 12 LIGHT button ●
- 13 ON/OFF button ●
Press this button to turn on and turn off the radio.
- 14 POWER/LOCK switch ●
When using the unit, set this switch to POWER. Set the switch to LOCK when carrying the unit. When this switch is set to LOCK, all the functions of the buttons are locked.
- 15 VOL (volume) control ●
- 16 SLEEP button ●
- 17 TONE selector ●
- 18 BAND button ●
- 19 SCAN button ●
- 20 TUNE(tuning)/WORLD TIME +,- buttons ● ●
- 21 STANDBY/TIME SET ●, ● buttons ●
- 22 Display window

Location of Controls

Rear, Left Side

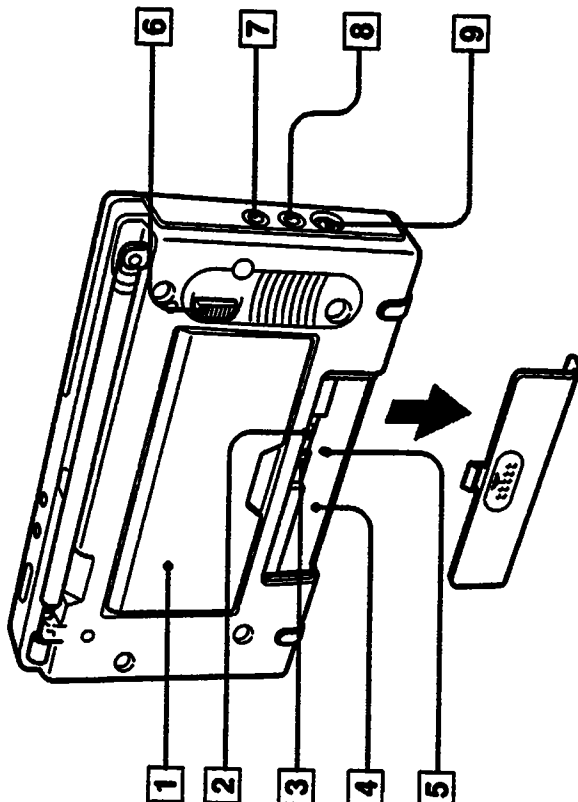

1 Stand

2 9/10 MW CH STEP (9 kHz/10 kHz MW channel step) selector

3 12H/24H (12-hour/24-hour clock system) button

4 Battery compartment

5 RESET button (inside the battery compartment)

When this button is pressed, all the stored memories are cleared and the clock is reset. The unit will return to the same condition as when you inserted the batteries for the first time.

6 SENS (sensitivity) DX/LOCAL selector

Normally set this selector to DX. When the scan stops so often, or received station is too strong to become distorted, set it to LOCAL.

7 REC OUT (recording out) jack

8 PHONES (earphones) jack (stereo mini)

9 DC IN 4.5 V (external power input) jack

How to Use the Stand

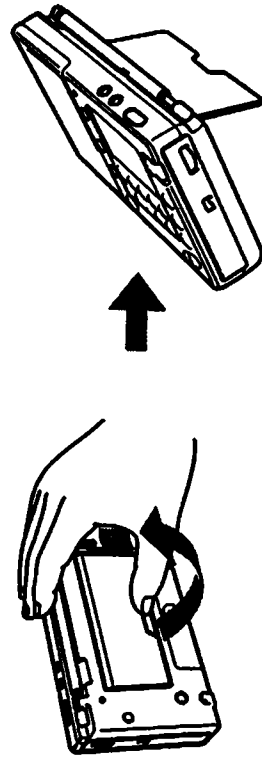

Location of Controls

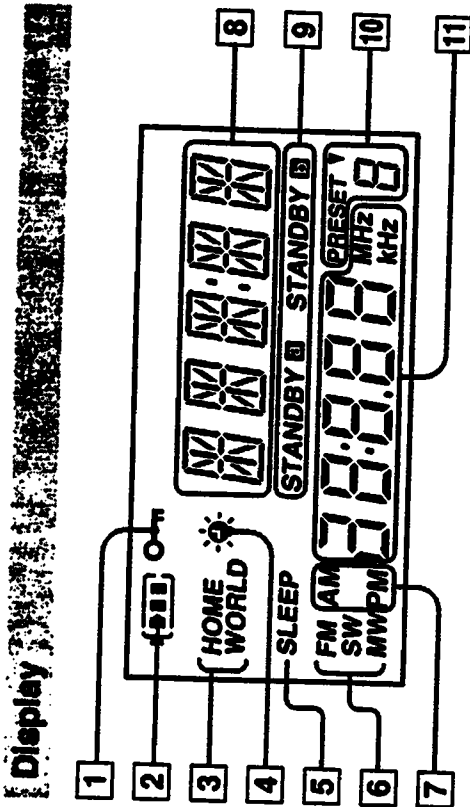

- 1 Key protect indication
 - 2 Battery indication
 - 3 HOME/WORLD indication
 - 4 Daylight Saving Time Indication
 - 5 SLEEP indication
 - 6 Band indication
 - 7 AM/PM indication
- When the clock is based on 12-hour system, this indication appears.
- 8 Time difference/City name indication
 - 9 Standby time indication
 - 10 SW meter band indication
 - 11 STANDBY or indication
 - PRESET ▽ and preset number indication
 - Frequency indication
 - Current time indication

Power Sources

Batteries

Install three R6 (size AA) batteries with correct polarity as illustrated.

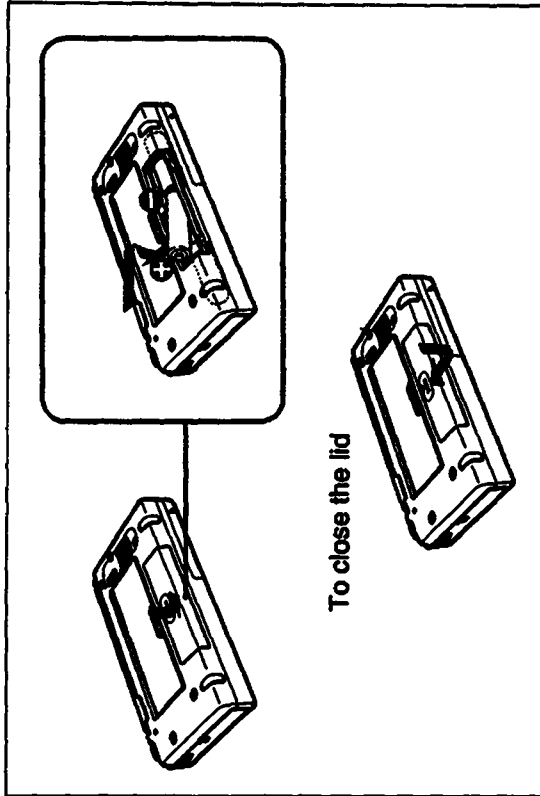

When to replace the batteries

When the batteries become weak, sound becomes weak or distorted.

You can check the battery condition with the battery indication.

While you are listening to the radio, check the battery condition by pressing the BATT/DST button located in the upper side.

When the batteries are run down completely, the power is turned off and  indication flashes.

For battery life, see "Specifications" on page 48.

The Indication of the power remaining in the battery

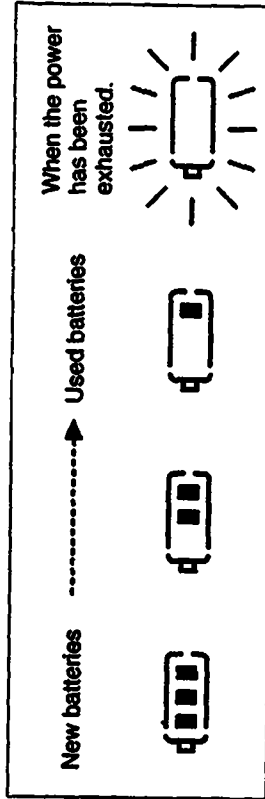

Power Sources

When replacing the batteries

Turn the radio off.

Replace the batteries within about 3 minutes. If you take more time than 3 minutes, The preset stations may be erased, the clock setting may be cleared and "0:00" or "AM 12:00" flashes. After replacing the batteries,  indication still flashes. Once turn on the radio to make this indication disappear.

When the batteries are removed for a long time

Preset stations may be erased and the clock setting may be cleared.

Notes

- Even when the unit is not to be used for a long period of time, keep the batteries installed for the back-up of the clock and the built-in microprocessor unit.
- The internal batteries do not discharge while the power is supplied through the AC power adaptor or from a car battery. However, keep the batteries installed as a back-up in case of sudden power interruption or removal of the car battery cord.

House Current

Use the AC power adaptor (AC-E45M) recommended for this unit. Connect the AC power adaptor to DC IN 4.5 V jack and the other end to a wall outlet.

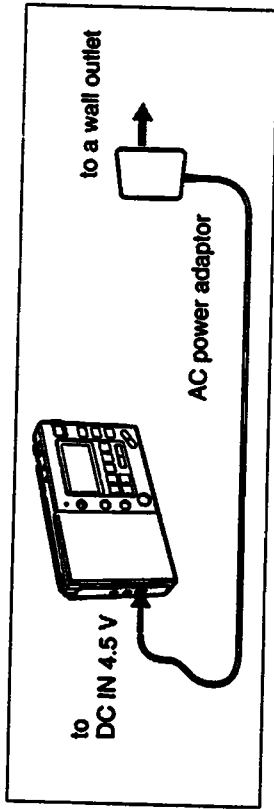

Note

Before connecting the AC power adaptor, be sure to set the voltage of the adaptor to the local power line voltage.

Note on the AC power adaptor

Use only the AC power adaptor recommended. Do not use any other AC power adaptor.





Use the Sony DCC-E145L car battery cord (not supplied).

Connect the car battery cord to DC IN 4.5 V jack and the other end to a cigarette lighter socket of the car.

Note

When the AC power adaptor or car battery cord is connected to the DC IN 4.5 V jack, the internal batteries (if present) are automatically disconnected.

Setting the Clock (HOME time)

The home time means the time in your area and the world time means the time in some place in the world. They can be switched each other with the HOMEWORLD button.

Before setting the clock, see the table on page 25. When your city name is not shown, check the time difference in your area. Use the world map in the rear panel only for your reference.

How to change the clock system

Clock system has been adjusted to either 12-hour or 24-hour according to where you purchased. To change this system, press the 12H/24H button in the battery compartment with some pointed object. Time indication changes automatically.

In 12-hour clock system, hour indication changes as follows.
AM1:00...AM11:00→PM12:00 (noon)→PM1:00...PM11:00→AM 12:00 (midnight)...AM1:00...

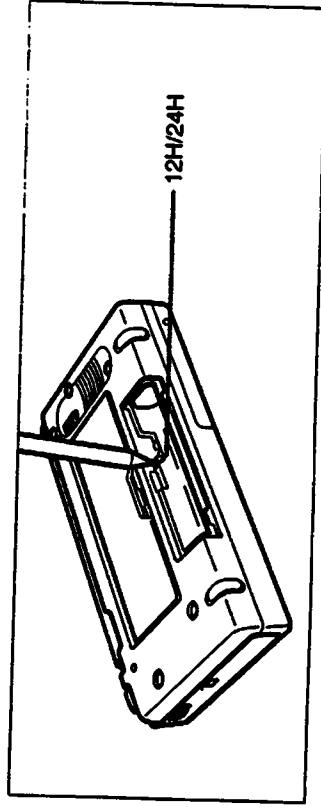

Setting the Clock (HOME time)

Note

Set the clock when the radio is turned off.

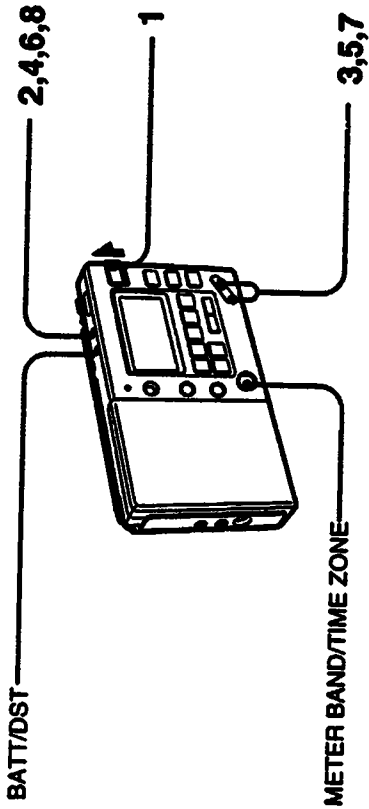

When you insert the batteries for the first time, digits flash.

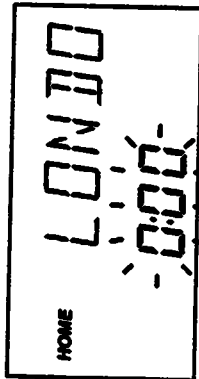

This illustration shows 24-hour clock system

Note

if you take longer than 64 seconds to proceed a step, the unit returns to the condition before the step 2. In this case, proceed again from the step 2.

Example: When you set the home time at 15:30 in Tokyo

- 1 Set the **POWER/LOCK** switch to **POWER**.
- 2 Press the **HOME TIME SET** button for more than 1 second.

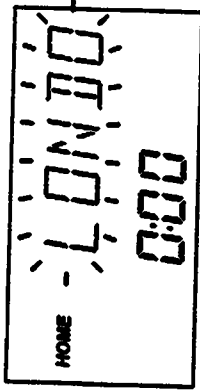

- 3 Press the + or - button to select the time difference or city name in your area.

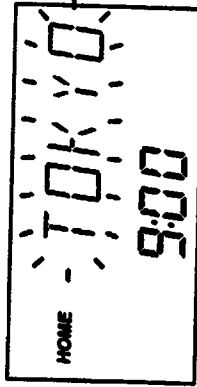

- When you keep the + or - button pressed, indications change constantly in the order shown in the table on page 25. Each time you press the + or - button while keeping the **METER BAND/TIME ZONE** button pressed, only the time differences appear in the order, thus skipping city names.
- When a city name has more than 5 letters, the letters move on the display. All the letters appear twice and then the first 5 letters flash.

Setting the Clock (HOME time)

- 4 Press the HOME TIME SET button.

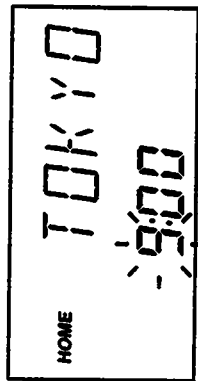

- 5 Adjust the hour with the + or - button.

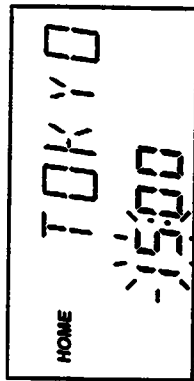

When you keep the button pressed, hour indication changes constantly.

- 6 Press the HOME TIME SET button.

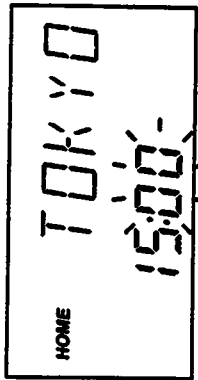

- 7 Adjust the minute with the + or - button.

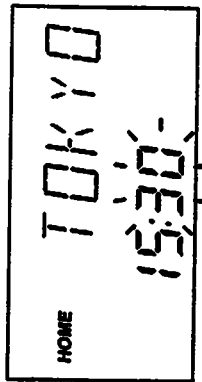

When you keep the button pressed, minute indication changes constantly.

- 8 Press the HOME TIME SET button.

Just when you press the button, the clock starts operating from 0 second of that time. ":" flashes.

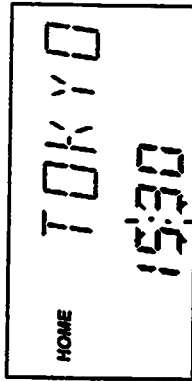

Setting the Clock (HOME time)

For areas where "Daylight Saving Time" is used

When you set the clock during this period, press the BATT/DST button between the steps 1 and 2. "*" appears. At the end of the daylight saving time, press the BATT/DST button. Current time indication changes automatically.

Note

Press the BATT/DST button only when the radio is turned off.
You can set the Daylight Saving Time for HOME time and WORLD time respectively.

Table of the time difference and the city names stored in this unit

Time difference		City name
0:00	LONDON	
+1:00	AMSTERDAM BERLIN MADRID PARIS ROME STOCKHOLM ZURICH	BEIJING HONG KONG SINGAPORE
+2:00	ATHENS CAIRO	
+3:00	JEDDAH	
+4:00	DUBAI	
+5:00	KARACHI	
+6:00	DACCA	
+7:00	BANGKOK	
+8:00		SEOUL TOKYO
+9:00		SYDNEY
+10:00		
+11:00		
+12:00		
-1:00		
-2:00		
-3:00		
-4:00		
-5:00		
-6:00		
-7:00		

This table shows the time during standard time (not under daylight saving time).

How to Know the Current Time in Some Place in the World

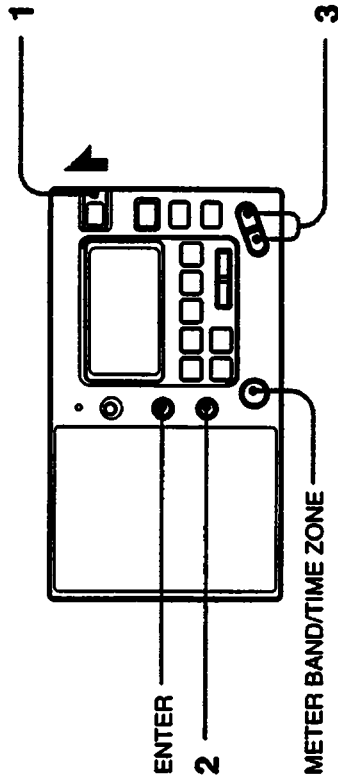

- 1 Set the **POWER/LOCK** switch to **POWER**.
- 2 Press the **HOME/WORLD** button to make the **WORLD** indication appear.
This button switches between **HOME** and **WORLD**.
- 3 Press the **+** or **-** button to select the desired time difference or the city name.

- You can skip the city names. Press the **+** or **-** button while pressing the **METER BAND/TIME ZONE**. Only the time differences will appear on the display.

Note

When your desired place is now under daylight saving time, press the **BATT/DST** button after pressing the **HOME/WORLD** button. Press the **BATT/DST** button only when the radio is turned off.

To check the current time in some place in the world while listening to the radio

Do the same procedures. In this case, the time indication shows the time when you press the **HOME/WORLD** button. Soon, the display returns from the time indication to the radio indication. Even while you are listening to the radio, you can check the time in some other place in the world without affecting the radio reception.

Setting the Clock (HOME time)

To Store the City Name and the Local Time into Memory

Turn the radio off.

While pressing the ENTER button, press the button M1 to M5 in which you want to store the city name or the time difference.

"PRESET ∇ " and the number appear on the display.

Then, you can know the time in that place, only by pressing the button M1 to M5.

Changing the MW Channel Step

When you use the radio where the frequency allocation system is based on the other MW channel step, proceed as follows;

- 1 Be sure to set the **POWER/LOCK switch to LOCK**.
- 2 Change the position of the **MW CH STEP selector** in the battery compartment with a ball-point pen or some pointed object.

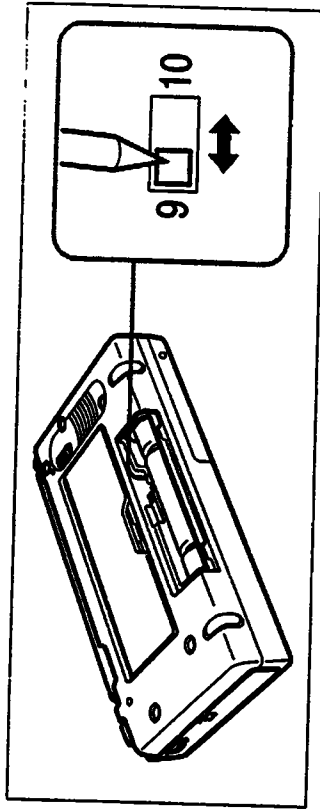

- 3 Set the **POWER/LOCK switch to POWER**.

Area	MW channel step
North and South American countries	10 kHz
Other countries	9 kHz

Note

You cannot change the MW channel step with the step 2 only. Follow the steps from 1 to 3 completely.

Manual Tuning

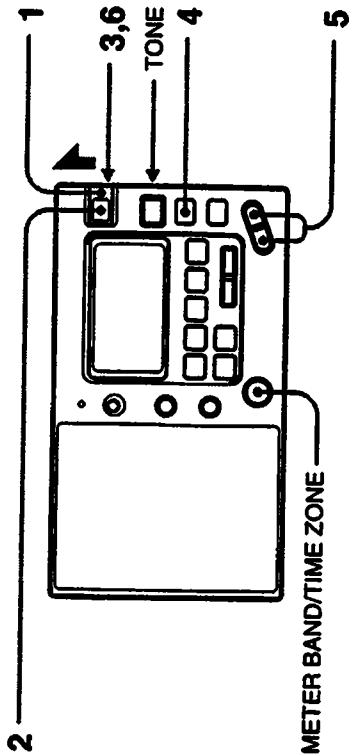

- 1 Set the **POWER/LOCK** switch to **POWER**.
- 2 Press the **ON/OFF** button to turn the radio on.
- 3 Turn the **VOL** control a little to get sound.
- 4 Press the **BAND** button to select the band.
Each press of the button changes the band in the following order.

→ MW → SW → FM

(The display window shows the last frequency chosen in each band.)

For **SW**, while pressing the **METER BAND/TIME ZONE** button, press the **TUNE +** or **-** button to select the meter band.

5 **Tune in the desired station by pressing the TUNE + or - button.**

If you keep the button pressed, frequencies change continuously.

For the channel step, see the table on page 35.

6 **Adjust the volume.**

To turn the radio off

Press the **ON/OFF** button.

On TONE selector

When you listen to the news, set the **TONE** selector to **NEWS**. Human voice will be heard more clearly. When you listen to music, set it to **MUSIC**.

To enjoy FM stereo

Connect the stereo earphones to the **PHONES** jack.

To Improve Reception

MW: Since the reception is affected by the position of the radio, rotate the unit horizontally for optimum reception.

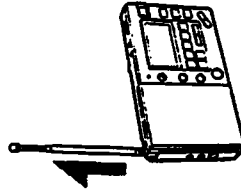
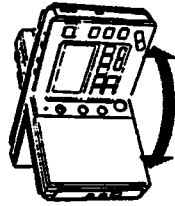

SW: Pull out the telescopic antenna to its full length and set it vertically. Usually the telescopic antenna is sufficient for **SW** reception. However, in a metal or concrete building, use the wire antenna supplied.

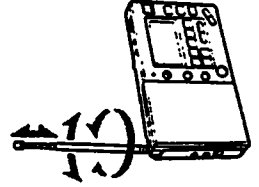

FM: Extend the telescopic antenna and adjust the length, direction and angle for the best reception.

Manual Tuning

How to use the supplied SW compact antenna

Usually the telescopic antenna is sufficient for SW reception. However, in a metal or concrete building, the use of the supplied SW compact antenna (AN-71) is recommended.

- 1 Fully pull out the cord from the case.
 - 2 Attach the coupler to the telescopic antenna.
 - 3 When the window can be opened: Extend the cord and the case out through the window, after making sure there is no danger.
- When the window cannot be opened: Fully extend the cord along the frame of the window.

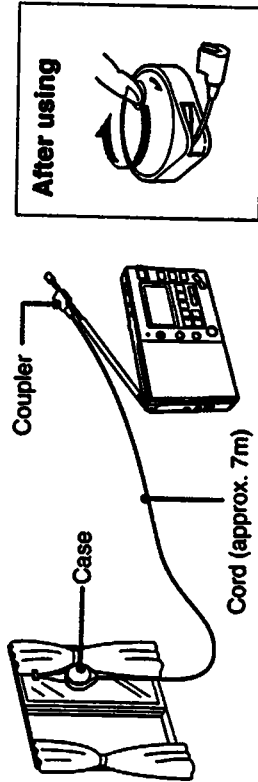

Using an external antenna for MW and SW reception

- Use the wide range antenna AN-1 or AN-102 (not supplied).
- 1 With a connecting cord, connect the OUTPUT jack of the antenna controller and the INPUT jack of the antenna coupler (supplied with the AN-1 or AN-102).

- 2 For MW: Put the antenna coupler near the ICF-SW33.
For SW: Attach the antenna coupler to the telescopic antenna.

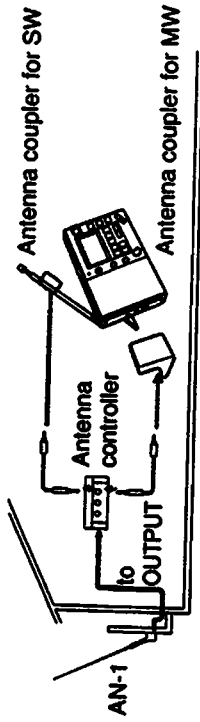

Note

For further details, refer to the instruction manual of the AN-1 or AN-102.

To Prevent Accidental Change of the Receiving Station

Press the KEY PROTECT button. The mark is displayed, indicating that all the functions of the buttons are locked. You can adjust the tone and volume even if the mark is displayed. To release the key protection, press the KEY PROTECT button again.

To Use the Unit in a Dimly Lighted Area

Press the LIGHT button. (The display should not be displayed.) The display window will be illuminated for about 20 seconds.

Scan Tuning

Use scan tuning to automatically scan the stations in the frequency range of a broadcast band.

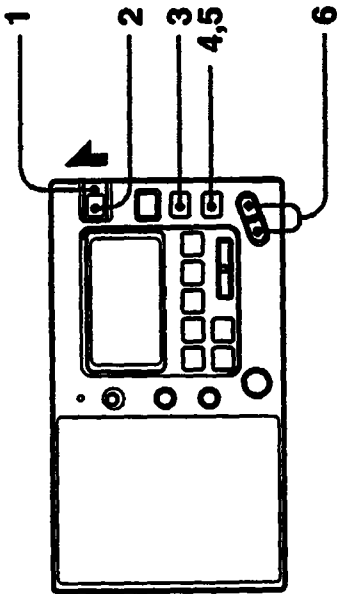

- 1 Set the **POWER/LOCK** switch to **POWER**.
- 2 Press the **ON/OFF** button to turn the radio on.
- 3 Press the **BAND** button to select the band.
For SW, select the meter band, too.
- 4 Press the **SCAN** button.
Within the frequency range of the table on page 35, scan tuning will begin and stop automatically for about 2.5 seconds when a station is received.
- 5 When your desired station is tuned in, press the **SCAN** button.
When you do not press the **SCAN** button, scan tuning will continue.
- 6 Tune the station more precisely with the **TUNE + or -** button, if necessary.

On SENS selector
Normally set this selector to **DX**. When the scan stops so often, set it to **LOCAL**.

Frequency range and channel step of each broadcast band

Band	Meter band	Frequency	Channel step
MW	/	531-1710 kHz *1	9 kHz
		530-1710 kHz *1	10 kHz
		531-1602 kHz *2	9 kHz
		530-1610 kHz *2	10 kHz
SW	/	3700-4200 kHz *1	1 kHz (Manual tuning) 5 kHz (Scan tuning)
		3850-4200 kHz *2	
		4650-5150 kHz	
		5800-6300 kHz	
		6950-7450 kHz	
		9375-10000 kHz	
		11525-12150 kHz	
		13375-14000 kHz	
		14975-15600 kHz	
		17475-18100 kHz	
FM	/	21320-21950 kHz	0.05 MHz
		25475-26100 kHz	
		87.50-108.00 MHz *3	
		76.00-108.00 MHz *4	

*1 Countries except for Italy and Saudi Arabia

*2 Italy and Saudi Arabia

*3 Germany, Austria, Scandinavian countries, Italy and Saudi Arabia

*4 Countries except for *3

Preset Tuning

You can preset up to five stations for each band in the MEMORY PRESET buttons M1 to M5 (a total of 15 stations) and 2 stations in the STANDBY MEMORY buttons S **a** and S **b**.

Note on the preset stations stored in the STANDBY MEMORY buttons

These stations can be used as the memories for standby operation. See page 38. Stations of any band can be stored in these two buttons.

Presetting the Stations

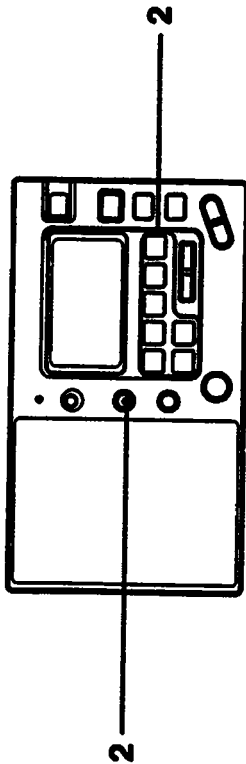

1 Tune in the desired station according to the procedures explained in "Manual Tuning" or "Scan Tuning".

2 While keeping the ENTER button pressed, press one of the MEMORY PRESET buttons M1 to M5, or STANDBY MEMORY buttons S **a** or S **b** in which you want to preset. "PRESET V" and preset number (or, **a** or **b**) appear in the display window.

To change the preset station

Preset a new station in the number of which you want to change the station. The previous station will be canceled.

Listening to the Preset Stations

- 1 Press the POWER/LOCK switch to POWER.
- 2 Press the ON/OFF button to turn the radio on.
- 3 Press the BAND button to select the band.
For STANDBY MEMORY button S **a** or S **b**, skip this step.
- 4 Press the desired MEMORY PRESET button M1 to M5 or STANDBY MEMORY button S **a** or S **b**.
- 5 Adjust the volume.

Using the Standby Function

Beep sounds for about 10 seconds until the standby time comes, and the radio will be turned on. The radio will be turned off automatically after about 120 minutes, unless you turn it off. Before setting the standby time, make sure that the desired station is preset in the STANDBY MEMORY button S **[a]** or **[b]**.

The standby time which is preset in the STANDBY/STANDBY TIME SET **[a]** button works on the radio station which is preset in the STANDBY MEMORY S **[a]** button. The standby time which is preset in the STANDBY/STANDBY TIME SET **[b]** button works on the radio station which is preset in the STANDBY MEMORY S **[b]** button.

Setting the Standby Time

Example: To set the standby time at 7:30

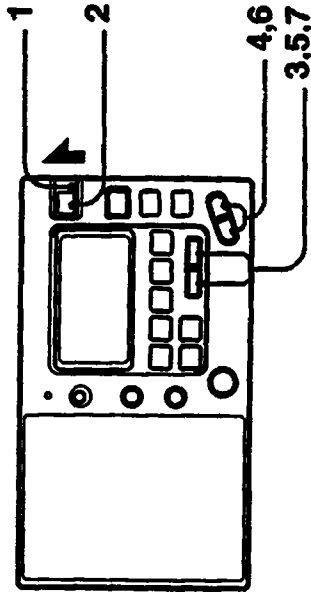

When you leave the unit for more than 64 seconds during the steps from 3 to 7, the unit returns to the condition before the step 3.

- 1 Set the **POWER/LOCK** switch to **POWER**.
- 2 Make sure that the radio is turned off.
- 3 Press the **STANDBY/STANDBY TIME SET [a]** or **[b]** button for more than 1 second.

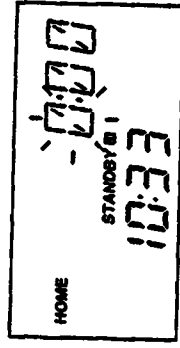
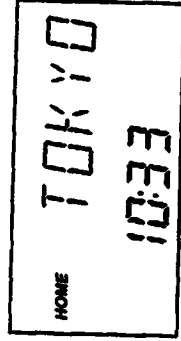

- 4 Adjust the hour with the + or - button.

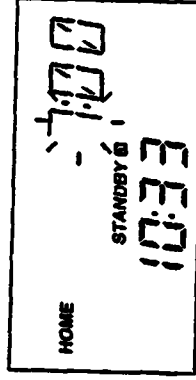

- 5 Press the **STANDBY/STANDBY TIME SET [a]** or **[b]** button.

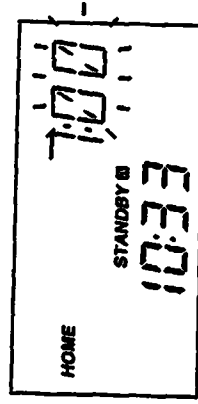

Using the Standby Function

- 6 Adjust the minute with the + or - button.

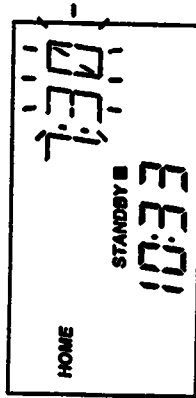

- 7 Press the STANDBY/STANDBY TIME SET **a** or **b** button.

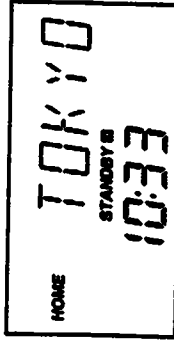
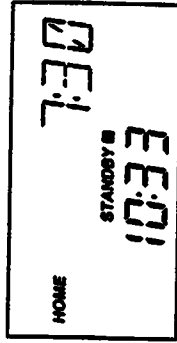

Setting is complete. Soon the standby time indication will change to the time difference or city name indication. STANDBY **a** or STANDBY **b** indication shows that the standby function is preset. STANDBY **a** and STANDBY **b** work independently of each other. You can set either or both of them.

Notes

- To stop the beep, press the ON/OFF button.
- To turn off the radio, press the ON/OFF button.
- After presetting the standby time, if you happen to set the POWER/LOCK switch to LOCK, STANDBY **a** and/or STANDBY **b** indication disappear and the standby function will not activate. Return the POWER/LOCK switch to POWER, and the standby function will be recovered.
- Standby function will not activate while you are setting the clock or setting the standby time.
- Radio sound will not be heard if the VOL control is turned down completely. Check the VOL control setting.

ATTENTION!



The standby function will activate when the current time indication becomes identical with the standby time which has been preset. So, make sure that either HOME or WORLD appears on the display. If you want to activate the standby function at your home (local) time, HOME indication should be displayed. If you want to activate it at the time in some place in the world, WORLD indication should be displayed. To change the indication, press the HOME/WORLD button.

To cancel the standby function

Press the unnecessary STANDBY/STANDBY TIME SET button **a** or **b**. STANDBY **a** or STANDBY **b** indication disappears. When you press the button again, the standby function will be set again.

Using the Standby Function



To check the standby time setting

Set the POWER/LOCK switch to POWER and press the STANDBY MEMORY S  or S  button. Standby time indication will be displayed for about 3 seconds.

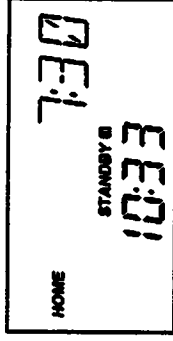
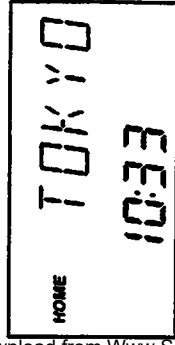
In 12-hour clock system, the indication "A" and "P" show the "AM" and "PM" respectively.



Note

When you check the standby time setting while you are listening to the radio, radio frequency changes to the frequency preset in the STANDBY MEMORY S  or S  button. In this case, select the band and frequency again.

When standby time preset comes while you are listening to the radio

Beep sounds for about 10 seconds before the standby time preset and the radio station now you are listening to will be replaced with the station which is preset at the standby time.

Using the Sleep Function

You can fall asleep while listening to the radio.

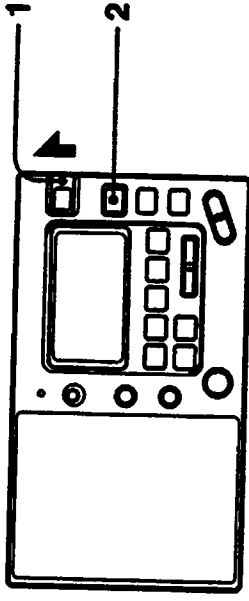

- 1 Set the POWER/LOCK switch to POWER.
- 2 Press the SLEEP button.

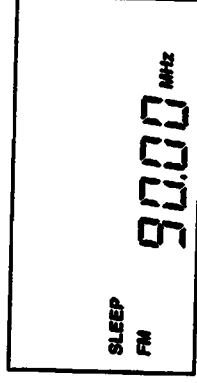

The radio is turned on. If necessary, select your desired station. After about 60 minutes, the radio will be turned off automatically. To turn off the radio before that time, press the ON/OFF button.

Note

To prolong the listening time, press the SLEEP button. The radio will be turned off 60 minutes later from then.

Recording a Broadcast

You can record radio programs by connecting a tape recorder to the REC OUT jack as illustrated below.

Tune in the desired station and start recording on the tape recorder. The volume control setting on the radio has no effect on the recording.

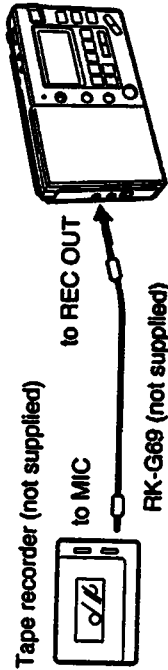

Troubleshooting Guide

The following checklist will help you to solve most of the problems that you may encounter with this unit. If problems persist after you have checked the following items, please consult your nearest Sony dealer.

The power is not turned on even if you press the ON/OFF button.

- Weak batteries.
- Incorrect polarity of batteries. See page 14.
- The POWER/LOCK switch is set to LOCK.
- The AC power adaptor or a car battery cord is not connected.
- Battery operation is attempted while an AC power adaptor or a car battery cord is connected to the unit, but not to a wall outlet or cigarette lighter socket.

No indication in the display

- Incorrect polarity of batteries. See page 14.
- Weak batteries.

Display is dim.

- Weak batteries.
- The unit is being used in extremely high temperature or in a place subject to excessive moisture.

Sound is not heard at all.

- The VOL control is turned down completely.
- The stereo earphones are plugged in.
- Incorrect polarity of batteries. See page 14.

Troubleshooting Guide

Very weak or interrupted sound, or unsatisfactory reception.

- Weak batteries.
- Tuning or antenna adjustment is not correct.
- Weak signal. →When using in a vehicle or in a building, listen near a window.
- The SENS selector is set to LOCAL. →Set to DX.

Stations have not been stored.

- You made wrong operation when you stored stations. →To store the stations, see page 36.



No key input is acceptable.

- The KEY PROTECT  button has been pressed. →Press the button again to release.
- The POWER/LOCK switch is set to LOCK.

The preset station cannot be received during preset tuning.

- Incorrect MEMORY PRESET or STANDBY MEMORY button has been used when you stored the station.
- The preset station was erased. →Store the station again.

The radio is not turned on at the standby time.

- STANDBY  or STANDBY  indication did not appear.
- You took more time than 3 minutes when replacing the batteries. →Set the standby time again.
- The POWER/LOCK switch is set to LOCK.
- The current time indication was not correct. →Make sure that either HOME or WORLD indication appears. Make sure that the city name or the time difference is correct.

You cannot change the city name or time difference.

- HOME indication appears. →Press the HOME/WORLD button.
- The POWER/LOCK switch is set to LOCK.

Radio disconnects even though you press the ON/OFF button.

- Batteries are exhausted. (The  mark flashes.) Replace all the batteries with new ones.

Specifications

Circuit system SW: Dual conversion superheterodyne
MW/FM: Single conversion superheterodyne

Frequency range

Band	Meter band	Frequency	Channel step
MW		531-1710 kHz *1	9 kHz
		530-1710 kHz *1	10 kHz
		531-1602 kHz *2	9 kHz
		530-1610 kHz *2	10 kHz
SW	75 m	3700-4200 kHz *1	1 kHz
		3650-4200 kHz *2	
	60 m	4650-5150 kHz	
	49 m	5800-6300 kHz	
	41 m	6950-7450 kHz	
	31 m	9375-10000 kHz	
	25 m	11525-12150 kHz	
	21 m	13375-14000 kHz	
	19 m	14975-15600 kHz	
	16 m	17475-18100 kHz	
13 m	21320-21950 kHz		
FM		25475-26100 kHz	0.05 MHz
		87.50-108.00 MHz *3	
		76.00-108.00 MHz *4	

*1 Countries except for Italy and Saudi Arabia

*2 Italy and Saudi Arabia

*3 Germany, Austria, Scandinavian countries, Italy and Saudi Arabia

*4 Countries except for *3

Intermediate frequency

MW: 450 kHz

SW: 21.44 MHz (1st)

450 kHz (2nd)

FM: 10.7 MHz

Antennas SW/FM: Telescopic antenna

MW: Built-in ferrite bar antenna

Approx. ø6.6 cm (2 1/8 inches)

Speaker

Power output
Output

200 mW (at 10 % harmonic distortion)
PHONES jack (stereo minijack)
REC OUT jack (minijack)

Output level 0.775 mV (-60 dB)
Output impedance 1 kilohm

Power requirements

4.5 V DC, three R6 (size AA) batteries
DC IN 4.5 V jack accepts:

Sony AC-E45M AC power adaptor (not supplied)

Sony DCC-E145L car battery cord (not supplied) for use with 12 V car battery

Approx. 11 hours of listening for 4 hours a day at a normal volume using Sony batteries SUM-3 (NS)

Battery life

Dimensions

Approx. 165.7 x 93 x 30.5 mm (w/h/d)
(Approx. 6 5/8 x 3 3/4 x 1 1/4 inches)

Mass

not incl. projecting parts and controls.

Approx. 401 g (14.15 oz) incl. batteries.

Accessories supplied

Carrying case (1)

SW compact antenna (1)

Short wave guide (1) only English version

Design and specifications subject to change without notice.

Note

This appliance conforms with EEC Directive 87/308/EEC regarding interference suppression.

Accessories not supplied

AC power adaptor AC-E45M

Car battery cord DCC-E145L

MW/SW wide range antenna AN-1/AN-102

Connecting cord RK-G69 (miniplug to miniplug, no resistor type)

Your dealer may not handle some of the above listed accessories.

Please ask the dealer for detailed information about them available in your country.

Free Manuals Download Website

<http://myh66.com>

<http://usermanuals.us>

<http://www.somanuals.com>

<http://www.4manuals.cc>

<http://www.manual-lib.com>

<http://www.404manual.com>

<http://www.luxmanual.com>

<http://aubethermostatmanual.com>

Golf course search by state

<http://golfingnear.com>

Email search by domain

<http://emailbydomain.com>

Auto manuals search

<http://auto.somanuals.com>

TV manuals search

<http://tv.somanuals.com>