

FM Stereo FM-AM Receiver

Operating Instructions

STR-DE345

© 2000 Sony Corporation

WARNING

To prevent fire or shock hazard, do not expose the unit to rain or moisture.

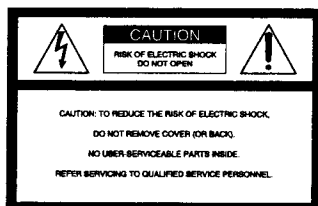

This symbol is intended to alert the user to the presence of uninsulated "dangerous voltage" within the product's enclosure that may be of sufficient magnitude to constitute a risk of electric shock to persons.



This symbol is intended to alert the user to the presence of important operating and maintenance (servicing) instructions in the literature accompanying the appliance.

IMPORTANT

This equipment has been tested and found to comply with the limits for a Class B digital device, pursuant to Part 15 of the FCC Rules.

These limits are designed to provide reasonable protection against harmful interference in a residential installation. This equipment generates, uses, and can radiate radio frequency energy and, if not installed and used in accordance with the instructions, may cause harmful interference to radio communications. However, there is no guarantee that interference will not occur in a particular installation. If this equipment does cause harmful interference to radio or television reception, which can be determined by turning the equipment off and on, the user is encouraged to try to correct the interference by one or more of the following measures:

- Reorient or relocate the receiving antenna.
- Increase the separation between the equipment and receiver.
- Connect the equipment into an outlet on a circuit different from that to which the receiver is connected.
- Consult the dealer or an experienced radio/TV technician for help.

CAUTION

You are cautioned that any change or modifications not expressly approved in this manual could void your authority to operate this equipment.

Note to CATV system installer

This reminder is provided to call the CATV system installer's attention to Article 820-40 of the NEC that provides guidelines for proper grounding and, in particular, specifies that the cable ground shall be connected to the grounding system of the building, as close to the point of cable entry as practical.



ENERGY STAR® is a U.S. registered mark. As an ENERGY STAR® partner, Sony Corporation has determined that this product meets the ENERGY STAR® guidelines for energy efficiency.

Owner's record

The model and serial numbers are located on the rear of the unit. Record the serial number in the space provided below. Refer to them whenever you call upon your Sony dealer regarding this product.

Model No. STR-DE345

Serial No. _____

Precautions

On safety

- Should any solid object or liquid fall into the cabinet, unplug the receiver and have it checked by qualified personnel before operating it any further.

On power sources

- Before operating the receiver, check that the operating voltage is identical with your local power supply. The operating voltage is indicated on the nameplate at the rear of the receiver.
- The receiver is not disconnected from the AC power source (MAINS) as long as it is connected to the wall outlet, even if the receiver itself has been turned off.
- If you are not going to use the receiver for a long time, be sure to disconnect the receiver from the wall outlet. To disconnect the AC power cord, grasp the plug itself; never pull the cord.
- One blade of the plug is wider than the other for the purpose of safety and will fit into the wall outlet only one way. If you are unable to insert the plug fully into the outlet, contact your dealer.
- Should the AC power cord need to be changed, have it done at a qualified service shop only.

On placement

- Place the receiver in a location with adequate ventilation to prevent heat build-up and prolong the life of the receiver.
- Do not place the receiver near heat sources, or in a place subject to direct sunlight, excessive dust or mechanical shock.
- Do not place anything on top of the cabinet that might block the ventilation holes and cause malfunctions.

On operation

- Before connecting other components, be sure to turn off and unplug the receiver.

On cleaning

- Clean the cabinet, panel and controls with a soft cloth slightly moistened with a mild detergent solution. Do not use any type of abrasive pad, scouring powder or solvent such as alcohol or benzine.

For detailed safety precautions, see the "IMPORTANT SAFEGUARDS" leaflet.

If you have any question or problem concerning your receiver, please consult your nearest Sony dealer.

About This Manual

The instructions in this manual is for model STR-DE345. Check your model number by looking at the upper right corner of the front panel.

Conventions

- The instructions in this manual describe the controls on the receiver. You can also use the controls on the remote if they have the same or similar names as those on the receiver. For details on the use of the remote, refer to the separate operating instructions supplied with the remote.

- A "Quick Reference Guide" is supplied on the back cover.
- The following icons are used in this manual:



Indicates that you can use only the remote to do the task.



Indicates hints and tips for making the task easier.

This receiver contains a Dolby Pro Logic Surround decoder.

Manufactured under license from Dolby Laboratories.

"Dolby", "AC-3", "Pro Logic" and the double-D symbol  are trademarks of Dolby Laboratories.

TABLE OF CONTENTS

Getting Started

- Unpacking 4
 - Hookup Overview 4
 - Antenna Hookups 5
 - Audio Component Hookups 5
 - Video Component Hookups 6
 - Speaker System Hookups 7
 - AC Hookups 9
 - Before You Use Your Receiver 9
-

Receiver Operations

- Selecting a Component 10
 - Receiving Broadcasts 11
 - Presetting Radio Stations 12
 - Recording 13
 - Using the Sleep Timer 14
-

Using Surround Sound

- Choosing a Sound Field 15
 - Getting the Most Out of Dolby Pro Logic Surround Sound 16
-

Additional Information

- Troubleshooting 19
 - Specifications 20
 - Glossary 21
-

Index 22

Rear Panel Descriptions 23

Quick Reference Guide Back cover

Unpacking

Check that you received the following items with the receiver:

- FM wire antenna (1)
- AM loop antenna (1)
- Remote commander (remote) (1)
- Size AA (R6) batteries (2)
- Operating Instructions of the remote RM-PP404

Hookup Overview

The receiver allows you to connect and control the following audio/video components. Follow the hookup procedures for the components that you want to connect to the receiver on the pages specified. To learn the locations and names of each jack, see "Rear Panel Descriptions" on page 23.

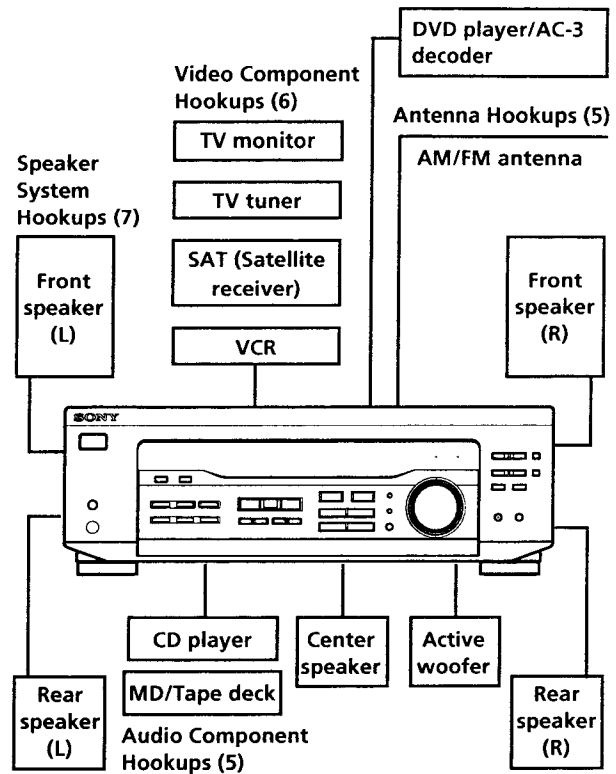

Before you get started

- Turn off the power to all components before making any connections.
- Do not connect the AC power cords until all of the connections are completed.
- Be sure to make connections firmly to avoid hum and noise.
- When connecting an audio/video cable, be sure to match the color-coded pins to the appropriate jacks on the components: Yellow (video) to Yellow; White (left, audio) to White; and Red (right, audio) to Red.

Antenna Hookups

Overview

This section describes how to connect AM and FM antennas to the receiver. If you want to receive radio broadcasts with the receiver, complete these connections first, then go to the following pages. For specific locations of the terminals, see the illustration below.

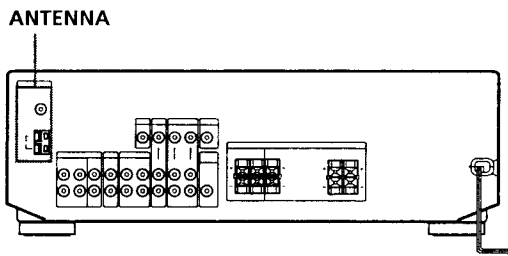

What antennas will I need?

- FM wire antenna (supplied) (1)
- AM loop antenna (supplied) (1)



Hookups

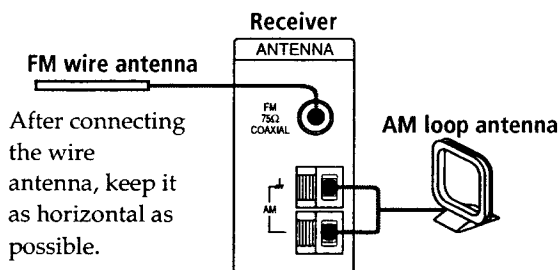

💡 If you have poor FM reception

Use a 75-ohm coaxial cable (not supplied) to connect the receiver to an outdoor FM antenna as shown below.

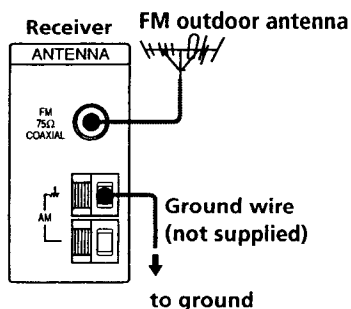

💡 If you have poor AM reception

Connect a 20 to 50 ft. (6 to 15-meter) insulated wire (not supplied) to the AM antenna terminal in addition to the AM loop antenna. Try to extend the wire outdoors and keep it horizontal.

Connecting a ground wire

If you connect the receiver to an outdoor antenna, ground it against lightning as shown in the illustration in the left column. To prevent a gas explosion, do not connect the ground wire to a gas pipe.

Where do I go next?

If you want to connect other components, go on to the next section. If you're only planning to use the receiver to listen to the radio, go to "Speaker System Hookups" on pages 7 and 8.

Audio Component Hookups

Overview

This section describes how to connect your audio components to the receiver. If you want to use the receiver as an amplifier, complete these connections. For specific locations of the jacks, see the illustration below.

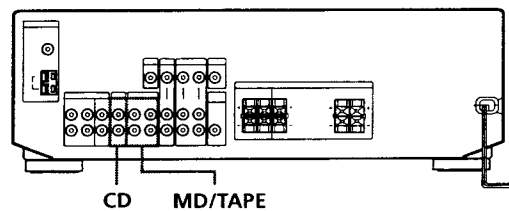

What cables will I need?

Audio cables (not supplied) (1 for CD player; 2 for each MD recorder or tape deck)

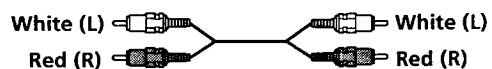

(continued)

Hookups

The arrow \Rightarrow indicates signal flow.

CD player

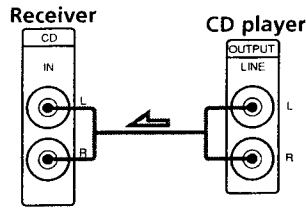

MD recorder or Tape deck

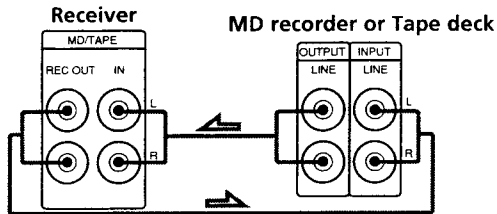

Where do I go next?

Go on to the next section to connect video components to enjoy surround sound when watching/listening to TV programs or video tapes.

Video Component Hookups

Overview

This section describes how to connect video components to the receiver. For specific locations of the jacks, see the illustration below.

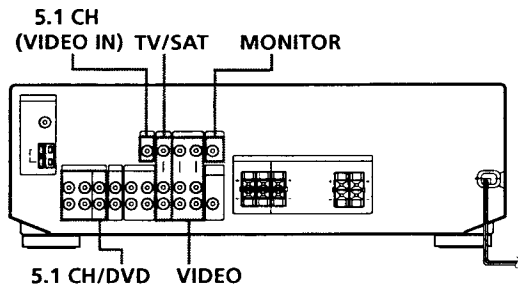

What cables will I need?

- Audio/video cable (not supplied) (1 for each TV tuner or Satellite receiver; 2 for the VCR)



- Video cable (not supplied) (1 for a TV monitor)



Hookups

The arrow \Rightarrow indicates signal flow.

TV/SAT

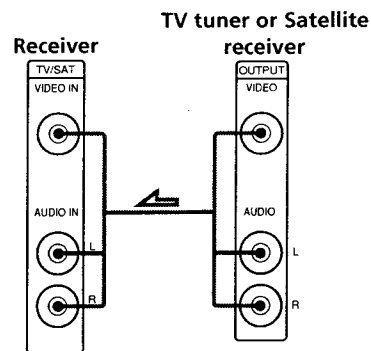

MONITOR

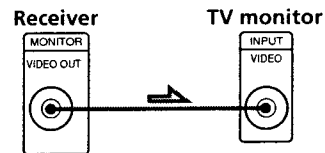

VCR

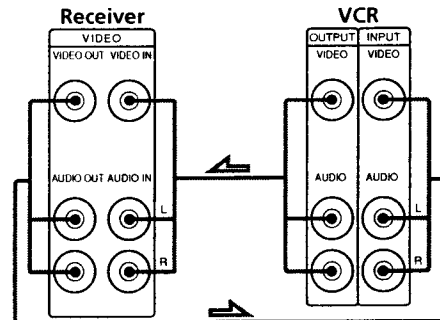

- 💡 Use the function buttons (TV/SAT, CD, MD/TAPE etc.) to select the VIDEO AUDIO OUT signal. You can record this audio signal by connecting a recording component such as a cassette deck (to the VIDEO AUDIO OUT jack).

DVD player/AC-3 decoder

What cables will I need?

- Audio cable (not supplied) (1 for each 5.1 CH/DVD FRONT and REAR jacks)



- Monaural audio cable (not supplied) (1 for each 5.1 CH/DVD CENTER and SUB WOOFER jacks)



- Video cable (not supplied) (1 for the 5.1 CH VIDEO IN jack)

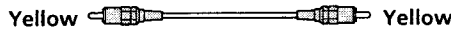

💡 You can play decoded Dolby Digital AC-3 soundtracks through the speakers connected to the receiver. If you have a Dolby Digital AC-3 decoder you can amplify a decoded Dolby Digital AC-3 soundtrack with the following connections.

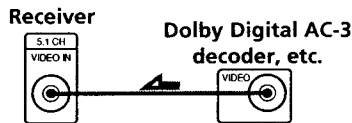
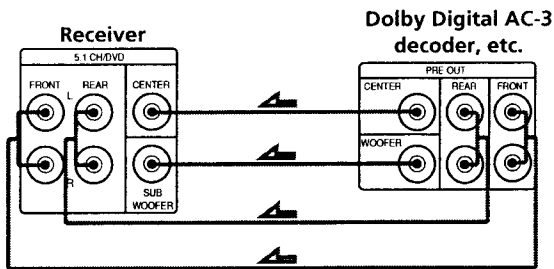

Where do I go next?

Go on to the next section to connect the speakers.

Speaker System Hookups

Overview

This section describes how to connect your speakers to the receiver. Although front (left and right) speakers are required, center and rear speakers are optional. Adding center and rear speakers will enhance the surround effects. Connecting an active woofer will increase bass response. For specific locations of the terminals, see the illustration below.

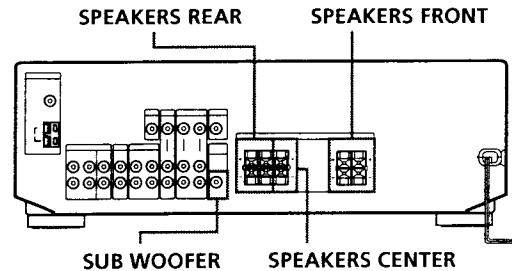

For optimum surround sound effect, place your speakers as shown below.

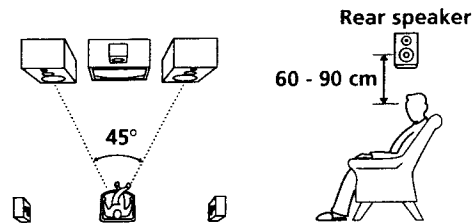

What cords will I need?

Speaker cord (not supplied) (1 for each speaker)



Twist the stripped ends of the cord about 2/3 inch (15 mm). Be sure to match the speaker cord to the appropriate terminal on the components: + to + and - to -. If the cords are reversed, the sound will be distorted and will lack bass.

(continued)

Hookups

Front Speakers

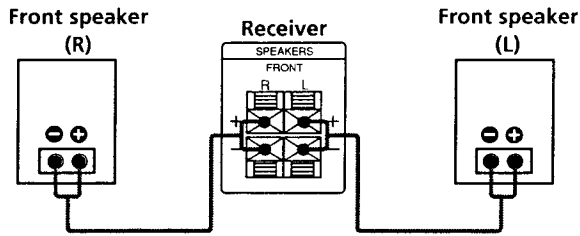

Rear and center speakers

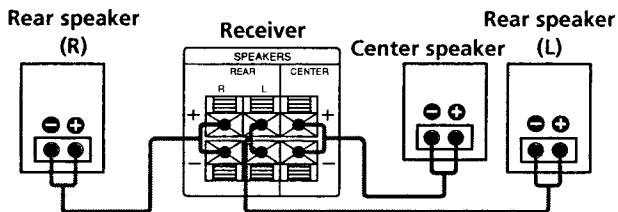

To avoid short-circuiting the speakers

Short-circuiting of the speakers may damage the receiver. To prevent this, make sure to take the following precautions when connecting the speakers. Make sure the stripped ends of each speaker cord does not touch another speaker terminal or the stripped end of another speaker cord.

Examples of poor conditions of the speaker cord:

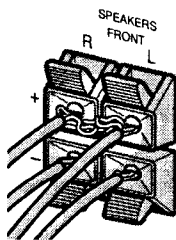

Stripped speaker cord is touching another speaker terminal.

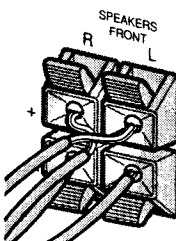

Stripped cords are touching each other due to excessive removal of insulation.

After connecting all the components, speakers and AC power cord, output a test tone to check that all the speakers are connected correctly. For details on outputting a test tone, refer to "Adjusting the speaker volume", on page 17.

If you have connected rear speakers, be sure to press the 5.1 CH/DVD button and turn off sound field on the receiver before outputting a test tone so that the tone is output individually from the left and right rear speakers.

If no sound is heard from a speaker while outputting a test tone or a test tone is output from a speaker other than the one whose name is currently displayed on the receiver, the speaker may be short-circuited. If this happens, check the speaker connection again.

Active woofer

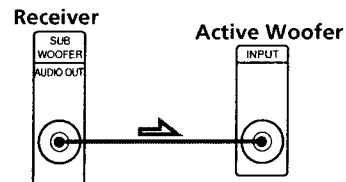

Note

Do not connect any other component.



To listen to the speakers

Make sure that you set the SPEAKERS button to ON.



If your TV monitor uses separate speakers

You can connect one of them to the SPEAKERS CENTER terminals for use with Dolby Pro Logic Surround sound (see page 16).

Where do I go next?

To complete your system, go to "AC Hookups" on next page.

AC Hookups

Connecting the AC power cord

Connect the AC power cord from this receiver and from your audio/video components to a wall outlet.

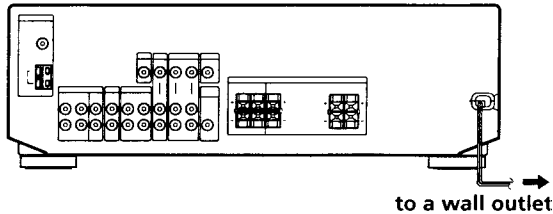

Where do I go next?

Before you use the receiver, go to the next section to make sure that all the controls are set to the appropriate positions.

Before You Use Your Receiver

Before turning on the receiver, make sure that you have:

- Set the SPEAKERS button to ON.

Before you use your receiver for the first time or when you want to clear the receiver's memory, do the procedure below:

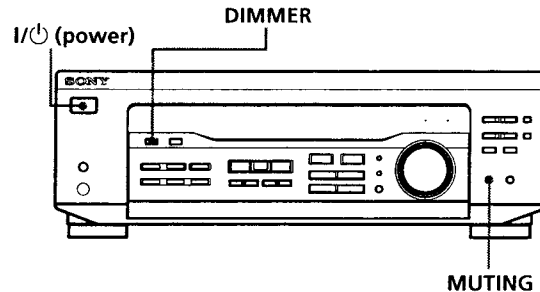

- 1 Turn off the receiver.
- 2 Press I/⏻ (power) for more than 4 seconds. "INITIAL" appears in the display and the items including the following are reset or cleared:
 - All preset stations are reset to their factory settings.
 - All sound field parameters are reset to their factory settings.
 - All index names (of preset stations and program sources) are cleared.
 - All adjustments made with the SET UP button are reset to their factory settings.
 - The sound field memorized for each program source and preset station is cleared.

Turn on the receiver and check the following indicator.

- Press MUTING if the MUTING indicator turns on.
- Press DIMMER repeatedly to set the display at any of four levels of brightness.

Selecting a Component

To listen to or watch a connected component, first select the function on the receiver or with the remote. Before you begin, make sure you have:

- Connected all components securely and correctly as indicated on pages 5 to 9.

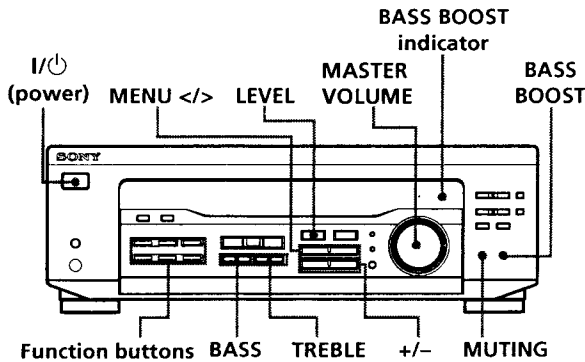

- 1 Press I/⏻ (power) to turn on the receiver.
- 2 Press a function button to select the component you want to use:

To listen to or watch	Press
Radio programs	TUNER
Compact discs (CD)	CD
MiniDiscs (MD) or audio tapes	MD/TAPE
TV programs or Satellite receiver	TV/SAT
Video tapes	VIDEO
DVD player/AC-3 decoder	5.1 CH/DVD

- 3 Turn on the component, for example, a CD player, and then start playing.
To tune in radio stations on this receiver, see "Receiving Broadcasts" on page 11.
- 4 Turn MASTER VOLUME to adjust the volume. Every time you turn MASTER VOLUME, the display changes as follows:

VOL MIN ↔ VOL 1 ↔ ... ↔ VOL 30
↔ VOL MAX

- 💡 **To adjust the volume of the TV's speaker**
Use the volume control on the TV.

💡 To avoid damaging your speakers

Make sure that you turn down the volume before you turn off the receiver. When you turn on the receiver, the volume remains at the level you turn off the receiver.

To	Do this
Mute the sound	Press MUTING. Press again to restore the sound.
Reinforce the bass	Press BASS BOOST to turn on the BASS BOOST indicator.
Adjust the balance	<ol style="list-style-type: none"> 1 Press LEVEL or CURSOR MODE on the remote repeatedly until the LEVEL indicator lights up. 2 Press MENU < or > repeatedly until "BALANCE" appears on the display. 3 Press + or - to adjust the balance right or left.
Adjust the tone quality	Press BASS +/- and TREBLE +/- to adjust the tone level. You can select a tone level of -6dB to +6dB in 2-dB steps.

💡 When you listen with headphones

Connect the headphones to the PHONES jack and set the SPEAKERS button to OFF.

Watching/listening to video programs

When you watch/listen to TV or video programs, we recommend you play audio portion through the receiver instead of your TV's speaker. This lets you take advantage of the receiver's surround sound effects, such as Dolby Pro Logic Surround and lets you use the receiver's remote to control the audio. Turn off the speakers on your TV before you start so you can enjoy the surround sound from your receiver.

To watch/listen to TV programs, turn on the TV, TV tuner and the receiver and press TV/SAT on the receiver.

To watch videos, do the following:

- 1 Press VIDEO to select the VCR.
- 2 Turn on the TV and set the TV's video input to match your video component.
- 3 Turn on the VCR, and start playback.

Receiving Broadcasts

This receiver lets you enter a station's frequency directly by using the numeric buttons on the remote (direct tuning). If you don't know the frequency of the station you want, see "Receiving broadcasts by scanning stations (automatic tuning)" on this page.

Before you begin, make sure you have:

- Connected an FM/AM antenna to the receiver as indicated on page 5.
- Set the SPEAKERS button to ON.

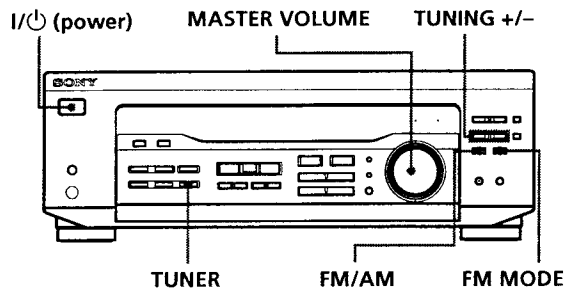

- 1 Press I/⏻ (power) to turn on the receiver.
- 2 Press TUNER.
The last received station is tuned in.
- 3 Press FM/AM to select FM or AM stations.
- 4 Press D. TUNING on the remote.
- 5 Press the numeric buttons on the remote to enter the frequency.

Example 1: FM 102.50 MHz

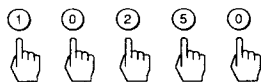

Example 2: AM 1350 kHz

(10 kHz interval)

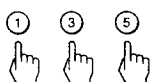

(9 kHz interval)

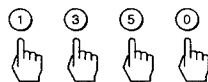

- 6 When you tune in AM stations, adjust the direction of the AM loop antenna for optimum reception.

To receive other stations

Repeat Steps 3 to 5.

💡 If the STEREO indicator remains off
Press FM MODE when an FM stereo broadcast is received.

💡 If an FM stereo program is distorted
The STEREO indicator flashes. Press FM MODE to change to monaural (MONO). You will not have the stereo effect but the distortion will be reduced. To return to stereo mode, press this button again.

💡 If you cannot tune in a station and the entered numbers are flashing
Make sure you've entered the right frequency. If not, press D. TUNING and re-enter the frequency you want on the remote. If the entered numbers still flash, the frequency is not used in your area.

💡 To watch FM simulcast TV programs
Make sure that you tune in the simulcast program both on the TV (or the VCR) and on the receiver.

💡 If you enter a frequency not covered by the tuning interval
The entered value is automatically rounded up or down to the closest covered value.

Tuning intervals for direct tuning are:

FM: 50 kHz intervals

AM: 9 kHz/10 kHz intervals (see page 20)

Receiving broadcasts by scanning stations (automatic tuning)

If you don't know the frequency of the radio station you want, you can have the receiver scan all the receivable stations to locate the one you want.

- 1 Press TUNER.
The last received station is tuned in.
- 2 Press FM/AM to select FM or AM.
- 3 Press TUNING + or -.
Press the + button for a higher frequency; press the - button for a lower one. When you tune past either end of the band, the receiver automatically jumps to the opposite end. Every time a station is received, the receiver stops scanning. To continue scanning, press the button again.

Presetting Radio Stations

You'll most likely want to preset the receiver with the radio stations you listen to often so that you don't have to tune in the station every time. The receiver can store a total of 30 FM or AM stations. You can store the stations on preset numbers combining three characters (A, B, C) and numbers (0 - 9). For example, you can store a station as preset number A1, B6 or C9, etc.

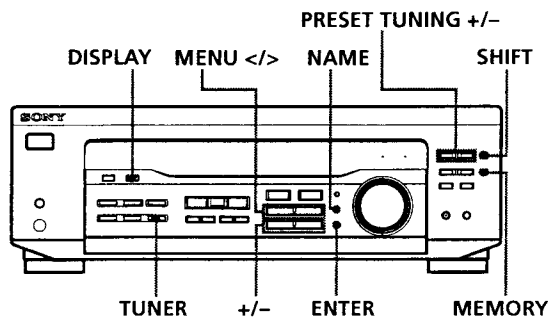

- 1** Press TUNER.
The last received station is tuned in.
- 2** Tune in the station you want.
If you are not familiar with how to tune in a station, see "Receiving Broadcasts" on the previous page.
- 3** Press MEMORY.
"MEMORY" appears for a few seconds.
Do steps 4 to 6 before "MEMORY" goes out.
- 4** Press SHIFT to select a character (A, B or C).
Each time you press SHIFT, the letter "A", "B" or "C" appears in the display.
If "MEMORY" disappears, start again from step 3.
- 5** Select a preset number by pressing PRESET TUNING + or PRESET TUNING -.
- 6** Press MEMORY again to store the station.
- 7** Repeat Steps 2 to 6 to preset other stations.

To change a preset station

Preset a new station on the number you want to change.

Note

If the AC power cord is disconnected for about one week, the preset stations will be cleared from the receiver's memory, and you will have to preset the stations again.

Tuning preset stations (preset tuning)

You can tune directly to a preset station by entering its preset number. If you don't know which stations are preset on which numbers, you can tune by scanning the preset stations.

- 1** Press TUNER.
The last received station is tuned in.
- 2** Press SHIFT to select a character (A, B or C), then press the number on the remote.
For example, to tune in the station preset as A7, select A and then press 7.

💡 You can tune by scanning the preset stations

First press TUNER and then press PRESET TUNING + or - to select the station you want. Each time you press the buttons, the preset numbers change as follows:

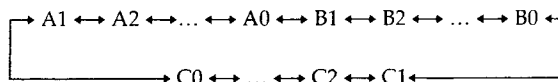

Naming preset stations

You can store names (index names), up to 8 characters long, for your preset stations. Once you name a preset station, the name appears in the display instead of the frequency when you tune to that preset station. The characters you can use include letters, numbers and symbols.

- 1** Tune to the preset station you want to name.
- 2** Press NAME.
The cursor blinks in the display.
- 3** Use + or – to select the character you desire.
- 4** Press MENU </> to move the cursor into position for the next character.
- 5** Repeat steps 3 and 4 to enter up to 8 characters.
- 6** Press ENTER to store the names.

If you make a mistake

Press MENU </> repeatedly so that the character you want to change blinks in the display, then use + or – to select the desired character.

To display index names

Press DISPLAY repeatedly to display index names and program source (or frequency if you select TUNER).

Notes

- You can also enter a name of up to 8 characters for program sources. Select the program source you want and repeat steps 2 to 6 (except 5.1 CH/DVD).
- To clear program source name, press NAME and then press the same program source button. Press ENTER to delete the name (except TUNER).

Recording

This receiver makes it easy to record to and from the components connected to the receiver. You don't have to connect playback and recording components directly: once you select a program source on the receiver, you can record and edit as you normally would using the controls on each component. Before you begin, make sure you've connected all components properly.

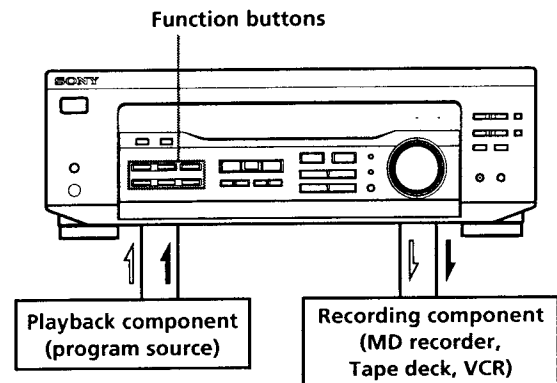

↔: Audio signal flow

→: Video signal flow

Recording on a MiniDisc or audio tape

You can record on a MiniDisc or cassette tape using the receiver. See the instruction manual of your MD recorder or tape deck if you need help.

- 1** Press one of the function buttons to select the program source.
- 2** Set the component to be ready for playing. For example, insert a CD into the CD player.
- 3** Insert a blank disc or tape into the recording deck and adjust the recording level, if necessary.
- 4** Start recording on the recording deck and then start playing the component.

(continued)

Recording on a video tape

You can record from a TV or a satellite receiver using the receiver. You can also add audio from a variety of audio sources when editing a video tape. See your VCR's instruction manual if you need help.

- 1 Press TV/SAT to select the program source.
- 2 Set the component to be ready for playing. For example, turn on the TV and TV tuner.
- 3 Insert a blank video tape into the VCR for recording.
- 4 Start recording on the VCR.

You can replace audio while editing a video tape

At the point you want to start adding different sound, press another function button (for example, CD) and start playback. The sound from the selected component will be recorded over the original audio.

To resume recording the original sound, press the TV/SAT function button.

Note

You cannot record the audio and video signal during 5.1 CH/DVD mode.

Using the Sleep Timer

You can set the receiver to turn off automatically at a time you specify.

Press SLEEP on the remote while the power is on. Each time you press SLEEP, the time changes as shown below.

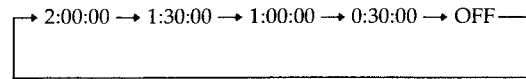

The display dims after you specify the time.

You can check the time remaining before the receiver turns off

Press SLEEP on the remote. The remaining time appears in the display.

Choosing a Sound Field

You can take advantage of surround sound simply by selecting one of the pre-programmed sound field according to the type of music you wish to play.

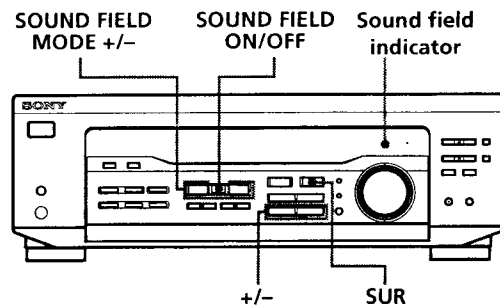

- 1 Press SOUND FIELD ON/OFF to turn on the sound field.
The sound field indicator lights up.
- 2 Press SOUND FIELD MODE +/- repeatedly until the sound field you want appears on the display.
Select the appropriate sound field as follows:

Type	MODE (Sound field)	Effects
CINEMA	PRO LOGIC*	Decodes programs processed with Dolby Pro Logic Surround.
	C. STUDIO (Cinema Studio)	Reproduces the sound characteristics of a movie theatre. Good for watching standard movies.
VIRTUAL	DOLBY V	Uses front speakers to create surround sound effects.
	V SURR**	Uses front speakers and center speaker to create surround sound effects.
MUSIC	HALL	Reproduces the acoustics of a rectangular concert hall. Ideal for soft acoustic sounds.

* "DOLBY PL" appears on the display.

** When using 5.1 CH/DVD only.

To turn off sound field

Press SOUND FIELD ON/OFF.

💡 The receiver memorizes the last sound field selected for each program source (Sound Field Link)

Whenever you select a program source, the sound field that was last applied is automatically applied again. For example, if you listen to CD with HALL as the sound field, change to different program source, then return to CD, HALL will be applied again. In the case of the tuner, the sound fields for AM or FM band and for all the preset stations are memorized separately.

💡 You can find Dolby Surround-encoded software by looking at the packaging

However, some videos and laser discs may use Dolby Surround sound even if it's not indicated on the package.

Adjusting the Effect Level (all sound fields except PRO LOGIC)

You can make the surround sound more prominent by increasing the EFFECT level. This control lets you adjust the "presence" of the surround effect in six steps (1-6).

- 1 Start playing a program source.
- 2 Press SUR.
The effect level ("EFFECT 1" ... "EFFECT 6") appears on the display.
- 3 Press +/- to select the level you prefer.

Note

Changing the effect level may not produce major variations in the surround effect when used with certain playback sources.

Getting the Most Out of Dolby Pro Logic Surround Sound

To obtain the best possible Dolby Pro Logic Surround sound, first select the center mode according to the speaker system you have. Then, adjust each speaker volume and delay time.

Note that you must have at least one additional pair of speakers and/or one center speaker to do the following adjustments.

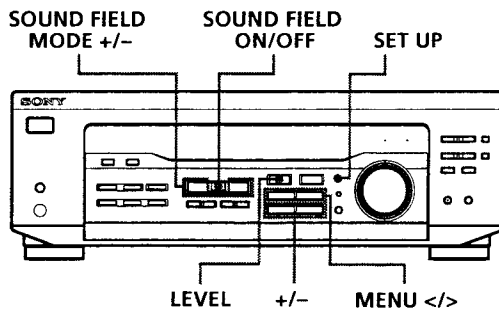

Selecting the center mode

The receiver offers you four center modes: Phantom, Normal, Wide and 3 STEREO. Each mode is designed for a different speaker configuration. Select the mode that best suits your speaker's system configuration:

- 1** Press SOUND FIELD ON/OFF to turn on the sound field.
- 2** Press SOUND FIELD MODE +/- repeatedly to select the Dolby surround sound field (PRO LOGIC or C.STUDIO mode).
- 3** Press SET UP.
- 4** Press MENU < or > repeatedly until "CTR MODE" appears on the display.

- 5** Press +/- repeatedly until the center mode you want appears on the display. Select the center mode as follows:

If you have	Select	So that
Front and rear speakers, and a small center speaker	NORMAL	The bass sound of the center channel is output from the front speakers (because a small speaker cannot produce enough bass).
Front and center speakers, no rear speaker	3 STEREO (3 Channel Logic)	The sound of the rear channel is output from the front speakers.
Front and rear speakers, no center speaker	PHANTOM	The sound of the center channel is output from the front speakers.
Front and rear speakers, and a large center speaker	WIDE	The center channel fully reproduces the entire audio spectrum.

Adjusting the speaker volume

The test tone feature lets you set the volume of your speakers to the same level. (If all of your speakers have equal performance, you don't have to adjust the speaker volume.)

Using the controls on the remote lets you test the speaker connection and adjust the volume level from your listening position.

- 1** Press SOUND FIELD ON/OFF to turn on the sound field.
Press SOUND FIELD MODE +/- repeatedly to select "DOLBY PL".
- 2** Press TEST TONE on the remote.
You will hear the test tone from each speaker sequentially.
- 3** Adjust the volume level so that the volume of test tone from each speaker sounds the same when you are in your main listening position.
 - Press REAR +/- or CENTER +/- to adjust the rear or center speaker level respectively.
- 4** Press TEST TONE on the remote to turn off the test tone.

 **You can adjust all speakers at one time**
Adjust MASTER VOLUME on the receiver.

 **You can also adjust the volume level with the controls on the receiver**

After pressing TEST TONE on the remote:

- Press MENU < or > repeatedly to select "CTR xxdB".
Press +/- to adjust the center speaker level.
- Press MENU < or > repeatedly to select "REAR xxdB".
Press +/- to adjust the rear speaker level.

You can select a volume level of -15 dB to +10 dB in 1-dB steps.

 **You can adjust the volume level of the sub woofer**

- Press LEVEL until the LEVEL indicator lights up.
- Press MENU < or > repeatedly to select "SW xxdB".
- Press +/- to adjust the level.

You can select a volume level of -15dB to +10dB in 1-dB steps.

 **You can increase the output level of the rear speakers**

The adjustment range of the rear speakers is preset from -15 to +10, but you can shift the range up 5 levels (-10 to +15).

- Press SET UP.
- Press MENU < or > repeatedly until "REAR SET UP" appears on the display.
- Press +/- repeatedly until "NORMAL" appears on the display.

The values for the rear level remain fixed at -15 to +10 in the display, but you will be able to hear the difference in the actual output level.

To reset the rear level adjustment range, repeat this procedure to display "GAIN LOW".

 **You can reset all sound field settings to initial setting**

- Turn off the receiver.
- Hold down SOUND FIELD ON/OFF and then press I/⏻ (power).

All sound field settings will be cleared and set to sound field off.

(continued)

Adjusting the delay time (PRO LOGIC sound field only)

You can make the surround sound more effective by delaying the output from the rear speakers (delay time). You can select from three delay times, S (15 mS), M (20 mS), and L (30 mS). For example, if you've placed the rear speakers in a large room or apart from your listening position, set the delay time shorter.

- 1 Start playing a program source encoded with Dolby Surround sound.
- 2 Press SUR.
The current delay time appears in the display.
- 3 Press +/- to select the level you prefer, such as "DELAY S", "DELAY M" or "DELAY L".

Adjustable parameters for each sound field when selecting program source

Sound field mode	Type	MODE	Parameters				Test tone output		
			DELAY	EFFECT	REAR	CENTER		SUB WOOFER	
Off	—	—					●	No sound	
On	CINEMA	PRO LOGIC	●		● ^{a)}	● ^{b)}		●	Depends on center mode (see page 16)
		C. STUDIO		●	● ^{a)}	● ^{b)}		●	
	VIRTUAL	DOLBY V		●				●	No sound
	MUSIC	HALL		●	●			●	From the front and the rear speakers alternately

Adjustable parameters for each sound field when using 5.1 CH/DVD

Sound field mode	Type	MODE	Parameters				Test tone output	
			DELAY	EFFECT	REAR	CENTER		SUB WOOFER
Off	—	—			●	●	●	In the following order: front (L), center, front (R), rear (R) and rear (L)
On	CINEMA	C. STUDIO		●	●	●	●	In the following order: front (L), center and front (R)
	VIRTUAL	V SURR		●		●	●	

a) Adjustable only when the center mode is set to PHANTOM, NORMAL or WIDE (see page 16).

b) Adjustable only when the center mode is set to 3 STEREO, NORMAL or WIDE (see page 16).

Note

To adjust the speaker volume using a test tone as described on page 17, select the PRO LOGIC sound field. The test tone output in all other sound fields is used for verifying whether there is output from speakers or not.

Troubleshooting

If you experience any of the following difficulties while using the receiver, use this troubleshooting guide to help you remedy the problem. Should any problem persist, consult your nearest Sony dealer.

There's no sound or only a very low-level sound is heard.

- ➔ Check that the speakers and components are connected securely.
- ➔ Make sure you select the correct component on the receiver.
- ➔ Make sure you set the SPEAKERS button to ON.
- ➔ Press MUTING if the MUTING indicator turns on.
- ➔ The protective device on the receiver has been activated because of a short circuit ("PROTECT" flashes). Turn off the receiver, eliminate the short-circuit problem and turn on the power again.

The left and right sounds are unbalanced or reversed.

- ➔ Check that the speakers and components are connected correctly and securely.
- ➔ Adjust the balance (see page 10).

Severe hum or noise is heard.

- ➔ Check that the speakers and components are connected securely.
- ➔ Check that the connecting cords are away from a transformer or motor, and at least 10 feet (3 meters) away from a TV set or fluorescent light.
- ➔ Place your TV away from the audio components.
- ➔ Make sure you connect a ground wire to the antenna ground terminal.
- ➔ The plugs and jacks are dirty. Wipe them with a cloth slightly moistened with alcohol.

No sound is heard from the center speaker.

- ➔ Select the appropriate center mode (see page 16).
- ➔ Adjust the speaker volume appropriately (see page 17).

No sound or only a very low-level sound is heard from the rear speakers.

- ➔ Select the appropriate center mode (see page 16).
- ➔ Adjust the speaker volume appropriately (see page 17).
- ➔ Make sure you turn on the sound field surround mode function.

Radio stations cannot be tuned in.

- ➔ Check that the antennas are connected securely. Adjust the antennas and connect an outdoor antenna if necessary.
- ➔ The signal strength of the stations is too weak (when you tune in with automatic tuning). Use direct tuning.
- ➔ Make sure you set the tuning interval correctly (when you tune in AM stations with automatic tuning) (see pages 11 and 20).
- ➔ No stations have been preset or the preset stations have been cleared (when you tune in with scanning preset stations). Preset the stations (see page 12).

Surround effect cannot be obtained.

- ➔ Make sure you turn on the sound field function.
- ➔ Make sure that the SPEAKERS button is depressed.

No picture or an unclear picture is seen on the TV screen.

- ➔ Select the appropriate function on the receiver.
- ➔ Place your TV away from the audio components.

Recording cannot be made.

- ➔ Check that the components are connected correctly.
- ➔ You cannot record audio from a program source connected to 5.1 CH/DVD jacks.

The remote does not function.

- ➔ Point the remote at the remote sensor  on the receiver.
- ➔ Remove the obstacles in the path of the remote and the receiver.
- ➔ Replace both batteries in the remote with new ones if they are weak.
- ➔ Make sure you select the correct function on the remote.

Specifications

Audio power specifications

POWER OUTPUT AND TOTAL HARMONIC DISTORTION

With 8-ohm load, both channels driven, from 20 - 20,000 Hz, rated 100 watts per channel minimum RMS power, with no more than 0.09 % total harmonic distortion from 250 milliwatts to rated output.

Amplifier section

Rated Power Output at Stereo Mode (8 ohms at 20 Hz - 20 kHz, THD 0.09%)
100 W + 100 W

Reference Power Output (8 ohms at 1 kHz, THD 0.7%)
Front: 100 W + 100 W
Center: 100 W
Rear: 100 W + 100 W

Frequency response TV/SAT, CD, MD/TAPE, VIDEO, 5.1 CH/DVD:
10 Hz - 50 kHz $^{+0.5}_{-2}$ dB

Inputs

	Sensitivity	Impedance	S/N
CD, 5.1 CH/DVD, MD/TAPE, TV/SAT, VIDEO	150 mV	50 kilohms	85 dB

Outputs

MD/TAPE REC OUT:
Voltage: 150 mV,
Impedance: 10 kilohms
VIDEO AUDIO OUT:
Voltage: 150 mV,
Impedance: 10 kilohms
SUB WOOFER:
Voltage: 2 V
Impedance: 1 kilohms
PHONES: Accepts low and high impedance headphones

Muting

Full mute

BASS BOOST

+6 dB at 70 Hz

TONE

±6 dB at 100 Hz and 10 kHz

Tuner section

FM stereo, FM/AM superheterodyne tuner

FM tuner section

Tuning range 87.5 - 108.0 MHz

Antenna terminals 75 ohms, unbalanced

Intermediate frequency 10.7 MHz

Sensitivity Mono: 18.3 dBf, 4.5 μ V
Stereo: 38.3 dBf, 45 μ V

Usable sensitivity 11.2 dBf, 2 μ V (IHF)

S/N Mono: 76 dB
Stereo: 70 dB

Harmonic distortion at 1 kHz Mono: 0.3 %
Stereo: 0.5 %

Separation 45 dB at 1 kHz

Frequency response 30 Hz - 15 kHz $^{+0.5}_{-2}$ dB

Selectivity 60 dB at 400 kHz

AM tuner section

Tuning range 10 kHz interval*
530 - 1710 kHz
9 kHz interval
531 - 1710 kHz

Antenna Loop antenna

Intermediate frequency 450 kHz

Usable sensitivity 50 dB/m (at 1,000 kHz or 999 kHz)

S/N 54 dB (at 50 mV/m)

Harmonic distortion 0.5 % (50 mV/m, 400 Hz)

Selectivity At 9 kHz: 35 dB
At 10 kHz: 40 dB

- * You can change the AM tuning interval between 9 kHz and 10 kHz. Turn off the receiver and press I/⏻ (power) for more than 4 seconds until "INITIAL" appears.
- 1) After tuning in any AM station, turn off the receiver.
 - 2) Hold down PRESET TUNING + button and press the I/⏻ (power) button. "9k STEP" appears.

To change to 10k Step, repeat step 1 and 2 until "10k STEP" appears. Note that all preset stations, index names and sound field are cleared after you make the procedure above.

Video section

Inputs VIDEO, TV/SAT, 5.1 CH/DVD:
1 Vp-p 75 ohms

Outputs VIDEO, MONITOR:
1 Vp-p 75 ohms

General

System Tuner section: PLL quartz-locked digital synthesizer system
Pre-amplifier section: Low-noise NF type equalizer
Power amplifier section: Pure-complementary SEPP

Power requirements 120 V AC, 60 Hz

Power consumption 235 W

Dimensions 17 x 5 $^{9}/_{8}$ x 12 inches
(430 x 145 x 304 mm)

Mass (Approx.) 7.3 kg (16 lb 2 oz)

Supplied accessories See page 4

Design and specifications are subject to change without notice.

Glossary

Center mode

Setting of speakers to enhance Dolby Pro Logic Surround mode. To obtain the best possible surround sound, select one of the following four center modes according to your speaker system.

- **NORMAL mode**

Select NORMAL mode if you have front and rear speakers and a small center speaker. Since a small speaker cannot produce enough bass, the bass sound of the center channel is output from the front speakers.

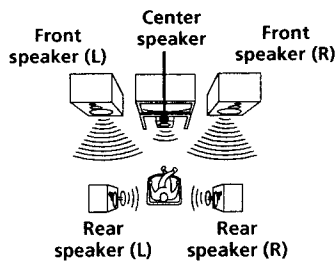

- **WIDE mode**

Select WIDE mode if you have front and rear speakers and a large center speaker. With the WIDE mode, you can take full advantage of Dolby Surround sound.

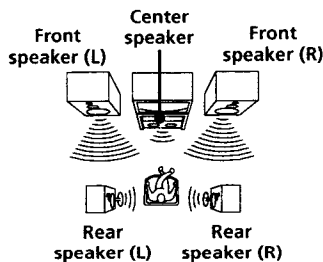

- **PHANTOM mode**

Select PHANTOM mode if you have front and rear speakers but no center speaker. The sound of the center channel is output from the front speakers.

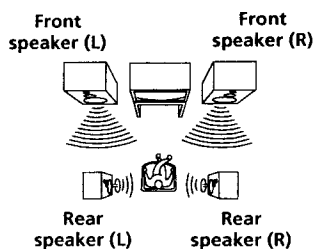

- **3 STEREO mode**

Select 3 STEREO mode if you have front and center speakers but no rear speaker. The sound of the rear channel is output from the front speakers to let you experience some of the surround sound without using rear speakers.

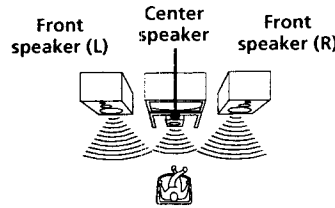

Delay time

Time lag between the surround sound output from front speakers and rear speakers. By adjusting the delay time of the rear speakers, you can obtain the feeling of presence. Make the delay time longer when you have placed the rear speakers in a small room or close to your listening position, and make it shorter when you have placed them in a large room or apart from your listening position.

Direct tuning

Tuning method to let you directly enter a station's frequency using the numeric buttons on the remote. Use this method if you know the frequency of the station you want.

Dolby Pro Logic Surround

As one method of decoding Dolby Surround, Dolby Pro Logic Surround produces four channels from two channel sound. Compared with the former Dolby Surround system, Dolby Pro Logic Surround reproduces left-to-right panning more naturally and localizes sounds more precisely. To take full advantage of Dolby Pro Logic Surround, you should have one pair of rear speakers and a center speaker. The rear speakers output monaural sound.

5.1 CH/DVD

These jacks are used to input decoded Dolby Digital (AC-3) audio signals, allowing you to enjoy 5.1 channel surround sound. Use these jacks to connect a Dolby Digital (AC-3) decoder or a DVD player with a built-in AC-3 decoder.

Preset station

A radio broadcasting station that is stored in memory of the receiver. Once you "preset" stations, you no longer have to tune in the stations. Each preset station is assigned its own preset number, which lets you tune them in quickly.

Surround sound

Sound that consists of three elements: direct sound, early reflected sound (early reflections) and reverberative sound (reverberation). The acoustics where you hear the sound affect the way these three sound elements are heard. These sound elements are combined in such a way that you can actually feel the size and the type of a concert hall.

- **Types of sound**

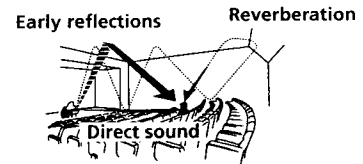

- **Transition of sound from rear speakers**

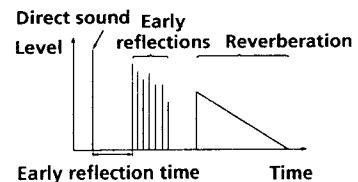

Test tone

Signal given out by the receiver for adjusting the speaker volume. The test tone will come out as follows:

- **In a system with a center speaker (NORMAL/WIDE/3 STEREO modes)**

The test tone is output from the front L (left), center, front R (right), and rear speakers in succession.

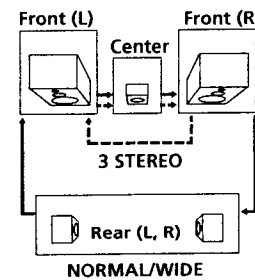

- **In a system without a center speaker (PHANTOM mode)**

The test tone is output from the front and the rear speakers alternately.

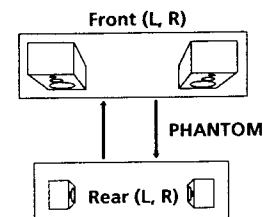

A, B

- Adjusting
 - delay time 18, 21
 - effect level 15
 - speaker volume 17
 - tone 10
 - volume 10
- Antenna hookups 5
- Audio component hookups 5
- Automatic tuning 11

C

- Center mode 16, 21
 - NORMAL mode 16, 21
 - PHANTOM mode 16, 21
 - 3 STEREO mode 16, 21
 - WIDE mode 16, 21
- Connecting. *See* Hookups

D

- Delay time 18, 21
- Direct tuning 11, 21
- Dolby Pro Logic
 - Surround 16, 21
 - center mode 16, 21
- Dubbing. *See* Recording

E, F, G

- Editing. *See* Recording
- Effect level 15

H, I, J, K, L, M

- Hookups
 - AC power cord 9
 - antennas 5
 - audio components 5
 - overview 4
 - speakers 7
 - video component 6

N, O

- Naming preset station 13
- NORMAL mode 16, 21

P

- PHANTOM mode 16, 21
- Preset station 12, 21
- Presetting
 - radio stations 12
- Preset tuning 12
- Program source
 - selecting 10

Q

- Quick reference guide 24

R

- Rear panel 5, 6, 7, 9, 23
- Receiving broadcasts
 - directly 11
 - using preset stations 12
- Recording
 - on a MiniDisc 13
 - on a tape 13
 - on a video tape 14

S

- Scanning
 - preset stations 12
 - radio stations 11
- Selecting a program source 10
- Sleep Timer 14
- Speakers
 - connection 8
 - placement 7
 - volume 17
- Storing radio stations. *See* Presetting
- Surround sound 16, 21

T

- Test tone 17, 21
- 3 STEREO mode 16, 21
- Troubleshooting 19
- Tuning. *See* Receiving broadcasts

U

- Unpacking 4

V

- Video component hookups 6

W, X, Y, Z

- Watching/listening to video programs 10
- WIDE mode 16, 21

Rear Panel Descriptions

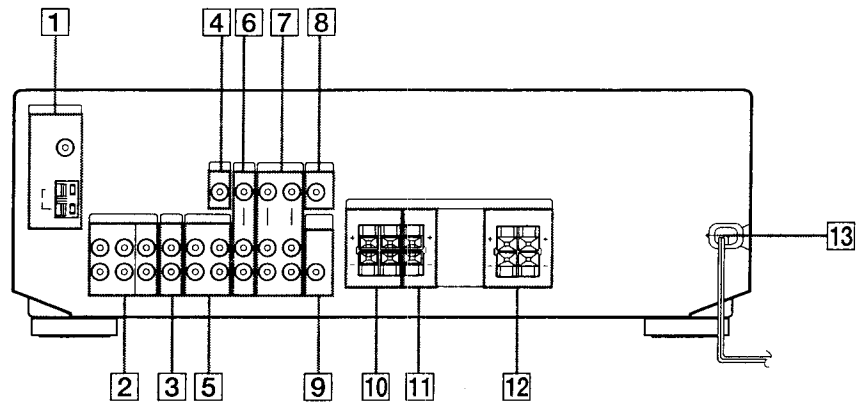

- 1 ANTENNA (AM/FM)
- 2 5.1 CH/DVD
- 3 CD
- 4 5.1 CH (VIDEO IN)
- 5 MD/TAPE

- 6 TV/SAT
- 7 VIDEO
- 8 MONITOR
- 9 SUB WOOFER
- 10 SPEAKERS REAR

- 11 SPEAKERS CENTER
- 12 SPEAKERS FRONT
- 13 AC power cord

Receiving Broadcasts (direct tuning)

Example: Receiving FM
102.50 MHz

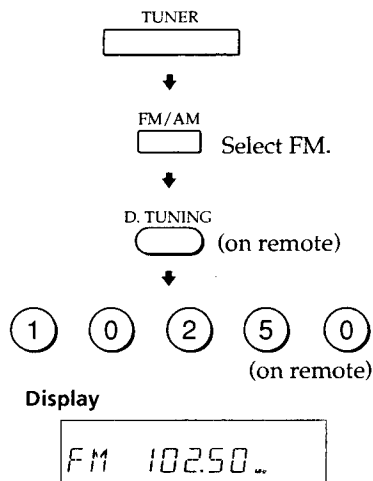

Presetting Radio Stations

Example: Presetting a station as A7

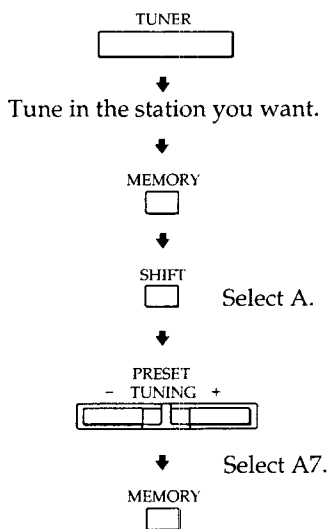

Selecting a Component

Example 1: Playing a CD

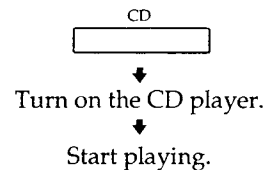

Example 2: Watching a video tape

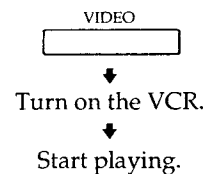

Scanning Radio Stations (automatic tuning)

Example: Scanning FM stations

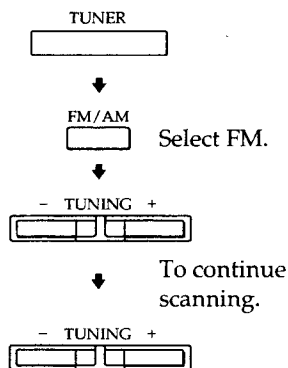

Receiving Preset Stations

Example: Receiving the station number A7

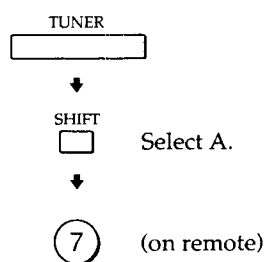

Using Pre-programmed Sound Fields

Example: Watching the video tape of a Dolby Surround-encoded movie

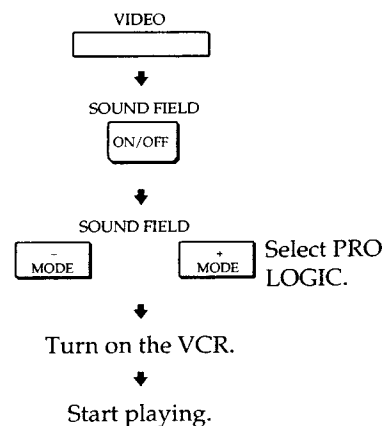

Scanning Preset Stations

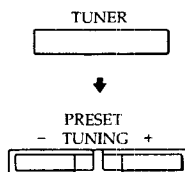

Free Manuals Download Website

<http://myh66.com>

<http://usermanuals.us>

<http://www.somanuals.com>

<http://www.4manuals.cc>

<http://www.manual-lib.com>

<http://www.404manual.com>

<http://www.luxmanual.com>

<http://aubethermostatmanual.com>

Golf course search by state

<http://golfingnear.com>

Email search by domain

<http://emailbydomain.com>

Auto manuals search

<http://auto.somanuals.com>

TV manuals search

<http://tv.somanuals.com>