

Multi Channel AV Receiver

Operating Instructions

WARNING

To reduce the risk of fire or electric shock, do not expose this apparatus to rain or moisture.

To reduce the risk of fire, do not cover the ventilation opening of the apparatus with newspapers, tablecloths, curtains, etc.

Do not place the naked flame sources such as lighted candles on the apparatus.

To reduce the risk of fire or electric shock, do not expose this apparatus to dripping or splashing, and do not place objects filled with liquids, such as vases, on the apparatus.

Do not install the appliance in a confined space, such as a bookcase or built-in cabinet.

As the main plug is used to disconnect the unit from the mains, connect the unit to an easily accessible AC outlet. Should you notice an abnormality in the unit, disconnect the main plug from the AC outlet immediately.

Do not expose batteries or apparatus with battery-installed to excessive heat such as sunshine, fire or the like.

The unit is not disconnected from the mains as long as it is connected to the AC outlet, even if the unit itself has been turned off.

Excessive sound pressure from earphones and headphones can cause hearing loss.



This symbol is intended to alert the user to the presence of the Hot Surface that may be hot if it is touched during the normal operation.

For customers in the United States

Owner's Record

The model and serial numbers are located on the rear of the unit. Record these numbers in the space provided below. Refer to them whenever you call upon your Sony dealer regarding this product.

Model No. _____

Serial No. _____



This symbol is intended to alert the user to the presence of uninsulated "dangerous voltage" within the product's enclosure that may be of sufficient magnitude to constitute a risk of electric shock to persons.



This symbol is intended to alert the user to the presence of important operating and maintenance (servicing) instructions in the literature accompanying the appliance.

Important Safety Instructions

- 1) Read these instructions.
- 2) Keep these instructions.
- 3) Heed all warnings.
- 4) Follow all instructions.
- 5) Do not use this apparatus near water.
- 6) Clean only with dry cloth.
- 7) Do not block any ventilation openings. Install in accordance with the manufacturer's instructions.
- 8) Do not install near any heat sources such as radiators, heat registers, stoves, or other apparatus (including amplifiers) that produce heat.
- 9) Do not defeat the safety purpose of the polarized or grounding-type plug. A polarized plug has two blades with one wider than the other. A grounding type plug has two blades and a third grounding prong. The wide blade or the third prong are provided for your safety. If the provided plug does not fit into your outlet, consult an electrician for replacement of the obsolete outlet.
- 10) Protect the power cord from being walked on or pinched particularly at plugs, convenience receptacles, and the point where they exit from the apparatus.
- 11) Only use attachments/accessories specified by the manufacturer.

- 12) Use only with the cart, stand, tripod, bracket, or table specified by the manufacturer, or sold with the apparatus. When a cart is used, use caution when moving the cart/apparatus combination to avoid injury from tip-over.



- 13) Unplug this apparatus during lightning storms or when unused for long periods of time.
- 14) Refer all servicing to qualified service personnel. Servicing is required when the apparatus has been damaged in any way, such as power-supply cord or plug is damaged, liquid has been spilled or objects have fallen into the apparatus, the apparatus has been exposed to rain or moisture, does not operate normally, or has been dropped.

The following FCC statement applies only to the version of this model manufactured for sale in the U.S.A. Other versions may not comply with FCC technical regulations.

NOTE:

This equipment has been tested and found to comply with the limits for a Class B digital device, pursuant to Part 15 of the FCC Rules. These limits are designed to provide reasonable protection against harmful interference in a residential installation. This equipment generates, uses and can radiate radio frequency energy and, if not installed and used in accordance with the instructions, may cause harmful interference to radio communications. However, there is no guarantee that interference will not occur in a particular installation. If this equipment does cause harmful interference to radio or television reception, which can be determined by turning the equipment off and on, the user is encouraged to try to correct the interference by one or more of the following measures:

- Reorient or relocate the receiving antenna.
- Increase the separation between the equipment and receiver.
- Connect the equipment into an outlet on a circuit different from that to which the receiver is connected.
- Consult the dealer or an experienced radio/TV technician for help.

CAUTION

You are cautioned that any changes or modifications not expressly approved in this manual could void your authority to operate this equipment.

To reduce the risk of electric shock, the speaker cord should be connected to the apparatus and the speakers in accordance with the following instructions.

- 1) Disconnect the AC power cord from the MAINS.
- 2) Strip 10 to 15 mm of the wire insulation of the speaker cord.
- 3) Connect the speaker cord to the apparatus and the speakers carefully so as not to touch the core of speaker cord by hand. Also disconnect the AC power cord from the MAINS before disconnecting the speaker cord from the apparatus and the speakers.

For customers in Europe



Disposal of Old Electrical & Electronic Equipment (Applicable in the European Union and other European countries with separate collection systems)

This symbol on the product or on its packaging indicates that this product shall not be treated as household waste. Instead it shall be handed over to the applicable collection point for the recycling of electrical and electronic equipment. By ensuring this product is disposed of correctly, you will help prevent potential negative consequences for the environment and human health, which could otherwise be caused by inappropriate waste handling of this product. The recycling of materials will help to conserve natural resources. For more detailed information about recycling of this product, please contact your local Civic Office, your household waste disposal service or the shop where you purchased the product.



Disposal of waste batteries (applicable in the European Union and other European countries with separate collection systems)

This symbol on the battery or on the packaging indicates that the battery provided with this product shall not be treated as household waste.

On certain batteries this symbol might be used in combination with a chemical symbol. The chemical symbols for mercury (Hg) or lead (Pb) are added if the battery contains more than 0.0005% mercury or 0.004% lead.

By ensuring these batteries are disposed of correctly, you will help prevent potentially negative consequences for the environment and human health which could otherwise be caused by inappropriate waste handling of the battery. The recycling of the materials will help to conserve natural resources.

In case of products that for safety, performance or data integrity reasons require a permanent connection with an incorporated battery, this battery should be replaced by qualified service staff only. To ensure that the battery will be treated properly, hand over the product at end-of-life to the applicable collection point for the recycling of electrical and electronic equipment.

For all other batteries, please view the section on how to remove the battery from the product safely. Hand the battery over to the applicable collection point for the recycling of waste batteries.

For more detailed information about recycling of this product or battery, please contact your local Civic Office, your household waste disposal service or the shop where you purchased the product.

Notice for customers: The following information is only applicable to equipment sold in countries applying EU Directives.

The manufacturer of this product is Sony Corporation, 1-7-1 Konan Minato-ku Tokyo, 108-0075 Japan. The Authorized Representative for EMC and product safety is Sony Deutschland GmbH, Hedelfinger Strasse 61, 70327 Stuttgart, Germany. For any service or guarantee matters please refer to the addresses given in separate service or guarantee documents.

For customers in Australia



Disposal of Old Electrical & Electronic Equipment (Applicable in the European Union and other European countries with separate collection systems)

About This Manual

- The instructions in this manual are for models STR-DH730 and STR-DH830. The model number is located at the lower right corner of the front panel. The illustrations used in this manual are of the USA model and they may be different from your model. Any differences in operation are marked in the manual as “Europe model only”.
- The instructions in this manual describe the operation of the receiver with the supplied remote control. You can also use the buttons or knobs on the receiver if they have the same or similar names as those on the remote control.

On copyrights

This receiver incorporates Dolby* Digital and Pro Logic Surround and the DTS** Digital Surround System.

* Manufactured under license from Dolby Laboratories. Dolby, Pro Logic, and the double-D symbol are trademarks of Dolby Laboratories.

** Manufactured under license under U.S. Patent Nos: 5,956,674; 5,974,380; 6,226,616; 6,487,535; 7,212,872; 7,333,929; 7,392,195; 7,272,567 & other U.S. and worldwide patents issued & pending. DTS-HD, the Symbol, & DTS-HD and the Symbol together are registered trademarks & DTS-HD Master Audio is a trademark of DTS, Inc. Product includes software. © DTS, Inc. All Rights Reserved.

This receiver incorporates High-Definition Multimedia Interface (HDMI™) technology. HDMI, the HDMI Logo, and High-Definition Multimedia Interface are trademarks or registered trademarks of HDMI Licensing LLC in the United States and other countries.

“x.v.Color (x.v.Colour)” and “x.v.Color (x.v.Colour)” logo are trademarks of Sony Corporation.

“BRAVIA” is a trademark of Sony Corporation.

“PlayStation” is a registered trademark of Sony Computer Entertainment Inc.

The font type (Shin Go R) installed in this receiver is provided by MORISAWA & COMPANY LTD. These names are the trademarks of MORISAWA & COMPANY LTD., and the copyright of the font also belongs to MORISAWA & COMPANY LTD.

iPhone, iPod, iPod classic, iPod nano, and iPod touch are trademarks of Apple Inc., registered in the U.S. and other countries.

All other trademarks and registered trademarks are of their respective holders. In this manual, ™ and ® marks are not specified.



“Made for iPod” and “Made for iPhone” mean that an electronic accessory has been designed to connect specifically to iPod or iPhone, respectively, and has been certified by the developer to meet Apple performance standards.

Apple is not responsible for the operation of this device or its compliance with safety and regulatory standards. Please note that the use of this accessory with iPod or iPhone may affect wireless performance.

MPEG Layer-3 audio coding technology and patents licensed from Fraunhofer IIS and Thomson.

“WALKMAN” is a registered trademark of Sony Corporation.

MICROVAULT is a trademark of Sony Corporation.

Windows Media is either a registered trademark or trademark of Microsoft Corporation in the United States and/or other countries.

This product contains technology subject to certain intellectual property rights of Microsoft. Use or distribution of this technology outside of this product is prohibited without the appropriate license(s) from Microsoft.

Table of Contents

About This Manual.....	4
Supplied accessories.....	7
Description and location of parts.....	9
Getting started	17

Connections

1: Installing the speakers	18
2: Connecting the speakers.....	20
3: Connecting the TV	22
4a: Connecting the video equipment.....	23
4b: Connecting the audio equipment.....	30
5: Connecting the antennas (aerials).....	31
6: Connecting the AC power cord (mains lead)	31

Preparing the Receiver

Initializing the receiver.....	32
Setting the speakers	32
Using AUTO CALIBRATION.....	33
Guide to on-screen display operation	38

Basic Operations

Playing an input source equipment.....	40
Playing an iPod/iPhone.....	42
Playing a USB device	45
Recording using the receiver	47

Tuner Operations

Listening to FM/AM radio	48
Presetting FM/AM radio stations (Preset Tuning)	49
Receiving RDS broadcasts	50
(Europe, Australia and Taiwan models only)	

Enjoying Sound Effects

Selecting the sound field.....	51
Using Advanced Auto Volume function.....	55
Resetting sound fields to the default settings	55

“BRAVIA” Sync Features

What is “BRAVIA” Sync?.....	56
Preparing for the “BRAVIA” Sync.....	56
Playing back equipment with one-touch operation (One-Touch Play).....	57
Enjoying the TV sound from the speakers connected to the receiver (System Audio Control).....	58
Turning off the receiver with the TV (System Power-Off)	58
Enjoying optimum sound field for the selected scene (Scene Select).....	59

Other Operations

Switching between digital and analog audio (INPUT MODE)	59
Using the sound/images from other inputs (Input Assign)	60

Adjusting Settings

Using the Settings menu	62
Speaker Settings menu.....	63
Surround Settings menu.....	65
EQ Settings menu	66
Audio Settings menu.....	66
HDMI Settings menu	67
System Settings menu.....	67
Operating without connecting to a TV	68

Using the Remote Control

Reassigning the input button.....	72
Resetting the input buttons.....	73

Additional Information

Precautions	74
Troubleshooting	75
Specifications	82
Index.....	84

Supplied accessories

- Operating Instructions (this manual)
- Quick Setup Guide (1)
- GUI Menu List (1)
- FM wire antenna (aerial) (1)



- AM loop antenna (aerial) (1)



- Remote control (1)
 - RM-AAU106 (USA, Canada and Mexico models only)
 - RM-AAU107 (Other models)

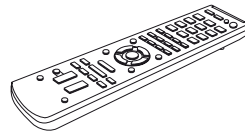

- R6 (size AA) batteries (2)



- Optimizer microphone (ECM-AC2) (1)



Inserting batteries into the remote control

Insert two R6 (size AA) batteries (supplied) by matching \oplus and \ominus on the batteries to the diagram inside the battery compartment of the remote control.

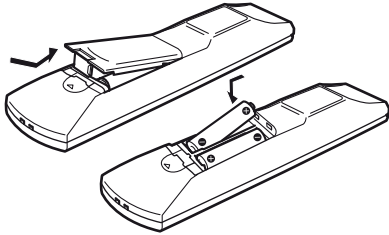

Notes

- Do not leave the remote control in an extremely hot or humid place.
- Do not use a new battery with old ones.
- Do not mix manganese batteries and other kinds of batteries.
- Do not expose the remote control sensor to direct sunlight or lighting apparatuses. Doing so may cause a malfunction.
- If you do not intend to use the remote control for an extended period of time, remove the batteries to avoid possible damage from battery leakage and corrosion.
- When you replace the batteries, the remote control buttons may be reset to their default settings. If this happens, reassign the input buttons (page 72).
- When the receiver no longer responds to the remote control, replace all the batteries with new ones.

Description and location of parts

Front panel

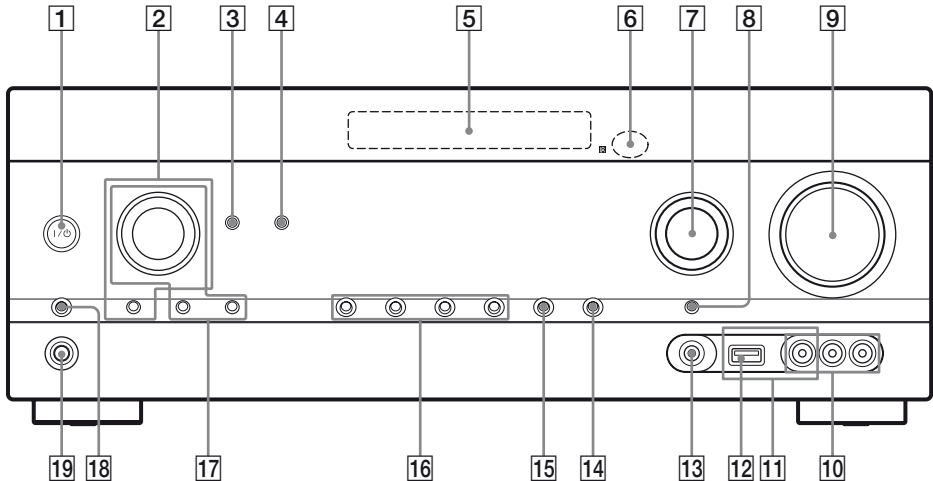

1 I/⏻ (on/standby) (page 32, 49, 55)

2 TONE, TONE MODE (page 66)

Press TONE MODE repeatedly to select BASS or TREBLE, then turn TONE to adjust the level.

3 NIGHT MODE

Allows you to retain a theater like environment at low volume levels.

When watching a movie late at night, you will be able to hear the dialog clearly even at a low volume level. This function can be used with other sound fields.

Press the button again to turn off this function.

Note

This function does not work when "A. DIRECT" is selected.

Tips

- You can also set the Night Mode function "ON" and "OFF" by using Night Mode in Audio Settings menu.
- While the NIGHT MODE is turned on, the bass, treble, and effect levels increase, and "D. RANGE" is automatically set to "COMP. MAX".

4 AUTO VOL (page 55)

5 Display panel (page 10)

6 Remote control sensor

Receives signals from remote control.

7 INPUT SELECTOR (page 41, 47, 59)

8 INPUT MODE (page 59)

9 MASTER VOLUME (page 40)

10 VIDEO 2 IN jacks (page 28)

11 iPod/iPhone terminals (page 27)

Connects the ⚡ (USB) port and the video jack to output audio/video from iPod/iPhone.

12 ⚡ (USB) port (page 30)

13 AUTO CAL MIC jack (page 34)

14 DISPLAY (page 72)

15 DIMMER

Adjusts the brightness of the display panel in 3 levels.

16 2CH/A.DIRECT, A.F.D., MOVIE (HD-D.C.S.), MUSIC (page 51, 53)

17 TUNING MODE, MEMORY/ENTER, TUNING

Press to operate a tuner (FM/AM). Turn TUNING to scan a station.

18 SPEAKERS (page 21)

19 PHONES jack (page 76)

Indicators on the display panel

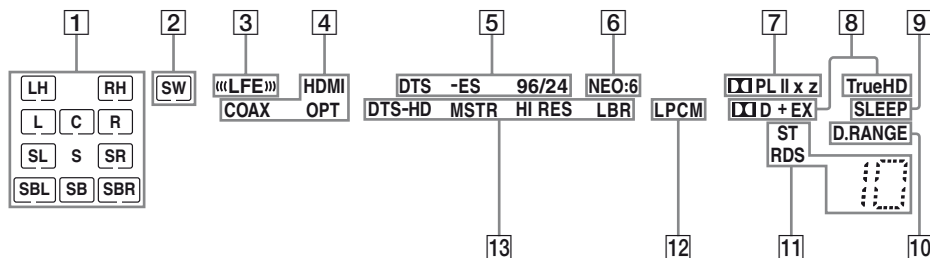

1 Playback channel indicators

The letters (L, C, R, etc.) indicate the channels being played back. Based on the speaker settings, the box around the letter(s) vary to show how the receiver downmixes the source sound.

LH	Front Left High
RH	Front Right High
L	Front Left
R	Front Right
C	Center (monaural)
SL	Surround Left
SR	Surround Right
S	Surround (monaural or the surround equipment obtained by Pro Logic processing)
SBL	Surround Back Left
SBR	Surround Back Right
SB	Surround Back (the surround back equipment obtained by 6.1 channel decoding)

Example:

Speaker pattern: 3/0.1
Recording format: 3/2.1
Sound Field: A.F.D. AUTO



2 SW

Lights up when the audio signal is output from the SUBWOOFER jack.

3 «LFE»

Lights up when the disc being played back contains an LFE (Low Frequency Effect) channel and the LFE channel signal is actually being reproduced.

4 Input indicator

Lights up to indicate the current input.

HDMI

- The INPUT MODE is set to "AUTO", and when the receiver recognizes the equipment connected via an HDMI IN jack (page 23, 59).
- TV input detected Audio Return Channel (ARC) signals.

COAX

The INPUT MODE is set to "AUTO" or "COAX", and when the source signal is a digital signal through the COAXIAL jack (page 25, 59).

OPT

The INPUT MODE is set to "AUTO" or "OPT", and when the source signal is a digital signal through the OPTICAL jack (page 22, 25, 26, 59).

5 DTS(-ES) indicator

Lights up the respective indicator when the receiver is decoding the corresponding DTS format signals.

DTS	DTS
DTS-ES	DTS-ES
DTS 96/24	DTS 96 kHz/24 bit

Note

When playing a DTS format disc, make sure that you have completed the digital connections and that INPUT MODE is not set to "ANALOG" (page 59) or "A. DIRECT" is not selected.

6 NEO:6

Lights up when DTS Neo:6 Cinema/Music decoder is activated (page 52, 53).

7 **Dolby Pro Logic indicator**

Lights up the respective indicator when the receiver performs Dolby Pro Logic processing. This matrix surround decoding technology can enhance input signals.

<input type="checkbox"/> PL	Dolby Pro Logic
<input type="checkbox"/> PL II	Dolby Pro Logic II
<input type="checkbox"/> PL IIx	Dolby Pro Logic IIx
<input type="checkbox"/> PL IIz	Dolby Pro Logic IIz

Note

These indicators may not light up depending on the speaker pattern setting.

8 **Dolby Digital Surround indicator**

Lights up the respective indicator when the receiver is decoding the corresponding Dolby Digital format signals.

<input type="checkbox"/> D	Dolby Digital
<input type="checkbox"/> D EX	Dolby Digital Surround EX
<input type="checkbox"/> D+	Dolby Digital Plus
<input type="checkbox"/> TrueHD	Dolby TrueHD

Note

When playing a Dolby Digital format disc, make sure that you have completed the digital connections and that INPUT MODE is not set to "ANALOG" (page 59) or "A. DIRECT" is not selected.

9 **SLEEP**

Lights up when the Sleep Timer is activated (page 14).

10 **D.RANGE**

Lights up when dynamic range compression is activated (page 65).

11 **Tuning indicators**

Lights up when the receiver tunes to a radio station.

ST

Stereo broadcast

RDS (Europe, Australia and Taiwan models only)

Tuned to a station with RDS services.



Preset station number (The number will change according to the preset station you select.)

12 **LPCM**

Lights up when the receiver is decoding the Linear PCM signals.

13 **DTS-HD indicator**

Lights up the respective indicator when the receiver is decoding the corresponding DTS-HD format signals.

DTS-HD MSTR	DTS-HD Master Audio
DTS-HD HI RES	DTS-HD High Resolution Audio
DTS-HD LBR	DTS-HD Low Bit Rate Audio

Rear panel

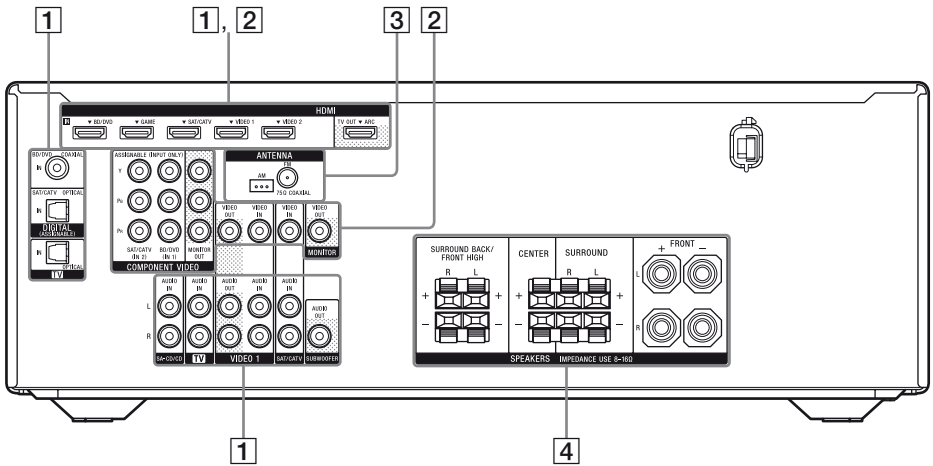

1 Audio signal section

DIGITAL INPUT/OUTPUT jacks (page 22, 25, 26, 27, 28)



HDMI IN/OUT



OPTICAL IN



COAXIAL IN

ANALOG INPUT/OUTPUT jacks (page 20, 22, 25, 26, 28, 30)



White (L)

AUDIO IN/OUT



Red (R)



Black

AUDIO OUT

2 Video signal section*

The image quality depends on the connecting jack.

DIGITAL INPUT/OUTPUT jacks (page 22, 25, 26, 27, 28)



HDMI IN/OUT

COMPONENT VIDEO INPUT/OUTPUT jacks (page 22, 25, 26)



Green (Y)



Blue (P_B)

Y, P_B, P_R IN/OUT



Red (P_R)

COMPOSITE VIDEO INPUT/OUTPUT jacks (page 22, 26, 28)



Yellow

VIDEO IN/OUT

3 ANTENNA section



FM ANTENNA jack (page 31)



AM ANTENNA terminals (page 31)

High quality image

4 SPEAKERS section (page 20)

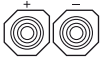

* You must connect the HDMI TV OUT or MONITOR OUT jack to your TV to watch the selected input image (page 22).

Remote control

Use the supplied remote control to operate this receiver and other equipment. The remote control is assigned to operate Sony audio/video equipment. You can reassign the input button to match the equipment connected to your receiver (page 72).

- **RM-AAU106 (USA, Canada and Mexico models only)**
- **RM-AAU107 (Other models)**

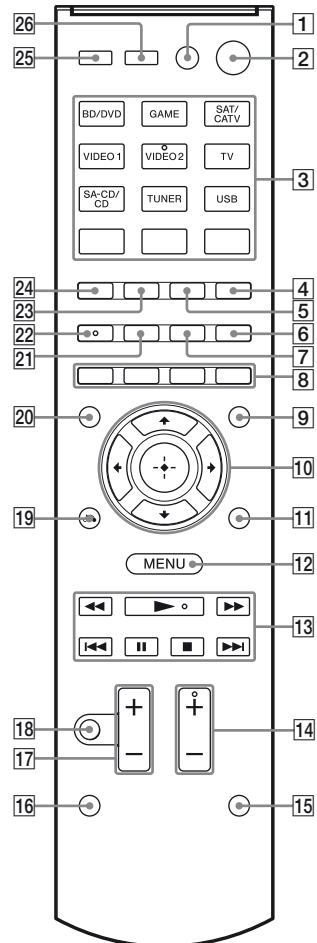

continued

To use the buttons printed in pink

Hold down SHIFT (15), then press the button printed in pink that you want to use.
Example: Hold down SHIFT (15), then press ENT/MEM (3).

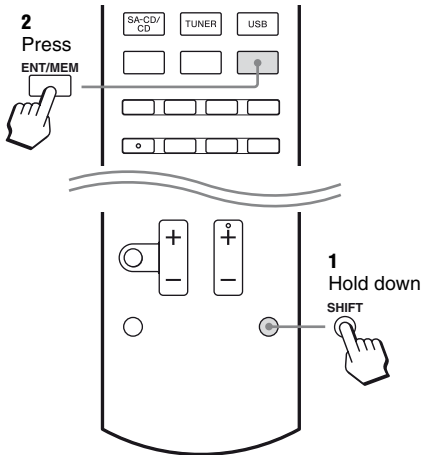

To control the receiver

- 2** **I/⏻*** (on/standby)
Turns the receiver on or sets it to standby mode.
Saving the power in standby mode
When "Ctrl for HDMI" is set to "OFF" (page 67).
- 3** **Input buttons****
Selects the equipment you want to use. When you press any of the input buttons, the receiver turns on. The buttons are assigned to control Sony equipment.
Numeric buttons**
Hold down SHIFT (15), then press numeric buttons to preset or tune to the preset stations.
ENT/MEM
Hold down SHIFT (15), then press ENT/MEM to store a station during tuner operation.
- 5** **INPUT MODE**
Selects the input mode when the same equipment is connected to both digital and analog jacks.
- 6** **DISPLAY**
Views information on the display panel.
- 9** **GUI MODE**
Displays the GUI menu on the TV screen.

- 10** **+**, **↕/↔/↔/↔**
Press **↕/↔/↔/↔** to select the settings, then press **+** to enter/confirm the selection.
- 11** **TOOLS/OPTIONS**
Displays and selects items from the option menus.
- 12** **MENU/HOME**
Press AMP (25), then press MENU/HOME to display the menu to operate the receiver.
- 13** **TUNING +/-**
Scans a station.
PRESET +/-
Selects preset stations.
D.TUNING
Enters direct tuning mode.
- 14** **SOUND FIELD +**/-**
Selects a sound field.
- 15** **SHIFT**
Changes the remote control button function to activate the buttons printed in pink (page 14).
- 17** **MASTER VOL +/- or \triangle +/-**
Adjusts the volume level of all speakers at the same time.
- 18** **MUTING or \times**
Turns off the sound temporarily.
Press MUTING or \times again to restore the sound.
- 19** **RETURN/EXIT \curvearrowright**
Returns to the previous menu.
- 23** **SLEEP**
Sets the receiver to turn off automatically at a specified time.
Each time you press this button, the display changes cyclically as follows:
0-30-00 → 1-00-00 → 1-30-00 → 2-00-00 → OFF
When Sleep Timer is being used, "SLEEP" indicator lights up on the display panel.
- Tip**
To check the remaining time before the receiver turns off, press SLEEP. The remaining time appears on the display panel. If you press SLEEP again, the Sleep Timer will be canceled.

24 AUTO VOL

Activates the advanced auto volume function (page 55).

AUTO CAL

Hold down SHIFT (15), then press AUTO CAL to activate the Auto Calibration function.

Note

This button is not available when the receiver is in "GUI MODE".

25 AMP

Activates the receiver operation.

To control a Sony TV

Hold down TV (16), then press the button printed in yellow to select the function you want.

Example: Hold down TV (16), then press TV CH + or PROG + (14).

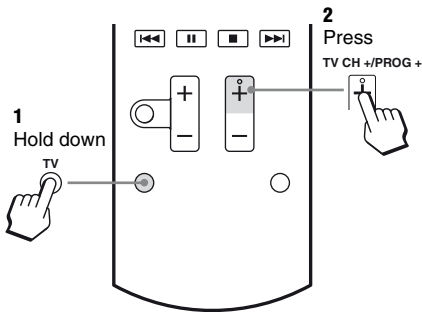

1 TV I/O (on/standby)

Turns the TV on or off.

3 Numeric buttons**

Selects the TV channels.

ENT/MEM

Enters the selections.

CLEAR

Use with the numeric buttons to select the channel numbers of the Digital CATV terminal. For example, to select 2.1, press 2, CLEAR, and 1.

↻ (Previous channel)

Returns to the previous channel watched (for more than five seconds).

☰ (Text)

Displays text information.

6 DISPLAY

Displays information related to the current TV program.

⊕/⊗ (Info/Text reveal)

Displays information such as current channel number and screen mode.

Reveals hidden information (e.g. answers to a quiz) while in the text mode.

8 Color buttons

Displays an operation guide on the TV screen when the color buttons are available. Follow the operation guide to perform a selected operation.

11 TOOLS/OPTIONS

Displays the TV function options.

12 MENU/HOME

Displays the TV menus.

14 TV CH +**/- or PROG +**/-

Scans for the preset TV channels.

⊕**/⊖

Selects the next or previous page while in the text mode.

17 TV VOL +/- or ◁ +/-

Adjusts the TV volume.

18 MUTING or ✖

Activates the TV's muting function.

19 RETURN/EXIT ↶

Returns to the previous TV menu.

20 GUIDE or ≡

Displays the on-screen program guide.

22 AUDIO** or ○○**

Changes the dual sound mode.

26 INPUT or ↵ (Input select)

Selects the input signal (TV or video).

⊕ (Text hold)



Holds the current page while in the text mode.

* If you press AV I/O (1) and I/O (2) simultaneously, the receiver and connected equipment will turn off (SYSTEM STANDBY). The function of the AV I/O (1) changes automatically each time you press the input buttons (3).

**The 5/VIDEO 2, AUDIO/○○, ▶ and TV CH +/SOUND FIELD+/PROG+/⊕ buttons have tactile dots. Use the tactile dots as references when operating the receiver.

To control other Sony equipment

Be sure to hold down SHIFT (15) to activate the buttons printed in pink (page 14).

Name	Blu-ray Disc/ DVD player	Satellite tuner, cable TV tuner	VCR	CD player	USB device, iPod/iPhone
1 AV I/⏻ ^{a)}	Power	Power	Power	Power	–
3 Numeric buttons ^{b)}	Track	Channel	Channel	Track	–
ENT/MEM	Enter	Enter	Enter	Enter	Enter
CLEAR	Clear	(.) dot ^{c)} /Text ^{e)}	–	Track >10	–
4 iPhone CTRL	–	–	–	–	iPod/iPhone control mode
6 DISPLAY	Display	Display	Display	Display	Display
7 POP UP/MENU	Menu	–	–	–	–
8 Color buttons	Menu, guide	Menu, guide	–	–	–
10 +	Enter	Enter	Enter	–	Enter
↕/↔/↔/↔	Select	Select	Select	–	Select
11 TOOLS/OPTIONS	Options menu	Options menu	–	–	Options menu
12 MENU/HOME	Menu	Menu	Menu	–	Menu
13 ◀◀▶▶	Search forward, – backward	–	Fast forward, rewind	Fast forward, rewind	Fast forward, rewind
▶ ^{b)}	Play	–	Play	Play	Play
◀◀▶▶	Skip track	–	Search index	Skip track	Skip track
 	Pause	–	Pause	Pause	Pause
■	Stop	–	Stop	Stop	Stop
FOLDER +/-	–	–	–	–	Select folder
19 RETURN/ EXIT ↵	Return	Return, exit	–	–	Return
20 GUIDE or 	Program schedule	Guide menu	–	–	–
21 TOP MENU	On-screen guide	–	–	–	–
22 AUDIO ^{b)} or  ^{b)}	Audio	–	–	–	–
26 INPUT	Select input	–	Select input	–	–

a) If you press AV I/⏻ (1) and I/⏻ (2) simultaneously, the receiver and connected equipment will turn off (SYSTEM STANDBY). The function of the AV I/⏻ (1) changes automatically each time you press the input buttons (3).

b) The 5/VIDEO 2, AUDIO/⏻, ▶ and TV CH +/SOUND FIELD+/PROG+/ buttons have tactile dots. Use the tactile dots as references when operating the receiver.

c) USA, Canada and Mexico models only.

d) For example, to select 2.1, press 2, CLEAR, and 1.

e) Other models.

Notes

- The above explanation is intended to serve as examples.
- Depending on the model of your connected equipment, some functions explained in this section may not work with the supplied remote control.

Getting started

You can enjoy your audio/video equipment connected to the receiver by following the simple steps below.

Before connecting cords, be sure to disconnect the AC power cord (mains lead).

Installing and connecting the speakers (page 18, 20)



Checking the connection appropriate for your equipment

Connecting the TV and video equipment (page 22, 23)

The image quality depends on the connecting jack. See the illustration below. Select the connection according to the jacks on your equipment.

We recommend that you connect your video equipment via HDMI connection if they have HDMI jacks.

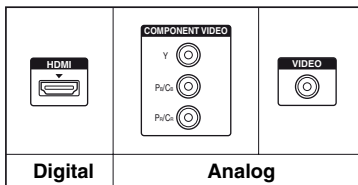

High quality image



Connecting the audio equipment (page 30)



Preparing the receiver

See “6: Connecting the AC power cord (mains lead)” (page 31) and “Initializing the receiver” (page 32).



Setting the speakers

Select the speaker pattern (page 32), then perform Auto Calibration (page 33).

Note

You can check the speaker connection using “Test Tone” (page 64). If the sound is not output correctly, check the speaker connection.



Setting the audio output settings on the connected equipment

To output multi channel digital audio, check the digital audio output setting on the connected equipment.

For a Sony Blu-ray Disc player, check that “Audio (HDMI)”, “Dolby Digital”, and “DTS” are set to “Auto”, “Dolby Digital” and “DTS” respectively (as of September 2011).

For a PlayStation 3, check that “BD/DVD Audio Output Format (HDMI)” and “BD Audio Output Format (Optical Digital)” are set to “Bitstream” (with system software version 3.70).

For details, refer to the operating instructions supplied with the connected equipment.

1: Installing the speakers

This receiver allows you to use up to a 7.1 channel system (7 speakers and one subwoofer).

Example of speaker system configuration

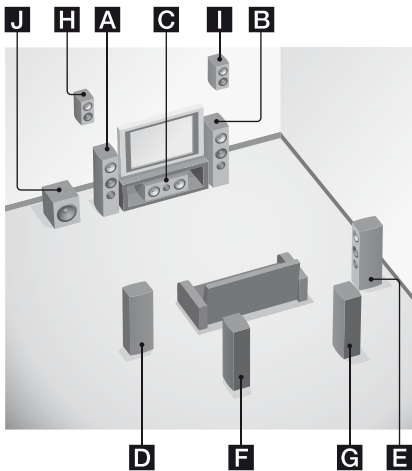

- A** Front speaker (Left)
- B** Front speaker (Right)
- C** Center speaker
- D** Surround speaker (Left)
- E** Surround speaker (Right)
- F** Surround back speaker (Left)*
- G** Surround back speaker (Right)*
- H** Front high speaker (Left)*
- I** Front high speaker (Right)*
- J** Subwoofer

* You cannot use the surround back speakers and the front high speakers simultaneously.

5.1 channel speaker system

To fully enjoy theater-like multi channel surround sound requires five speakers (two front speakers, a center speaker, and two surround speakers) and a subwoofer.

7.1 channel speaker system using surround back speakers

You can enjoy high fidelity reproduction of DVD or Blu-ray Disc software recorded sound in 6.1 channel or 7.1 channel format by connecting additional one surround back speaker (6.1 channel) or two surround back speakers (7.1 channel).

7.1 channel speaker system using front high speakers

You can enjoy vertical sound effects by connecting additional two front high speakers.

Recommended speaker placement

7.1 channel speaker system using surround back speakers

- The angle **A** shown in the illustration should be the same.

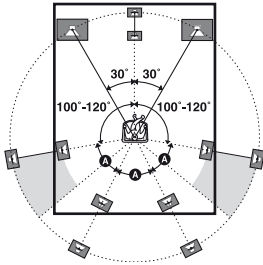

6.1 channel speaker system

- Place the surround back speaker behind the listening position.

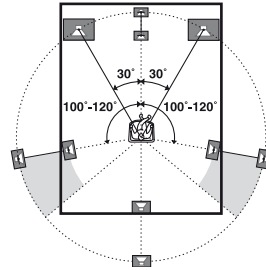

Tip

Since the subwoofer does not emit highly directional signals, you can place it wherever you want.

7.1 channel speaker system using front high speakers

- Place the front high speakers
 - at an angle between 22° to 45°.
 - at least 1 meter (3.3 feet) directly above the front speakers.

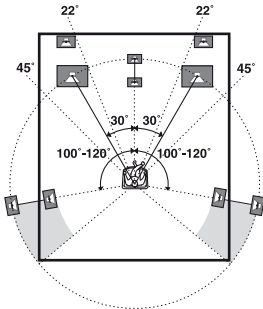

2: Connecting the speakers

Before connecting cords, be sure to disconnect the AC power cord (mains lead).

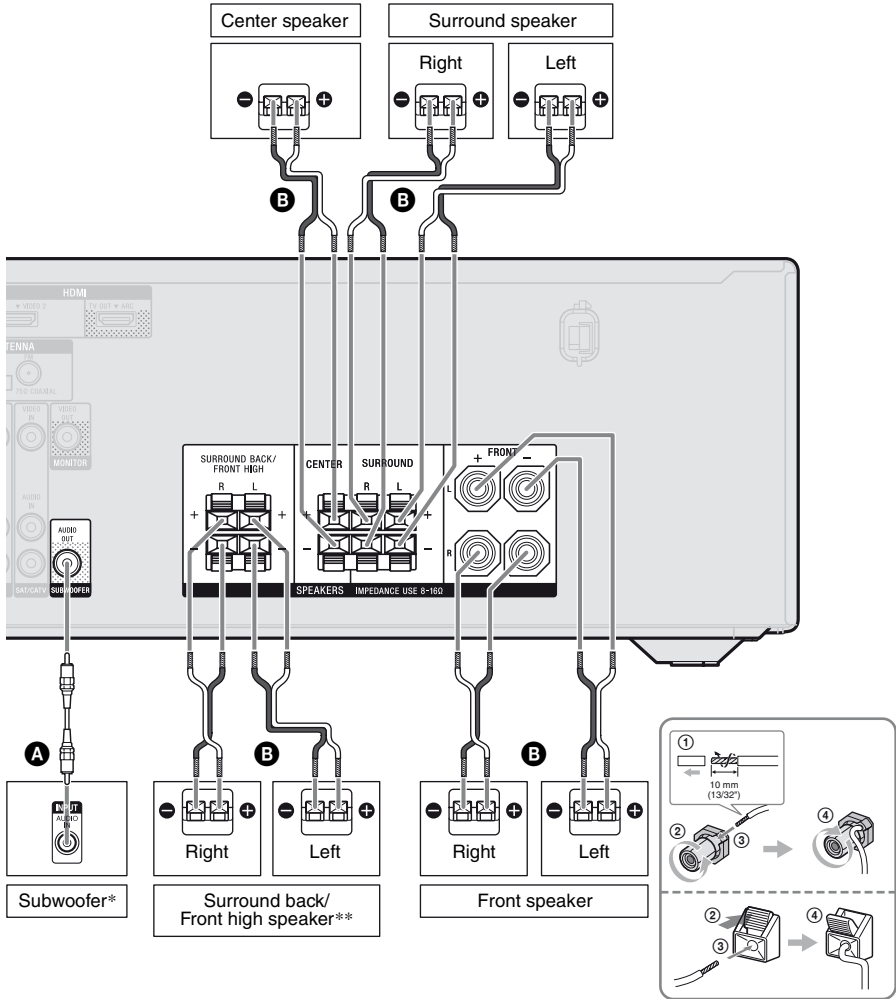

- A** Monaural audio cord (not supplied)
- B** Speaker cord (not supplied)

- * When you connect a subwoofer with an auto standby function, turn off the function when watching movies. If the auto standby function is set to on, it turns to standby mode automatically based on the level of the input signal to the subwoofer, and the sound may not be output.
- **If you connect only one surround back speaker, connect it to the SPEAKERS SURROUND BACK/FRONT HIGH L terminals.

Notes

- You can turn on or off the speaker system with the SPEAKERS button (page 9).
- After you have install and connect your speaker, be sure to select the speaker pattern from the Speaker Settings menu (page 32).

3: Connecting the TV

You can watch the selected input image when you connect the HDMI TV OUT or MONITOR OUT jack to a TV. You can operate this receiver using a GUI (Graphical User Interface) if you connect HDMI TV OUT jack to a TV.

Before connecting cords, be sure to disconnect the AC power cord (mains lead).

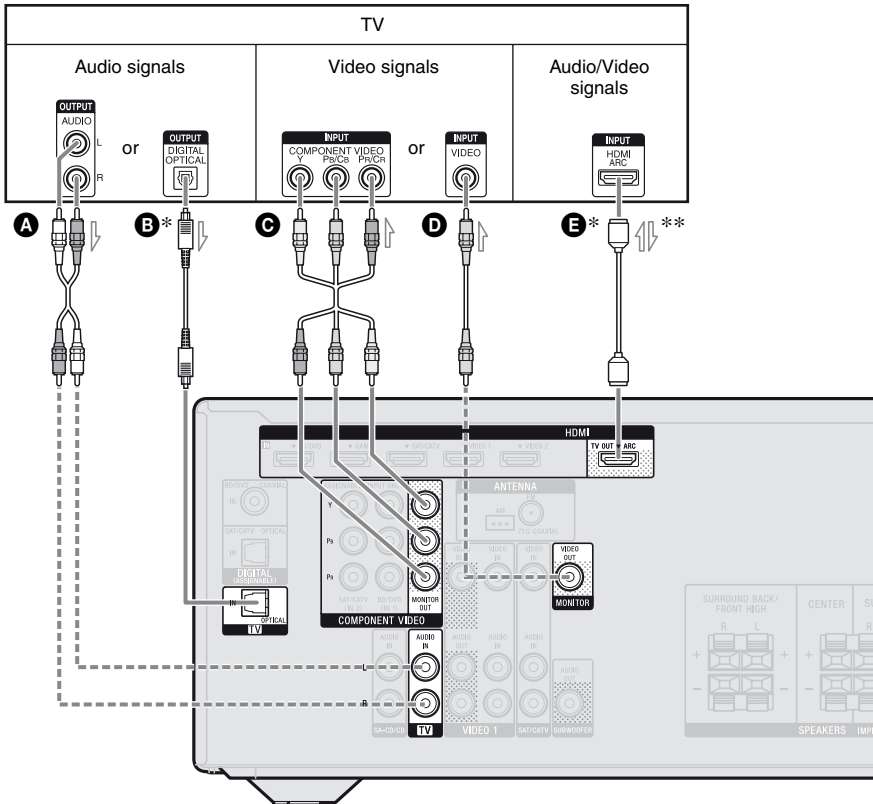

- A** Audio cord (not supplied)
- B** Optical digital cord (not supplied)
- C** Component video cord (not supplied)
- D** Video cord (not supplied)
- E** HDMI cable (not supplied)

— Recommended connection
 - - - - Alternative connection

Sony recommends that you use an HDMI-authorized cable or Sony HDMI cable.

* To enjoy the TV broadcast in multi channel surround sound from the speakers connected to the receiver, you can make either one of the following connections:

- connect **B**.
- connect **E** if your TV is compatible with the Audio Return Channel (ARC) function.

Be sure to turn off the TV's volume or activate the TV's muting function.

**If you connect the receiver to the Audio Return Channel (ARC) compatible TV, the TV sound will output from the speakers connected to the receiver via the HDMI TV OUT jack. Be sure to set the "Ctrl for HDMI" to "ON" in HDMI Settings menu (page 67). If you want to select an audio signal using other than an HDMI cable (e.g., via an optical digital cord or an audio cord), switch the audio input mode using INPUT MODE (page 59).

Notes

- Connect a TV monitor or a projector to the HDMI TV OUT or MONITOR OUT jack on the receiver. You may not be able to record, even if you connect recording equipment.
- Depending on the status of the connection between the TV and the antenna (aerial), the image on the TV screen may be distorted. If this is the case, place the antenna (aerial) farther away from the receiver.
- When connecting optical digital cords, insert the plugs straight until they click into place.
- Do not bend or tie optical digital cords.

Tips

- All the digital audio jacks are compatible with 32 kHz, 44.1 kHz, 48 kHz, and 96 kHz sampling frequencies.
- The receiver has a video conversion function. For details, see "Function for conversion of video signals" (page 29).
- When you connect the audio output jack of the TV to the TV IN jacks of the receiver to output the TV sound from the speakers connected to the receiver, set the sound output jack of the TV to "Fixed" if it can be switched between either "Fixed" or "Variable".

To listen to the sound from the TV

If your TV does not support System Audio Control function, set the "Audio Out" to "TV+AMP" in the HDMI Settings menu (page 67).

4a: Connecting the video equipment

Using HDMI connection

High-Definition Multimedia Interface (HDMI) is an interface which transmits video and audio signals in digital format.

By connecting Sony "BRAVIA" Sync-compatible equipment using HDMI cables, operations can be simplified. See "'BRAVIA" Sync Features" (page 56).

HDMI features

- A digital audio signals transmitted by HDMI can be output from the speakers connected to the receiver. This signal supports Dolby Digital, DTS, and Linear PCM. For details, see "Digital audio formats supported by the receiver" (page 54).
- The receiver can receive Multi Channel Linear PCM (up to 8 channels) with a sampling frequency of 192 kHz or less with an HDMI connection.
- Analog video signals input to the receiver's VIDEO jack or COMPONENT VIDEO jacks can be output as HDMI signals (page 29). Audio signals are not output from an HDMI TV OUT jack while the image is converted.
- This receiver supports High Bitrate Audio (DTS-HD Master Audio, Dolby TrueHD), Deep Color (Deep Colour), x.v.Color (x.v.Colour) and 3D transmission.
- To enjoy 3D images, connect 3D-compatible TV and video equipment (Blu-ray Disc player, Blu-ray Disc recorder, PlayStation 3, etc.) to the receiver using High Speed HDMI cables, put on 3D glasses, and then play back a 3D-compatible content.

continued

23^{GB}

Notes on HDMI connections

- The audio and video signals of HDMI input are not output from the HDMI TV OUT jack while the GUI menu is displayed.
- DSD signals of Super Audio CD are not input and output.
- Depending on the TV or the video equipment, 3D images may not be displayed.
- Refer to the operating instructions of each connected equipment for details.

When connecting cords

- Before connecting cords, be sure to disconnect the AC power cord (mains lead).
- It is not necessary to connect all the cords. Connect according to the availability of jacks on the connected equipment.
- Use a High Speed HDMI cable. If you use a Standard HDMI cable, 1080p, Deep Color (Deep Colour) or 3D images may not be displayed properly.
- We do not recommend using an HDMI-DVI conversion cable. When you connect an HDMI-DVI conversion cable to a DVI-D equipment, the sound and/or the image may be lost. Connect a separate audio cords or digital connecting cords, then set the “Input Assign” in the Input Option menu (page 60) when the sound is not output correctly.
- When connecting optical digital cords, insert the plugs straight until they click into place.
- Do not bend or tie optical digital cords.

Tip

All the digital audio jacks are compatible with 32 kHz, 44.1 kHz, 48 kHz, and 96 kHz sampling frequencies.

If you want to connect several digital equipment, but cannot find an unused input

See “Using the sound/images from other inputs (Input Assign)” (page 60).

Converting video signals

This receiver is equipped with a function for converting video signals. For details, see “Function for conversion of video signals” (page 29).

Connecting a Blu-ray Disc player, DVD player

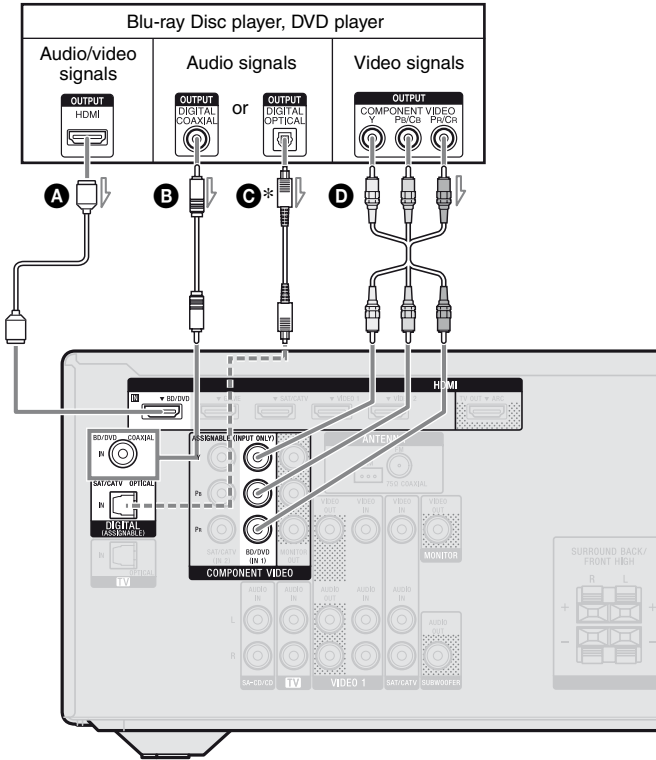

- A** HDMI cable (not supplied)
Sony recommends that you use an **HDMI-authorized cable or Sony HDMI cable.**
- B** Coaxial digital cord (not supplied)
- C** Optical digital cord (not supplied)
- D** Component video cord (not supplied)

— Recommended connection
 - - - - Alternative connection

* When you connect the equipment equipped with an OPTICAL jack, set the “Input Assign” in the Input Option menu (page 60).

Notes

- Be sure to change the default setting of the BD/DVD input buttons on the remote control so that you can use the button to control your DVD player. For details, see “Reassigning the input button” (page 72).
- You can also rename the BD/DVD input so that it can be displayed on the receiver’s display panel. For details, see “Naming the input (Name Input)” (page 41).

Connecting a satellite tuner, cable TV tuner

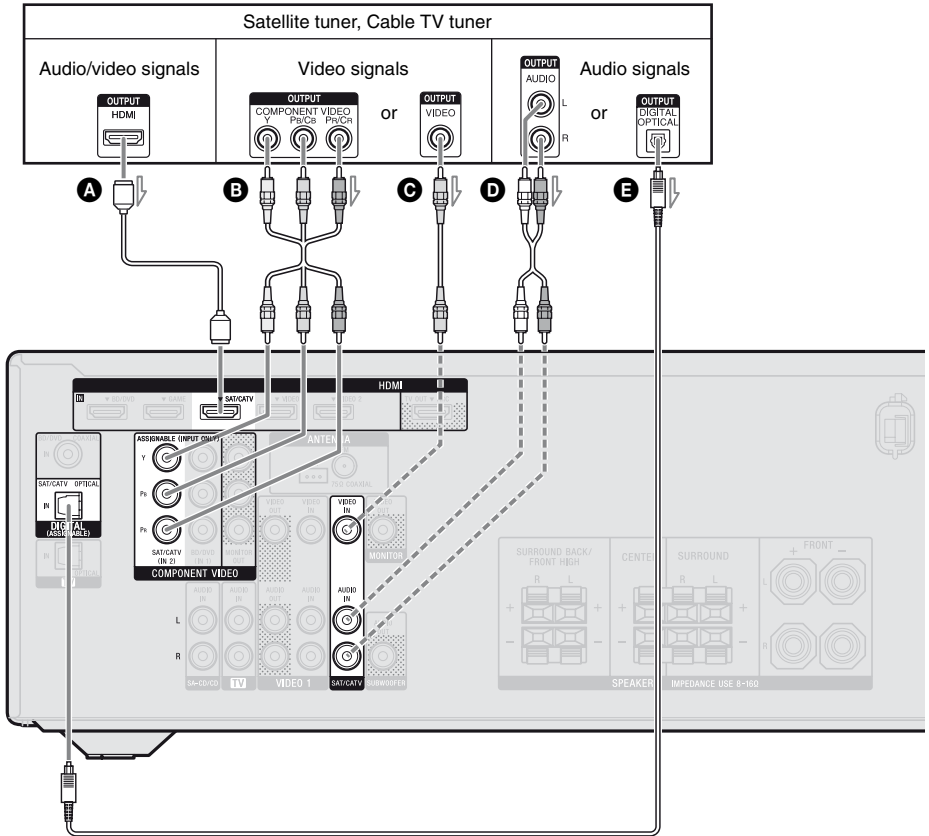

- A** HDMI cable (not supplied)
Sony recommends that you use an HDMI-authorized cable or Sony HDMI cable.
- B** Component video cord (not supplied)
- C** Video cord (not supplied)
- D** Audio cord (not supplied)
- E** Optical digital cord (not supplied)

— Recommended connection
 - - - - Alternative connection

Connecting a PlayStation 3

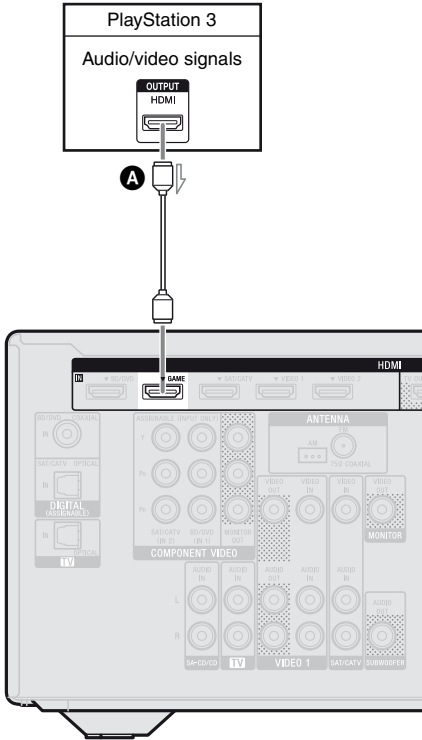

- A** HDMI cable (not supplied)
Sony recommends that you use an HDMI-authorized cable or Sony HDMI cable.

Connecting an iPod, iPhone for video contents

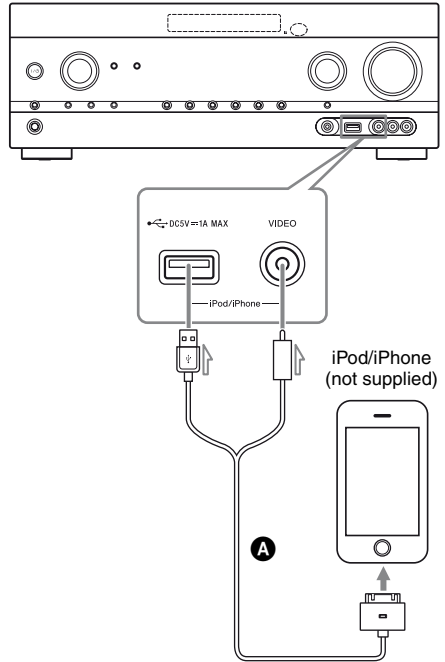

- A** Apple Composite AV cable (not supplied)

Connecting a DVD recorder, VCR

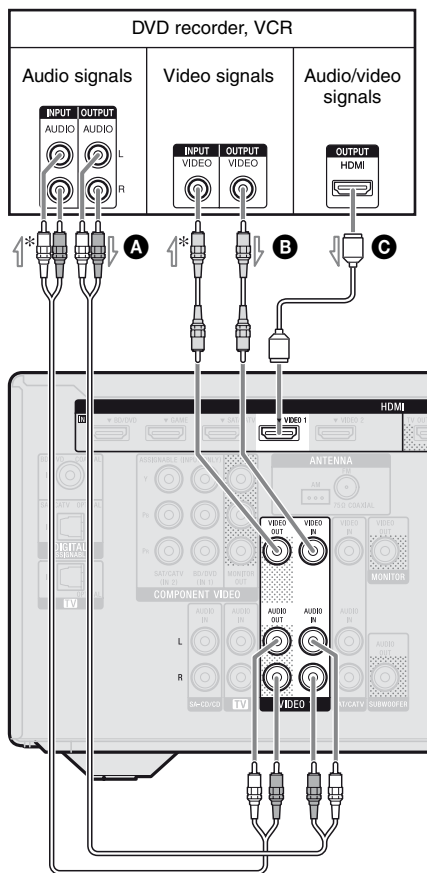

- A** Audio cord (not supplied)
- B** Video cord (not supplied)
- C** HDMI cable (not supplied)

Sony recommends that you use an HDMI-authorized cable or Sony HDMI cable.

* If you want to record, you must make this connection (page 47).

Note

Be sure to change the default setting of the VIDEO 1 input button on the remote control so that you can use the button to control your DVD recorder. For details, see "Reassigning the input button" (page 72).

Connecting a Camcorder, Video game, PC

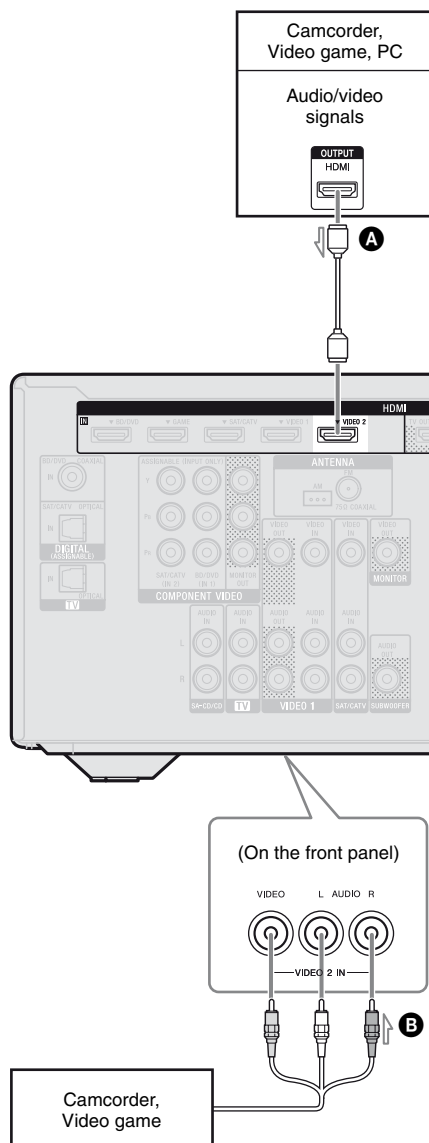







- A** HDMI cable (not supplied)
Sony recommends that you use an HDMI-authorized cable or Sony HDMI cable.
- B** Audio/video cord (not supplied)

Function for conversion of video signals

The receiver is equipped with a function for converting video signals.

Video signals and component video signals can be output as HDMI video signals (HDMI TV OUT jack only). As the default setting, video signals input from the connected equipment are output as shown in the table with solid arrows.

INPUT jack		OUTPUT jack
HDMI IN		HDMI TV OUT
COMPONENT VIDEO IN	 	COMPONENT VIDEO MONITOR OUT
VIDEO IN	 	MONITOR VIDEO OUT

 : Same type of signal as that of the input signal is output.

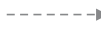
 : Video signals are upconverted and output (up to 1080i).

Notes on converting video signals

- When video signals from a VCR, etc., are up converted on this receiver and then viewed on your TV, depending on the status of the video signal output, the image on the TV screen may appear distorted horizontally or no image can be seen.
- If you are using an image improvement circuitry with your VCR, it may impact the video signal conversion. It is recommended to turn off this function on your VCR.
- Converted HDMI image output does not support x.v.Color (x.v.Colour), Deep Color (Deep Colour) and 3D.
- HDMI video signals cannot be converted to component video signals and video signals.

To connect a recording equipment

When recording, connect the recording equipment to the VIDEO OUT jacks of the receiver. Connect cords for input and output signals to the same type of jack, as VIDEO OUT jacks do not have an up-conversion function.

Note

Signals output from the HDMI TV OUT or MONITOR OUT jacks may not be recorded properly.

4b: Connecting the audio equipment

Connecting a Super Audio CD player, CD player

Before connecting cords, be sure to disconnect the AC power cord (mains lead).

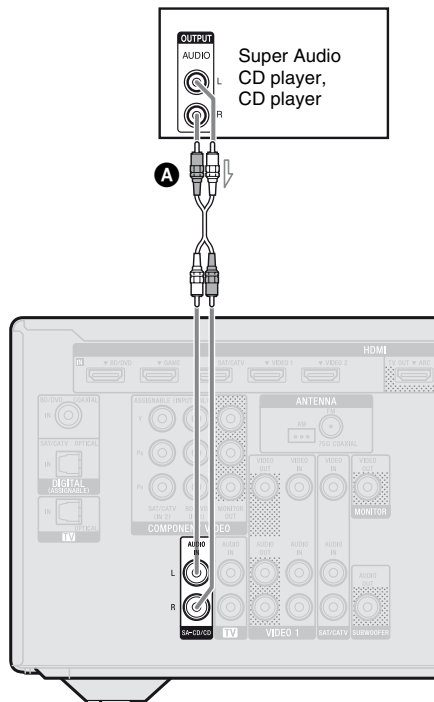

A Audio cord (not supplied)

Connecting an iPod, iPhone, USB device

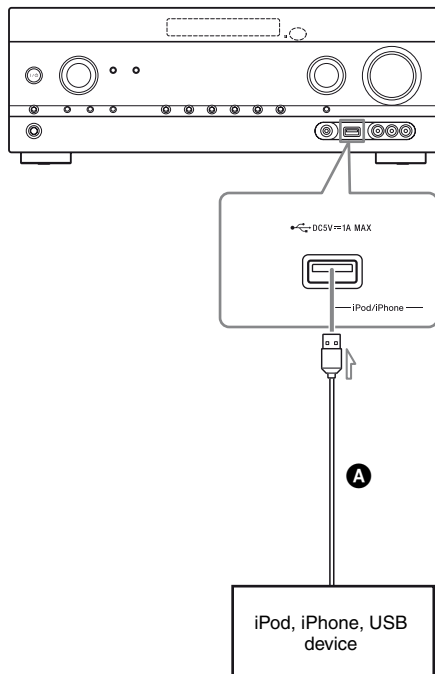

A USB cable (not supplied)

5: Connecting the antennas (aerials)

Before connecting the antennas (aerials), be sure to disconnect the AC power cord (mains lead).

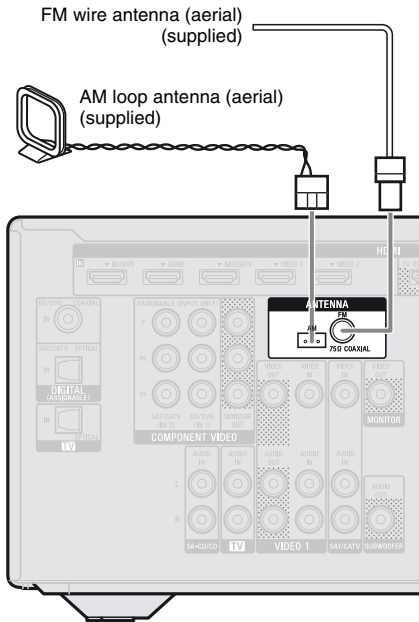

Notes

- To prevent noise pickup, keep the AM loop antenna (aerial) away from the receiver and other equipment.
- Be sure to fully extend the FM wire antenna (aerial).
- After connecting the FM wire antenna (aerial), keep it as horizontal as possible.

6: Connecting the AC power cord (mains lead)

Connect the AC power cord (mains lead) to a wall outlet.

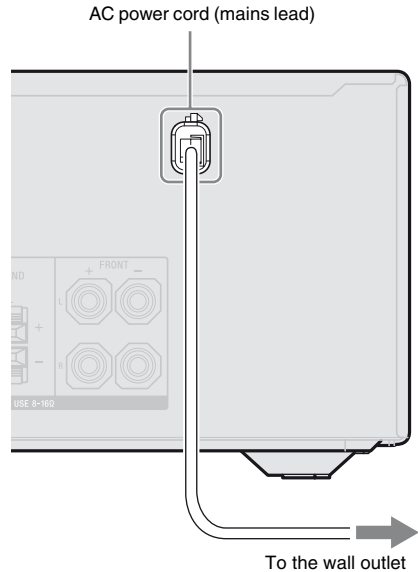

Preparing the Receiver

Initializing the receiver

Before using the receiver for the first time, initialize the receiver by performing the following procedure. This procedure can also be used to revert back to the factory default settings.

Be sure to use the buttons on the receiver to perform this operation.

I/⏻

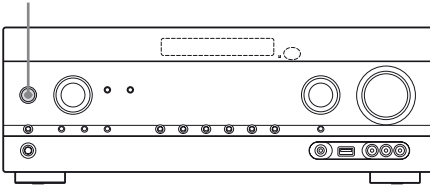

1 Press I/⏻ to turn off the receiver.

2 Hold down I/⏻ for 5 seconds.

The “CLEARING” appears on the display panel for a while, then changes to “CLEARED”.

Changes or adjustments made to the settings are now reset to the defaults.

Setting the speakers

Selecting the speaker pattern

Select the speaker pattern according to the speaker system which you are using.

1 Press GUI MODE.

After “GUI ON” appears on the display panel for a while, the GUI menu appears on the TV screen.

Press MENU if the GUI menu does not appear on the TV screen.



2 Press ⬆/⬇ repeatedly to select “⚙ Settings”, then press ⊕ or ➡.

The Settings menu list appears on the TV screen.

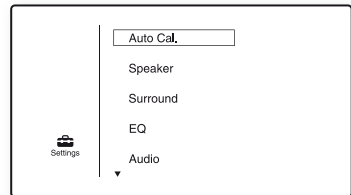

- 3** Press \uparrow/\downarrow repeatedly to select “Speaker”, then press \oplus or \rightarrow .

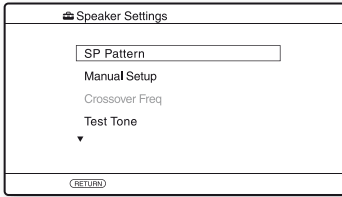

- 4** Press \uparrow/\downarrow repeatedly to select “SP Pattern”, then press \oplus or \rightarrow .

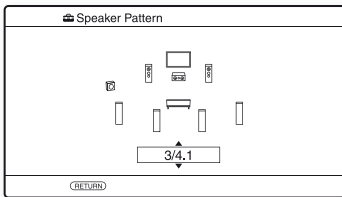

- 5** Press \uparrow/\downarrow repeatedly to select the speaker pattern you want, then press \oplus .

- 6** Press RETURN/EXIT \leftarrow .

Using AUTO CALIBRATION

This receiver is equipped with DCAC (Digital Cinema Auto Calibration) function which allows you to perform automatic calibration as follows:

- Check the connection between each speaker and the receiver.
- Adjust the speaker level.
- Measure the distance of each speaker from your seating position.*
- Measure the speaker size.*
- Measure the frequency characteristics.*

* The measurement result is not utilized when “A. DIRECT” is selected.

The DCAC is designed to achieve proper sound balance for your room. However, you can adjust the speaker levels manually according to your preference. For details, see “Test Tone” (page 64).

Before you perform Auto Calibration

Before you perform Auto Calibration, check the following items.

- Set up and connect the speakers (page 18, 20).
- Connect only the supplied optimizer microphone to the AUTO CAL MIC jack. Do not connect any other microphones to this jack.
- Make sure the speaker output is not set to “SPK OFF” (page 9).
- Disconnect the headphones.
- Remove any obstacles in the path between the optimizer microphone and the speakers to avoid measurement errors.
- Get accurate measurement by making sure the environment is free from noise and quiet.

continued

33GB

Notes

- The speakers emit very loud sound during the calibration and the volume cannot be adjusted. Provide consideration to your neighborhood and to the children in presence.
- If the muting function has been activated before you perform Auto Calibration, the muting function will shut off automatically.
- The correct measurements may not be able to take or Auto Calibration cannot be performed when special speakers, such as dipole speakers are used.

Setting up the Auto Calibration

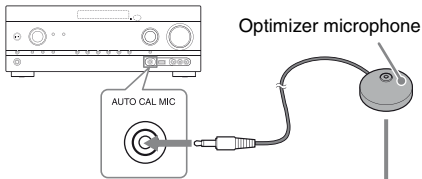

Example of using surround back speakers

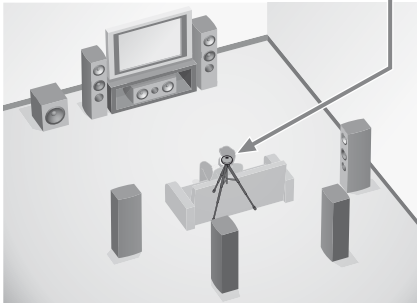

1 Select the speaker pattern (page 32).

If you connect front high speakers, select the speaker pattern that has front high speakers (5/■.■ or 4/■.■) each time you perform Auto Calibration. Otherwise, the characteristics of the front high speakers cannot be measured.

2 Connect the supplied optimizer microphone to the AUTO CAL MIC jack.

3 Set up the optimizer microphone.

Place the optimizer microphone at your seating position. Use a stool or tripod so that the optimizer microphone remains at the same height as your ears.

Confirm active subwoofer setup

- When a subwoofer is connected, turn on the subwoofer and turn up the volume prior to activating the subwoofer. Turn the LEVEL to just before the mid-point.
- If you connect a subwoofer with a crossover frequency function, set the value to maximum.
- If you connect a subwoofer with an auto standby function, set it to off (deactivated).

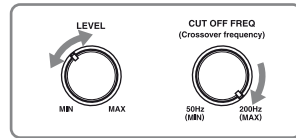

Note

Depending on the characteristics of the subwoofer you are using, the setup distance value may be different from the actual position.

Performing Auto Calibration

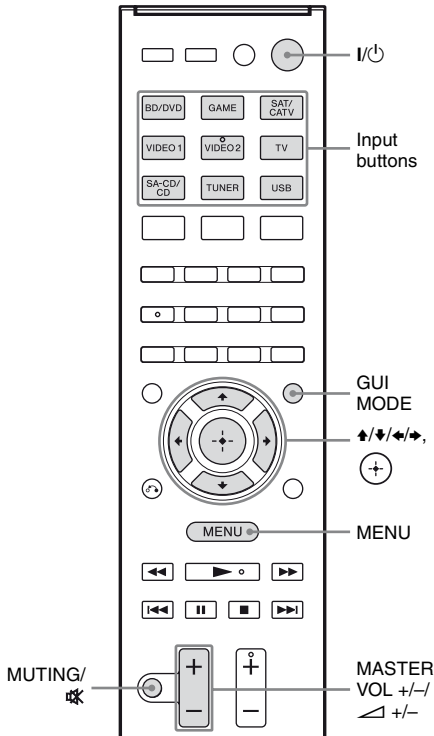

1 Press GUI MODE.

After “GUI ON” appears on the display panel for a while, the GUI menu appears on the TV screen.

Press MENU if the GUI menu does not appear on the TV screen.

2 Press \uparrow/\downarrow repeatedly to select “Settings”, then press \oplus or \rightarrow .

The Settings menu list appears on the TV screen.

3 Press \uparrow/\downarrow repeatedly to select “Auto Cal.”, then press \oplus or \rightarrow .

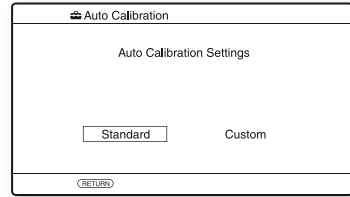

4 Press \leftarrow/\rightarrow repeatedly to select “Standard”, then press \oplus .

The calibration type is automatically set to “Engineer”.



5 Press \oplus to select “START”.

6 The measurement starts in five seconds.

The measurement process will take approximately 30 seconds with a test tone.

When the measurement ends, a beep sounds and the screen switches.

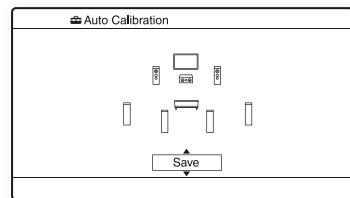

Note

If an error code appears on the screen, see “Message list after Auto Calibration measurement” (page 37).

7 Press \uparrow/\downarrow repeatedly to select the item you want, then press



- **Retry:** Performs the Auto Calibration again.
- **Save:** Save the measurement results and exits the setting process.
- **Warning:** Displays warning related to the measurement results. See “Message list after Auto Calibration measurement” (page 37).
- **Exit:** Exits the setting process without saving the measurement results.

8 Save the measurement result.

Select “Save” in step 7.

Note

You can select the calibration type you want by using the “Custom” Auto Calibration (page 37).

9 Disconnect the optimizer microphone from the receiver.

Note

If you reposition your speaker, we recommend that you perform Auto Calibration again to enjoy the surround sound.

Tips

- You can change the unit of distance in “Distance Unit” in the Speaker Settings menu (page 65).
- The size of a speaker (“Large”/“Small”) is determined by the low frequency characteristics. The measurement results may vary, depending on the position of the optimizer microphone and speakers, and the shape of the room. It is recommended that you apply the measurement results. However, you can change those settings in the Speaker Settings menu. Save the measurement results first, then try to change the settings.

To cancel Auto Calibration

The Auto Calibration function will be canceled when you perform the following during the measurement process:

- Press I/⏻.
- Press the input buttons on the remote control or turn the INPUT SELECTOR on the receiver.
- Press MUTING or .
- Press SPEAKERS on the receiver.
- Change the volume level.
- Connect the headphones.
- Press SHIFT, then press AUTO CAL again.

Checking the Auto Calibration results

To check error code or warning message obtained in “Performing Auto Calibration” (page 35), proceed with the following steps.

Press \uparrow/\downarrow to select “Warning” in step 7 in “Performing Auto Calibration” (page 35) then press



If a warning message appears, check the message and use the receiver without change. Or if necessary, perform Auto Calibration again.

When “Error Code” appears

Check the error and perform Auto Calibration again.

- 1 Press to select “ENTER”.
“RETRY ?” appears on the TV screen.
- 2 Press \leftarrow/\rightarrow to select “YES”, then press .
- 3 Repeat step 6 to 9 in “Performing Auto Calibration” (page 35).

Message list after Auto Calibration measurement

Display and explanation

Error Code 31

The SPEAKERS is set to off. Set to other speaker settings (page 9) and perform the Auto Calibration again.

Error Code 32

Error Code 33

Speakers were not detected or not connected properly.

- None of the front speakers are connected or only one front speaker is connected.
- Either the surround left or surround right speaker is not connected.
- Surround back speakers or front high speakers are connected even though surround speakers are not connected. Connect the surround speaker(s) to the SPEAKERS SURROUND terminals.
- The surround back speaker is connected only to the SPEAKERS SURROUND BACK/FRONT HIGH R terminals. When you connect only one surround back speaker, connect it to the SPEAKERS SURROUND BACK/FRONT HIGH L terminals.
- Either the front left high or front right high speaker is not connected.

The optimizer microphone is not connected. Make sure that the optimizer microphone is connected properly and perform the Auto Calibration again. If the optimizer microphone is connected properly but the error code still appears, the optimizer microphone cable may be damaged.

Warning 40

The measurement process has completed with high noise level detection. You may be able to achieve better results if you try in a quiet environment again.

Warning 41

Warning 42

The input from the microphone is too big.

- The distance between the speaker and the microphone may be too close. Set them apart and perform the measurement again.

Warning 43

The distance and position of a subwoofer cannot be detected. This may be caused by noise. Try to perform the measurement in a quiet environment.

No Warning

There is no warning information.

Tip

Depending on the position of the subwoofer, the measurement results may vary. However, there will be no problems even if you continue to use the receiver with that value.

Customizing the Auto Calibration

You can customize the Auto Calibration by selecting the calibration type you want.

1 Press GUI MODE.

After “GUI ON” appears on the display panel for a while, the GUI menu appears on the TV screen.

Press MENU if the GUI menu does not appear on the TV screen.

2 Press \uparrow/\downarrow repeatedly to select “Settings”, then press \oplus or \rightarrow .

The Settings menu list appears on the TV screen.

3 Press \uparrow/\downarrow repeatedly to select “Auto Cal.”, then press \oplus or \rightarrow .

4 Press \leftarrow/\rightarrow repeatedly to select “Custom”, then press \oplus .

5 Press \uparrow/\downarrow repeatedly to select the calibration type you want, then press \oplus .

- **Full Flat:** Makes the measurement of frequency from each speaker flat.
- **Engineer:** Sets to “the Sony listening room standard” frequency characteristics.
- **Front Reference:** Adjusts the characteristics of all the speakers to match the characteristics of the front speaker.
- **Off:** Sets the Auto Calibration equalizer level to off.

continued

37GB

- 6** Press **+** to confirm the selected calibration type.
- 7** Follow steps 5 to 9 in “Performing Auto Calibration” (page 35).

Guide to on-screen display operation

You can display the menu of the receiver on the TV screen and select the function you want to use on the TV screen by pressing **↑/↓/←/→** and **+** on the remote control.

To display the menu of the receiver on the TV screen, make sure that the receiver is in “GUI MODE” following the steps in “To turn “GUI MODE” on and off” (page 39).

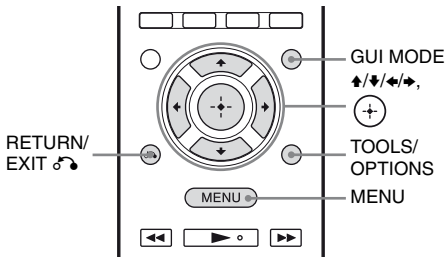

Using the menu

- 1** Switch the input of the TV so that an image of the menu is displayed.

2 Press GUI MODE.

After “GUI ON” appears on the display panel for a while, the GUI menu appears on the TV screen.

Press MENU if the GUI menu does not appear on the TV screen.

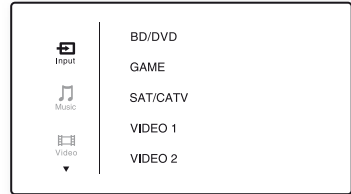

3 Press **↑/↓** repeatedly to select a menu you want, then press **+** or **→** to enter the menu.

The menu item list appears on the TV screen.

Example: When you select “**Input**”.

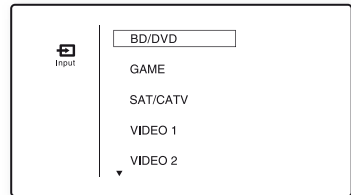

4 Press **↑/↓** repeatedly to select the menu item you want to adjust, then press **+** to enter the menu item.

5 Repeat steps 3 and 4 to select the parameter you want.

To return to the previous screen





Press RETURN/EXIT **↵**.

To exit the menu

Press MENU.

To turn “GUI MODE” on and off
 Press GUI MODE. “GUI ON” or “GUI OFF” appears on the display panel, depending on the mode selected.

Overview of the main menus

Menu icon	Description
 Input	Selects the input source equipment connected to the receiver (page 40).
 Music	Selects the music from iPod/iPhone (page 42) or USB device (page 45).
 Video	Selects the video from iPod/iPhone (page 42).
 FM/AM	Selects the built-in FM/AM radio (page 48).
 Settings	Adjusts the settings of the receiver (page 62).

Using the option menus

When you press TOOLS/OPTIONS, the option menus for the selected main menu are displayed. You can select a related function without reselecting the menu.

1 Press GUI MODE.

After “GUI ON” appears on the display panel for a while, the GUI menu appears on the TV screen.

Press MENU if the GUI menu does not appear on the TV screen.

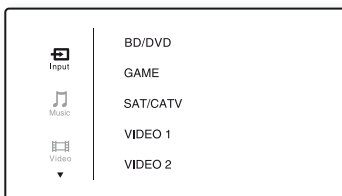

2 Press \uparrow/\downarrow repeatedly to select a menu you want, then press \oplus or \rightarrow to enter the menu.

The menu item list appears on the TV screen.

Example: When you select “ Input”.

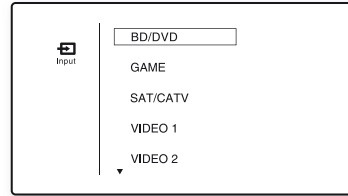

3 Press TOOLS/OPTIONS while the menu item list is displayed.

The option menu appears.

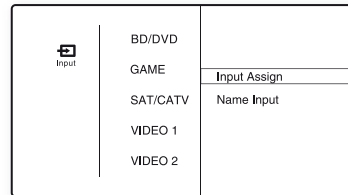

4 Press \uparrow/\downarrow repeatedly to select the option menu item you want, then press \oplus or \rightarrow .

5 Press \uparrow/\downarrow repeatedly to select the parameter you want, then press \oplus .

To exit the option menu

Press RETURN/EXIT .

Playing an input source equipment

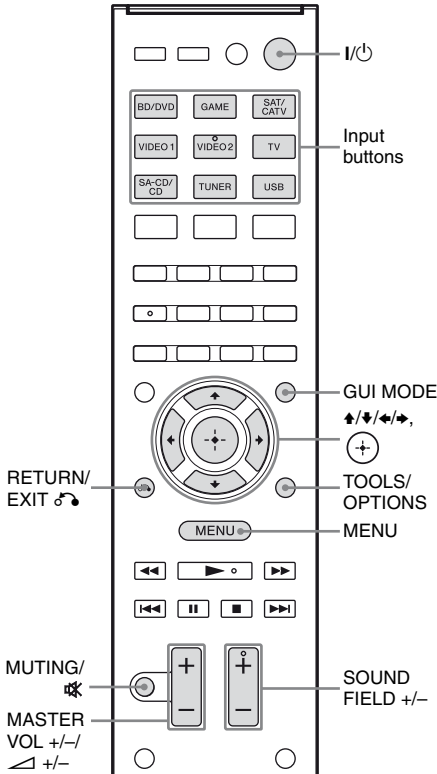

1 Press GUI MODE.

Press MENU if the GUI menu does not appear on the TV screen.

2 Select “Input”, then press **+** or **→**.

The menu item list appears on the TV screen.

3 Select the equipment you want, then press **+**.

The menu screen disappears and the playback screen of the external input appears.

The input that can be selected:

- **BD/DVD**: Blu-ray Disc player or DVD player, etc., connected to the BD/DVD jack.
- **GAME**: PlayStation 3, etc., connected to the GAME jack.
- **SAT/CATV**: Satellite tuner, etc., connected to the SAT/CATV jack.
- **VIDEO 1, VIDEO 2**: VCR, etc., connected to the VIDEO 1 or VIDEO 2 jack.
- **TV**: TV connected to the TV jack.
- **SA-CD/CD**: Super Audio CD or CD player, etc., connected to the SA-CD/CD jack.

4 Turn on the equipment and start playback.

5 Press MASTER VOL +/- or **↙ +/-** to adjust the volume.

You can also use MASTER VOLUME on the receiver.

6 Press SOUND FIELD +/- to enjoy the surround sound.

You can also use 2CH/A.DIRECT, A.F.D., MOVIE (HD-D.C.S.) or MUSIC button on the receiver.

For details, see page 51.

Tips

- You can turn INPUT SELECTOR on the receiver or press input buttons on the remote control to select the equipment you want.
- You can adjust the volume differently depending on the speed you turn the MASTER VOLUME on the receiver.
To turn the volume up or down quickly: turn the knob quickly.
To make fine adjustment: turn the knob slowly.
- You can adjust the volume differently depending on the length of time you press and hold the MASTER VOL +/- or  +/- on the remote control.
To turn the volume up or down quickly: press and hold the button.
To make a fine adjustment: press the button and release it immediately.

To activate the muting function

Press MUTING or .

The muting function will be canceled when you do the following.

- Press MUTING or  again.
- Increase the volume.
- Turn off the receiver.
- Perform Auto Calibration.









To avoid damaging your speakers

Before you turn off the receiver, be sure to turn down the volume level.

Naming the input (Name Input)

You can enter a name of up to 8 characters for inputs and display it.

It is more recognizable having the equipment named on the display than the jacks.

- 1 Select the input you want to name from “ Input” screen.**
- 2 Press TOOLS/OPTIONS.**
The option menu appears.
- 3 Select “Name Input”, then press  or .**
- 4 Press / repeatedly to select a character, then press .**
You can move the input position backward and forward by pressing /.
- 5 Repeat step 4 to input a character one by one, then press .**
The name you entered is registered.

Note

Some letters that can be displayed on the TV screen cannot be displayed on the display panel.

Playing an iPod/iPhone

You can enjoy music/video contents from the iPod/iPhone by connecting it to the iPod/iPhone terminals on the receiver.

For details on connecting the iPod/iPhone, see page 27, 30.

Compatible iPod/iPhone models

You can use the following iPod/iPhone models on this receiver. Update your iPod/iPhone with the latest software before using it.



iPod touch
4th generation



iPod touch
3rd generation



iPod touch
2nd generation



iPod touch
1st generation



iPod nano
6th generation



iPod nano
5th generation
(video camera)



iPod nano
4th generation
(video)



iPod nano
3rd generation
(video)



iPod nano
2nd generation
(aluminum)



iPod classic



iPhone 4S



iPhone 4



iPhone 3GS



iPhone 3G



iPhone

Notes

- Sony cannot accept responsibility in the event that data recorded to iPod/iPhone is lost or damaged when using an iPod/iPhone connected to this receiver.
- This product has been designed specifically to work with iPod/iPhone and has been certified to meet Apple performance standards.

Selecting the iPod/iPhone control mode

You can select the iPod/iPhone control mode using the GUI menu or iPhone CTRL on the remote control.

You can use the GUI menu to browse contents on the iPod/iPhone.

You can also control all operations by viewing the information on the display panel when "GUI MODE" is turned off.

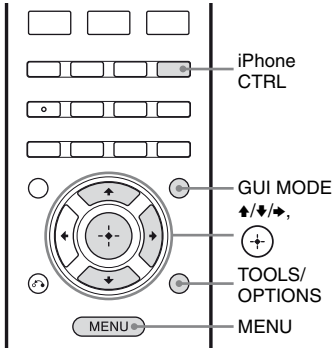

1 Press GUI MODE.

Press MENU if the GUI menu does not appear on the TV screen.

2 Select "🎵 Music" or "📺 Video", then press \oplus or \rightarrow .

When the iPod or iPhone is connected, "iPod/iPhone" appears on the TV screen.

3 Press TOOLS/OPTIONS.

The option menu appears.

4 Select "System GUI" or "iPod", then press \oplus .

Operating the iPod/iPhone using "System GUI" mode

1 Make sure that "System GUI" is selected in step 4 in "Selecting the iPod/iPhone control mode" (page 43).

2 Press \oplus to select "iPod/iPhone".

3 Select the content you want from the content list, then press \oplus or \rightarrow .

The selected content starts playback and the information of music/video contents appears on the TV screen.

Note

The video signals from iPod/iPhone are up converted on this receiver and then viewed on your TV, depending on the status of the video signal output.

For details, see "Function for conversion of video signals" (page 29).

To select the playback mode

You can change the playback mode using the TOOLS/OPTIONS on the remote control.

- Repeat: Off / One / All
- Shuffle: Off / Songs / Albums
- Audiobooks: Slower / Normal / Faster

Operating the iPod/iPhone using "iPod" mode

1 Make sure that "iPod" is selected in step 4 in "Selecting the iPod/iPhone control mode" (page 43).

2 Press \oplus to select "iPod/iPhone".

continued

3 Select the content you want using iPod/iPhone menu.

For details on operating the iPod/iPhone, refer to the operating instructions supplied with iPod/iPhone.

To operate the iPod/iPhone using the remote control

You can operate the iPod/iPhone using the following buttons on the remote control of the receiver.

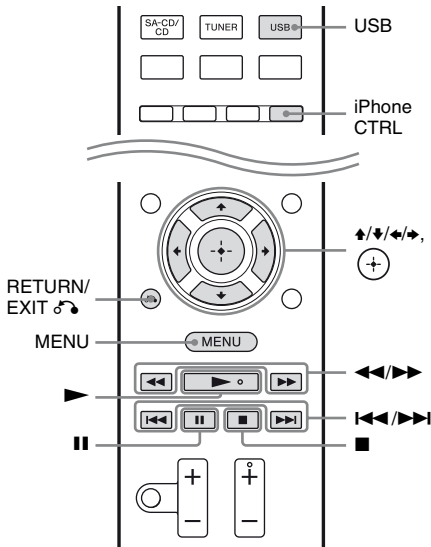

Press USB before you use the following buttons.

Press	Operation
	Starts play.
	Pauses play.
	Fast reverses or forwards.
	Goes to the previous/next track.
	Enters the selected item.
MENU, RETURN/EXIT	Returns to previous display/folder hierarchy.
	Selects the previous/next item.
iPhone CTRL	Selects the iPod/iPhone control mode.

Notes on iPod/iPhone

- The iPod/iPhone is charged when connected to the receiver while the receiver is turned on.
- You cannot transfer songs onto the iPod/iPhone from this receiver.
- Do not remove the iPod/iPhone during operation. To avoid data corruption or damage to the iPod/iPhone, turn the receiver off when connecting or removing the iPod/iPhone.

iPod/iPhone message list

Message and explanation

Reading

The receiver is recognizing and reading information of the iPod or iPhone.

Loading

The receiver is loading information of the iPod or iPhone.

No Support

An unsupported iPod or iPhone is connected, or an unknown device is connected.

No Device

No iPod or iPhone is connected.

No Music / No Video

No music or video was found.

HP No Support

No sound is output from the headphones when iPod or iPhone is connected.

Playing a USB device

You can enjoy music from the USB device by connecting it to the  (USB) port on the receiver.

For details on connecting a USB device, see “Connecting an iPod, iPhone, USB device” (page 30).

The music file formats that can be played back by this receiver are as follows:

Music

File format	Extensions
MP3 (MPEG-1 Audio Layer III)	“.mp3”
AAC*	“.m4a”, “.3gp”, “.mp4”
WMA9 Standard*	“.wma”

* The receiver does not play files encoded with DRM.

Compatible USB devices

You can use the following Sony USB devices on this receiver. Other USB devices cannot be used on this receiver.

Verified Sony USB device

Product name	Model name
Walkman®	NWZ-S754 / S755
	NWZ-E453 / E454 / E455
	NWZ-E353 / E354 / E355
	NWZ-B133 / B135 / B133F / B135F
	NWZ-B142 / B143 / B142F / B143F
	NWD-E023F / E025F
	NWZ-E435F / E436F / E438F
	NWZ-E343 / E344 / E345
	NWZ-S636F / S638F / S639F
	NWZ-S736F / S738F / S739F
	NWZ-A726 / A728 / A729 / A726B / A728B

Product name	Model name
	NWZ-A826 / A828 / A829
	NWZ-W202
	NWZ-X1050 / X1060
	NWZ-S744 / S745
	NWZ-E443 / E444 / E445
	NWZ-S543 / S544 / S545
	NWZ-A844 / A845 / A846 / A847
	NWZ-W252 / W253
	NWZ-B152 / B153 / B152F / B153F
MICROVAULT	USM1GL / 2GL / 4GL / 8GL / 16GL
	USM1GLX / 2GLX / 4GLX / 8GLX / 16GLX

Notes

- The receiver is unable to read data in NTFS format.
- The receiver is unable to read data other than that saved in the first partition of a hard disk drive.
- Do not use USB devices other than these USB devices. Operation of models not listed here is not guaranteed.
- Operation may not always be ensured even when using these USB devices.
- Some of these USB devices may not be available for purchase in certain areas.
- When formatting the above models, be sure to format using the model itself or the dedicated formatting software for that model.
- When connecting a USB device to the receiver, be sure to connect after the display “Creating Library” or “Creating Database” on the USB device has disappeared.

Operating the USB device

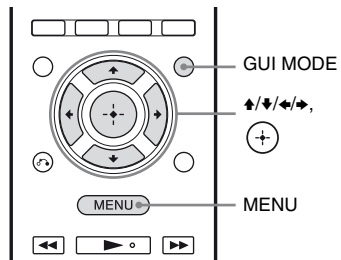

continued

1 Press GUI MODE.

Press MENU if the GUI menu does not appear on the TV screen.

2 Select “ Music”, then press or .

When the USB device is connected, “USB” appears on the TV screen.

3 Press to select “USB”.

You can operate the USB device using the remote control of the receiver.

The information of music contents appear on the TV screen.

To select the playback mode

You can change the playback mode using the TOOLS/OPTIONS on the remote control.





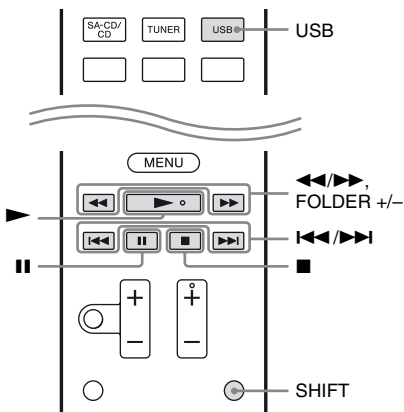

- Repeat: Off / One / All / Folder

To operate the USB device using the remote control

You can operate the USB device using the following buttons on the remote control of the receiver.



Press USB before you use the following buttons.

Press	Operation
	Starts play.
	Pauses play.
	Stops play.
 or 	Fast reverses or forwards.
 or 	Goes to the previous/next file.
FOLDER +/-*	Goes to the previous/next folder.

* Hold down SHIFT and press this button.

Notes on the USB device

- When USB cable connection is necessary, connect the USB cable supplied with the USB device to be connected. Refer to the operating instructions supplied with the USB device to be connected for details on the operation method.
- Do not connect the receiver and the USB device through a USB hub.
- When the USB device is connected, “Reading” appears.
- It may take about 10 seconds before “Reading” appears depending on the type of USB device connected.
- When the USB device is connected, the receiver reads all the files on the USB device. If there are many folders or files on the USB device, it may take a long time to finish reading the USB device.
- The receiver can recognize up to
 - 100 folders (including “ROOT” folder).
 - 100 audio files for each folder.
 - 8 folder levels (tree structure of files, including “ROOT” folder).The maximum number of audio files and folders may vary depending on the file and folder structure.
Do not save other types of files or unnecessary folders on a USB device.
- Compatibility with all encoding/writing softwares, recording devices, and recording media cannot be guaranteed. Incompatible USB device may produce noise or interrupted audio or may not play at all.

- Some time may be needed to start playback when:
 - the folder structure is complex.
 - the memory capacity is excessive.
- This receiver does not necessarily support all the functions provided in a connected USB device.
- The playback order for the receiver may differ from the playback order of the connected USB device.
- Folders that have no audio files are skipped.
- When playing a very long track, some operations may cause playback delay.

USB message list

Message and explanation

Reading

The receiver is recognizing and reading information of the USB device.

Device Error

The memory of the USB device could not be recognized (page 45).

No Support

An unsupported USB device is connected, an unknown device is connected, or the USB device is connected through a USB hub (page 45).

No Device

No USB device is connected or the connected USB device is not recognized.

No Track

No track was found.

Recording using the receiver

You can record from an audio/video equipment using the receiver. Refer to the operating instructions supplied with your recording equipment.

1 Prepare the source for playing.

Use the input button (or INPUT SELECTOR on the receiver) to select the source.

For example, select SAT/CATV.

2 Prepare the recording equipment.

Insert a blank video tape, etc. into the recording equipment (connected to VIDEO 1 OUT jacks).

3 Start recording on the recording equipment, then start the playback equipment.

Notes

- Some sources contain copyright protection to prevent recording. In this case, you may not be able to record from the source.
- Audio and video input signals via HDMI IN, COMPONENT VIDEO IN and DIGITAL IN jacks cannot be recorded.
- While only composite video signals are being recorded, the auto standby function of the receiver may start up and interrupt the recording. In this case, set the "Auto Standby" to "OFF" (page 67).

Tuner Operations

Listening to FM/AM radio

You can listen to FM and AM broadcasts through the built-in tuner. Before operation, be sure you have connected the FM and AM antennas (aerials) to the receiver (page 31).

Tip

The tuning scale for direct tuning is shown below.

Area	FM	AM
USA, Canada	100 kHz	10 kHz*
Europe, Australia, Taiwan	50 kHz	9 kHz
Mexico	50 kHz	10 kHz*

* The AM tuning scale can be changed (page 49).

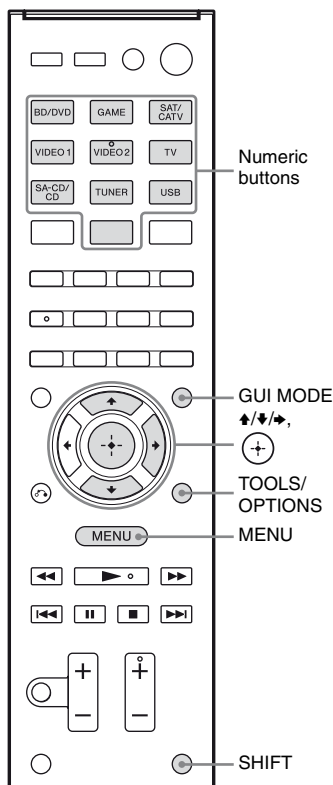

1 Press GUI MODE.

Press MENU if the GUI menu does not appear on the TV screen.

2 Select “ FM FM” or “ AM AM” from the menu, then press \oplus or \rightarrow .

The FM or AM menu list appears on the TV screen.

Tuning to a station automatically (Auto Tuning)

1 Select “Auto Tuning”, then press \oplus or \rightarrow .

2 Press \uparrow/\downarrow .

Press \uparrow to scan from lower to higher frequency stations, press \downarrow to scan from higher to lower stations.

The receiver stops scanning whenever a station is received.

In case of poor FM stereo reception

1 Tune in the station you want to listen to using Auto Tuning, Direct Tuning (page 48), or select the preset station you want (page 49).

2 Press TOOLS/OPTIONS.

3 Select “FM Mode”, then press \oplus or \rightarrow .

4 Select “MONO”, then press \oplus .

Tuning to a station directly (Direct Tuning)

You can enter the frequency of a station directly by using the numeric buttons.

1 Select “Direct Tuning”, then press \oplus or \rightarrow .

2 Press SHIFT, then press numeric buttons to enter the frequency.

Example 1: FM 102.50 MHz

Select 1 → 0 → 2 → 5 (→ 0*)

Example 2: AM 1,350 kHz

Select 1 → 3 → 5 → 0

* Press 0 for Europe, Mexico, Australia and Taiwan models only.

Tip

Adjust the direction of the AM loop antenna (aerial) for optimum reception upon tuning to an AM station.

3 Press (+).

If you cannot tune to a station

“---.--- MHz” or “---- kHz” appears and then the screen returns to the current frequency.

Make sure you have entered the right frequency. If not, repeat step 2. If you still cannot tune to a station, the frequency may not be in use in your area.

Changing the AM tuning scale

(USA, Canada and Mexico models only)

You can change the AM tuning scale to either 9 kHz or 10 kHz using the buttons on the receiver.

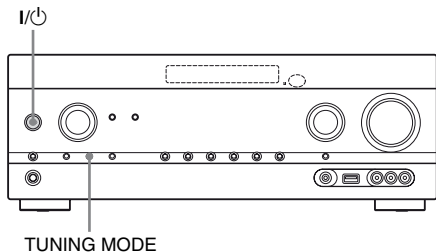

1 Press I/O to turn off the receiver.

2 While holding down TUNING MODE, press I/O on the receiver.

3 Change the current AM tuning scale to 9 kHz (or 10 kHz).

To reset the scale to 10 kHz (or 9 kHz), repeat the procedure above.

Note

All preset stations will be erased when you change the tuning scale.

Presetting FM/AM radio stations (Preset Tuning)

You can store up to 30 FM and 30 AM stations as your favorite stations.

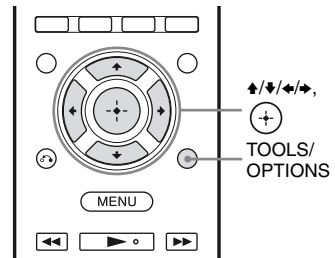

1 Tune to the station that you want to preset using Auto Tuning (page 48) or Direct Tuning (page 48).

2 Press TOOLS/OPTIONS.

The option menu appears.

3 Select “Memory”, then press (+) or →.

4 Select a preset number, then press (+).

The station is stored as the selected preset number.

continued

5 Repeat steps 1 to 4 to store another station.

You can store station as follows:

- AM band: AM 1 to AM 30
- FM band: FM 1 to FM 30

Tuning to preset stations

1 Select “ FM” or “ AM” from the menu, then press  or .

2 Select the preset station you want, then press .



Preset numbers from 1 to 30 are available.

Naming preset stations (Name Input)



1 On “ FM” or “ AM” screen, select the preset number which you want to name.

2 Press TOOLS/OPTIONS.

The option menu appears.

3 Select “Name Input”, then press  or .

4 Press / repeatedly to select a character, then press .

You can move the input position backward and forward by pressing /.

5 Repeat step 4 to input a character one by one, then press .

The name you entered is registered.

Note

Some letters that can be displayed on the TV screen cannot be displayed on the display panel.

Receiving RDS broadcasts

(Europe, Australia and Taiwan models only)

This receiver allows you to use Radio Data System (RDS), which enables radio stations to send additional information along with the regular programming signal. This receiver offers convenient RDS features, such as Program Service name display. RDS is available only for FM stations.*

* Not all FM stations provide RDS service, nor do they provide the same type of services. If you are not familiar with the RDS services in your area, check with your local radio stations for details.

Simply select a station on the FM band.

When you tune to a station that provides RDS services, “RDS” lights up and the Program Service name* appears on the TV screen and the display panel.

* If an RDS broadcast is not received, a Program Service name will not appear.

Notes

- RDS may not work properly if the station you tuned to is not transmitting the RDS signal or if the signal strength is weak.
- Some letters that can be displayed on the TV screen cannot be displayed on the display panel.

Tip

While a Program Service name is displayed, you can check the frequency by pressing DISPLAY repeatedly (page 72).

Selecting the sound field

This receiver can create multi channel surround sound. You can select one of the optimized sound fields from the receiver's pre-programmed sound fields.

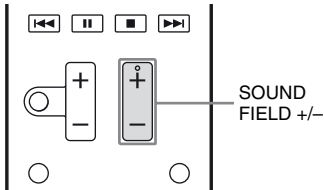

Press SOUND FIELD +/- repeatedly to select the sound field you want.

You can also use 2CH/A.DIRECT, A.F.D., MOVIE (HD-D.C.S.) or MUSIC on the receiver.

2 channel sound mode

You can switch the output sound to 2 channel sound regardless of the recording formats of the software you are using, the playback equipment connected, or the sound field settings of the receiver.

■ 2CH ST. (2ch Stereo)

The receiver outputs the sound from the front left/right speakers only. There is no sound from the subwoofer.

Standard 2 channel stereo sources completely bypass the sound field processing and multi channel surround formats are downmixed to 2 channels.

■ A. DIRECT (Analog Direct)

You can switch the audio of the selected input to 2 channel analog input. This function enables you to enjoy high quality analog sources.

When using this function, only the volume and front speaker level can be adjusted.

Note

You cannot select "A. DIRECT" when you select BD/DVD, GAME and USB as input.

Auto Format Direct (A.F.D.) mode

The Auto Format Direct (A.F.D.) mode allows you to listen to higher fidelity sound and select the decoding mode for listening to a 2 channel stereo sound as multi channel sound.

■ A.F.D. AUTO (A.F.D. Auto)

Presets the sound as it was recorded/encoded without adding any surround effects.

However, for USA and Canada models, this receiver will generate a low frequency signal for output to the subwoofer when there is no LFE signals.

■ MULTI ST. (Multi Stereo)

Outputs 2 channel left/right signals from all speakers. However, sound may not be output from certain speakers depending on the speaker settings.

Movie mode

You can take advantage of surround sound simply by selecting one of the receiver's pre-programmed sound fields. They bring the exciting and powerful sound of movie theaters into your home.

■ HD-D.C.S.

HD Digital Cinema Sound (HD-D.C.S.) is Sony's new innovative home theater technology using the latest acoustic and digital signal processing technologies. It is based on precise response measurement data of a mastering studio.

With HD-D.C.S., you are able to enjoy Blu-ray and DVD movies at home with not only the high quality of sound, but also the best sound ambience, just as the movie's sound engineer intended in the mastering process.

You can select the effect type for HD-D.C.S. For details, see "Surround Settings menu" (page 65).

■ PLII MV (PLII Movie)

Performs Dolby Pro Logic II Movie mode decoding. This setting is ideal for movies encoded in Dolby Surround. In addition, this mode can reproduce sound in 5.1 channel for watching videos of overdubbed or old movies.

■ PLIIX MV (PLIIX Movie)

Performs Dolby Pro Logic IIX Movie mode decoding. This setting expands Dolby Pro Logic II Movie or Dolby Digital 5.1 to discrete 7.1 movie channels.

■ PLIIZ (PLIIZ Height)

Performs Dolby Pro Logic IIZ mode decoding. This setting can expand a source sound from a 5.1 channel to a 7.1 channel to which a vertical equipment is applied, and gives a dimension of presence and depth.

■ NEO6 CIN (Neo:6 Cinema)

Performs DTS Neo:6 Cinema mode decoding. A source recorded in 2 channel format is decoded into 7 channels.

■ 2CH V.SUR (2ch V.Surround)

Generates virtual surround sound with only two front speakers.

Music mode

You can take advantage of surround sound simply by selecting one of the receiver's pre-programmed sound fields. They bring the exciting and powerful sound of concert halls into your home.

■ HALL (Hall)

Reproduces the acoustics of a classical concert hall.

■ JAZZ (Jazz Club)

Reproduces the acoustics of a jazz club.

■ CONCERT (Live Concert)

Reproduces the acoustics of a 300-seat live house.

■ STADIUM (Stadium)

Reproduces the feeling of a large open-air stadium.

■ SPORTS (Sports)

Reproduces the feeling of sports broadcasting.

■ P. AUDIO (Portable Audio)

Reproduces a clear enhanced sound image from your portable audio device. This mode is ideal for MP3 and other compressed music.

■ PLII MS (PLII Music)

Performs Dolby Pro Logic II Music mode decoding. This setting is ideal for normal stereo sources such as CDs.

■ PLIIX MS (PLIIX Music)

Performs Dolby Pro Logic IIX Music mode decoding. This setting is ideal for normal stereo sources such as CDs.

■ PLIIZ (PLIIZ Height)

Performs Dolby Pro Logic IIZ mode decoding. This setting can expand a source sound from a 5.1 channel to a 7.1 channel to which a vertical equipment is applied, and gives a dimension of presence and depth.

■ NEO6 MUS (Neo:6 Music)

Performs DTS Neo:6 Music mode decoding. A source recorded in 2 channel format is decoded into 7 channels. This setting is ideal for normal stereo sources such as CDs.

When headphones are connected

You can only select this sound field if the headphones are connected to the receiver.

■ HP 2CH (HP (2CH))

This mode is selected automatically if you use headphones (except “A. DIRECT”). Standard 2 channel stereo sources completely bypass the sound field processing and multi channel surround formats are downmixed to 2 channels except LFE signals.

■ HP DIR (HP (Direct))

This mode is selected automatically if you use headphones when “A. DIRECT” is selected. Outputs the analog signals without processing by the equalizer, sound field, etc.

If you connect a subwoofer

This receiver will generate a low frequency signal for output to the subwoofer when there is no LFE signal, which is a low-pass sound effect output from a subwoofer to a 2 channel signal. However, the low frequency signal is not generated for “NEO6 CIN” or “NEO6 MUS” when all speakers are set to “Large”. In order to take full advantage of the Dolby Digital bass redirection circuitry, we recommend setting the subwoofer’s cut off frequency as high as possible.

Notes on sound fields

- Depending on the speaker pattern settings, some sound fields may not be available.
- You cannot select PLIIX and PLIIZ at the same time.
 - PLIIX is available only when the speaker pattern is set to a setting with surround back speaker(s).
 - PLIIZ is available only when the speaker pattern is set to a setting with front high speakers.
- The sound fields for music and movie do not work in the following cases.
 - DTS-HD Master Audio, DTS-HD High Resolution Audio or Dolby TrueHD with sampling frequency of more than 48 kHz are being received.
 - “A. DIRECT” is selected.
- “PLII MV”, “PLIIX MV”, “PLII MS”, “PLIIX MS”, “PLIIZ”, “NEO6 CIN” and “NEO6 MUS” do not work when the speaker pattern is set to 2/0 or 2/0.1.
- When one of the sound fields for music is selected, no sound is output from the subwoofer if all the speakers are set to “Large” in the Speaker Settings menu. However, the sound will be output from the subwoofer if
 - the digital input signal contains LFE signals.
 - the front or surround speakers are set to “Small”.
 - “MULTI ST.”, “PLII MV”, “PLII MS”, “PLIIX MV”, “PLIIX MS”, “PLIIZ”, “HD-D.C.S.” or “P. AUDIO” is selected.

To turn off the surround effect for movie/music

Press SOUND FIELD +/- repeatedly to select “2CH ST.” or “A.F.D. AUTO”.

You can also press 2CH/A.DIRECT repeatedly on the receiver to select “2CH ST.” or press A.F.D. repeatedly on the receiver to select “A.F.D. AUTO”.

Digital audio formats supported by the receiver

Digital audio formats that this receiver can decode depend on digital audio output jacks of the equipment connected. This receiver supports the following audio formats.

Audio format	Maximum number of channels	Connection between the playback equipment and the receiver	
		COAXIAL/OPTICAL	HDMI
Dolby Digital	5.1	○	○
Dolby Digital EX	6.1	○	○
Dolby Digital Plus ^{a)}	7.1	×	○
Dolby TrueHD ^{a)}	7.1	×	○
DTS	5.1	○	○
DTS-ES	6.1	○	○
DTS 96/24	5.1	○	○
DTS-HD High Resolution Audio ^{a)}	7.1	×	○
DTS-HD Master Audio ^{a)b)}	7.1	×	○
Multi Channel Linear PCM ^{a)}	7.1	×	○

^{a)} Audio signals are output in another format if the playback equipment does not correspond to the format. For details, refer to the operating instructions of the playback equipment.

^{b)} Signals with a sampling frequency of more than 96 kHz are played back at 96 kHz or 88.2 kHz.

Using Advanced Auto Volume function

This receiver can adjust the volume automatically depending on the input signal or content from the connected equipment.

This function is useful, for example, when the sound of a commercial is louder than the TV programs.

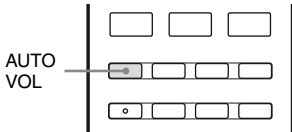

Press AUTO VOL to select “A.VOL ON”.

The advanced auto volume function is set to on and off as you press AUTO VOL.

Notes

- Be sure to reduce the volume level before you turn on/off this function.
- As this function is available only when Dolby Digital, DTS or Linear PCM signals are input, the sound may suddenly increase when you switch to other formats.
- This function does not work in the following cases.
 - Linear PCM signals with a sampling frequency of more than 48 kHz are being received.
 - Dolby Digital Plus, Dolby TrueHD, DTS 96/24, DTS-HD Master Audio, or DTS-HD High Resolution Audio signals are being received.

Resetting sound fields to the default settings

Be sure to use the buttons on the receiver to perform this operation.

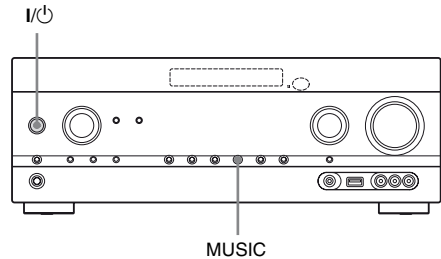

1 Press I/Power to turn off the receiver.

2 While holding down MUSIC, press I/Power.

“S.F. CLEAR” appears on the display panel and all sound fields are reset to their default setting.

What is “BRAVIA” Sync?

The “BRAVIA” Sync function allows communication between Sony products such as TV, Blu-ray Disc/DVD player, AV amplifier, etc. that supports the Control for HDMI function.

By connecting Sony equipment that is compatible with the “BRAVIA” Sync with an HDMI cable (not supplied), operation is simplified as follows:

- One-Touch Play (page 57)
- System Audio Control (page 58)
- System Power-Off (page 58)
- Scene Select (page 59)

Control for HDMI is a mutual control function standard used by HDMI CEC (Consumer Electronics Control) for HDMI (High-Definition Multimedia Interface).

We recommend that you connect the receiver to products featuring “BRAVIA” Sync.

Note

Depending on the connected equipment, the Control for HDMI function may not work. Refer to the operating instructions of the equipment.

Preparing for the “BRAVIA” Sync

The receiver is compatible with the “Control for HDMI-Easy Setting” function.

- If your TV is compatible with the “Control for HDMI-Easy Setting” function, you can set the Control for HDMI function of the receiver and playback equipment automatically by setting the Control for HDMI function on your TV (page 56).
- If your TV is not compatible with the “Control for HDMI-Easy Setting” function, set the Control for HDMI function of the receiver, playback equipment and TV individually (page 57).

If your TV is compatible with the “Control for HDMI-Easy Setting” function

The Control for HDMI function of the receiver can be turned on simultaneously by turning on the Control for HDMI function of the TV.

- 1** Connect the receiver, TV and playback equipment via HDMI connection (page 23).
(The respective equipment must be compatible with the Control for HDMI function.)
- 2** Turn on the receiver, TV and playback equipment.
- 3** Turn on the Control for HDMI function of the TV.
The Control for HDMI function of the receiver and all the connected equipment are turned on simultaneously. During the setup, “SCANNING” flashes on the display panel. Wait until “COMPLETE” appears. The setup is complete.

For details on setup of the TV, refer to the operating instructions of your TV.

If your TV is not compatible with the “Control for HDMI-Easy Setting” function

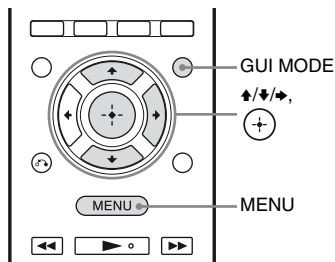

- 1 Press GUI MODE.
Press MENU if the GUI menu does not appear on the TV screen.
- 2 Select “ Settings” from the menu, then press \oplus or \rightarrow .
The Settings menu list appears on the TV screen.
- 3 Select “HDMI”, then press \oplus or \rightarrow .
- 4 Select “Ctrl for HDMI”, then press \oplus or \rightarrow .
- 5 Select “ON”, then press \oplus .
The Control for HDMI function is set to on.
- 6 Press GUI MODE to exit the GUI menu.
If the GUI menu is displayed, the Control for HDMI function of the playback equipment will not work properly.
- 7 Select the HDMI input of the receiver and TV to match the HDMI input of the connected equipment, so that the image from the connected equipment is displayed.
- 8 Set the Control for HDMI function for the connected equipment to on.
If the Control for HDMI function for the connected equipment is already set to on, you do not need to change the setting.
- 9 Repeat steps 7 and 8 for other equipment that you want to use the Control for HDMI function.
For details on setting the TV and connected equipment, refer to the operating instructions of the respective equipment.

Notes

- When you unplug the HDMI cable or change the connection, perform the steps given in “If your TV is compatible with the “Control for HDMI-Easy Setting” function” (page 56) or “If your TV is not compatible with the “Control for HDMI-Easy Setting” function” (page 57).
- Before you perform the “Control for HDMI-Easy Setting” on your TV, be sure to turn on the TV and other connected equipment including the receiver first.
- If the playback equipment cannot function after you have made the settings for “Control for HDMI-Easy Setting”, check the Control for HDMI setting on your TV.
- If the connected equipment does not support the “Control for HDMI-Easy Setting”, but still supports the Control for HDMI, then you need to set the Control for HDMI function for the connected equipment before you perform the “Control for HDMI-Easy Setting” from the TV.

Playing back equipment with one-touch operation (One-Touch Play)

When you start playback the equipment connected to the receiver via an HDMI connection, the receiver and TV operation are simplified as follow:

Receiver and TV

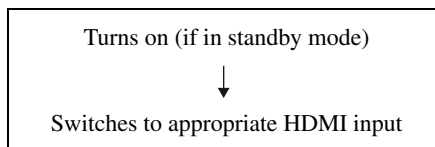

If you set “Pass Through” to “AUTO” or “ON”, then set the receiver to standby mode, sound and image can be output only from the TV.

Notes

- Be sure that the System Audio Control function is set to on using TV menu.
- Depending on the TV, the start of the content may not appear.
- Depending on the settings, the receiver may not turn on when “Pass Through” is set to “AUTO” or “ON”.

Tip

You can also select a connected equipment, such as Blu-ray Disc/DVD player from the TV menu. The receiver and TV will automatically switch to the appropriate HDMI input.

Enjoying the TV sound from the speakers connected to the receiver (System Audio Control)

You can enjoy the TV sound from the speakers connected to the receiver by a simple operation.

You can operate System Audio Control function using the TV menu. For details, refer to the operating instructions of the TV.

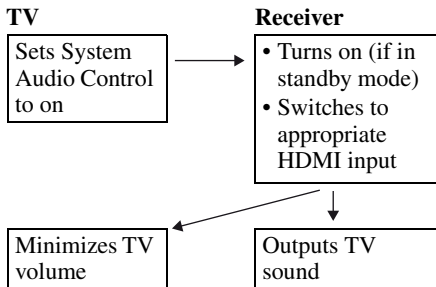

You can also use the System Audio Control function as follows.

- If you turn on the receiver while the TV is turned on, the System Audio Control function will automatically activate to output TV sound through the speakers connected to the receiver. However, if you turn off the receiver, the sound will output from the TV speakers.

- When you adjust the TV volume, the System Audio Control function adjusts the receiver’s volume simultaneously.

Notes

- If System Audio Control does not function according to your TV setting, refer to the operating instructions of the TV.
- When “Ctrl for HDMI” is set to “ON”, the “Audio Out” settings in the HDMI Settings menu will set automatically based on the System Audio Control settings.
- If the TV is turned on before turning on the receiver, the TV will momentarily lose the sound output.

Turning off the receiver with the TV (System Power-Off)

When you turn the TV off, using the POWER button on the TV’s remote control, the receiver and the connected equipment turn off automatically.

You can also use the receiver’s remote control to turn off the TV.

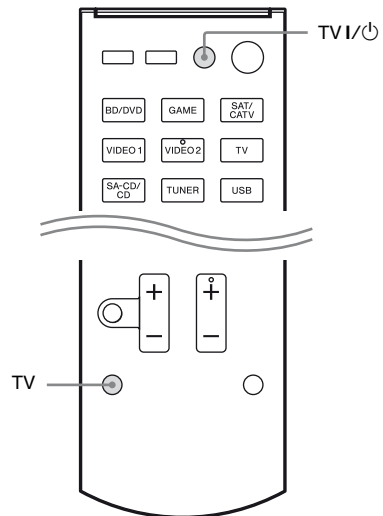

Hold down TV, then press TV I/⏻.

The TV, receiver and the equipment connected via HDMI are turned off.

Notes

- Set the TV power supply interlock function to “ON” before using the System Power-Off function. For details, refer to the operating instructions of the TV.
- Depending on the condition of the connected equipment, it may not be turned off. For details, refer to the operating instructions of the connected equipment.

Enjoying optimum sound field for the selected scene (Scene Select)

The Scene Select function allows you to enjoy the optimum picture quality and switches the sound field according to the selected scene on your TV.

For details on the operation, refer to the operating instructions of the TV.

Note

The sound field may not switch depending on the TV.

Correspondence table

Scene setting on the TV	Sound field
Cinema	HD-D.C.S.
Sports	Sports
Music	Live Concert
Animation	A.F.D. Auto
Photo	A.F.D. Auto
Game	A.F.D. Auto
Graphics	A.F.D. Auto

Other Operations

Switching between digital and analog audio (INPUT MODE)

When you connect equipment to both digital and analog audio input jacks on the receiver, you can fix the audio input mode to either of them, or switch from one to the other, depending on the type of material you intend to watch.

1 Turn INPUT SELECTOR on the receiver to select the input.

You can also use the input buttons on the remote control.

2 Press INPUT MODE repeatedly on the receiver to select the audio input mode.

The selected audio input mode appears on the display panel.

- **AUTO:** Gives priority to digital audio signals. If there are more than one digital connection, HDMI audio signals have priority.

If there are no digital audio signals, analog audio signals are selected. When TV input is selected, priority is given to the Audio Return Channel (ARC) signals. If your TV is not compatible with the Audio Return Channel (ARC) function, the digital optical audio signals are selected.

- **COAX:** Specifies the digital audio signals input to the DIGITAL COAXIAL jack.
- **OPT:** Specifies the digital audio signals input to the DIGITAL OPTICAL jack.
- **ANALOG:** Specifies the analog audio signals input to the AUDIO IN (L/R) jacks.

continued

Notes

- Some audio input modes may not be set up based on the input.
- When the USB input is selected, “-----” appears on the display panel, and you cannot change to other modes. Select another input, then set the audio input mode.
- When “A. DIRECT” is being used, audio input is set to “ANALOG”. You cannot select other modes.
- The Audio Return Channel (ARC) function does not work in the following cases.
 - Your TV is not compatible with the Audio Return Channel (ARC) function.
 - “Ctrl for HDMI” is set to “OFF”.
 - When you do not connect the receiver to the ARC compatible TV’s HDMI jack via an HDMI cable.

Using the sound/images from other inputs (Input Assign)

You can reassign audio and/or video signals to another input when they are not currently being used.

After you have reassigned the input jacks, you can use the input button (or INPUT SELECTOR on the receiver) to select the equipment you connected.

Component video and digital audio input assign

You can reassign the COMPONENT VIDEO and DIGITAL input jacks to other input if the default settings of the jacks do not correspond to your connected equipment.

Example:

When you connect the DVD player to the OPTICAL SAT/CATV IN and COMPONENT VIDEO SAT/CATV (IN 2) jacks.

- Assign the OPTICAL SAT/CATV IN jack to “BD/DVD”
- Assign the COMPONENT VIDEO SAT/CATV (IN 2) jacks to “BD/DVD”

1 Press GUI MODE.

Press MENU if the GUI menu does not appear on the TV screen.

2 Select “ Input”, then press or .

3 Select the input name you want to assign.

4 Press TOOLS/OPTIONS.

The option menu appears.

5 Select “Input Assign”, then press or .

The “Input Assign” screen appears.

6 Select the audio and/or video signals you want to assign to the input which you selected in step 3 using ///.

7 Press .

Input name		BD/DVD	GAME	SAT/CATV	VIDEO1	VIDEO2	SA-CD/CD
Assignable video input jacks	COMP.1	○*	○	○	○	○	○
	COMP.2	○	○	○*	○	○	○
	CVBS	–	–	○	○*	○*	–
	NONE	○	○*	–	–	–	○*
Assignable audio input jacks	BD COAX	○*	○	○	○	○	○
	SAT OPT	○	○	○*	○	○	○
	ANALOG	–	–	○	○*	○*	○*
	NONE	○	○*	–	–	–	–

* Default setting

Notes

- When you assign the digital audio input, the INPUT MODE setting may change automatically.
- One reassignment is allowed for each input.

Adjusting Settings

Using the Settings menu

You can adjust various settings for speakers, surround effects, etc. using the Settings menu. To display the menu of the receiver on the TV screen, make sure that the receiver is in “GUI MODE” by following the steps in “To turn “GUI MODE” on and off” (page 39).

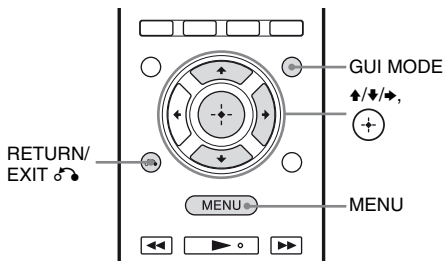

1 Press GUI MODE.

Press MENU if the GUI menu does not appear on the TV screen.

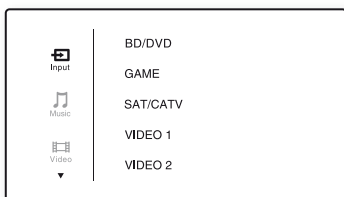

2 Select “Settings” from the menu, then press \oplus or \rightarrow to enter the menu mode.

The Settings menu list appears on the TV screen.

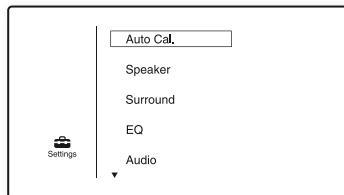

3 Select the menu item you want, then press \oplus .

Example: When you select “Auto Cal.”.

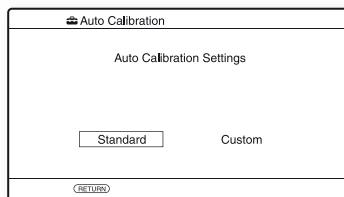

4 Select the parameter you want, then press \oplus .

To return to the previous screen

Press RETURN/EXIT \leftarrow .

To exit the menu

Press MENU.

Settings menu list

Settings menu	Description
Auto Cal.	Sets the speaker level or distance and makes the measurement automatically (page 33).
Speaker	Sets the speaker position manually (page 63).
Surround	Selects the sound field and adjusts the surround effect you choose (page 65).
EQ	Adjusts the equalizer (bass/treble sound) (page 66).
Audio	Sets various sound items (page 66).
HDMI	Makes settings for sound/images from equipment connected to the HDMI jacks (page 67).
System	Makes settings for the system of the receiver (page 67).

Speaker Settings menu

You can adjust each speaker manually.
You can also adjust the speaker levels after the Auto Calibration is completed.

Note

The speaker settings are only for the current seating position.

■ SP Pattern (Speaker pattern)

Select “SP Pattern” according to the speaker system which you are using. Select the speaker pattern before you perform Auto Calibration.

■ Manual Setup

You can adjust each speaker manually on the “Manual Setup” screen. You can also adjust the speaker levels after the Auto Calibration is completed.

To adjust the speaker level

You can adjust each speaker’s level (front left/right, front left/right high, center, surround left/right, surround back left/right, subwoofer).

- 1 Select the speaker on the screen for which you want to adjust the level, then press (+).
- 2 Select “Lvl”.
- 3 Set the level of the selected speaker, then press (+).
You can adjust the level from –10.0 dB to +10.0 dB in 0.5 dB intervals.

Note

When one of the sound fields for music is selected, no sound is output from the subwoofer if all the speakers are set to “Large” in the Speaker Settings menu. However, the sound will be output from the subwoofer if

- the digital input signal contains LFE signals.
- the front or surround speakers are set to “Small”.
- “MULTI ST.”, “PLIIX MV”, “PLIIX MS”, “PLIIX MV”, “PLIIX MS”, “PLIIZ”, “HD-D.C.S.” or “P. AUDIO” is selected.

To adjust the distance from the seating position to each speaker

You can adjust the distance from the seating position to each speaker (front left/right, front left/right high, center, surround left/right, surround back left/right, subwoofer).

- 1 Select the speaker on the screen for which you want to adjust the distance from the seating position, then press (+).
- 2 Select “Dist”.

3 Set the distance of the selected speaker, then press (+).

You can adjust the distance from 1 m 0 cm to 10 m 0 cm (3 ft 3 in to 32 ft 9 in) in 10 cm (1 in) intervals.

Tip

You can adjust the distance in 1 cm interval when you have performed the Auto Calibration and saved the measurement result.

Notes

- Depending on the speaker pattern setting, some parameters may not be available.
- This function does not work when "A. DIRECT" is being used.

To adjust the size of each speaker

You can adjust each speaker's (front left/right, front left/right high, center, surround left/right, surround back left/right) size.

1 Select the speaker on the screen for which you want to adjust the size, then press (+).

2 Select "Size".

3 Set the size of the selected speaker, then press (+).

- **Large:** If you connect large speakers that will effectively reproduce bass frequencies, select "Large". Normally, select "Large".
- **Small:** If the sound is distorted, or you feel a lack of surround effects when using multi channel surround sound, select "Small" to activate the bass redirection circuitry and output the bass frequencies of each channel from the subwoofer or other "Large" speakers.

Note

This function does not work when "A. DIRECT" is being used.

Tips

- The "Large" and "Small" settings for each speaker determine whether the internal sound processor will cut the bass signal from that channel. When the bass is cut from a channel, the bass redirection circuitry sends the corresponding bass frequencies to the subwoofer or other "Large" speakers. However, since bass sound has a certain amount of directionality, it is best not to cut it, if possible. Therefore, even when using small speakers, you can set them to "Large" if you want to output the bass frequencies from that speaker. On the other hand, if you are using a large speaker, but prefer not to have bass frequencies output from that speaker, set it to "Small". If the overall sound level is lower than you prefer, set all speakers to "Large". If there is not enough bass, you can use the equalizer to boost the bass levels.
- The surround back speakers will be set to the same setting as that of the surround speakers.
- When the front speakers are set to "Small", the center, surround, and surround back/front high speakers are also automatically set to "Small".
- If you do not use the subwoofer, the front speakers are automatically set to "Large".

■ Crossover Freq (Speaker crossover frequency)

Lets you set the bass crossover frequency of speakers that the speaker size has been set to "Small" in the Speaker Settings menu. Measured speaker crossover frequency is set for each speaker after the Auto Calibration.

1 Select the speaker on the screen for which you want to adjust the crossover frequency, then press (+).

2 Adjust the value, then press (+).

■ Test Tone

You can select the test tone type on the "Test Tone" screen.

Tips

- To adjust the level of all speakers at the same time, press MASTER VOL +/- or \triangle +/- . You can also use MASTER VOLUME on the receiver.
- The adjusted value is shown on the TV screen during adjustment.

To output test tone from each speaker

You can output test tone from the speakers in sequence.

- 1 Select “Test Tone”, then press \odot or \blacktriangleright .
- 2 Adjust the parameter, then press \odot .
 - **OFF**
 - **AUTO:** The test tone is output from each speaker in sequence.
- 3 Adjust the speaker level, then press \oplus .

■ D.Range Comp (Dynamic range compression)

Lets you compress the dynamic range of the soundtrack. This may be useful when you want to watch movies at low volumes late at night. Dynamic range compression is possible with Dolby Digital sources only.

- **MAX:** The dynamic range is compressed dramatically.
- **STD:** The dynamic range is compressed as intended by the recording engineer.
- **AUTO:** The dynamic range is applied automatically with Dolby TrueHD source or other source is set to “OFF”.
- **OFF:** The dynamic range is not compressed.

Tip

“STD” is the standard setting, and enacts light compression. Therefore, we recommend using the “MAX” setting. This greatly compresses the dynamic range and lets you view movies late at night at low volumes. Unlike analog limiters, the levels are predetermined and provide a very natural compression.

■ Distance Unit

Lets you select the unit of measurement for setting distances.

- **FEET:** The distance is displayed in feet.
- **METER:** The distance is displayed in meters.

Surround Settings menu

You can select the sound field and adjust the effect level, etc. on the “Sound Field Setup” screen.

For details on the sound field, see “Enjoying Sound Effects” (page 51).

Note

The setup items you can adjust on each menu vary depending on the sound field.

To adjust the effect type for HD-D.C.S.

- 1 Select “HD-D.C.S.”, then press \odot or \blacktriangleright .
- 2 Select the effect you want, then press \odot .

HD-D.C.S. has three different types:

Theater, Dynamic and Studio. Each type has different reflection and reverberation sound mixture levels and is optimized to match a listener’s room uniqueness, taste and mood.

• Dynamic

Want to enjoy the sound effects to the full extent, just like at the movie theaters?

Dynamic type emphasizes on the reflection sound. Without HD-D.C.S., many rooms are often somewhat reverberant but lack a spacious feeling. This type acoustically opens up those types of rooms and provides a spacious and dynamism feeling equivalent to a mastering studio.

continued

• Theater

Theater type (default setting) mixes reflection and reverberation sound creating the characteristics of a mastering studio. Additionally, this type mixes in frequency characteristics that are often found in professional studios and movie theaters. It is ideal for watching movies in a listening room that has less reverberation.

• Studio

In Studio type, effects are kept to a minimum, while still providing a great theater experience. This type provides the accuracy of the original recording.

EQ Settings menu

You can use the following parameters to adjust the tonal quality (bass/treble level) of front speakers.

- Bass
- Treble

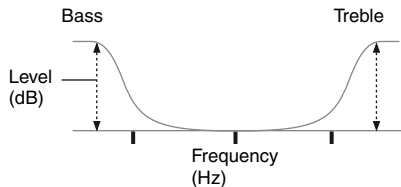

Note

This function does not work when “A. DIRECT” is being used.

Tip

You can also adjust the front speaker bass and treble level with TONE MODE and TONE on the receiver (page 9).

Audio Settings menu

You can adjust settings for the audio to suit your preference.

■ A/V Sync (Synchronizes audio with video output)

Lets you delay the output of audio to minimize the time gap between audio output and visual display.

- **ON (Delay time: 60 ms):** The audio output is delayed so that the time gap between the audio output and visual display is minimized.
- **OFF (Delay time: 0 ms):** The audio output is not delayed.

Notes

- This function is useful when you use a large LCD or plasma monitor or a projector.
- This function does not work when “A. DIRECT” is being used.
- The delay time may vary depending on audio format, sound field, speaker pattern and speaker distance settings.

■ Dual Mono (Digital broadcast language selection)

Lets you select the language you want when you listen to the dual audio of a digital broadcast when available. This feature only functions for Dolby Digital sources.

- **MAIN/SUB:** Sound of the main language will be output through the front left speaker and sound of the sub language will be output through the front right speaker simultaneously.
- **MAIN:** Sound of the main language will be output.
- **SUB:** Sound of the sub language will be output.

■ Night Mode

Lets you retain a theater-like environment at low volume levels (page 9).

- **ON**
- **OFF**

HDMI Settings menu

You can make the required settings for equipment connected to the HDMI jack.

■ Ctrl for HDMI (Control for HDMI)

Lets you turn the Control for HDMI function on or off. For details, see “Preparing for the “BRAVIA” Sync” (page 56).

- **ON**
- **OFF**

Note

When you set “Ctrl for HDMI” to “ON”, “Audio Out” may be changed automatically.

■ Pass Through

Lets you output the HDMI signals to the TV even when the receiver is in standby mode.

- **ON:** When the receiver is in the standby mode, the receiver continuously outputs HDMI signals from the receiver’s HDMI TV OUT jack.
- **AUTO:** When the TV is turned on while the receiver is in the standby mode, the receiver outputs HDMI signals from the receiver’s HDMI TV OUT jack. Sony recommends this setting if you use a “BRAVIA” Sync compatible Sony TV. This setting saves power in the standby mode when compared with the “ON” setting.
- **OFF:** The receiver does not output HDMI signals when the receiver is in the standby mode. Turn on the receiver to enjoy the connected equipment’s source on the TV. This setting saves power in the standby mode when compared with the “ON” setting.

Notes

- This function is not available when “Ctrl for HDMI” is set to “OFF”.
- When “AUTO” is selected, it may take a little more time for the image and sound to be output to the TV than when “ON” is selected.

- When the receiver is in standby mode, “A.STANDBY” appears on the display panel if “Pass Through” is set to “AUTO” or “ON”. However, “A.STANDBY” will disappear when “Pass Through” is set to “AUTO” and no signals are detected.

■ Audio Out

Lets you set the HDMI audio signals output from the playback equipment connected to the receiver via an HDMI connection.

- **AMP:** The HDMI audio signals from the playback equipment is only output to the speakers connected to the receiver. Multi channel sound can be played back as it is.
- **TV+AMP:** The sound is output from TV’s speaker and the speakers connected to the receiver.

Notes

- The sound quality of the playback equipment depends on the TV’s sound quality, such as the number of channels, and the sampling frequency, etc. If the TV has stereo speakers, the sound output from the receiver is also in stereo as that of the TV, even if you play back multi channel source.
- When you connect the receiver to an image display equipment (projector, etc.), sound may not be output from the receiver. In this case, select “AMP”.

System Settings menu

You can customize the settings of the receiver.

■ Auto Standby

Lets you set the receiver switch to standby mode automatically when you do not operate the receiver or when there is no signals input to the receiver.

- **ON:** Switches to standby mode after approximately 30 minutes.
- **OFF:** Does not switch to standby mode.

continued

67^{GB}

Notes

- This function does not work when TUNER input is selected.
- If you use the Auto standby mode and the Sleep Timer at the same time, the Sleep Timer has priority.

Operating without connecting to a TV

You can operate this receiver using the display panel even if the TV is not connected to the receiver.

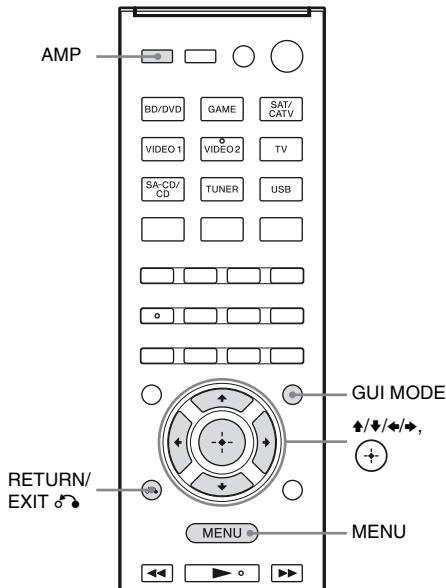

Using the menu on the display panel

Press **GUI MODE** repeatedly to select “GUI OFF”.

The receiver is switched to front panel display mode.

- 1** Press **AMP**.
- 2** Press **MENU**.
- 3** Press **↑/↓** repeatedly to select the menu you want, then press **+** or **→**.
- 4** Press **↑/↓** repeatedly to select the parameter you want to adjust, then press **+** or **→**.
- 5** Press **↑/↓** repeatedly to select the setting you want, then press **+**.

To return to the previous display

Press **←** or **RETURN/EXIT** .

To exit the menu

Press **MENU**.

Note

Some parameters and settings may appear dimmed on the display panel. This means that they are either unavailable or fixed and unchangeable.

Overview of the menus

The following options are available in each menu. For details on navigating through menus, see page 68.

Menu [Display]	Parameters [Display]	Settings	Default setting
Auto Calibration settings [<A. CAL>]	Auto Calibration (Standard) [STANDARD]		
	Auto Calibration (Custom) [CUSTOM]	FULL.FLAT, ENGINEER, FRONT.REF, OFF	ENGINEER
Level settings [<LEVEL>]	Test tone ^{a)} [T. TONE]	AUTO ■■■ ^{b)} , OFF	OFF
	Front left speaker level ^{a)} [FL LVL]	FL -10.0 dB to FL +10.0 dB (0.5 dB interval)	FL 0 dB
	Front right speaker level ^{a)} [FR LVL]	FR -10.0 dB to FR +10.0 dB (0.5 dB interval)	FR 0 dB
	Center speaker level ^{a)} [CNT LVL]	CNT -10.0 dB to CNT +10.0 dB (0.5 dB interval)	CNT 0 dB
	Surround left speaker level ^{a)} [SL LVL]	SL -10.0 dB to SL +10.0 dB (0.5 dB interval)	SL 0 dB
	Surround right speaker level ^{a)} [SR LVL]	SR -10.0 dB to SR +10.0 dB (0.5 dB interval)	SR 0 dB
	Surround back speaker level ^{a)} [SB LVL]	SB -10.0 dB to SB +10.0 dB (0.5 dB interval)	SB 0 dB
	Surround back left speaker level ^{a)} [SBL LVL]	SBL -10.0 dB to SBL +10.0 dB (0.5 dB interval)	SBL 0 dB
	Surround back right speaker level ^{a)} [SBR LVL]	SBR -10.0 dB to SBR +10.0 dB (0.5 dB interval)	SBR 0 dB
	Front left high speaker level ^{a)} [LH LVL]	LH -10.0 dB to LH +10.0 dB (0.5 dB interval)	LH 0 dB
	Front right high speaker level ^{a)} [RH LVL]	RH -10.0 dB to RH +10.0 dB (0.5 dB interval)	RH 0 dB
	Subwoofer level ^{a)} [SW LVL]	SW -10.0 dB to SW +10.0 dB (0.5 dB interval)	SW 0 dB
	Dynamic range compression [D. RANGE]	COMP. MAX, COMP. STD, COMP.AUTO, COMP. OFF	COMP.AUTO
	Speaker settings [<SPKR>]	Speaker pattern [PATTERN]	5/2.1 to 2/0 (20 patterns)
Front speakers size ^{a)} [FRT SIZE]		LARGE, SMALL	LARGE
Center speaker size ^{a)} [CNT SIZE]		LARGE, SMALL	LARGE
Surround speakers size ^{a)} [SUR SIZE]		LARGE, SMALL	LARGE

continued

Menu [Display]	Parameters [Display]	Settings	Default setting
	Front high speakers size ^{a)} [FH SIZE]	LARGE, SMALL	LARGE
	Front left speaker distance ^{a)} [FL DIST.]		
	Front right speaker distance ^{a)} [FR DIST.]		
	Center speaker distance ^{a)} [CNT DIST.]		
	Surround left speaker distance ^{a)} [SL DIST.]		
	Surround right speaker distance ^{a)} [SR DIST.]		
	Surround back speaker distance ^{a)} [SB DIST.]		
	Surround back left speaker distance ^{a)} [SBL DIST.]	1.00 m to 10.00 m (0.1 m interval) ^{c)} 3'3" to 32'9" (1 inch interval)	3.00 m 9'10"
	Surround back right speaker distance ^{a)} [SBR DIST.]		
	Front left high speaker distance ^{a)} [LH DIST.]		
	Front right high speaker distance ^{a)} [RH DIST.]		
	Subwoofer distance ^{a)} [SW DIST.]		
	Distance unit [DIST.UNIT]	METER, FEET	METER ^{d)}
	Front speakers crossover frequency ^{e)} [FRT CRS.]	CRS. 40 Hz to CRS. 200 Hz (10 Hz interval)	CRS. 120 Hz
	Center speaker crossover frequency ^{e)} [CNT CRS.]	CRS. 40 Hz to CRS. 200 Hz (10 Hz interval)	CRS. 120 Hz
	Surround speakers crossover frequency ^{e)} [SUR CRS.]	CRS. 40 Hz to CRS. 200 Hz (10 Hz interval)	CRS. 120 Hz
	Front high speakers crossover frequency ^{e)} [FH CRS.]	CRS. 40 Hz to CRS. 200 Hz (10 Hz interval)	CRS. 120 Hz
Surround settings [<SURR>]	Effect level ^{f)} [EFFECT]	DYNAMIC, THEATER, STUDIO	THEATER
EQ settings [<EQ>]	Front speakers bass level [BASS]	BASS -10 dB to BASS +10 dB (1 dB interval)	BASS 0 dB
	Front speakers treble level [TREBLE]	TRE -10 dB to TRE +10 dB (1 dB interval)	TRE 0 dB

Menu [Display]	Parameters [Display]	Settings	Default setting
Tuner settings [<TUNER>]	FM station receiving mode [FM MODE]	STEREO, MONO	STEREO
	Naming preset stations [NAME IN]	For details, see “Naming preset stations (Name Input)” (page 50).	
Audio settings [<AUDIO>]	Synchronizes audio with video output [A/V SYNC]	SYNC ON, SYNC OFF	SYNC OFF
	Digital broadcast language selection [DUAL]	MAIN/SUB, MAIN, SUB	MAIN
	Digital audio input assignment [A. ASSIGN]	For details, see “Using the sound/ images from other inputs (Input Assign)” (page 60).	
	Night mode [NIGHT M.]	NIGHT. ON, NIGHT.OFF	NIGHT.OFF
Video settings [<VIDEO>]	Video input assignment [V. ASSIGN]	For details, see “Using the sound/ images from other inputs (Input Assign)” (page 60).	
HDMI settings [<HDMI>]	Control for HDMI [CTRL.HDMI]	CTRL ON, CTRL OFF	CTRL ON
	Pass Through [PASS.THRU]	ON, AUTO, OFF	OFF
	Audio out [AUDIO.OUT]	AMP, TV+AMP	AMP
System settings [<SYSTEM>]	Auto standby mode [AUTO.STBY]	STBY ON, STBY OFF	STBY ON
	Naming inputs [NAME IN]	For details, see “Naming the input (Name Input)” (page 41).	

a) Depends on the speaker pattern setting, some parameters or settings may not be available.

b) ■■■ represent a speaker channel (FL, FR, CNT, SL, SR, SB, SBL, SBR, LH, RH, SW).

c) You can adjust the distance in 0.01 meter interval when you have performed the Auto Calibration and saved the measurement result.

d) “FEET” for USA and Canada models.

e) You can only select this parameter if your speaker is set to “SMALL”.

f) You can only select this parameter if you select “HD-D.C.S.” as sound field.

To view the information on the display panel

The display panel provides various information of the receiver status such as sound field.

- 1 Select the input for which you want to check the information.
- 2 Press AMP, then press DISPLAY repeatedly.
Each time you press DISPLAY, the display will change cyclically as follows.

Index name of the input* → Input you selected → Sound field currently applied → Volume level → Stream information**

When listening to FM and AM radio

Preset station name* → Frequency → Sound field currently applied → Volume level

When receiving RDS broadcasts (Europe, Australia and Taiwan models only)

Program Service name or preset station name* → Frequency, band and preset number → Sound field currently applied → Volume level

* Index name appears only when you have assigned one to the input or preset station.
Index name does not appear when only blank spaces have been entered or it is same as the input name.

**Stream information may not be displayed.

Note

Character or marks may not be displayed for some languages.

Tip

You cannot switch the display while "GUI MODE" is shown on the display panel. Press GUI MODE repeatedly to select "GUI OFF".

Using the Remote Control

Reassigning the input button

You can change the default settings of the input buttons to suit the equipment in your system. For example, if you connect a Blu-ray Disc player to the SAT/CATV jack on the receiver, you can set the SAT/CATV button on this remote to control the Blu-ray Disc player.

Note

You cannot reassign the TV, TUNER and USB input buttons.

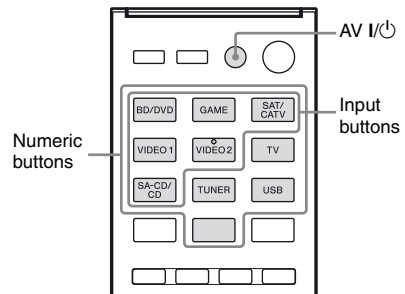

- 1 While holding down the input button of which you want to change the assignment, hold down AV I/O.

Example: While holding down SAT/CATV, hold down AV I/O.

- 2 With the AV I/O button held, release the input button.

Example: With the AV I/O button held, release SAT/CATV.

3 Referring to the following table, press the corresponding button for the category you want, then release AV I/⏻.

Example: Press 1, then release AV I/⏻. Now you can use the SAT/CATV button to control the Blu-ray Disc player.

Categories	Press
Blu-ray Disc player (command mode BD1) ^{a)}	1
Blu-ray Disc recorder (command mode BD3) ^{a)}	2
DVD player (command mode DVD1)	3
DVD recorder (command mode DVD3) ^{b)}	4
VCR (command mode VTR3) ^{c)}	5
CD player	6
DSS (Digital Satellite Receiver) ^{d)} /Euro Digital Satellite Receiver ^{e)}	7

^{a)}For details on the BD1 or BD3 setting, refer to the operating instructions supplied with the Blu-ray Disc player or Blu-ray Disc recorder.

^{b)}Sony DVD recorders are operated with a DVD1 or DVD3 setting. For details, refer to the operating instructions supplied with the DVD recorders.

^{c)}Sony VCRs are operated with a VTR 3 setting which corresponds to VHS.

^{d)}USA, Canada and Mexico models only.

^{e)}Other models.

Resetting the input buttons

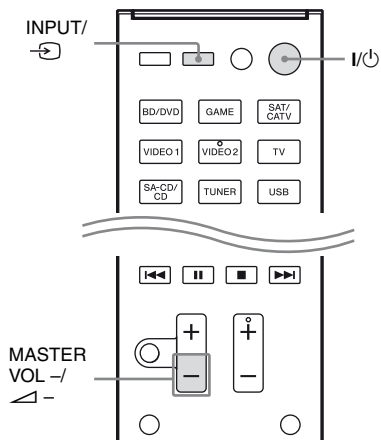

1 While holding down **MASTER VOL -** or **◀ -**, press **I/⏻** and **INPUT** or **→**.

2 Release all buttons.

The input buttons are reset to the default settings.

Precautions

On safety

Should any solid object or liquid fall into the cabinet, unplug the receiver and have it checked by qualified personnel before operating it any further.

On power sources

- Before operating the receiver, check that the operating voltage is identical with your local power supply.

The operating voltage is indicated on the nameplate on the back of the receiver.

- The unit is not disconnected from the AC power source (mains) as long as it is connected to the wall outlet, even if the unit itself has been turned off.
- If you are not going to use the receiver for a long time, be sure to disconnect the receiver from the wall outlet. To disconnect the AC power cord (mains lead), grasp the plug itself; never pull the cord.
- (USA and Canada models only)
One blade of the plug is wider than the other for the purpose of safety and will fit into the wall outlet only one way. If you are unable to insert the plug fully into the outlet, contact your dealer.
- The AC power cord (mains lead) must be changed only at a qualified service shop.

On heat buildup

Although the receiver heats up during operation, this is not a malfunction. If you continuously use this receiver at a large volume, the cabinet temperature of the top, side and bottom rises considerably. To avoid burning yourself, do not touch the cabinet.

On placement

- Place the receiver in a location with adequate ventilation to prevent heat buildup and prolong the life of the receiver.
- Do not place the receiver near heat sources, or in a place subject to direct sunlight, excessive dust, or mechanical shock.
- Do not place anything on top of the cabinet that might block the ventilation holes and cause malfunctions.
- Do not place the receiver near equipment such as a TV, VCR, or tape deck. (If the receiver is being used in combination with a TV, VCR, or tape deck, and is placed too close to that equipment, noise may result, and picture quality may suffer. This is especially likely when using an indoor antenna (aerial). Therefore, we recommend using an outdoor antenna (aerial).)
- Use caution when placing the receiver on surfaces that have been specially treated (with wax, oil, polish, etc.) as staining or discoloration of the surface may result.

On operation

Before connecting other equipment, be sure to turn off and unplug the receiver.

On cleaning

Clean the cabinet, panel, and controls with a soft cloth slightly moistened with a mild detergent solution. Do not use any type of abrasive pad, scouring powder, or solvent, such as alcohol or benzine.

If you have any questions or problems concerning your receiver, please consult your nearest Sony dealer.

Troubleshooting

If you experience any of the following difficulties while using the receiver, use this troubleshooting guide to help you remedy the problem. Should any problem persist, consult your nearest Sony dealer. Note that if service personnel changes some parts during repair, these parts may be retained.

Power

The receiver is turned off automatically.

- “Auto Standby” is set to “ON” (page 67).
 - The Sleep Timer function is working (page 14).
-

Image

No image appears on the TV.

- Select the appropriate input using the input buttons.
- Set your TV to the appropriate input mode.
- Move your audio equipment away from the TV.
- Assign the component video input correctly.
- The input signal should be same as the input function when you are up-converting an input signal with this receiver (page 29).
- Make sure that cables are correctly and securely connected to equipment.
- Depending on the playback equipment, you may need to set up the equipment. Refer to the operating instructions supplied with each equipment.
- Be sure to use a High Speed HDMI cable when you view images or listen to sound, especially for the 1080p, Deep Color (Deep Colour) or 3D transmission.

No 3D image appears on the TV.

- Depending on the TV or the video equipment, 3D images may not be displayed.
-

When the receiver is in standby mode, there is no image output from the TV.

- When the receiver enters into standby mode, image is from the last HDMI equipment selection before you turned off the receiver. If you are enjoying other equipment, play the equipment and perform the One-Touch Play operation, or turn on the receiver to select the HDMI equipment you want to enjoy.
 - Make sure “Pass Through” is set to “ON” in the HDMI Settings menu if you connect equipment not compatible with the “BRAVIA” Sync to the receiver (page 67).
-

Recording cannot be carried out.

- Check that the equipment is connected correctly.
 - Select the source equipment using the input buttons (page 40).
 - Video input signals via HDMI IN and COMPONENT VIDEO IN jacks cannot be recorded.
 - Copyright protection to prevent recording is contained in the sources. In this case, you may not be able to record from the sources.
-

The GUI menu does not appear on the TV screen.

- Press GUI MODE repeatedly to select “GUI ON”. If the GUI menu still does not appear on the TV screen, press MENU.
 - Check that the TV is connected correctly.
-

Sound

There is no sound, no matter which equipment is selected, or only a very low-level sound is heard.

- Check that all connecting cords are inserted to their input/output jacks for the respective jacks of the receiver, speakers and the equipment.
- Check that both the receiver and all equipment are turned on.
- Check that MASTER VOLUME control is not set to “VOL MIN”.
- Check that the SPEAKERS is not set to “SPK OFF” (page 9).
- Check that headphones are not connected to the receiver.
- Press MUTING or  on the remote control to cancel the muting function.
- Try pressing the input button on the remote control or turning the INPUT SELECTOR on the receiver to select the equipment of your choice (page 40).
- When you want to listen to the sound from the TV speaker, set the “Audio Out” to “TV+AMP” in the HDMI Settings menu (page 67). If you cannot play back multi channel audio source, set to “AMP”. However, the sound will not output through the TV speaker.
- Sound may be interrupted when the sampling frequency, the number of channels or audio format of audio output signals from the playback equipment is switched.

There is severe hum or noise.

- Check that the speakers and equipment are connected securely.
- Check that the connecting cords are away from a transformer or motor, and at least 3 meters (10 feet) away from a TV set or fluorescent light.
- Move your audio equipment away from the TV.
- The plugs and jacks are dirty. Wipe them with a cloth slightly moistened with alcohol.

There is no sound, or only a very low level sound is heard from specific speakers.

- Connect a pair of headphones to the PHONES jack to verify that sound is output from the headphones. If only one channel is output from the headphones, the equipment may not be connected to the receiver correctly. Check that all the cords are fully inserted into the jacks on both the receiver and the equipment. If both channels are output from the headphones, the front speaker may not be connected to the receiver correctly. Check the connection of the front speaker which is not outputting any sound.
- Make sure you have connected to both the L and R jacks of an analog equipment, analog equipment requires both L and R jack connections. Use an audio cord (not supplied).
- Adjust the speaker level (page 63).
- Make sure the center/surround speaker(s) is (are) set to either “Small” or “Large”.
- Check that the speaker settings are appropriate for the setup using the Auto Calibration menu or “SP Pattern” in the Speaker Settings menu. Then check that sound is output from each speaker correctly, using “Test Tone” in the Speaker Settings menu.
- Some discs have no Dolby Digital Surround EX information.
- Check that the subwoofer is connected correctly and securely.
- Make sure you have turned on your subwoofer.
- Depending on the selected sound field, no sound will be available from the subwoofer.
- When all speakers are set to “Large” and “NEO6 CIN” or “NEO6 MUS” is selected, there is no sound from the subwoofer.

There is no sound from a specific equipment.

- Check that the equipment is connected correctly to the audio input jacks for that equipment.
- Check that the cord(s) used for the connection is (are) fully inserted into the jacks on both the receiver and the equipment.
- Check the INPUT MODE (page 59).
- Check that the equipment is connected correctly to the HDMI jack for that equipment.
- You cannot listen to the Super Audio CD by connecting HDMI.
- Depending on the playback equipment, you may need to set up the HDMI setting of the equipment. Refer to the operating instructions supplied with each equipment.
- Be sure to use a High Speed HDMI cable when you view images or listen to sound, especially for the 1080p, Deep Color (Deep Colour) or 3D transmission.
- Sound may not be output from the receiver while the GUI appears on the TV screen. Press GUI MODE to select “GUI OFF”.
- Audio signals (format, sampling frequency, bit length, etc.) transmitted from an HDMI jack may be suppressed by the connected equipment. Check the setup of the connected equipment if the image is poor or the sound does not come out of the equipment connected via the HDMI cable.
- When the connected equipment is not compatible with copyright protection technology (HDCP), the image and/or the sound from the HDMI TV OUT jack may be distorted or may not be output. If this is the case, check the specification of the connected equipment.
- Set the image resolution of the playback equipment to more than 720p/1080i to enjoy High Bitrate Audio (DTS-HD Master Audio, Dolby TrueHD).
- The image resolution of the playback equipment may need to be at certain settings before you can enjoy Multi Channel Linear PCM. Refer to the operating instructions of the playback equipment.
- Make sure the TV is compatible with the System Audio Control function.
- If the TV does not have System Audio Control function, set the “Audio Out” settings in HDMI Settings menu to
 - “TV+AMP” if you want to listen to the sound from the TV speaker and receiver.
 - “AMP” if you want to listen to the sound from the receiver.
- When you connect the receiver to a video equipment (projector, etc.), sound may not be output from the receiver. In this case, set the “Audio Out” to “AMP” in the HDMI Settings menu (page 67).
- If you cannot listen to the sound of the equipment connected to the receiver while TV input is selected on the receiver
 - Be sure to change the input of the receiver to HDMI when you want to watch a program on the equipment connected via HDMI connection to the receiver.
 - Change the TV channel when you want to watch a TV broadcast.
 - Be sure to select the correct equipment or input you want when you watch a program from the equipment connected to the TV. Refer to the operating instructions of the TV on this operation.
- Check that the “A. DIRECT” is not being used.
- When using the Control for HDMI function, you cannot control the connected equipment using TV’s remote control.
 - Depending on the connected equipment and TV, you may need to set up the equipment and TV. Refer to the operating instructions supplied with each equipment and TV.
 - Change the input of the receiver to the HDMI input connected to the equipment.

continued

- Check that the selected digital audio input jack is not reassigned to other inputs (page 60).

The left and right sounds are unbalanced or reversed.

- Check that the speakers and equipment are connected correctly and securely.
- Adjust the sound level parameters using the Speaker Settings menu.

Dolby Digital or DTS multi channel sound is not reproduced.

- Check that the DVD, etc. you are playing is recorded in Dolby Digital or DTS format.
- When connecting the DVD player, etc., to the digital input jacks of this receiver, make sure the digital audio output setting of the connected equipment is available.
- Set “Audio Out” to “AMP” in the HDMI Settings menu (page 67).
- You can enjoy High Bitrate Audio (DTS-HD Master Audio, Dolby TrueHD), Multi Channel Linear PCM only with an HDMI connection.

The surround effect cannot be obtained.

- Make sure you have selected the sound field for movie or music (page 51).
- Sound fields do not function when DTS-HD Master Audio, DTS-HD High Resolution Audio or Dolby TrueHD with sampling frequency of more than 48 kHz are being received.

Recording cannot be carried out.

- Check that the equipment is connected correctly.
- Select the source equipment using the input buttons (page 40).
- Audio input signals via HDMI IN and DIGITAL IN jacks cannot be recorded.
- Copyright protection to prevent recording is contained in the sources. In this case, you may not be able to record from the sources.

A test tone is not output from the speakers

- The speaker cords may not be connected securely. Check to see if they are connected securely and cannot be disconnected by pulling on them slightly.
- The speaker cords may have short-circuit problem.

A test tone is output from a different speaker than the speaker displayed on the TV screen

- The speaker pattern set up is incorrect. Make sure that the speaker connections and the speaker pattern match correctly.

When the receiver is in standby mode, there is no sound output from the TV.

- When the receiver enters into standby mode, sound is from the last HDMI equipment selection before you turned off the receiver. If you are enjoying other equipment, play the equipment and perform the One-Touch Play operation, or turn on the receiver to select the HDMI equipment you want to enjoy.
- Make sure “Pass Through” is set to “ON” in the HDMI Settings menu if you connect equipment not compatible with the “BRAVIA” Sync to the receiver (page 67).

Tuner

The FM reception is poor.

- Use a 75-ohm coaxial cable (not supplied) to connect the receiver to an outdoor FM antenna (aerial) as shown below.

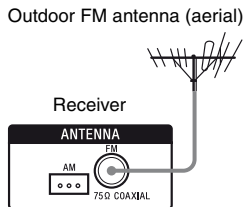

Radio stations cannot be tuned in.

- Check that the antennas (aerials) are connected securely. Adjust the antennas (aerials) and connect an external antenna (aerial), if necessary.
- The signal strength of the stations is too weak with automatic tuning. Use direct tuning.
- Make sure you set the tuning scale correctly (when tuning in AM stations with direct tuning) (page 49).
- No stations have been preset or the preset stations have been cleared (when tuning by scanning preset stations is used). Preset the stations (page 49).
- Press AMP, then press DISPLAY repeatedly on the remote control so that the frequency appears on the display panel.

RDS does not work.*

- Make sure that you are tuned to an FM RDS station.
- Select a stronger FM station.
- The station you tuned to is not transmitting the RDS signal or the signal strength is weak.

The RDS information that you want does not appear.*

- The service may be temporarily out of order. Contact the radio station and find out whether they actually provide the service in question.

* Europe, Australia and Taiwan models only.

iPod/iPhone

The sound is distorted.

- Press MASTER VOL – or  – on the remote control repeatedly.
- Set the “EQ” setting of the iPod/iPhone to “Off” or “Flat”.

There is no sound from the iPod/iPhone.

- Disconnect the iPod/iPhone and connect the iPod/iPhone again.

The iPod/iPhone cannot be charged.

- Check that the receiver is turned on.
- Make sure the iPod/iPhone is connected firmly.

The iPod/iPhone cannot be operated.

- Check that you have removed the protect case of the iPod/iPhone.
- Depending on the contents of the iPod/iPhone, it may take time to start playback.
- Disconnect the iPod/iPhone and connect the iPod/iPhone again.
- You are using an unsupported iPod/iPhone. See “Compatible iPod/iPhone models” (page 42) for the supported device types.

The ring volume of the iPhone does not change.

- Adjust the ring volume using the controls on the iPhone.

USB device

Are you using a supported USB device?

- If you connect an unsupported USB device, the following problems may occur. See “Compatible USB devices” (page 45) for the supported device types.
 - The USB device is not recognized.
 - File or folder names are not displayed on this receiver.
 - Playback is not possible.
 - The sound skips.
 - There is noise.
 - A distorted sound is output.

There is noise, skipping, or distorted sound.

- Turn off the receiver and reconnect the USB device, then turn on the receiver.
- The music data itself contains noise, or the sound is distorted.

The USB device is not recognized.

- Turn off the receiver, then disconnect the USB device. Turn on the receiver again and reconnect the USB device.
- Connect the supported USB device (page 45).
- The USB device does not work properly. Refer to the USB device operating instruction on how to deal with this problem.

Playback does not start.

- Turn off the receiver and reconnect the USB device, then turn on the receiver.
- Connect the supported USB device (page 45).
- Press **▶** to start playback.

The USB device cannot be connected into the  (USB) port.

- The USB device is being connected upside down. Connect the USB device in the correct orientation.

Erroneous display.

- The data stored in the USB device may have been corrupted.
- The character codes that can be displayed by this receiver are as follows:
 - Upper cases (A to Z)
 - Numbers (0 to 9)
 - Symbols (= < > * + , - . / [\] _)Other characters may not be displayed correctly.

“Reading” is displayed for an extended time, or it takes a long time before playback starts.

- The reading process can take a long time in the following cases.
 - There are many folders or files on the USB device.
 - The file structure is extremely complex.
 - The memory capacity is excessive.
 - The internal memory is fragmented.Thus, we recommend following these guidelines.
 - Total folders on USB device: 100 or less (including “ROOT” folder)
 - Total files per folder: 100 or less.

Audio file cannot be played back.

- MP3 files in MP3 PRO format cannot be played back.
- The audio file is a multiple track audio file.
- Some AAC files may not be played back correctly.
- WMA files in Windows Media Audio Lossless and Professional format cannot be played back.
- USB device formatted with file systems other than FAT16 or FAT32 are unsupported.*
- If you use partitioned USB device, only audio files on the first partition can be played back.
- Playback is possible up to 8 levels (including “ROOT” folder).
- The number of folders has exceeded 100 (including “ROOT” folder).
- The number of files in a folder has exceeded 100.
- Files that are encrypted or protected by passwords, etc. cannot be played back.

* This unit supports FAT16 and FAT32, but some USB device may not support all of these FAT. For details, refer to the operating instruction of each USB device or contact the manufacturer.

“BRAVIA” Sync (Control for HDMI)

The Control for HDMI function does not work.

- Check the HDMI connection (page 23).
- Make sure “Ctrl for HDMI” is set to “ON” in HDMI Settings menu.
- Make sure the connected equipment is compatible with the Control for HDMI function.
- Check the Control for HDMI settings on the connected equipment. Refer to the operating instructions of the connected equipment.
- If you unplug the HDMI cable or change the connection, repeat the procedures of “Preparing for the “BRAVIA” Sync” (page 56).
- When “Ctrl for HDMI” is set to “OFF”, the “BRAVIA” Sync does not work properly, even if the equipment is connected to the HDMI IN jack.
- The types and the number of equipment which can be controlled by the “BRAVIA” Sync are restricted in the HDMI CEC standard as follows.
 - Recording equipment (Blu-ray Disc recorder, DVD recorder, etc.): up to 3 equipment
 - Playback equipment (Blu-ray Disc player, DVD player, etc.): up to 3 equipment
 - Tuner-related equipment: up to 4 equipment
 - AV receiver (audio system): up to 1 equipment

Remote control

The remote control does not function.

- Point the remote control at the remote control sensor on the receiver (page 9).
- Remove any obstacles in the path between the remote control and the receiver.

- Replace all the batteries in the remote control with new ones, if they are weak.
- Make sure you select the correct input on the remote control.

Error messages

If there is a malfunction, a message appears on the display panel. You can check the condition of the system by the message. If any problem persists, consult your nearest Sony dealer.

PROTECT

Irregular current is output to the speakers, or the receiver is covered and ventilation holes are blocked. The receiver will automatically turn off after a few seconds. Remove the object covering the upper panel of the receiver, check the speaker connection, and turn on the power again.

USB FAIL

An over current from the  (USB) port was detected.

This receiver will automatically turn off after a few seconds. Check the iPod/iPhone or USB device, then unplug it and turn on the power again.

For other messages, see “Message list after Auto Calibration measurement” (page 37), “iPod/iPhone message list” (page 44) and “USB message list” (page 47).

Clearing the memory

Reference sections

To clear	See
All memorized settings	page 32
Customized sound fields	page 55

Specifications

AUDIO POWER SPECIFICATIONS

POWER OUTPUT AND TOTAL HARMONIC DISTORTION: (USA model only)

With 8 ohm loads, both channels driven, from 20 – 20,000 Hz; rated 95 watts per channel minimum RMS power, with no more than 0.09% total harmonic distortion from 250 milliwatts to rated output.

Amplifier section

USA model¹⁾

Minimum RMS Output Power
(8 ohms, 20 Hz – 20 kHz, THD 0.09%)

95 W + 95 W

Stereo Mode Output Power
(8 ohms, 1 kHz, THD 1%)

105 W + 105 W

Surround Mode Output Power²⁾
(8 ohms, 1 kHz, THD 10%)

140 W per channel

Canada, Europe, Mexico, Australia and Taiwan models¹⁾

Minimum RMS Output Power
(8 ohms, 20 Hz – 20 kHz, THD 0.09%)

85 W + 85 W

Stereo Mode Output Power
(8 ohms, 1 kHz, THD 1%)

105 W + 105 W

Surround Mode Output Power²⁾
(8 ohms, 1 kHz, THD 10%)

140 W per channel

¹⁾Measured under the following conditions:

Area	Power requirements
USA, Canada, Taiwan	120 V AC, 60 Hz
Mexico	127 V AC, 60 Hz
Europe, Australia	230 V AC, 50 Hz

²⁾Reference power output for front, center, surround, surround back and front high speakers. Depending on the sound field settings and the source, there may be no sound output.

Frequency response

Analog 10 Hz – 70 kHz,
+0.5/-2 dB (with sound field and equalizer bypassed)

Input

Analog Sensitivity: 500 mV/
50 kilohms
S/N³⁾: 96 dB
(A, 500 mV⁴⁾)

Digital (Coaxial) Impedance: 75 ohms
S/N: 100 dB
(A, 20 kHz LPF)

Digital (Optical) S/N: 100 dB
(A, 20 kHz LPF)

Output (Analog)

AUDIO OUT Voltage: 500 mV/
1 kilohm

SUBWOOFER Voltage: 2 V/1 kilohm

Equalizer

Gain levels ±6 dB, 1 dB step

³⁾INPUT SHORT (with sound field and equalizer bypassed).

⁴⁾Weighted network, input level.

FM tuner section

Tuning range 87.5 MHz – 108.0 MHz
Antenna (aerial) FM wire antenna (aerial)
Antenna (aerial) terminals 75 ohms, unbalanced

AM tuner section

Tuning range

Area	Tuning scale	
	10 kHz step	9 kHz step
USA, Canada, Mexico	530 kHz – 1,710 kHz	531 kHz – 1,710 kHz
Europe, Australia, Taiwan	–	531 kHz – 1,602 kHz

Antenna (aerial) Loop antenna (aerial)

Video section

Inputs/Outputs

Video: 1 Vp-p, 75 ohms

COMPONENT VIDEO:

Y: 1 Vp-p, 75 ohms

PB: 0.7 Vp-p, 75 ohms

PR: 0.7 Vp-p, 75 ohms

80 MHz HD Pass Through

Mass (Approx.)

Europe model 8.2 kg (18 lb 2 oz)

Other models 8.3 kg (18 lb 5 oz)

Design and specifications are subject to change without notice.

Halogenated flame retardants are not used in the certain printed wiring boards.

iPod/iPhone section

DC 5V 1.0 A MAX

USB section

Supported bit rate* MP3 (MPEG 1 Audio Layer-3):
32 kbps – 320 kbps, VBR
WMA: 48 kbps – 192 kbps
AAC: 48 kbps – 320 kbps
* Compatibility with all encoding/writing software, recording devices and recording media cannot be guaranteed.

Transfer speed Full-speed

Supported USB device

Mass Storage Class

Maximum current 500 mA

General

Power requirements

Area	Power requirements
USA, Canada, Taiwan	120 V AC, 60 Hz
Mexico	127 V AC, 60 Hz
Europe, Australia	230 V AC, 50/60 Hz

Power consumption 240 W

Power consumption (during standby mode)
0.3 W (When “Ctrl for HDMI” is set to “OFF”)

Dimensions (width/height/depth) (Approx.)
430 mm × 158 mm ×
322.6 mm (17 in ×
6 1/4 in × 12 3/4 in)
including projecting parts
and controls

Index

Numerics

- 2 channel 51
- 5.1 channel 18
- 7.1 channel 18

A

- A.F.D. mode 51
- A/V Sync 66, 71
- Advanced Auto Volume 55
- AM 48
- Audio Out 67, 71
- Audio Settings 66, 71
- Auto Calibration Custom 69
- Auto Calibration Settings 69
- Auto Calibration Standard 69
- Auto Standby 67, 71
- Auto Tuning 48

B

- Bass 66, 70
- Blu-ray Disc player 25
- BRAVIA Sync
 - preparing 56

C

- Cable TV tuner 26
- Camcorder 28
- CD player 30
- Clear
 - memory 32
 - remote control 73
 - sound field 55
- Connection
 - antennas 31
 - audio equipment 30
 - iPod/iPhone 27, 30
 - speakers 20
 - TV 22
 - USB device 30
 - video equipment 23
- Control for HDMI 67, 71
- Crossover frequency 64, 70

D

- DCAC (Digital Cinema Auto Calibration) 33
- Direct Tuning 48
- Display panel 10
- Distance Unit 65, 70
- Dolby Digital EX 54
- Dual Mono 66, 71
- DVD recorder 28
- Dynamic range compression 65, 69

E

- Effect level 65
- EQ Settings 66, 70

F

- FM 48
- FM Mode 48, 71

G

- GUI (Graphical User Interface) 38

H

- HDMI Settings 67, 71

I

- Input 40
- Input Assign 60
- INPUT MODE 59
- iPod/iPhone 42, 79

L

- Level Settings 69
- LFE (Low Frequency Effect) 10

M

- Manual Setup 63
- Menu 62, 69
- Message
 - Auto Calibration 37
 - Error 81
 - iPod/iPhone 44
 - USB 47
- Movie mode 51
- Music mode 52
- Muting 41

N

- Name Input 41, 50
- Night mode 66

O

- One-Touch Play 57
- Option menu 39

P

- Pass Through 67, 71
- PlayStation 3 27
- Preset stations 49
- PROTECT 81

R

- Recording 47
- Remote control 13, 72
- Resetting 32

S

- Satellite tuner 26
- Scene Select 59
- Settings menu 62
- Sound field 51
- Speaker Pattern 32, 63, 69
- Speaker Settings 63, 69
- Super Audio CD player 30
- Surround Settings 65, 70
- System Audio Control 58
- System Power-Off 58
- System Settings 67, 71

T

Test Tone 64, 69
Treble 66, 70
Tuner 48
Tuner Settings 71
TV 22

U

Up converting 29
USB device 45
USB FAIL 81

V

VCR 28
Video game 28
Viewing information in the
display 72

<http://www.sony.net/>

©2012 Sony Corporation Printed in Malaysia



* 4 4 0 8 1 5 1 1 1 * (2)

Download from [Www.Somanuals.com](http://www.Somanuals.com). All Manuals Search And Download.

Free Manuals Download Website

<http://myh66.com>

<http://usermanuals.us>

<http://www.somanuals.com>

<http://www.4manuals.cc>

<http://www.manual-lib.com>

<http://www.404manual.com>

<http://www.luxmanual.com>

<http://aubethermostatmanual.com>

Golf course search by state

<http://golfingnear.com>

Email search by domain

<http://emailbydomain.com>

Auto manuals search

<http://auto.somanuals.com>

TV manuals search

<http://tv.somanuals.com>