

FM Stereo/FM-AM Receiver

Operating Instructions

STR-D611
STR-D511

WARNING

WARNING

To prevent fire or shock hazard, do not expose the unit to rain or moisture.

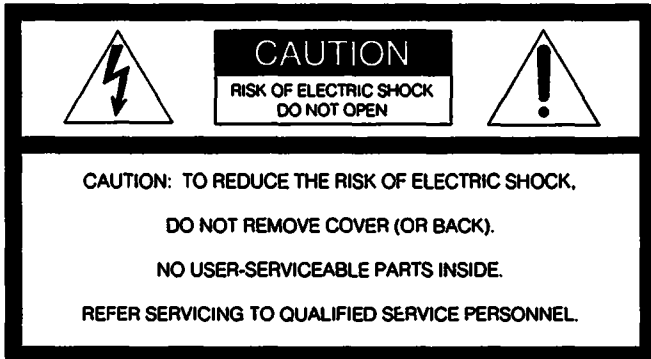

This symbol is intended to alert the user to the presence of uninsulated "dangerous voltage" within the product's enclosure that may be of sufficient magnitude to constitute a risk of electric shock to persons.



This symbol is intended to alert the user to the presence of important operating and maintenance (servicing) instructions in the literature accompanying the appliance.

Note to CATV system installer

This reminder is provided to call the CATV system installer's attention to Article 820-40 of the NEC that provides guidelines for proper grounding and, in particular, specifies that the cable ground shall be connected to the grounding system of the building, as close to the point of cable entry as practical.

Owner's Record

The model number is located on the rear exterior and serial number is on the rear. Record the serial number in the space provided below. Refer to these numbers whenever you call upon your Sony dealer regarding this product.

Model No. STR-D611 Serial No. _____
Model No. STR-D511 Serial No. _____

INFORMATION

This equipment has been tested and found to comply with the limits for a Class B digital device, pursuant to Part 15 of the FCC Rules. These limits are designed to provide reasonable protection against harmful interference in a residential installation. This equipment generates, uses, and can radiate radio frequency energy and, if not installed and used in accordance with the instructions, may cause harmful interference to radio communications. However, there is no guarantee that interference will not occur in a particular installation. If this equipment does cause harmful interference to radio or television reception, which can be determined by turning the equipment off and on, the user is encouraged to try to correct the interference by one or more of the following measures:

- Reorient or relocate the receiving antenna.
- Increase the separation between the equipment and receiver.
- Connect the equipment into an outlet on a circuit different from that to which the receiver is connected.
- Consult the dealer or an experienced radio/TV technician for help.

CAUTION

You are cautioned that any change or modifications not expressly approved in this manual could void your authority to operate this equipment.

NOTICE FOR CUSTOMERS IN THE UNITED KINGDOM

A moulded plug complying with BS 1363 is fitted to this equipment for your safety and convenience.

Should the fuse in the plug supplied need to be replaced, a 5 AMP fuse approved by ASTA or BSI to BS 1362, (i.e. marked with ⚡ or ⚡ mark) must be used.

If the plug supplied with this equipment has a detachable fuse cover, be sure to attach the fuse cover after you change the fuse. Never use the plug without the fuse cover. If you should lose the fuse cover, please contact your nearest Sony service station.

IMPORTANT

If the plug supplied is not suitable for the socket outlets in your home, it should be cut off and an appropriate plug fitted in accordance with the following instructions.

The wires in this mains lead are coloured in accordance with the following code:

- Blue: Neutral
- Brown: Live

As the colours of the wires in the mains lead of this apparatus may not correspond with the coloured markings identifying the terminals in your plug, proceed as follows:
The wire which is coloured blue must be connected to the terminal which is marked with the letter N or coloured black. The wire which is coloured brown must be connected to the terminal which is marked with the letter L or coloured red. Do not connect either wire to the earth terminal in the plug which is marked by the letter E or by the safety earth symbol \perp or coloured green or green and yellow.

WARNING

To prevent shock hazard, do not insert the plug cut off from the mains lead into a socket outlet. This plug cannot be used and should be destroyed.

For the customers in Canada

CAUTION :

TO PREVENT ELECTRIC SHOCK, DO NOT USE THIS POLARIZED AC PLUG WITH AN EXTENSION CORD, RECEPTACLE OR OTHER OUTLET UNLESS THE BLADES CAN BE FULLY INSERTED TO PREVENT BLADE EXPOSURE.

This apparatus complies with the Class B limits for radio noise emissions set out in Radio Interference Regulations.

Table of Contents

Introduction	
Overview	3
Precautions	4
Chapter 1 Getting Started	
Unpacking	4
Checking the supplied accessories	4
Selecting the AM tuning interval (Except U.K. and Australian models)	4
Hooking up the system	5
Notes on connections	5
Connecting equipment	5
Connecting the FM antenna	6
Connecting the antenna ground	6
Connecting the AM antenna	6
Connecting speaker systems	7
Connecting the AC power (Except U.K. model)	7
Identifying the parts and controls	8
Front panel	8
Remote commander	9
Inserting the batteries into the remote commander	9
Chapter 2 Basic Operations	
Remote controls	10
Changing the settings of the FUNCTION buttons	10
Audio adjustment	11
Adjusting volume	11
Adjusting tone quality	11
Adjusting left and right sound balance	11
Reinforcing the bass	11
Selecting the speaker system	11
Selecting a program source	11
Receiving FM/AM broadcasts	12
Tuning in a station directly (Direct tuning)	12
Automatic tuning	13
Presetting stations	14
Tuning in a preset station - Preset tuning	15
Chapter 3 Advanced Operations	
Recording an audio source	16
Recording	16
Tape dubbing	16
Recording a video source	17
Video tape editing	17
Obtaining the surround effect	17
Selecting the surround mode	17
Available types of effects	17
Placement of speakers and selecting the PRO LOGIC MODE	18
Adjusting the speaker volume	19
Adjusting the delay time of the rear speakers (STR-D611 only)	20
Chapter 4 Other Information	
Troubleshooting guide	21
Specifications	23

Introduction

Overview

The STR-D611/D511 is an FM Stereo/FM-AM receiver and audio/video control center.

You can listen to various audio/video program sources with this unit.

TV/video programs

- You can enjoy TV or CATV programs with FM simulcast.

Tuner

- Precise tuning is ensured by a quartz-locked digital synthesizer.

Surround sound system

This unit incorporates all of 3 types of surround effect.

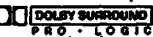
-  expands sound just like listening to it in a movie theater.
- HALL: Surround provides reverberation effect that is produced in a large concert hall.
- SIMULATED: Surround gives the feeling of width and thickness to monaural sound of old movie program, etc. (STR-D611 only)
- **DOLBY* PRO LOGIC:** This unit incorporates the Dolby Pro Logic Surround Decoder which has the same functions for playback as movie theaters and gives a theater-like experience in your listening room, naturally reproducing the audio sound field.
- The input balance of Dolby surround program sources is automatically adjusted.

* Manufactured under license from Dolby Laboratories Licensing Corporation. Additionally licensed under one or more of the following patents: U.S. number 3,959,590; Canadian numbers 1,004,603 and 1,037,877. "DOLBY", "Pro Logic", and the double-D symbol are trademarks of Dolby Laboratories Licensing Corporation.

Remote commander

- The supplied remote commander allows you to remotely control this unit and the equipments connected to the unit.

Difference between the models

This instruction manual covers the STR-D611 and STR-D511. The STR-D611 has the following features which are not in the STR-D511.

- DELAY TIME adjustment
- The SIMULATED mode of the surround effect

Note: All illustrations in this manual show the STR-D611.

Precautions

On safety

- For U.S.A. and Canadian models, operate the unit only on 120 V AC, 60 Hz.
- For U.K. model, operate the unit only on 240 V AC, 50/60 Hz.
- For Australian model, operate the unit only on 240 V AC, 50 Hz.
- Should any solid object or liquid fall into the cabinet, unplug the unit and have it checked by qualified personnel before operating it any further.
- Unplug the unit from the wall outlet if it is not to be used for an extended period of time. To disconnect the cord, pull it out by grasping the plug. Never pull the cord itself.
- One blade of the plug is wider than the other for the purpose of safety and will fit into the power outlet only one way. If you are unable to insert the plug fully into the outlet, contact your dealer. (not applicable to U.K. and Australian customers)
- AC power cord must be changed only at the qualified service shop.
- This unit is not disconnected from the AC power source as long as it is connected to the mains outlet, even if the unit itself has been turned off.

On operation

Before making program source connections, be sure to turn the power switch off and unplug the unit.

On cleaning the cabinet

Clean the cabinet, panel and controls with a soft cloth lightly moistened with mild detergent solution. Do not use any type of abrasive pad, scouring powder, or solvent such as alcohol or benzene.

For the customers in the U.S.A.

For detailed safety precautions, see the "IMPORTANT SAFEGUARDS" leaflet.

If you have any question or problem concerning your unit, please consult your nearest Sony dealer.

Unpacking

To prevent internal heat buildup in the unit, place the unit in a location with adequate air circulation.

Do not install the unit:

- near heat sources such as radiators or air ducts.
- in a place subject to direct sunlight, excessive dust, mechanical vibration or shock.

Do not place anything on top of the cabinet.

The top ventilation holes must be unobstructed for the proper operation of the unit and to prolong the life of its components.

Do not throw away the carton and packing material!

It will be an ideal container when transporting the system for repair work, etc.

Checking the Supplied Accessories

After unpacking, check that the following accessories are present.

- FM wire antenna (1)
- AM loop antenna (1)
- Remote commander RM-U232 (1)
- Sony batteries SUM-3 (NS) (2)

Selecting the AM Tuning Interval (Except U.K. and Australian Models)

The AM tuning interval is preset to 10 kHz. To use the receiver where the frequency allocation system is based on a 9 kHz interval, make the following adjustments.

- 1 Turn on the power and tune into any AM station.
- 2 Turn off the power.
- 3 Press the POWER button while pressing the "+" TUNING button.

To reset the AM tuning interval, repeat the above steps.

Caution

When the interval is changed, all preset stations which you have memorized will be erased. After changing the interval, be sure to preset the stations again.

Hooking Up the System

Notes on Connections

At first, this section describes about the connection with the other equipments, the antenna connection, speaker connection and then the AC power connection.

- Do not connect the power cord to an AC outlet nor press the POWER switch before accomplishing all other connections.
- The cable connectors should be fully inserted into the jacks. Loose connection may cause hum and noise.
- Jacks and plugs of the connecting cord are color-coded as follows:
Red jacks and plugs: For the right channel of audio signals
White jacks and plugs: For the left channel of audio signals
Yellow jacks and plugs: For video signals

Connecting Equipment

The numbers correspond to the following details on page 6 and 7.

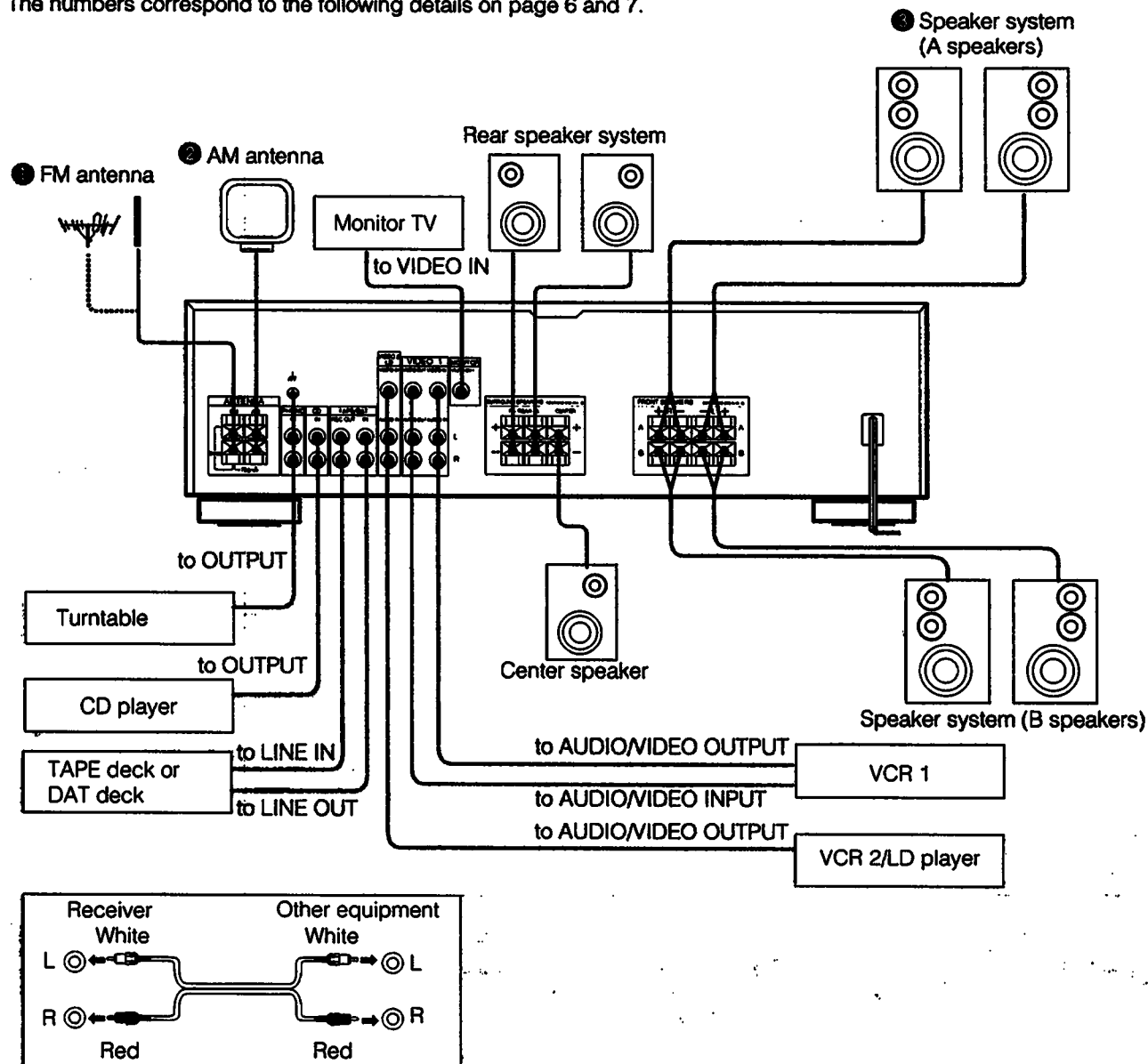

Hooking Up the System

1 Connecting the FM Antenna

Though the wire antenna is supplied with this unit, the higher quality sound will be obtained with 75-ohm coaxial cable. (optional)

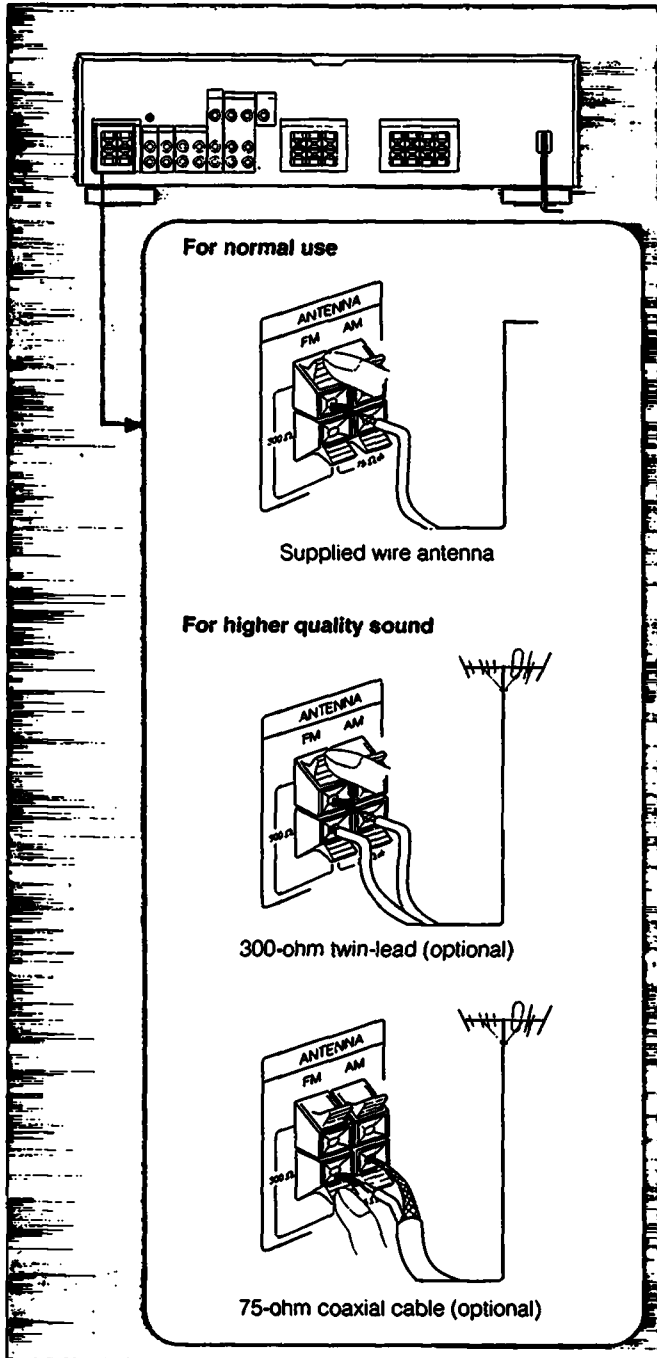

2 Connecting the AM Antenna

The AM reception is adequate with the supplied AM loop antenna. However, the connection of insulated wire is also available for areas with difficult AM reception.

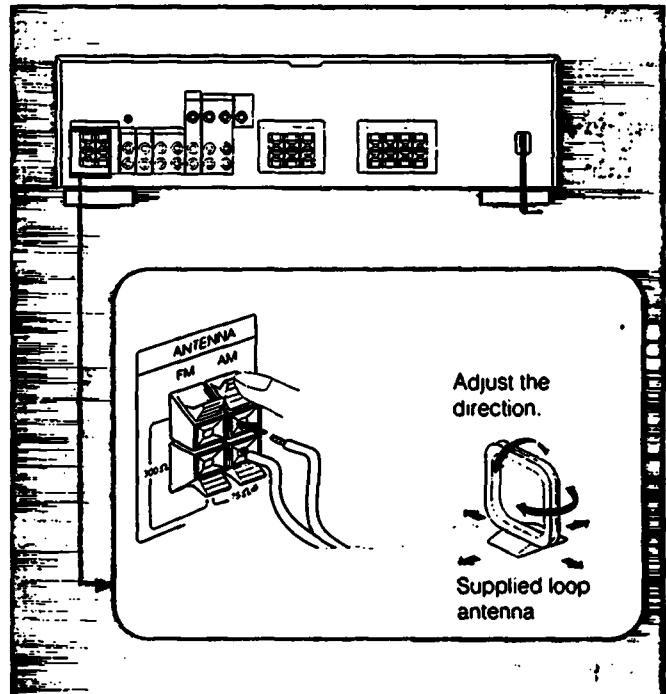

For areas with poor AM reception

In areas with poor reception, connect a 6 to 15-meters (20 to 50-feet) insulated wire to the AM antenna terminal. Extend this out of doors if possible, keeping the greater portion horizontal. There is no need to disconnect the supplied antenna.

Connecting the Antenna Ground

To prevent hum, connect the ground wire to ANTENNA ground terminal (⌏). When an outdoor antenna is installed, be sure to connect the ground wire for lightning protection.

3 Connecting Speaker Systems

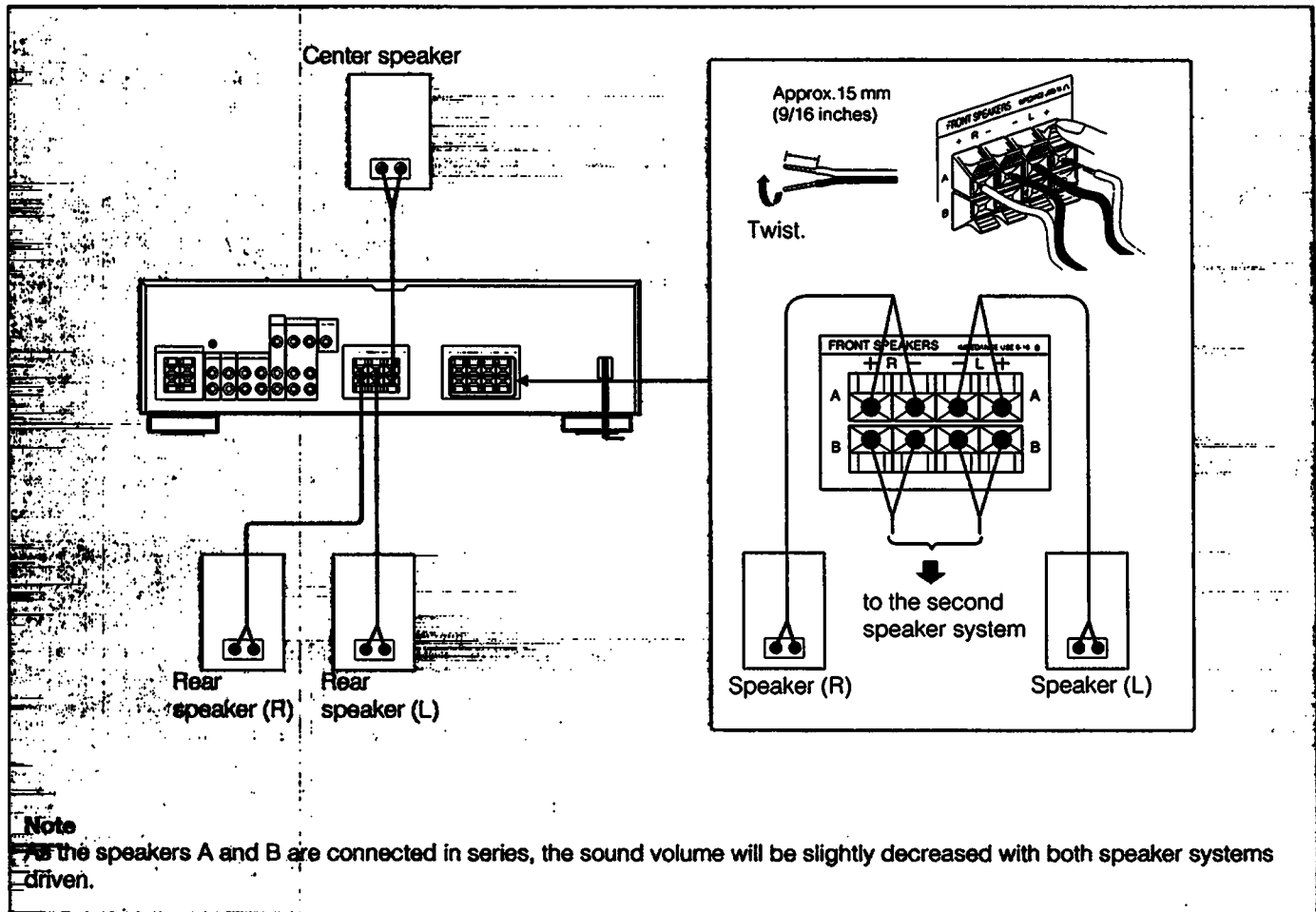

Connecting the AC Power (Except U.K. Model)

Be careful that the power consumption of equipment connected to the outlet on the receiver does not exceed 120 watts for USA and Canada models or 100 watts for Australian model.

Do not connect electrical home appliance such as an electric iron, fan, TV, or other high-wattage equipment to the outlet.

Download from www.Somanuals.com. All Manuals Search And Download.

Identifying the Parts and Controls

Front Panel

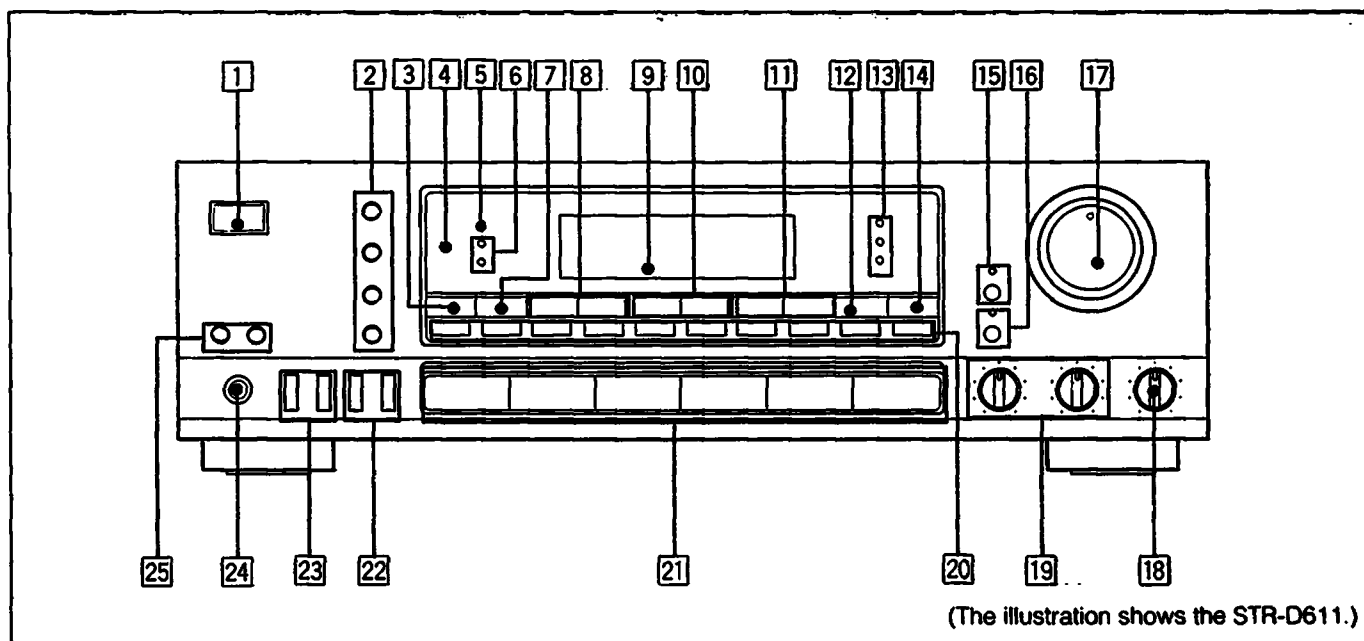

- 1 POWER switch**
- 2 SUR (surround) ON/OFF button**
(See pages 19 and 20.)
SUR (surround) MODE button (See pages 19 and 20.)
PRO LOGIC MODE button (See pages 18 and 19.)
DELAY TIME selector (STR-D611 only) (See page 20.)
- 3 SHIFT button** (See pages 14 and 15.)
- 4 Remote sensor**
- 5 STANDBY indicator** (for U.K. and Australian models only)
The STANDBY indicator lights up when the power cord is connected.
- 6 VIDEO 1/2 indicators** (See page 17.)
- 7 MEMORY button** (See page 14.)
- 8 TUNING +/- buttons** (See page 13.)
- 9 Display window**
- 10 PRESET TUNING +/- buttons** (See page 15.)
- 11 FM/AM band selectors** (See pages 12 and 13.)
- 12 TUNING DIRECT button** (See page 12.)
- 13 SUR (surround) mode indicators** (See page 17.)
- 14 FM MODE button** (See page 12.)
- 15 DBFB (Dynamic Bass Feedback) button and indicator** (See page 11.)
- 16 MUTING button and indicator** (See page 11.)
- 17 MASTER VOLUME control** (See page 11.)
- 18 BALANCE control** (See page 11.)
- 19 BASS/TREBLE controls** (See page 11.)
- 20 Numeric buttons** (See pages 12, and 15.)
- 21 Function selectors** (See page 11.)
- 22 REAR LEVEL +/- buttons** (See page 19.)
- 23 CENTER LEVEL +/- buttons** (See page 19.)
- 24 HEADPHONES jack**
- 25 SPEAKERS A/B buttons** (See page 11.)

Remote Commander

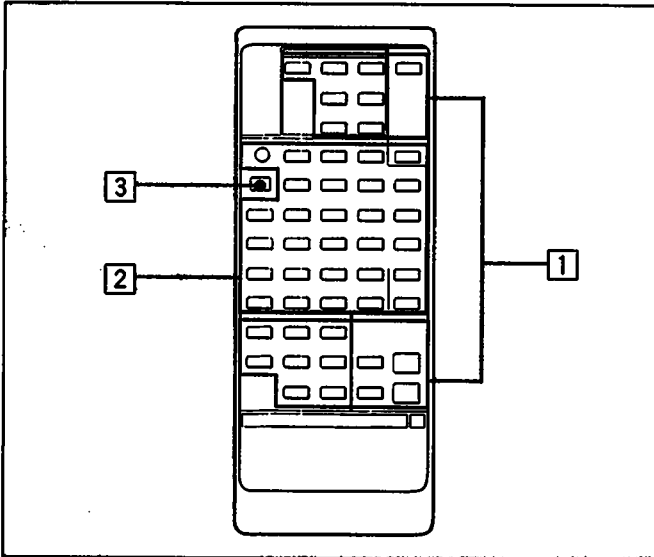

1 Receiver control section

FUNCTION

PHONO, TUNER, CD, TAPE, DAT, VIDEO 1, VIDEO 2:
When each function is selected, the unit enters its operating mode automatically.
SYSTEM OFF: Turns off the power of the whole system.

SURROUND

MODE: Selects the surround mode.
ON/OFF: Turns on/off the surround system.
REAR LEVEL +/- buttons: Control the volume of rear speakers (surround level).
CENTER LEVEL +/- buttons: Control the volume of center speaker (surround level).
DELAY button: Adjusts the delay time. (STR-D611 only)
T. (test) TONE: Generates a test tone signal that is sent in succession to each speaker.

DBFB button: Turns on/off the DBFB (Dynamic Bass Feedback).

MUTING button: Mutes the sound.

MASTER VOL +/- buttons: Control the volume level.

2 Other equipment control section

The operative buttons are changed according to the function mode and the setting of the SYSTEM/TV selector.

Numeric buttons (1 to 0): Designate the number.

>10: Designates the number more than 10.

ENTER: Press after designating the TV/VCR channel.

SHIFT: Select the memory page (A, B or C) only in the tuner mode.

TV/VIDEO selector: Selects the program to see ; TV or VCR.

ANT TV/VTR button: Selects the output signal from the antenna terminals on the VCR, either a TV signal or VCR programs.

VISUAL POWER: Turns on/off the power of TV, VCR and LD player.

CH/PRESET +/- buttons: Select a preset station or TV/VCR channel.

◀◀▶▶: Fast winding/manual search

● and ▶: Forward recording

● and ◀: Reverse recording

◀▶: Play

■: Stop

||: Pause

◀◀▶▶: Locate a desired selection.

D (disc) SKIP: Disc skip (for a CD player equipped with a multi-disc changer)

SELECT: Changes the settings of the FUNCTION button.

3 SYSTEM/TV mode switch

In TV mode (When setting the SYSTEM/TV selector to TV.)

Only MUTING, MASTER VOL +/- and the operative buttons in TV section on the list described on the next page can be used.

Inserting the Batteries into the Remote Commander

Before operating remote commander, install the batteries as shown below.

1 Open the cover.

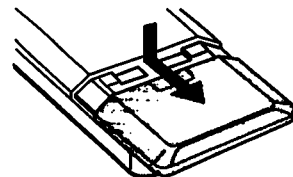

2 Insert two size-AA (R6) batteries with correct polarity.

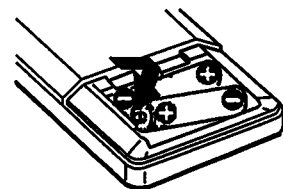

To avoid damage caused by battery leakage and corrosion

When the commander will not be used for a long time, remove the batteries.

Battery life

Normal operation can be expected about a half year using Sony SUM-3 (NS), and a year using Sony AM-3 (NW) alkaline batteries.

When the batteries are run down, the remote commander will not operate the unit. In this case, replace both batteries with new ones.

Audio Adjustment

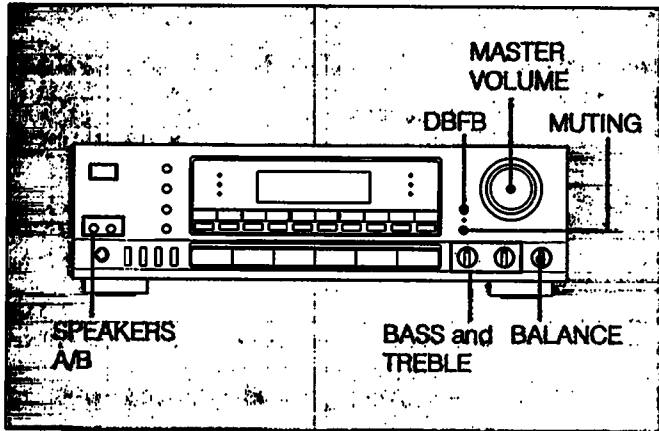

Adjusting volume

To adjust volume
Turn MASTER VOLUME.

To reduce the sound to a low level temporarily (- 20 dB attenuation)
Press MUTING and the indicator lights up.
Press again to restore the same listening level as before and the indicator goes off.

Adjusting Tone Quality

Adjust BASS or TREBLE for the optimum sound.

Adjusting Left and Right Sound Balance

Adjust BALANCE to correct stereo imaging, when the speaker position is not symmetrical.

Reinforcing the Bass

Press DBFB (Dynamic Bass Feedback) and the indicator lights up.
Press again to cancel the DBFB mode and the indicator goes off.

Selecting the Speaker System

To drive speaker system A: Press SPEAKERS A.
To drive speaker system B: Press SPEAKERS B.
To drive both speaker systems A and B: Press both SPEAKERS A and B.
For headphone listening: Connect headphones to HEADPHONES and set SPEAKERS A and B to off.

IMPORTANT

Speaker systems A and B are connected in series. No sound can be heard if the SPEAKERS A and B buttons are set to on when only one speaker system is connected.

Selecting a Program Source

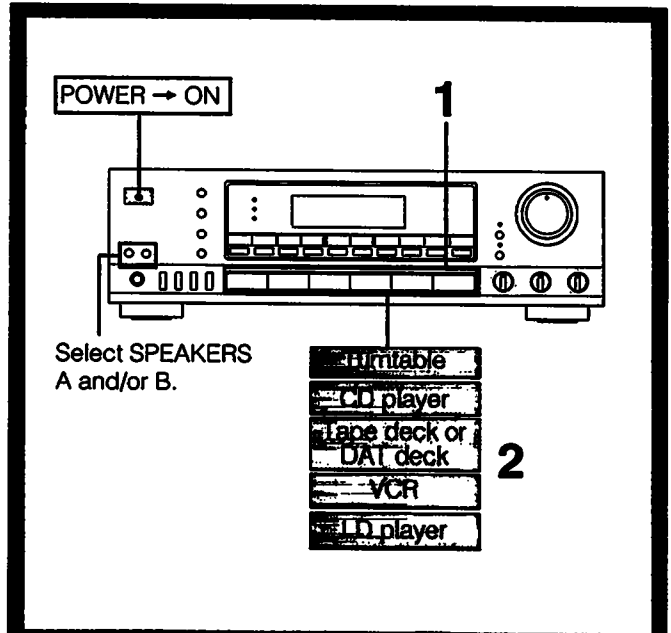

Select SPEAKERS A and/or B.

1 Select the program source.

	The function selector to be pressed
Phono record	PHONO
Radio Broadcast	TUNER
Compact disc	CD
DAT or Taped programs	TAPE/DAT
Video programs	VIDEO 1, VIDEO 2/LD

If only pressing one of the FUNCTION buttons on the supplied remote commander, both the power of its operating equipment and the receiver are turned on.

2 Start the selected program.

Receiving FM/AM Broadcasts

Tuning in a Station Directly — Direct Tuning

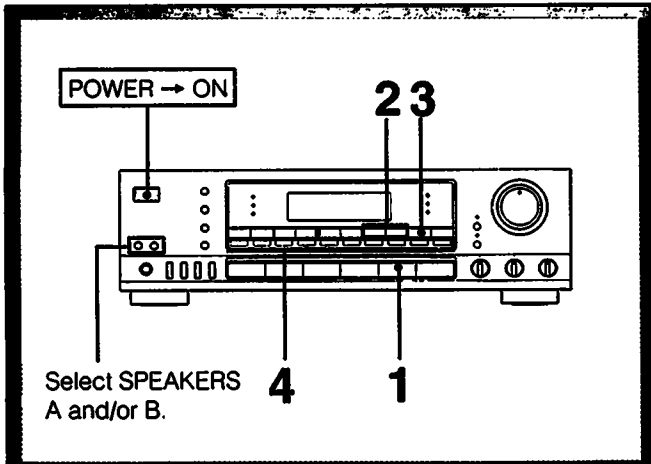

1 Press TUNER.

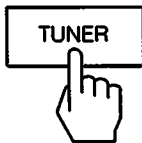

2 Select FM or AM.

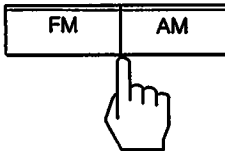

3 Press TUNING DIRECT.



4 Press the appropriate numeric buttons to enter the frequency. (See examples below.)

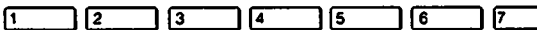

The entered frequency is displayed.

Example 1: FM 102.50 MHz

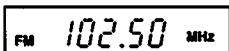
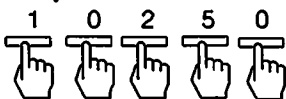

Example 2: AM 1350 kHz

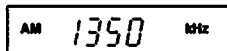

To correct the entered frequency
Repeat steps 3 to 4.

For entering AM frequencies

You need not enter the last "0". (except U.K. and Australian models)

However, if you have changed the AM tuning interval to 9 kHz, enter all the digits.

If you enter a frequency not covered by the tuning interval

The entered value is automatically rounded up or down to the closest value covered by the tuning interval.

Tuning intervals for direct tuning are the followings:

FM: 50 kHz interval

AM: 10 kHz interval (changeable to the 9 kHz interval)

9 kHz interval (for U.K. and Australian models)

(See page 4.)

When an FM stereo program is noisy

When the unit receives an FM stereo program, the STEREO indicator lights in the display window. If the stereo program is noisy, press FM MODE to change the mode over to MONO. This eliminates the stereo effect, but the noise will be greatly reduced.

To return to the stereo mode, press FM MODE again.

Automatic Tuning

When you do not know the frequency of the station, proceed as follows.

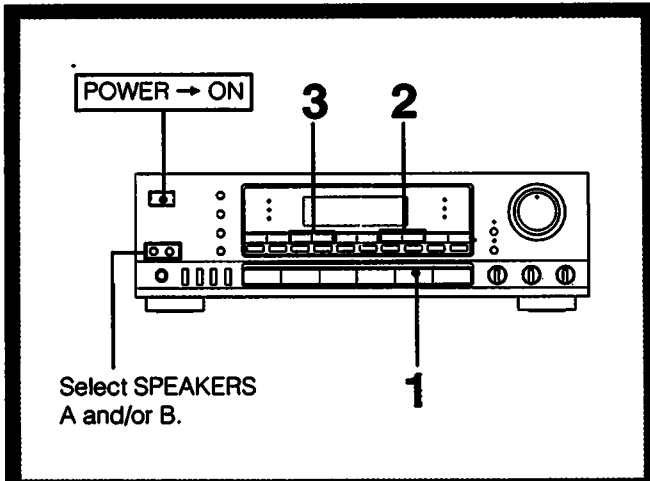

1 Press TUNER.

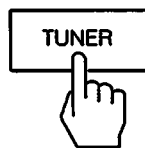

2 Select FM or AM.

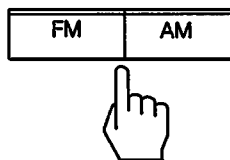

3 Press TUNING + or -.

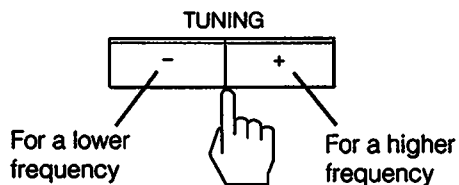

When a station is received, automatic tuning stops automatically. To change the station, press + or - again.

Quickly tuning in a roughly known frequency

Proceed as the following example.

Example: The station between AM 700 and AM 800 kHz.

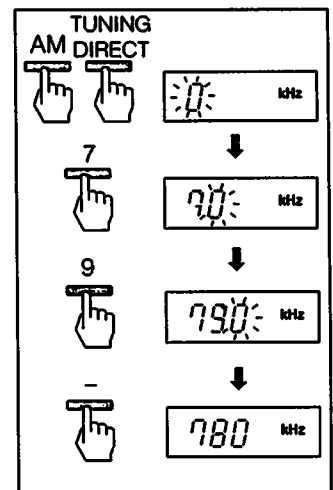
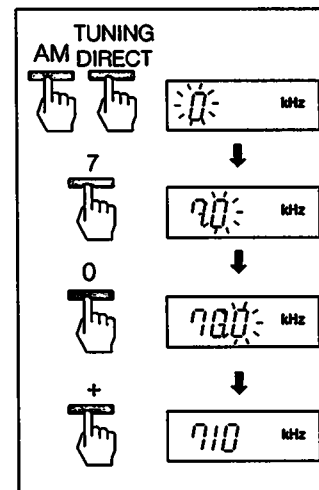

When sweeping does not stop at the desired station

The signal strength is weak. Tune in the station as described in "Tuning in a Station Directly" on page 12.

Receiving FM/AM Broadcasts

Presetting Stations

A total of 30 FM/AM stations can be memorized in any desired sequence.

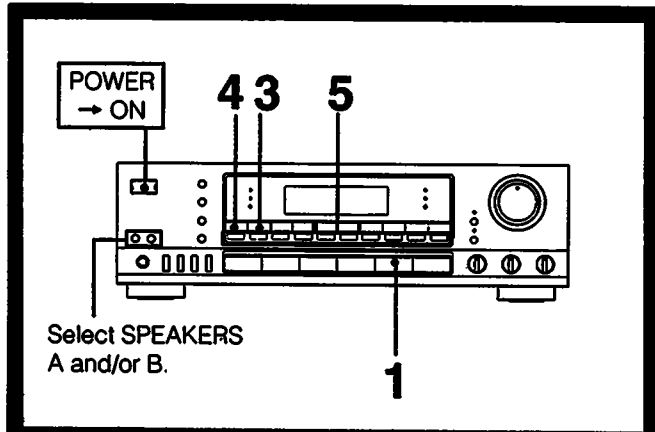

1 Press TUNER.

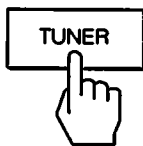

2 Tune in the desired station. (See "Automatic Tuning" or "Tuning in a Station Directly".)

3 Press MEMORY and the MEMORY indicator appears for a few seconds.



4 Press SHIFT to select the memory page (A, B or C).

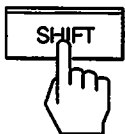

Each time the button pressed, A, B or C is selected cyclically.

5 Press the desired numeric button (1 to 0), while the MEMORY indicator is displayed.



Repeat above steps for presetting other desired stations.

Use of memory pages

The memory pages (A, B and C) can be used to classify stations according to the music category, station band, etc.

Replacing a preset station

Preset another station on the number of the station to be replaced. The previously preset station will be erased.

IMPORTANT

The memorized station is maintained for approximately one month even if the power cord is disconnected from the AC power outlet. If they are erased, store the stations again.

Tuning in a Preset Station - Preset Tuning

There are two ways to perform the preset tuning. In method A, the direct tuning, select by designating the desired preset station number directly with the numeric button. In method B, the scan tuning, select the preset station with the PRESET TUNING +/- button.

Method A: Direct tuning

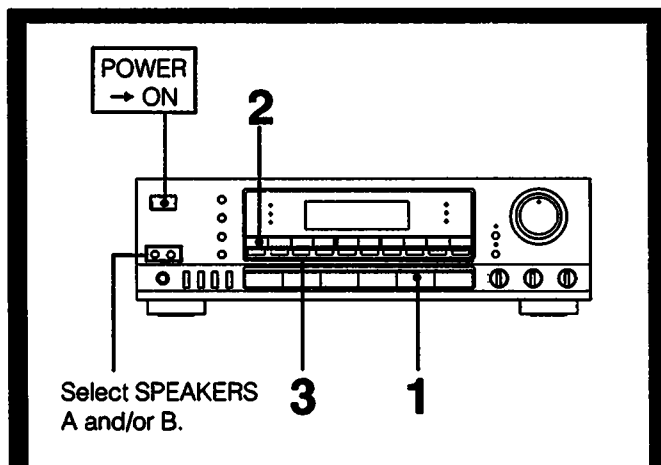

1 Press TUNER.

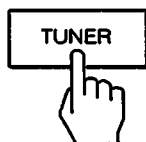

2 Press SHIFT to select the memory page (A, B or C).

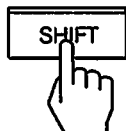

Each time the button pressed, A, B or C is selected cyclically.

3 Press the numeric button.

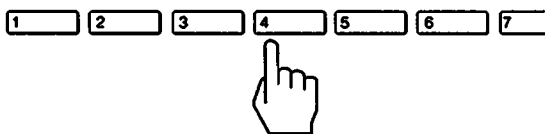

Method B: Scan tuning

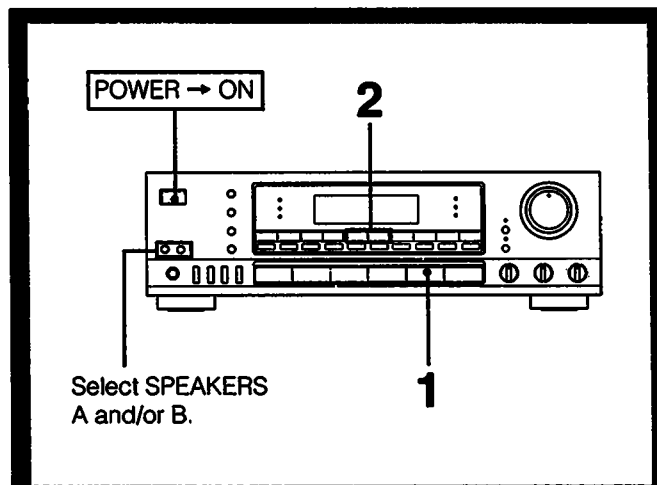

1 Press TUNER.

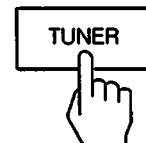

2 Press PRESET TUNING + or -.

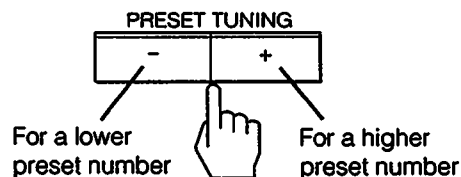

Each time you press + or -, the preset station of the next higher or lower number is tuned in.

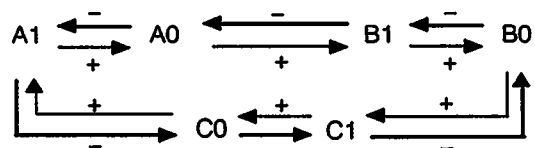

- If you keep pressing + or -, preset stations are successively tuned in. Release the button when the desired preset station is tuned in.

Recording an Audio Source

Recording

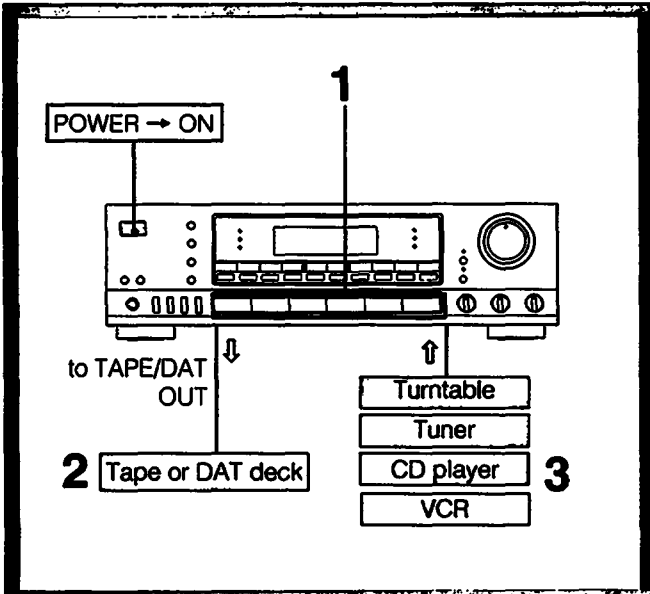

- 1** Select the desired program source with the function selector.
For an FM/AM broadcast, tune in the desired station.



- 2** Set the tape (DAT) deck in the recording mode.
- 3** Start the selected program source.

Note on recording

The settings of MASTER VOLUME, BASS/TREBLE, SUR (surround), DBFB, BALANCE and MUTING do not have any effect on recording.

Tape Dubbing

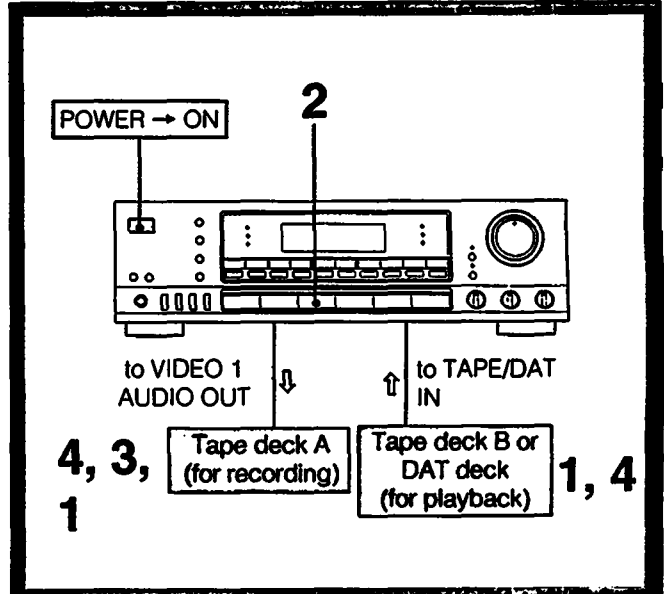

- 1** Insert the recorded tape into tape deck B (or the DAT deck) and a blank tape into tape deck A.

- 2** Press TAPE/DAT to select the deck for playback.



- 3** Adjust the recording level of tape deck A.

- 4** Start playback of the tape (or the DAT) in tape deck B (or the DAT deck), and set tape deck A in the recording mode.
Dubbing will start.

Recording a Video Source

Video Tape Editing

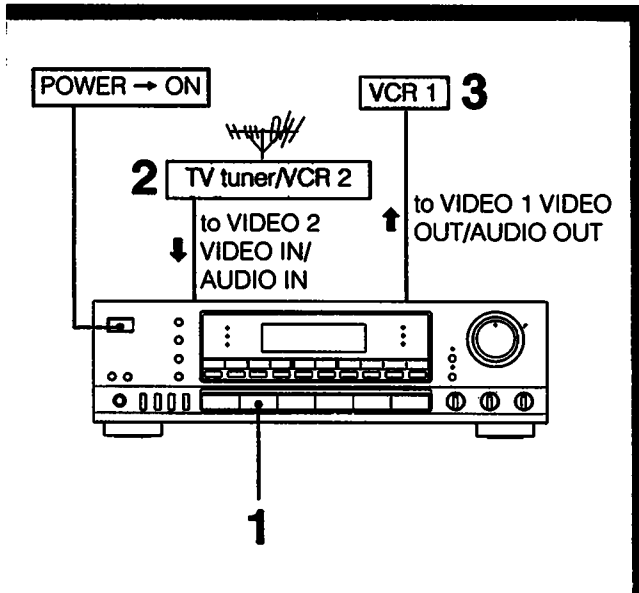

- 1 Press VIDEO 2/LD so that the VIDEO 2 indicator lights up.



- 2 Set VCR 2 to the playback mode.

- 3 Set VCR 1 to the recording mode.

Obtaining the Surround Effect

Selecting the Surround Mode

- 1 Press SUR ON/OFF to ON.
- 2 Press SUR MODE to select the surround effect. Each time the button is pressed, the HALL, SIMULATED (STR-D611 only) or DOLBY mode is selected cyclically and the respective indicator lights up.
- 3 When selecting the DOLBY mode in step 2, press PRO LOGIC MODE to select the PRO LOGIC mode.

Available Types of Effects

Two front and two rear speakers are necessary to enjoy the surround function. In the Dolby PRO LOGIC MODE, the speaker operation mode can be selected according to your speaker configuration.

How to place speakers

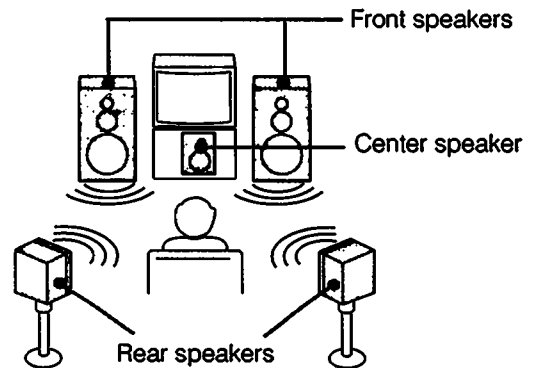

HALL: Provides reverberation effect that is produced in a concert hall.

SIMULATED (STR-D611 only): Gives a simulated stereo effect to monaural sound.

DOLBY: Expands sound just like listening to in a movie theater.

To select the PRO LOGIC MODE, see next page.

Note

When you wish to enjoy the surround function, set the SPEAKERS A button or both A and B buttons to on. If only the SPEAKERS B button is set to on (that is, the SPEAKERS A button is set to off), the surround effect cannot be obtained.

Obtaining the Surround Effect

Placement of Speakers and Selecting the PRO LOGIC MODE

The Dolby Pro Logic Surround Decoder has the same functions for playback, such as movie theaters and gives a theater-like experience in your listening room, naturally reproducing the audio sound field.

The STR-D611 and STR-D511 incorporate a decoder which reproduces the specially encoded surround sound of Dolby surround video programs.

In the Dolby surround mode, select the speaker operation mode according to your speaker configuration by pressing the PRO LOGIC MODE button. Each time the PRO LOGIC MODE button is pressed, the PRO LOGIC MODE is changed in the following order:

→ PHANTOM → 3 CH. LOGIC → NORMAL → WIDE

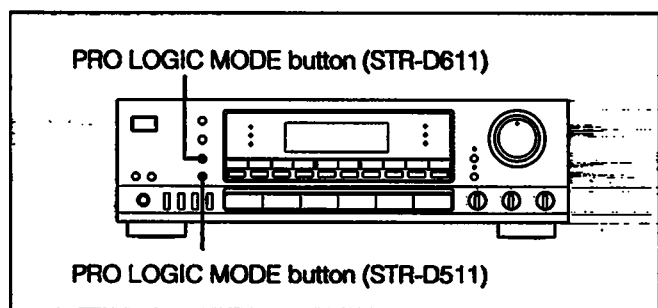

PHANTOM mode

Select this mode when you play back a Dolby surround program source without using a center speaker. The sound of the center channel is output from the front (L and R) speakers.

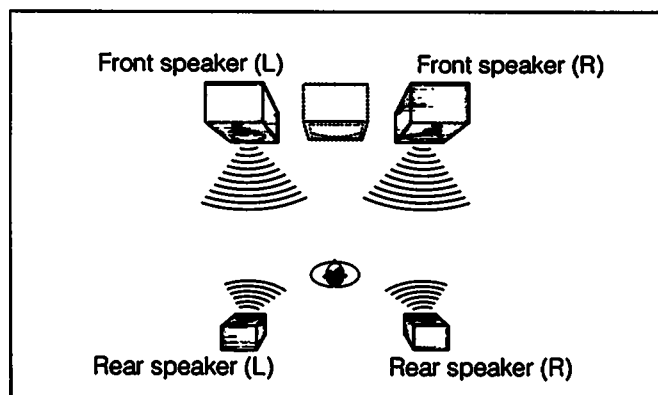

3CH. (Channel) LOGIC mode

Select this mode when you play back a Dolby surround program source only with the front and center speakers. The sound of the rear channel is output from the front (L and R) speakers.

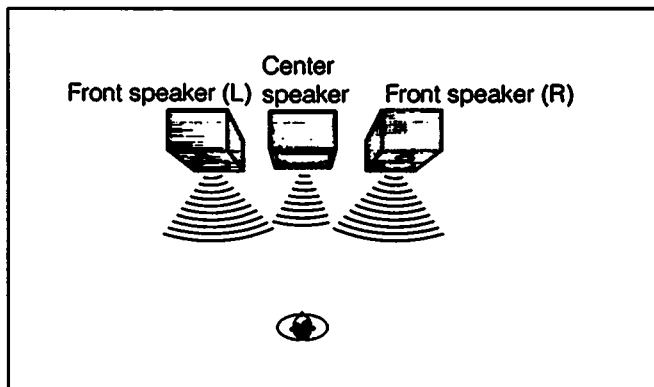

NORMAL mode

Select this mode if you use small center speaker. The bass sound of the center channel is output from the front speakers, as a small speaker cannot produce enough bass.

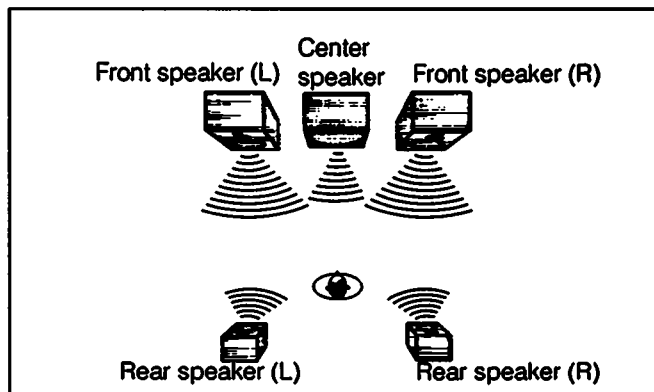

WIDE mode

Select this mode if you use a medium to large center speaker.

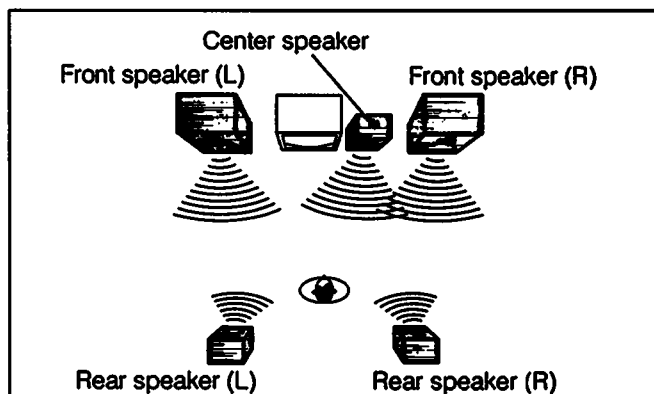

Note

Some commercially available software may have Dolby surround processed sound tracks even though it is not so indicated on the package.

Adjusting the Speaker Volume

To enjoy the surround sound to the maximum on playing any program sources, adjust the front, rear, and center (if connected) speakers to the same volume level. The level once adjusted can be used for all surround modes. You can adjust the volume level from your listening position by using the remote commander.

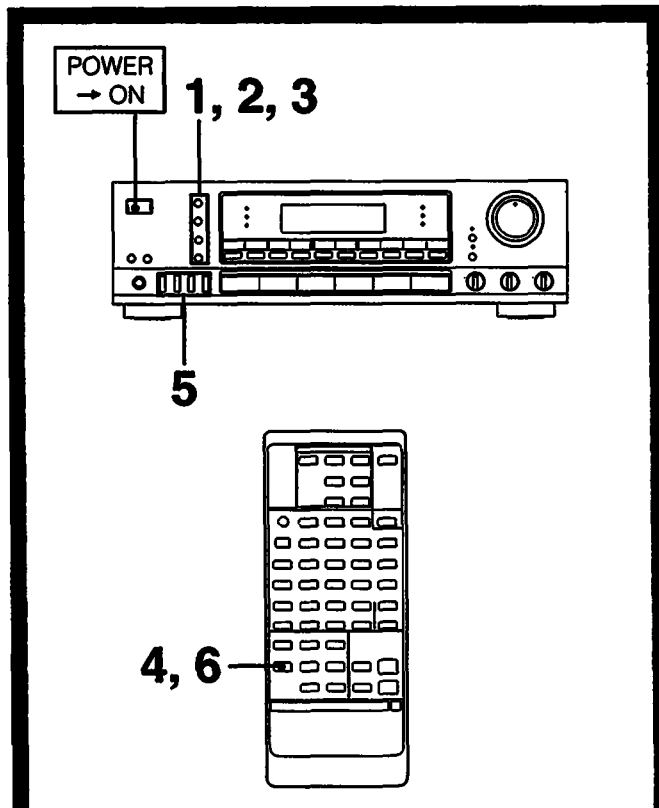

- 1** Press SUR ON/OFF to ON.
- 2** Press SUR MODE to select DOLBY.
- 3** Press PRO LOGIC MODE to select the Dolby pro logic mode according to your speaker system.
- 4** Press T. TONE on the remote commander to set to on.

5 Adjust the level of rear and center speakers.

To adjust the level of rear speakers

Press REAR LEVEL + or - to adjust the level of rear speakers.

To adjust the level of center speaker

Press CENTER LEVEL + or - to adjust the level of center speaker so that sound from each speaker is heard in the same volume level at the listening position. (When adjusting the VOLUME control on the receiver, all speakers are adjusted simultaneously.)

- 6** Press T. TONE on the remote commander to set to off.

Sequence of the test tone

In a system with a center speaker:

The test tone will be output automatically from the front L, center, front R, and the rear speakers in succession.

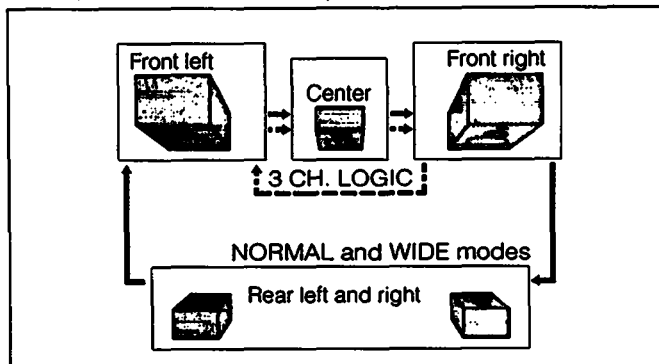

In a system without a center speaker:

The test tone will be output automatically from the front left and right speakers and the rear speakers alternately.

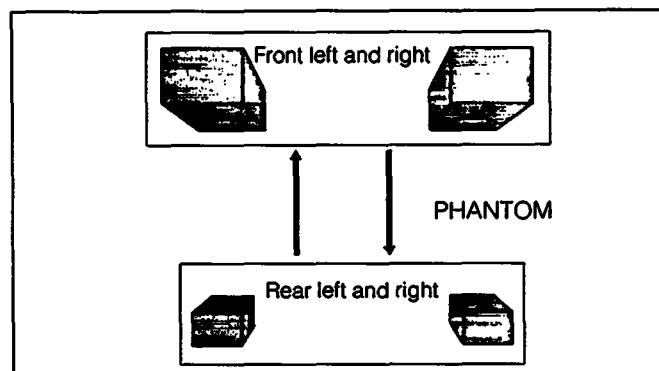

Obtaining the Surround Effect

Adjusting the Delay Time of the Rear Speakers (STR-D611 only)

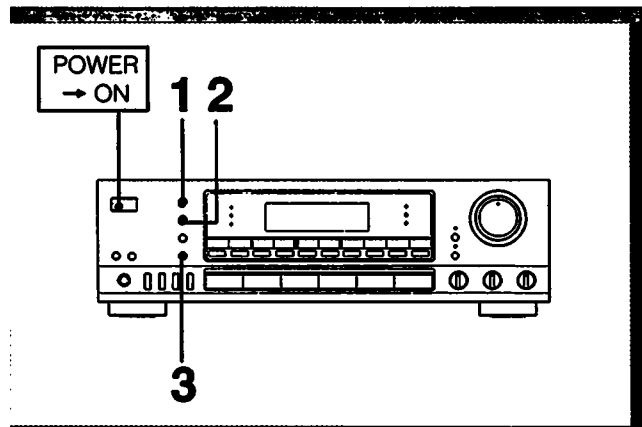

- 1** Press SUR ON/OFF to ON.
- 2** Press SUR MODE to select DOLBY.
- 3** Press DELAY TIME on the front panel or DELAY on the remote commander to adjust the delay time.

To turn off the surround effect

Press SUR ON/OFF to set it to off. The normal sound without surround effect will resume.

Rear level, center level and delay time of the surround is memorized each time after adjusting with the DELAY TIME, REAR LEVEL +/- and CENTER LEVEL +/- buttons. They will be restored when the surround mode is resumed.

The receiver is preset in the factory to get an optimum rear level as long as each speaker has an equal efficiency.

Troubleshooting Guide

Before proceeding through the check list below, examine the connections and the procedures outlined in the manual.

Should any problem persist after you have checked the following items, consult your nearest Sony dealer.

Problem	Cause	Solution
The STEREO indicator flickers or does not appear when receiving stereo programs.	A very weak FM station or a noisy FM program is received.	Adjust the antenna or connect an external FM antenna. Press FM MODE to set to MONO mode.
No station can be tuned in by Automatic Tuning operation.	The AM tuning interval is set incorrectly.	Change the tuning interval according to the AM frequency allocation system of your country. (See page 4)
	The signal strength of the station is too weak for Automatic Tuning.	Adjust the antenna. Directly tune in the stations. (See page 12)
No stations can be tuned in by pressing PRESET TUNING +/-.	No stations have been preset.	Preset the stations. (See page 14)
No sound is heard even if you adjust VOLUME.	The speaker or program source equipment is not connected correctly.	Connect the equipment correctly.
	The SPEAKERS A/B buttons are not set correctly.	Set the buttons correctly. If the A and B buttons are both depressed, check that both speaker systems are properly connected.
	A wrong function selector has been pressed.	Press the correct function selector.
No sound is heard from center speaker.	The PHANTOM mode is selected in the PRO LOGIC MODE.	Sound from the center speaker cannot be heard in the PHANTOM mode. Select another mode. (See page 18)
	The level of the center speaker is very low.	Adjust the level of the center speaker correctly. (See page 19)
	The HALL or SIMULATED mode is selected.	Sound from the center speaker cannot be heard in these modes. (See page 18)
No sound or sound at very low level is heard from rear speakers.	Surround function is turned off.	Press SUR ON/OFF to turn on the function.
	The 3CH LOGIC mode is selected in the PRO LOGIC MODE.	Sound from the rear speakers cannot be heard in the 3CH LOGIC mode. Select another mode. (See page 18)
	The level of the rear speakers is very low.	Adjust the level of the rear speakers correctly. (See page 19)
	Monaural program source is played back in Dolby surround mode.	Select another mode.

Troubleshooting Guide

Problem	Cause	Solution
There is an abrupt loss of sound from one or both of the speakers, or the PROTECTOR indicator flickers in the display window.	A short-circuit problem activates the protective circuit.	Turn off the unit, eliminate the short-circuit problem and turn on the power again. If there is no short-circuit problem, consult your nearest Sony dealer.
Surround effect cannot be obtained.	The unit is in a wrong mode.	Press SUR MODE to set the surround mode.
	Surround circuit is turned off.	Press SUR ON/OFF.
Sound is heard only at a very low volume.	MUTING has been pressed. (The muting indicator is lit.)	Press the button to disengage.
One channel does not transmit audio, or the volume from the left and right speakers is unbalanced.	The BALANCE control is not set appropriately.	Adjust the BALANCE control.
	The speaker or program source is not connected correctly.	Check and properly connect the equipment.
Sound transmitted from the speakers is reversed.	The speakers are not connected correctly.	Connect the right speaker to the R SPEAKER terminals and the left speaker to the L SPEAKER terminals.
There is lack of bass sound or the instrument position is obscure.	* The \oplus/\ominus connection of the speaker is reversed.	Connect the speaker with the correct phase.
Severe hum or noise is heard.	The connecting cords are not shielded type.	Use shielded type cords.
	A transformer, motor, TV or fluorescent light affects the connecting cords.	Place the connecting cords in a location away from a transformer or motor, and at least 3 meters (10 feet) from a TV set or a fluorescent light.
	The audio components are too close to a TV set.	If both are used at the same time, separate the TV from the audio components.
	The unit is not grounded.	Connect the ground wire to the antenna ground terminal.
	The connections are loose.	Make secure connections.
	The plugs and jacks are dirty.	Wipe the plugs and jacks with a cloth lightly dampened with alcohol.
The remote commander will not operate.	The batteries are exhausted.	Replace the batteries with new ones.
	The commander head is not pointed toward the unit's front.	Point the commander head toward the receiver.

Specifications

(For USA and Canadian models)

Audio Power Specifications

POWER OUTPUT AND TOTAL HARMONIC DISTORTION

With 8-ohm load, both channels driven, from 40 - 20,000 Hz, rated 70 watts (STR-D611) or 50 watts (STR-D511) per channel minimum RMS power, with less than 0.8% total harmonic distortion from 250 milliwatts to rated output.

SUR (surround) MODE (8 ohms, less than 0.8% total harmonic distortion)

	STR-D611	STR-D511
FRONT	80 W/CH	70 W/CH
CENTER (only in the DOLBY mode)	20 W	10 W
REAR	20 W	10 W

Other Specifications

Amplifier section

Continuous RMS power output (8 ohms, at 40 Hz - 20 kHz less than 0.8% total harmonic distortion) (FRONT)

STR-D611: 75 W + 75 W

STR-D511: 55 W + 55 W

Dynamic power (at 1 kHz IHF) (FRONT)

STR-D611: 90 W + 90 W (8 ohms), 120 W + 120 W (4 ohms)

STR-D511: 80 W + 80 W (8 ohms), 110 W + 110 W (4 ohms)

Harmonic distortion

Less than 0.8% at rated output

Frequency response

PHONO: RIAA equalization curve ± 0.5 dB

CD

VIDEO

TAPE

10 Hz - 50 kHz ± 1 dB

Inputs

	Sensitivity	Impedance	S/N (weighting network, input level)
PHONO	2.5 mV	50 kilohms	74 dB 72 dB* (A, 2.5 mV)
CD	300 mV	50 kilohms	95 dB 80 dB* (A, 200 mV)
VIDEO 1, 2 TAPE	200 mV		

* '78 IHF

Outputs

REC OUT, VIDEO 1 (AUDIO) OUT	Voltage 200 mV Impedance 10 kilohms
HEADPHONES	Accepts low and high impedance headphones

Tone controls

BASS: ± 10 dB at 100 Hz

TREBLE: ± 8 dB at 10 kHz

Muting

-20 dB

DBFB

+7 dB at 70 Hz

Video section

INPUT	VIDEO 1,2	1 Vp-p 75 ohms
OUTPUT	VIDEO 1 MONITOR	1 Vp-p 75 ohms

Tuner section

	FM tuner section	AM tuner section
Tuning range	87.5 — 108 MHz	530 — 1710 kHz (10 kHz step) 531 — 1602 kHz (9 kHz step)
Antenna terminals	300 ohms, balanced 75 ohms, unbalanced	External antenna terminal
Sensitivity at 50 dB quieting	18.3 dBf, 4.5 μ V (mono) 38.3 dBf, 45 μ V (stereo)	—
Usable sensitivity	11.2 dBf, 2 μ V (IHF)	Loop antenna: 500 μ V (at 1,000 kHz)
Signal-to-noise ratio	76 dB (mono) 70 dB (stereo)	54 dB (at 50 mV/m)
Harmonic distortion	0.3% (mono), 0.5% (stereo) at 1 kHz	0.5% (at 50 mV/m, 400 Hz)
Selectivity	60 dB at 400 kHz	40 dB at 10 kHz
Separation	45 dB at 1 kHz	—
Frequency response	30 Hz — 15 kHz $+0.5$ dB -2	—

General

System

Tuner section: PLL quartz-locked digital synthesizer system

Preamplifier section: low-noise NF type equalizer amp

Power amplifier section: pure complementary SEPP

Power requirements

120 V AC, 60 Hz

Power consumption

U.S.A. model: 170 W (STR-D611)

140 W (STR-D511)

Canadian model: 180 W (STR-D611)

155 W (STR-D511)

AC outlet

One switched (120 W/1A Max.)

Dimensions

Approx. 430 x 135 x 295 mm (w/h/d)

(17 x 5 $\frac{3}{8}$ x 11 $\frac{5}{8}$ inches)

including projecting parts and controls

Mass

Approx. 6.4 kg (14 lb 20 oz) (STR-D611)

Approx. 5.9 kg (13 lb 1 oz) (STR-D511)

Accessories supplied

FM wire antenna (1)

AM loop antenna (1)

Remote Commander RM-U232 (1)

Sony batteries SUM-3(NS) (2)

Design and specifications are subject to change without notice.

Specifications

(For U.K. and Australian models)

Amplifier section

Continuous RMS power output (8 ohms, at 40 Hz - 20 kHz less than 0.8% total harmonic distortion) (FRONT)

STR-D611: 60 W + 60 W

STR-D511: 50 W + 50 W

Dynamic power (at 1 kHz IHF) (FRONT)

STR-D611: 80 W + 80 W (8 ohms), 110 W + 110 W (4 ohms)

STR-D511: 70 W + 70 W (8 ohms), 100 W + 100 W (4 ohms)

Harmonic distortion

Less than 0.8% at rated output

SUR (surround) MODE (8 ohms, less than 0.8% total harmonic distortion)

	STR-D611	STR-D511
FRONT	60 W +60 W	50 W +50 W
CENTER (only in the DOLBY mode)	20 W	10 W
REAR	20 W	10 W

Frequency response

PHONO: RIAA equalization curve ± 0.5 dB

CD
VIDEO
TAPE } 10 Hz - 50 kHz ± 1 dB

Inputs

	Sensitivity	Impedance	S/N (weighting network, input level)
PHONO	2.5 mV	50 kilohms	74 dB 72 dB* (A, 2.5 mV)
CD	300 mV	50 kilohms	95 dB 80 dB* (A, 200 mV)
VIDEO 1,2 TAPE	200 mV		

* '78 IHF

Outputs

REC OUT, VIDEO 1 (AUDIO) OUT	Voltage 200 mV Impedance 10 kilohms
HEADPHONES	Accepts low and high impedance headphones

Tone controls

BASS: ± 10 dB at 100 Hz

TREBLE: ± 8 dB at 10 kHz

Muting

-20 dB

DBFB

+7 dB at 70 Hz

Video section

INPUT	VIDEO 1,2	1 Vp-p 75 ohms
OUTPUT	VIDEO 1 MONITOR	1 Vp-p 75 ohms

Tuner section

	FM tuner section	AM tuner section
Tuning range	87.5 — 108 MHz	531 — 1,602 kHz
Antenna terminals	300 ohms, balanced 75 ohms, unbalanced	External antenna terminal
Sensitivity at 3-dB quieting	18.3 dBf, 4.5 μ V (mono) 38.3 dBf, 45 μ V (stereo)	—
Usable sensitivity	11.2 dBf, 2 μ V (IHF)	Loop antenna: 500 μ V (at 999 kHz)
Signal-to-noise ratio	70 dB (mono) 66 dB (stereo)	54 dB (at 50 mV/m)
Harmonic distortion	0.3% (mono), 0.5% (stereo) at 1 kHz	0.5% (at 50 mV/m, 400 Hz)
Selectivity	60 dB at 400 kHz	30 dB at 9 kHz
Separation	45 dB at 1 kHz	—
Frequency response	30 Hz — 15 kHz $+0.5$ dB -2	—

General

System

Tuner section: PLL quartz-locked digital synthesizer system

Preamplifier section: low-noise NF type equalizer amp

Power amplifier section: pure complementary SEPP

Power requirements

240 V AC, 50/60 Hz (for U.K. model)

240 V AC, 50 Hz (for Australian model)

Power consumption

160 W (STR-D611)

135 W (STR-D511)

In standby condition: 5 W

AC outlet

One switched (100 W Max.)

Dimensions

Approx. 430 x 135 x 295 mm (w/h/d)

(17 x 5 $\frac{3}{8}$ x 11 $\frac{3}{8}$ inches)

including projecting parts and controls

Mass

Approx. 6.9 kg (15 lb 4 oz) (STR-D611)

Approx. 6.4 kg (14 lb 2 oz) (STR-D511)

Accessories supplied

FM wire antenna (1)

AM loop antenna (1)

Remote Commander RM-U232 (1)

Sony batteries SUM-3(NS) (2)

Design and specifications are subject to change without notice.

Note

This appliance conforms with EEC Directive 87/308/EEC regarding interference suppression.

Free Manuals Download Website

<http://myh66.com>

<http://usermanuals.us>

<http://www.somanuals.com>

<http://www.4manuals.cc>

<http://www.manual-lib.com>

<http://www.404manual.com>

<http://www.luxmanual.com>

<http://aubethermostatmanual.com>

Golf course search by state

<http://golfingnear.com>

Email search by domain

<http://emailbydomain.com>

Auto manuals search

<http://auto.somanuals.com>

TV manuals search

<http://tv.somanuals.com>