

FM Stereo FM-AM Receiver

Operating Instructions

***STR-DE1015G
STR-DE815G
STR-D760Z***

WARNING

To prevent fire or shock hazard, do not expose the unit to rain or moisture.

For customers in the U.S.A.

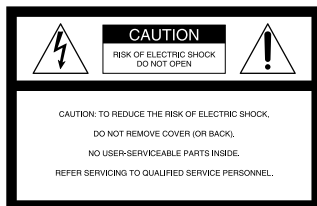

This symbol is intended to alert the user to the presence of uninsulated “dangerous voltage” within the product’s enclosure that may be of sufficient magnitude to constitute a risk of electric shock to persons.



This symbol is intended to alert the user to the presence of important operating and main maintenance (servicing) instructions in the literature accompanying the appliance.

INFORMATION

This equipment has been tested and found to comply with the limits for a Class B digital device, pursuant to Part 15 of the FCC Rules.

These limits are designed to provide reasonable protection against harmful interference in a residential installation. This equipment generates, uses, and can radiate radio frequency energy and, if not installed and used in accordance with the instructions, may cause harmful interference to radio communications. However, there is no guarantee that interference will not occur in a particular installation. If this equipment does cause harmful interference to radio or television reception, which can be determined by turning the equipment off and on, the user is encouraged to try to correct the interference by one or more of the following measures:

- Reorient or relocate the receiving antenna.
- Increase the separation between the equipment and receiver.
- Connect the equipment into an outlet on a circuit different from that to which the receiver is connected.
- Consult the dealer or an experienced radio/TV technician for help.

CAUTION

You are cautioned that any changes or modification not expressly approved in this manual could void your authority to operate this equipment.

Note to CATV system installer

This reminder is provided to call CATV system installer’s attention to Article 820-40 of the NEC that provides guidelines for proper grounding and, in particular, specifies that the cable ground shall be connected to the grounding system of the building, as close to the point of cable entry as practical.

Owner’s record

The model and serial numbers are located on the rear of the unit. Record the serial number in the space provided below. Refer to them whenever you call upon your Sony dealer regarding this product.

Model No. STR-DE1015G
 STR-DE815G
 STR-D760Z

Serial No. _____

For customers in Canada

CAUTION

TO PREVENT ELECTRIC SHOCK, DO NOT USE THIS POLARIZED AC PLUG WITH AN EXTENSION CORD, RECEPTACLE OR OTHER OUTLET UNLESS THE BLADES CAN BE FULLY INSERTED TO PREVENT BLADE EXPOSURE.

This receiver incorporates the Dolby* Pro Logic Surround system.

* Manufactured under license from Dolby Laboratories Licensing Corporation. “Dolby,” the double-D symbol , “AC-3” and “Pro Logic” are trademarks of Dolby Laboratories Licensing Corporation.

Precautions

On safety

- Should any solid object or liquid fall into the cabinet, unplug the receiver and have it checked by qualified personnel before operating it any further.

On power sources

- Before operating the receiver, check that the operating voltage is identical with your local power supply. The operating voltage is indicated on the nameplate at the rear of the receiver.
- This unit is not disconnected from the AC power source (mains) as long as it is connected to the wall outlet, even if the unit itself has been turned off.
- If you are not going to use the receiver for a long time, be sure to disconnect the receiver from the wall outlet. To disconnect the AC power cord, grasp the plug itself; never pull the cord.
- One blade of the plug is wider than the other for the purpose of safety and will fit into the wall outlet only one way. If you are unable to insert the plug fully into the outlet, contact your dealer.
- AC power cord must be changed only at the qualified service shop.

On placement

- Do not install the appliance in a confined space, such as a bookcase or built-in cabinet.
- Place the receiver in a location with adequate ventilation to prevent heat buildup and prolong the life of the receiver.
- Do not place the receiver near heat sources, or in a place subject to direct sunlight, excessive dust or mechanical shock.
- Do not place anything on top of the cabinet that might block the ventilation holes and cause malfunctions.

On operation

- Before connecting other components, be sure to turn off and unplug the receiver.

On cleaning

- Clean the cabinet, panel and controls with a soft cloth slightly moistened with a mild detergent solution. Do not use any type of abrasive pad, scouring powder or solvent such as alcohol or benzine.

For customers in the USA

For detailed safety precautions, see the "IMPORTANT SAFEGUARDS" leaflet.

If you have any question or problem concerning your receiver, please consult your nearest Sony dealer.

About This Manual

The instructions in this manual are for models STR-DE1015G, STR-DE815G and STR-D760Z. Check your model number by looking at the upper right corner of the front panel. Functionally, the main difference between the models is that the STR-DE1015G is equipped with a Dolby Digital (AC-3) decoder and the STR-DE815G and STR-D760Z are not.

In this manual, the STR-DE1015G is the model used for illustration purposes, any difference in operation is clearly indicated in the text, for example, "STR-DE1015G only."

This manual is divided into three sections; Getting Started, On-screen Operations and Front Panel Operations.

The "Getting Started" section describes connections, how to set up the remote for on-screen control, and Dolby Surround.

The "On-Screen Operations" section describes how to operate the receiver using the remote to manipulate the on-screen display on your TV screen. The remote lets you perform almost all of the receiver operations.

You can also control the receiver without the remote. The "Front Panel Operations" section describes how to operate the receiver using the front panel controls. In addition, for the USA and Canadian models, this section also explains how to use the remote short-cut buttons.

The following icon is used in this manual:



Indicates hints and tips for making the task easier.

Table of contents

Welcome! 4

Hooking Up the System

Hookup Overview 5
Infrared (IR) Repeater Hookups 7
Antenna Hookups 7
Audio Component Hookups 8
Speaker System Hookups 9
TV/VCR Hookups 11
Digital Component Hookups (STR-DE1015G only) 13
AC Hookups 14

Setting Up the Remote for On-Screen Control

Using the Remote 15
Registering a TV (or Monitor) 17
Registering Audio and Video Components 19

Dolby Surround Setup

Dolby Digital (AC-3) (STR-DE1015G only) 22
Dolby Pro Logic (STR-DE815G and STR-D760Z) 24

Playback/Recording

Selecting a Component 26
Watching TV or Video Programs 28
Tuning and Presetting Radio Stations 29
Recording 31

Sound Adjustment

Using the Pre-programmed Sound Field 33
Customizing the Sound Fields 37

Additional Operations and Settings

Registering Desired Component (User IR setting) 42
Indexing 43
Playing Sources Automatically (Auto Play) 44
Starting a Source Automatically at Power On (Auto Start) 44
Starting Several Components in Sequence Automatically (Macro Play) 45
Adjusting the Sensitivity of the Remote 46
Changing the Display Settings 46
Using the Sleep Timer 48
Operating a CD Changer 48

Front Panel Operations (Remote Short-cuts: USA and Canada only)

Front Panel Descriptions 51
Remote Descriptions 52
Selecting a Component 53
Tuning Radio Stations 54
Recording 55
Adjusting the Sound 55
Customizing the Receiver Operations 57
Indexing 59
Playing Audio Sources Without the TV (Flasher) (except for USA and Canada) 60

Additional Information

Troubleshooting 61
Specifications 63
Glossary 65
Index (Back Cover)

Getting Started

On-Screen Operations

Front Panel Operations

Thank you for purchasing the STR-DE1015G, STR-DE815G or STR-D760Z Sony FM Stereo/FM-AM Receiver.

Your new receiver is an audio/video control center with a unique interface. When you connect the receiver to your TV, an on-screen display (shown below) appears and lets you operate the various connected audio/video components with this receiver's remote.

Also, the on-screen display lets you control any other device that can be controlled by an infrared remote control, such as air conditioners.

About the color system for video input

This unit is compatible with the following color systems.

USA and Canadian model :	NTSC
Australian model :	PAL*
Singaporean model :	PAL*
Other countries :	NTSC

* Although the normal OSD is displayed in color, when video signals are input from other components the OSD is displayed in black and white.

Understanding How the Receiver Works

- 1 The remote emits an infrared (IR) signal when you press direction control button (see ① below).
- 2 This controls the movement of the pointer (hand-shaped icon) in the on-screen display (see ② below).
- 3 When you move the pointer to an on-screen icon, and press the center of the direction control button on the remote, the infrared (IR) emitter on the front panel transmits the corresponding IR control code to the respective component (see ③ below).

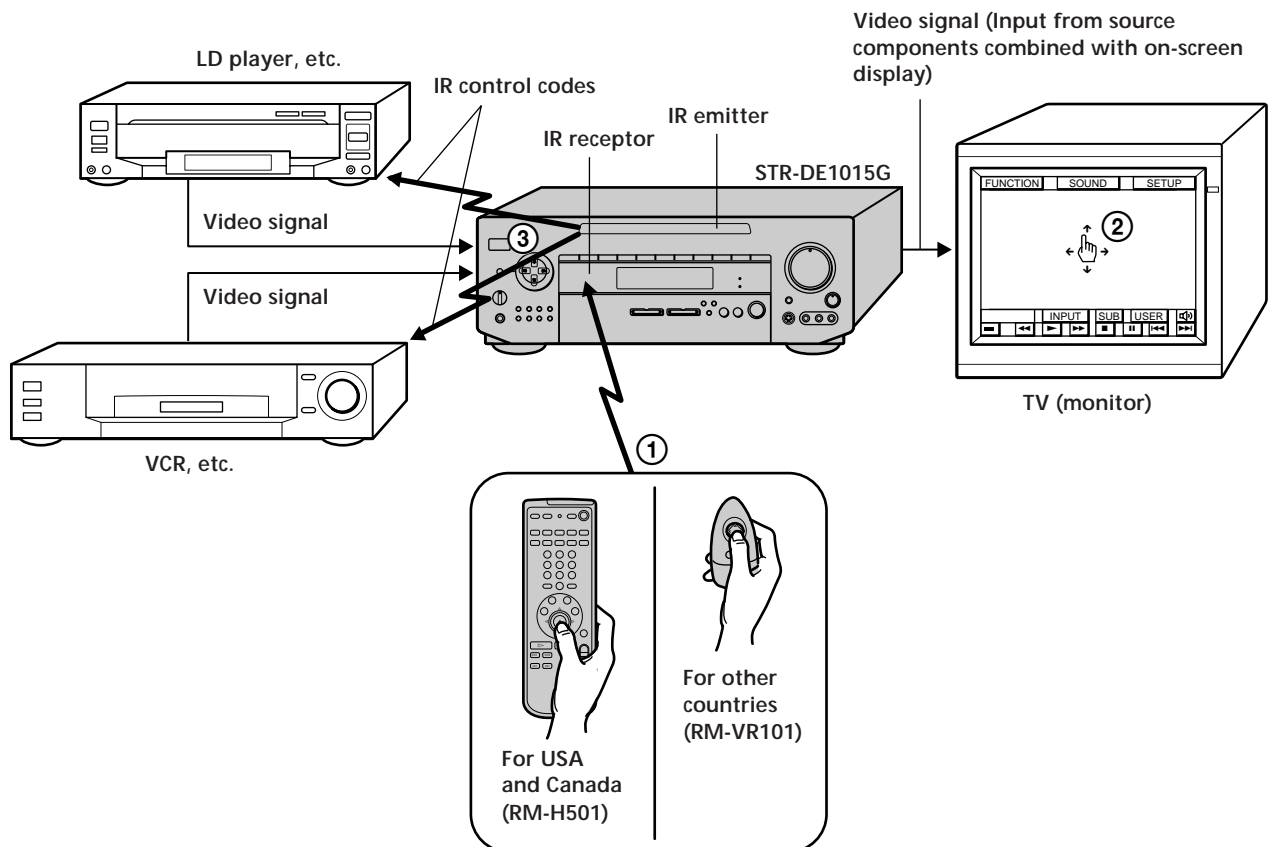

Hookup Overview

The receiver allows you to connect and control the following audio/video components. For details on connection of each component, see the pages in parentheses.

■ STR-DE1015G

Infrared (IR) Repeater Hookups (7)

TV/VCR Hookups (11)

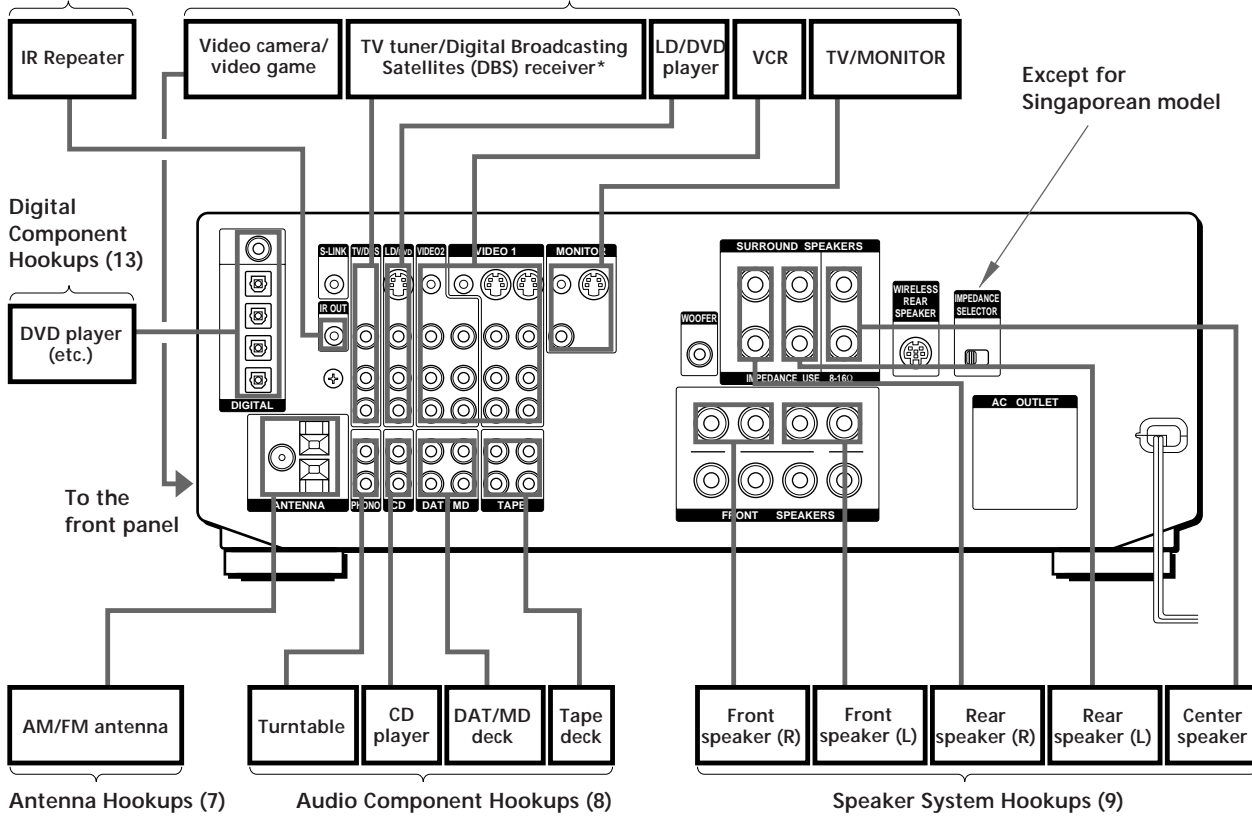

* DBS receivers can be used with USA, Canadian and Australian models only.

Hooking Up the System

■ STR-DE815G and STR-D760Z

Infrared (IR) Repeater
Hookups (7)

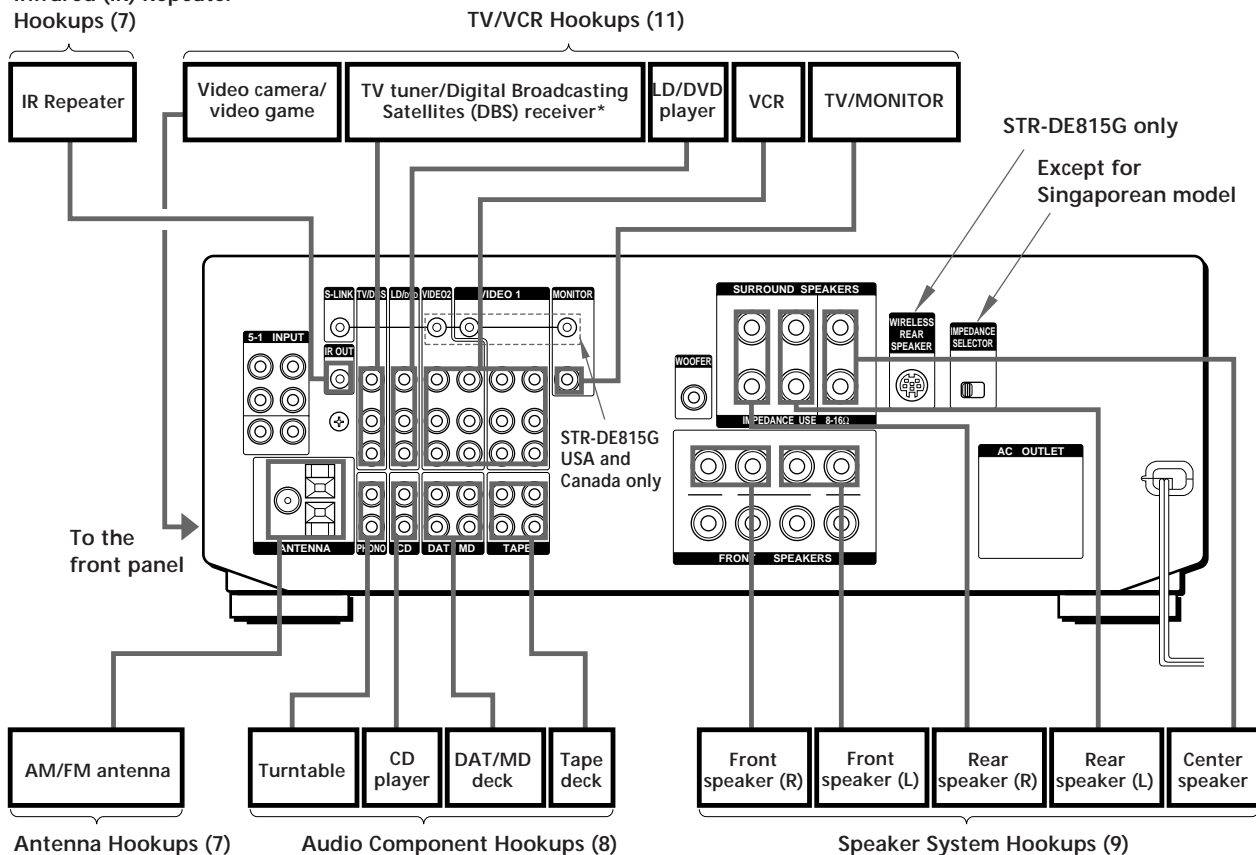

* DBS receivers can be used with USA, Canadian and Australian models only.

Before you get started

- Check that you received the following items with the receiver:
 - FM wire antenna (1)
 - AM loop antenna (1)
 - Remote commander (remote) (1)
(remote for USA and Canada: RM-H501)
(Remote for other countries: RM-VR101)
 - Size AA (R6) batteries (2)
 - IR repeater (1)
 - Video Cable (1)
(USA and Canadian models only)
 - Control S cable for TV (1)
(USA and Canadian models only)
- Turn off the power to all components before making any connections.
- Do not connect the AC power cords until all of the connections are completed.
- Be sure to make connections firmly to avoid hum and noise.

Infrared (IR) Repeater Hookups

The IR repeater emits infrared signals corresponding to those emitted by the remote controls supplied with the components. Connect the IR repeater if:

- You experience difficulty controlling a certain component using the on-screen display control.
- Your installation configuration prevents the IR repeater on the receiver's front panel from reaching all of the components you need to control.

After connecting the IR repeater, set it above or below the IR sensor on the component(s) to be controlled. Each IR repeater can send infrared signals to one component.

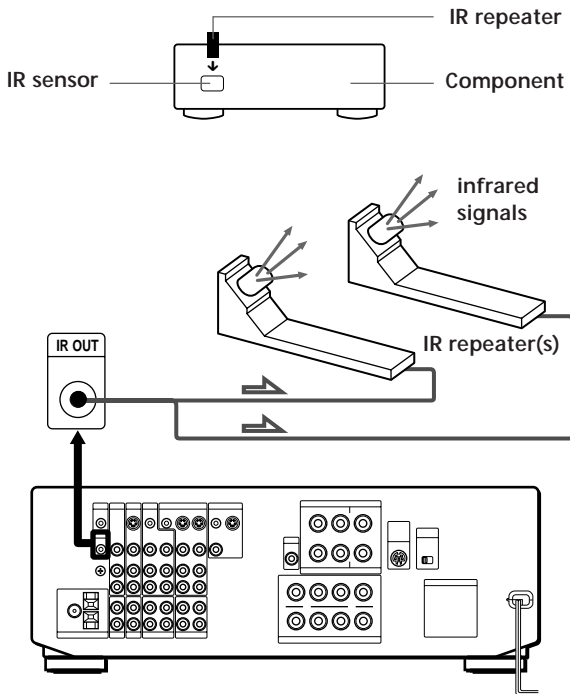

Note

Use the supplied adhesive tape to secure the IR repeater so that its front faces the component to be controlled.

Antenna Hookups

You can receive radio broadcasts by connecting FM and AM antennas.

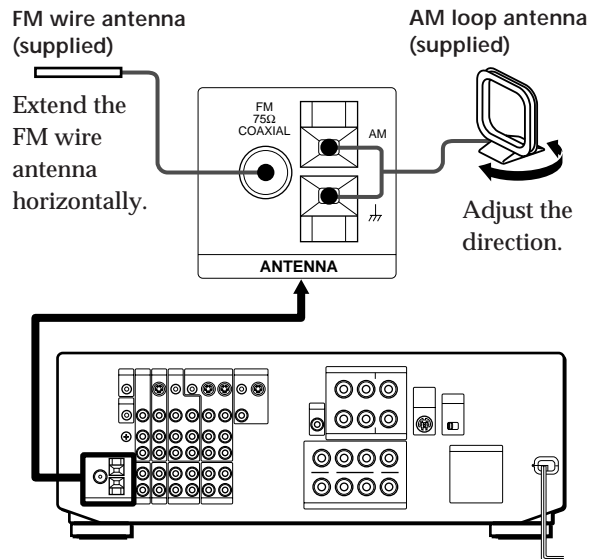

Connecting an outdoor antenna

We recommend that you connect an outdoor antenna for better reception. Connect an optional FM outdoor antenna for FM.

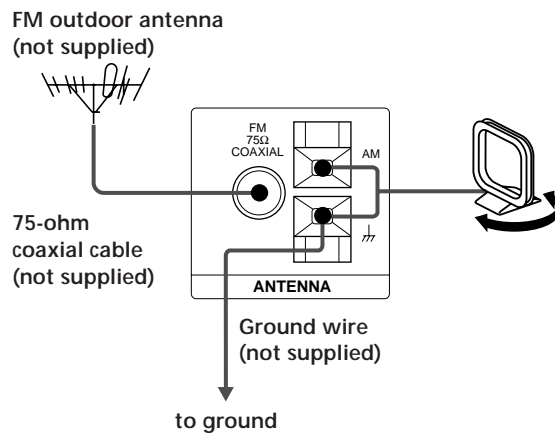

Important

If you connect an outdoor antenna, ground it against lightning. To prevent a gas explosion, do not connect the ground wire to a gas pipe.

Notes

- Do not use the \hbar SIGNAL GND for this connection.
- To prevent noise pickup, keep the AM loop antenna away from the receiver and TV.

Audio Component Hookups

You can use the receiver as an amplifier by completing these connections.

If your components are Sony products, connect them to the jacks as shown in the table on page 19 so that the IR registration is unnecessary.

Note for STR-DE1015G

For digital connections see "Digital Component Hookups" (page 13).

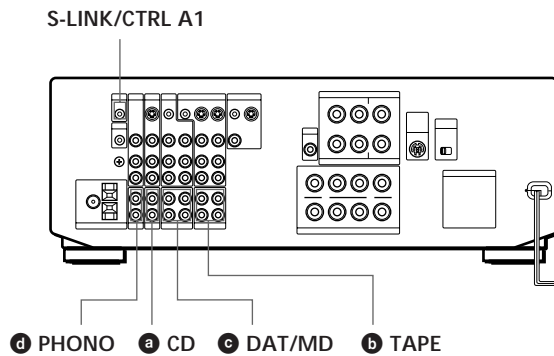

What cords will I need?
Audio cord (not supplied)

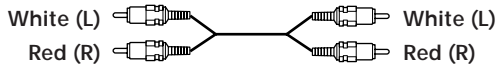

↔ : signal flow

③ CD (to CD player)

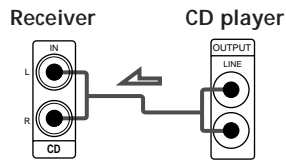

② TAPE (to a tape deck)

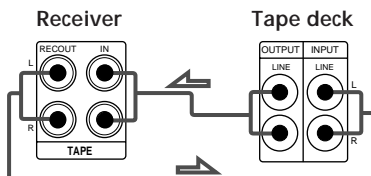

① DAT/MD (to DAT/MD deck)

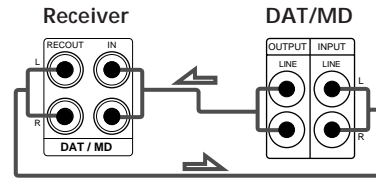

④ PHONO (to a turntable)*

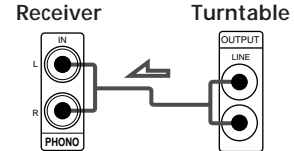

* If your turntable has an earth lead, connect it to \hbar SIGNAL GND on the unit to prevent hum.

💡 To use Sony components with a CONTROL A1 terminal

You can connect a CONTROL A1 compatible Sony CD player, tape deck or MD deck to the receiver. Use a CONTROL A1 cord (not supplied) to connect the CTRL A1 jack on each component to the S-LINK CTRL A1 jack on the receiver. See the instructions for each component.

💡 You can display the operating status of the component connected to the CTRL A1 jack
See page 58 for DTR-DE1015G.
See page 59 for STR-DE815G.

💡 To use a Sony CD changer with a COMMAND MODE selector

- If the changer does not have a VIDEO OUT jack, set the command mode to "CD 1" and connect the changer to the CD jack on the receiver.
- If the changer has a VIDEO OUT jack, set the command mode to "CD 2" and connect the changer to the VIDEO 1, VIDEO 2, or LD jack on the receiver.

Speaker System Hookups

Although front (left and right) speakers are required, center and rear speakers are required only for enjoying surround sound.

What cords will I need?
Speaker cord (not supplied)



Twist the stripped ends of the cord about 2/3 inch (15 mm). Be sure to match the speaker cord to the appropriate terminal on the components: + to + and - to -. If the cords are reversed, the sound will be distorted and will lack bass.

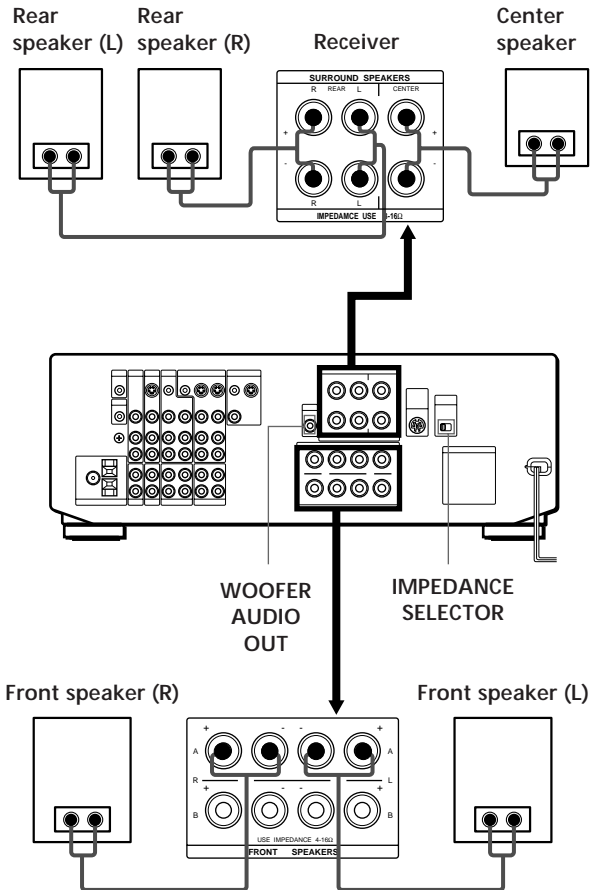

Speaker placement for STR-DE1015G

Normally, to obtain the best possible surround sound all speakers should be placed the same distance from your listening position (A).

This unit, however, allows you to place the center speaker closer (B), so that it lines up with the front speakers. The rear speakers can also be placed closer (C), according to the shape of your room.

If you feel that this placement reduces the surround effects, you can adjust the center and rear delay parameters to obtain the effect you desire (see page 39).

Note

To take full advantage of Dolby Digital (AC-3) surround effects we recommend using high quality speakers. We also recommend using front, center, and rear speakers that are of the same size and quality.

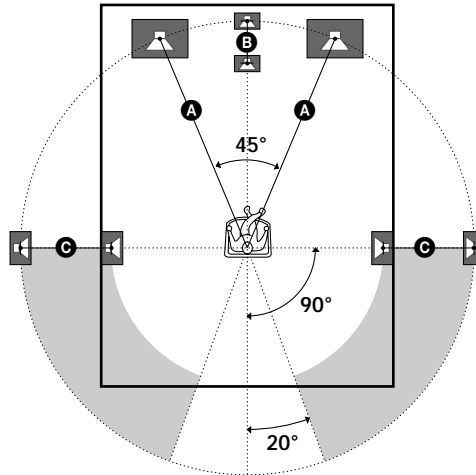

Notes

- Do not place the center or rear speakers farther away from the listening position than the front speakers.
- When mounting the rear speakers on side walls perpendicular to the listening position they should be placed 60 - 90 cm (24 - 35 inches) above the listening position (as shown in "Speaker placement for STR-DE815G and STR-D760Z" on page 10).

Hooking Up the System

Depending on the shape of your room (etc.), you may wish to place the rear speakers behind you instead of on the side walls. One advantage of this placement is that you can use a pair of large floor standing speakers matching your front speakers.

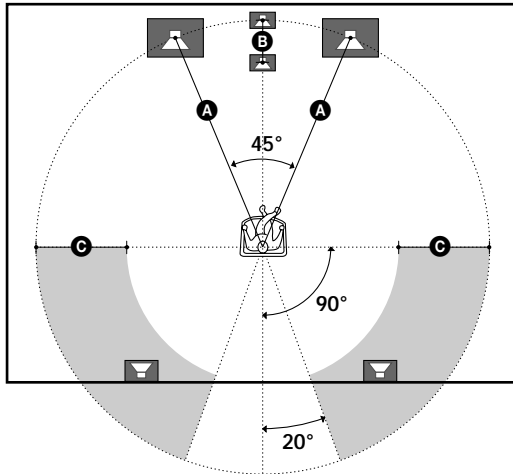

Note

If you place the rear speakers behind you, be sure to check the rear speaker position setting in the SPEAKER SETUP before using the VIRTUAL MULTI REAR and VIRTUAL REAR SHIFT sound fields (see pages 22 and 33 to 34 for details).

Speaker placement for STR-DE815G and STR-D760Z

For optimum surround sound effect, place your speakers as shown below.

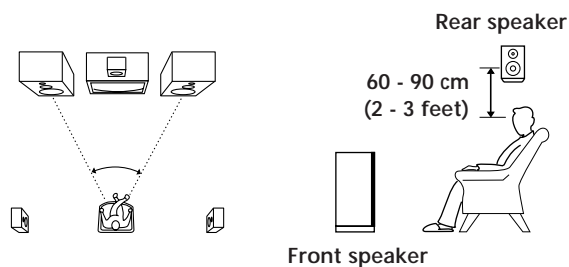

You can connect an active woofer

You can reinforce the bass sound by connecting an optional active woofer to the WOOFER AUDIO OUT terminal.

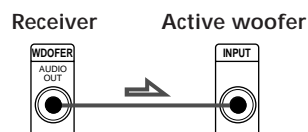

You can connect wireless rear speakers (except for STR-D760Z)

When using an optional Sony wireless rear speaker system, connect the transmitter to the WIRELESS REAR SPEAKER connector.

Note

Do not connect any other components to the WIRELESS REAR SPEAKER connector.

Selecting the speaker system

You can connect one set or two sets of speakers. Set the SPEAKERS selector on the front panel according to your speaker system.

To drive	Set SPEAKERS selector to
Speaker system A (connected to the FRONT SPEAKERS A terminals)	A
Speaker system B (connected to the FRONT SPEAKERS B terminals)	B
Both speaker systems A and B (parallel connection)	A+B*

* Connect speakers with nominal impedance of 8 ohms, or higher, to the A and B terminals.

Selecting the impedance (except for Singaporean models)

Check the impedance of your speakers (usually indicated on the back of the speaker), and set the IMPEDANCE SELECTOR for the front speakers.

If nominal impedance of your speaker is	Set IMPEDANCE SELECTOR your speaker is to
Between 4 and 8 ohms	4 Ω
8 ohms or higher	8 Ω

TV-VCR Hookups

You must connect a TV to control the receiver using the on-screen display. Also, to enjoy the Dolby Pro Logic Surround encoded videos and TV programs, you need to connect TV and VCRs together with the center and rear speakers.

If your components are Sony products, connect them to the jacks as shown in the table on page 19, this makes IR registration unnecessary.

■ STR-DE1015G

For digital connections see "Digital Component Hookups" (page 13)

- d TV/DBS* c LD/DVD b VIDEO 1, 2 a MONITOR

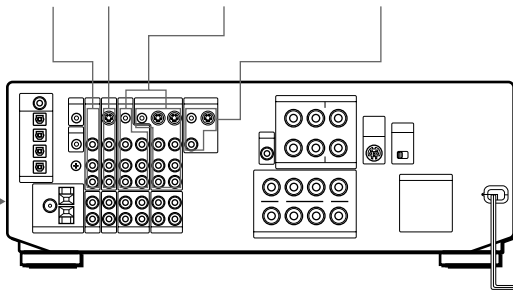

- e VIDEO 3 INPUT
(on the front panel)

■ STR-DE815G and STR-DE760Z

- d TV/DBS* c LD/DVD b VIDEO 1, 2 a MONITOR

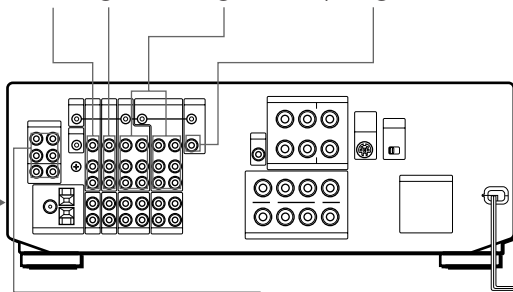

- e VIDEO 3 INPUT
(on the front panel)
- 5.1 INPUT

* TV/DBS : USA, Canada and Australia
TV : Other countries

What cables will I need?

- Audio/video cable (not supplied)

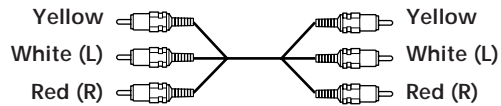

- Video cable (not supplied)

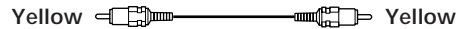

Make sure to match the color of the plugs and the jacks: Yellow (video) to Yellow; White (left, audio) to White; and Red (right, audio) to Red. If your components have S-video jacks, we recommend that you use the S-video jacks instead of the video jacks.

↔ : signal flow

ⓐ MONITOR (to TV or monitor)

Be sure to use your TV as a monitor, and use the TV tuner built-in to the VCR to watch TV programs. If you use your TV's tuner, the on-screen display will change to a TV program when you switch channels. Also, do not connect anything to the TV/DBS* IN jacks.

If you connect a Sony TV with TV OUT jacks, you can use the TV tuner in your TV (see page 28 for details) and the TV/DBS IN jacks without disrupting the on-screen display.

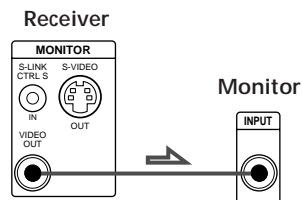

ⓑ VIDEO 1, 2 (to VCR)

Connect VCRs to the VIDEO 1 or/and VIDEO 2 jacks. If you connect a Sony StarSight tuner, connect it to the VIDEO 1 jacks.

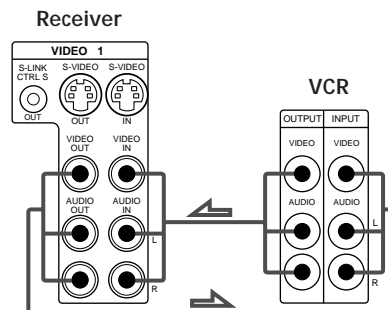

Hooking Up the System

c LD/DVD (to LD or DVD player)

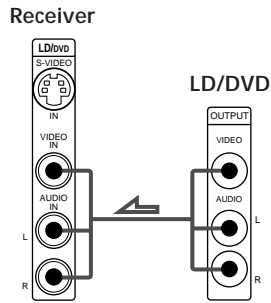

Note for STR-DE815G and STR-D760Z

To input decoded Dolby Digital (AC-3) soundtracks, make connections as shown below in "Playing decoded Dolby Digital (AC-3) soundtracks".

d TV/DBS* (to TV tuner or Digital Broadcasting Satellites (DBS) receiver)

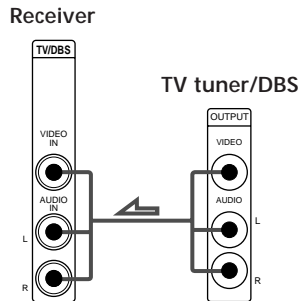

e VIDEO 3 INPUT (to a video camera or a video game)

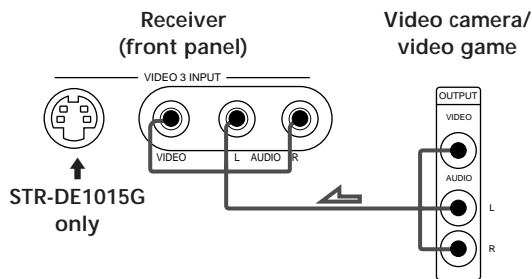

* TV/DBS : USA, Canada and Australia
TV : Other countries

💡 If you have a CONTROL S compatible monitor or VCR (for USA and Canada only)

Use a CONTROL S cord (supplied) to connect the CTRL S IN (for monitor) or CTRL S OUT (for VCR) jack on the receiver to the appropriate S-LINK jack on the respective component. Refer to the Operating Instructions supplied with your monitor or VCR for details.

Note

Set the TV tuner to skip channels where there is no broadcast so that an image is always displayed on the TV screen; otherwise, the on-screen display is distorted.

Playing decoded Dolby Digital (AC-3) soundtracks (STR-DE815G and STR-D760Z)

If you have a Dolby Digital (AC-3) decoder, you can use the receiver to amplify decoded Dolby Digital (AC-3) soundtracks with the following connections. These audio signals are paired with the video signals input to the LD/DVD VIDEO IN jack (see page 27 for details regarding operation).

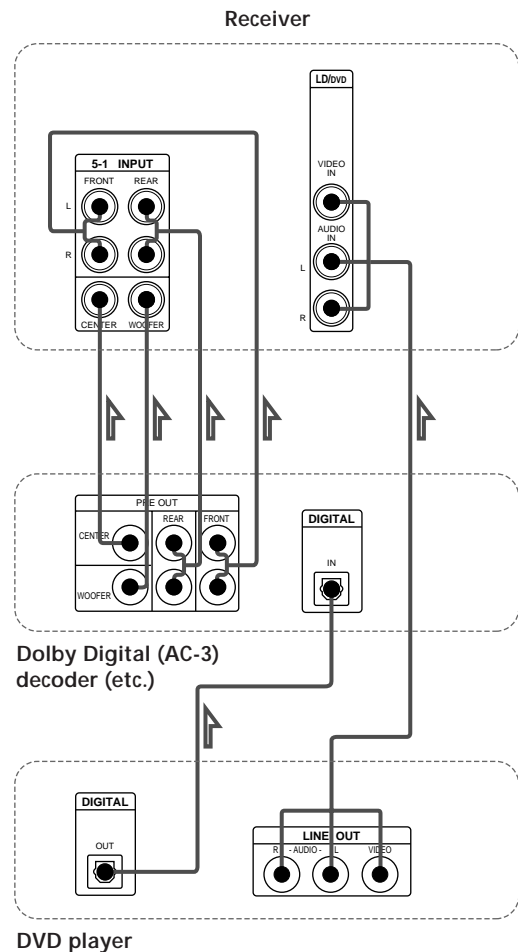

Digital Component Hookups (STR-DE1015G only)

You can connect the optical digital output jack of a DVD player, DAT/MD deck, CD player (etc.) to the receiver's optical digital input jacks.

You can also connect the AC-3 RF output terminal of an LD player to the receiver's AC-3 RF input terminal.

You can connect the receiver's optical digital output jack to a DAT/MD deck.

After making digital connections, also be sure to select the appropriate INPUT MODE (see page 27 for details).

- a LD/DVD: OPTICAL
- b LD/DVD: RF
- c CD IN: OPTICAL

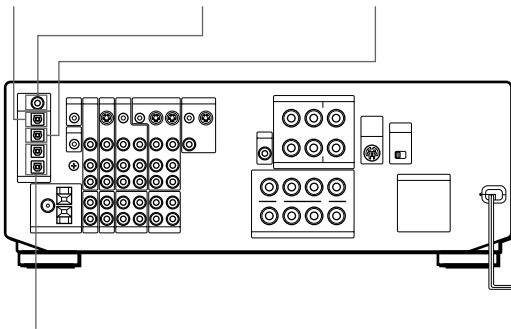

- d DAT/MD IN (OUT): OPTICAL

What cords will I need?

- Optical digital connecting cord (not supplied)
- Coaxial digital connection cord (not supplied)

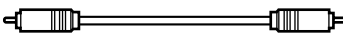
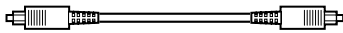

↔ : signal flow

- a LD/DVD IN: OPTICAL (to DVD player)

If you connect a DVD player to the analog LD/DVD in jacks, be sure to connect the DVD player's optical digital output to the LD/DVD IN : OPTICAL jack.

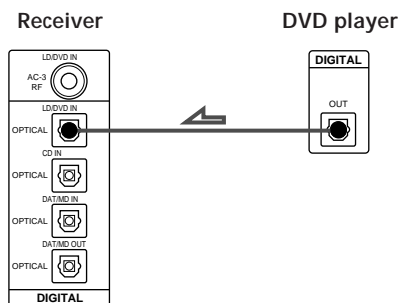

- b LD/DVD IN: AC-3 RF (to LD player)

If you connect an LD player to the analog LD/DVD in jacks, be sure to connect the LD player's AC-3 RF output to the LD/DVD IN: AC-3 RF jack.

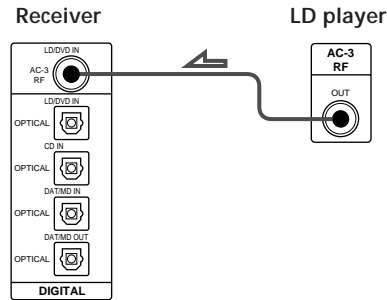

- c CD IN: OPTICAL (to CD player)

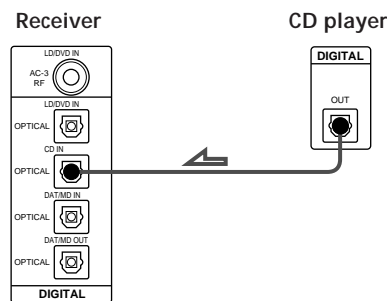

- d DAT/MD IN(OUT):OPTICAL (to DAT or MD deck)

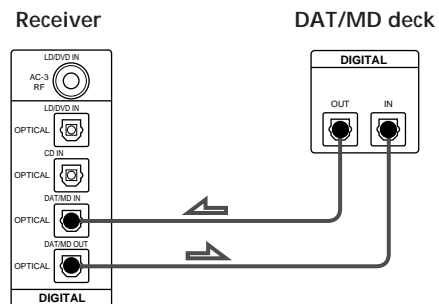

Note

This unit is only compatible with digital components using 32 kHz/44.1 kHz/48 kHz sampling frequencies. It is not compatible with 96 kHz.

Warning regarding the playback of DAT/MD sources
When playing DAT/MD sources through this unit, do not play a DAT/MD that contains digital recordings made from a DVD player whose digital output was set to "DOLBY DIGITAL". High volume noise will be output which may damage this unit or your speakers.

AC Hookups

Setting the voltage selector (only on the models supplied with the voltage selector)

Check that the voltage selector on the rear panel of the receiver is set to the local power supply voltage. If not, set the selector to the correct position using a screwdriver before connecting the AC power cord to a wall outlet.

Connecting the AC power cord

Connect the AC power cord from this receiver and from your audio/video components to a wall outlet. If you connect other audio components to the SWITCHED AC OUTLET(s) on the receiver, the receiver can supply power to the connected components so you can turn on/off the entire system when you turn on/off the receiver.

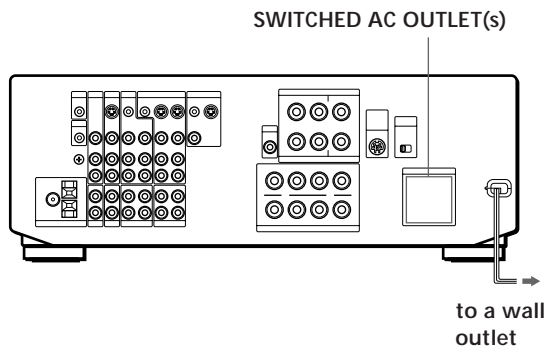

Caution

Make sure that the power consumption of the component(s) connected to the receiver's AC outlet(s) does not exceed the wattage indicated on the rear panel. Do not connect high-wattage electrical home appliances such as electric irons, fans, or TVs to this outlet.

Before using for the first time

Be sure to clear the receiver's memory before using for the first time.

- 1 Make sure the POWER is set to off.
- 2 While holding down the VIDEO FUNCTION >, AUDIO FUNCTION > and SOUND FIELD MODE buttons, press POWER to turn on the receiver.
"ALL CLEAR!" appears in the display.

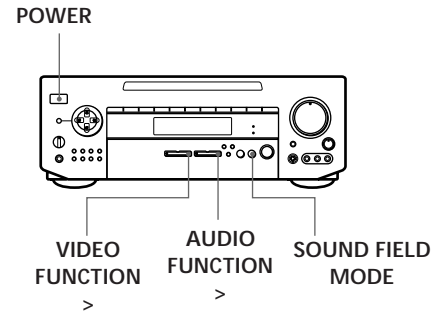

Note

Clearing the receiver's memory erases all preset radio stations and IR code settings etc.

Using the Remote

Inserting batteries into the remote (USA and Canada)

Insert two size AA (R6) batteries with the + and - on the battery compartment. When using the remote, point it at the remote sensor  on the receiver.

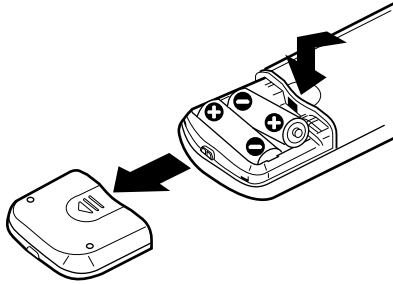

Inserting batteries into the remote (other countries)

1 Open the cover on the bottom of the remote.

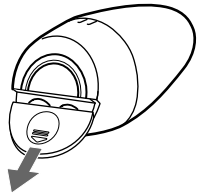

2 Insert two size AA (R6) batteries with correct polarity (+/-), then close the cover.

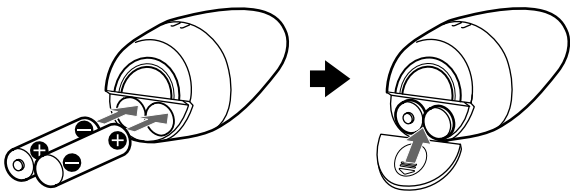

Turning on the receiver and bringing up the on-screen display on your TV (or monitor)

To turn on the receiver, point the remote at the IR receptor, and then press the direction control button on the remote once or twice. To bring up the on-screen display, turn on your TV and set it to the appropriate video input. If you register the IR code of your TV (see "Registering a TV (or Monitor)" on page 17), you can turn on your TV automatically whenever you turn on the receiver.

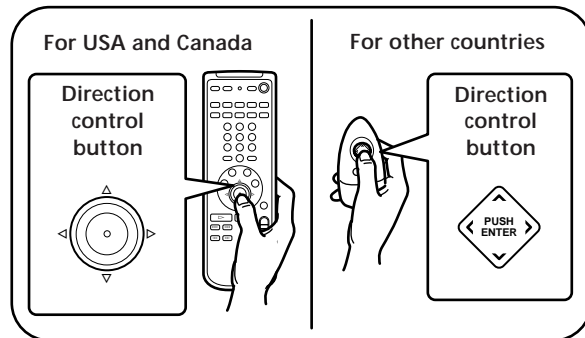
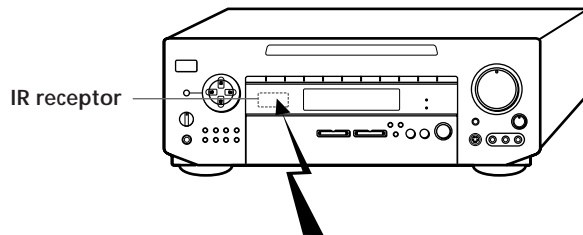

Notes on the remote

Battery life

Under normal use, the batteries should last for about 6 months. When the remote no longer operates the receiver, replace both batteries with new ones.

Notes

- Do not leave the remote in an extremely hot or humid place.
- Do not use a new battery with an old one.
- Do not expose the remote sensor to direct sunlight or lighting apparatuses. Doing so may cause a malfunction.
- If you don't use the remote for an extended period of time, remove the batteries to avoid possible damage from battery leakage and corrosion.

(continued)

Setting Up the Remote for On-Screen Control

How to use the remote

The supplied remote lets you perform almost all of the receiver operations.

This section describes how to use the direction control button. For certain operations, you can also control the receiver using the other (short-cut) buttons instead of the direction control button.

For details, see page 52.

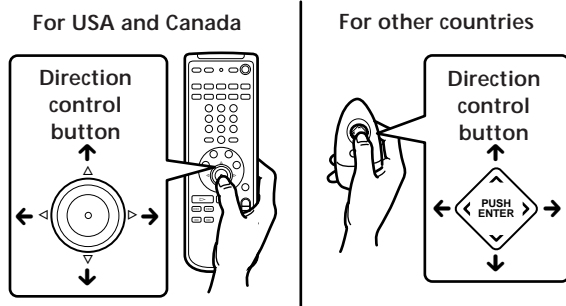
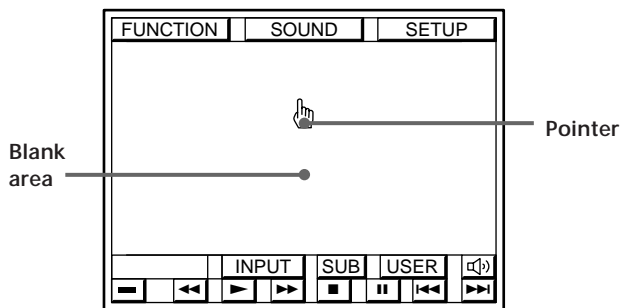

- 1 Press the direction control button on the remote once to recall the on-screen display.
- 2 Press repeatedly (or hold down) the corner of the direction control button (←, →, ↑, ↓) in the direction you want to move the pointer (hand-shaped icon) on the on-screen display.
- 3 To “click” on an item, position the pointer so that it is on one of the on-screen items, then press and quickly release the center of the direction control button (indicated by “PUSH ENTER”).

To make the on-screen display disappear

Position the pointer in the blank area, and press the center of the direction control button.

- **For USA and Canada** : You can also turn the on-screen display on or off by pressing GUI.

Notes on handling the remote (except for USA and Canada)

- Do not cover the IR emitter on the remote when operating the remote.

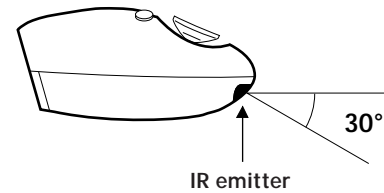

- Hold the remote with its direction control button facing up, as shown below.



Registering a TV (or Monitor)

You must register the IR code of your TV (or monitor) in order to turn on your TV automatically whenever you turn on the receiver.

IR code registration is unnecessary in the following case

If your TV is a Sony product that can be controlled by an infrared remote, and it is connected to the receiver by its VIDEO 1 video input jack, you do not need to register its IR code.

Registering IR codes

- 1 Turn on the receiver and the TV.
Make sure the input selector on the TV is set to the video input.

- 2 Click SETUP in the main menu.

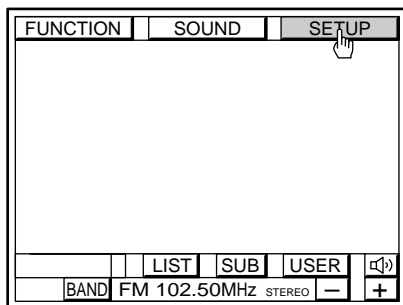

- 3 Click TV SET.

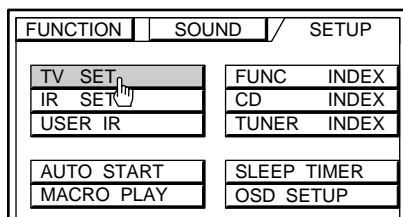

- 4
 - Sony TV
 - 1 Click Sony TV.
 - 2 Click VIDEO 1, 2 or 3 to select the video input of the TV that is connected to the receiver.
 - 3 If your TV type is a wide screen type (screen ratio:16 x 9), click WIDE (except for Australian and Singaporean models).
The IR codes are automatically registered and registration is complete.

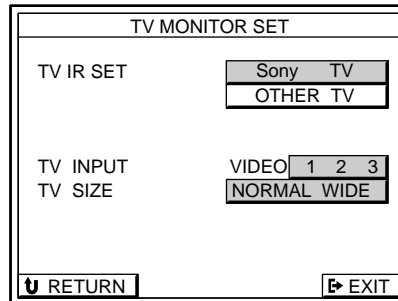

- Non-Sony TV
 - 1 Click OTHER TV.
 - 2 Click VIDEO 1, 2 or 3 to select the video input of the TV that is connected to the receiver.
 - 3 If you are using a wide TV, click WIDE (except for Australian and Singaporean models).
 - 4 Go to step 5.

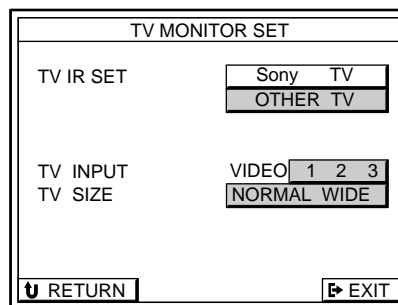

- 5 Cover the IR sensor on the TV to prevent accidental operation. Otherwise, the on-screen display may be turned off during the registration procedure.

- 6 Click START.

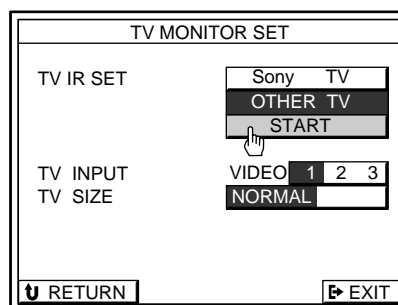

(continued)

Setting Up the Remote for On-Screen Control

- 7 When "PUSH YOUR REMOTE" appears in the on-screen display, press the button on the TV's remote that corresponds to the highlighted control button (e.g., POWER).
- If your TV's remote has an independent input selector button (e.g., VIDEO 1). Register the IR code of this button when the VIDEO 1 button appears. When you turn on the receiver, the TV switches to the video input automatically.
 - If your TV does not have an independent input selector button or has a cyclic input selector button. Do not register an IR code of the input selector button. The TV's input cannot be switched automatically when you turn on the receiver. Switch the TV to the video input manually. If you registered an IR code for the VIDEO 1 button, erase the VIDEO 1 code following the steps in "To erase a specific IR code" below.
 - If you selected WIDE in step 4. Register the IR code for the wide TV mode button on your TV's remote when the WIDE TV DISPLAY MODE button appears.

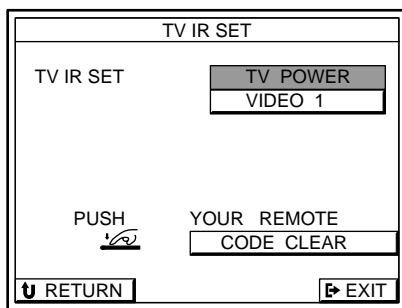

For Australian and Singaporean models

The on-screen display also includes the following settings for your TV's remote control.

- TV/VIDEO :** Use to program the cyclic input selector button on your TV's remote. This allows you to switch the TV's input selector using this unit's remote. Do not program an independent input selector button at this setting.
- WIDE TV DISPLAY MODE:** Use to program the wide TV mode button on your TV's remote.

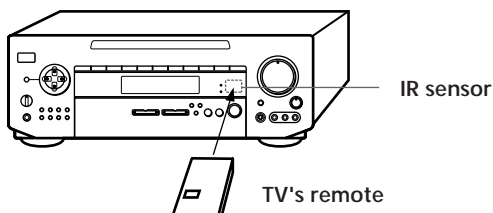

When registering the IR code, be sure to do the following; otherwise, the IR code may not be registered correctly.

- Point the remote at the IR sensor on the receiver from a distance of less than 2 inches (5 cm).
- Hold down the button on the remote for about 2 or 3 seconds until the "RECEIVING" display switches to "RELEASE YOUR REMOTE".
- Keep the remote pointed horizontally at the IR sensor until the code is registered.

- 8 Repeat step 7 for the remaining buttons that appear in the on-screen display. If "NG" is displayed, an IR code was not registered correctly. In this case, repeat step 7 again.

To return to the main menu

Click EXIT.

To return to a previous menu

Click RETURN.

-  To exchange from a non-Sony TV to a Sony TV Connect the receiver's MONITOR OUT jack to the VIDEO 1 input jack of the Sony TV. Follow the registration steps 1 to 3, then click SONY TV in step 4. Click VIDEO 1 2 3 and/or WIDE to specify VIDEO 1 and/or WIDE if necessary.

Note

Some IR codes may not have been successfully registered, even if "RELEASE YOUR REMOTE" appears on the TV screen. In this case, try registering the IR code again. If the IR code still cannot be registered, follow the procedure described in "Registering Desired Components (User IR setting)" on page 42.

Erasing TV IR codes

Click CODE CLEAR in the TV IR SET menu that appears when you click START.

- To erase a specific IR code
 - Click SINGLE IR CODE CLEAR.
 - Click the button you want to clear. "Are you sure?" appears.
 - Click YES to erase the code. To cancel erasing, click NO. To erase another code repeat steps 2 and 3.
- To erase all the TV IR codes
 - Click TV IR CODE CLEAR. "Are you sure?" appears.
 - Click YES to erase the codes. "CODE CLEAR!" appears in the display. To cancel erasing, click NO.

Registering Audio and Video Components

You must register the IR code of your audio/video component to control your component using the on-screen display.

IR code registration is unnecessary in the following case

If your audio/video component is a Sony product that can be controlled by an infrared remote, and it is connected to the jacks shown in the following table, you do not need to register the IR code.

Receiver jacks	Component to be connected
VIDEO 1	Sony VTR 3 (VHS)
VIDEO 2	Sony VTR 1 (BETA)
VIDEO 3	Sony VTR 2 (8 mm)
LD/DVD	Sony LD player
TV/DBS	Sony DBS receiver (USA, Canada and Australia only)
DAT/MD	Sony DAT deck
CD	Sony CD player (CD 1)
TAPE	Sony Tape deck
MONITOR	Sony TV (via its VIDEO 1 jack)

The following cases require registration of Sony products

- When connecting a Sony MD deck to the DAT/MD jacks.
- When connecting a Sony audio product with CONTROL-A1 compatibility.
- When connecting a Sony product to jacks other than those specified in the previous table (e.g., when connecting a Sony LD player to the VIDEO 3 jacks).
- When exchanging a non-Sony audio or video component with a Sony product.

Notes

- If your VCR has a COMMAND CODE selector switch (for VTR1, VTR2, or VTR3), set the switch to the applicable setting. If your VCR has a built-in StarSight tuner, you must set the COMMAND CODE selector switch to VTR 3.
- If your CD changer has a COMMAND MODE selector switch (for CD 1, CD 2, or CD 3), normally it should be set to "CD 1." However, if your CD changer has VIDEO OUT terminals, set the command mode to "CD 2" or "CD 3" ("CD 3" should be used only when making CONTROL-A1 connections).

Registering IR codes

- 1 Click SETUP in the main menu.

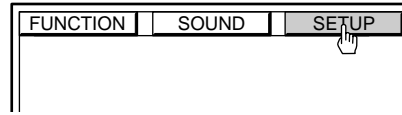

- 2 Click IR SET.

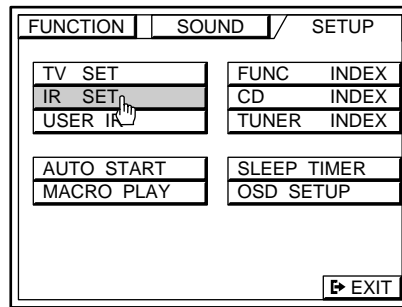

- 3 Click the name of the receiver's jack you want.

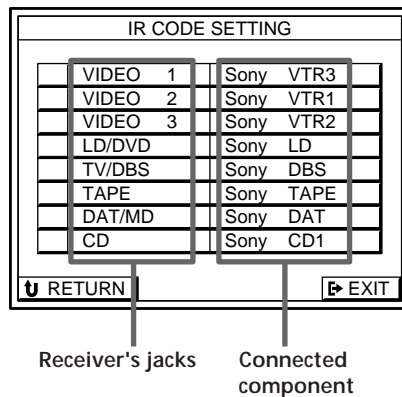

- 4 • Sony product

Click Sony.

The IR codes are automatically registered and registration is complete.

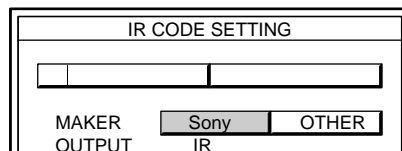

To take advantage of CONTROL-A1 compatible audio components, such as multi-disc CD players, click CONTROL-A1 to select CONTROL-A1.

- non-Sony product

Click OTHER.

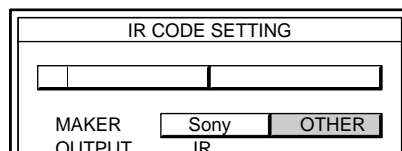

(continued)

Setting Up the Remote for On-Screen Control

- 5 Click the respective component.

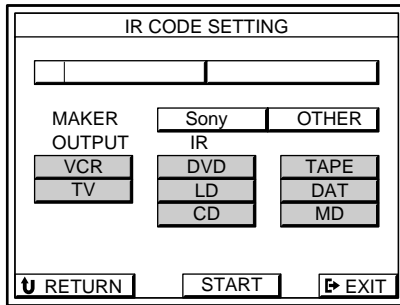

- If the component is not a VCR or laser disc player
- Cover the IR sensor on the component to prevent accidental operation during the registration procedure.
 - Click START, then go to step 6.
- If the component is a VCR, DVD or laser disc player:
- Click START.
A list of other manufacturers appears.

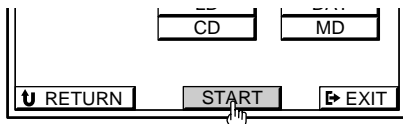

- Click the manufacturer of the component you want.
The IR codes for that component are automatically registered.

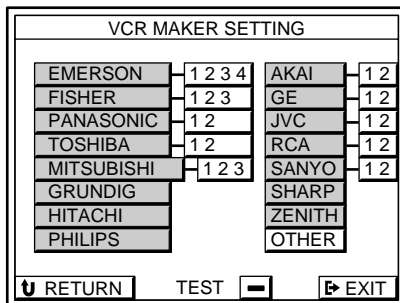

If the manufacturer is not listed, cover the IR sensor on the component to prevent accidental operation during the registration procedure, click OTHER, then go to step 6.

- 3 Click TEST.

If the selected component turns on, the IR codes have been registered. The registration is complete.

If the component does not turn on:
Click the number button beside the manufacturer's name to select another number, then click TEST again.

If the component still does not turn on:
Cover the IR sensor on the component to prevent accidental operation during the registration procedure is complete, click OTHER, then go to step 6.

- When "PUSH YOUR REMOTE" appears, press the button on your audio/video component's remote that corresponds to the control button highlighted.

 is the POWER switch.

After you have registered all the IR codes, the IR CODE SETTING menu reappears.

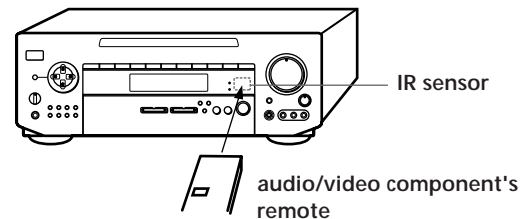
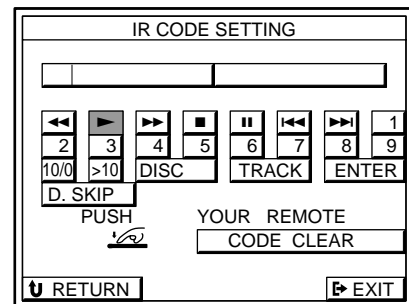

When registering the IR code, be sure to do the following; otherwise, the IR code may not be registered correctly.

- Point the remote at the IR sensor on the receiver from a distance of less than 2 inches (5 cm).
- Hold down the button on the remote for about 2 or 3 seconds until the "RECEIVING" display switches to "RELEASE YOUR REMOTE".
- Keep the remote pointed horizontally at the IR sensor until the code is registered.

- Repeat steps 3 to 6 to register IR codes from other components.

To return to the main menu
Click EXIT.

To return to a previous menu
Click RETURN.

To register special IR codes that do not appear as on-screen controls
See "Registering Desired Components (User IR setting)" on page 42.

Notes

- If the IR codes do not operate as expected, perform the registration operation(s) again to make sure the IR codes are registered correctly. If the IR code still cannot be registered, see "Registering Desired Components (User IR setting)" on page 42.
- If you experience difficulty operating the INPUT, number, or ENTER buttons of a VCR or LD player after automatic registration in step 5, register the IR codes for that component manually as shown in step 6.
- When using components made by other manufacturers, certain operations may not be possible even after selecting manufacturer (in step 5). In this case, register the IR codes for those buttons manually as shown in step 6.
- If you register a playback source as TOSHIBA 2 or RCA 2, you cannot turn the TV on or off using the receiver's remote (the power will not go on when you click TEST).
- Do not register the same type of component (e.g., an LD player) at several different functions.
- You can register about 200 IR codes, including user IR codes (see page 42); however, depending on the type of codes recorded, the maximum limit may be less than 100. It may be difficult or impossible to register about 200 codes under the following conditions:
 - When registering from remotes with weak batteries.
 - When registering IR codes that have been registered to a programmable remote (e.g., any IR code not originally supplied in the respective remote).
- Keep the IR sensor away from fluorescent light or direct sunlight. Otherwise, the IR codes may not be registered.
- If the AC power cord is disconnected for about two weeks, the registered IR codes will be erased. "ALL CLEAR!" will appear on the TV screen the next time you turn on the receiver.
- Some remote controls supplied with audio and video components made by other manufacturers may have a special formats. In such cases, it may not be possible for the receiver to learn (or properly execute) their command codes.

Erasing IR codes

Click CODE CLEAR in the IR CODE SETTING menu that appears when you click START.

- To erase a specific IR code
 - 1 Click SINGLE IR CODE CLEAR.
"SELECT CLEAR CODE KEY" appears.
 - 2 Click the button you want to clear.
"Are you sure?" appears.
 - 3 Click YES to erase the code.
"CODE CLEAR!" appears.
To cancel erasing, click NO.
To erase another code repeat steps 2 and 3.
- To erase all the IR codes for the current component (e.g., OTHER CD)
 - 1 Click (OTHER CD) CODE CLEAR.
"Are you sure?" appears.
 - 2 Click YES to erase the codes.
"CODE CLEAR!" appears.
To cancel erasing, click NO.
- To erase all the IR codes
 - 1 Click ALL IR CODE CLEAR.
"Are you sure?" appears.
 - 2 Click YES to erase the codes.
"CODE CLEAR!" appears.
To cancel erasing, click NO.

Dolby Digital (AC-3) (STR-DE1015G only)

To obtain the best possible surround sound, first specify the type of speakers you have connected. Then use the test tone to adjust the speaker volumes to the same level.

Specifying the speaker type

- 1 Click SETUP in the main menu.
- 2 Click SPEAKER.

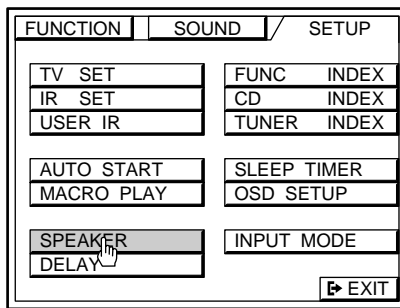

- 3 Set the speaker size parameters according to the type of speakers you connected.

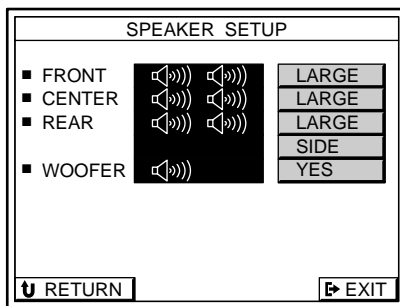

Front speaker (FRONT)

- If you connect large speakers that will effectively reproduce bass frequencies, select "LARGE".
- If you cannot obtain sufficient surround effects when playing a Dolby Digital (AC-3) source (a source for which the DISCRETE indicator lights), select "SMALL". The bass frequencies for the front speakers will be output from the sub woofer or other "LARGE" speakers.

Center speaker (CENTER)

- If you connect a large speaker that will effectively reproduce bass frequencies, select "LARGE".
- If you cannot obtain sufficient surround effects when playing a Dolby Digital (AC-3) source (a source for which the DISCRETE indicator lights), select "SMALL". The bass frequencies for the center speaker will be output from the sub woofer or other "LARGE" speakers.
- If you do not connect the center speaker, select "NO".

Rear speaker (REAR)

- If you connect large speakers that will effectively reproduce bass frequencies, select "LARGE".
- If you cannot obtain sufficient surround effects when playing a Dolby Digital (AC-3) source (a source for which the DISCRETE indicator lights), select "SMALL". The bass frequencies for the rear speakers will be output from the sub woofer or other "LARGE" speakers.
- If you do not connect rear speakers, select "NO".

Rear speaker place (REAR)

This parameter lets you specify the location of your rear speakers for proper implementation of the Digital Cinema Sound VIRTUAL REAR SHIFT and VIRTUAL MULTI REAR modes. Refer to the illustration below.

- Set to SIDE if the location of your rear speakers corresponds to section A.
- Set to BEHIND if the location of your rear speakers corresponds to section B.

This setting affects only the VIRTUAL REAR SHIFT and VIRTUAL MULTI REAR modes.

This parameter does not appear when the rear speaker parameter is set to "NO".

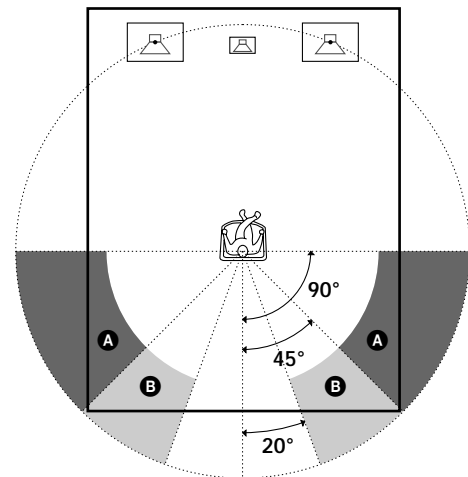

Sub woofer (WOOFER)

- If you connect a sub woofer, select "YES" to output the LFE (low frequency extension) channel from the sub woofer.
- If you do not connect a sub woofer, select "NO". This activates the Dolby Digital (AC-3) bass redirection circuitry and outputs the LFE signals from other speakers.
- In order to take full advantage of the Dolby Digital (AC-3) bass redirection circuitry, we recommend setting the sub woofer's cut off frequency as high as possible.

Adjusting the speaker volume

Use the remote while seated in your listening position to adjust the volume of each speaker.

Note

This unit incorporates a new test tone with a frequency centered at 800 Hz for easier speaker volume adjustment.

- 1 Click SOUND in the main menu.
- 2 Click DOLBY, then click SUR.

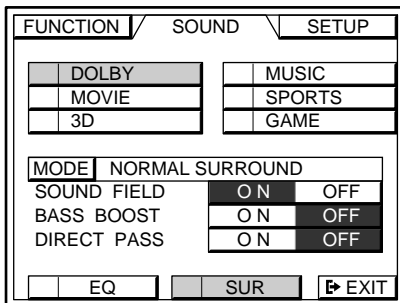

- 3 Click TEST. You will hear the test tone from each speaker in sequence.

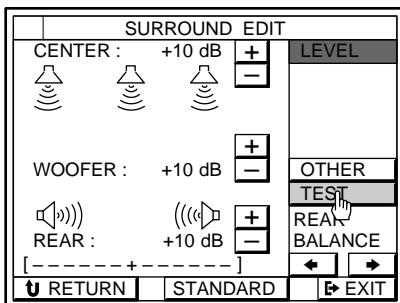

- 4 From your listening position, use the remote to adjust the volume of each speaker so that the test tone can be heard at the same level from all speakers.

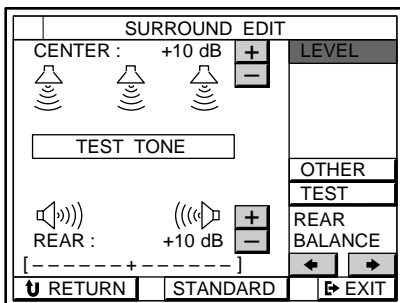

Center speaker level (CENTER)

- Click CENTER + or - to adjust the level of the center speaker from -20.0 dB to +10.0 dB (0.5 dB/steps).
- During this adjustment, the test tone is emitted from the center speaker.

Rear speaker level (REAR)

- Click REAR + or - to adjust the level of the rear speakers from -20.0 dB to +10.0 dB (0.5 dB/steps).
- During this adjustment, the test tone is emitted from both speakers simultaneously.

Rear speaker balance (--+--)

- Click REAR BALANCE ← or → to adjust the balance between the rear left and right speakers ±8 dB (1 dB/steps).
- During this adjustment, the test tone is emitted from both speakers simultaneously.

- 5 Click TEST again to turn off the test tone.

To return to the main menu

Click EXIT.

To return to a previous menu

Click RETURN.

You can adjust all speakers at one time
Use MASTER VOL on the remote.

To adjust the subwoofer level (WOOFER)
Click WOOFER + or - to adjust the level of the subwoofer from -20.0 dB to +10.0 dB (0.5 dB/steps).
This adjustment is not possible during the test tone operation.

Note

The test tone cannot be used in the following cases:

- When the DIRECT PASS is ON
- When the "MUTING" is displayed
- When the SOUND FIELD is OFF
- When a sound field genre other than "DOLBY" is selected.

Dolby Pro Logic (STR-DE815G and STR-D760Z)

Dolby Pro Logic Surround is a decoding system standardized in TV programs and movies. Dolby Pro Logic Surround improves sound image by using four separate channels. These channels manipulate the sound and enhance the action as it happens on the screen.

Specifying the center mode

To take advantage of Dolby Pro Logic Surround, you should connect at least one pair of rear speakers and/or one center speaker, plus a TV and a VCR. Also, to enjoy a full effect, you need to select the appropriate center mode (WIDE, NORMAL, PHANTOM, or 3 CH LOGIC modes) on the receiver, according to your speaker system.

WIDE mode

Select this mode if you have front and rear speakers and a large center speaker. With this mode, you can take full advantage of Dolby Surround sound.

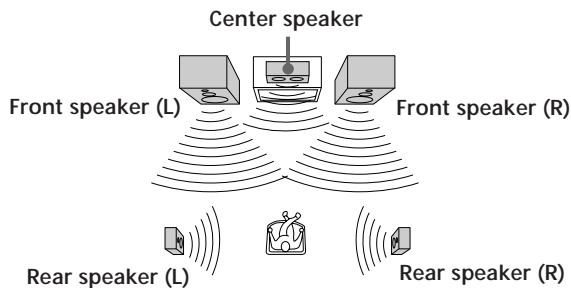

NORMAL mode

Select this mode if you have front and rear speakers and a small center speaker. Since a small speaker cannot produce enough bass, the bass sound of the center channel is output from the front speakers.

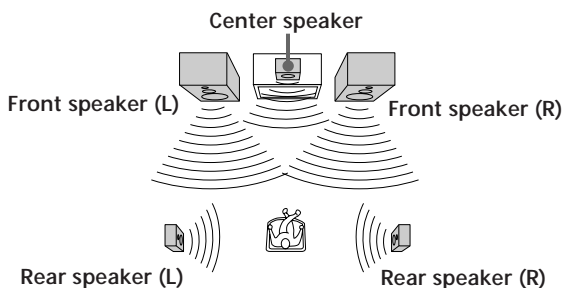

PHANTOM mode

Select this mode if you have front and rear speakers but no center speaker. The sound of the center channel is output from the front speakers.

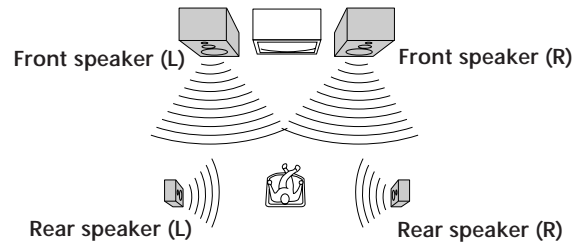

3 CH LOGIC mode

Select this mode if you have front and center speakers but no rear speakers. The sound of the rear channel is output from the front speakers to let you experience some of the surround sound without using rear speakers.

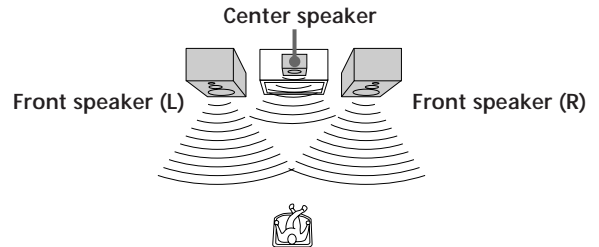

Adjusting the speaker volume

To enjoy Dolby Pro Logic Surround sound, select the appropriate center mode. Then adjust the volume of each speaker using the test tone that the receiver provides. The test tone feature lets you set the volume of your speakers to the same level. (If all of your speakers have equal performance, you do not have to adjust the speaker volume.)

Using the remote lets you adjust the volume level from your listening position.

- 1 Click SOUND in the main menu.
- 2 Click PRO LOGIC, then click SUR.

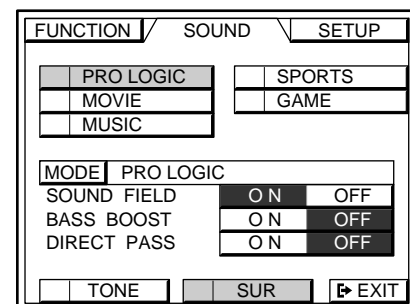

- Click C MODE repeatedly to display the center mode appropriate for your speaker system (see page 24).

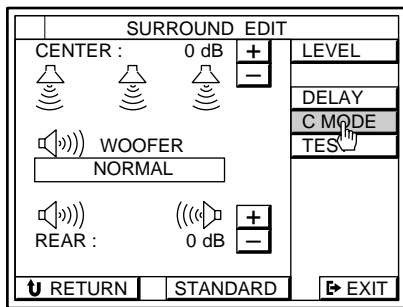

- Click TEST.
You will hear a test tone from the speakers in the following order. The speaker emitting the test tone is shown in red on the SURROUND EDIT menu.
WIDE, NORMAL: Front (left) → Center → Front (right) → Rear
PHANTOM: Front (left and right) → Rear
3CH LOGIC: Front (left) → Center → Front (right)

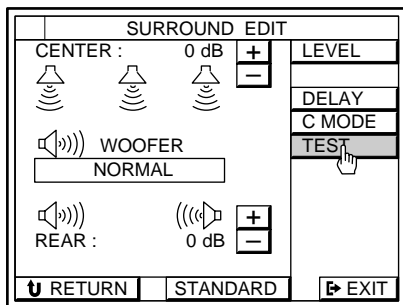

- Adjust the volume levels so that you hear the test tone from each speaker at the same volume level when you are in your listening position:
 - Click CENTER + or - to adjust the level of the center speaker from -15.0 dB to +10.0 dB (1 dB/steps).
During this adjustment, the test tone is emitted from the center speaker.
 - Click REAR + or - to adjust the level of the rear speakers from -15.0 dB to +10.0 dB (1 dB/steps).
During this adjustment, the test tone is emitted from both speakers simultaneously.
- Click TEST when you are done adjusting.
The test tone is turned off.

To return to the main menu
Click EXIT.

To return to a previous menu
Click RETURN.

You can adjust all speakers at one time
Use MASTER VOL on the remote.

You can increase the output level of the rear speakers
You can raise the output of the rear speakers by 5 dB. When turning on the receiver, press POWER and MODE simultaneously to display "GAIN UP". To return the output level to normal, repeat this procedure to display "GAIN NORMAL".

Selecting a Component

You can listen to or watch a connected component by clicking on the component in the on-screen display.

Before you begin, make sure you have:

- Registered the IR codes for the connected components (see pages 17 to 21).
- Turned MASTER VOL on the front panel to the leftmost position (0) to avoid damaging your speakers.
- Set the Auto Play function to ON. (The factory setting is ON, see page 44.)
- Selected the appropriate speaker system (see page 10).
- Set BALANCE on the front panel to the center position.

- 1 Press the button on the remote once or twice to turn on the receiver.
The TV turns on automatically, and the main menu appears. If the TV does not turn on automatically, see pages 17 to 18 to register your TV.

- 2 Click FUNCTION in the main menu.

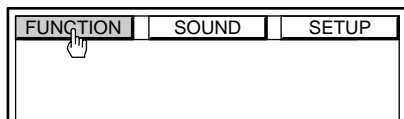

- 3 Click the component you want.
The control buttons appear, then the component turns on and starts playing automatically.

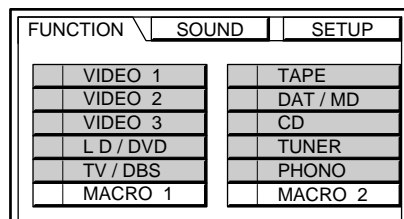

To listen to or watch	Click* ¹
TV programs* ² or video tapes	VIDEO 1, VIDEO 2 or VIDEO 3
Laser Discs (LD) or DVD	LD/DVD
TV programs (only for Sony TV with TV OUT jacks) or Digital Broadcasting Satellites (DBS)* ²	TV/DBS (or TV)* ³
Digital Audio Tapes (DAT) or MiniDiscs (MD)	DAT/MD
Compact Discs (CD)	CD
Radio programs* ⁴	TUNER
Records	PHONO* ⁵
Analog audio tapes	TAPE

*¹ If you connect the component to jacks other than those specified in the table, click the appropriate one according to your connection (e.g., If you connect the LD player to the VIDEO 3 jacks, click VIDEO 3 to watch the LD).

*² For details about watching TV or controlling a DBS receiver, see page 28.

*³ TV/DBS : USA, Canada, and Australia
TV : Other countries

*⁴ For details about tuning radio stations, see page 29.

*⁵ Control buttons do not appear when you select PHONO.

- 4 Use MASTER VOL + or - on the remote to adjust the volume.
To adjust the volume of the TV's speakers, use the volume control on the TV.

To operate the selected component, click the control buttons. For details of the functions of the control buttons, see the instructions of the selected component. To display other control buttons for the selected component, click SUB.

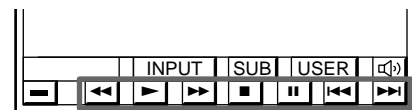

Control buttons



To turn off the selected component

Click  in the bottom left corner. To turn on the component, follow steps 1 to 3.

To turn off all components

Press SYSTEM OFF (for USA and Canadian models) or ALL OFF (for other models) on the remote control.

To mute the sound

Click . The icon changes to . "MUTING" appears in the display on the front panel. To turn the sound back on, click on the icon again.

- **For USA and Canada :** You can also mute the sound by pressing MUTING on the remote control. "MUTING" appears in the display on the front panel. Press again to restore the sound.

To listen to digital program sources (STR-DE1015G)

Click SETUP in the main menu, then click INPUT MODE.

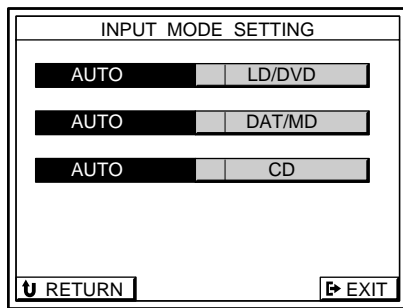

Click the buttons next to each program source to select the audio signals you desire:

- **AUTO :** gives priority to digital signals when there are both digital and analog connections. If there are no digital signals, analog is selected.
- **ANALOG :** selects the analog audio signals input to the AUDIO IN (L and R) jacks.
- **DIGITAL (OPTICAL) :** selects the digital audio signals input to the DIGITAL OPTICAL IN jack.
- **AC-3 RF :** selects the digital RF audio signals input to the DIGITAL AC-3 RF IN jack (LD/DVD only).

To listen to decoded Dolby Digital (AC-3) program sources (STR-DE815/D760Z)

Click FUNCTION, then click 5.1 INPUT.

The video signal from the LD/DVD VIDEO IN jack is automatically paired with the audio signals from the 5.1 INPUT jacks. When set to this mode, the audio signals bypass the receiver's sound fields. To customize the sound of the 5.1 INPUT, use the controls on your Dolby Digital (AC-3) decoder.

To listen to the analog audio signals input to the LD/DVD AUDIO (L and R) jacks, select LD/DVD from the FUNCTION menu.

You can play video and audio components at the same time

Play a video component you want, then play audio component. Make sure the AUTO PLAY function is set to off (see page 44).

Notes

- Components of the same type (e.g., Sony LD player) will be controlled simultaneously by the on-screen controls.
- If a component does not respond, it may be because IR codes from the IR emitter are not fully reaching the component. In this case, connect the extra IR repeater (supplied) and position it facing the component (see "Infrared (IR) Repeater Hookups" on page 7). If the IR repeater is already connected, change the position of the IR repeater or program source.
- When 5.1 INPUT is selected, sound fields cannot be selected or edited (STR-DE815G and STR-D760Z only).

Watching TV or Video Programs

Use the TV tuner built-in to the VCR to watch TV programs; otherwise, the on-screen display will change to a TV program when you switch channels. Also, set the VCR's TV tuner to skip channels where there is no broadcast so that an image is always displayed on the TV screen; otherwise, the on-screen display will be distorted.

Before you begin, make sure you have:

- Connected your TV and VCR to the receiver (see pages 11 to 12).

- 1 Select the appropriate VCR component (e.g., VIDEO 2).

Do not select TV/DBS*. If you select TV/DBS, the Auto Play function (page 44) will not operate the next time you select the VCR.

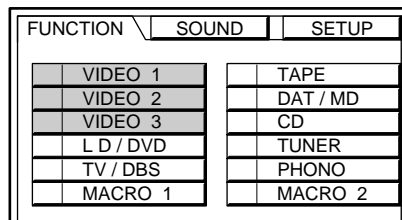

- 2 Click CH + or - to select the channel you desire.

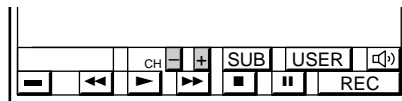

* TV/DBS : USA, Canada and Australia
TV : Other countries

If the Auto Play function is set to on (page 44).
Be sure to click ■ to stop playback from the VCR before clicking CH + or -.

To watch TV programs using a Sony TV with TV OUT jacks
When connecting a Sony TV with TV OUT jacks, connect the TV OUT jacks to this receiver's TV/DBS* IN jacks, then set the TV/DBS* function to "Sony TV." This lets you watch TV programs by selecting the TV/DBS* function. Also, use the TV's VIDEO LABEL function to set the video input jack (e.g., VIDEO 1 IN) connected to this receiver's MONITOR OUT jack to "RECEIVER."

To change the video input of a Sony VCR
Click SUB, then click INPUT.

To switch the screen size when using a wide TV monitor
Click  repeatedly to select the screen size you desire. This operation is possible only when TV SIZE in the TV MONITOR SET menu is set to WIDE (see page 17).*

- * Except for Australian and Singaporean models.
- For USA and Canada : You can also switch the screen size by pressing WIDE on the remote control repeatedly.
- For non-Sony TVs : You must register the IR code for the wide TV mode button on your TV's remote (see pages 17 and 18).

To control a Sony DBS receiver (USA, Canada and Australia only)

- 1 Select the component to which you assigned Sony DBS receiver IR codes (e.g., TV/DBS).
- 2 Click CURSOR MENU.

The DBS receiver control panel appears.

The icons in the cursor menu have the same function as those on the DBS receiver (except for SELECT, which substitutes for the enter button). Click the borders at the edge of the screen to move the DBS cursor.

To jump between the current and the previous channels

Click JUMP.

To control StarSight functions of a Sony VCR (USA and Canada only)

- 1 Select the component to which you assigned StarSight VCR IR codes (e.g., VIDEO 1).
- 2 Click SUB
- 3 Click STARSIGHT.

The StarSight control panel appears.

Click the borders at the edge of the screen to move the StarSight cursor.

Tuning and Presetting Radio Stations

The receiver lets you directly enter a station's frequency using the number buttons (Direct Tuning). You can also tune a station by scanning stations (Automatic Tuning), and by selecting preset stations (Preset Tuning: see page 30).

- 1 Click FUNCTION in the main menu, then click TUNER.
- 2 Click FM/AM to select FM or AM, then click SUB.

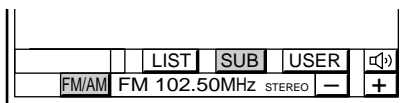

- 3 Click DIRECT.

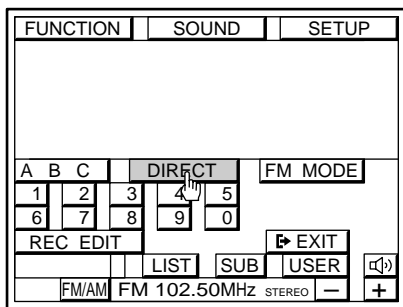

- 4 Click the number buttons to enter the frequency.

Example 1: FM 102.50 MHz

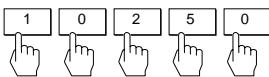

Example 2: AM 1350kHz

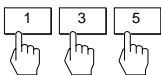

- 5 Repeat steps 2 to 4 to receive other stations.

💡 If an FM stereo program is noisy
 "STEREO" flashes next to the frequency. Click FM MODE to change to monaural (MONO) reception. There will be no stereo effect, but the reception will improve. To return to the auto stereo mode, click this icon again.

💡 If "STEREO" remains off
 Click FM MODE, even when an FM stereo broadcast is received.

💡 If an AM program is noisy
 Adjust the direction of the AM loop antenna for optimum reception.

💡 If you cannot tune in a station and the entered numbers are flashing
 Make sure you have entered the right frequency. If not, reenter the frequency you want. If the entered numbers still flash, the frequency is not used in your area.

💡 If you enter a frequency not covered by the tuning interval
 The entered value is automatically rounded up or down to the closest covered value.
 Tuning intervals for Direct Tuning are:
 FM: 50 kHz intervals
 AM: 10 kHz intervals
 (except for Australian and Singaporean models)
 (to change to 9 kHz intervals, see page 64)
 9 kHz intervals

💡 To watch FM simulcast TV programs
 Make sure that you tune in the simulcast program on both the TV (or VCR) and the receiver.

Tuning radio stations by scanning stations (Automatic Tuning)

- 1 Click FUNCTION in the main menu, then click TUNER.
- 2 Click FM/AM to select FM or AM.

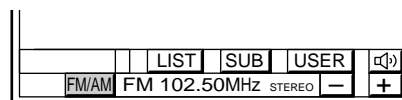

- 3 Click + or -.
 The frequency indication changes and scanning stops when the receiver tunes in a station. To continue scanning, click + or - again. Click + for a higher station number; click - for a lower one. When the scanning is finished, the receiver starts scanning again.

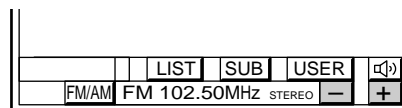

(continued)

Presetting the radio stations

The receiver can store a total of 30 FM or AM stations. You can store up to 10 stations in three different "pages": A, B and C, and recall them later with a simple click. You can also assign names to the preset stations (see page 43).

- 1 Tune in the station you want.
- 2 Click LIST.
The memory list appears.

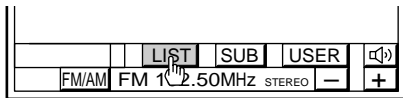

- 3 Click A B C repeatedly to select the page (A, B, or C) you want.

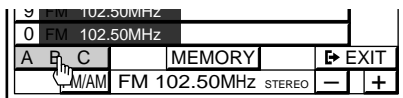

- 4 Click MEMORY.
MEMORY turns red.

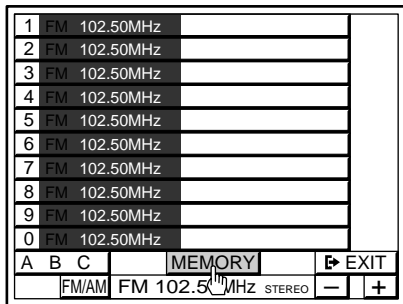

- 5 Click the number button (0 to 9) you want.
The number button lights up and the station is stored.

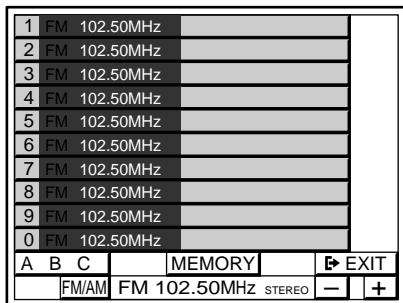

- 6 Repeat steps 1 to 5 to preset up to 30 stations.
You can also use + or - next to the frequency to tune stations from the LIST menu.

To change a preset station

Preset a new station at the number you want to change.

Note

If the AC power cord is disconnected for about 1 week, the preset stations will be cleared. Preset the stations again.

Tuning preset stations (Preset Tuning)

- 1 Click FUNCTION in the main menu, then click TUNER.
- 2 Click LIST.
- 3 Click A B C repeatedly to select the page, then click the number button (0 to 9) of the station you want.

 To recall preset stations from the SUB menu
Click SUB, then click A B C repeatedly to select the page, and then click the number button (0 to 9).

Recording

You can control both playback and recording components using the receiver's on-screen display. If necessary, see the instructions of your recording component.

Recording to audio tape or MD

- 1 Click FUNCTION in the main menu.
- 2 Click the playback component you want (e.g., CD).
- 3 Click SUB.

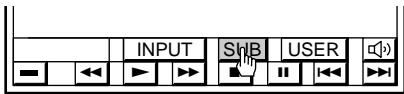

- 4 Click REC EDIT.

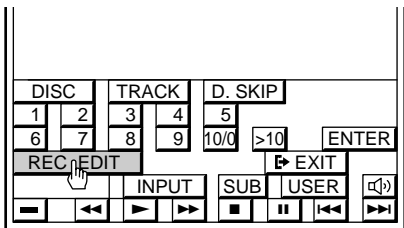

- 5 Click a recording component (e.g., TAPE).

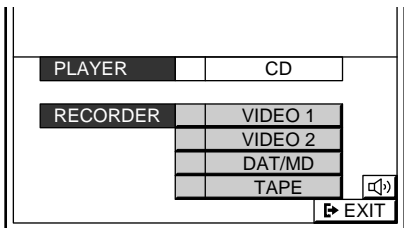

The control buttons for both components appear. "PLAYER" for the playback component, and "RECORDER" for the recording component. The arrow indicates the operative component.

arrow

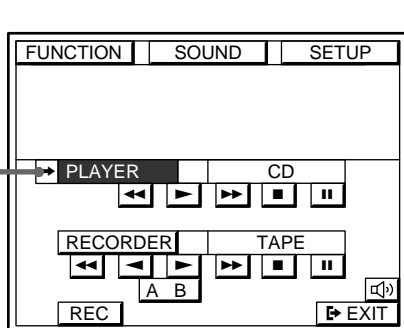

- 6 Insert a blank tape into the recording component (tape deck, etc.) and adjust the recording level, if necessary.
- 7 Click REC to start recording, then click the play button (▶) on the PLAYER control. Recording starts. Do not click any RECORDER controls while recording. This will cut off the source being recorded.

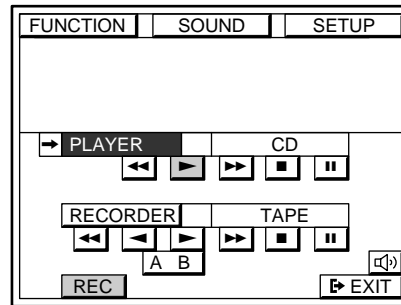

To stop recording

Click the recording component's ■ control.

To control the recorder after recording

Click RECORDER. RECORDER becomes the operative component and you can use the RECORDER controls to rewind and playback the recording (etc.). Click PLAYER to operate the playback component.

To return to the main menu

Click EXIT.

Digital recording (STR-DE1015G only)

If you connect your CD player and DAT(or MD) deck using digital connections (see page 13) and specify the OPTICAL jacks for both components (see page 27), the previous operations will let you make digital recordings from CD to DAT (or MD).

Notes

- If you leave the REC EDIT menu by clicking FUNCTION, SOUND, or EXIT, recording continues, but control returns to the PLAYER side, even if you previously clicked RECORDER.
- Some tape decks require that you press the ● REC and ▶ buttons simultaneously to start recording. To perform one-button recording from the on-screen display, be sure to record the recording signal as shown in steps 1 to 7 of "Registering IR codes" (pages 19 to 21).
- Sound input through the 5.1 INPUT jacks cannot be recorded on a recording component (STR-DE815G only).
- When you record on a DAT or MD connected to the DAT/MD REC OUT jacks, sound adjustments do not affect the recording.

(continued)

■ Recording other components to video tape

- 1 Click FUNCTION in the main menu.
- 2 Click the video playback component you want (VCR 1, VCR 2, LD/DVD, etc.).
- 3 Click REC.
(If you selected LD/DVD or TV/DBS* in step 2 click SUB.)

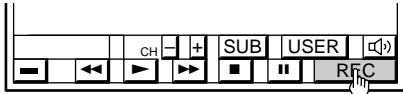

- 4 Click REC EDIT.
(If you selected LD/DVD or TV/DBS* in step 2 click REC EDIT in the sub menu.)

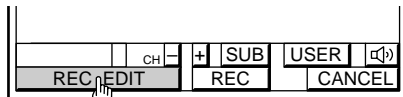

- 5 Click a recording component (e.g., VIDEO 2).

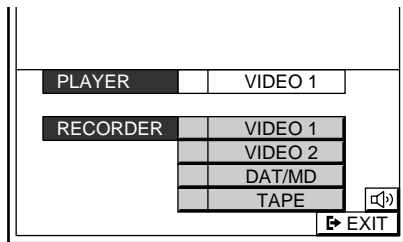

The control buttons for both components appear. "PLAYER" for the playback component, and "RECORDER" for the recording component. The arrow indicates the operative component.

arrow

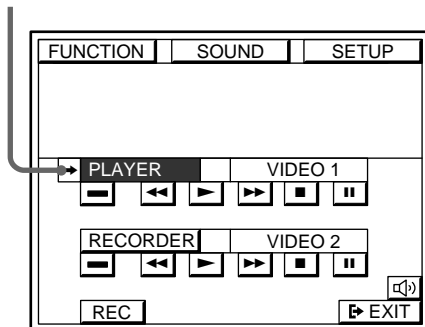

- 6 Insert a blank tape into the recording component (VCR, etc.) and adjust the recording level, if necessary.

- 7 Click REC to start recording, then click the play button (▶) on the PLAYER control. Recording starts. **Do not click any RECORDER controls while recording. This will cut off the source being recorded.**

To stop recording

Click the recording component's ■ control.

To control the recorder after recording

Click RECORDER. RECORDER becomes the operative component and you can use the RECORDER controls to rewind and playback the recording (etc.).

Click PLAYER to operate the playback component.

To return to the main menu

Click EXIT.

■ Recording TV programs to video tape

- 1 Click FUNCTION in the main menu and select a VCR 1 or 2.
- 2 Tune in the TV program on your video deck.
- 3 Click REC.

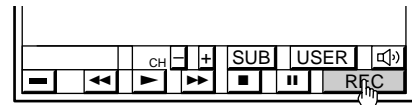

- 4 Click REC again to start recording.

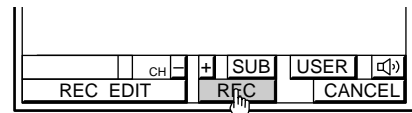

Using the Pre-programmed Sound Fields

The sound fields let you select a sound characteristic to enhance the type of programs or music you are listening to. To make the most out of this feature, we recommend that you connect center and/or rear speakers.

Sound fields for STR-DE1015G

Genre	Mode	Surround effect
DOLBY*1	NORMAL SURROUND	Decodes programs processed with Dolby Surround.
	ENHANCED SURROUND	Additional output from rear speakers when decoding Dolby Surround programs.
MOVIE	CINEMA STUDIO A	Reproduces the sound characteristics of the Sony Pictures Entertainment "Cary Grant Theater" cinema production studio.
	CINEMA STUDIO B	Reproduces the sound characteristics of the Sony Pictures Entertainment "Kim Novak Theater" cinema production studio.
	CINEMA STUDIO C	Reproduces the sound characteristics of the Sony Pictures Entertainment scoring stage.
	SMALL THEATER	
	MEDIUM THEATER	Adds acoustic reflections of a theaters to decoded Dolby Surround signals.
	LARGE THEATER	
	NIGHT THEATER	Compresses the dynamic range for listening at low volume levels.
	MONO MOVIE	Creates a theater-like environment from movies with 2-channel monaural soundtracks.
3D	VIRTUAL ENHANCED A	Uses 3D sound imaging to create virtual rear speakers from the sound of the front speakers without using actual rear speakers. The virtual speakers are reproduced as shown in Ill. A on page 34.
	VIRTUAL ENHANCED B	Uses 3D sound imaging to create virtual rear speakers from the sound of the front speakers without using actual rear speakers. The virtual speakers are reproduced as shown in Ill. B on page 34.
	VIRTUAL REAR SHIFT	Uses 3D sound imaging to shift the sound of the rear speakers away from the actual speaker position (Ill. C on page 34). The shift position differs according to the setting of the rear speaker position (see page 22).
	VIRTUAL MULTI REAR	Uses 3D sound imaging to create an array of virtual rear speakers from a single pair of actual rear speakers (Ill. D on page 34). The position of the virtual rear speakers differs according to the setting of the rear speaker position (see page 22).
MUSIC	SMALL HALL	Reproduces the acoustics of a rectangular concert hall. Ideal for soft acoustic sounds.
	LARGE HALL	
	SMALL OPERA HOUSE	Reproduces the acoustics of an opera house. Ideal for musicals and operas.
	LARGE OPERA HOUSE	
	SMALL JAZZ CLUB	Reproduces the acoustics of a jazz club.
	LARGE JAZZ CLUB	
	CHURCH	Reproduces the acoustics of a church.
	LIVE HOUSE	Reproduces the acoustics of a rock and roll club.
	KARAOKE	Reduces the vocal tracks of normal 2-channel stereo music sources.
ACOUSTIC*2	Reproduces normal 2-channel stereo with equalization (EQ).	

(continued)

Sound Adjustment

SPORTS	ARENA	Reproduces the feeling of a large concert arena. Great for rock and roll.
	STADIUM	Reproduces the feeling of a large open-air stadium. Great for electric sounds.
GAME	GAME	Obtains maximum audio impact from video game software.

*1 If you select DOLBY, be sure to adjust the volume level of the center and/or rear speakers to get the most out of the Dolby Digital (AC-3) Surround Sound (see page 22).

*2 If you select ACOUSTIC, the hooks of the center and/or rear speakers are unnecessary.

III. A VIRTUAL ENHANCED (SURROUND) A

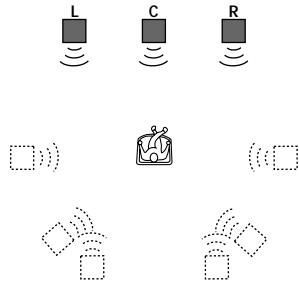

III. B VIRTUAL ENHANCED (SURROUND) B

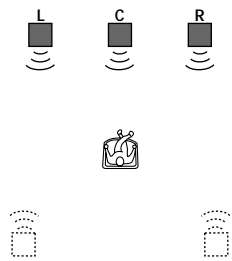

L : Front speaker (left)
 R : Front speaker (right)
 C : Center speaker
 SL : Rear speaker (left)
 SR : Rear speaker (right)
 □ : Virtual speaker

* See page 10 for details on how to set the rear speaker place.

III. C VIRTUAL REAR SHIFT

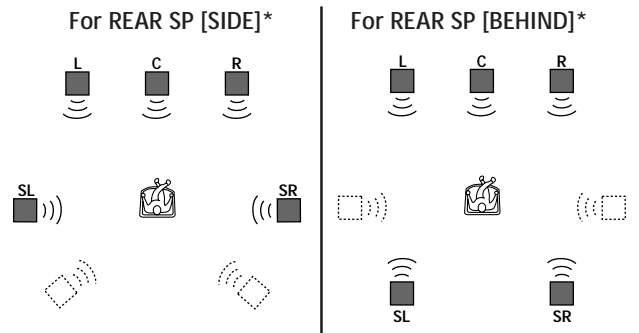

III. D VIRTUAL MULTI REAR

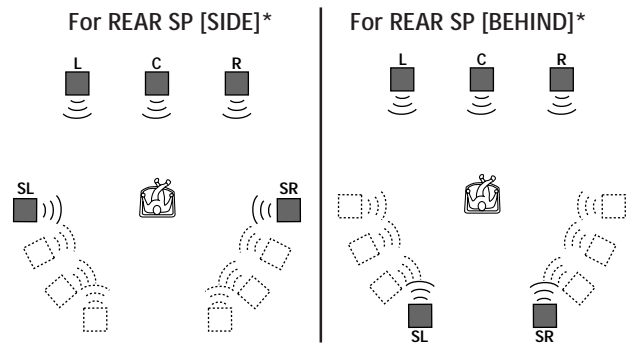

Sound fields for STR-DE815G and STR-D760Z

Genre	Mode	Surround effect
PRO LOGIC* ¹	PRO LOGIC	Decodes programs processed with Dolby Surround.
	ENHANCED PRO LOGIC	Additional output from rear speakers when decoding Dolby Surround programs.
MOVIE	CINEMA STUDIO A	Reproduces the sound characteristics of the Sony Pictures Entertainment "Cary Grant Theater" cinema production studio.
	CINEMA STUDIO B	Reproduces the sound characteristics of the Sony Pictures Entertainment "Kim Novak Theater" cinema production studio.
	THEATER	Adds acoustic reflections of a theater to decoded Dolby Surround signals.
	NIGHT THEATER	Compresses the dynamic range for listening at low volume levels.
	MONO MOVIE	Creates a theater-like environment from movies with monaural soundtracks.
MUSIC	SMALL HALL	Reproduces the acoustics of a rectangular concert hall. Ideal for soft acoustic sounds.
	LARGE HALL	
	JAZZ CLUB	Reproduces the acoustics of a jazz club.
	LIVE HOUSE	Reproduces the acoustics of a rock and roll club.
	ACOUSTIC* ²	Reproduces normal 2-channel stereo with equalization (TONE).
SPORTS	STADIUM	Reproduces the feeling of a large open-air stadium. Great for electric sounds.
GAME	GAME	Obtains maximum audio impact from video game software.

*¹ If you select PRO LOGIC, be sure to adjust the volume level of the center and/or rear speakers to get the most out of the Dolby Pro Logic Surround Sound (see pages 24 to 25).

*² If you select ACOUSTIC, the hookups of the center and/or rear speakers are unnecessary.

(continued)

Selecting the sound fields

- 1 While playing a component, click SOUND in the main menu.

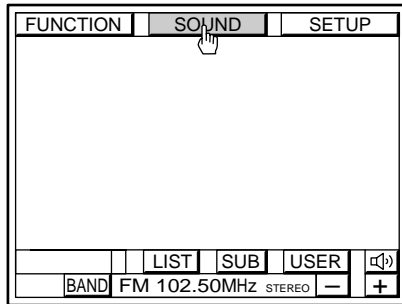

- 2 Click a sound field genre, then click MODE repeatedly until the mode you want appears. See "Sound fields. . ." charts on pages 33 and 35.

■ STR-DE1015G

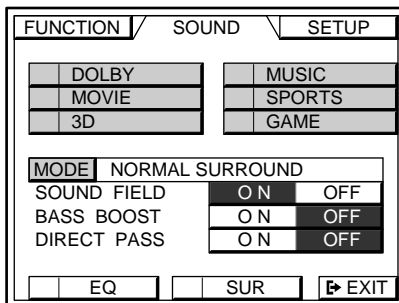

■ STR-DE815G and STR-D760Z

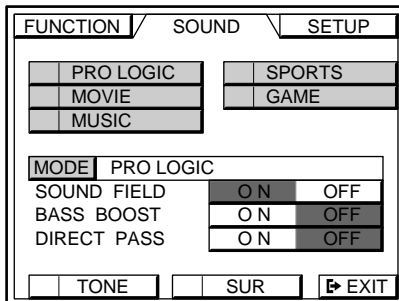

To turn off the sound fields

Click SOUND FIELD OFF.



You can adjust the bass sound or listen to the music directly in the SOUND FIELD SELECT menu. To increase the bass sound, click BASS BOOST ON. To listen to the music without any audio effects, click DIRECT PASS ON. Click OFF to cancel. Even if you set SOUND FIELD to OFF, these functions are effective.

Notes on the output of Dolby Digital (AC-3) source signals

When Dolby Digital (AC-3) encoded sources are played back through this unit, the output method changes automatically according to the information recorded on the source and the settings of this unit.

- When playing a source encoded with discrete information

If the "DOLBY" sound field or DIRECT PASS is set to ON: The DISCRETE indicator lights up and the number of channels recorded in the source are decoded and output directly.

If a sound field (other than "ACOUSTIC" or "KARAOKE") is set to ON: The DISCRETE indicator lights up and the number of channels recorded in the source are decoded. The effects provided by each sound field are then added to each channel before the sound is output.

If the "ACOUSTIC" soundfield is selected or the sound field is set to OFF: The source signal is downmixed to 2 ch (Left and Right) stereo before output. When "ACOUSTIC" is selected equalizer (EQ) adjustments can be performed.

- When playing a source encoded with Dolby Pro Logic information

If the "DOLBY" sound field or DIRECT PASS is set to ON: "PRO LOGIC" appears in the display, the sound is decoded using Pro Logic formula and output.

If a sound field (other than "ACOUSTIC") is set to ON: The effects provided by each sound field are added to each channel before the sound is output.

When the sound field genre is MOVIE (except for MONO MOVIE) or 3D the sound is decoded using the Pro Logic formula and "PRO LOGIC" appears in the display.

If the "ACOUSTIC" sound field is selected or the sound field is set to OFF: The source signal is downmixed to 2 ch (Left and Right) stereo before output. When "ACOUSTIC" is selected equalizer (EQ) adjustments can be performed.

Note on the "KARAOKE" mode

The KARAOKE mode is designed to reduce vocal tracks positioned in the center of 2 channel sources. Therefore, 5.1 channel Dolby Digital (AC-3) sources must be downmixed to 2 channels before the KARAOKE effect can be applied. Consequently, the "DISCRETE" indicator does not light when you select KARAOKE while inputting 5.1 channel Dolby Digital (AC-3) sources.

Customizing the Sound Fields

Each sound field is composed of a tone parameter (bass/treble) and surround sound parameters — variables of sound that create the sound image. You can customize the sound fields by adjusting some of the sound parameters (tone and/or surround sound parameters) to suit your listening situation. Also, since this receiver uses Digital Signal Processing (DSP), you can adjust the sound parameters electronically. DSP automatically converts analog audio signals to digital, which lets you adjust the sound with virtually no degradation in sound quality.

Once you customize the sound fields, they are stored in memory unless the receiver is unplugged for about 1 week. To change a customized sound field, make new adjustments to the sound field.

Adjustable sound parameters for STR-DE1015G

GENRE	MODE	EFFECT	WALL/SEAT	LFE MIX/D.REV	R (BAL/LEV)*	C LEV*	EQ
DOLBY	NORMAL			●	●	●	●
	ENHANCED			●	●	●	●
MOVIE	C STUDIO A	●		●	●	●	●
	C STUDIO B	●		●	●	●	●
	C STUDIO C	●		●	●	●	●
	S THEATER	●	●	●	●	●	●
	M THEATER	●	●	●	●	●	●
	L THEATER	●	●	●	●	●	●
	N THEATER	●	●	●	●	●	●
	MONO MOVIE	●	●	●	●	●	●
3 D	VIRTUAL ENHANCED A	●		●	●	●	●
	VIRTUAL ENHANCED B	●		●	●	●	●
	VIRTUAL REAR SHIFT	●		●	●	●	●
	VIRTUAL MULTI-REAR	●		●	●	●	●
MUSIC	S HALL	●	●	●	●	●	●
	L HALL	●	●	●	●	●	●
	S OPERA HOUSE	●	●	●	●	●	●
	L OPERA HOUSE	●	●	●	●	●	●
	S JAZZ CLUB	●	●	●	●	●	●
	L JAZZ CLUB	●	●	●	●	●	●
	CHURCH	●	●	●	●	●	●
	LIVE HOUSE	●	●	●	●	●	●
	ACOUSTIC						●
	KARAOKE	●			●		●
SPORTS	ARENA	●	●	●	●	●	●
	STADIUM	●	●	●	●	●	●
GAME	GAME	●	●	●	●	●	

- EFFECT : Effect level
- WALL : Wall type
- SEAT (F-R/L-R) : Seat (Front-Rear/Left-Right)
- REV : Reverberation time
- LFE MIX : Low Frequency Effect Mix
- D.COMP : Dynamic Compression
- R (BAL/LEV) : Rear speaker level and balance
- W LEV : Woofer Level
- C LEV : Center Level
- EQ : Equalizer parameter

* These settings are not stored separately for each sound mode. They effects all of the sound modes simultaneously.

(continued)

Notes

- All sound fields can be used with Dolby Digital (AC-3) sound sources.
- The EFFECT parameter allows you to adjust the overall presence of the sound field.
- When DIRECT PASS is set to ON, only the R LEV, W LEV, and C LEV parameters can be adjusted.

Adjustable sound parameters for STR-DE815G and STR-D760Z

GENRE	MODE	TONIE	EFFECT	REAR	CENTER	DELAY
PRO LOGIC	PRO LOGIC	●		● ¹⁾	● ²⁾	●
	ENHANCED PRO LOGIC	●		● ¹⁾	● ²⁾	●
MOVIE	C STUDIO A	●	●	● ¹⁾	● ²⁾	
	C STUDIO B	●	●	● ¹⁾	● ²⁾	
	THEATER	●	●	● ¹⁾	● ²⁾	
	N THEATER	●	●	●		
	MONO MOVIE	●	●	●		
MUSIC	S HALL	●	●	●		
	L HALL	●	●	●		
	JAZZ CLUB	●	●	●		
	LIVE HOUSE	●	●	●		
	ACOUSTIC	●				
SPORTS	STADIUM	●	●	●		
GAME	GAME	●	●	●		

- 1) Adjustable only when the center mode is set to PHANTOM, NORMAL, or WIDE (see page 24).
- 2) Adjustable only when the center mode is set to 3 CH LOGIC, NORMAL, or WIDE (see page 24).

Notes

- To get the most out of the PRO LOGIC sound fields, also see the chapter "Dolby Pro Logic (STR-DE815G and STR-D760Z)" on page 24.
- The EFFECT parameter allows you to adjust the overall presence of the sound field.

Adjusting the equalizer parameter (STR-DE1015G)

Adjust the equalization (bass or treble) of the front, center and rear speakers for optimum sound. The following adjustments effect all sound fields simultaneously.

- 1 While playing a component, click SOUND in the main menu.
- 2 Click a sound field genre, then click MODE repeatedly until the mode you want appears.
- 3 Click EQ.

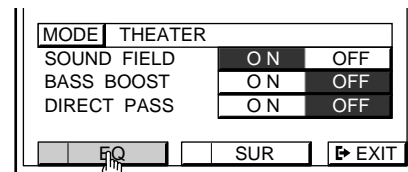

- 4 Click CHANNEL to select the speakers you want to adjust (FRONT, CENTER or REAR).

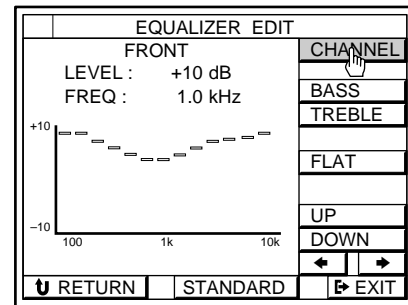

- 5 Click BASS or TREBLE to select a frequency band. Then click UP or DOWN to raise or lower the level of the selected frequency. Click ◀ or ▶ to select specific frequencies within the frequency band.

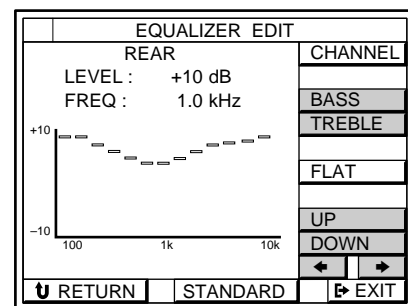

- 6 Repeat steps 4 and 5 as necessary.

To start adjustment with a flat equalizer curve
Click FLAT.

To reset the equalizer to the factory settings
Click STANDARD.

Note

You may hear some noise as you adjust the parameters.

Adjusting the tone parameter (STR-DE815G and STR-D760Z)

Adjust the tone (bass or treble) of the front, center and rear speakers for optimum sound. You can adjust the tone of all sound fields.

- 1 While playing a component, click SOUND in the main menu.
- 2 Click a sound field genre, then click MODE repeatedly until the mode you want appears.
- 3 Click TONE.

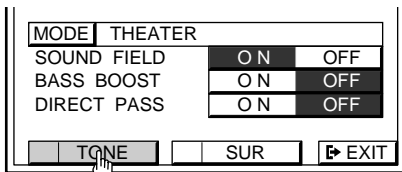

- 4 Click BASS + or - to adjust the level of the low frequencies and click TREBLE + or - to adjust the level of the high frequencies.

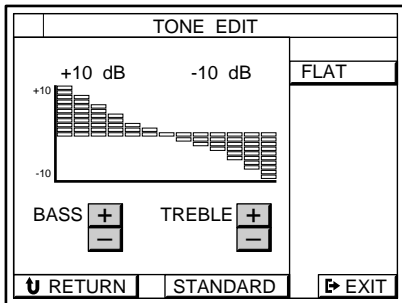

To start adjustment with a flat equalizer curve
Click FLAT.

To reset the tone to the factory settings
Click STANDARD.

Note

You may hear some noise as you adjust the parameters.

Adjusting the delay time (STR-DE1015G)

Click SETUP in the main menu, then click DELAY.

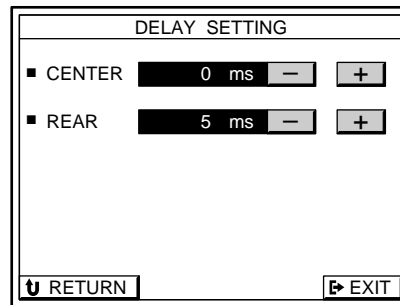

Click the buttons next to each setting to adjust the delay time as you desire.

CENTER

Use this adjustment to add a sense of depth to the center channel. Longer delay times create a greater sense of depth. The CENTER delay can be set from 0 to 5 ms (in 1 ms steps).

REAR

Use this adjustment to add a sense of depth to the rear channel. Longer delay times create a greater sense of depth. The REAR delay can be set from 0 to 20 ms (in 5 ms steps).

Adjusting the delay time (STR-DE815G and STR-D760Z)

The delay time is the time lag between the surround sound output from front and rear speakers. You can make the surround sound more effective by delaying the output from the rear speakers. You can select between three different delay times: 15ms, 20ms, and 30ms. For example, if you have placed the rear speakers in a large room or apart from your listening position, you might want to shorten the delay time. **Delay time adjustment is only available for the PRO LOGIC genre.**

- 1 Start playing a component encoded with Dolby surround sound, then click SOUND in the main menu to display the SOUND FIELD SELECT menu.
- 2 Click PRO LOGIC, then click SUR.

(continued)

- Click DELAY.

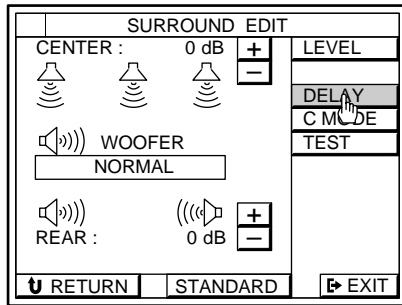

- Click SHORT or LONG to adjust the delay time.

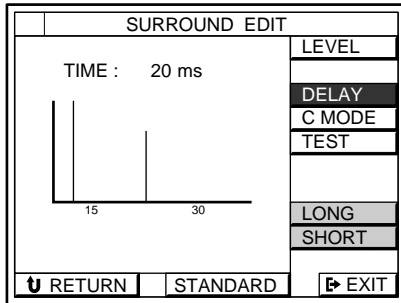

To reset the delay time to the factory settings
Click STANDARD.

Adjusting surround sound parameters (except for delay time)

Adjust the surround sound parameters to fit your listening situation. See the charts “Adjustable sound parameters . . .” on pages 37 and 38 for parameters you can adjust in each sound field.

- While playing a component, click SOUND in the main menu to display the SOUND FIELD SELECT menu.
- Click a sound field genre, then click MODE repeatedly until the mode you want appears.
- Click SUR.

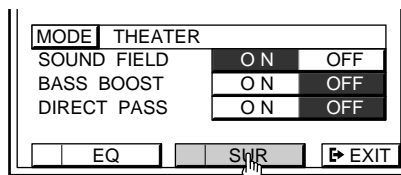

- Click the icon for the parameter you want to adjust.
The parameter chart for your selection appears.
See the next page for details of each adjustment.

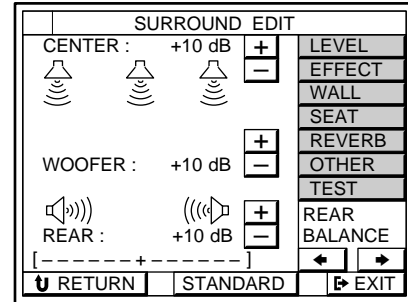

- Click an adjustment icon (+ / -, UP/DOWN, SHORT, LONG, etc.) to adjust the parameter.

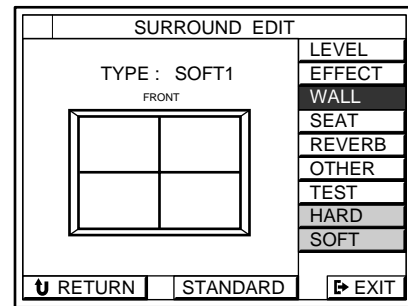

To reset all parameters (except for the delay time) of the current sound field to the factory settings.
Click STANDARD.

💡 Hints for adjusting the parameters (STR-DE1015G)

• Wall material simulation (WALL)

When sound is reflected off soft material, such as a curtain, the high frequency elements are reduced. A hard wall is highly reflective and does not significantly affect the frequency response of the reflected sound. The WALL parameter lets you control the level of the high frequencies to alter the sonic character of your listening environment by simulating a softer (SOFT), or harder (HARD) wall. The midpoint designates a neutral wall (made of wood).

- **Seat position simulation (SEAT)**
(FRONT/REAR and LEFT/RIGHT)

If you sit in the front of a room, you hear more direct sound from the front speakers. As you move to the rear, the reflected sound increases. Similarly, the reflected sound changes when you move from left to right, and vice versa.

The FRONT/REAR and LEFT/RIGHT parameters let you control the balance of direct and reflected sound to simulate your listening position.

In the FRONT/REAR parameter, "F" signifies the front of the room and "R" signifies the rear. The midpoint designates the center.

In the LEFT/RIGHT parameter, "L" signifies the left side of the room and "R" signifies the right side. The midpoint designates the center.

- **Reverberation time (REVERB)**

This parameter adjusts the length of time required for the reverberation (echoes) generated from a given sound to attenuate -60 dB.

You can choose shorter (S) or longer (L) reverberation times.

- **Low Frequency Extension (LFE) mix level (OTHER)**

This parameter lets you attenuate the level of the LFE (Low Frequency Extension) channel output from the sub woofer without effecting the level of the bass frequencies sent to the sub woofer from the front, center or rear channels via the bass redirection circuitry. The level can be adjusted in 0.5 dB steps from -20.0 dB to 0 dB (line level). 0 dB outputs the full LFE signal at the mix level determined by the recording engineer.

Selecting MUTE mutes the sound of the LFE channel from the sub woofer. However, the low frequency sounds of the front, center, or rear speakers are output from the sub woofer according to the settings made for each speaker in the speaker setup (page 22).

- **Dynamic range compression ratio (OTHER)**

Lets you compress the dynamic range of the sound track. This may be useful when you want to watch movies at low volumes late at night.

OFF reproduces the sound track with no compression.

STD reproduces the sound track with the full dynamic range as intended by the recording engineer.

0.1 ~ 0.9 allow you to compress the dynamic range in small steps to achieve the sound you desire.

MAX provides a dramatic compression of the dynamic range.

- **Test tone (TEST)**

This parameter emits the test tone and allows you to check the balance of the speaker levels. See "Adjusting the speaker volume" on page 23 for details.

Registering Desired Components (User IR setting)

Use the USER IR CODE SETTING menu to register any IR codes that could not be registered in "Registering Audio and Video Components" on page 19. By registering User IR codes, you can control a variety of appliances (such as air conditioners) as well as audio/video components. You can register up to 20 User IR codes.

- 1 Click SETUP in the main menu to display the SETUP menu, then click USER IR.

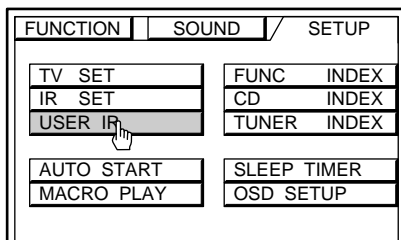

- 2 Click A B C D to select a User IR code page, then click INDEX.

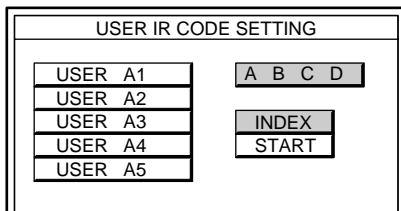

- 3 Create a name for the IR code by clicking each character. The name is automatically stored. To enter a space, click the space bar. To switch between upper and lower case letters, click CAPS. If you made a mistake, click ← or → to move the cursor to the character to be changed, then click the correct character.

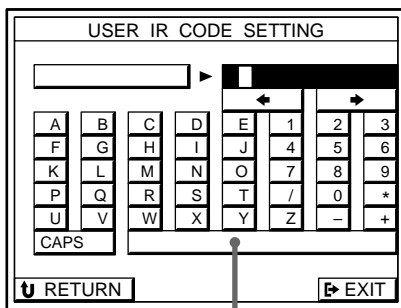

Space bar

- 4 Click RETURN to go back to the USER IR CODE SETTING menu, then repeat steps 2 to 4 until you enter the names of all the IR codes you want to register.

- 5 Click the name of the first IR code.

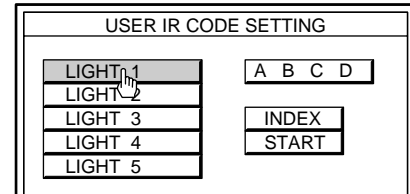

- 6 Cover the IR sensor on the respective component to prevent accidental operation during the registration procedure.

- 7 Click START. When "PUSH YOUR REMOTE" appears on the TV screen, press the button you want to register.

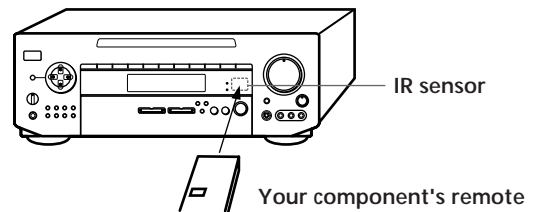
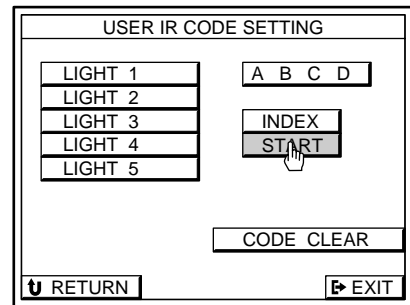

When registering the IR code, be sure to do the following; otherwise, the IR code may not be registered correctly.

- Point the remote at the IR sensor on the receiver from a distance of less than 2 inches (5 cm).
- Hold down the button on the remote for about 2 or 3 seconds until the "RECEIVING" display switches to "RELEASE YOUR REMOTE".
- Keep the remote pointed horizontally at the IR sensor until the code is registered.

To register a specific IR code

Click the button where the IR code was registered, then click START.

Notes

- If the AC power cord is disconnected for about two weeks, the registered IR codes will be cleared. "ALL CLEAR!" will appear on the TV screen the next time you turn on the receiver.
- The power switch on some air conditioners use two independent IR codes, even when there is only one switch. If you cannot turn the air conditioner off with the IR code registered for the on/off switch, repeat the procedure and register the on and off IR codes separately.
- The receiver may not be able to register IR codes with special waveforms produced on some remote controls.

Erasing IR codes

Click CODE CLEAR in the USER IR CODE SETTING menu.

- To erase a specific IR code
 - 1 Click SINGLE IR CODE CLEAR.
 - 2 Click the button you want to clear.
"Are you sure?" appears.
 - 3 Click YES to erase the code.
"CODE CLEAR!" appears.
To cancel erasing, click NO.

To erase another code, repeat steps 2 and 3.
- To erase all the User IR codes
 - 1 Click USER IR CODE CLEAR.
"Are you sure?" appears.
 - 2 Click YES to erase the codes.
"CODE CLEAR!" appears.
To cancel erasing, click NO.

Indexing

The Index functions let you specify icons for each function button and names up to 8 characters long for each function button and preset radio station.

- 1 Click SETUP in the main menu to display the SETUP menu, then click FUNC INDEX or TUNER INDEX.

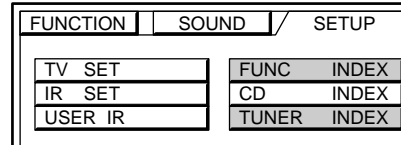

- 2
 - For the function buttons (FUNCTION INDEX)
 - 1 Click the icon to be specified.
 - 2 Click the icon you want from the icon menu, then click RETURN.
 - 3 Click the function button to be specified.

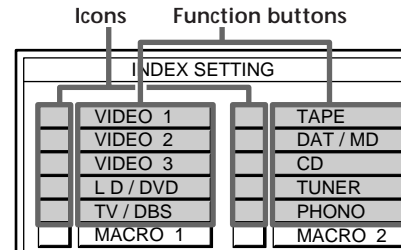

- For the preset radio stations (TUNER INDEX)
 - 1 Click LIST TUNER to display the list of the preset frequencies
 - 2 Click ABC to select the page, then select the station to be named.

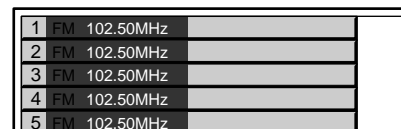

- 3 Create the new name by clicking each character. The name is stored automatically. To enter a space, click the space bar. If you made a mistake, click ← or → to move the cursor to the character to be changed, then click the correct character.

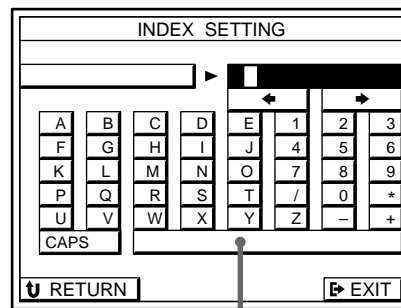

Space bar

Playing Components Automatically (Auto Play)

The Auto Play function lets you set the receiver to start playing the components immediately after they are selected from the FUNCTION SELECT menu. The receiver comes from the factory with Auto Play set to on.

- 1 Click SETUP in the main menu to display the SETUP menu, then click OSD SETUP.

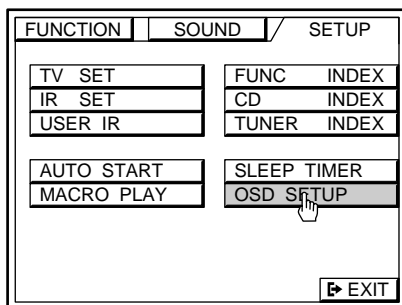

- 2 Click AUTO PLAY ON or OFF.

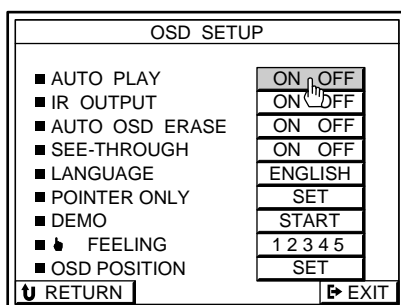

Notes

- The Auto Play function does not work when you operate the receiver from the front panel.
- The receiver cancels the automatic playback function of components designed to start playing when they are turned on (such as laser disc and CD players). To activate the auto play function, set the receiver's Auto Play to on.

Starting a Component Automatically at Power On (Auto Start)

The Auto Start function lets you set the receiver to start playing a specific component immediately whenever you turn on the receiver.

- 1 Click SETUP in the main menu to display the SETUP menu, then click AUTO START.

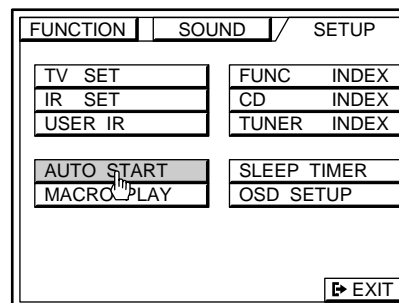

- 2 Click the component you want.
 - To start the last-played component automatically when you turn on the receiver, click LAST.
 - To do a macro automatically when you turn on the receiver, click MACRO 1 or MACRO 2. Be sure that the Auto Play function is set to on.

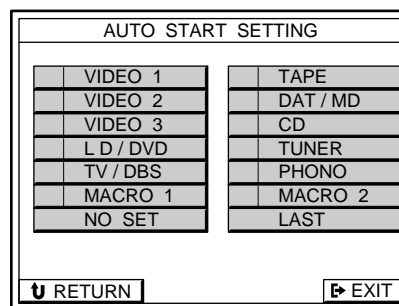

To cancel the Auto Start function
Click NO SET in step 2.

Note

A Macro Play setting containing the ALL OFF command cannot be selected for Auto Start.

Starting Several Components in Sequence Automatically (Macro Play)

The Macro Play function lets you link several IR codes in a sequential order as a single command. The receiver provides 2 pages (MACRO 1 and 2). You can specify up to 8 of the registered IR codes for each page.

Setting the sequence of IR codes

- 1 Click SETUP in the main menu to display the SETUP menu, then click MACRO PLAY.

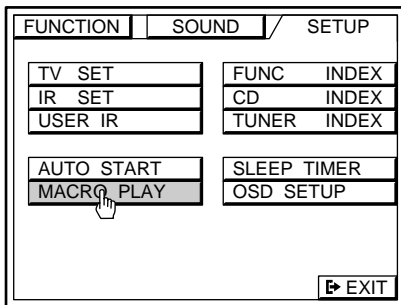

- 2 Click MACRO 1 or 2.

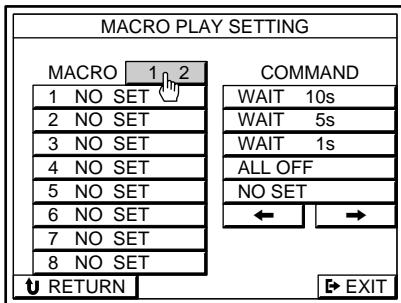

- 3 Click macro step number 1. This is the first IR code in the macro sequence.

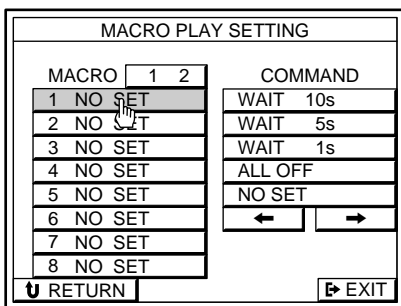

- 4 Click ← or → to show the IR codes available for that button.

The registered IR codes appear at the right of the screen.

- To specify a time lag between commands, click ← or → repeatedly until the time lag commands (WAIT 10s, WAIT 5s, and WAIT 1s) appear.
- To specify an IR code to turn off all the components, click ← or → repeatedly until ALL OFF appears.

- 5 Click the IR code you want. The name of the IR code appears in the highlighted macro step number and the highlight moves to next macro step number.

- 6 Repeat steps 4 and 5 to enter up to 8 IR codes.

To erase an entered IR code

- 1 Click the code you want to erase.
- 2 Click ← or → repeatedly until NO SET appears at the right of the screen.
- 3 Click NO SET.

Note

The ALL OFF command is not available for the Macro Play selected for Auto Start.

Starting a Macro Play

Click FUNCTION in the main menu, then click MACRO 1 or MACRO 2. The specified IR codes start automatically.

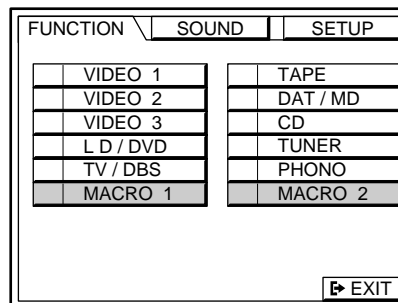

You can start a Macro Play automatically when you turn on the receiver by selecting a Macro Play in the Auto Start function (see page 44).

Adjusting the Sensitivity of the Remote

You can select from five sensitivity levels that determine the speed at which the pointer moves.

- 1 Click SETUP in the main menu to display the SETUP menu, then click OSD SETUP.
- 2 Click FEELING 1 to 5 to select the sensitivity level you want.
The higher the number, the faster the speed.

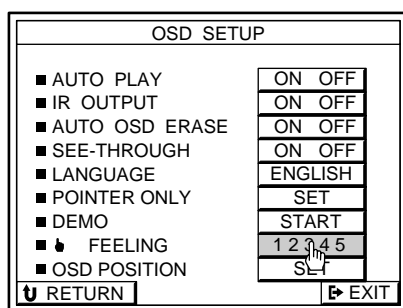

Changing the Display Settings

Selecting the display parameters

You can select the display modes (AUTO OSD ERASE, POINTER ONLY or DEMO) and the display type (SEE-THROUGH or LANGUAGE). You can also switch the IR OUTPUT setting when you connect the IR repeater.

- 1 Click SETUP in the main menu to display the SETUP menu, then click OSD SETUP.
- 2 Select the display parameters you want to change.

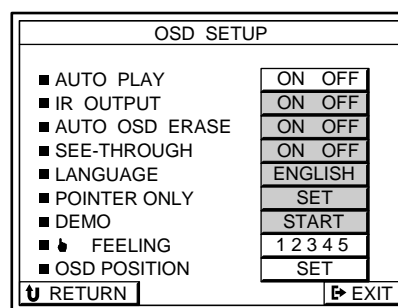

- To select the display mode, click AUTO OSD ERASE (ON or OFF), POINTER ONLY (SET) or DEMO (START).

AUTO OSD ERASE: This display mode is useful during LD player operations since it allows you to see chapter numbers that otherwise might be hidden by the control panel. When this mode is on, control panels disappear whenever you click and hold down the direction control button on the remote. When you release the button, the control panel reappears.

POINTER ONLY: This display mode allows you to use the pointer to point to various on-screen items, such as during a presentation (etc.). When you click POINTER ONLY SET, the on-screen display disappears except for the pointer and an EXIT button. To freeze the pointer, hold down the direction control button on the remote.

DEMO: This display mode activates a program that explains the various functions of the receiver. **Note that when the program is running, it replaces previously stored data (such as surround sound parameters) with data from the program.** Click START to activate the program. To stop the program, press any button on the remote or receiver.

- To select the display type, click SEE-THROUGH (ON or OFF) and LANGUAGE (ENGLISH, FRENCH or GERMAN).
SEE-THROUGH: When set to OFF, the display appears in the factory-set color. When set to ON, all menus and control panels are transparent, with only characters and outlines visible, allowing you to see the contents of video programs.

LANGUAGE: This setting lets you specify the language appearing in the on-screen display and the display on the front of the receiver. You can choose between three languages: English, French and German.

- To switch the IR OUTPUT setting, click IR OUTPUT ON or OFF. When it is set to OFF, the IR signals are output only from the IR OUT jack on the rear panel. No IR signals will be output from the IR emitter on the front panel. When the IR OUTPUT is set to OFF, "IR OFF" appears in the main menu. Normally, IR OUTPUT should be set to ON.

Note

Even if you have selected SEE-THROUGH ON, the display changes to the factory set color when there is no video signal being input. When a video signal is input, the display reverts to SEE-THROUGH ON.

Adjusting the position of the on-screen display

You can adjust the overall position of the on-screen display control panel.

- Click SETUP in the main menu to display the SETUP menu, then click OSD SETUP.
- Click OSD POSITION SET.
The position adjustment screen appears.

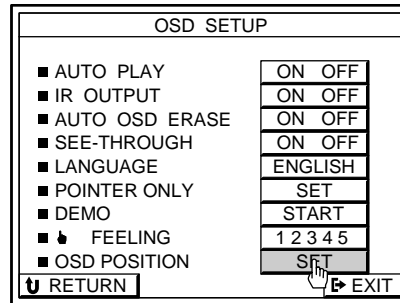

- Click the borders to adjust the position so you can just see the top, bottom, right and left edges of the border.

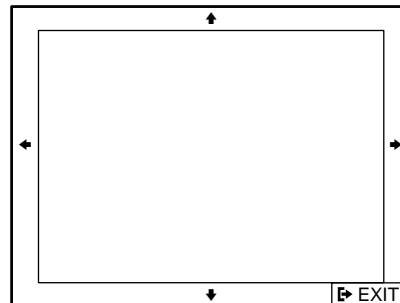

Using the Sleep Timer

You can set the receiver to turn off automatically at a time you specify.

- 1 Click SETUP in the main menu to display the SETUP menu, then click SLEEP TIMER.

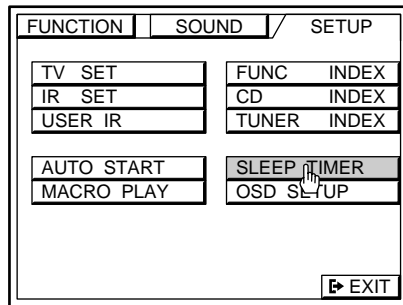

- 2 Click TIMER repeatedly to select the length of the sleep timer. Each time you click TIMER, the menu changes as follows:

→ 2:00:00 → 1:30:00 → 1:00:00 → 0:30:00 → OFF →

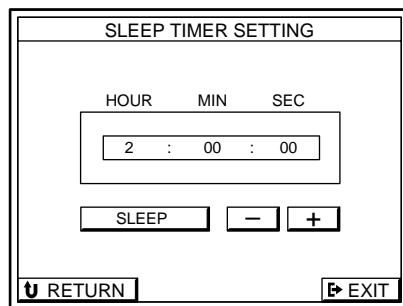

“SLEEP” appears in the upper left corner of the main menu.

- 💡 You can also freely specify the time
Click + or - to change the sleep time in 1 minute increments. You can specify up to 5 hours.
- 💡 You can check the time remaining before the receiver turns off
Click FUNCTION, then click SLEEP. The remaining time appears in the on-screen display.
- 💡 For USA and Canada
You can also operate the sleep timer by pressing SLEEP on the remote. Each time you press SLEEP, the time changes as shown in step 2 above. The display dims after you specify the time.
To check the time remaining before the receiver turns off, press SLEEP.

Operating a CD Changer

Downloading the CD name data in a Sony CD changer with a CTRL A1 jack

You can download all of the CD name data in a Sony CD changer that is equipped with a CTRL A1 jack, thus saving you the trouble of adding names one by one. Make sure that the CONTROL A1 connection is complete (see page 8) and the CD changer is registered as a Sony CONTROL A1 CD in the IR CODE SETTING menu (see page 19).

- 1 Click SETUP in the main menu to display the SETUP menu, then click CD INDEX.

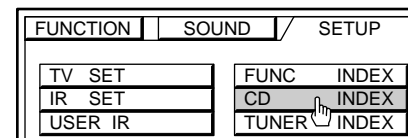

- 2 Click DATA LOAD.
The CD name data is downloaded and after a few minutes, the downloaded data appears in the CD INDEX SETTING menu.

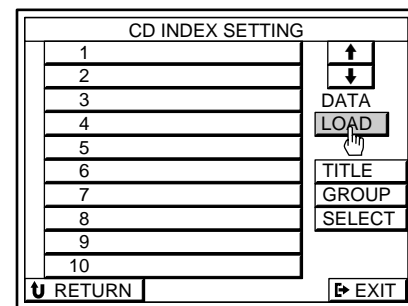

Note

If the characters (# \$; • ä ö ü) have been recorded in the CD changer, they will appear as blanks in the on-screen display.

Indexing a CD

You can specify the names up to 12 characters for each CD (up to 200 discs) or group of discs in a CD changer.

- 1 Click SETUP in the main menu, then click CD INDEX.
- 2 • To name a disc, click TITLE. And then Click **↑** or **↓** to display the number of the disc to be named, then click the disc.

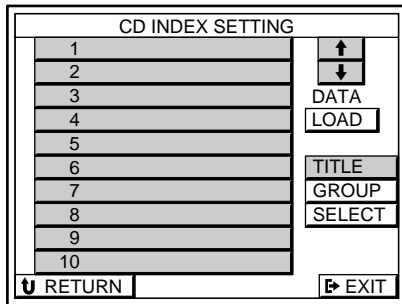

- To name a group, click GROUP, then click the group to be named.

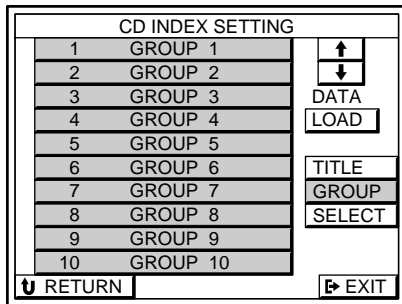

- 3 Create the new name by clicking each character. The name is automatically stored. To enter a space, click the space bar. If you made a mistake, click **←** or **→** to move the cursor to the character to be changed, then click the correct character.

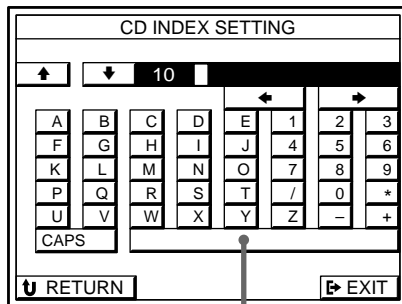

Space bar

Grouping CDs

You can assign your CDs to one or more groups.

- 1 Click SETUP in the main menu, then click CD INDEX.
- 2 Click SELECT, then click the disc you want to assign to a new group. If the disc you want does not appear, click **↑** or **↓**.

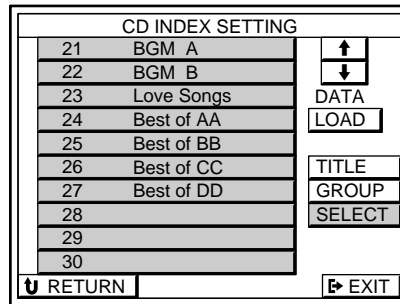

- 3 Click the names of the groups to which you want to assign the CD.

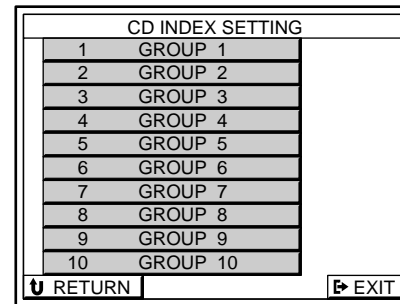

To remove the CD from one or more groups
Click the highlighted group name so that it goes out in step 3.

- 💡 You can assign the CD to one or more group
For example, to assign the CD to both "GROUP 1" and "GROUP 4," click both group names in step 3.

(continued)

Searching for a CD quickly

1 Click FUNCTION in the main menu, then click CD.

2 Click LIST.

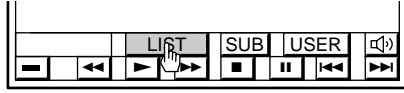

3 • To search in alphabetical order
 1 Click ALPHABET to display the discs in alphabetical order.
 2 Click the disc. If the disc you want is not displayed, click ↑ or ↓.

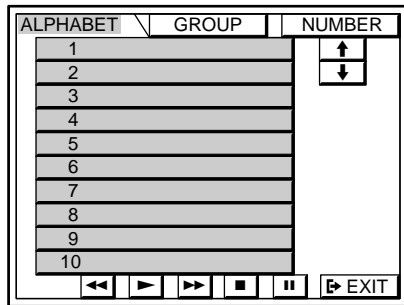

• To search using the group names
 1 Click GROUP.
 The GROUP SELECT button and a group number appear at the right side of the screen.
 If there is no group corresponding to the respective group number, "NO ENTRY" is displayed.
 2 Click SELECT to display groups 1~10.
 3 Click the group you desire.
 The group number and disc list for the selected group appear on screen.
 4 Click the disc. If the disc you want is not displayed, click ↑ or ↓.

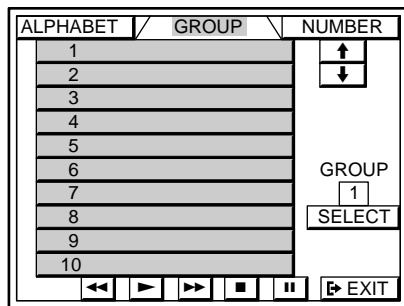

• To search by disc number.
 1 Click NUMBER to display the discs in numerical order.
 2 Click the disc. If the disc you want is not displayed, click ↑ or ↓.

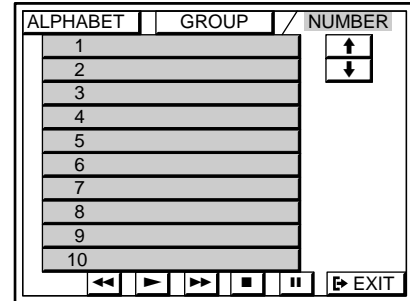

Playback starts automatically.

Notes

- Depending on the type of CD changer connected (3 or 5 disc changer, etc.), you may not be able to select the CD by clicking the disc name. In this case, select the CD from the normal CD control panel.
- If the CD changer is made by another manufacturer, and the sequence of operations required to start playback is other than; ① pressing a numeric button followed by ② pressing the disc button, then playback may not start when you click the disc name. In this case, return to the main menu, click SUB, and operate the CD changer according to its normal playback procedure.

Front Panel Descriptions

You can control the receiver using the front panel instead of the remote. For details of the operations, see the pages in parenthesis.

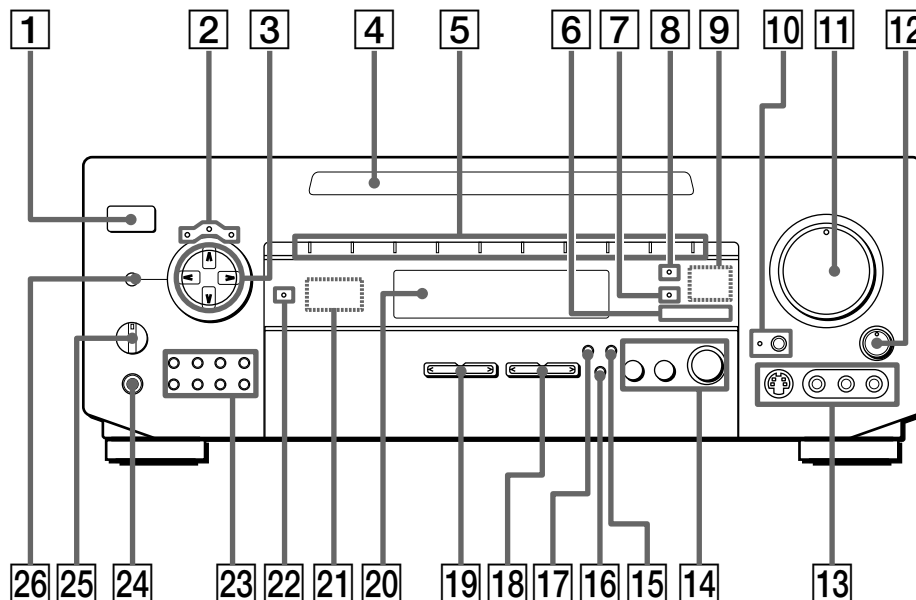

- | | |
|---|--|
| <p>1 POWER switch</p> <p>2 SUR indicator (56)
EQ indicator (STR-DE1015G) (55)
TONE indicator (STR-DE815G / D760Z) (56)
INDEX indicator (59)</p> <p>3 Digital Processing Controls</p> <p>4 IR emitter (4)</p> <p>5 FUNCTION indicators</p> <p>6 DISCRETE indicator (STR-DE1015G) (36)
5.1 INPUT indicator (STR-DE815G / D760Z) (53)</p> <p>7 DIRECT PASS indicator (56)</p> <p>8 LEARNING SENSOR indicator</p> <p>9 IR sensor (18)</p> <p>10 BASS BOOST button and indicator (53)</p> <p>11 MASTER VOLUME control (53)</p> <p>12 BALANCE control (53)</p> <p>13 VIDEO 3 input jacks (12)
(S-VIDEO terminal for STR-1015G only)</p> <p>14 SOUND FIELD buttons (55)
SOUND FIELD ON/OFF button
SOUND FIELD GENRE button
SOUND FIELD MODE button</p> | <p>15 SET UP button (57)</p> <p>16 INPUT MODE button (STR-DE1015G) (53)
5.1 INPUT button (STR-DE815G / D760Z) (53)</p> <p>17 DIRECT PASS button (56)</p> <p>18 AUDIO FUNCTION selector (53)</p> <p>19 VIDEO FUNCTION selector (53)</p> <p>20 Display</p> <p>21 IR receptor (15)</p> <p>22 STANDBY indicator (except for USA and Canadian models)</p> <p>23 Tuner operation buttons (54)
TUNING (+/-) buttons
PRESET (+/-) buttons
FM MODE button
FM/AM button
SHIFT button
DISPLAY button</p> <p>24 PHONES jack (53)</p> <p>25 SPEAKERS selector (10)</p> <p>26 DPC MODE button (55, 56, 59)</p> |
|---|--|

Remote Descriptions

■ USA and Canada

Although the direction control button lets you perform almost all of the receiver operations, for certain operations, you can also control the receiver using the other (short-cut) buttons. For details of the operations, see the pages in parenthesis.

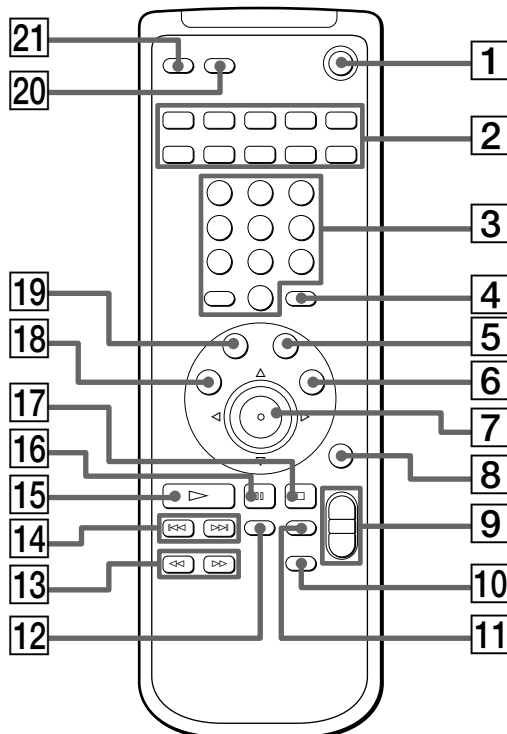

- 1 SYSTEM OFF
- 2 SYSTEM CONTROL FUNCTION buttons (54)
- 3 Number buttons
CD, MD, LD, DVD : Selects track numbers (0 selects track 10).
TV, VCR, DBS : selects channel (press ENTER to change the channel).
- 4 ENTER
TV/VCR/DBS : changes channels when used with buttons 0-9.
- 5 DBS MENU* : displays the menu of the connected DBS tuner.
- 6 DBS GUIDE* : displays the guide of the connected DBS tuner.
- 7 Direction control button (16)
- 8 EXIT
Press to exit the current menu (same function as EXIT icon in on screen display).
- 9 MASTER VOL +/- (26)
- 10 MUTING

- 11 WIDE MODE (29)
- 12 DISC SKIP
MULTI-CD : Press repeatedly to skip between discs.
- 13 ◀◀/▶▶ buttons
CD : searches tracks (Forward or backward)
Tape, MD, VCR, LD : fast forwards or rewinds
- 14 ◀◀/▶▶ buttons
CD, MD, LD : skips tracks.
- 15 ▶
CD, Tape, MD, LD, VCR : starts play.
- 16 ⏸
CD, Tape, MD, LD, VCR : pauses play or record (also starts recording with components in record standby).
- 17 □
CD, Tape, MD, LD, VCR : stops play.
- 18 VCR MENU* : displays the menu of the connected VCR.
- 19 GUI : displays or erases this unit's on-screen display.
- 20 5.1 INPUT button (STR-DE815G / D760Z) (53)
(This button cannot be used with STR-DE1015G.)
- 21 SLEEP (48)

* When you press these buttons, the receiver's on-screen display will disappear. To operate the receiver, press 19.

■ Other countries

Although the direction control button lets you perform almost all of the receiver operations, for certain operations, you can also control the receiver using the other (short-cut) buttons. For details of the operations, see the pages in parenthesis.

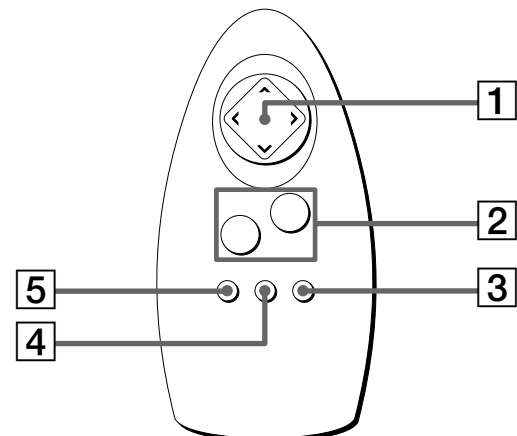

- 1 Direction control button (16)
- 2 VOL +/- (26)
- 3 ALL OFF
- 4 TV/VIDEO
TV : switches TV's input mode.
- 5 FLASHER (60)

Selecting a Component

For the on-screen operations, see page 26.

- 1 Press POWER to turn on the receiver, then press VIDEO FUNCTION or AUDIO FUNCTION repeatedly until the component you want appears in the display.

VIDEO FUNCTION

To listen to or watch	Select* ¹
Video tapes	VIDEO 1, VIDEO 2 or VIDEO 3
Laser discs (LD) or DVD	LD/DVD
TV programs or Digital Broadcasting Satellites (DBS)	TV/DBS* ²

*¹The FUNCTION HOOKUP setting (see below) allows you to delete the names of components which are not connected.

*²TV/DBS : USA, Canada and Australia
TV : Other countries

AUDIO FUNCTION

To listen to or watch	Select*
Digital Audio Tapes (DAT) or MiniDiscs (MD)	DAT/MD
Compact Discs (CD)	CD
Analog audio tapes	TAPE
Radio programs	TUNER
Records	PHONO

* The FUNCTION set up (see page 58 or 59) allows you to delete the names of components which are not connected. When a function is set to "NO" in the FUNCTION set up menu, it cannot be selected.

- 2 Start playing the component, then use MASTER VOLUME to adjust the volume.

To	Do This
Reinforce the bass	Press BASS BOOST to turn on the BASS BOOST indicator.
Adjust the balance	Turn the BALANCE control to the left (L) or right (R).
Enjoy high quality sound	Press DIRECT PASS to bypass audio effects the equalizer, bass reinforcement, and surround effects. The DIRECT PASS indicator lights up.

When you listen with headphones

Connect the headphones to the PHONES jack and set the SPEAKERS selector to OFF.

To listen to digital program sources (STR-DE1015G)

Select the digital source you desire (LD/DVD, CD or DAT/MD), then press INPUT MODE on the front panel repeatedly to select "AUTO", "DIGITAL", or "ANALOG".

See "To listen to digital program sources" on page 27 for details.

To listen to decoded Dolby Digital (AC-3) program sources (STR-DE815G / D760Z)

Press 5.1 INPUT. The 5.1 INPUT indicator lights up and the function automatically switches to LD/DVD. To listen to analog signals from the component connected to the LD/DVD jacks, select LD/DVD using the VIDEO FUNCTION selector.

Playing audio and video components at the same time

- 1 Press VIDEO FUNCTION repeatedly to select the video component you want.
- 2 Press AUDIO FUNCTION repeatedly to select the audio component you want.
- 3 Start playing the selected video and audio components.

(continued)

Selecting a component directly from the remote control (USA and Canada only)

- 1 Press one of the SYSTEM CONTROL FUNCTION buttons to select the component you want to use. The receiver and the selected component turn on. The SYSTEM CONTROL FUNCTION buttons on the remote are factory-set as follows:

To listen to or watch	Press*
Records	PHONO
Radio programs	TUNER
Compact Discs (CD)	CD
Digital Audio Tapes (DAT) or MiniDiscs (MD)	DAT/MD
Audio tapes	TAPE
TV programs or video tapes	VIDEO 1, VIDEO 2 or VIDEO 3
Laser discs/DVD	LD/DVD
Digital program sources (STR-DE1015G only)	INPUT MODE
Decoded AC-3 programs (STR-DE815G / D760Z only)	5.1 INPUT

* "NO CONNECTION" is displayed if you select a function that was set to "NO" in the FUNCTION set up menu (see page 58 or 59).

If the component does not turn on
Press the power switch on the component.

- 2 Start playing.
Refer to "Remote Descriptions" on page 52 for details.

To turn off the components

Press SYSTEM OFF. This will also turn off the video and audio components connected to the SWITCHED AC OUTLETS on the back of this unit at the same time.

Tuning Radio Stations

The receiver lets you tune a station by scanning stations (Automatic Tuning), and by selecting preset stations (Preset Tuning).

For the on-screen operations, see pages 29 to 30.

- 1 Press AUDIO FUNCTION repeatedly to display "TUNER," then press FM/AM to select FM or AM.
- 2 Press DISPLAY so that the frequency appears.
- 3 Press TUNING + or -.
The frequency indication changes and scanning stops when the receiver tunes in a station. To continue scanning, press + or - again. Press + for a higher station number; press - for a lower one.

Tuning preset stations (Preset Tuning)

- 1 Press AUDIO FUNCTION repeatedly to display "TUNER".
- 2 Press SHIFT to select a memory page (A, B or C).
- 3 Press PRESET TUNING + or - repeatedly to select the station you want. Each time you press the buttons, the preset numbers change as follows:

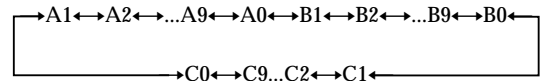

Note

If the AC power cord is disconnected for about 1 week, the preset stations will be cleared. Preset the stations again.

Recording

For the on-screen operations, see page 31.

- 1 Press VIDEO FUNCTION or AUDIO FUNCTION repeatedly to select the playback component you want to record.
- 2 Insert a blank tape into the recording component and adjust the recording level, if necessary.
- 3 Start recording on the recording component, then start playing the playback component.

To stop recording
Stop both components.

Digital Recording (STR-DE1015G only)

EXAMPLE: Recording a CD using a DAT deck.
See your DAT or CD player's instruction manual if you need help.

- 1 Press INPUT MODE repeatedly to select CD (if the CD player is connected to the DIGITAL OPTICAL: CD IN jack).
- 2 Insert a blank digital audio tape into the DAT for recording.
- 3 Start recording on the DAT, then start playing the CD you want to record.

Note
You cannot record the digital signal from a Dolby Digital (AC-3) program source.

Adjusting the Sound

The adjusted sounds are stored automatically.

To select the sound fields

For the on-screen operations, see page 36.

Press GENRE repeatedly to display the sound fields genres, then press MODE repeatedly to display the sound fields mode. For the list of sound fields, see page 33 (STR-DE1015G) or 35 (STR-DE815G / D760Z).

To turn off the sound fields
Press SOUND FIELD ON/OFF.

To adjust the equalizer parameters (STR-DE1015G)

For the on-screen operations, see page 38.

- 1 Start playing a component, then select the sound field you want to adjust.
- 2 Press DPC MODE repeatedly until the EQ indicator lights up.
- 3 Use digital processing control buttons (\wedge / \vee) to select the parameter you want.

Front speaker bass adjustment

Level : F : BASS 0dB
Frequency : F : BASS 250Hz

Front speaker treble adjustment

Level : F : TREBLE 0dB
Frequency : F : TREBLE 2.5kHz

Center speaker bass adjustment

Level : C : BASS 0dB
Frequency : C : BASS 250Hz

Center speaker treble adjustment

Level : C : TREBLE 0dB
Frequency : C : TREBLE 2.5kHz

Rear speaker bass adjustment

Level : R : BASS 0dB
Frequency : R : BASS 250Hz

Rear speaker treble adjustment

Level : R : TREBLE 0dB
Frequency : R : TREBLE 2.5kHz

(continued)

- 4 Use digital processing control buttons (</>) to adjust the level, then press (^/∨) to select the frequency (Hz). You can adjust the level ± 10 dB in 0.5 dB steps.
- 5 Repeat steps 3 and 4 to make all necessary adjustments.

To adjust the tone parameters (STR-DE815G / D760Z)

For the on-screen operations, see page 39.

- 1 Start playing a component, then select the sound field you want to adjust.
- 2 Press DPC MODE repeatedly until the TONE indicator lights up.
- 3 Use digital processing control buttons (^/∨) to select BASS or TREBLE.
Bass adjustment
Initial setting is : 0 dB
Treble adjustment
Initial setting is : 0 dB
- 4 Use digital processing control buttons (</>) to adjust the tone level. You can adjust the level ± 10 dB in 2 dB steps.
- 5 Repeat steps 3 and 4 to make all necessary adjustments.

 To turn off the equalizer or tone adjustments without erasing them
Press DIRECT PASS.

To adjust the surround sound parameters

For the on-screen operations, see pages 37 and 40 (STR-DE1015G) or 38 and 40 (STR-DE815G / D760Z).

- 1 Start playing a component, then select the sound field you want to adjust.
- 2 Press DPC MODE repeatedly until the SUR indicator lights up.

- 3 Use digital processing control buttons (^/∨) to select the parameter you want.
See “Surround (SUR) parameters” below for details.
- 4 Use digital processing control buttons (</>) to adjust the level of the parameter.

Note

Certain menu items may not be available for adjustment depending on the current settings and menu modes. Unavailable items appear dimmed when shown in the display.

Surround (SUR) parameters (STR-DE1015G)

■ Surround sound parameters (See page 40 for details)

Surround effect level (Digital Cinema Sound modes only)

Initial setting is : EFFECT [_____]

It lets you adjust the “presence” of the current digital cinema sound surround effect.

- In the KARAOKE mode, use the effect level to adjust the amount of vocal cancellation. Greater effect levels produce greater reduction of the vocals.

Wall Type

Initial setting is : WALL S____I____H

It lets you adjust the “brightness” of the current digital cinema sound surround effect.

Front to rear seat position

Initial setting is : SEAT F____I____R

It lets you adjust the atmosphere of the current digital cinema sound surround effect.

Left to right seat position

Initial setting is : SEAT L____I____R

It lets you adjust the atmosphere of the current digital cinema sound surround effect.

Reverberation time

Initial setting is : REVERB S____I____L

It lets you adjust the amount of reverberation present in the current digital cinema sound surround effect.

Low Frequency Extension (LFE) mix level (DISCRETE only)

Initial setting is : LFE MIX 0dB

This parameter lets you attenuate the level of the LFE (Low Frequency Extension) channel output from the sub woofer without effecting the level of the bass frequencies sent to the sub woofer from the front, center or rear channels via the bass redirection circuitry.

Dynamic range compression ratio

Initial setting is : D.RANGE COMP OFF

Lets you compress the dynamic range of the sound track.
This may be useful when you want to watch movies at low volumes late at night.

■ Speaker level / balance parameters (See page 23 for details)

Rear speaker balance

Initial setting is : REAR L____I____R

Lets you adjust balance between the rear speakers.

Rear speaker level

Initial setting is : REAR 0 dB

Lets you adjust level of the rear speakers.

Center speaker level

Initial setting is : CENTER 0 dB

Lets you adjust the level of the center speaker.

Sub woofer level

Initial setting is : SUB WOOFER 0 dB

Lets you adjust the level of the sub woofer.

Surround (SUR) parameters (STR-DE815G / STR-D760Z)

Surround effect level

It lets you adjust the "presence" of the current surround effect.

Delay time (Dolby Surround mode only)

Initial setting is : DELAY 20

It lets you adjust the delay time of the Dolby Pro Logic surround sound.

See page 39 for details.

Rear speaker level

Initial setting is : REAR SP 0 dB

Lets you adjust level of the rear speakers.

See pages 24 and 25 for details.

Center speaker level

Initial setting is : CENT.SP 0 dB

Lets you adjust the level of the center speaker.

See pages 24 and 25 for details.

Customizing the Receiver Operations

The menu operations allow you to customize various aspects of the receiver to suit your listening environment, your speakers, your components, and your personal preferences.

For the on-screen speaker setup operations, see page 22 (STR-DE1015G) or 24 (STR-DE815G / D760Z).

- 1 Press SET UP.
"SET UP" appears in the display.
- 2 Press SET UP repeatedly to display one of the following menus:

STR-DE1015G	STR-DE815G / STR-D760Z
SPEAKER SETUP	CENTER MODE
FUNCTION HOOKUP	DISPLAY SETUP
OTHER SETUP	FUNCTION HOOKUP
- 3 Use digital processing control buttons (^ / v) to select the parameter you want.
- 4 Use digital processing control buttons (< / >) to adjust the parameter.
- 5 Repeat steps 2 and 4 to make all necessary adjustments.
- 6 Press SET UP twice to exit the set up mode.

(continued)

Set up parameters (STR-DE1015G)

■ SPEAKER SETUP (see pages 22 to 23 for details)

Front speaker

Initial setting is : FRONT SP [LARGE]

Center speaker

Initial setting is : CENTER SP [LARGE]

Rear speaker

Initial setting is : REAR SP [LARGE]

Rear speaker place

Initial setting is : REAR SP [SIDE]

Sub woofer

Initial setting is : SUB WOOFER [YES]

■ FUNCTION HOOKUP

VIDEO1, VIDEO2, LD/DVD, TV/DBS, TAPE, DAT/MD, CD, PHONO

Initial setting is : YES

These settings let you delete the names of unconnected components from the function lists.

- YES displays the name of the respective component (jacks).
- NO deletes the name of the respective component (jacks).

Notes

- When a function is set to "NO", it cannot be selected.
- If an S-LINK signal (Control A1, Control-S) is input to the S-LINK jack from a component whose function was set to "NO", the function will automatically switch to "YES" and that function will be selected.
- When using the remote, "NO CONNECTION" is displayed if you select a function that was set to "NO" (USA and Canada only).

■ OTHER SETUP

Center speaker delay

Initial setting is : CENT. DELAY 0

See page 39 for details.

Rear speaker delay

Initial setting is : REAR DELAY 5

See page 39 for details.

Dimmer level

This setting lets you select brightness of the display on the front panel.

- You can select between four different settings.

Control A1 display

Initial setting is : CTRL A1 [AUTO]

This setting lets you specify the display mode for Control A1 components.

- AUTO displays "PLAY", "STOP", "PAUSE" or "REC" for about 8 seconds when the operation switches.
- FIX displays "PLAY", "STOP", "PAUSE", "REC" or the contents of a disc or track memo of a CD or MD at all times.
- OFF turns off the operation status display.

Notes

- This setting is only effective when the IR code setting is set to Sony Control A1.
- If the disc or track memo contains a character that the receiver cannot display, "." appears for that character.

Set up parameters (STR-DE815G / D760Z)

Center mode

Initial setting is : CENTER [NORMAL]

See page 24 for details.

■ DISPLAY set up

Dimmer level

This setting lets you select brightness of the display on the front panel.

- You can select between four different settings.

Control A1 mode

Initial setting is : CTRL A1 [AUTO]

This setting lets you specify the display mode for Control A1 components.

- AUTO displays "PLAY", "STOP", "PAUSE" or "REC" for about 8 seconds when the operation switches.
- FIX displays "PLAY", "STOP", "PAUSE", "REC" or the contents of a disc or track memo of a CD or MD at all times.
- OFF turns off the operation status display.

Notes

- This setting is only effective when the IR code setting is set to Sony Control A1.
- If the disc or track memo contains a character that the receiver cannot display, "." appears for that character.

■ FUNCTION set up

VIDEO1, VIDEO2, LD/DVD, TV/DBS, TAPE, DAT/MD, CD, PHONO

Initial setting is : YES

These settings let you delete the names of unconnected components from the function lists.

- YES displays the name of the respective component (jacks).
- NO deletes the name of the respective component (jacks).

Notes

- When a function is set to "NO", it cannot be selected.
- If an S-LINK signal (Control A1, Control-S) is input to the S-LINK jack from a component whose function was set to "NO", the function will automatically switch to "YES" and that function will be selected.
- When using the remote, "NO CONNECTION" is displayed if you select a function that was set to "NO" (USA and Canada only).

Indexing

Using the index functions, you can specify names up to 8 characters long for each component and preset radio station.

For the on-screen operations, see page 43.

- For the components
Press AUDIO FUNCTION or VIDEO FUNCTION repeatedly to select a component.
 - For the preset stations
Tune in a preset station.
- Press DPC MODE repeatedly until the INDEX indicator lights up.
- Create a name using the digital processing control buttons.
Press ^ or v to select a character, and then press > to move the cursor to the next position. The name is stored automatically.
To insert a space, press ^ or v until a blank space appears in the display. The space appears between " and A.
If you've made a mistake, press < or > repeatedly until the character you want to change flashes. Then select the right character.
- Repeat steps 1 to 3 to assign index names to other components or stations.

To switch the display

Each time you press DISPLAY, the display switches between the index name → component name (or frequency) → track memo*¹⁾ → disc memo*¹⁾.

- If the Control-A1 display mode is set to "AUTO" or "FIX" when listening to a Control-A1 compatible tape or DAT deck, the Control-A1 operations are displayed together with the index name and component name.

Example: TAPE [PLAY] → index name [PLAY]

*¹⁾ If the Control-A1 display mode is set to "FIX" when listening to a Control-A1 compatible CD player or MD deck, you can display the disc memo and track memo information in addition to the Control-A1 operations.

Example: CD [PLAY] → index name [PLAY] → disc memo*²⁾ → track memo*³⁾

*²⁾ Up to 13 characters for CD (15 for MD).

*³⁾ Up to 14 characters for CD (15 for MD).

Note

The display mode returns to FREQUENCY automatically when you press TUNING +/-.

Playing Audio Components Without the TV (Flasher) (except for USA and Canada)

Using the flasher function, you can control components without using the TV's on-screen display. Instead, you use the remote and the display on the front panel of the receiver.

- 1** Press the **FLASHER** button on the remote to turn off the on-screen display.
If you are listening to an audio source the TV turns off automatically.
- 2** Press the left or right corner of the direction control button repeatedly.
Each time you press the direction control button the receiver displays a different operation (the **FUNCTION** indicators also light to help separate the different operations).
The operations available for each component are shown below.

Component	Operations
VIDEO 1, 2, 3	FLASHER OFF, POWER ON/OFF, ◀▶, ▶▶, ■, ■■, CH -, CH +, REC
LD/DVD	FLASHER OFF, POWER ON/OFF, ◀▶, ▶▶, ■, ■■, ◀◀, ▶▶
CD	FLASHER OFF, POWER ON/OFF* ¹⁾ , ◀▶, ▶▶, ■, ■■, ◀◀, ▶▶, DISC SKIP
TUNER	FLASHER OFF, PRESET CH -, PRESET CH +
TAPE	FLASHER OFF, POWER ON/OFF, ◀▶, ▶▶, ■, ■■, REC
DAT	FLASHER OFF, ◀▶, ▶▶, ■, ■■, ◀◀, ▶▶, REC
MD	FLASHER OFF, POWER ON/OFF, ◀▶, ▶▶, ■, ■■, ◀◀, ▶▶, REC
PHONO	FLASHER OFF
TV/DBS	FLASHER OFF, POWER ON/OFF, CH -, CH +
5.1 INPUT* ²⁾	FLASHER OFF, POWER ON/OFF, ◀▶, ▶▶, ■, ■■, ◀◀, ▶▶

*¹⁾ Sony CD player only.

*²⁾ STR-DE815G and STR-D760Z only.

- 3** Click the remote when the operation you want appears in the front panel display.
The “<----->” and “<-----” displays indicate that no operations are available at the current flasher position.

To select another component

Press the up or down corner of the direction control button. The component names appear in the display one at a time. If you select a video component, the TV will turn on automatically.

To temporarily cancel the Flasher function

Press the left or right corner of the direction control button repeatedly to display “FLASHER OFF”, then click the remote.

You can also cancel by pressing **FLASHER** on the remote.

If you turn off the receiver while the Flasher function is on

The next time the receiver is turned on “FLASHER START” is displayed and the receiver turns on in the flasher mode.

Troubleshooting

If you run into any problems using this receiver, use the following list.

First, check that the power cord is connected firmly. Should any problem persist, consult your nearest Sony dealer.

Power

The TV turns off when you turn on the receiver with the remote.

- ➔ Make sure that the TV is off when you turn on the receiver with the remote.

The component turns off when you select a component with the remote.

- ➔ The component was turned on by another remote. The component needs to be turned on by the receiver's remote or manually (after selection).

Some components do not turn off when you press ALL OFF / SYSTEM OFF.

- ➔ The component was turned on by another remote. Turn off the component manually.

On-screen control

The on-screen display does not appear.

- ➔ Set your TV to the appropriate input mode.
- ➔ Place your TV away from the audio components.
- ➔ Select the appropriate component on the receiver.

The on-screen display does not respond or disappears while you are using the remote.

- ➔ Make sure the remote is not too far from the IR sensor.

The on-screen display becomes distorted when you select a component with the remote.

- ➔ There may be distortion in the video signal, but this is not a malfunction, continue as is.

You have difficulty operating the unit because the on-screen display is distorted.

- ➔ If you connect two or more VCRs to the receiver, make sure to use a distributor when connecting the TV antenna to the VCRs to preserve video signal quality.
- ➔ Clean the head of the VCR.
- ➔ Do not select channels where there is no broadcast. Set your VCR (etc.) to skip channels where there is no broadcast.

The remote does not function.

- ➔ Replace weak batteries in the remote with new ones.
- ➔ Remove any obstacles in the path of the remote and the IR sensor.
- ➔ The infrared (IR) signals transmitted from the IR emitter may not be reaching the IR sensor on the respective component. In such a case, connect the IR repeater to IR OUT jack on the rear of the receiver (see page 7).
- ➔ Press the GUI button on the remote before performing the operation (USA and Canada only).

Sound

No sound or only a very low-level sound is heard.

- ➔ Check that the speakers and components are connected securely.
- ➔ Make sure you select the correct component on the receiver.
- ➔ Make sure you set the SPEAKERS selector correctly (see page 10).
- ➔ Click the  icon if "MUTING" is displayed.
- ➔ The protective device on the receiver has been activated because of a short circuit. ("PROTECTOR" flashes.) Turn off the receiver, eliminate the short-circuit problem and turn on the power again.

The left and right sounds are unbalanced or reversed.

- ➔ Check that the speakers and components are connected correctly and securely.
- ➔ Adjust the BALANCE control on the front panel.

(continued)

Severe hum or noise is heard.

- ➔ Check that the speakers and components are connected securely.
- ➔ Check that the connecting cords are away from a transformer or motor, and at least 10 feet (3 meters) away from a TV set or fluorescent light.
- ➔ Place your TV away from the audio components.
- ➔ Make sure you connect a ground wire to the antenna ground terminal.
- ➔ The plugs and jacks are dirty. Wipe them with a cloth slightly moistened with alcohol.

No sound is heard from the center speaker.

- ➔ STR-DE1015G : Select a sound mode other than ACOUSTIC or KARAOKE (see page 37).
- ➔ STR-DE815G / D760Z : Select a sound field using the center speaker: PRO LOGIC, MOVIE (except NIGHT THEATER and MONO MOVIE) (see page 38).
- ➔ STR-DE815G / D760Z : Select the appropriate center mode (see pages 24 and 25).
- ➔ Adjust the speaker volume appropriately (see page 23 for STR-DE1015G or pages 24 and 25 for STR-DE815G / D760Z).

No sound or only a very low-level sound is heard from the rear speakers.

- ➔ Select a sound field other than ACOUSTIC.
- ➔ STR-DE815G / D760Z : Select the appropriate center mode (see pages 24 and 25).
- ➔ Adjust the speaker volume appropriately (see page 22 for STR-DE1015G or pages 24 and 25 for STR-DE815G / D760Z).

Surround effect cannot be obtained.

- ➔ Turn on the sound field function.
- ➔ Set DIRECT PASS to OFF.
- ➔ Make sure you set the SPEAKERS selector correctly (see page 10).

Tuner

Radio stations cannot be tuned in.

- ➔ Check that the antenna is connected securely. Adjust the antenna and connect an external antenna if necessary.
- ➔ The signal strength of the stations is too weak (when you tune in with Automatic Tuning). Use Direct Tuning (see page 29).
- ➔ Make sure you set the tuning interval correctly (when you tune in AM stations with Automatic Tuning) (see page 29 or 54 and 64).
- ➔ No stations have been preset or the preset stations have been cleared (when you tune in with Preset Tuning). Preset the stations (see page 30).
- ➔ Display the frequency by pressing DISPLAY (when you tune with Automatic Tuning).

Others

IR codes of components cannot be registered.

- ➔ When registering the IR code, be sure to check the following:
 - Point the remote at the IR sensor on the receiver from a distance of less than 2 inches (5 cm).
 - Hold down the button on the remote for about 2 or 3 seconds until the "RECEIVING" display switches to "RELEASE YOUR REMOTE".
 - Keep the remote pointed horizontally at the IR sensor until the code is registered.

Recording cannot be made.

- ➔ Check that the components are connected correctly.
- ➔ Select the playback component with the remote or with the AUDIO FUNCTION or VIDEO FUNCTION controls on the front panel.

A component cannot be selected

- ➔ Check the FUNCTION hookup setting of the component (see page 58 or 59).

Specifications

Audio power specifications

POWER OUTPUT AND TOTAL HARMONIC DISTORTION

With 8-ohm loads both channels driven, from 20 - 20,000 Hz; rated 100 watts per channel minimum RMS power, with no more than 0.09 % total harmonic distortion from 250 milliwatts to rated output (USA model only).

Amplifier section

POWER OUTPUT

Stereo mode

Singaporean models :
4 ohms DIN 1 kHz,
100W + 100W
Other models :
8 ohms 20 Hz - 20
kHz, THD 0.09%,
100 W + 100 W

Surround mode

Singaporean models :
(4 ohms DIN 1 kHz)
Front: 100 W + 100 W
Center*: 100 W
Rear*: 100 W/ch
Other models:
(8 ohms at 1kHz,
THD 0.8%)
Front: 100 W/ch
Center*: 100 W
Rear*: 100 W/ch
* No sound may be
output when using
certain sound sources
and/or sound mode
settings.

5.1 mode (STR-DE815G/ D760Z only)

Singaporean models:
(4 ohms DIN 1 kHz)
Front: 100 W + 100 W
Center: 100 W
Rear: 100 W/ch
Other models:
(8 ohms 20 Hz - 20
kHz, THD 0.09%)
Front: 100 W/ch
Center: 100 W
Rear: 100 W/ch

Dynamic power output (USA and Canadian models only) 155 W + 155 W, 8 ohms
220 W + 220 W, 4 ohms

Harmonic distortion at rated output Less than 0.09% (Direct Pass)

Frequency response PHONO: RIAA equalization curve ±0.5 dB
CD, TAPE, DAT/MD, LD/DVD, TV/DBS, VIDEO: 10 Hz - 50 kHz ^{+0.5} ₋₂ dB (Direct Pass)

Input (ANALOG)

	Sensitivity	Impedance	S/N
PHONO	2.5 mV	50 kilohms	75 dB ¹⁾ (A, 2.5 mV)
CD ³⁾ , LD/DVD ³⁾	200 mV		
TAPE, DAT/MD, VIDEO, LD/DVD ²⁾ , TV/DBS, CD ²⁾	150 mV	50 kilohms	82 dB ¹⁾ (A, 150mV)
5.1 INPUT ³⁾	200 mV	50 kilohms	82 dB ¹⁾ (A, 150mV)

Input (DIGITAL)²⁾

	Sensitivity	Impedance	S/N
LD/DVD AC-3 RF	-	75 ohms	100 dB (A, 20 kHz LPF)
LD/DVD, CD, DAT/MD OPTICAL	-	-	100 dB (A, 20 kHz LPF)

¹⁾ '78 IHF

²⁾ STR-DE1015G only

³⁾ STR-DE815G/D760Z only

Outputs REC OUT VIDEO 1, 2 (AUDIO) OUT:
Voltage 150 mV,
Impedance 10 kilohms
WOOFER OUT
Voltage: 2 V
Impedance: 1 kilohms
PHONES: Accepts low and high impedance headphones

BASS BOOST STR-DE1015G:
+6 dB at 50 Hz
STR-DE815G/D760Z:
+10 dB at 70 Hz

TONE ±8 dB at 100 Hz and 10 kHz

Digital signal processor section (STR-DE1015G ONLY)

Modulation (A/D conversion) High Density Linear Converter
Demodulation (D/A conversion) High Density Linear Converter (Advanced Pulse D/A converter)
Sampling frequency 48 kHz
Surround LFE MIX
MUTE, -20 ~ 0 dB, 0.5 dB step
D.RANGE COMP OFF, 0.1 ~ 0.9, STD, MAX
REAR level -20 ~ +10 dB, 0.5 dB step
CENTER level -20 ~ +10 dB, 0.5 dB step
SUB WOOFER level -20 ~ +10 dB, 0.5 dB step
WALL 17-step adjustable
SEAT L/R 17-step adjustable
F/R 17-step adjustable
EFFECT 21-step adjustable
REVERB time 17-step adjustable

The available parameters are different for each sound field, see page 37 for details.

Equalizer

Band

BASS/TREBLE
Turnover frequency
BASS: 99 Hz ~ 992 Hz
TREBLE: 1.0 kHz ~ 8.6 kHz

Level

±10 dB, 0.5 dB step

Additional Information

FM tuner section		Video section	
Tuning range	87.5 - 108.0 MHz	Inputs	1 V _{p-p} 75 ohms
Antenna terminals	75 ohms, unbalanced	Outputs	1 V _{p-p} 75 ohms
Sensitivity	Mono: 18.3 dBf, 4.5 μV Stereo: 38.3 dBf, 45 μV	General System	
Usable sensitivity	11.2 dBf, 2 μV (IHF)	Tuner section: PLL quartz-locked digital synthesizer system	
S/N	Mono: 76 dB Stereo: 70 dB	Preamplifier section: Low-noise NF type equalizer	
Harmonic distortion at 1 kHz	Mono: 0.3 % Stereo: 0.5 %	Power amplifier section: Pure-complimentary SEPP	
Separation	45 dB at 1 kHz	Power requirements	Australian models: 240 V AC, 50 Hz USA, Canadian models: 120 V AC, 60 Hz Singaporean models: 230 V AC, 50/60 Hz Other models: 120/240/220 V AC, 50/60 Hz
Frequency response	30 Hz - 15 kHz ^{+0.5} ₋₂ dB		
Selectivity	60 dB at 400 kHz		
AM tuner section			
Tuning range	With 10 kHz interval* (except for Australia and Singapore) : 530 - 1710 kHz (USA and Canada) 530 - 1610 kHz (other countries) With 9 kHz interval: 531 - 1710 kHz (USA and Canada) 531 - 1602 kHz (Other countries)	Power consumption	STR-DE1015G: USA models: 290 W Canada models: 480 VA STR-DE815G/D760Z: USA models: 280 W Canada models: 480 VA Singaporean models: 240 W Other models: 280 W
Antenna	Loop antenna	AC outlets	Australian and Singaporean models: 1 switched, total 100 W Other models: 2 switched, total 120 W
Usable sensitivity	50 dB/m (at 1,000 kHz or 999 kHz)	Dimensions	430 x 155 x 350 mm (17 x 6 1/8 x 13 7/8 inches)
S/N	54 dB (at 50 mV/m)	Mass (Approx.)	STR-DE1015G: 11.4 kg (25 lb 3 oz) STR-DE815G/D760Z: Singaporean models: 11.5 kg (25 lb 6 oz) Other models: 10.5 kg (23 lb 3 oz)
Harmonic distortion	0.5 % (50 mV/m, 400 kHz)		
Selectivity	At 9 kHz: 35 dB At 10 kHz: 40 dB		

* You can change the AM tuning interval between 9 kHz and 10 kHz. After tuning in any AM station, turn off the receiver. While holding down the PRESET + button, press the POWER switch. When you change the interval, all the preset stations will be erased. To reset the interval, repeat the same procedure.

Supplied accessories

See page 5.

Design and specifications are subject to change without notice.

Glossary

Center mode

Setting of speakers to enhance Dolby Pro Logic Surround mode. To obtain the best possible surround sound, select one of the four center modes (WIDE, NORMAL, PHANTOM or 3 CH LOGIC) according to your speaker system.

Dolby Pro Logic Surround

Decoding system of Dolby Surround sound standardized in TV programs and movies. Compared with the former Dolby Surround system, Dolby Pro Logic Surround improves sound image by using four separate channels: off-screen audio effects, on-screen dialog, left-to-right panning, and music. These channels manipulate the sound to be heard and enhance the action as it happens on the screen.

Dolby Surround

Encoding and decoding system of Dolby Surround sound for consumer use. Dolby Surround decodes the extra channels on the Dolby Surround-encoded sound tracks of movie videos and TV programs and produces sound effects and echoes that make the action seem to envelop you.

The receiver offers Dolby Surround (PRO LOGIC) as one of the pre-programmed sound fields. If you have rear or center speaker(s), we recommend that you customize the Dolby Surround sound field by selecting the appropriate center mode to take advantage of Dolby Pro Logic Surround sound.

Effect level

Combination of the level of early reflections and reverberation. You can adjust the effect level in 6 levels. As you select higher levels, the room becomes "live," and as you select lower levels, the room becomes "dead."

Parameter

Variable of sound that composes sound image, such as tone or delay time. You can customize the pre-programmed sound fields by adjusting parameters to suit your listening situation.

Sound field

Sound pattern produced by a sounding source or sources in a given environment due to direct and reflected sounds and the acoustics of the environment. The receiver offers pre-programmed sound fields to let you enjoy surround sound easily.

Surround sound

Sound that consists of three elements: direct sound, early reflected sound (early reflections) and reverberative sound (reverberation). The acoustics where you hear the sound affect the way these three sound elements are heard. These sound elements are combined in such a way that you can actually feel the size and the type of a concert hall.

• Types of sound

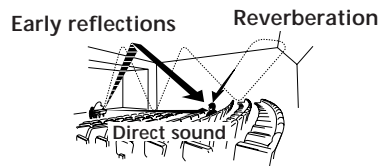

• Transition of sound from rear speakers

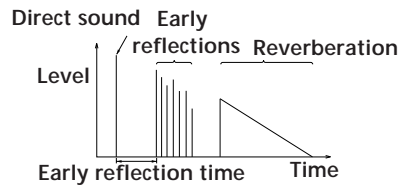

Index

A, B

- AC-3. *See* Dolby Digital (AC-3)
- Adjusting
 - delay time 39, 57
 - position of the on-screen display 47
 - sound parameter 37, 38, 55
 - sensitivity of remote 46
 - speaker volume 23, 24, 58
 - tone 38, 39, 55, 56
 - volume 23, 25, 26, 53
- Antenna hookups
 - AM/FM 7
- Audio components hookups 8
- Automatic play 44
- Automatic start 44
- Automatic tuning 29, 54

C

- Center mode 24, 25, 59, 65
 - NORMAL mode 24
 - PHANTOM mode 24
 - 3 CH LOGIC mode 24
 - WIDE mode 24
- CD changer operation 48
- Changing the display settings 46
- Connecting. *See* Hookups
- Customizing sound fields 37, 55

D

- Decoded Dolby Digital AC-3 programs 27, 53
- Delay time 39, 57, 58
- Digital components
 - connecting 13
 - playback from 27, 53
- Dimming the display 58, 59
- Direct tuning 29
- Dolby Digital (AC-3)
 - speaker setting 9-10
 - sound modes 33
- Dolby Pro Logic Surround
 - getting the most out of 24
- Dolby Surround sound 33, 65
- Dubbing. *See* Recording

E

- Editing. *See* Recording
- Effect level 37, 38, 56, 57

F

- Front panel 51

G

- Grouping CDs 49

H

- Hookups
 - AC power cord 14
 - AM/FM antennas 7
 - audio components 8
 - digital components 13
 - IR repeater 7
 - overview 5
 - speakers 9
 - TV/VCRs 11

I, J, K

- Indexing
 - CDs 49
 - preset stations 43, 59
 - program sources 43, 59
 - using the controls on the front panel 59
- Inserting batteries into the remote 15
- IR repeater 7, 46-47

L

- Labeling. *See* Indexing

M

- Macro operations 45

N, O

- Naming. *See* Indexing
- NORMAL mode 24

P, Q

- Parameter 37, 38, 65
- PHANTOM mode 24
- Playing audio components
 - without TV 60
- Preset station 30
- Presetting
 - radio stations 30
- Preset tuning 30, 54
- Program source
 - indexing 43, 59
 - selecting 26, 53

R

- Rear panel 5, 6
- Receiving broadcasts. *See* Tuning
- Recording 31
 - using the controls on the front panel 55
- Registering IR codes 17, 19, 42
 - clearing the signal 18, 21, 43
- Remote 15-21, 52
 - controlling non-Sony components 17, 19, 42
 - controlling Sony components 17, 19
 - inserting batteries 15
 - sensitivity 46
 - usage 15-16

S

- Scanning
 - CD list 50
 - preset stations 30, 54
 - radio stations 29, 54
- Searching for a CD 50
- Selecting
 - a component 26
 - using the front panel 53
 - display parameter 57-59
- Sleep timer 48
- Sound field
 - adjustable parameters 37, 38
 - customizing 37-41, 55-57
 - pre-programmed 33-35
- Speakers
 - connection 9
 - impedance 10
 - placement 9-10
 - selecting the speaker system 10
- Storing radio stations. *See* Presetting
- Surround sound 65

T

- Test tone 23, 24
- 3 CH LOGIC mode 24
- Troubleshooting 61
- Tuning
 - by scanning indexed stations 30
 - directly 29
 - using preset stations 30, 54
 - using the controls on the front panel 54
- TV/VCR hookups 11

U, V

- Unpacking 6

W, X, Y, Z

- Watching
 - TV 28
 - video programs 28
- WIDE mode 24

Free Manuals Download Website

<http://myh66.com>

<http://usermanuals.us>

<http://www.somanuals.com>

<http://www.4manuals.cc>

<http://www.manual-lib.com>

<http://www.404manual.com>

<http://www.luxmanual.com>

<http://aubethermostatmanual.com>

Golf course search by state

<http://golfingnear.com>

Email search by domain

<http://emailbydomain.com>

Auto manuals search

<http://auto.somanuals.com>

TV manuals search

<http://tv.somanuals.com>