

Multi Channel AV Receiver

Operating Instructions

STR-DA1200ES

WARNING

To reduce the risk of fire or electric shock, do not expose this apparatus to rain or moisture.

To prevent fire, do not cover the ventilation of the apparatus with news papers, table-cloths, curtains, etc. And don't place lighted candles on the apparatus.

To prevent fire or shock hazard, do not place objects filled with liquids, such as vases, on the apparatus.

Do not install the appliance in a confined space, such as a bookcase or built-in cabinet.



Install this system so that the power cord can be unplugged from the wall socket immediately in the event of trouble.



Don't throw away the battery with general house waste, dispose of it correctly as chemical waste.

NOTICE FOR THE CUSTOMERS IN THE UNITED KINGDOM

A moulded plug complying with BS1363 is fitted to this equipment for your safety and convenience.

Should the fuse in the plug supplied need to be replaced, a fuse of the same rating as the supplied one and approved by ASTA or BSI to BS1362, (i.e., marked with  or  mark) must be used.

If the plug supplied with this equipment has a detachable fuse cover, be sure to attach the fuse cover after you change the fuse. Never use the plug without the fuse cover.

If you should lose the fuse cover, please contact your nearest Sony service station.

For customers in Europe

Disposal of Old Electrical & Electronic Equipment (Applicable in the European Union and other European countries with separate collection systems)



This symbol on the product or on its packaging indicates that this product shall not be treated as household waste. Instead it shall be handed over to the applicable collection point for the recycling of electrical and electronic equipment. By ensuring this product is disposed of correctly, you will help prevent potential negative consequences for the environment and human health, which could otherwise be caused by inappropriate waste handling of this product. The recycling of materials will help to conserve natural resources. For more detailed information about recycling of this product, please contact your local Civic Office, your household waste disposal service or the shop where you purchased the product.

About This Manual

- The instructions in this manual are for model STR-DA1200ES. Check your model number by looking at the lower right corner of the front panel.
- The instructions in this manual describe the controls on the supplied remote. You can also use the controls on the receiver if they have the same or similar names as those on the remote.

This receiver incorporates Dolby* Digital and Pro Logic Surround and the DTS** Digital Surround System.

- * Manufactured under license from Dolby Laboratories.
“Dolby”, “Pro Logic”, “Surround EX”, and the double-D symbol are trademarks of Dolby Laboratories.
- ** Manufactured under license from Digital Theater Systems, Inc. U.S. Pat. No’s. 5,451,942; 5,956,674; 5,974,380; 5,978,762; 6,226,616; 6,487,535 and other U.S. and world-wide patents issued and pending.
“DTS”, “DTS-ES”, “Neo:6”, and “DTS 96/24” are trademarks of Digital Theater Systems, Inc. Copyright 1996, 2003 Digital Theater Systems, Inc. All Rights Reserved.

This receiver incorporates High-Definition Multimedia Interface (HDMI™) technology.

HDMI, the HDMI logo and High-Definition Multimedia Interface are trademarks or registered trademarks of HDMI Licensing LLC.

Table of Contents

Getting Started

Description and location of parts	6
1: Installing speakers	16
2: Connecting speakers	17
3a: Connecting the audio components	19
3b: Connecting the video components	24
4: Connecting the antennas (aerials)	35
5: Preparing the receiver and the remote	36
6: Setting the speakers	38
7: Calibrating the appropriate settings automatically (AUTO CALIBRATION)	40

Playback

Selecting a component	47
Listening to a Super Audio CD/CD	48
Watching a DVD	49
Enjoying video games	50
Watching video	51

Amplifier Operations

Navigating through menus	52
Adjusting the level (Level Settings menu)	56
Adjusting the equalizer (EQ Settings menu)	57
Settings for the surround sound (Sur Settings menu)	59
Settings for the tuner (Tuner Settings menu)	61
Settings for the audio (Audio Settings menu)	62
Settings for the video (Video Settings menu)	63
Settings for the speakers (Speaker Settings menu)	63
Settings for the system (System Settings menu)	67

Calibrating the appropriate settings automatically (Auto Calibration menu)	68
--	----

Enjoying Surround Sound

Enjoying Dolby Digital and DTS surround sound (A.F.D. mode)	69
Selecting a pre-programmed sound field (DCS)	71
Using only the front speakers (2CH STEREO)	73
Enjoying the surround effect at low volume levels (NIGHT MODE)	73
Listening to the sound without any adjustment (ANALOG DIRECT)	74
Adjusting the speaker levels and balance (TEST TONE)	74
Resetting sound fields to the initial settings	76

Tuner Operations

Listening to FM/AM radio	77
Storing FM stations automatically (AUTOBETICAL)	78
Presetting radio stations	79
Using the Radio Data System (RDS)	81

Other Operations

Displaying menus of the receiver on the TV screen	83
Naming inputs	84
Switching between digital and analog audio (INPUT MODE)	85
Listening to digital sound from other inputs (DIGITAL ASSIGN)	86
Watching HDMI images from other inputs (HDMI ASSIGN)	87

Watching component images from other inputs	
(COMPONENT VIDEO ASSIGN)	88
Changing the display	89
Using the Sleep Timer	90
Recording using the receiver	90
Using a bi-amplifier connection	91

Using the Remote

Operating each component using the remote	93
Programming the remote	94
Clearing all the contents of the remote's memory	97

Additional Information

Glossary	98
Precautions	100
Troubleshooting	101
Specifications	105
Index	108

Description and location of parts

Front panel

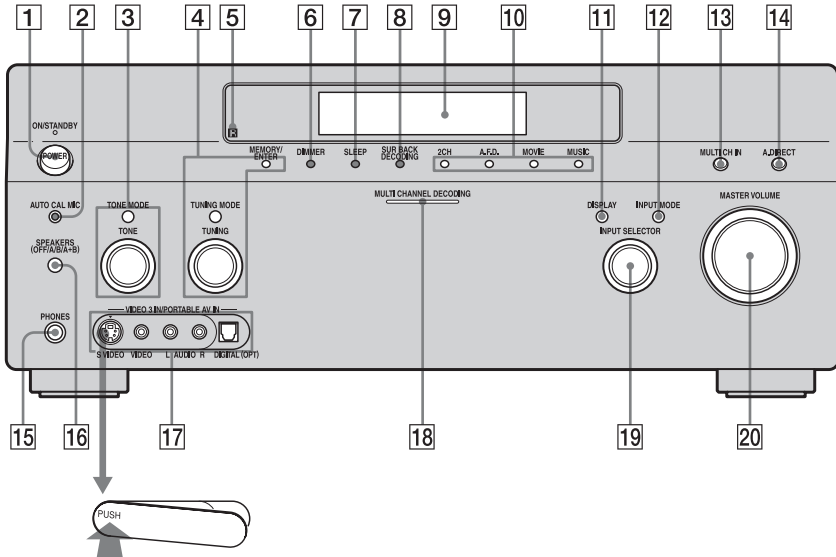

To remove the cover

Press PUSH.

When you remove the cover, keep it out of reach from children.

Name	Function
1 POWER	Press to turn the receiver on or off (page 36, 48, 49, 50, 51, 76).
2 AUTO CAL MIC jack	Connects to the supplied optimizer microphone for the Digital Cinema Auto Calibration function (page 40).

Name	Function
3 TONE MODE TONE	Adjusts FRONT BASS and FRONT TREBLE. Press TONE MODE repeatedly to select BASS or TREBLE, then turn TONE to adjust the level (page 57).
4 MEMORY/ENTER TUNING MODE TUNING	Press to operate a tuner (FM/AM) (page 77).
5 Remote sensor	Receives signals from remote commander.
6 DIMMER	Press to adjust brightness of the display.
7 SLEEP	Press to activate the SLEEP function (page 90).
8 SUR BACK DECODING	Press to activate SB DECODING (page 60).
9 Display window	The current status of the selected component or a list of selectable items appears here (page 8).
10 2CH A.F.D. MOVIE MUSIC	Press to select sound field (page 69).
11 DISPLAY	Press to select information displayed on the display window (page 89).

Name	Function
12 INPUT MODE	Press to select the input mode when the same components are connected to both digital and analog jacks (page 85).
13 MULTI CH IN	Press to select the audio input signal from the component connected to the MULTI CHANNEL INPUT jack (page 47).
14 A.DIRECT	Press to listen to high quality analog sound (page 74).
15 PHONES jack	Connects to headphones (page 72).
16 SPEAKERS (OFF/A/B/A+B)	Press to select A, B, A+B, OFF of the front speakers (page 38).
17 VIDEO 3 IN/ PORTABLE AV IN jack	Connect to a portable audio/video component such as a camcorder or video game (page 32, 50).
18 MULTI CHANNEL DECODING lamp	Lights up when multi-channel audio signals are decoded (page 49).
19 INPUT SELECTOR	Turn to select the input source to play back (page 47, 48, 49, 50, 51, 84, 85, 91).
20 MASTER VOLUME	Turn to adjust the volume level of all speakers at the same time (page 47, 48, 49, 50, 51).

About the indicators on the display

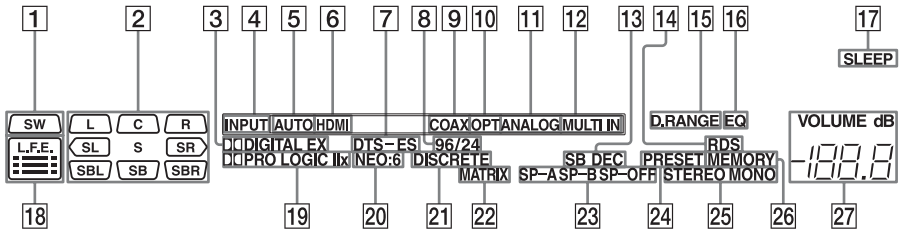



Name	Function
1 SW	Lights up when sub woofer selection is set to "YES" and the audio signal is output from the SUB WOOFER jack (page 63). While this indicator lights up, the receiver creates a sub woofer signal based on the L.F.E. signal in the disc being played back or the low frequency components of the front channels.

Name	Function
2 Playback channel indicators	The letters (L, C, R, etc.) indicate the channels being played back. The boxes around the letters vary to show how the receiver downmixes the source sound (based on the speaker settings).
L	Front Left
R	Front Right
C	Center (monaural)
SL	Surround Left
SR	Surround Right
S	Surround (monaural or the surround components obtained by Pro Logic processing)
SBL	Surround Back Left
SBR	Surround Back Right
SB	Surround Back (the surround back components obtained by 6.1 channel decoding)
Example:	Recording format: (Front/Surround): 3/2.1 Output channel: Surround speakers are set to "NO." Sound Field: A.F.D. AUTO

Name	Function
3 DIGITAL (EX)	Lights up when the receiver is decoding Dolby Digital Surround signals. "DIGITAL EX" also lights up when the receiver is decoding Dolby Digital Surround EX signals. When playing a Dolby Digital format disc, be sure that you have made digital connections and that INPUT MODE is not set to "ANALOG" (page 85).
4 INPUT	Lights up constantly. One of the input indicators also lights up according to the current input.
5 AUTO	Lights up when INPUT MODE is set to "AUTO" (page 85).
6 HDMI	Lights up when the receiver recognizes a component connected via an HDMI IN jack (page 25).
7 DTS (-ES)	Lights up when the receiver is decoding DTS signals. "DTS-ES" also lights up when the receiver is decoding DTS-ES signals. When playing a DTS format disc, be sure that you have made digital connections and that INPUT MODE is not set to "ANALOG" (page 85).
8 96/24	Lights up when the receiver is decoding DTS96/24 (96 kHz/24 bit).

Name	Function
9 COAX	Lights up when INPUT MODE is set to "AUTO" and the source signal is a digital signal being input through the COAXIAL jack, or when INPUT MODE is set to "COAX" (page 85).
10 OPT	Lights up when INPUT MODE is set to "AUTO" and the source signal is a digital signal being input through the OPTICAL jack, or when INPUT MODE is set to "OPT" (page 85).
11 ANALOG	Lights up when INPUT MODE is set to "AUTO" and no digital signal is being input through the COAXIAL or OPTICAL jacks, or when INPUT MODE is set to "ANALOG," or when the ANALOG DIRECT function is being used (page 85).
12 MULTI IN	Lights up when MULTI IN is selected (page 47).
13 SB DEC	Lights up when surround back sound decoding is activated (page 60).
14 RDS	Lights up while receiving RDS information (page 81).
15 D.RANGE	Lights up when dynamic range compression is activated (page 57).
16 EQ	Lights up when the equalizer is activated (page 57).
17 SLEEP	Lights up when the sleep timer is activated (page 90).

continued

Name	Function
18 L.F.E.	Lights up when the disc being played back contains an L.F.E. (Low Frequency Effect) channel and the L.F.E. channel signal is actually being reproduced, the bars underneath the letters light up to indicate the level. Since the L.F.E. signal is not recorded in all parts of the input signal the bar indication will fluctuate (and may turn off) during playback.
19  PRO LOGIC (II/ IIX)	Lights up when the receiver applies Pro Logic processing to 2 channel signals in order to output the center and surround channel signals. “  PRO LOGIC II” also lights up when the Pro Logic II MOVIE/MUSIC/GAME decoder is activated. “  PRO LOGIC IIX” also lights up when the Pro Logic IIX MOVIE/MUSIC/GAME decoder is activated (page 70). Note This indicator does not light if both the center and surround speakers are set to “NO” (page 64).
20 NEO:6	Lights up when DTS Neo:6 Cinema/Music decoding is activated (page 70).
21 DISCRETE	Lights up when DTS-ES Discrete decoding is activated (page 60).
22 MATRIX	Lights up when DTS-ES Matrix decoding is activated (page 60).

Name	Function
23 SP-A/SP-B/ SP-OFF	Lights up according to the speaker system used (page 38). “SP-OFF” lights up when “SP-OFF” is selected or headphones are connected.
24 PRESET	Lights up when TUNING MODE is “PRESET.”
25 Tuner indicators	Lights up when using the receiver to tune in radio stations (page 77–82), etc.
26 MEMORY	Lights up when a memory function, such as Name Input (page 84) etc., is activated.
27 VOLUME	Displays the current volume.

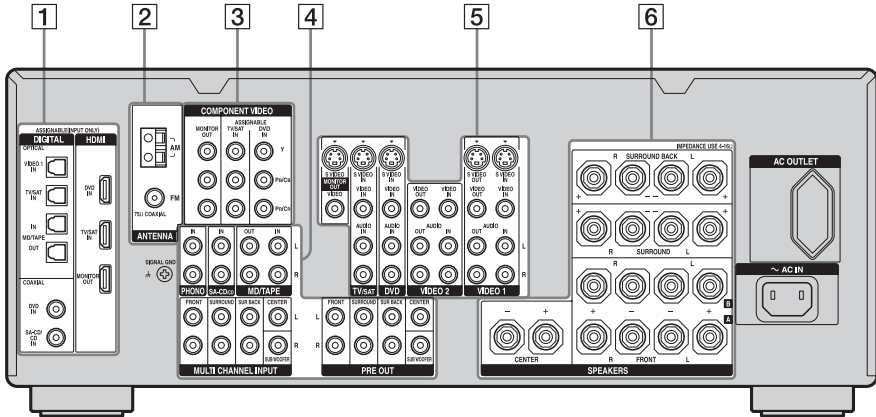

1 DIGITAL INPUT/OUTPUT section



OPTICAL IN/OUT jacks

Connects to a DVD player, Super Audio CD player, etc. The **COAXIAL** jack provides a better quality sound (page 19, 20, 29).



COAXIAL IN jacks



HDMI IN/MONITOR OUT jacks

Connects to a DVD player, or a satellite tuner. An image and the sound are output to TV or a projector (page 25).

2 ANTENNA section



FM ANTENNA jack

Connects to the FM wire antenna (aerial) supplied with this receiver (page 35).



AM ANTENNA jack

Connects to the AM loop antenna (aerial) supplied with this receiver (page 35).

3 COMPONENT VIDEO INPUT/OUTPUT section



Y

COMPONENT VIDEO Connects to a DVD player, TV, or a satellite tuner. (page 27, 29).



Pb/Cb



Pr/Cr

INPUT/OUTPUT jacks*

4 AUDIO INPUT/OUTPUT section



L

AUDIO IN/OUT jacks

Connects to a MD deck or tape deck, etc (page 19, 23).



R

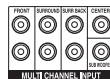

MULTI CHANNEL INPUT jacks

Connects to a Super Audio CD player or DVD player with an analog audio jack for 7.1 channel or 5.1 channel sound (page 19, 22).

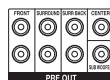

PRE OUT jacks

Connects to an external power amplifier.

5 VIDEO/AUDIO INPUT/OUTPUT

section



L

AUDIO IN/
OUT jacks

Connects to a VCR
or a DVD player etc.
(page 29, 30, 31, 32).



R



VIDEO IN/
OUT jacks*



S VIDEO IN/
OUT jacks*

6 SPEAKERS section



Connects to speakers
(page 17).

* You can watch the selected input image when you connect the MONITOR OUT jack to a TV (page 27). You can also display certain menu settings and the sound field on the monitor when you press ON SCREEN on the remote (page 83).

Remote commander

You can use the supplied remote RM-AAP015 to operate the receiver and to control the Sony audio/video components that the remote is assigned to operate (page 94).

RM-AAP015

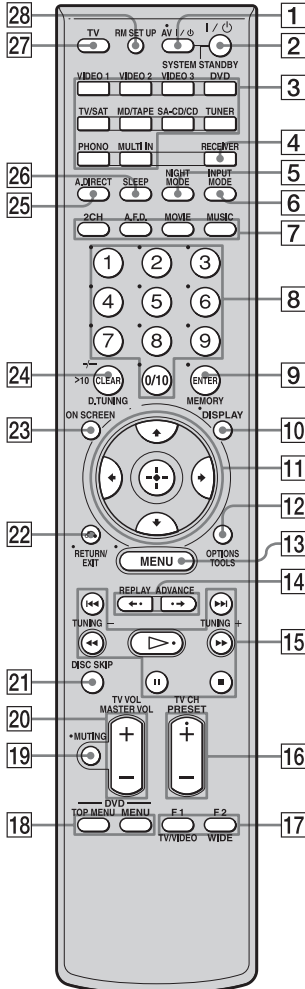

Name	Function
1 AV I/O (on/standby)	Press to turn on or off the audio/video components that the remote is assigned to operate (page 94). If you press the I/O (2) at the same time, it will turn off the receiver and other Sony components (SYSTEM STANDBY). Note The function of the AV I/O switch changes automatically each time you press the input button (3).
2 I/O (on/standby)	Press to turn the receiver on or off.
3 Input buttons	Press one of the buttons to select the component you want to use. When you press any of the input buttons, the receiver turns on. The buttons are factory assigned to control Sony components (page 47). You can program the remote to control non-Sony components following the steps in "Programming the remote" (page 94).
4 RECEIVER	Press to enable the receiver operation (page 52).
5 NIGHT MODE	Press to activate the NIGHT MODE function (page 73).
6 INPUT MODE	Press to select the input mode when the same components are connected to both digital and analog jacks (page 85).
7 2CH A.F.D. MOVIE MUSIC	Press to select a sound field (page 69).

continued

13GB

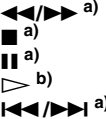
Name	Function
8 Numeric buttons	Press to <ul style="list-style-type: none"> – preset/tune to preset stations. – select track numbers of the CD player, DVD player or MD deck. Press 0/10 to select track number 10. – select channel numbers of the VCR or satellite tuner. – After pressing TV (27), press the numeric buttons to select the TV channels.
9 ENTER	Press to enter the value after selecting a channel, disc or track using the numeric buttons.
MEMORY	Press to store a tuner station during tuner operation.
10 DISPLAY	Press to select information displayed on the display window, TV screen of the VCR, satellite tuner, CD player, DVD player, or MD deck (page 89).
11  ▲/▼/◀/▶	After pressing MENU (13) or TOP MENU (18), press ▲/▼, ◀ or ▶ to select the settings. Then press ⊕ to enter the selection (page 52).
12 TOOLS	Press to display and select items from the option menus for DVD player, etc.
OPTIONS	
13 MENU	Press to display the menu of the receiver, a DVD player or TV, etc.
14 REPLAY ◀/ ADVANCE ▶	Press to replay the previous scene or fast forward the current scene of the VCR or DVD player.
15 	Press to operate the DVD player, CD player, MD deck or tape deck, etc.
TUNING +/-	Press to select stations (page 77, 80).
16 PRESET + b)/- a)	Press to register FM/AM Radio stations or to select preset stations.
TV CH +/-	Press TV (27) and then press TV CH+/- to operate the TV, satellite tuner, VCR, etc.

Name	Function
17 F1/F2	Press TV (27) and then press F1 or F2 to select a component to operate. <ul style="list-style-type: none"> • Hard disk recorder F1: HDD F2: DVD • DVD/VHS combo player F1: DVD F2: VHS
TV/VIDEO	Press TV/VIDEO and TV (27) at the same time to select the input signal (TV input or video input).
WIDE	Press to select the wide picture mode.
18 TOP MENU	Press to display the menu or on-screen guide of the DVD player on the TV screen. Then use ▲/▼/◀/▶ and ⊕ to perform menu operations.
MENU	Press to display the menus of the DVD player on the TV screen. Then use ▲/▼/◀/▶ and ⊕ to perform menu operations (page 93).
19 MUTING	Press to activate the muting function (page 47).
20 MASTER VOL +/-	Press to adjust the volume level of all speakers at the same time (page 47).
TV VOL +/-	Press TV (27) and then press TV VOL +/- to adjust the volume level of the TV.
21 DISC SKIP	Press to skip a disc when using a multi-disc changer.
22 RETURN/ EXIT ↶	Press to return to the previous menu or exit the menu while the menu or on-screen guide of the VCR, DVD player, or satellite tuner is displayed on the TV screen (page 93).
23 ON SCREEN	Press to display the receiver status. Then, if you press MENU (13), the menus of the receiver appear (page 83).

Name	Function
24 CLEAR	Press to <ul style="list-style-type: none"> – clear a mistake when you press the incorrect numeric button. – return to continuous playback, etc. of the satellite tuner or DVD player.
>10	Press to select <ul style="list-style-type: none"> – track numbers over 10 of the VCR, satellite tuner, CD player or MD deck. – channel numbers of the Digital CATV terminal.
D.TUNING	Press to enter direct tuning mode (page 78).
25 A.DIRECT	Press to switch the audio of the selected input to analog signal without any adjustment (page 74).
26 SLEEP	Press to activate the Sleep Timer function and the duration which the receiver turns off automatically (page 90).
27 TV	Press to enable TV operation.
28 RM SET UP	Press to set up the remote.

Notes

- Some functions explained in this section may not work depending on the model.
- The above explanation is intended to serve as an example only. Therefore, depending on the component, the above operation may not be possible or may operate differently than described.

^{a)} See the table on page 93 for information on the buttons that you can use to control each component.

^{b)} The tactile dot is attached to these buttons (▷, PRESET+). Use as a mark of operation.

1: Installing speakers

This receiver allows you to use a 7.1 channel system (7 speakers and one sub woofer).

Enjoying a 5.1/7.1 channel system

To fully enjoy theater-like multi-channel surround sound requires five speakers (two front speakers, a center speaker, and two surround speakers) and a sub woofer (5.1 channel system).

Example of a 5.1 channel speaker system configuration

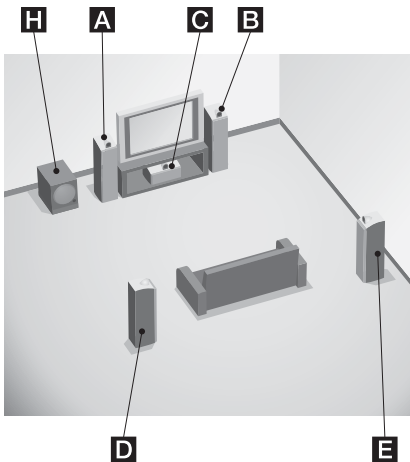

- A** Front left speaker
- B** Front right speaker
- C** Center speaker
- D** Surround left speaker
- E** Surround right speaker
- H** Sub woofer

You can enjoy high fidelity reproduction of DVD software recorded sound in the Surround EX format if you connect one additional surround back speaker (6.1 channel system) or

two surround back speakers (7.1 channel system). (see “Using the surround back decoding mode (SB DECODING)” on page 60).

Example of a 7.1 channel speaker system configuration

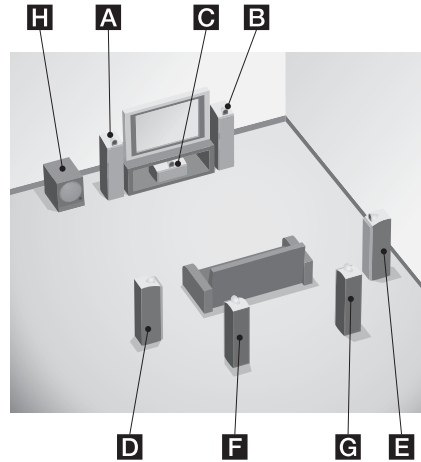

- A** Front left speaker
- B** Front right speaker
- C** Center speaker
- D** Surround left speaker
- E** Surround right speaker
- F** Surround back left speaker
- G** Surround back right speaker
- H** Sub woofer

Tips

- When you connect a 6.1 channel speaker system, place the surround back speaker behind the listening position.
- Since the sub woofer does not emit highly directional signals, you can place it wherever you want.

2: Connecting speakers

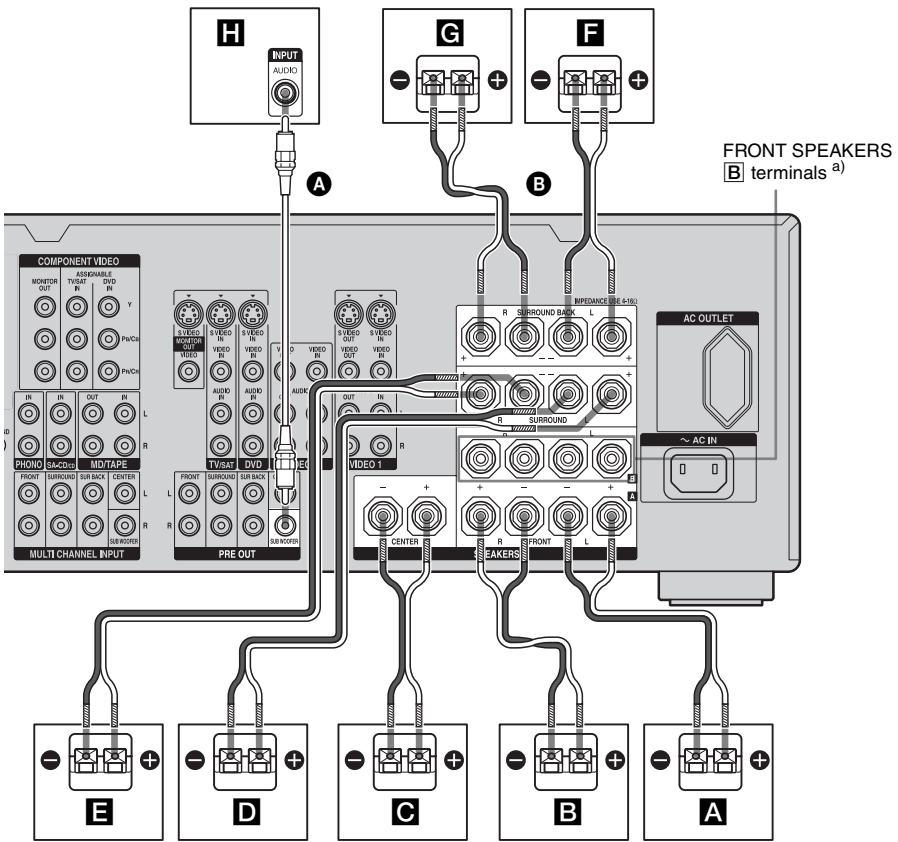

- A** Monaural audio cord (not supplied)
- B** Speaker cords (not supplied)

- A** Front speaker **A** (L)
- B** Front speaker **A** (R)
- C** Center speaker
- D** Surround speaker (L)
- E** Surround speaker (R)
- F** Surround back speaker (L)^{b)}
- G** Surround back speaker (R)^{b)}
- H** Sub woofer^{c)}

^{a)} If you have an additional front speaker system, connect them to the FRONT SPEAKERS **B** terminals. You can select the front speaker system you want to use with the SPEAKERS (OFF/A/B/A+B) on the front panel (page 38).

^{b)} If you connect only one surround back speaker, connect it to the SURROUND BACK SPEAKERS L terminals.

continued

17^{GB}

- c) When you connect a sub woofer with an auto standby function, turn off the function when watching movies. If the auto standby function is set to on, it turns to standby mode automatically based on the level of the input signal to a sub woofer, then sound may not be output.

Note

When you connect all the speakers with a nominal impedance of 8 ohms or higher, set "SP. IMPEDANCE" in the System Settings menu to "8 ohm." In other connections, set it to "4 ohm." For details, see "6: Setting the speakers" (page 38).

Tip

To connect certain speakers to another power amplifier, use the PRE OUT jacks. The same signal is output from both the SPEAKERS terminals and the PRE OUT jacks. For example, if you want to connect just the front speakers to another amplifier, connect that amplifier to the PRE OUT FRONT L and R jacks.

3a: Connecting the audio components

How to hook up your components

This section describes how to hook up your components to this receiver. Before you begin, refer to “Component to be connected” below for the pages which describe how to connect each component.

After hooking up all your components, proceed to “4: Connecting the antennas (aerials)” (page 35).

Component to be connected		Page
Super Audio CD player/ CD player	With digital audio output	20
	With multi-channel audio output	22
	With analog audio output only	23
MD/TAPE	With digital audio output	20
	With analog audio output only	23
Analog disc turntable		23

Audio input/output jacks to be connected

The sound quality depends on the jack used. Refer to the illustration that follows. Select the connection configuration according to the jacks of your components.

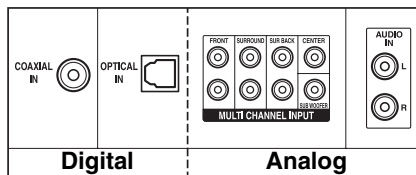

← High quality sound

Notes

- When connecting optical digital cords, insert the plugs straight in until they click into place.
- Do not bend or tie optical digital cords.

Tip

All the digital audio jacks are compatible with 32 kHz, 44.1 kHz, 48 kHz, and 96 kHz sampling frequencies.

Connecting components with digital audio input/output jacks

The following illustration shows how to connect a Super Audio CD player, CD player and an MD/TAPE deck.

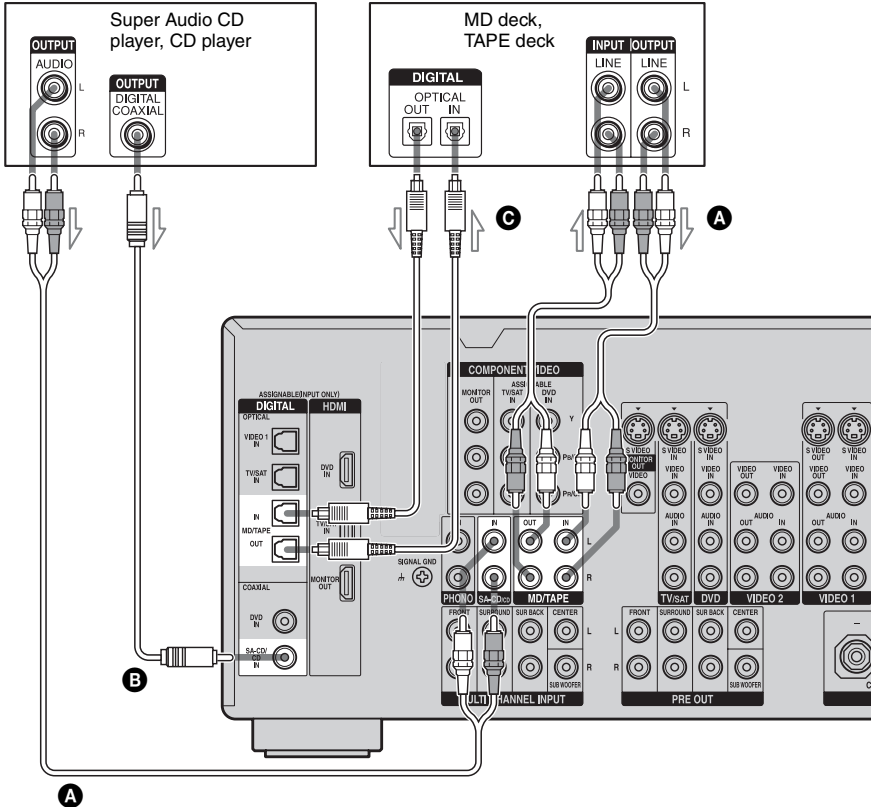

- Ⓐ Audio cord (not supplied)
- Ⓑ Coaxial digital cord (not supplied)
- Ⓒ Optical digital cord (not supplied)

Notes on playing a Super Audio CD on a Super Audio CD player

- No sound is output when playing a Super Audio CD on a Super Audio CD player connected to only the COAXIAL SA-CD/CD IN jacks on this receiver. When you play a Super Audio CD, connect the player to the MULTI CHANNEL INPUT or SA-CD/CD IN jacks. Refer to the operating instructions supplied with the Super Audio CD player.
- You cannot make digital recordings of a Super Audio CD. Use the analog jack for recording in this case.
- When connecting optical digital cords, insert the plugs straight in until they click into place.
- Do not bend or tie digital optical cords.

If you want to connect several digital components, but cannot find an unused input

See “Listening to digital sound from other inputs (DIGITAL ASSIGN)” (page 86).

Tip

You cannot connect an LD player’s DOLBY DIGITAL RF OUT jack directly to this receiver’s digital input jacks. You must use an RF demodulator for this configuration.

Connecting components with multi-channel output jacks

If your DVD or Super Audio CD player is equipped with multi-channel output jacks, you can connect it to the MULTI CHANNEL INPUT jacks of this receiver to enjoy multi-channel sound. Alternatively, the multi-channel input jacks can be used to connect an external multi-channel decoder.

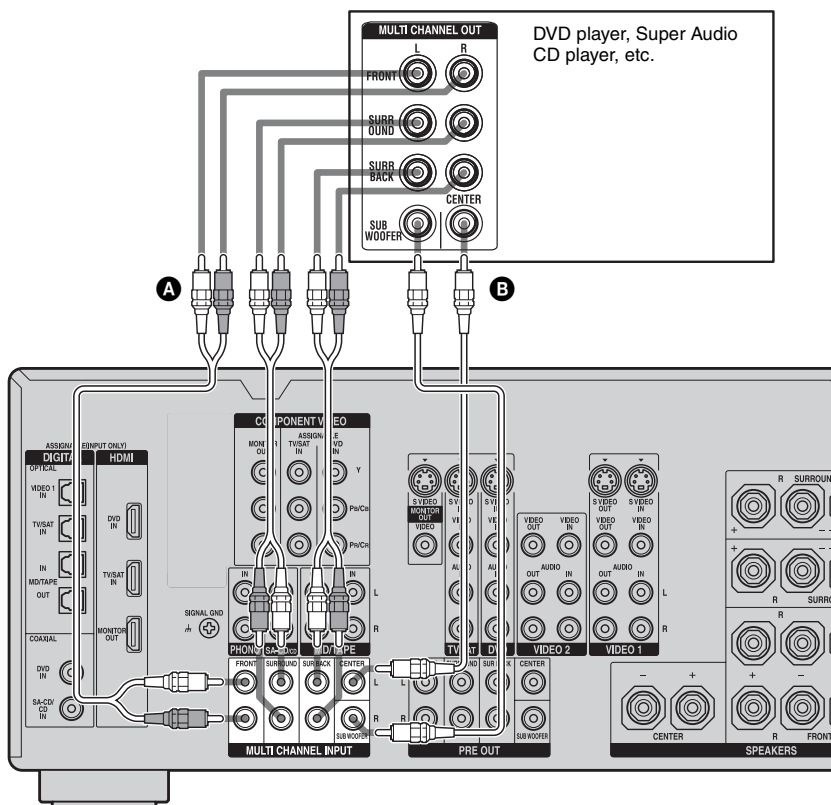

- A** Audio cord (not supplied)
- B** Monaural audio cord (not supplied)

Note

DVD and Super Audio CD players do not have the SURROUND BACK jacks.

Connecting components with analog audio jacks

The following illustration shows how to connect a component with analog jacks, such as tape deck, turntable, etc.

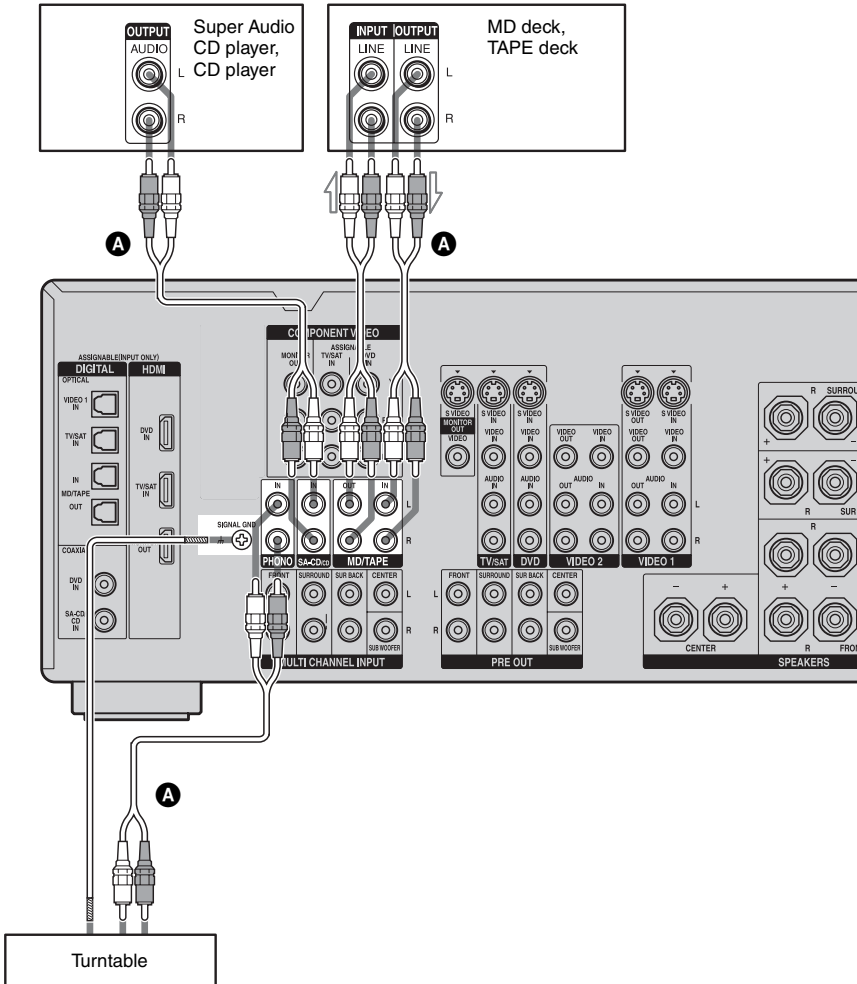

A Audio cord (not supplied)

Note

If your turntable has a ground (earth) wire, connect it to the (⏏) SIGNAL GND terminal.

3b: Connecting the video components

How to hook up your components

This section describes how to hook up your components to this receiver. Before you begin, refer to “Component to be connected” below for the pages which describe how to connect each component.

After hooking up all your components, proceed to “4: Connecting the antennas (aerials)” (page 35).

Component to be connected	Page
With HDMI jack	25
TV monitor	27
DVD player, DVD recorder	29-30
Satellite tuner	31
VCR	32
Camcorder, video game, etc.	32

Video input/output jacks to be connected

The image quality depends on the connecting jack. Refer to the illustration that follows. Select the connection according to the jacks on your components.

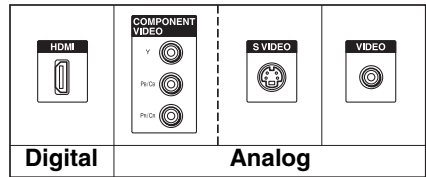

High quality image

Connecting components with HDMI jacks

HDMI is the abbreviated name for High-Definition Multimedia Interface. It is an interface which transmits video and audio signals in digital format.

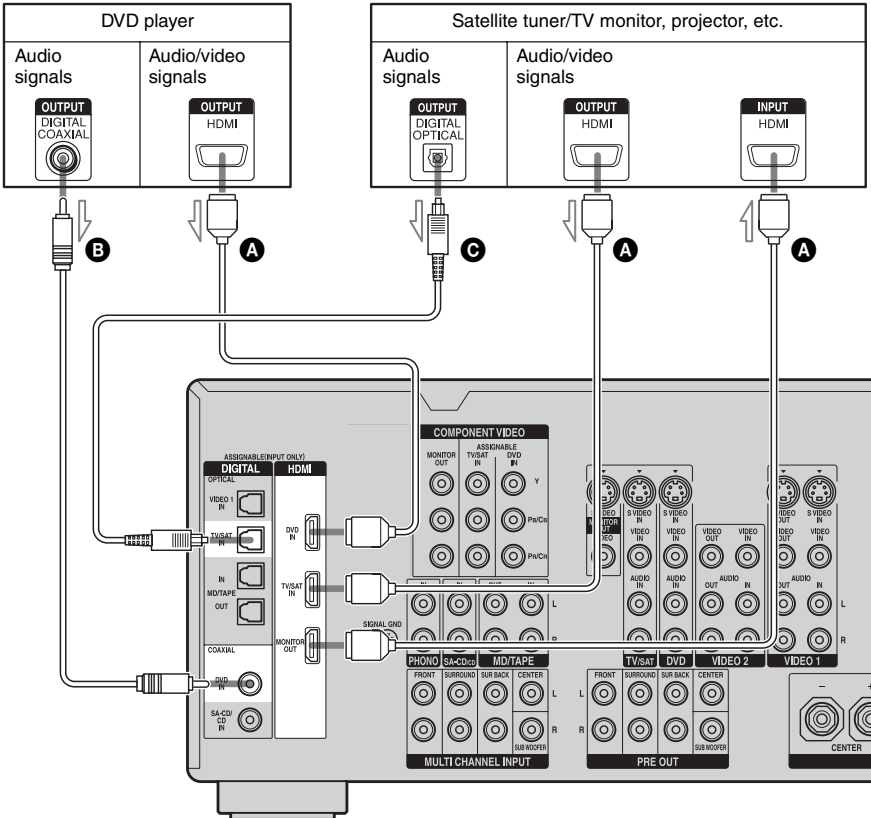

- A** HDMI cable (not supplied)

We recommend that you use a Sony HDMI cable.

- B** Coaxial digital cord (not supplied)
- C** Optical digital cord (not supplied)

continued

Notes on HDMI connections

- Audio signals input to the HDMI IN jacks are output from the HDMI OUT jack. The input audio signals are not output from the speaker output jacks, PRE OUT jacks and any other audio output jacks.
- You must connect audio or digital cords to output sound from the receiver (page 29, 31).
- Video signals input to the HDMI IN jack can only be output from the HDMI OUT jack. The input video signals cannot be output from the VIDEO OUT jacks, S VIDEO OUT jacks, or MONITOR OUT jacks.
- Use an HDMI cable with the HDMI logo (made by Sony).
- Check the setup of the connected component if an image is poor or the sound does not come out of a component connected via the HDMI cable.
- Be sure to turn on the receiver when video and audio signals of a playback component are being output to a TV through this receiver. Unless the power is on, neither video nor audio signals will be transmitted.
- This receiver may not be able to transfer video or audio signals with certain types of components.
- Refer to the operating instructions of each component connected for details.

Connecting a TV monitor

The image from a visual component connected to this receiver and the menu of this receiver can be displayed on a TV screen.

It is not necessary to connect all the cables.

Connect audio and video cords according to the jacks of your components.

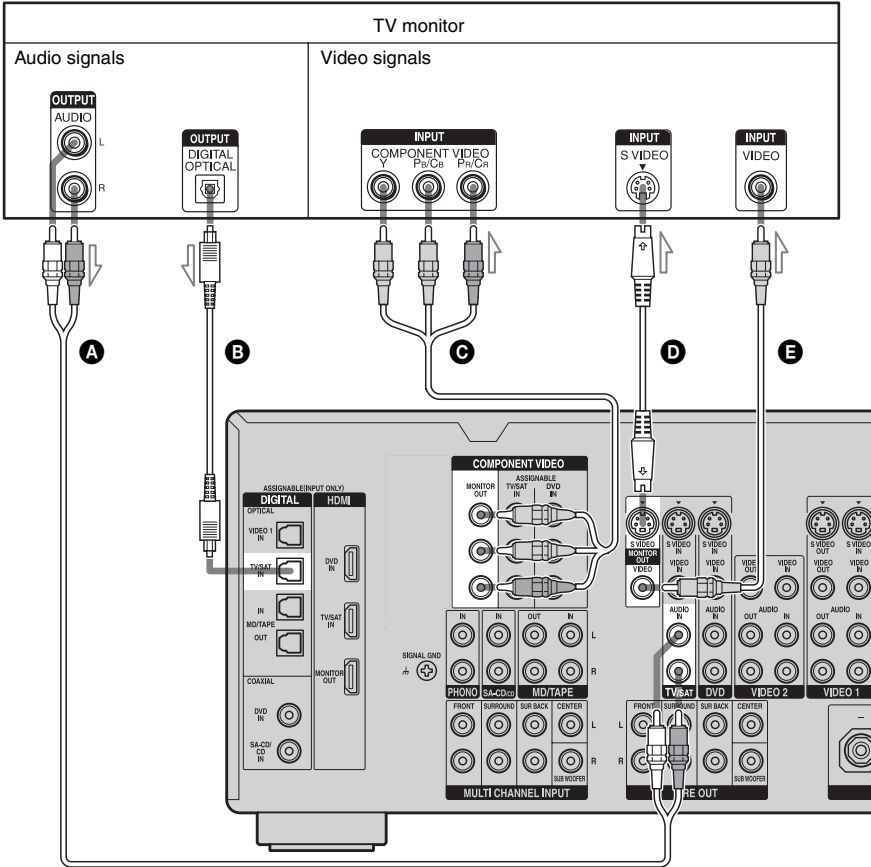

- A** Audio cord (not supplied)
- B** Optical digital cord (not supplied)
- C** Component video cord (not supplied)
- D** S video cord (not supplied)
- E** Video cord (not supplied)

continued

Notes

- Connect image display components such as a TV monitor or a projector to the MONITOR OUT jack on the receiver. You may not be able to record, even if you connect recording components.
- Turn on the receiver when the video and audio of a playback component are being output to a TV via the receiver. If the power supply of the receiver is not turned on, neither video nor audio is transmitted.
- Depending on the status of the connection between the TV and the antenna (aerial), the image on the TV screen may be distorted. In this case, place the antenna (aerial) farther away from the receiver.

Tips

- The receiver has a video conversion function. For details, see “Notes on converting video signals” (page 34).
- You can watch the selected input image when you connect the MONITOR OUT jack to a TV monitor. You can also display certain menu settings and the sound field on the monitor when you press ON SCREEN (page 83).
- The sound of the TV is output from the speakers connected to the receiver if you connect the sound output jack of the TV and the TV/SAT AUDIO IN jacks of the receiver. In this configuration, set the sound output jack of the TV to “Fixed” if it can be switched between either “Fixed” or “Variable.”

Connecting a DVD player/DVD recorder

The following illustration shows how to connect a DVD player/DVD recorder. It is not necessary to connect all the cables. Connect audio and video cords according to the jacks of your components.

Note

To output multi-channel digital audio, set the digital audio output setting on the DVD player. Refer to the operating instructions supplied with the DVD player.

Connecting a DVD player

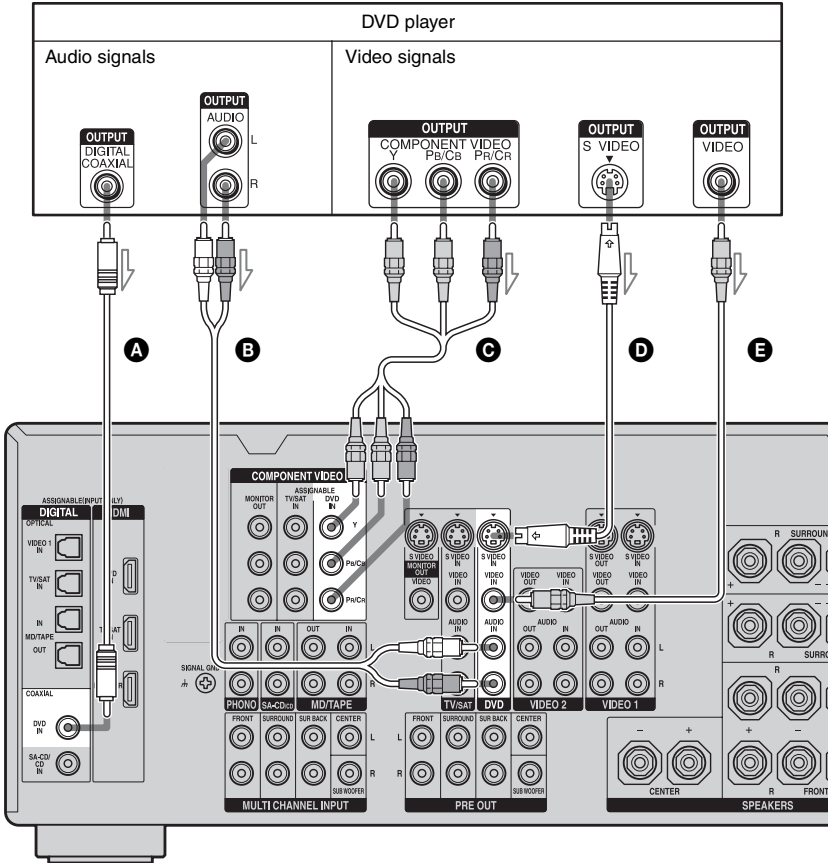

- A** Coaxial digital cord (not supplied)
- B** Audio cord (not supplied)
- C** Component video cord (not supplied)
- D** S video cord (not supplied)
- E** Video cord (not supplied)

continued

29GB

Connecting a DVD recorder

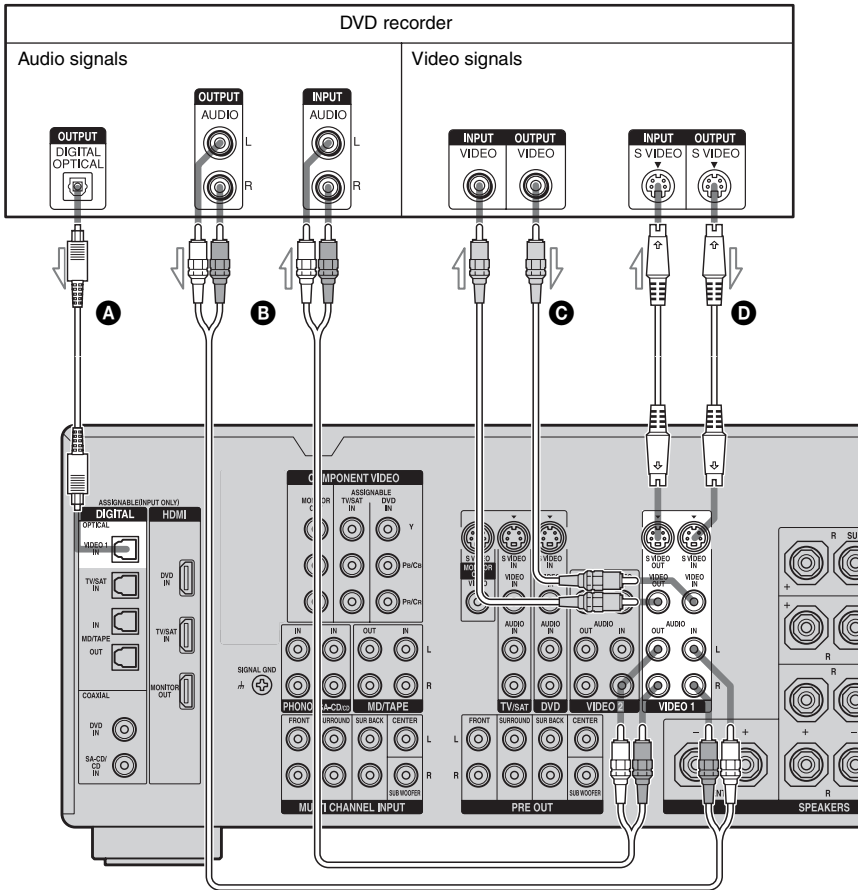

- A** Optical digital cord (not supplied)
- B** Audio cord (not supplied)
- C** Video cord (not supplied)
- D** S video cord (not supplied)

Connecting components with analog video and audio jack

The following illustration shows how to connect a component which has analog jacks such as a VCR, etc.

It is not necessary to connect all the cables. Connect audio and video cords according to the jacks of your components.

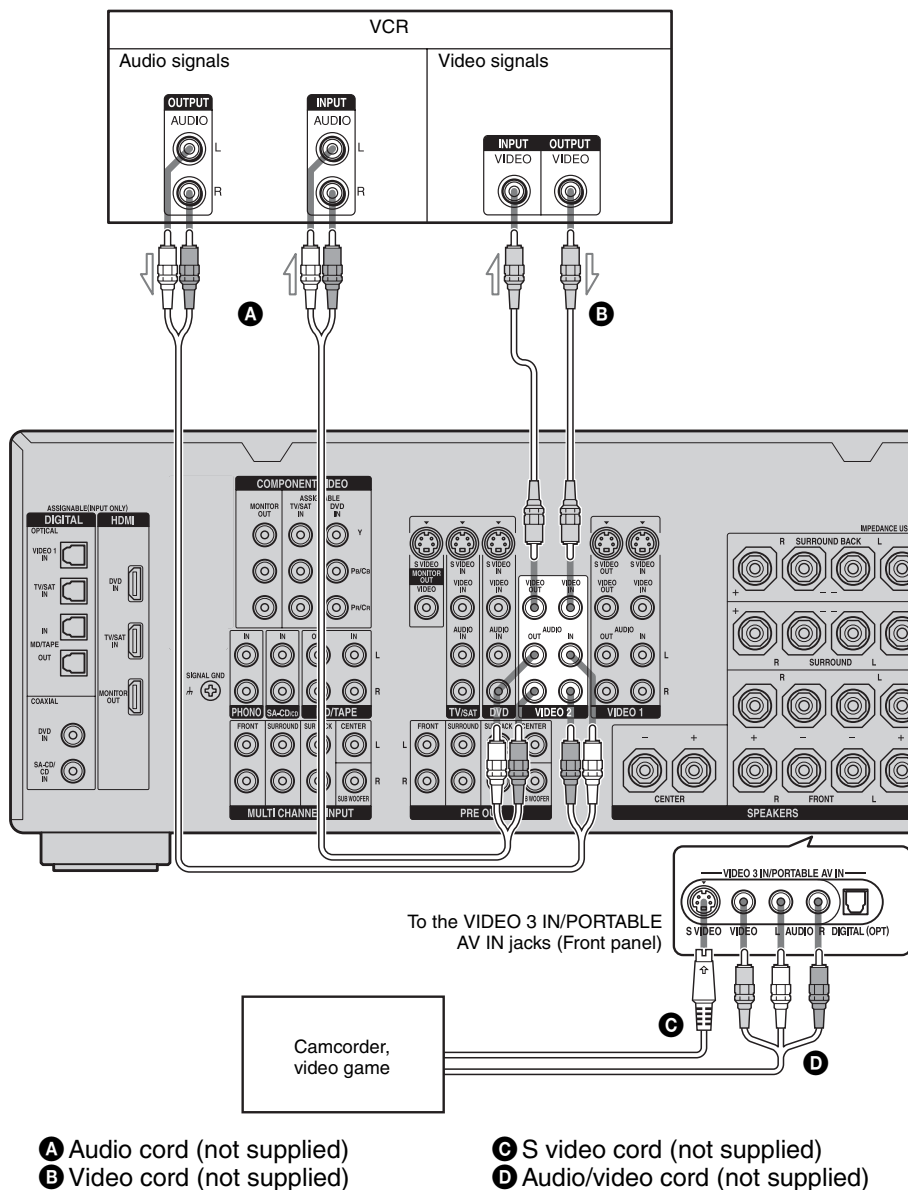

Function for conversion of video signals

This receiver is equipped with a function for converting video signals. You can output the video signal after connecting this receiver via the MONITOR OUT jack as shown in the illustration.

- Composite video signals can be output as S video signals and component video signals.
- S video signals can be output as component video signals.

In the video input/output conversion table of the receiver

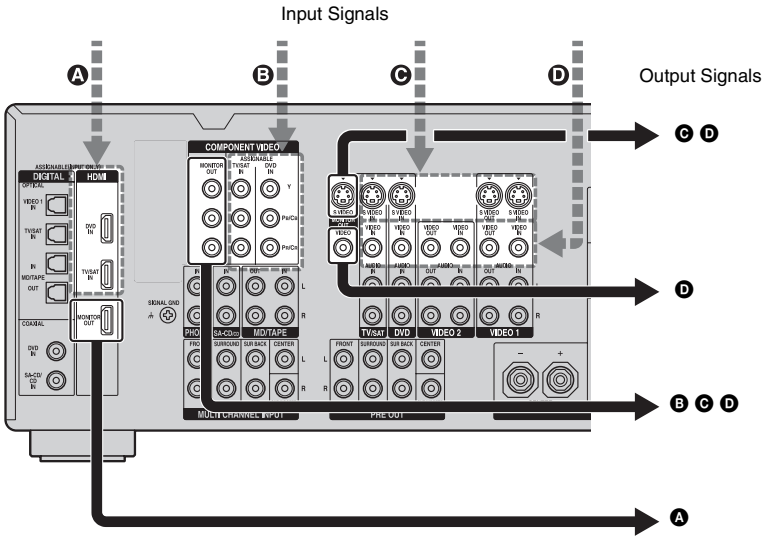

OUTPUT jack \ INPUT jack	HDMI OUT	COMPONENT VIDEO MONITOR OUT	S VIDEO MONITOR OUT	VIDEO MONITOR OUT
HDMI IN A	△	X	X	X
COMPONENT VIDEO IN B	X	△	X	X
S VIDEO IN C	X	○	△	X
VIDEO IN D	X	○	○	△

- : Video signals are converted and output through the video converter.
 △ : The same type of signal as that of the input signal is output. Video signals are not converted.
 X : Video signals are not output.

Notes on converting video signals

- You cannot down-convert input signals using the receiver. Component video signals cannot be converted to S video signals and composite video signals. S video signals cannot be converted to composite video signals. HDMI video signals cannot be converted to component video signals, S video signals, and video signals.
- When video or S video signals from a VCR, etc., are converted on this receiver and then output to your TV, depending on the status of the video signal output, the image on the TV screen may appear distorted horizontally or no image may be output.
- The converted video signals are output only from the MONITOR OUT jacks. They are not output from VIDEO OUT jacks or S VIDEO OUT jacks.
- When you play a VCR with an image improvement circuit, such as TBC, the images may be distorted or may not be output. In this case, set the image improvement circuit function to off.
- The video conversion function does not work with SECAM video signals.

Closed Caption display

When the receiver receives video output signals that are up-converted but the accompanying closed caption cannot be displayed, down-convert the video output signals to the original video signals, and connect the TV to the MONITOR OUT jack that outputs the original video signals.

To connect a recording component

When recording, connect the recording component to the VIDEO OUT jacks or S VIDEO OUT jacks of the receiver. Connect cords for input and output signals to the same type of jack, as VIDEO OUT jacks and S VIDEO OUT jacks do not have an up-conversion function.

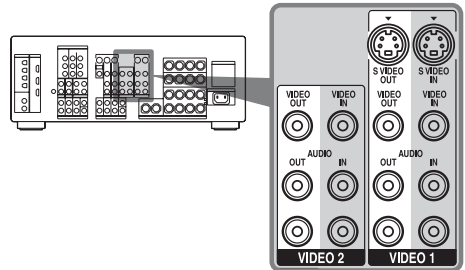

Note

Signals output from the MONITOR OUT jacks may not be recorded properly.

4: Connecting the antennas (aerials)

Connect the supplied AM loop antenna (aerial) and FM wire antenna (aerial).

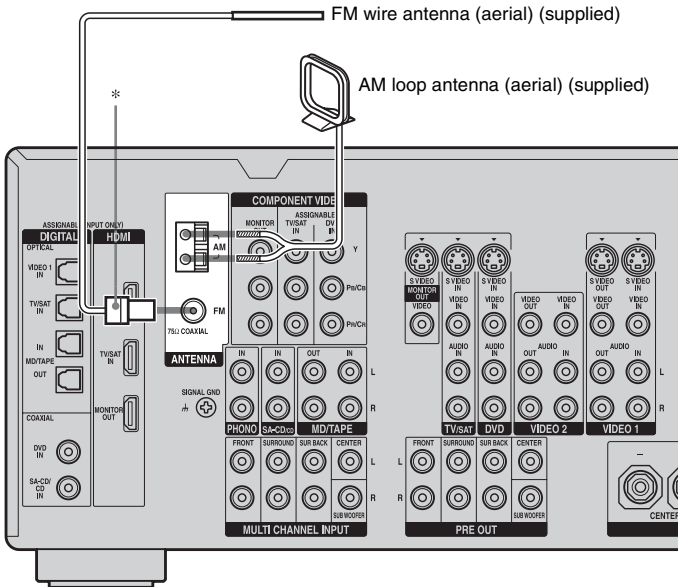

* The shape of the connector varies depending on the area.

Notes

- To prevent noise pickup, keep the AM loop antenna (aerial) away from the receiver and other components.
- Be sure to fully extend the FM wire antenna (aerial).
- After connecting the FM wire antenna (aerial), keep it as horizontal as possible.
- Do not use the ⏏ SIGNAL GND terminal for grounding the receiver.

5: Preparing the receiver and the remote

Connecting the AC power cord (mains lead)

Connect the supplied AC power cord (mains lead) to the AC IN terminal on the receiver, then connect the AC power cord (mains lead) to a wall outlet.

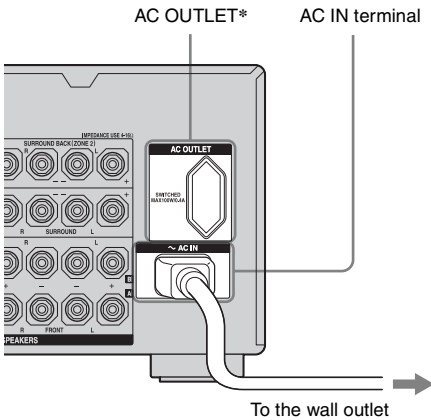

* The configuration, shape, number of AC outlets, and the information displayed on the label will vary according to the area.

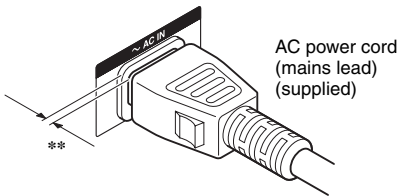

** A several space is left between the plug and the rear panel even when the power cord (mains lead) is inserted firmly. The cord is supposed be connected this way. This is not malfunction.

Notes

- The AC OUTLET(s) on the rear of the receiver is a switched outlet, which supplies power to the connected component only while the receiver is turned on.

- Make sure that the total power consumption of the component(s) connected to the receiver's AC OUTLET(s) does not exceed the wattage stated on the rear panel. Do not connect high-wattage electrical home appliances such as electric irons, fans, or TVs to this outlet. This may cause a malfunction.

Performing initial setup operations

Before using the receiver for the first time, initialize the receiver by performing the following procedure. This procedure can also be used to return settings you have made to their factory defaults.

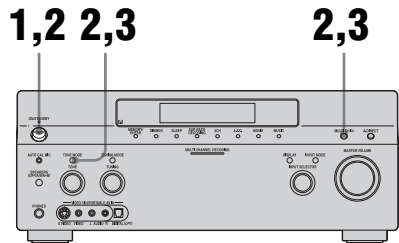

- 1 Press POWER to turn off the receiver.**
- 2 Press POWER while pressing TONE MODE and MULTI CH IN.**
- 3 Release TONE MODE and MULTI CH IN after a few seconds.**

After "MEMORY CLEARING..." appears on the display for a while, "MEMORY CLEARED!" appears.

The following items are reset to their factory settings.

- All settings in the Level Settings, EQ Settings, Sur Settings, Tuner Settings, Audio Settings, Video Settings, Speaker Settings, System Settings, and Auto Calibration menus.
- The sound field memorized for each input and preset station.
- All preset stations.
- All index names for inputs and preset.

Inserting batteries into the remote

Insert two R6 (size-AA) batteries in the RM-AAP015 remote commander. Observe the correct polarity when installing batteries.

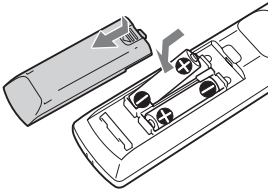

RM-AAP015

Notes

- Do not leave the remote in an extremely hot or humid place.
- Do not use a new battery with old ones.
- Do not mix manganese batteries and other kinds of batteries.
- Do not expose the remote sensor to direct sunlight or lighting apparatuses. Doing so may cause a malfunction.
- If you do not intend to use the remote for an extended period of time, remove the batteries to avoid possible damage from battery leakage and corrosion.
- When you replace the batteries, the programmed remote codes may be cleared. If this happens, program the remote codes again (page 94).

Tip

When the remote no longer operates the receiver, replace all the batteries with new ones.

About the command mode

The receiver and the remote use the same command mode.

If the command modes of the receiver and the remote are different, you cannot use the remote to operate the receiver.

If the command modes of both the receiver and the remote are those of the initial setting (AV SYSTEM 2), it is not necessary to reset them. You can switch the command mode (AV SYSTEM 1 or AV SYSTEM 2) of the receiver and the remote. If both the receiver and the other Sony component respond to the same remote command, switch the command mode of either the component or the receiver to another command mode so that the component does not respond to the same remote command as the receiver.

To switch the command mode of the receiver

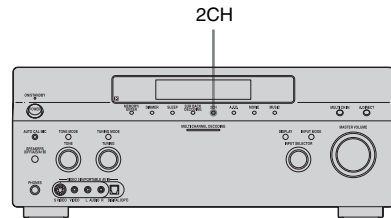

Turn on the receiver while pressing 2CH.

When the command mode is set to “AV2,” “COMMAND MODE [AV2]” appears on the display.

When the command mode is set to “AV1,” “COMMAND MODE [AV1]” appears on the display.

To switch the command mode of the RM-AAP015 remote

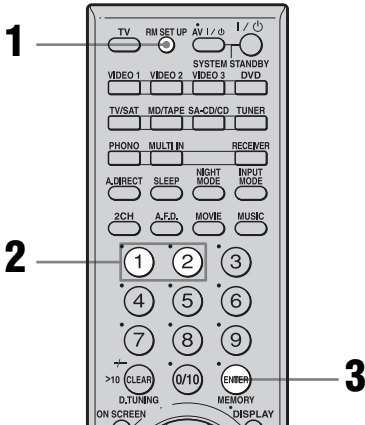

- 1 Press RM SET UP.**
The RM SET UP button flashes.
- 2 Press 1 or 2 while the RM SET UP button is flashing.**
When you press 1, the command mode is set to AV SYSTEM 1. When you press 2, the command mode is set to AV SYSTEM 2.
- 3 Press ENTER when the RM SET UP button lights up.**
The RM SET UP button flashes twice, then the command mode setting process is completed.

Tip

When you press RM SET UP, use a thin wire, such as a paper clip.

6: Setting the speakers

Setting the speaker impedance

Set the appropriate speaker impedance for the speakers you are using.

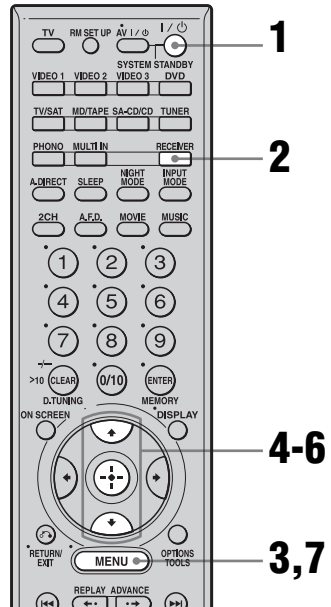

- 1 Turn on the receiver.**
- 2 Press RECEIVER.**
Receiver operation is enabled.
- 3 Press MENU.**
The list of setting menus appears.
- 4 Press \uparrow/\downarrow repeatedly to select "System Settings," then press \odot to enter.**
- 5 Press \uparrow/\downarrow repeatedly to select "SP. IMPEDANCE," then press \odot to enter the parameter.**

6 Press **↑/↓** repeatedly to select “4 ohm” or “8 ohm” depending on the speakers you are using, then press **(+)** to enter the selection.

7 Press **MENU** to exit the menu.

Notes

- If you are not sure of the impedances of the speakers, refer to the operating instructions supplied with your speakers. (This information is often on the back of the speaker.)
- When you connect all speakers with a nominal impedance of 8 ohms or higher, set “SP. IMPEDANCE” to “8 ohm.” When connecting other types of speakers, set it to “4 ohm.”
- When you connect front speakers to both the SPEAKER A and B terminals, connect the speakers with a nominal impedance of 8 ohms or higher.
 - When you connect speakers with impedance of 16 ohms or higher in both “A” and “B” configuration:
Set “SP. IMPEDANCE” to “8 ohm” in the System Settings menu.
 - For other types of speakers in other configurations:
Set “SP. IMPEDANCE” to “4 ohm” in the System Settings menu.

Note

You cannot switch the front speakers by pressing **SPEAKER (OFF/A/B/A+B)** when the headphones are connected to the receiver.

Set to	To select
A	The speakers connected to the FRONT SPEAKERS A terminals.
B	The speakers connected to the FRONT SPEAKERS B terminals.
A+B	The speakers connected to both the FRONT SPEAKERS A and B terminals (parallel connection).
OFF	No audio signals are output from any speaker terminals, or the PRE OUT terminal.

Selecting the front speaker

You can select the front speakers you want to drive.

SPEAKERS (OFF/A/B/A+B)

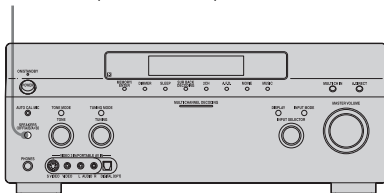

Press SPEAKERS (OFF/A/B/A+B) repeatedly to select the front speaker system you want to drive.

7: Calibrating the appropriate settings automatically (AUTO CALIBRATION)

The DCAC (Digital Cinema Auto Calibration) function allows you to perform automatic calibration, such as checking the connection between each speaker and the receiver, adjusting the speaker level, and measuring the distance of each speaker from your listening position automatically. Refer also to the “Quick Setup Guide” supplied with the receiver.

Before you perform auto calibration

Before you perform the auto calibration, set up and connect the speakers (page 16, 17).

- The AUTO CAL MIC jack is used for the supplied optimizer microphone only. Do not connect other microphones to this jack. Doing so may damage the receiver and the microphone.
- During the calibration, the sound that comes out of the speakers is very loud. Pay attention to the presence of children or to the effect on your neighborhood.
- Perform the auto calibration in a quiet environment to avoid the effect of noise and get a more accurate measurement.
- If there are any obstacles in the path between the optimizer microphone and the speakers, the calibration cannot be performed correctly. Remove any obstacles from the measurement area to avoid measurement error.
- When you use a bi-amplifier connection, set “SUR BACK SP” to “BI-AMP” in the Speaker Settings menu before you perform auto calibration (page 64).

Notes

- The auto calibration function does not work in the following cases.

- MULTI IN is selected.
 - The ANALOG DIRECT function is being used.
 - Headphones are connected.
- Cancel MUTING if it is set to on.

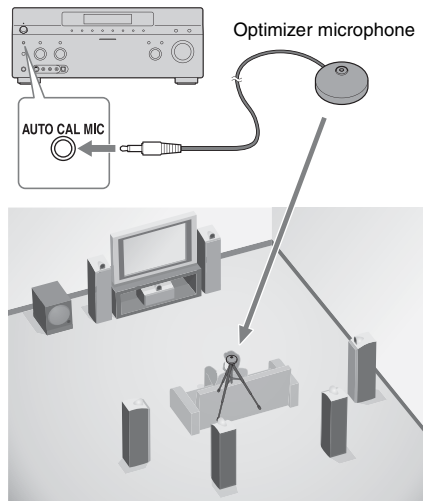

- 1 Connect the supplied optimizer microphone to the AUTO CAL MIC jack on the front panel.**
- 2 Set up the optimizer microphone.**

Place the optimizer microphone at your listening position. Use a stool or tripod so that the optimizer microphone remains at the same height as your ears.

On setting up the active sub woofer

- When a sub woofer is connected, turn on the sub woofer and turn up the volume beforehand. Turn the VOLUME knob to just before the mid-point.
- If you connect a sub woofer with a crossover frequency function, set the value to the maximum.
- If you connect a sub woofer with an auto standby function, set this function to off (deactivated).

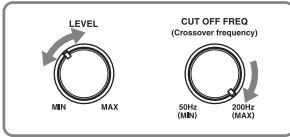

Note

Depending on the characteristics of the sub woofer you are using, the setup distance value may be further away from the actual position.

Using the receiver as a pre-amplifier

You can use the auto calibration function when you use the receiver as a pre-amplifier.

In this case, the distance value shown on the display may differ from the actual distance value. However, there will be no problems even if you continue to use the receiver with that value.

Performing auto calibration

The auto calibration function allows you to measure the following:

- Whether or not speakers are connected^{a)}
- Polarity of speakers
- Distance of each speaker from your listening position^{b)}
- Speaker size^{b)}
- Speaker level
- Frequency characteristics^{c)}

^{a)}This receiver corrects signals by analog downmix processing only for the center speaker and sub woofer when MULTI IN is selected. The correction is invalid for other speakers.

^{b)}The measurement result is not utilized when MULTI IN is selected.

^{c)}DTS 96/24 signals are always played back as 48 kHz when you correct signals.

- The measurement result is not utilized in the following cases.
 - MULTI IN is selected.

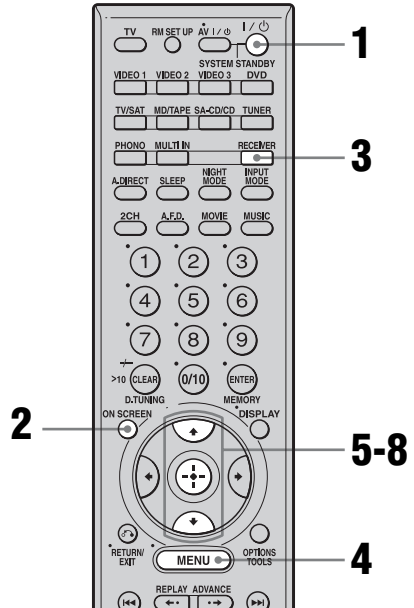

1 Turn on the receiver and the TV.

2 Press **ON SCREEN**.

Switch the input of the TV so that the setting menu is displayed on the TV screen connected to this receiver.

3 Press **RECEIVER**.

Receiver operation is enabled.

4 Press **MENU**.

The list of setting menus appears.

5 Press **↑/↓** repeatedly to select **“Auto Calibration,”** then press **⊕** to enter the menu.

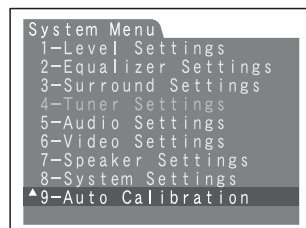

continued

6 Press \uparrow/\downarrow repeatedly to select “CAL TYPE,” then press \oplus to enter the parameter.

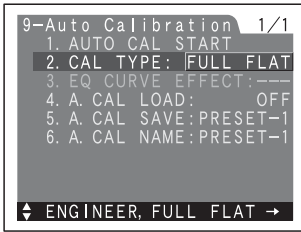

7 Press \uparrow/\downarrow repeatedly to select the parameter, then press \oplus to enter the selection.

Calibration type	Explanation
ENGINEER	Sets the frequency characteristics to a set that matches that of the Sony listening room standard.
FULL FLAT	Makes the measurement of frequency from each speaker flat.
FRONT REF	Adjusts the characteristics of all the speakers to match the characteristics of the front speaker.

8 Press \uparrow/\downarrow repeatedly to select “AUTO CAL START,” then press \oplus to start the measurement.

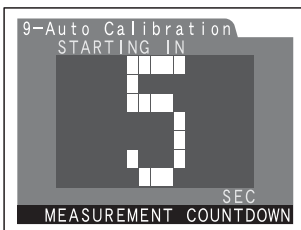

Measurement starts in five seconds. A countdown appears on the TV screen.

While the time is counting down, stand away from the measurement area to avoid measurement error.

9 Measurement starts.

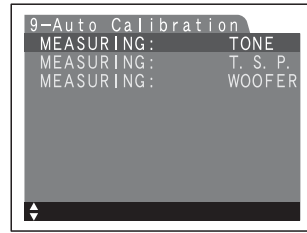

The measurement process will take approximately 30 seconds. Wait until the measurement process completes.

Note

You cannot measure the speaker height of the surround speakers and the surround back speakers. Set this value from “SP POSI.” settings in the Speaker Settings menu (page 66).

Tips

- Operations other than turning the receiver on or off and pressing ON SCREEN to turn the display on or off are deactivated during auto calibration.
- When special speakers, such as dipole speakers are used, the measurements may not be performed correctly or auto calibration cannot be performed.

To cancel auto calibration

Auto calibration is cancelled when you change the volume, switch functions, change the speaker setting of the receiver, or connect headphones.

Confirming/saving the measurement results

1 Confirm the measurement result.

When the measurement ends, a beep sounds and the measurement result appears on the display.

Measurement result	Display	Explanation
When the measurement process completes properly	COMPLETE	Proceed to step 2.
When the measurement process fails	ERROR CODE XX	See "When error codes appear" (page 43).

2 Press \uparrow/\downarrow repeatedly to select the item, then press \oplus .

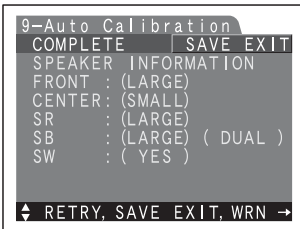

Item	Explanation
RETRY	Re-performs the auto calibration.
SAVE EXIT	Saves the measurement results and exits the setting process.
WRN CHECK	Displays a warning concerning the measurement results. See "When you select "WRN CHECK"" (page 44).
PHASE INFO	Displays the phase of each speaker (in phase/out of phase). See "When you select "PHASE INFO"" (page 44).

Item	Explanation
DIST.INFO	Displays the measurement result for speaker distance.
LEVEL INFO	Displays the measurement result for speaker level.
EXIT	Exits the setting process without saving the measurement results.

3 Press \uparrow/\downarrow repeatedly to select a preset number to be used, then press \oplus .

4 Press \oplus .

The measurement results are saved.

Tip

The size of a speaker (LARGE/SMALL) is determined by the low characteristics. The measurement results may vary, depending on the position of the optimizer microphone and speakers, and the shape of the room. It is recommended that you follow the measurement results. However, you can change those settings in the Speaker Settings menu (page 63). Save the measurement results first, then try to change the settings if you want.

When error codes appear

Try the remedies and re-perform the auto calibration.

Error code	Cause and remedies
CODE 31	SPEAKERS (OFF/A/B/A+B) is set to OFF. Set it to others and re-perform the auto calibration.
CODE 32	None of the speakers were detected. Make sure that the optimizer microphone is connected properly and re-perform the auto calibration. If the optimizer microphone is connected properly but the error code appears, the optimizer microphone cable may be damaged or improperly connected.
CODE 33 (F)	None of the front speakers are connected or only one front speaker is connected. The optimizer microphone is not connected.

continued

Error code	Cause and remedies
CODE 33 (SR)	<ul style="list-style-type: none"> • Either the left or right surround speakers is not connected. • Surround back speakers are connected even though surround speakers are not connected. Connect the surround speaker to the SURROUND terminals.
CODE 33 (SB)	The surround back speaker is connected only to the SURROUND BACK SPEAKERS R terminals. When you connect only one surround back speaker, connect it to the SURROUND BACK SPEAKERS L terminals.

•CODE 31

- 1 Press \oplus , then follow the instructions from step 1 of “Performing auto calibration.”

•CODE 32, 33

- 1 When you press \oplus , “RETRY?” appears.
- 2 Press \uparrow/\downarrow to select “YES,” then press \oplus .
- 3 Follow the instructions from step 2 of “Performing auto calibration.”
- 4 Press \uparrow/\downarrow repeatedly to select preset number to store preset settings then press \oplus .

When you select “WRN CHECK”

If a warning on the measurement result is present, detailed information is displayed.

Press \oplus to return to step 1 of “Confirming/saving the measurement results.”

Warning code	Explanation
WARNING 40	The auto calibration has completed. However, the noise level is high. You may be able to perform the auto calibration properly if you try it again, even though the measurement cannot be performed in all environments. Try to perform the auto calibration in a quiet environment.

Warning code	Explanation
WARNING 41	The sound input from the optimizer microphone is outside the acceptable range. It is louder than the loudest sound that can be measured. Try to perform the auto calibration when the environment is quiet enough to allow proper measurement.
WARNING 42	The volume of the receiver is out of the acceptable range. Try to perform the auto calibration when the environment is quiet enough to allow proper measurement.
WARNING 43	The distance and position of a sub woofer cannot be detected. Or the angle of the speaker position cannot be detected. This may be caused by noise. Try to perform the auto calibration in a quiet environment.

NO WARNING There is no warning information.

When you select “PHASE INFO”

You can check the phase of each speaker (in phase/out of phase).

Press \uparrow/\downarrow repeatedly to select a speaker, then press \oplus to return to step 1 in “Confirming/saving the measurement results.”

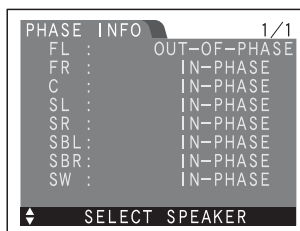

Display	Explanation
IN-PHASE	The speaker is in phase.
OUT-OF-PHASE	The speaker is out of phase. The “+” and “-” terminals of the speaker may be connected the other way around. However, depending on the speakers, “OUT-OF-PHASE” appears on the display even though the speakers are connected properly. This is because of the speakers’ specifications. In this case, you can continue to use the receiver.
-----	No speakers are connected.

Tip

Depending on the position of the sub woofer, the measurement results for polarity may vary. However, there will be no problems even if you continue to use the receiver with that value.

Auto Calibration menu parameters

■ AUTO CAL START? (Starts auto calibration)

- MEASUREMENT COUNTDOWN
A time countdown appears on the display from five seconds to one second.
- MEASURING TONE
Appears while TONE is being measured.
- MEASURING T.S.P.
Appears while TSP is being measured.
- MEASURING WOOFER
Appears while WOOFER is being measured.
- COMPLETE
Appears when the measurement process completes successfully. For details on each message, see “Confirming/saving the measurement results” (page 43).
- WARNING CODE ■■■■:4■
Appears if a warning on the measurement result is present. For details on each message, see “Confirming/saving the measurement results” (page 43).
- NO WARNING
There is no warning information.

- ERROR CODE ■■■■:3■
Appears when the measurement fails. For details on each message, see “Confirming/saving the measurement results” (page 43).
- RETRY?
Appears to ask you to re-measure or exit without re-measuring when the measurement fails.
- CANCEL
Appears when you cancel auto calibration during the measurement.

■ CAL TYPE* (Parameter type)

- ENGINEER
Sets the frequency to one that matches that of the Sony listening room standard.
- FULL FLAT
Makes the measurement of frequency from each speaker flat.
- FRONT REF
Adjusts the characteristics of all the speakers to match the characteristics of the front speaker.

■ EQ CURVE EFFECT* (Activates/deactivates the EQ curve measurement)

- OFF
Deactivates the EQ curve measurement.
- ON
Activates the EQ curve measurement. After the measurement is completed, this setting is set to ON automatically.

* The frequency response measurement result is not utilized in the following cases.
– MULTI IN is selected.

■ A.CAL LOAD? (Loads a preset measurement)

- PRESET-1
Loads the measurement value stored as “PRESET-1.”
- PRESET-2
Loads the measurement value stored as “PRESET-2.”
- PRESET-3
Loads the measurement value stored as “PRESET-3.”
- OFF
Select this when you do not want to load a preset value.

■ A.CAL SAVE? (Saves the measurement value)

- PRESET-1
Saves the measurement results as “PRESET-1.”
- PRESET-2
Saves the measurement results as “PRESET-2.”
- PRESET-3
Saves the measurement results as “PRESET-3.”

■ A.CAL NAME? (Naming inputs)

You can change the preset to name to something more recognizable.

Listening to a Super Audio CD/CD

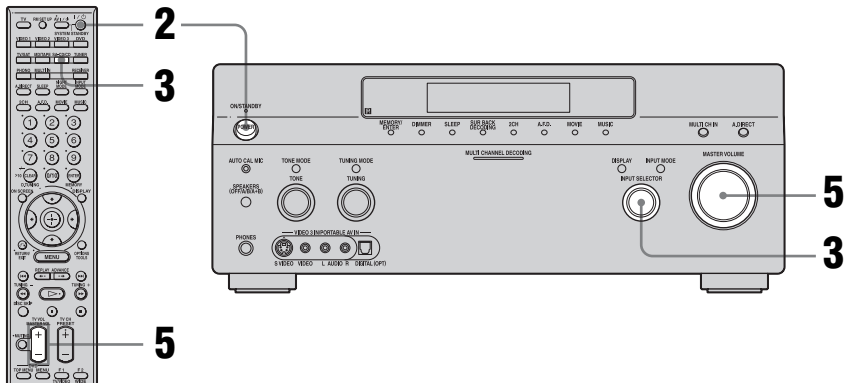

- The operation is described for a Sony Super Audio CD player.
- Refer to the operating instructions supplied with the Super Audio CD player or CD player.



You can select the sound field to suit the music. Refer to page 71 for details.

Recommended sound fields:

Classical: HALL

Jazz: JAZZ CLUB

Live concert: LIVE CONCERT, STADIUM

- 1 Turn on the Super Audio CD player or CD player, then place the disc in the tray.**
- 2 Turn on the receiver.**
- 3 Press SA-CD/CD.**

You can also use INPUT SELECTOR on the receiver to select “SA-CD/CD.”

An example of the display



- 4 Play back the disc.**
- 5 Adjust to a suitable volume.**
- 6 After you have finished listening to a Super Audio CD or CD, eject the disc and turn off the receiver and the Super Audio CD player or CD player.**

Watching a DVD

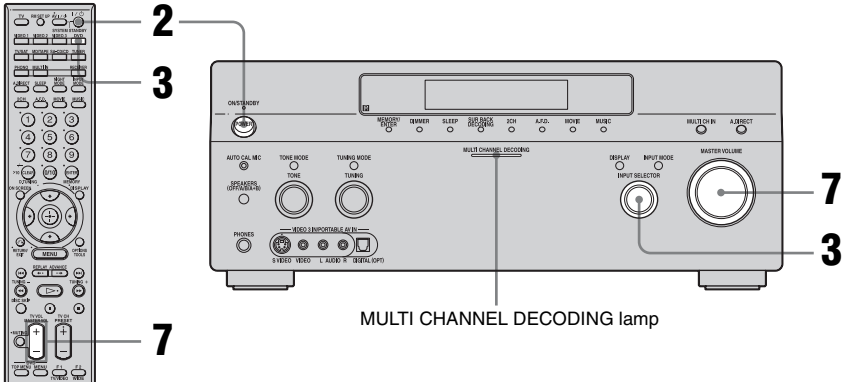

• Refer to the operating instructions supplied with the TV and DVD player.



Select the sound format of the disc to be played, if necessary.



You can select the sound field to suit the movie or the music. Refer to page 71 for details.

Recommended sound fields:
 Movie: CINEMA STUDIO EX
 Live image: LIVE CONCERT
 Sport: SPORTS



Check the following if you cannot listen to the multi-channel sound.

- Be sure the sound source corresponds to the multi-channel format (the MULTI CHANNEL DECODING lamp on the front panel lights up during playback).
- Be sure this receiver is connected to the DVD player via a digital connection.
- Be sure the digital audio output of the DVD player is set up properly.

- 1 Turn on the TV and DVD player.**
- 2 Turn on the receiver.**
- 3 Press DVD.**

You can also use INPUT SELECTOR on this receiver to select “DVD.”

An example of the display

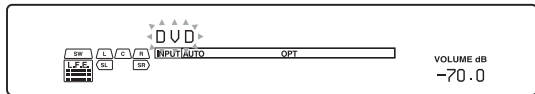

- 4 Switch the input of the TV so that an image of the DVD is displayed.**
- 5 Set up the DVD player.**
Refer to “Quick Setup Guide” supplied with the receiver.
- 6 Play back the disc.**
- 7 Adjust to a suitable volume.**
- 8 After you have finished watching a DVD, eject the disc and turn off the receiver, the TV, and the DVD player.**

Enjoying video games

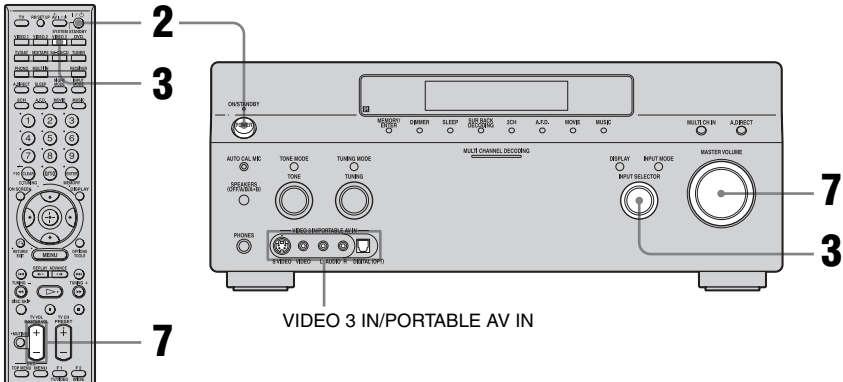

- Refer to the operating instructions supplied with the TV and video game.

- 1 Turn on the TV and video game.**
- 2 Turn on the receiver.**
- 3 Press VIDEO 3*.**

You can also use INPUT SELECTOR on this receiver to select “VIDEO 3*.”

* When you connect a TV game to the VIDEO 3 IN/PORTABLE AV IN jack on the front panel.

An example of the display

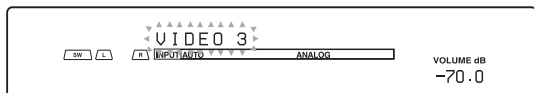

- 4 Switch the input of the TV so that an image of the video game is displayed.**
- 5 Set up the video game.**
- 6 Place the disc in the tray and play it back on the video game.**
- 7 Adjust to a suitable volume.**
- 8 After you have finished playing a game, eject the disc and turn off the receiver, the TV, and the video game.**

Watching video

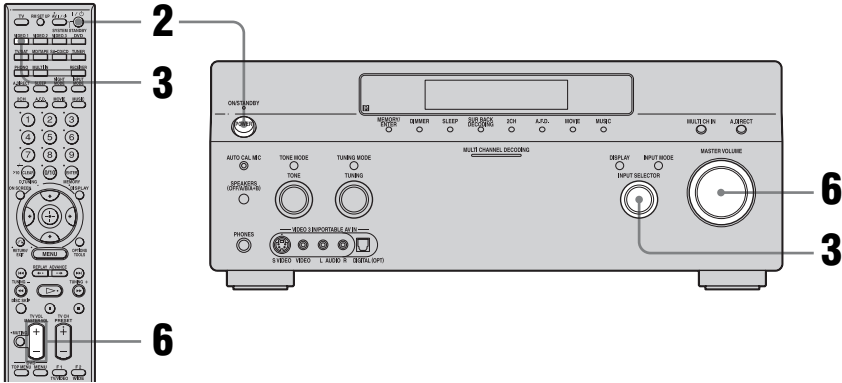

• Refer to the operating instructions supplied with the TV and VCR.

- 1** Turn on the VCR.
- 2** Turn on the receiver.
- 3** Press VIDEO 1*.

You can also use INPUT SELECTOR on this receiver to select "VIDEO 1*."

* When you connect VCR to the VIDEO 1 jack.

An example of the display

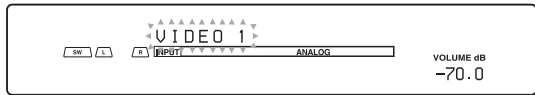

- 4** Switch the input of the TV so that an image of the VCR is displayed.
- 5** Play back the tape on the VCR.
- 6** Adjust to a suitable volume.
- 7** After you have finished watching a video, eject the tape and turn off the receiver, the TV, and the VCR.

Amplifier Operations

Navigating through menus

By using the amplifier menus, you can make various adjustments to customize the receiver.

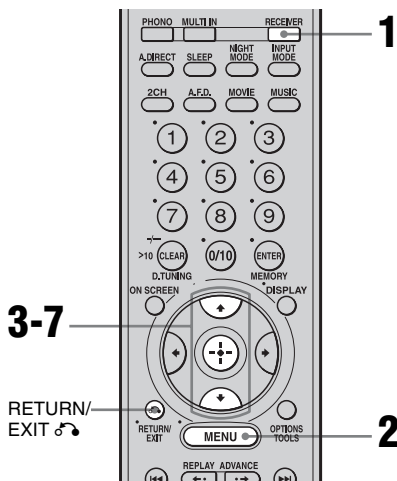

To return to the previous display







Press RETURN/EXIT .

To exit the menu

Press MENU.

Note

Some parameters and settings may appear dimmed on the display. This means that they are either unavailable or fixed and unchangeable.

- 1 Press RECEIVER.**
Receiver operation is enabled.
- 2 Press MENU.**
The list of setting menus appears.
- 3 Press / repeatedly to select the menu you want.**
- 4 Press  to enter the menu.**
- 5 Press / repeatedly to select the parameter you want to adjust.**
- 6 Press  to enter the parameter.**
- 7 Repeat steps 3 to 6 when you want to make other settings.**

Overview of the menus

The following options are available in each menu. For details on navigating through menus, see page 52.

Menu	Item	Parameter	Initial setting	Refer page
1-Level Settings	TEST TONE [■■■■■■■■■■]	OFF, AUTO, FIX	OFF	page 56 - 57
	PHASE NOISE [■■■■■■■■■■]	OFF, L/C, C/R, R/SL, R/SR, SR/SL, SR/SBR, SBR/SBL, SBL/SL, SL/L, L/SR	OFF	
	PHASE AUDIO [■■■■■■■■■■]	OFF, L/C, C/R, R/SL, R/SR, SR/SL, SR/SBR, SBR/SBL, SBL/SL, SL/L, L/SR	OFF	
	FRONT BAL. [■■■■.■ dB]	R+20.0dB to L+20.0dB (0.5dB step)	0dB	
	CENTER [■■■■.■ dB]	-20.0dB to +10.0dB (0.5dB step)	0dB	
	SURROUND L [■■■■.■ dB]	-20.0dB to +10.0dB (0.5dB step)	0dB	
	SURROUND R [■■■■.■ dB]	-20.0dB to +10.0dB (0.5dB step)	0dB	
	SUR BACK [■■■■.■ dB]	-20.0dB to +10.0dB (0.5dB step)	0dB	
	SUR BACK L [■■■■.■ dB]	-20.0dB to +10.0dB (0.5dB step)	0dB	
	SUR BACK R [■■■■.■ dB]	-20.0dB to +10.0dB (0.5dB step)	0dB	
	SUB WOOFER [■■■■.■ dB]	-20.0dB to +10.0dB (0.5dB step)	0dB	
	MULTI CH SW [■■■■.■ dB]	0dB, +10.0dB	0dB	
	D. RANGE COMP. [■■■■]	OFF, STD, MAX	OFF	
2-EQ Settings	EQ PRESET [■■■■]	1, 2, 3, 4, 5, OFF	1	page 57 - 58
	FRONT BASS [■■■■ dB]	-10.0dB to +10.0dB (1dB step)	0dB	
	FRONT TREBLE [■■■■ dB]	-10.0dB to +10.0dB (1dB step)	0dB	
	CENTER BASS [■■■■ dB]	-10.0dB to +10.0dB (1dB step)	0dB	
	CENTER TREBLE [■■■■ dB]	-10.0dB to +10.0dB (1dB step)	0dB	
	SUR/SB BASS [■■■■ dB]	-10.0dB to +10.0dB (1dB step)	0dB	
	SUR/SB TREBLE [■■■■ dB]	-10.0dB to +10.0dB (1dB step)	0dB	
	PRESET ■ CLEAR [■■■■]	YES, NO	NO	

Menu	Item	Parameter	Initial setting	Refer page
3-Sur Settings	SOUND FIELD SELECT ?		A.FD AUTO	page 69
	SB DECODING [■ ■ ■ ■ ■]	OFF, AUTO, ON	AUTO	page 59 - 60
	SB DEC MODE [■ ■ ■ ■ ■ ■ ■ ■ ■]	DDEX, PLIIx MV, PLIIx MS	PLIIx MV	
	EFFECT LEVEL [■ ■ ■ ■ %]	20% to 120% (5% step)	100%	
	CENTER WIDTH [■]	8 step	3	
	DIMENSION [■ ■ ■ ■ ■ ■ ■ ■ ■]	FRONT +3 to SUR +3	0	
	PANORAMA MODE [■ ■ ■ ■ ■]	OFF, ON	OFF	
	SCREEN DEPTH [■ ■ ■ ■ ■]	ON, OFF	ON	
	VIR. SPEAKERS [■ ■ ■ ■ ■]	ON, OFF	ON	
4-Tuner Settings	FM MODE [■ ■ ■ ■ ■ ■ ■ ■ ■]	MONO, STEREO	STEREO	page 61
	NAME IN? [■ ■ ■ ■ ■]			page 84
5-Audio Settings	DEC. PRIORITY [■ ■ ■ ■ ■ ■]	PCM, AUTO	AUTO	page 62
	DUAL MONO [■ ■ ■ ■ ■ ■ ■ ■ ■ ■ ■]	MAIN/SUB, MAIN, SUB, MAIN+SUB	MAIN	
	A/V SYNC [■ ■ ■ ■ ms]	0ms to 150ms/300ms (10 ms step)	0ms	
	DIGITAL ASSIGN ?			page 86
	NAME IN ? [■ ■ ■ ■ ■]			page 84
6-Video Settings	COMPONENT V. ASSIGN ?			page 88
	HDMI ASSIGN ?			page 87
	COLOR SYSTEM [■ ■ ■ ■ ■ ■]	NTSC, PAL	PAL	page 63
	NAME IN ? [■ ■ ■ ■ ■ ■ ■ ■ ■ ■ ■]			page 84

Menu	Item	Parameter	Initial setting	Refer page
7-Speaker Settings	SUB WOOFER [■■■■]	NO, YES	YES	page 63 - 67
	FRONT SP [■■■■■■■]	SMALL, LARGE	LARGE	
	CENTER SP [■■■■■■■]	MIX, NO, SMALL, LARGE	LARGE	
	SURROUND SP [■■■■■■■]	NO, SMALL, LARGE	LARGE	
	SUR BACK SP [■■■■■■■■]	BI-AMP, NO, SINGLE, DUAL	DUAL	
	FRONT L ■.■meter*	1.0m to 7.0m (0.1m** step)	3.0 meter	
	FRONT R ■.■meter*	1.0m to 7.0m (0.1m** step)	3.0 meter	
	CENTER ■.■meter*	1.0m to 7.0m (0.1m** step)	3.0 meter	
	SURROUND L ■.■meter*	1.0m to 7.0m (0.1m** step)	3.0 meter	
	SURROUND R ■.■meter*	1.0m to 7.0m (0.1m** step)	3.0 meter	
	SUR BACK L ■.■meter*	1.0m to 7.0m (0.1m** step)	3.0 meter	
	SUR BACK R ■.■meter*	1.0m to 7.0m (0.1m** step)	3.0 meter	
	SUB WOOFER ■.■meter*	1.0m to 7.0m (0.1m** step)	3.0 meter	
	DISTANCE UNIT [■■■■■■]	meter, feet	meter	
	8-System Settings	SP POSI [■■■■■■■■■■■■]	SIDE/LOW, SIDE/HIGH, BEHD/LOW, BEHD/HIGH	SIDE/LOW
SP CROSSOVER [■■■■Hz]		40Hz to 200Hz (10Hz step)	120Hz	
DIMMER [■■■■% DOWN]		0%, 60%, 100%	0%	page 38
9-Auto Calibration	SP. IMPEDANCE [■■■■■■]	4 ohm, 8 ohm	8 ohm	page 45 - 46
	AUTO CAL START?			
	CAL TYPE [■■■■■■■■■■■■]	ENGINEER/FULL FLAT/FRONT REF	FULL FLAT	
	EQ CURVE EFFECT [■■■■]	OFF, ON	OFF	
	A.CAL LOAD? [PRESET- ■]	OFF, PRESET1, PRESET2, PRESET3	OFF	
	A.CAL SAVE? [PRESET- ■]	PRESET1, PRESET2, PRESET3	PRESET1	
A.CAL NAME? [■■■■■■■■■■■■]			page 84	

* After the measurements are completed using auto calibration, the measurement value is displayed as ■m■■cm.

** After the measurements are completed using auto calibration, you can adjust them in 1cm increments.

Adjusting the level (Level Settings menu)

You can use the Level Settings menu to adjust the balance and level of each speaker. These settings are applied to all sound fields. Select “Level Settings” in the setting menus. For details on adjusting the parameters, see “Navigating through menus” (page 52) and “Overview of the menus” (page 53).

Level Settings menu parameters

■ TEST TONE (Test Tone)

Lets you output the test tone sequentially from each speaker.

- OFF
- AUTO
The test tone is output from each speaker.
- FIX
You can select which speakers will output the test tone.

■ PHASE NOISE (Phase noise)

- ON
Lets you output the test tone sequentially from adjacent speakers.
- OFF

■ PHASE AUDIO (Phase audio)

- ON
Lets you output front 2 channel source sound (instead of the test tone) sequentially from adjacent speakers.
- OFF

■ FRONT BAL. (Front speaker balance)

Lets you adjust the balance between front left and right speakers.

■ CENTER (Center speaker level)

■ SURROUND L (Surround speaker (L) level)

■ SURROUND R (Surround speaker (R) level)

■ SUR BACK (Surround back speaker level)

Only when the surround back speakers are set to “SINGLE” in the System Settings menu (page 64).

■ SUR BACK L (Surround back (L) level)

Only when the surround back speakers are set to “DUAL” in the SYSTEM Settings menu (page 64).

■ SUR BACK R (Surround back (R) level)

Only when the surround back speakers are set to “DUAL” in the System Settings menu (page 64).

■ SUB WOOFER (Sub woofer level)

Note

When one of the sound fields for music is selected, no sound is output from the sub woofer if all the speakers are set to “LARGE” on the Speaker Settings menu. However, the sound will be output from the sub woofer if the digital input signal contains L.F.E. signals, the front or surround speakers are set to “SMALL,” the sound field for movie is selected, or “PORTABLE AUDIO” is selected.

■ MULTI CH SW (Multi-channel sub woofer level)

Lets you increase the level of the MULTI CHANNEL INPUT sub woofer channel signals by +10 dB. This adjustment may be necessary when connecting a DVD player to the MULTI CHANNEL INPUT jacks. The sub woofer level from DVD players is 10 dB lower than that of Super Audio CD players.

■ D.RANGE COMP. (Dynamic range compressor)

Lets you compress the dynamic range of the sound track. This may be useful when you want to watch movies at low volumes late at night. Dynamic range compression is possible with Dolby Digital sources only.

- OFF
The dynamic range is not compressed.
- STD
The dynamic range is compressed as intended by the recording engineer.
- MAX
The dynamic range is compressed dramatically.

Tip

Dynamic range compressor lets you compress the dynamic range of the soundtrack based on the dynamic range information included in the Dolby Digital signal.

“STD” is the standard setting, but it only enacts light compression. Therefore, we recommend using the “MAX” setting. This greatly compresses the dynamic range and lets you view movies late at night at low volumes. Unlike analog limiters, the levels are predetermined and provide a very natural compression.

Adjusting the equalizer (EQ Settings menu)

You can use the EQ Settings menu to adjust the tonal quality (bass/treble level) of the front speakers and to store up to 5 different equalizer settings in the equalizer preset (EQ PRESET [1]-[5]) and apply them. These settings are applied to all sound fields and for each speaker. Select “EQ Settings menu” in the system menus. For details on adjusting the parameters, see “Navigating through menus” (page 52) and “Overview of the menus” (page 53).

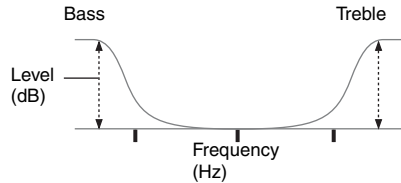

Notes

- This function does not work in following cases.
 - MULTI IN is selected.
- If you set up the sound field during DTS 96/24 signal reception, it will play back only at 48 kHz.

EQ Settings menu parameters

■ EQ PRESET (Preset equalizer selection)

Lets you select the equalizer preset ([1]-[5]). When you select “OFF,” the equalizer is cancelled.

■ FRONT BASS* (Front speaker bass level)

■ FRONT TREBLE* (Front speaker treble level)

* You can adjust the front speaker bass and treble level with TONE MODE and TONE on the receiver.

continued

■ **CENTER BASS**
(Center speaker bass level)

■ **CENTER TREBLE**
(Center speaker treble level)

■ **SUR/SB BASS**
(Surround/surround back speaker bass level)

■ **SUR/SB TREBLE**
(Surround/surround back speaker treble level)

■ **PRESET ■ CLEAR**
(Equalizer preset clear)

You can reset the adjusted equalizer settings to the initial setting. For details, see “Clearing stored equalizer settings.”

To apply the stored equalizer

- 1 Perform steps 1 to 3 in “Navigating through menus” (page 52). Select “EQ Settings” in step 3.
- 2 Press \uparrow/\downarrow repeatedly to select the equalizer (EQ PRESET [1]-[5]) you want to apply, then press \oplus to enter.

To turn off the equalizer

Select “OFF” in the “EQ PRESET” setting.

Clearing stored equalizer settings

- 1 Perform steps 1 to 3 in “Navigating through menus” (page 52). Select “EQ Settings” in step 3.
- 2 Press \uparrow/\downarrow repeatedly to select the equalizer (EQ PRESET [1]-[5]) you want to clear, then press \oplus to enter.
- 3 Press \uparrow/\downarrow repeatedly to select “PRESET ■ CLEAR.”
“■” is the number of the selected equalizer preset.

- 4 Press \uparrow/\downarrow repeatedly to select “YES,” then press \oplus .
“Are you sure?” appears on the display.
- 5 Press \uparrow/\downarrow repeatedly to select “YES,” then press \oplus .
“PRESET ■ CLEARED!” appears on the display and the adjusted contents of the selected equalizer preset are cleared.

Settings for the surround sound (Sur Settings menu)

You can use the Sur Settings menu to select the sound field you want for your listening pleasure. Select “Sur Settings” in the setting menus. For details on adjusting the parameters, see “Navigating through menus” (page 52) and “Overview of the menus” (page 53).

Sur Settings menu parameters

■ SOUND FIELD SELECT? (Sound field type selection)

Lets you select the sound field you want. For details, see “Enjoying Surround Sound” (page 69).

■ SB DECODING (Surround back decoding)

Lets you select the surround back decoding function. For details, see “Using the surround back decoding mode (SB DECODING)” (page 60).

■ SB DEC MODE (Surround back decoding mode)

Lets you select the surround back decoding mode. For details, see “Using the surround back decoding mode (SB DECODING)” (page 60).

■ EFFECT LEVEL (Effect level)

Higher settings apply more surround effect.

■ CENTER WIDTH (Center width control)

Lets you perform further adjustments for Dolby Pro Logic II and IIx Music mode decoding. You can set this parameter only when A.F.D. mode is set to “PRO LOGIC II MUSIC” or “PRO LOGIC IIx MUSIC” (page 70).

You can adjust the distribution of the center channel signal, generated through the Dolby Pro Logic II decoding, to the left/right speakers.

■ DIMENSION (Dimension control)

Lets you perform further adjustments for Dolby Pro Logic II and IIx Music mode decoding. You can set this parameter only when A.F.D. mode is set to “PRO LOGIC II MUSIC” or “PRO LOGIC IIx MUSIC” (page 70).

You can adjust the difference between the front channels and the surround channels.

■ PANORAMA MODE (Panorama mode)

Lets you perform further adjustments for Dolby Pro Logic II and IIx Music mode decoding. You can set this parameter only when A.F.D. mode is set to “PRO LOGIC II MUSIC” or “PRO LOGIC IIx MUSIC” (page 70).

- ON
Lets you enjoy surround sound by spreading the sound field of the front speakers to the left and right of the listening position (panorama mode).
- OFF
Panorama mode is not activated.

■ SCREEN DEPTH (Screen depth)

This parameter is provided especially for Cinema Studio EX modes (page 72).

Lets you create the sensation that the sound of the front speakers comes from inside the screen in your listening room, just like in theaters.

- ON
Lets you create a sound environment where you will feel the sound comes directly out of a large screen in front of you.
- OFF
This function is not activated.

■ VIR.SPEAKERS (Virtual speakers)

This parameter is provided especially for Cinema Studio EX modes (page 72).

- ON
Virtual speakers are created.
- OFF
Virtual speakers are not created.

Using the surround back decoding mode (SB DECODING)

By decoding the surround back signal of DVD software, etc. recorded in Dolby Digital Surround EX, DTS-ES Matrix, DTS-ES Discrete 6.1, etc., format, you can enjoy the surround sound intended by the filmmakers.

■ SB DECODING

- AUTO
When the input stream contains the 6.1 channel decode flag^{a)}, the appropriate decoding is performed on the surround back signal.

Input stream	Output	Surround back channels decoding
Dolby Digital 5.1	5.1 ^{e)}	—
Dolby Digital Surround EX ^{b)}	6.1 ^{e)}	Matrix decoder that conforms to Dolby Digital EX (page 60)
DTS 5.1	5.1 ^{e)}	—
DTS-ES Matrix 6.1 ^{c)}	6.1 ^{e)}	DTS Matrix decoding
DTS-ES Discrete 6.1 ^{d)}	6.1 ^{e)}	DTS Discrete decoding

^{a)} A 6.1 channel decode flag is information recorded in software, such as DVDs.

^{b)} A Dolby Digital DVD that includes a Surround EX flag. The Dolby Corporation web page can help you distinguish Surround EX films.

^{c)} Software encoded with a flag to denote it has both DTS-ES Matrix and 5.1 channel signals.

^{d)} Software encoded with both 5.1 channel signals and an extension stream designed for returning those signals to 6.1 discrete channels. Discrete 6.1 channel signals are DVD specific signals not used in movie theaters.

^{e)} When two surround back speakers are connected, the output channel will be 7.1 channel signals.

- ON
The SB DEC MODE setting is applied to 5.1 channel and 6.1 channel decoding in the input stream.
- OFF
Surround back decoding is not performed.

Notes

- This function does not work in the following cases.
 - MULTI IN is selected.
 - DTS 96/24 signals are being received.
 - The sound field for music is selected.
- There may be no sound from the surround back speaker in Dolby Digital EX mode. Some discs have no Dolby Digital Surround EX flag even though the packages have Dolby Digital EX logos. In this case, select “ON.”
- When “PLIIX” is selected, SB DECODING is set to the PLIIX mode.

■ SB DEC MODE

You can select surround back decoding mode only when “SB DECODING” is set to “ON” or “AUTO” and the input stream contains the Dolby Digital Surround EX flag.

SB DEC MODE	Speaker setting	Surround back decoding
[DDEX]	7.1 channels	Matrix decoder conforms to Dolby Digital EX
	6.1 channels	Matrix decoder conforms to Dolby Digital EX
[PLIIX MV]	7.1 channels	Movie decoder conforms to Dolby Pro Logic IIX
	6.1 channels	Matrix decoder conforms to Dolby Digital EX
[PLIIX MS]	7.1 channels	Music decoder conforms to Dolby Pro Logic IIX
	6.1 channels	Music decoder conforms to Dolby Pro Logic IIX

Notes

- Matrix decoding conforming to Dolby Digital EX is applied regardless of the surround back decoder mode setup when a sound field for a movie is selected.
- Matrix decoding conforming to Dolby Digital EX is applied if the speaker setting is 6.1 channel system and movie decoding conforming to Pro Logic IIx is applied if the speaker setting is 7.1 channel system, when you select Dolby PLIIx MS under the following conditions:
 - a Dolby Digital Surround EX signal is input
 - “SB DECODING” is set to “AUTO”

Settings for the tuner (Tuner Settings menu)

You can use the Tuner Settings menu to set the FM station receiving mode and to name preset stations.

Select “Tuner Settings” in the Setting menus. For details on adjusting the parameters, see “Navigating through menus” (page 52) and “Overview of the menus” (page 53).

Tuner Settings menu parameters

■ FM MODE (FM station receiving mode)

- STEREO

This receiver will decode the signal as stereo signal when the radio station is broadcast in stereo.

- MONO

This receiver will decode the signal as mono signal regardless of the broadcast signal.

■ NAME IN? (Naming preset stations)

Lets you set the name of preset stations. For details, see “Naming inputs” (page 84).

Settings for the audio

(Audio Settings menu)

You can use the Audio Settings menu to make settings for the audio to suit your preference. Select “Audio Settings” in the setting menus. For details on adjusting the parameters, see “Navigating through menus” (page 52) and “Overview of the menus” (page 53).

Audio Settings menu parameters

■ DEC. PRIORITY (Digital audio input decoding priority)

Lets you specify the input mode for the digital signal input to the DIGITAL IN and HDMI IN jacks.

- AUTO
Automatically switches the input mode between DTS, Dolby Digital, or PCM.
- PCM
PCM signals are given priority (to prevent interruption when playback starts).
However, when other signals are input, there may be no sound depending on the format.
In this case, set to “AUTO.”

Note

When set to “AUTO” and the sound from the digital audio jacks (for a CD, etc.) is interrupted when playback starts, set to “PCM.”

■ DUAL MONO (Digital broadcast language selection)

Lets you select the language you want to listen to during a digital broadcast. This feature only functions for Dolby Digital sources.

- MAIN/SUB
Sound of the main language will be output through the front left speaker, and sound of the sub language will be output through the front right speaker simultaneously.
- MAIN
Sound of the main language will be output.

- SUB
Sound of the sub language will be output.
- MAIN+SUB
Mixed sound of both the main and sub languages will be output.

■ A/V SYNC (Synchronizes audio and video output)

Lets you delay the output of audio to minimize the time gap between audio output and visual display.

Notes

- This function is useful when you use a large LCD or plasma monitor or a projector.
- This function does not work in the following cases.
 - MULTI IN is selected.
 - ANALOG DIRECT function is being used.
- You can adjust the delay to up to 300ms
 - the sampling frequency is less than 48 kHz
 - 2 channel analog signals
- You can adjust the delay to up to 150ms
 - the sampling frequency is 88.2 kHz or 96 kHzAlthough the parameter appears up to 300ms at this time, you cannot adjust the delay by more than 150ms.

■ DIGITAL ASSIGN? (Digital audio input assignment)

Lets you assign the digital audio input to other input source. For details, see “Listening to digital sound from other inputs (DIGITAL ASSIGN)” (page 86).

■ NAME IN? (Naming inputs)

Lets you set the name of inputs selected. For details, see “Naming inputs” (page 84).

Settings for the video (Video Settings menu)

You can use the Video Settings menu to reassign the component video input to another input and to name inputs. Select “Video Settings” in the setting menus. For details on adjusting the parameters, see “Navigating through menus” (page 52) and “Overview of the menus” (page 53).

Video Settings menu parameters

■ COMPONENT V. ASSIGN? (Component Video Assign)

Lets you reassign the component video input to another visual input. For details, see “Watching component images from other inputs (COMPONENT VIDEO ASSIGN)” (page 88).

■ HDMI ASSIGN? (HDMI Video Assign)

Lets you reassign the HDMI video input to another visual input. For details, see “Watching HDMI images from other inputs (HDMI ASSIGN)” (page 87).

■ COLOR SYSTEM (Color TV type selection)

- NTSC
- PAL

■ NAME IN? (Naming inputs)

Lets you set the name of inputs selected. For details, see “Naming inputs” (page 84).

Settings for the speakers (Speaker Settings menu)

You can use the Speaker Settings menu to set the size and distance of the speakers connected to this system. Select “Speaker Settings” in the setting menus. For details on adjusting the parameters, see “Navigating through menus” (page 52) and “Overview of the menus” (page 53).

Speaker Settings menu parameters

■ SUB WOOFER (Sub woofer)

- YES
If you have connected a sub woofer, select “YES.”
- NO
If you have not connected a sub woofer, select “NO.” This activates the bass redirection circuitry and outputs the L.F.E. (Low Frequency Effect) signals from other speakers.

Tip

In order to take full advantage of the Dolby Digital bass redirection circuitry, we recommend setting the sub woofer’s cut off frequency as high as possible.

■ FRONT SP (Front speakers)

- LARGE
If you connect large speakers that will effectively reproduce bass frequencies, select “LARGE.” Normally, select “LARGE.” When the sub woofer is set to “NO,” front speakers are automatically set to “LARGE.”
- SMALL
If the sound is distorted, or you feel a lack of surround effects when using multi-channel surround sound, select “SMALL” to activate the bass redirection circuitry and output the front channel bass frequencies from the sub woofer. When the front speakers are set to “SMALL,” the center, surround, and

continued

surround back speakers are also automatically set to “SMALL” (unless previously set to “NO”).

■ CENTER SP (Center speaker)

- LARGE

If you connect a large speaker that will effectively reproduce bass frequencies, select “LARGE.” Normally, select “LARGE.” However, if the front speakers are set to “SMALL,” you cannot set the center speaker to “LARGE.”

- SMALL

If the sound is distorted, or you feel a lack of surround effects when using multi-channel surround sound, select “SMALL” to activate the bass redirection circuitry and output the center channel bass frequencies from the front speakers (if set to “LARGE”) or sub woofer.

- NO

If you have not connected a center speaker, select “NO,” the sound of the center channel will be output from the front speakers.

- MIX

We recommend you set “CENTER SP” to “MIX” to enjoy digital audio with high quality sound when you do not have a center speaker connected. Analog downmix works when you set “CENTER SP” to “MIX.” This setting is also effective to input signals from MULTI CHANNEL INPUT jacks.

■ SURROUND SP (Surround speaker)

The surround back speakers will be set to the same setting.

- LARGE

If you connect large speakers that will effectively reproduce bass frequencies, select “LARGE.” Normally, select “LARGE.” However, if the front speakers are set to “SMALL,” you cannot set the surround speakers to “LARGE.”

- SMALL

If the sound is distorted, or you feel a lack of surround effects when using multi-channel surround sound, select “SMALL” to activate

the bass redirection circuitry and output the surround channel bass frequencies from the sub woofer or other “LARGE” speakers.

- NO

If you have not connected surround speakers, select “NO.”

■ SUR BACK SP (Surround back speakers)

When the surround speakers are set to “NO,” the surround back speakers are also automatically set to “NO” and the setting cannot be changed.

- DUAL

If you connect two surround back speakers, select “DUAL.” The sound will be output to a maximum of 7.1 channels.

- SINGLE

If you connect only one surround back speaker, select “SINGLE.” The sound will be output to a maximum of 6.1 channels.

- NO

If you have not connected surround back speakers, select “NO.”

- BI-AMP

If you connect front speakers in a bi-amplifier configuration, select “BI-AMP.”

Note

When “SUR BACK SP” is set to “BI-AMP,” even if “CENTER SP” is set to “MIX,” the setting will be ignored, so set “CENTER SP” to “NO.”

Tip

The “LARGE” and “SMALL” settings for each speaker determine whether the internal sound processor will cut the bass signal from that channel. When the bass is cut from a channel, the bass redirection circuitry sends the corresponding bass frequencies to the sub woofer or other “LARGE” speakers.

However, since bass sound has a certain amount of directionality, it is best not to cut them, if possible. Therefore, even when using small speakers, you can set them to “LARGE” if you want to output the bass frequencies from that speaker. On the other hand, if you are using a large speaker, but prefer not to have bass frequencies output from that speaker, set it to “SMALL.”

If the overall sound level is lower than you prefer, set all speakers to “LARGE.” If there is not enough

bass, you can use the equalizer to boost the bass levels. For details, see “Adjusting the equalizer (EQ Settings menu)” (page 57).

■ FRONT L (Front left speaker distance)

■ FRONT R (Front right speaker distance)

Lets you set the distance from your listening position to the front speakers (A).

If both front speakers are not placed an equal distance from your listening position, set the distance to the closest speaker.

With only one surround back speaker

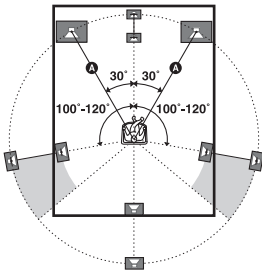

With two surround back speakers (The angle B should be the same)

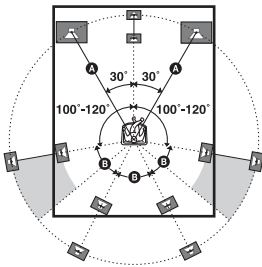

■ CENTER (Center speaker distance)

Lets you set the distance from your listening position to the center speaker.

■ SURROUND L (Surround left speaker distance)

■ SURROUND R (Surround right speaker distance)

Lets you set the distance from your listening position to the surround speakers.

If both surround speakers are not placed an equal distance from your listening position, set the distance to the closest speaker.

■ SUR BACK L (Surround back left speaker distance)

■ SUR BACK R (Surround back right speaker distance)

Lets you set the distance from your listening position to the surround back speaker.

If you connect two surround back speakers and both surround back speakers are not placed an equal distance from your listening position, set the distance to the closest speaker.

■ SUB WOOFER (Sub woofer distance)

Lets you set the distance from your listening position to the sub woofer.

Tips

- If you set up speakers using the auto calibration function, you can adjust the speaker distance in 1 cm increment.
- The distance between the center speaker and the listening position [B] cannot be more than 1.5 meters closer than the one between the listening position and the front speaker [A]. Place the speakers so that the difference in the length of [B] in the following diagram is no more than 1.5 meters closer than the length of [A].

Example: Adjust the distance [B] to 4.5 meters or more when the distance [A] is 6 meters.

Also, the distance between the surround speakers/ surround back speakers and the listening position [C] cannot be more than 4.5 meters closer than the distance between the listening position and the front speakers [A]. Place the speakers so that the difference in the length of [C] in the following diagram is no more than 4.5 meters closer than the length of [A].

continued

Example: Adjust the distance **C** to 1.5 meters or more when the distance **A** is 6 meters. This is important because incorrect speaker placement is not conducive to the enjoyment of surround sound. Place note that placing the speakers closer than the required will cause a delay in the output of the sound from that speaker. In other words, the speaker will sound like it is farther away.

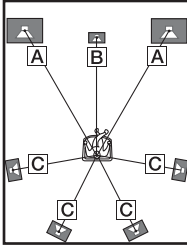

DISTANCE UNIT (Distance unit)

Lets you select the unit of measure for setting distances.

- feet
The distance is displayed in feet.
- meter
The distance is displayed in meters.

SP POSI. (Surround speaker position)

Lets you specify the location of your surround speakers for proper implementation of the surround effects in the Cinema Studio EX modes (page 72). This setup item is not available when the surround speakers are set to “NO” (page 64).

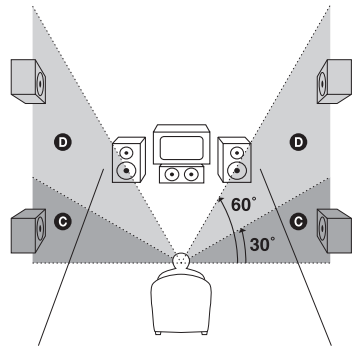
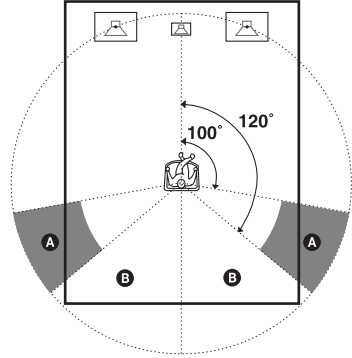

- **SIDE/LOW**
Select if the location of your surround speakers corresponds to sections **A** and **C**.
- **SIDE/HIGH**
Select if the location of your surround speakers corresponds to sections **A** and **D**.
- **BEHD/LOW**
Select if the location of your surround speakers corresponds to sections **B** and **C**.
- **BEHD/HIGH**
Select if the location of your surround speakers corresponds to sections **B** and **D**.

Tip

Surround speaker position is designed specifically for implementation of the Cinema Studio EX modes. For other sound fields, speaker position is not so critical.

Those sound fields were designed under the premise that the surround speakers would be located behind the listening position, but presentation remains fairly consistent even with the surround speakers positioned at a rather wide angle. However, if the speakers are pointing toward the listener from the immediate left and right of the listening position, the surround effects become unclear unless set to "SIDE."

Nevertheless, each listening environment has many variables, such as wall reflections, and you may obtain better results using "BEHD" if your speakers are located high above the listening position, even if they are located to the immediate left and right. Therefore, although it may result in a setting contrary to the above explanation, we recommend that you playback multi-channel surround encoded software and select the setting that provides a good sense of spaciousness and that best succeeds in forming a cohesive space between the surround sound from the surround speakers and the sound of the front speakers. If you are not sure which sounds best, select "BEHD" and then use the speaker distance parameter and speaker level adjustments to obtain proper balance.

■ SP CROSSOVER (Speaker crossover frequency)

Lets you set the bass crossover frequency of speakers that has been set to "SMALL" in the System Settings menu. You cannot set "SP CROSSOVER" when setting speakers using the auto calibration function. To adjust the speaker crossover, set "A.CAL LOAD ?" to "OFF" in the Auto Calibration menu. Then, set up the speakers manually, and select the parameter from "SP CROSSOVER."

Note

When MULTI IN is selected, only the sources from the sub woofer and center channel are downmixed into the front speakers. In this case, settings for the speaker distance and position, and the speaker crossover frequency are invalid.

Settings for the system (System Settings menu)

You can use the System Settings menu to customize the settings of the receiver. Select "System Settings" in the setting menus. For details on adjusting the parameters, see "Navigating through menus" (page 52) and "Overview of the menus" (page 53).

System Settings menu parameters

■ DIMMER (Brightness of the display)

Lets you adjust the brightness of the display. When you choose setting such that you turn off the display completely, the MULTI CHANNEL DECODING indicator is also turned off.

■ SP. IMPEDANCE (Speaker impedance)

For details, see "6: Setting the speakers" (page 38).

Calibrating the appropriate settings automatically (Auto Calibration menu)

For details, see “7: Calibrating the appropriate settings automatically (AUTO CALIBRATION)” (page 40).

Enjoying Surround Sound

Enjoying Dolby Digital and DTS surround sound (A.F.D. mode)

The A.F.D. (Auto Format Direct) mode allows you to listen to higher fidelity sound and select the decoding mode for listening to a 2 channel stereo sound as multi-channel sound.

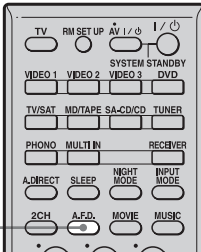

Press A.F.D. repeatedly to select the sound field you want.



For details, see “Type of A.F.D. mode” (page 70).

You can also select “A.F.D.” in the Sur Settings menu. For details, see “Settings for the surround sound (Sur Settings menu)” (page 59).

Notes

- This function does not work in the following cases.
 - MULTI IN is selected.
 - Input signals of which the sampling frequency is more than 48 kHz are being received.
- If you set up the sound field during DTS 96/24 signal reception, it will play back only at 48 kHz.

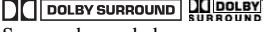
Tips

- We usually recommend “A.F.D. AUTO,” however sometimes it may be better to use “SB DECODING” (page 60) to match the input stream to the mode you prefer.
- You can identify the encoding format of DVD software, etc., by looking at the logo on the package.
 -  : Dolby Digital discs
 -  : Dolby Surround encoded programs
 -  : DTS Digital Surround encoded programs
- Only Dolby Pro Logic Ix decoding is effective, when a multi-channel signal is input. At this time, the setup of “SB DECODING” and “SB DEC MODE” in the Sur Settings menu becomes invalid. When you select decoding modes other than Dolby Pro Logic Ix, multi-channel sound (being encoded) is output.

If you connect a sub woofer

This receiver will generate a low frequency signal for output to the sub woofer when there is no L.F.E. signal, which is a low-pass sound effect output from a sub woofer to a 2 channel signal. However, the low frequency signal is not generated for “Neo:6 Cinema” or “Neo:6 Music” when all speakers are set to “LARGE.”

Type of A.F.D. mode

Decoding mode	A.F.D. mode [Display]	Multi-channel audio after decoding	Effect
(Detecting automatically)	A.F.D. AUTO [A.F.D. AUTO]	(Detecting automatically)	Presets the sound as it was recorded/ encoded without adding any surround effects.
Dolby Pro Logic	A.F.D. PRO LOGIC [PRO LOGIC]	4-channel signals	Performs Dolby Pro Logic decoding. The source recorded in 2 channel format is decoded into 4.1 channels.
Dolby Pro Logic II	A.F.D. PRO LOGIC II MOVIE [PRO LOGIC II MOVIE]	5-channel signals	Performs Dolby Pro Logic II Movie mode decoding. This setting is ideal for movies encoded in Dolby Surround. In Addition, this mode can reproduce sound in 5.1 channel system for watching videos of overdubbed or old movies.
	A.F.D. PRO LOGIC II MUSIC [PRO LOGIC II MUSIC]	5-channel signals	Performs Dolby Pro Logic II Music mode decoding. This setting is ideal for normal stereo sources such as CDs.
	A.F.D. PRO LOGIC II GAME [PRO LOGIC II GAME]	5-channel signals	Performs Dolby Pro Logic II Game mode decoding.
Dolby Pro Logic IIx*	A.F.D. PRO LOGIC IIx MOVIE [PRO LOGIC IIx MOVIE]	7-channel signals	Performs Dolby Pro Logic IIx Movie mode decoding. This setting is ideal for movies encoded in Dolby Surround. In addition, this mode can reproduce sound in 7.1 channel system for watching videos of overdubbed or old movies.
	A.F.D. PRO LOGIC IIx MUSIC [PRO LOGIC IIx MUSIC]	7-channel signals	Performs Dolby Pro Logic IIx Music mode decoding. This setting is ideal for normal stereo sources such as CDs.
	A.F.D. PRO LOGIC IIx GAME [PRO LOGIC IIx GAME]	7-channel signals	Performs Dolby Pro Logic IIx Game mode decoding.
Neo:6	A.F.D. Neo:6 Cinema [Neo:6 Cinema]	6-channel signals	Performs DTS Neo:6 Cinema mode decoding.
	A.F.D. Neo:6 Music [Neo:6 Music]	6-channel signals	Performs DTS Neo:6 Music mode decoding. This setting is ideal for normal stereo sources such as CDs.
(Multi Stereo)	A.F.D. MULTI STEREO [MULTI STEREO]	(Multi Stereo)	Outputs 2 channel left/right signals from all speakers.

* You cannot select this decoding mode if there are no surround back speakers connected to the receiver.

Selecting a pre-programmed sound field (DCS)

You can take advantage of surround sound simply by selecting one of the receiver's preprogrammed sound fields. They bring the exciting and powerful sound of movie theaters and concert halls into your home.

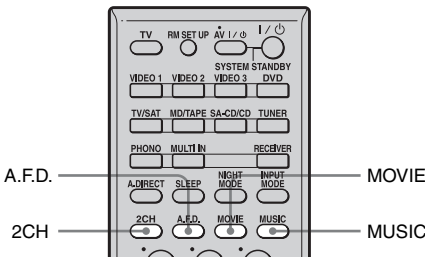

- When one of the sound fields for music is selected, no sound is output from the sub woofer if all the speakers are set to “LARGE” in the System Settings menu. However, the sound will be output from the sub woofer if the digital input signal contains L.F.E. signals, the front or surround speakers are set to “SMALL,” the sound field for movie is selected, or “PORTABLE AUDIO” is selected.
- The surround back decoding mode does not function while a sound field for music is selected (page 60).

Tips

- Sound fields with **DCS** marks use DCS technology. See “Glossary” (page 98).
- When the sound field's **DCS** mark is selected, the Digital Cinema Sound lamp lights up on the display.

To turn off the surround effect for MOVIE/MUSIC

Press 2CH to select “2CH STEREO” or press A.F.D. repeatedly to select “A.F.D. AUTO.”

Press MOVIE repeatedly to select a sound field for movies or press MUSIC repeatedly to select a sound field for music.

The sound field list appears. You can also select “MOVIE” or “MUSIC” in the Sur Settings menu. For details, see “Settings for the surround sound (Sur Settings menu)” (page 59).

Notes

- The sound fields for music and movie do not work in the following cases.
 - MULTI IN is selected.
 - Input signals of which the sampling frequency is more than 48 kHz are being received.
- If you set up the sound field during DTS 96/24 signal reception, it will play back only at 48 kHz.
- The effects provided by the virtual speakers may cause increased noise in the playback signal.
- When listening with sound fields that employ the virtual speakers, you will not be able to hear any sound coming directly from the surround speakers.

Types of sound field available

Sound field for	Sound field	Effect
Movie	CINEMA STUDIO EX A DCS	Reproduces the sound characteristics of the Sony Pictures Entertainment "Cary Grant Theater" cinema production studio. This is a standard mode, great for watching almost any type of movie.
	CINEMA STUDIO EX B DCS	Reproduces the sound characteristics of the Sony Pictures Entertainment "Kim Novak Theater" cinema production studio. This mode is ideal for watching science-fiction or action movies with lots of sound effects.
	CINEMA STUDIO EX C DCS	Reproduces the sound characteristics of the Sony Pictures Entertainment scoring stage. This mode is ideal for watching musicals or films where orchestra music is featured in the soundtrack.
	V.MULTI DIMENSION DCS	Creates many virtual speakers from a single pair of actual surround speakers.
Music	HALL	Reproduces the acoustics of a classical concert hall.
	JAZZ CLUB	Reproduces the acoustics of a jazz club.
	LIVE CONCERT	Reproduces the acoustics of a 300-seat live house.
	STADIUM	Reproduces the feeling of a large open-air stadium.
	SPORTS	Reproduces the feeling of sports broadcasting.
	PORTABLE AUDIO	Reproduces a clear enhanced sound image from your portable audio device. This mode is ideal for MP3 and other compressed music.
Headphone*	HEADPHONE (2CH)	This mode is selected automatically if you use headphones when 2CH STEREO mode (page 73)/A.F.D. mode (page 69) is selected. Standard 2 channel stereo sources completely bypass the sound field processing and multi-channel surround formats are downmixed to 2 channels.
	HEADPHONE THEATER DCS	This mode is selected automatically when you use headphones when sound field is selected for movie/music. It allows you to experience a theater-like environment while listening through a pair of headphones.
	HEADPHONE (DIRECT)	Outputs the analog signals without processing by the tone, sound field, etc.
	HEADPHONE (MULTI)	This mode is selected automatically if you use headphones when MULTI IN is selected. Outputs the front analog signals from the MULTI CHANNEL INPUT jacks.

* You can select this sound field mode if the headphones are connected to the receiver.

Using only the front speakers (2CH STEREO)

In this mode, the receiver outputs the sound from the front left/right speakers only. There is no sound from the sub woofer. Standard 2 channel stereo sources completely bypass the sound field processing and multi-channel surround formats are downmixed to 2 channel.

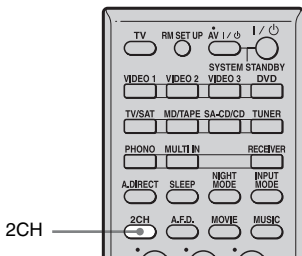

Press 2CH.

Note

No sound is output from the sub woofer in the 2CH STEREO mode. To listen to 2 channel stereo sources using the front left/right speakers and a sub woofer, select "A.F.D. AUTO."

This receiver will generate a low frequency signal for output to the sub woofer when there is no L.F.E. signal, which is a low-pass sound effect output from a sub woofer to a 2 channel signal.

Enjoying the surround effect at low volume levels (NIGHT MODE)

This function allows you to retain a theater like environment at low volume levels. This function can be used with other sound fields. When watching a movie late at night, you will be able to hear the dialog clearly even at a low volume level.

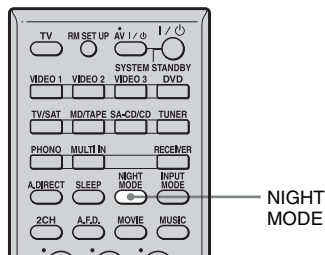

Press NIGHT MODE.

The NIGHT MODE function is activated. The NIGHT MODE is toggled between on and off as you press NIGHT MODE.

Notes

- This function does not work in following cases.
 - MULTI IN is selected
- If you set the NIGHT MODE to on during DTS 96/24 signal reception, it will play back only at 48 kHz.

Tip

While this function is on, the BASS, TREBLE, and EFFECT levels increase, and "D.RANGE COMP." is automatically set to "MAX" (page 57).

Listening to the sound without any adjustment (ANALOG DIRECT)

You can switch the audio of the selected input to 2 channel analog input. This function enables you to enjoy high quality analog sources. When using this function, only the volume and front speaker balance can be adjusted.

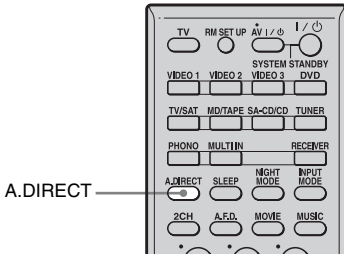

Press A.DIRECT.

Analog audio is output. ANALOG DIRECT function is toggled between on and off as you press A.DIRECT.

To enjoy the analog sound source with noise free performance (Analog pureness control)

The Analog pureness control function bypasses the video and digital circuits that are not in use, and shuts down the power while the analog source is being played back. Thus, the Analog pureness control function provides noise-free audio performance and delivers high sound quality.

The Analog pureness control function is activated when you select an input source with no video input, then select "ANALOG" from INPUT MODE, and you press ANALOG DIRECT.

Adjusting the speaker levels and balance (TEST TONE)

You can adjust the speaker levels and balance while listening the test tone from your listening position.

Tip

The receiver employs a test tone with a frequency centered at 800 Hz.

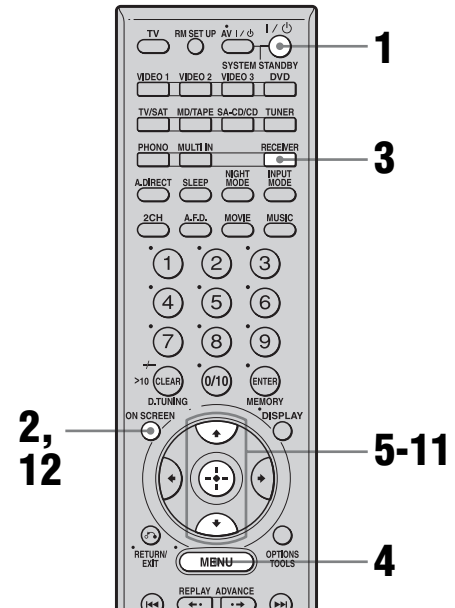

1 Turn on the receiver and TV.

2 Press ON SCREEN.

Switch the input of the TV so that the setting menu is displayed on the TV screen connected to this receiver.

3 Press RECEIVER.

Receiver operation is enabled.

4 Press MENU.

The list of setting menus appears.

5 Press **↑/↓** repeatedly to select “Level Settings,” then press **⊕** to enter.

6 Press **↑/↓** repeatedly to select “TEST TONE,” then press **⊕**.

7 Press **↑**.

The test tone is output from each speaker in sequence.

Also, if you press **↓**, the pattern will become the “FIX” pattern in which the test tone is output from the selected speaker only.

8 Press **⊕** to enter.

9 Adjust the speaker level and balance using the Level Settings menu so that the level of the test tone sounds the same from each speaker.

For details on the Level Settings menu, see page 56.

Tips

- To adjust the level of all speakers at the same time, press MASTER VOL +/-.
- The adjusted value is shown on the display during adjustment.

10 Press **↑/↓** repeatedly to select “TEST TONE,” then press **⊕**.

11 Press **↓** to select “OFF,” then press **⊕**.

The test tone turns off.

12 Press ON SCREEN.

The menu setting display disappears.

When a test tone is not output from the speakers

- The speaker cords may not be connected securely. Check to see if they are connected securely and cannot be disconnected by pulling on them slightly.
- The speaker cords may have the short-circuit problem.

When a test tone is output from a different speaker than the speaker displayed screen

The location where you set up the speaker (for example, the front speaker position) and type of the speaker terminal you connected (for example, the surround back speaker terminal) are different. Check the speaker allocation.

For more precise adjustment

You can output the test tone or sound source from two adjacent speakers to adjust their balance and level.

Then select the two speakers you want to adjust by selecting “PHASE NOISE” or “PHASE AUDIO” in step 6.

Resetting sound fields to the initial settings

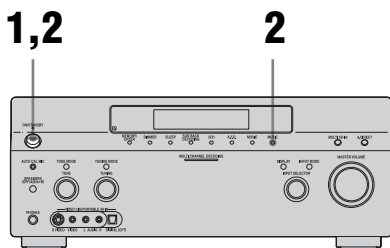

1 Press **POWER** to turn off the power.

2 While holding down **MUSIC**, press **POWER**.

“S.F. Initialize” appears on the display and all sound fields are reset to their initial setting.

Tuner Operations

Listening to FM/AM radio

You can listen to FM and AM broadcasts through the built-in tuner. Before operation, make sure you have connected the FM and AM antennas (aerials) to the receiver (page 35).

Tip

The tuning scale for direct tuning is shown below.

- FM band 50 kHz
- AM band 9 kHz

Automatic tuning



1 Press **TUNER** repeatedly to select the FM or AM band.

2 Press **TUNING +/-**.

Press **TUNING +** to scan from low to high, press **TUNING -** to scan from high to low.

The receiver stops scanning whenever a station is received.

In case of poor FM stereo reception

If the FM stereo reception is poor and “STEREO” flashes on the display, select monaural audio so that the sound will be less distorted.

Select “MONO” in “FM MODE” selection in the Tuner Settings menu.

Direct tuning

Enter the frequency of a station directly by using the numeric buttons.

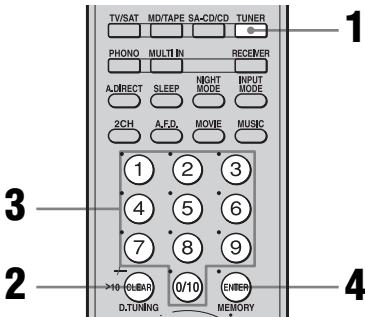

- 1 Press TUNER repeatedly to select the FM or AM band.**
- 2 Press D.TUNING.**
- 3 Press the numeric buttons to enter the frequency.**
Example 1: FM 102.50 MHz
Select 1 → 0 → 2 → 5 → 0
Example 2: AM 1,350 kHz
Select 1 → 3 → 5 → 0
- 4 Press ENTER.**

Tip

If you have tuned in an AM station, adjust the direction of the AM loop antenna (aerial) for optimum reception.

If you cannot tune in a station and the entered numbers flash

Make sure you have entered the right frequency. If not, repeat steps 2 to 4. If you still cannot tune in a station, the frequency is not used in your area.

Storing FM stations automatically (AUTOBETICAL)

This function lets you store up to 30 FM and FM RDS stations without redundancy. Additionally, it only stores the stations with the clearest signals.

If you want to store FM or AM stations one by one, see “Presetting radio stations” (page 79).

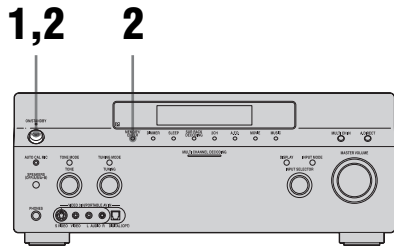

- 1 Press POWER to turn off the receiver.**

2 Hold down MEMORY/ENTER and press POWER to turn the receiver back on.

“Autobetical select” appears on the display and the receiver scans and stores all the FM and FM RDS stations in the broadcast area.

For RDS stations, the tuner first checks for stations broadcasting the same program, then stores only the ones with the clearest signal. The selected RDS stations are assigned a 2-character preset code. For more details on RDS, see “Using the Radio Data System (RDS)” (page 81).

Regular FM stations are assigned 2-character preset codes and stored after the RDS stations.

When this process is finished, “Autobetical finished” appears on the display momentarily and the receiver returns to normal operation.

Notes

- Do not press any button on the receiver or supplied remote during autobetical operation, except I/⏻.
- If you move to another area, repeat this procedure to store stations in your new area.
- For details on tuning the stored stations, see “Tuning to preset stations” (page 80).
- If you move the antenna after storing stations with this procedure, the stored settings may no longer be valid. If this happens, repeat this procedure to store the stations again.

Presetting radio stations

You can preset up to 30 FM and 30 AM stations. Then you can easily tune in the stations you often listen to.

Presetting radio stations

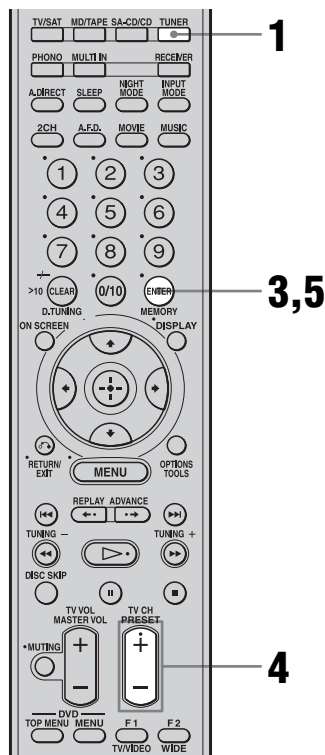

- 1 Press TUNER repeatedly to select the FM or AM band.
- 2 Tune in the station that you want to preset using Automatic Tuning (page 77) or Direct Tuning (page 78).

Switch the FM reception mode, if necessary (page 77).

continued

79GB

3 Press MEMORY.

“MEMORY” appears on the display for a few seconds. Perform steps 4 and 5 before the display goes out.

4 Press PRESET +/- to select a preset number.

If “MEMORY” goes out before you select the preset number, start again from step 3.

5 Press ENTER.

The station is stored as the selected preset number.

If “MEMORY” goes out before you press MEMORY, start again from step 3.

6 Repeat steps 1 to 5 to preset another station.

1 Press TUNER repeatedly to select the FM or AM band.

2 Press PRESET +/- repeatedly to select the preset station you want.

Each time you press the button, you can select a preset station as follows:

- AM band: AM1 to AM30
- FM band: FM1 to FM30

You can also press the numeric buttons to select the preset station you want. Then, press ENTER to enter the selection.

Tuning to preset stations

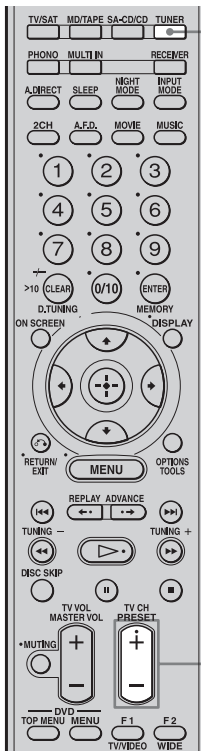

Naming preset stations

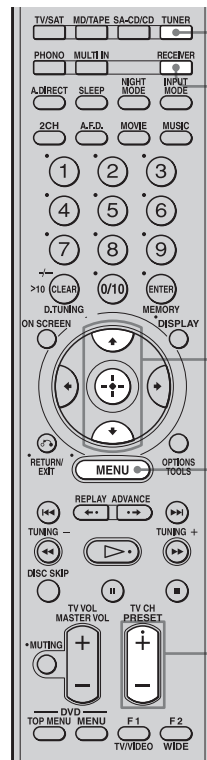

1 Press TUNER repeatedly to select the FM or AM band.

2 Tune in the preset station you want to create an index name for (page 77).

3 Press **RECEIVER**.

Receiver operation is enabled.

4 Press **MENU**.

The list of setting menus appears.

5 Press **▲/▼** repeatedly to select “Tuner Settings,” then press



6 Press **▲/▼** repeatedly to select “NAME IN?.”

7 Press to enter the parameter.

The cursor flashes and you can select a character. Follow the procedure given in “Naming inputs” (page 84).

Note

When you name an RDS station and tune in that station, the Program Service (PS) name appears instead of the name you entered. (You cannot change the Program Service (PS) name. The name you entered will be overwritten by the Program Service (PS) name.)

Using the Radio Data System (RDS)

This receiver also allows you to use RDS (Radio Data System), which enables radio stations to send additional information along with the regular program signal. You can display RDS information.

Notes

- RDS is operable only for FM stations.
- Not all FM stations provide RDS service, nor do they provide the same type of services. If you are not familiar with the RDS services in your area, check with your local radio stations for details.

Receiving RDS broadcasts

Simply select a station on the FM band using direct tuning (page 78), automatic tuning (page 77), or preset tuning (page 80).

When you tune in a station that provides RDS services, “RDS” lights up and the program service name appears on the display.

Note

RDS may not work properly if the station you tuned to is not transmitting the RDS signal properly or if the signal strength is weak.

Displaying RDS information

While receiving an RDS station, press DISPLAY repeatedly.

Each time you press the button, RDS information on the display changes cyclically as follows:

PS (Program Service name)^{a)} → PTY (Program Type) indication^{b)} → RT (Radio Text) indication^{c)} → CT (Time) indication (in 24-hour system mode) → Sound field type → Volume

^{a)}This information also appears for non-RDS FM stations.

^{b)}Type of program being broadcast.

continued

c)Text messages sent by the RDS station.

Notes

- If there is an emergency announcement by government authorities, “Alarm-Alarm!” flashes in the display.
- If a station does not provide a particular RDS service, “No XX” (such as “No Clock Time”) appears on the display.
- When a station broadcasts radio text data, it is displayed at the same rate at which it is sent from the station. Any change in this rate is reflected in the display rate of the data.

Description of program types

Program type indication	Description
News	News programs
Current Affairs	Topical programs that expand on current news
Information	Programs offering information on a wide spectrum of subjects, including consumer affairs and medical advice
Sport	Sports programs
Education	Educational programs, such as “how-to” and advice programs
Drama	Radio plays and serials
Cultures	Programs about national or regional culture, such as language and social concerns
Science	Programs about the natural sciences and technology
Varied Speech	Other types of programs such as celebrity interviews, panel games, and comedy
Pop Music	Popular music programs
Rock Music	Rock music programs
Easy Listening	Easy Listening
Light Classics M	Instrumental, vocal, and choral music
Serious Classics	Performances of major orchestras, chamber music, opera, etc.

Program type indication	Description
Other Music	Music that does not fit into any categories above, such as Rhythm & Blues and Reggae
Weather & Metr	Weather information
Finance	Stock market reports and trading, etc.
Children’s Progs	Programs for children
Social Affairs	Programs about people and the things that affect them
Religion	Programs of religious content
Phone In	Programs where members of the public express their views by phone or in a public forum
Travel & Touring	Programs about travel. Not for announcements that are located by TP/TA
Leisure & Hobby	Programs on recreational activities such as gardening, fishing, cooking, etc.
Jazz Music	Jazz programs
Country Music	Country music programs
National Music	Programs featuring the popular music of the country or region
Oldies Music	Programs featuring oldies music
Folk Music	Folk music programs
Documentary	Investigative features
None	Any programs not defined above

Displaying menus of the receiver on the TV screen

Press ON SCREEN, then display a menu on the TV screen connected to this receiver. You can set up menus easily.

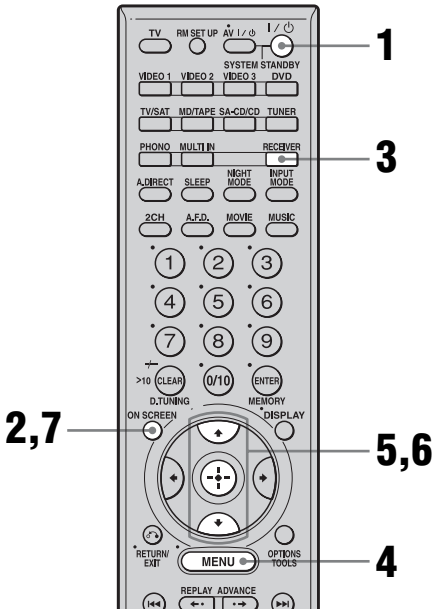

1 Turn on the receiver and the TV.

2 Press ON SCREEN.

Switch the input of the TV so that a setting menu is displayed on the TV screen connected to this receiver.

3 Press RECEIVER.

Receiver operation is enabled.

4 Press MENU.

The following menus are displayed on the TV screen.

- 1-Level Settings
- 2-Equalizer Settings
- 3-Surround Settings
- 4-Tuner Settings
- 5-Audio Settings
- 6-Video Settings
- 7-Speaker Settings
- 8-System Settings
- 9-Auto Calibration

5 Press \uparrow/\downarrow repeatedly to select the menu item, then press \oplus to enter the menu.

6 Press \uparrow/\downarrow repeatedly to select the parameter, then press \oplus to enter the parameter.

Depending on the parameter, the selected parameter can be entered by completing step 7.

7 Press ON SCREEN.

The menu setting display disappears.

Naming inputs

You can enter a name of up to 8 characters for inputs and display it on the receiver's display. This is convenient for labeling the jacks with the names of the connected components.

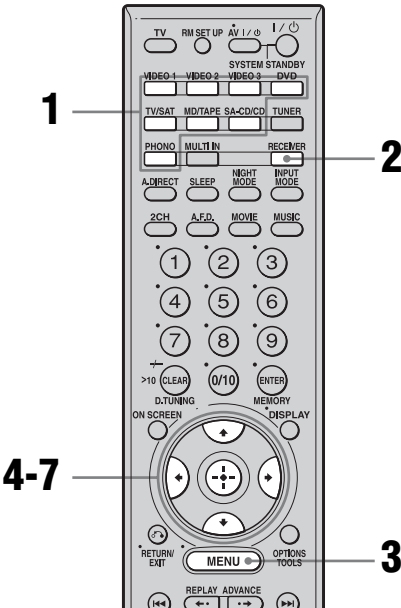

1 Press the input button to select an input you want to create an index name for.

You can also use INPUT SELECTOR on the receiver. The selected input appears on the display.

2 Press RECEIVER.

Receiver operation is enabled.

3 Press MENU.

The list of setting menus appears.

4 Press \uparrow/\downarrow repeatedly to select "Tuner Settings," "Audio Settings," "Video Settings," or "Auto Calibration."

5 Press \oplus to enter the menu.

6 Press \uparrow/\downarrow repeatedly to select "NAME IN ?" or "A.CAL NAME?," then press \oplus to enter.

The cursor flashes and you can select a character.

Press \uparrow/\downarrow to select a character, press \leftarrow/\rightarrow to select the position in which to enter the selected character.

To enter a blank space

Press \leftarrow/\rightarrow without inputting a character. You can also turn +/- on the receiver until a blank space appears on the display.

If you made a mistake

Press \leftarrow/\rightarrow until the character you want to change flashes, then turn +/- on the receiver to select the correct character.

Tip

You can select the character type by pressing \uparrow/\downarrow .

Alphabet (upper case) \rightarrow Alphabet (lower case) \rightarrow Numbers \rightarrow Symbols

7 Press \oplus to enter the name.

The entered name is registered.

Switching between digital and analog audio (INPUT MODE)

When you connect components to both digital and analog audio input jacks on the receiver, you can fix the audio input mode to either of them, or switch from one to the other, depending on the type of material you intend to watch.

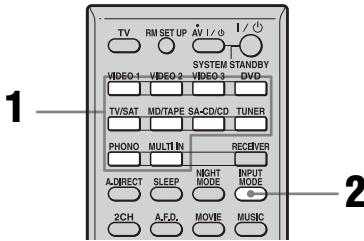

1 Press the input button.

You can also use INPUT SELECTOR on the receiver.

2 Press INPUT MODE repeatedly to select the audio input mode.

The selected audio input mode appears on the display.

Audio input modes

- **AUTO**
Gives priority to digital audio signals when there are both digital and analog connections.
If there are no digital audio signals, analog audio signals are selected.
- **COAX**
Specifies the digital audio signals input to the DIGITAL COAXIAL jack.
- **OPT**
Specifies the digital audio signals input to the DIGITAL OPTICAL jack.

- **ANALOG**

Specifies the analog audio signals input to the AUDIO IN (L/R) jacks.

Notes

- You cannot select the digital audio input assigned to another function using the DIGITAL ASSIGN function (page 86).
- Some audio input modes may not be set up depending on the input.
- When the ANALOG DIRECT function is being used, or MULTI IN is selected, audio input is set to "ANALOG." You cannot select other modes.

Listening to digital sound from other inputs (DIGITAL ASSIGN)

You can reassign digital audio input that has OPTICAL or COAXIAL (VIDEO 1 IN, DVD IN, TV/SAT IN, MD/DAT IN, SA-CD/CD IN) signals to another input when they are not currently being used.

For example, to make the DVD player the sound source for the digital audio input using the OPTICAL IN jack on the receiver, then:

- Connect the optical output jack of the DVD player and the OPTICAL VIDEO 1 IN jack of the receiver.
- Assign “VIDEO 1 OPT” to “DVD” in the DIGITAL ASSIGN setting.

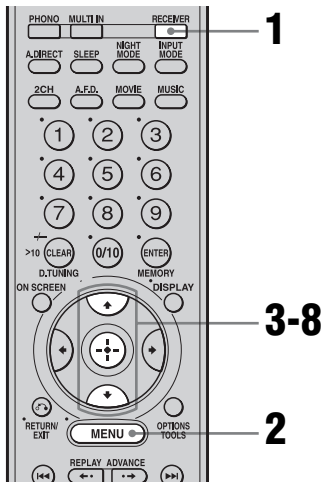

- 1 Press RECEIVER.**
Receiver operation is enabled.
- 2 Press MENU.**
The list of setting menus appears.
- 3 Press \uparrow/\downarrow repeatedly to select “Audio Settings,” then press \oplus to enter.**

- 4 Press \uparrow/\downarrow to select “DIGITAL ASSIGN ?,” then press \oplus .**
- 5 Press \uparrow/\downarrow repeatedly to select a vacant digital audio input (VIDEO 1 OPT in the example).**
- 6 Press \oplus .**
- 7 Press \uparrow/\downarrow repeatedly to select the input (DVD in the example) you want to assign to the digital audio input jack selected in step 5.**
- 8 Press \oplus .**

If an input is switched to “DVD,” the sound of the DVD player will also become a digital sound through the OPTICAL VIDEO 1 IN jack.

The input you can assign varies for each audio input. For details, see the following “Assignable inputs for digital audio input.”

Assignable inputs for digital audio input

The initial setting is marked with an underscore.

Digital audio input	Assignable inputs
VIDEO 1 OPT	<u>VIDEO 1</u> , VIDEO 2, DVD, SA-CD/CD
VIDEO 3 OPT	<u>VIDEO 3</u> , VIDEO 2, DVD, SA-CD/CD
TV/SAT OPT	<u>TV/SAT</u> , VIDEO 2, DVD, SA-CD/CD
MD/TAPE OPT	<u>MD/DAT</u> , VIDEO 2, DVD, SA-CD/CD
DVD COAX	<u>DVD</u> , VIDEO 1, VIDEO 2, VIDEO 3, TV/SAT, MD/TAPE
SA-CD/CD COAX	<u>SA-CD/CD</u> , VIDEO 1, VIDEO 2, VIDEO 3, TV/SAT, MD/TAPE

Notes

- You cannot reassign more than one digital audio input to the same input.
- You cannot assign optical signals from an input source to the optical input jacks on the receiver, and you cannot assign coaxial signals from the input source to the coaxial input jacks on the receiver.
- You cannot use the digital audio input as the original input when it has been reassigned to another input.
- When you assign the digital audio input, the INPUT MODE setting may change automatically (page 85).

Watching HDMI images from other inputs (HDMI ASSIGN)

You can reassign an HDMI video input to another input.

For example, you can watch HDMI images when you select a SA-CD/CD player, while listening to a super audio CD via the SA-CD/CD jack.

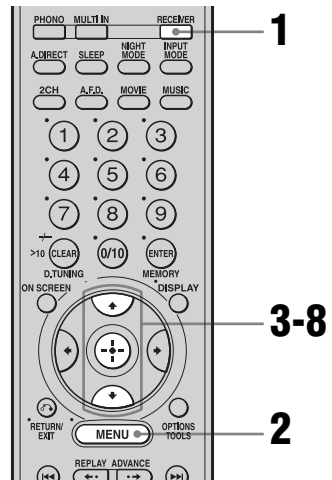

- 1 Press RECEIVER.**
Receiver operation is enabled.
- 2 Press MENU.**
The list of setting menus appears.
- 3 Press \uparrow/\downarrow repeatedly to select “Video Settings,” then press \oplus .**
- 4 Press \uparrow/\downarrow repeatedly to select “HDMI ASSIGN ?,” then press \oplus .**
- 5 Press \uparrow/\downarrow repeatedly to select an HDMI input you want to reassign.**

continued

6 Press **+**.

7 Press **↑/↓** repeatedly to select the input you want to assign as an HDMI video input selected in step 5.

8 Press **+**.

The input you can assign varies for each component video input. For details, see “Assignable inputs for an HDMI video input.”

Assignable inputs for an HDMI video input

The initial setting is marked with an underscore.

HDMI video input	Assignable inputs
DVD	NONE, VIDEO 1, VIDEO 2, VIDEO 3, <u>DVD</u> , MD/TAPE, SA-CD/CD
TV/SAT	NONE, VIDEO 1, VIDEO 2, VIDEO 3, <u>TV/SAT</u> , MD/TAPE, SA-CD/CD

Note

You cannot reassign more than one HDMI input to the same input.

Watching component images from other inputs (COMPONENT VIDEO ASSIGN)

You can reassign a component video input to another input (VIDEO 2 IN etc.).

For example, you can watch component images when you select a SA-CD/CD player, while listening to a super audio CD via the SA-CD/CD IN jack.

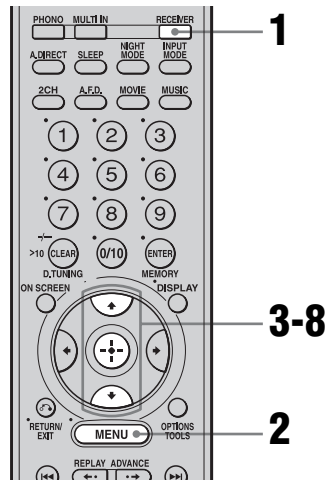

1 Press **RECEIVER**.

Receiver operation is enabled.

2 Press **MENU**.

The list of setting menus appears.

3 Press **↑/↓** repeatedly to select “Video Settings,” then press **+**.

4 Press **↑/↓** repeatedly to select “COMPONENT V. ASSIGN ?,” then press **+**.

5 Press **↑/↓** repeatedly to select an input (DVD IN in the example) you want to reassign.

6 Press **⊕**.

7 Press **↑/↓** repeatedly to select the input (SA-CD/CD in the example) you want to assign as the component video input selected in step 5.

8 Press **⊕**.

If an input is switched to “SA-CD/CD,” the image from the DVD player will be a component image.

The input you can assign varies for each component video input. For details, see the following “Assignable inputs for component video input.”

Assignable inputs for component video input

The initial setting is marked with an underscore.

Component video input	Assignable inputs
DVD	NONE, VIDEO 1, VIDEO 2, VIDEO 3, <u>DVD</u> , MD/TAPE, SA-CD/CD
TV/SAT	NONE, VIDEO 1, VIDEO 2, VIDEO 3, <u>TV/SAT</u> , MD/TAPE, SA-CD/CD

Notes

- You cannot reassign more than one component video input to the same input.
- You cannot use the component video input as the original input when it has been reassigned to another input.

Changing the display

You can check the sound field, etc., by changing the information on the display.

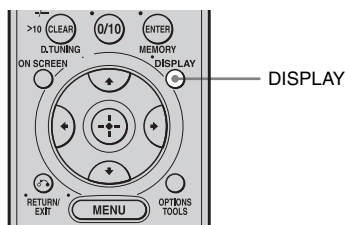

Press DISPLAY repeatedly.

Each time you press DISPLAY, the display will change as follows.

Station name → Frequency → Sound field type → Volume...

FM and AM band

Preset station name and sound field type* ↔ Frequency and sound field type

* Index name appears only when you have assigned one to the input or preset station (page 80, 84). Index name does not appear when only blank spaces have been entered, or it is the same as the input name.

Using the Sleep Timer

You can set the receiver to turn off automatically at a specified time.

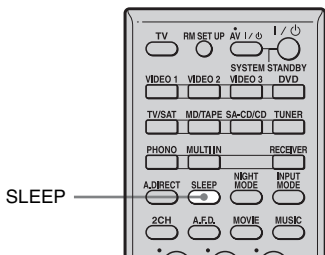

Press SLEEP repeatedly.

Each time you press SLEEP, the display changes cyclically as follows:

→ 2:00:00 → 1:30:00 → 1:00:00 → 0:30:00 → OFF

When Sleep Timer is being used, “SLEEP” lights up on the display.

Tip

To check the remaining time before the receiver turns off, press SLEEP. The remaining time appears on the display. If you press SLEEP again, the sleep timer will be changed.

Recording using the receiver

You can record from a video/audio component using the receiver. Refer to the operating instructions supplied with your recording component.

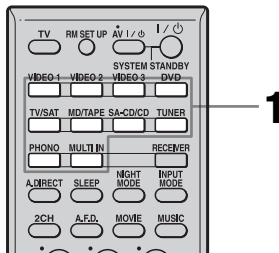

Recording onto a MiniDisc or audio tape

You can record onto a MiniDisc or audio tape using the receiver. See the operating instructions supplied with your MD deck or tape deck.

1 Press the input button of the playback component.

You can also use INPUT SELECTOR on the receiver.

2 Prepare the playback component for playing.

For example, insert a CD into the CD player.

3 Prepare the recording component.

Insert a blank MD or tape into the recording deck and adjust the recording level.

4 Start recording on the recording deck, then start playback on the playback component.

Notes

- Sound adjustments do not affect the signal output from the TAPE/CDR OUT or MD/DAT OUT jacks.
- The audio signals input to the MULTI CHANNEL INPUT jacks are output only from the front left/right channels.

To record digital sound

Connect a component for playback to the digital audio input (OPTICAL IN) jack, and connect the recording component to the OPTICAL MD/DAT OUT jack.

Recording onto recording media

- 1 Press the input button of the playback component.**
You can also use INPUT SELECTOR on the receiver.
- 2 Prepare the component for playing.**
For example, insert the video tape you want to copy into the VCR.
- 3 Prepare the recording component.**
Insert a blank video tape, etc. into the recording component (VIDEO 1 or VIDEO 2) for recording.
- 4 Start recording on the recording component, then start playback on the playback component.**

Notes

- Some sources contain copy guards to prevent recording. In this case, you may not be able to record from the sources.
- The audio signals input to the MULTI CHANNEL INPUT jacks are output only from the front left/right channels.

Using a bi-amplifier connection

If you are not using surround back speakers, you can use the SURROUND BACK SPEAKERS terminals for the front speakers for use with a bi-amplifier connection.

To connect speakers

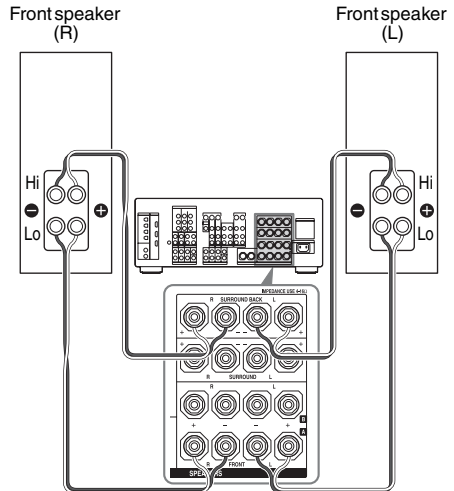

Connect the jacks on the Lo (or Hi) side of the front speakers to the FRONT SPEAKERS A jacks, and connect the jacks on the Hi (or Lo) side of the front speakers to the SURROUND BACK SPEAKERS terminals. Make sure that metal fittings of Hi/Lo attached to the speakers have been removed from the speakers. Not doing so may cause a malfunction of the receiver.

To set up speakers

Set "SUR BACK SP" to "BI-AMP" in the Speaker Settings menu (page 63). The same signals output from the FRONT SPEAKERS A terminals can be output from the SURROUND BACK SPEAKERS terminals.

Notes

- You cannot use the FRONT SPEAKERS B jacks for a bi-amplifier connection.
- When you use the auto calibration function, make the bi-amplifier settings before you perform auto calibration.
- If you make the bi-amplifier settings, the speaker level, balance, and equalizer settings of the surround back speakers become invalid, and those of the front speakers are used.
- Signals output from the PRE OUT jacks are used with the same settings as those of the SPEAKERS terminals.
- The audio signal of the center speaker of the MULTI CHANNEL INPUT jack is not output from the front left/right speakers when you set “SUR BACK SP” to “BI-AMP” in the Speaker Settings menu.

Using the Remote

Operating each component using the remote

When you program the remote to control the following Sony or non-Sony components, you can use the buttons on the remote that are marked with circles. Note, however, that some buttons may not operate your component.

If you want to change the contents of the input list to match your particular components, see “Programming the remote” (page 94).

Table of buttons used to control each component

Component \ Button	TV	VCR	DVD recorder, DVD/VHS combo	Blu-ray Disk player	PSX Video player, LD player	CD player	Digital satellite/terrestrial receiver	DSS, BST	Tape deck A/B	DAT deck	CD player, MD deck	Tuner	Receiver
AV I/⏻, I/⏻ (after pressing TV)	●	●	●	●	●	●	●	●		●	●		
Numeric buttons	●	●	●	●	●	●	●	●	●	●	●	●	●
MEMORY, ENTER	●	●	●	●	●	●*		●	●	●	●	●	●
CLEAR, D.TUNING, >10, -/-	●	●	●	●	●	●		●	●		●	●	
DISPLAY	●	●	●	●	●	●		●			●	●	●
OPTIONS/TOOLS	●		●										
RETURN/EXIT	●		●	●	●	●	●	●**					●
⏮/⏪/⏩/⏭, ⊕	●	●	●	●	●		●	●					●
MENU	●	●	●	●	●		●	●					●
⏮/⏪/⏩/⏭		●	●	●	●	●			●***	●	●		
CATEGORY +/-, REPLAY/ADVANCE, ⏮/⏩			●	●									
⏮/⏩, TUNING +/-	●	●	●	●	●	●			●	●	●	●	●
▷, II, ■		●	●	●	●	●			●	●	●		
DISK SKIP			●	●	●						●		
MUTING, MASTER VOL +/-, TV VOL +/-	●	●	●	●	●	●	●	●	●	●	●	●	●
PRESET +/-, TV CH +/-	●	●	●	●		●*	●	●				●	
DVD TOP MENU/ NIGHT MODE, DVD MENU/INPUT MODE			●	●	●								●
F1, TV/VIDEO	●		●	●				●**					●
F2, WIDE	●		●	●									●

* LD player only. ** DSS only. *** Deck B only.

Programming the remote

You can customize the remote to match the components connected to your receiver. You can even program the remote to control non-Sony components and also Sony components that the remote is normally unable to control. The procedure below uses as an example a case in which the other manufacturer's VCR is connected to the VIDEO 2 jacks on the receiver.

Before you begin, note that:

- You cannot change the settings of PHONO.
- The remote can control only components that accept infrared wireless control signals.

Be sure to turn on the receiver and point the remote towards the receiver when performing the following procedure.

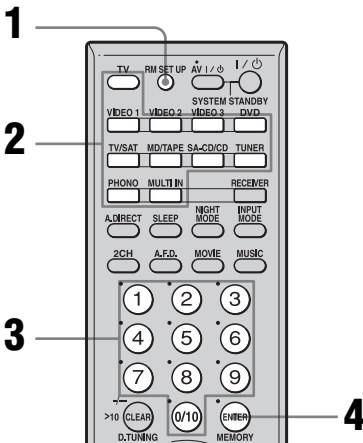

1 Press RM SET UP.

The RM SET UP button flashes.

2 While the RM SET UP button is flashing, press the input button (including TV) for the component you want to control.

For example, if you are going to control a CD player, press SA-CD/CD.

The RM SET UP button lights up.

3 Press the numeric buttons to enter the numeric code (or one of the codes if more than one code exists) corresponding to the component and the maker of the component you want to control.

The RM SET UP button lights up.

Note

For a TV remote code value, only numbers in the 500's are valid.

4 Press ENTER.

Once the numeric code has been verified, the RM SET UP button flashes twice and the remote automatically exits the programming mode. The input button also turns off.

To cancel programming

Press RM SET UP during any step.

The numeric codes corresponding to the component and the maker of the component

Use the numeric codes in the tables below to control non-Sony components and also Sony components that the remote is normally unable to control. Since the remote signal that a component accepts differs depending on the model and year of the component, more than one numeric code may be assigned to a component. If you fail to program your remote using one of the codes, try using other codes.

Notes

- The numeric codes are based on the latest information available for each brand. There is a chance, however, that your component will not respond to some or all of the codes.
- All of the input buttons on this remote may not be available when used with your particular component.

To control a CD player

Maker	Code(s)
SONY	101, 102, 103
DENON	104, 123
JVC	105, 106, 107
KENWOOD	108, 109, 110
MAGNAVOX	111, 116
MARANTZ	116
ONKYO	112, 113, 114
PANASONIC	115
PHILIPS	116
PIONEER	117
TECHNICS	115, 118, 119
YAMAHA	120, 121, 122

To control a DAT deck

Maker	Code(s)
SONY	203
PIONEER	219

To control an MD deck

Maker	Code(s)
SONY	301
DENON	302
JVC	303
KENWOOD	304

To control a tape deck

Maker	Code(s)
SONY	201, 202
DENON	204, 205
KENWOOD	206, 207, 208, 209
NAKAMICHI	210
PANASONIC	216
PHILIPS	211, 212
PIONEER	213, 214
TECHNICS	215, 216
YAMAHA	217, 218

To control an LD player

Maker	Code(s)
SONY	601, 602, 603
PIONEER	606

To control a video CD player

Maker	Code(s)
SONY	605

To control a VCR

Maker	Code(s)
SONY	701, 702, 703, 704, 705, 706
AIWA*	710, 750, 757, 758
AKAI	707, 708, 709, 759
BLAUPUNKT	740
EMERSON	711, 712, 713, 714, 715, 716, 750
FISHER	717, 718, 719, 720
GENERAL ELECTRIC	721, 722, 730
GOLDSTAR/LG	723, 753
GRUNDIG	724
HITACHI	722, 725, 729, 741
ITT/NOKIA	717
JVC	726, 727, 728, 736
MAGNAVOX	730, 731, 738
MITSUBISHI/MGA	732, 733, 734, 735
NEC	736
PANASONIC	729, 730, 737, 738, 739, 740
PHILIPS	729, 730, 731
PIONEER	729
RCA/PROSCAN	722, 729, 730, 731, 741, 747
SAMSUNG	742, 743, 744, 745
SANYO	717, 720, 746
SHARP	748, 749
TELEFUNKEN	751, 752
TOSHIBA	747, 755, 756
ZENITH	754

* If an AIWA VCR does not work even though you enter the code for AIWA, enter the code for Sony instead.

To control a DVD player

Maker	Code(s)
SONY	401, 402, 403
PANASONIC	406, 408
PHILIPS	407
PIONEER	409
TOSHIBA	404
DENON	405

To control a DVD recorder

Maker	Code(s)
SONY	403

To control a TV

Maker	Code(s)
SONY	501, 502
DAEWOO	504, 505, 506, 507, 515, 544
FISHER	508
GOLDSTAR/LG	503, 511, 512, 515, 534, 544
GRUNDIG	517, 534
HITACHI	513, 514, 515, 544
ITT/NOKIA	521, 522
JVC	516
MAGNAVOX	503, 518, 544
MITSUBISHI/MGA	503, 519, 544
NEC	503, 520, 544
PANASONIC	509, 524
PHILIPS	515, 518
PIONEER	509, 525, 526, 540
RCA/PROSCAN	510, 527, 528, 529, 544
SAMSUNG	503, 515, 531, 532, 533, 534, 544
SANYO	508, 545, 546, 547
SHARP	535
TELEFUNKEN	523, 536, 537, 538
THOMSON	530, 537, 539
TOSHIBA	535, 540, 541
ZENITH	542, 543

To control a satellite tuner or cable box

Maker	Code(s)
SONY	801, 802, 803, 804
JERROLD/G.I.	806, 807, 808, 809, 810, 811, 812, 813, 814
PANASONIC	818
RCA	805, 819
S. ATLANTA	815, 816, 817

To control a tuner

Maker	Code(s)
SONY	002, 003, 004, 005

To control a hard disc recorder

Maker	Code(s)
SONY	307, 308, 309

To control a blu-ray disc player

Maker	Code(s)
SONY	310, 311, 312

To control a PSX

Maker	Code(s)
SONY	313, 314, 315

Clearing all the contents of the remote's memory

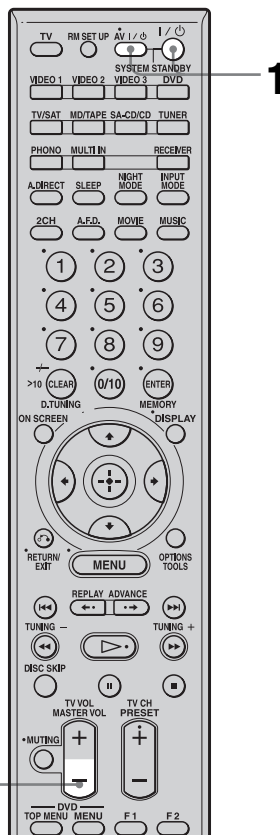

- 1 Press and hold MASTER VOL – first, then press I/O and then AV I/O.**

The RM SET UP button flashes three times.

- 2 Release MASTER VOL –.**

All the contents of the remote's memory (i.e., all the programmed data) are cleared.

Glossary

■ Cinema Studio EX

A surround sound mode that can be regarded as the compilation of Digital Cinema Sound technology, delivers the sound of a dubbing theater using three technologies: “Virtual Multi Dimensions,” “Screen Depth Matching,” and “Cinema Studio Reverberation.”

“Virtual Multi Dimensions,” the virtual speaker technology, creates a virtual multi-surround environment with actual speakers up to 7.1 channels, and brings the surround sound experience of a theater with the latest facilities into your home.

“Screen Depth Matching” reproduces treble attenuation, fullness, and depth of sound usually created in a theater using sound emission from behind the screen. This is then added to the front and center channels.

“Cinema Studio Reverberation” reproduces the sound characteristics of state-of-the-art dubbing theaters and recording studios, including Sony Pictures Entertainment’s dubbing studios. There are three modes, A/B/C, available according to the studio type.

■ Component video

A format for transmitting video signal information consisting of three separate signals: luminance Y, chrominance Pb, and chrominance Pr. High quality pictures, such as DVD video or HDTV pictures, are transmitted more faithfully. The three jacks are color-coded green, blue, and red.

■ Composite video

A standard format for transmitting video signal information. The luminance signal Y and chrominance signal C are combined and transmitted together.

■ Crossover frequency

The frequency at which two speaker’s frequencies intersect.

■ Digital Cinema Sound (DCS)

Unique sound reproduction technology for home theater developed by Sony, in cooperation with Sony Pictures Entertainment, for enjoying the exciting and powerful sound of movie theaters at home. With this “Digital Cinema Sound” developed by integrating a DSP (Digital signal processor) and measured data, the ideal sound field intended by filmmakers can be experienced at home.

■ Dolby Digital

Digital audio encoding/decoding technology developed by Dolby Laboratories, Inc. It consists of front (left/right), center, surround (left/right) and sub woofer channels. It is a designated audio standard for DVD-video and also known as 5.1 channels surround.

■ Dolby Digital Surround EX

Acoustic technology developed by Dolby Laboratories, Inc. Surround back information is matrixed into regular left and right surround channels so that the sound can be reproduced in 6.1 channels. Active scenes, especially, are recreated with a more dynamic and realistic sound field.

■ Dolby Pro Logic II

This technology converts 2 channel stereo recorded audio into 5.1 channels for playback. There is a MOVIE mode for movies and MUSIC mode for stereo sources such as music. Old movies encoded in the traditional stereo format can be enhanced with 5.1 channels surround sound. The GAME mode is suitable for video games.

■ Dolby Pro Logic IIx

Technology for 7.1 channels (or 6.1 channels) playback. Along with audio encoded in Dolby Digital Surround EX, 5.1 channels Dolby Digital encoded audio can be reproduced in 7.1 channels (or 6.1 channels). Furthermore, existing stereo recorded content can also be reproduced in 7.1 channels (or 6.1 channels).

■ Dolby Surround (Dolby Pro Logic)

Audio processing technology developed by Dolby Laboratories, Inc. Center and mono surround information is matrixed into two stereo channels. When reproduced, audio is decoded and output in 4 channels surround sound. This is the most common audio processing method for DVD-video.

■ Downmix

A method to output multi-channel audio such as 5.1 channels, encoded into two channels.

■ DTS 96/24

A high sound quality digital signal format. It records audio at a sampling frequency and bit rate of 96 kHz/24 bit which is the highest possible for DVD-video. The number of playback channels varies depending on the software.

■ DTS Neo:6

This technology converts 2 channels stereo recorded audio for 6.1 channels playback. There are two modes to select according to the playback source or your preference, CINEMA for movies, and MUSIC for stereo sources such as music.

■ DTS Digital Surround

Digital audio encoding/decoding technology for theaters developed by Digital Theater Systems, Inc. It compresses audio less than Dolby Digital, delivering a higher quality sound reproduction.

■ DTS-ES

Format for 6.1 channels playback with surround back information. There are two modes, "Discrete 6.1" which records all channels independently, and "Matrix 6.1" which matrixes surround back channel into surround left and surround right channels. It is ideal for playback of motion picture soundtracks.

■ Dynamic Range

The reproductive capacity of audio signals. The difference between the minimum (quietest) and the maximum (loudest) sound that can be reproduced is expressed by a number value of dB. A larger number value means a greater degree of quietness or loudness can be reproduced.

■ HDMI (High-Definition Multimedia Interface)

HDMI is an interface that supports both video and audio on a single digital connection. The HDMI connection carries standard to high definition video signals and multi-channel audio signals to audio/video components, such as HDMI equipped TVs, in digital form without degradation. The HDMI specification supports HDCP (High-bandwidth Digital Contents Protection), a copy protection technology that incorporates coding technology for digital video signals.

■ Interlace

A scanning method which completes a picture by displaying half of the lines on a tube surface of a TV or monitor each 1/60 second. First, all the odd-numbered lines are drawn, leaving spaces between each line, then all the even-numbered lines are drawn to fill the spaces.

■ L.F.E. (Low Frequency Effects)

Sound effects of low frequencies which are output from a sub woofer in Dolby Digital or DTS, etc. By adding a deep bass with a frequency between 20 to 120 Hz, audio becomes more powerful.

■ PCM (Pulse Code Modulation)

A method of converting analog audio to digital audio for easy enjoyment of digital sound.

■ Progressive

A scanning method that draws all scanning lines sequentially, as opposed to interlaced scanning where all the odd and then all the even lines are drawn.

■ Sampling frequency

To convert analog audio to digital, analog data should be quantified. This process is called sampling, and the number of times per second the analog data is quantified is called the sampling frequency. A standard music CD stores data quantified at 44,100 times per second, which is expressed as a sampling frequency of 44.1 kHz. Generally speaking, a higher sampling frequency means better sound quality.

■ S video signal

A format for transmitting video signal information. S video uses a single cable and two channels, one for the Luminance signal Y and another for the chrominance signal C. Better picture quality for recording and playback than that of Composite signal is achieved.

■ TSP (Time Stretched Pulse)

A TSP signal is a highly precise measuring signal that utilizes impulse energy, measuring a wide band, from low to high, in a short period.

The amount of energy used to measure signals is important to ensure measurement accuracy in a normal indoor environment. Using TSP signals makes it possible to measure signals effectively.

Precautions

On safety

Should any solid object or liquid fall into the cabinet, unplug the receiver and have it checked by qualified personnel before operating it any further.

On power sources

- Before operating the receiver, check that the operating voltage is identical with your local power supply.
The operating voltage is indicated on the nameplate on the back of the receiver.
- The unit is not disconnected from the AC power source (mains) as long as it is connected to the wall outlet, even if the unit itself has been turned off.
- If you are not going to use the receiver for a long time, be sure to disconnect the receiver from the wall outlet. To disconnect the AC power cord (mains lead), grasp the plug itself; never pull the cord.
- The AC power cord (mains lead) must be changed only at a qualified service shop.

On heat buildup

Although the receiver heats up during operation, this is not a malfunction. If you continuously use this receiver at a large volume, the cabinet temperature of the top, side and bottom rises considerably. To avoid burning yourself, do not touch the cabinet.

On placement

- Place the receiver in a location with adequate ventilation to prevent heat buildup and prolong the life of the receiver.
- Do not place the receiver near heat sources, or in a place subject to direct sunlight, excessive dust, or mechanical shock.
- Do not place anything on top of the cabinet that might block the ventilation holes and cause malfunctions.

- Do not place the receiver near equipment such as a television, VCR, or tape deck. (If the receiver is being used in combination with a television, VCR, or tape deck, and is placed too close to that equipment, noise may result, and picture quality may suffer. This is especially likely when using an indoor antenna (aerial). Therefore, we recommend using an outdoor antenna (aerial).)

On operation

Before connecting other components, be sure to turn off and unplug the receiver.

On cleaning

Clean the cabinet, panel, and controls with a soft cloth slightly moistened with a mild detergent solution. Do not use any type of abrasive pad, scouring powder, or solvent, such as alcohol or benzine.

If you have any questions or problems concerning your receiver, please consult your nearest Sony dealer.

Troubleshooting

If you experience any of the following difficulties while using the receiver, use this troubleshooting guide to help you remedy the problem. Should any problem persist, consult your nearest Sony dealer.

Audio

There is no sound, no matter which component is selected, or only a very low-level sound is heard.

- Check that the speakers and components are connected securely.
- Check that all speaker cords are connected correctly.
- Check that both the receiver and all components are turned on.
- Check that MASTER VOLUME control is not set at $-\infty$ dB.
- Check that SPEAKERS (OFF/A/B/A+B) is not set to "OFF" (page 38).
- Press MUTING on the remote to cancel the muting function.
- Check that you have selected the correct component with INPUT SELECTOR.
- Check that headphones are not connected.
- When only a very low-level sound is heard, check to see if NIGHT MODE is activated (page 73).
- The protective device on the receiver has been activated. Turn off the receiver, eliminate the short-circuit problem, and turn on the power again.

There is no sound from a specific component.

- Check that the component is connected correctly to the audio input jacks for that component.
- Check that the cord(s) used for the connection is (are) fully inserted into the jacks on both the receiver and the component.

There is no sound from one of the front speakers.

- Connect a pair of headphones to the PHONES jack to verify that sound is output from the headphones. If only one channel is output from the headphones, the component may not be connected to the receiver correctly. Check that all the cords are fully inserted into the jacks on both the receiver and the component. If both channels are output from the headphones, the front speaker may not be connected to the receiver correctly. Check the connection of the front speaker which is not outputting any sound.
- Make sure you have connected both the L or R jack to an analog component and not just to either the L or R jack. Use a monaural-stereo cable (not supplied). However, there will be no sound from the center speaker when a sound field (PRO LOGIC, etc.) is selected. When the center speaker is set to “NO,” sound is output only from the front left/right speakers.

There is no sound from analog 2 channel sources.

- Check that the INPUT MODE is not set to “COAX” nor “OPT” for the selected input (page 85).
- Check that the MULTI IN is not selected.
- Check that the DIGITAL ASSIGN function is not used to reassign the audio input of another source to the selected input (page 86).

There is no sound from digital sources (from COAXIAL or OPTICAL input jack).

- Check that the INPUT MODE is not set to “ANALOG” (page 85). Check that the INPUT MODE is not set to “COAX” for the sources from the OPTICAL input jack, nor set to “OPT” for the sources from the COAXIAL input jack.
- Check that the MULTI IN is not selected.
- Check that the ANALOG DIRECT function is not being used.

- Check that the DIGITAL ASSIGN function is not used to reassign the audio input of another source to the selected input (page 86).

The source sound input from the HDMI jack is not output.

- HDMI audio signals are not output from the speaker terminals.
- Only HDMI audio input signals are output from the TV connected to the HDMI OUT jack on the receiver.
- Check that the component is connected correctly to the HDMI jack for that component.
- You cannot listen to the Super Audio CD by connecting HDMI.
- Depending on the playback component, component may need to be set up. Refer to the operating instructions supplied with the each component.

The left and right sounds are unbalanced or reversed.

- Check that the speakers and components are connected correctly and securely.
- Adjust the balance parameters using the Level Settings menu.

There is severe hum or noise.

- Check that the speakers and components are connected securely.
- Check that the connecting cords are away from a transformer or motor, and at least 3 m (10 feet) away from a TV set or fluorescent light.
- Move your TV away from the audio components.
- Make sure you have grounded the \perp SIGNAL GND terminal (only when a turntable is connected).
- The plugs and jacks are dirty. Wipe them with a cloth slightly moistened with alcohol.

There is no sound, or only a very low-level sound is heard from the center/surround/surround back speakers.

- Select a CINEMA STUDIO EX mode (page 72).
- Adjust the speaker level (page 74).
- Make sure the center/surround speaker (s) is (are) set to either “SMALL” or “LARGE” (page 64).
- Make sure the surround back speakers are set to “DUAL” or “SINGLE” (page 64).

There is no sound from the surround back speakers.

- Some discs have no Dolby Digital Surround EX flag even though the packages have Dolby Digital Surround EX logos. In this case, select “ON” in the “SB DEC MODE” (page 60).

There is no sound from the sub woofer.

- Check that the sub woofer is connected correctly and securely.
- Make sure you have turned on your speaker.
- When all speakers are set to “LARGE” and “Neo:6 Cinema,” or “Neo:6 Music” is selected, there is no sound from the sub woofer.

The surround effect cannot be obtained.

- Make sure the sound field function is on (press MOVIE or MUSIC).
- Sound fields do not function for signals with a sampling frequency of more than 48 kHz.

Dolby Digital or DTS multi-channel sound is not reproduced.

- Check that the DVD, etc. you are playing is recorded in Dolby Digital or DTS format.
- When connecting the DVD player, etc., to the digital input jacks of this receiver, make sure the setting for the digital audio output of the connected component is available.

Recording cannot be carried out.

- Check that the components are connected correctly (page 17, 23).
- Select the source component using INPUT SELECTOR (page 47).

The MULTI CHANNEL DECODING lamp does not light up in blue.

- Check that the playback component is connected on a digital jack and the input is selected properly on this receiver.
- Check whether the input source of the software being played back corresponds to the multi-channel format.
- Check whether the setup on the playback component is set to multi-channel sound.
- Check whether the digital audio output of selected input is not assigned to another component input using DIGITAL ASSIGN function (page 86).

Video

There is no picture or an unclear picture appears on the TV screen or monitor.

- Select the appropriate input on the receiver (page 47).
- Set your TV to the appropriate input mode.
- Move your TV away from the audio components.
- Assign the component video input correctly.
- The input signal should be same as input when you are up-converting an input signal with this receiver (page 33).

The source image input from the HDMI jack is not output from the receiver or the TV speaker connected to the receiver.

- Make sure that cables are correctly and securely connected to components.
- Depending on the playback component, component may need to be set up. Refer to the operating instructions supplied with the each component.

Recording cannot be carried out.

- Check that the components are connected correctly (page 24).
- Select the source component using INPUT SELECTOR (page 47).

Tuner

The FM reception is poor.

- Use a 75-ohm coaxial cable (not supplied) to connect the receiver to an outdoor FM antenna (aerial) as shown below. If you connect the receiver to an outdoor antenna (aerial), ground it against lightning. To prevent a gas explosion, do not connect the ground (earth) wire to a gas pipe.

Outdoor FM antenna (aerial)

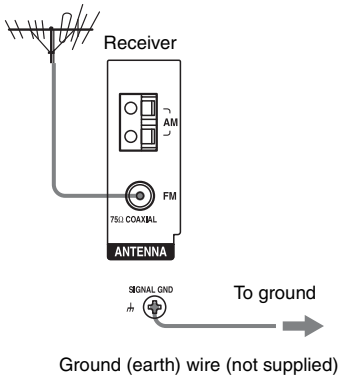

Radio stations cannot be tuned in.

- Check that the antennas (aerials) are connected securely. Adjust the antennas (aerials) and connect an external antenna (aerial), if necessary.
- The signal strength of the stations is too weak (when tuning in with automatic tuning). Use direct tuning.
- Make sure you set the tuning interval correctly (when tuning in AM stations with direct tuning).
- No stations have been preset or the preset stations have been cleared (when tuning by scanning preset stations). Preset the stations (page 80).

- Press DISPLAY so that the frequency appears on the display.

RDS does not work.

- Make sure that you are tuned to an FM RDS station.
- Select a stronger FM station.

The RDS information that you want does not appear.

- Contact the radio station and find out whether or not they actually provide the service in question. If so, the service may be temporarily out of order.

Remote control

The remote does not function.

- Point the remote at the remote sensor on the receiver.
- Remove any obstacles in the path between the remote and the receiver.
- Replace all the batteries in the remote with new ones, if they are weak.
- Make sure that the command modes of the receiver and the remote are the same. If the command mode of the receiver and the remote are different, you cannot operate the receiver with the remote (page 37).
- Make sure you select the correct input on the remote.
- When you operate a programmed non-Sony component, the remote may not function properly depending on the model and the maker of the component.

Error message

If there is a malfunction, the display shows a code of two numbers and a message. You can check the condition of the system by the message. Refer to the following table to solve the problem. If any problem persists, consult your nearest Sony dealer.

PROTECTOR

Irregular current is being output from the speakers, or the upper panel of the receiver is covered with something. The receiver will automatically turn off after a few seconds. Check the speaker connection and turn on the power again.

Reference sections for clearing the memory

To clear	See
All memorized settings	page 36
Customized sound fields	page 76

Specifications

Amplifier section

POWER OUTPUT

Rated Power Output at Stereo Mode^{1) 2)}

(8 ohms 1 kHz, THD 0.7%):

105 W + 105 W

Rated Power Output at Stereo Mode²⁾

(4 ohms 1 kHz, THD 0.7%):

105 W + 105 W

Reference Power Output

(8 ohms 20 Hz – 20 kHz, THD 0.09%)

FRONT²⁾:

100 W + 100 W

CENTER²⁾:

100 W

SURROUND²⁾:

100 W + 100 W

SURROUND BACK²⁾:

100 W + 100 W

Reference Power Output

(4 ohms 20 Hz – 20 kHz, THD 0.15%)

FRONT²⁾:

100 W + 100 W

CENTER²⁾:

100 W

SURROUND²⁾:

100 W + 100 W

SURROUND BACK²⁾:

100 W + 100 W

Reference Power Output at Stereo Mode^{1) 2)}

(8 ohms 1 kHz, THD 10%):

130 W + 130 W

Reference Power Output at Stereo Mode²⁾

(4 ohms 1 kHz, THD 10%):

130 W + 130 W

Reference Power Output

(8 ohms 1 kHz, THD 10%)
FRONT²⁾:
130 W + 130 W
CENTER²⁾:
130 W
SURROUND²⁾:
130 W + 130 W
SURROUND BACK²⁾:
130 W + 130 W

Reference Power Output

(4 ohms 1 kHz, THD 10%)
FRONT²⁾:
130 W + 130 W
CENTER²⁾:
130 W
SURROUND²⁾:
130 W + 130 W
SURROUND BACK²⁾:
130 W + 130 W

¹⁾Depending on the sound field settings and the source, there may be no sound output.

²⁾Measured under the following conditions:

Power requirements: 230 V AC, 50/60 Hz
(in countries/areas in Europe other than the U.K.)
240 V AC, 50/60 Hz
(in the U.K. and general area)

Frequency response

PHONO	RIAA equalization curve ± 0.5 dB
MULTI CHANNEL INPUT, SA-CD/CD, MD/TAPE, DVD, VIDEO 1/2/3	10 Hz – 100 kHz ± 3 dB

Inputs (Analog)

PHONO	Sensitivity: 2.5 mV Impedance: 50 kohms S/N: 86 dB (A, 20 kHz LPF)
MULTI CHANNEL INPUT, SA-CD/CD, MD/TAPE, DVD, TV/SAT, VIDEO1/2/3	Sensitivity: 150 mV Impedance: 50 kohms S/N: 96 dB (A, 20 kHz LPF)

Inputs (Digital)

DVD, SA-CD/CD (Coaxial)	Impedance: 75 ohms S/N: 96 dB (A, 20 kHz LPF)
VIDEO 1/3, TV/SAT, MD/TAPE (Optical)	S/N: 96 dB (A, 20 kHz LPF)

Outputs

MD/TAPE, VIDEO1/2 (AUDIO OUT)	Voltage: 150 mV Impedance: 1 kohms
FRONT L/R, CENTER, SURROUND L/R, SURROUND BACK L/R, SUB WOOFER	Voltage: 2 V Impedance: 1 kohms

EQUALIZER

Gain levels ±10 dB, 1 dB step

FM tuner section

Tuning range 87.5 - 108.0 MHz
Antenna (aerial) FM wire antenna (aerial)
Antenna (aerial) terminals
75 ohms, unbalanced
Sensitivity
Mono: 18.3 dBf, 2.2 µV/75 ohms
Stereo: 38.3 dBf, 22.5 µV/75 ohms
Usable sensitivity 11.2 dBf, 1 µV/75 ohms

S/N

Mono: 76 dB
Stereo: 70 dB

Harmonic distortion at 1 kHz

Mono: 0.3%
Stereo: 0.5%

Separation 45 dB at 1 kHz

Frequency response 30 Hz – 15 kHz, +0.5/-2 dB

Selectivity 60 dB at 400 kHz

AM tuner section

Tuning range 531 – 1,602 kHz
(With 9-kHz tuning scale)
Antenna (aerial) Loop antenna (aerial)
Usable sensitivity 50 dB µ/m (at 999 kHz)
S/N 54 dB (at 50 mV/m)
Harmonic distortion 0.5% (50 mV/m, 400 Hz)
Selectivity 35 dB

Video section

Inputs/Outputs

Video:	1 Vp-p, 75 ohms
S video:	Y: 1 Vp-p, 75 ohms C: 0.286 Vp-p, 75 ohms

COMPONENT VIDEO:

Y:	1 Vp-p, 75 ohms
P _B /C _B :	0.7 Vp-p, 75 ohms
P _R /C _R :	0.7 Vp-p, 75 ohms
	80 MHz HD Pass Through

General

Power requirements	230 V AC, 50/60 Hz (in countries/areas in Europe other than the U.K.) 240 V AC, 50/60 Hz (in the U.K. and general area)
Power consumption	440 W
Power consumption (during standby mode)	1 W
AC outlets	1 switched, 100 W/0.4A MAX (Models for countries/areas in Europe other than the U.K.)
Dimensions	430 × 175 × 430 mm (width/height/depth) including projecting parts and controls
Mass (Approx.)	15 kg

Supplied accessories

Operating Instructions (this manual)	
Quick Setup Guide (1)	
Optimizer microphone ECM-AC2 (1)	
FM wire antenna (aerial) (1)	
AM loop antenna (aerial) (1)	
AC power cord (mains lead) (1)	
Remote commander RM-AAP015 (1)	
R6 (size-AA) batteries (2)	

Design and specifications are subject to change without notice.

Index

Symbols

⌚ SIGNAL GND terminal 23, 35

Numerics

2CH STEREO mode 73

5.1 channel system 16

7.1 channel system 16

A

A.F.D. 70

AC power cord 36

Adjusting

Audio 62

Equalizer 57

Level 56

Sound effect 76

Speaker 63

Surround 59

System 67

Tuner 61

Video 63

ANALOG DIRECT 74

Auto Calibration 40

AUTO FORMAT DIRECT 69

AUTOBETICAL 78

B

BI-AMP 91

C

CD player 21

Connecting 19

Playback 48

Center frequency 74

Changing the display 89

COMPONENT VIDEO ASSIGN 88

Conversion 33

D

DCS 72

DIGITAL ASSIGN 86

Display 8

Dolby 60, 70

Downmix 73

DTS 60

DVD player/DVD recorder

Connecting 29–30

Playback 49

E

Equalizer 57

Error messages 105

H

HDMI

connecting 25

HDMI ASSIGN 87

I

Initial setup 36

INPUT MODE 85

INPUT SELECTOR 47

L

L.F.E. 10, 63

M

MD deck 20

Menu

Audio Settings 54, 62

Auto Calibration 55

EQ Settings 53, 57

Level Settings 53, 56

Speaker Settings 55, 63

Sur Settings 54, 59

System Settings 55, 67

Tuner Settings 54, 61

Video Settings 54, 63

Muting 47

N

Naming 84

NIGHT MODE 73

O

ON SCREEN 74, 83

R

RDS 81

Recording

Onto a MiniDisc or audio tape 90

Onto a video tape 91

Remote

All clear 97

Before use 37

Operating each component 93

Programming 94

Resetting 105

S

Satellite tuner 31

SB DEC MODE 60

SB DECODING 60

Sleep Timer 90

Sound fields

Customizing 59

Resetting 76

Selecting 71

Speakers

Connecting 17

Levels and balance 74–75

Set the distance 65

Setup 38, 63

SPEAKERS (OFF/A/B/A+B) 39

Super Audio CD player 21

Connecting 22

Playback 48

Surround sound 69

T

TAPE deck 20

TEST TONE 56, 74

Tuner

AM 77

Antennas (aerial) 35

FM 77

Tuning

Automatically 77

Directly 78

Preset stations 79

TV

Connecting 27

V

VCR

Connecting 32

Playback 51

Video game 50

Video signal conversion 33

Free Manuals Download Website

<http://myh66.com>

<http://usermanuals.us>

<http://www.somanuals.com>

<http://www.4manuals.cc>

<http://www.manual-lib.com>

<http://www.404manual.com>

<http://www.luxmanual.com>

<http://aubethermostatmanual.com>

Golf course search by state

<http://golfingnear.com>

Email search by domain

<http://emailbydomain.com>

Auto manuals search

<http://auto.somanuals.com>

TV manuals search

<http://tv.somanuals.com>