

FM Stereo FM/AM Receiver

Operating Instructions

Owner's Record

The model and serial numbers are located on the rear of the unit. Record the serial number in the space provided below. Refer to them whenever you call upon your Sony dealer regarding this product.

Model No. _____ Serial No. _____

STR-DA3100ES

WARNING

To prevent fire or shock hazard, do not expose the unit to rain or moisture.

To prevent fire, do not cover the ventilation of the apparatus with news papers, table-cloths, curtains, etc. And don't place lighted candles on the apparatus.

To prevent fire or shock hazard, do not place objects filled with liquids, such as vases, on the apparatus.

Do not install the appliance in a confined space, such as a bookcase or built-in cabinet.



Don't throw away batteries with general house waste; dispose of them correctly as chemical waste.

For customers in the United States

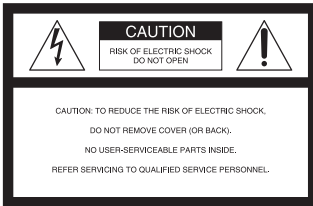

This symbol is intended to alert the user to the presence of uninsulated "dangerous voltage" within the product's enclosure that may be of sufficient magnitude to constitute a risk of electric shock to persons.



This symbol is intended to alert the user to the presence of important operating and maintenance (servicing) instructions in the literature accompanying the appliance.

WARNING

This equipment has been tested and found to comply with the limits for a Class B digital device, pursuant to Part 15 of the FCC Rules. These limits are designed to provide reasonable protection against harmful interference in a residential installation. This equipment generates, uses, and can radiate radio frequency energy and, if not installed and used in accordance with the instructions, may cause harmful interference to radio communications. However, there is no guarantee that interference will not occur in a particular installation. If this equipment does cause harmful interference to radio or television reception, which can be determined by turning the equipment off and on, the user is encouraged to try to correct the interference by one or more of the following measures:

- Reorient or relocate the receiving antenna.
- Increase the separation between the equipment and receiver.
- Connect the equipment into an outlet on a circuit different from that to which the receiver is connected.
- Consult the dealer or an experienced radio/TV technician for help.

CAUTION

You are cautioned that any changes or modification not expressly approved in this manual could void your authority to operate this equipment.

Note to CATV system installer:

This reminder is provided to call CATV system installer's attention to Article 820-40 of the NEC that provides guidelines for proper grounding and, in particular, specifies that the cable ground shall be connected to the grounding system of the building, as close to the point of cable entry as practical.

For customer in Canada

CAUTION

TO PREVENT ELECTRIC SHOCK, MATCH WIDE BLADE OF PLUG TO WIDE SLOT, FULLY INSERT.



ENERGY STAR® is a U.S. registered mark. As an ENERGY STAR® partner, Sony Corporation has determined that this product meets the ENERGY STAR® guidelines for energy efficiency.

About This Manual

- The instructions in this manual are for model STR-DA3100ES. Check your model number by looking at the lower right corner of the front panel.
- The instructions in this manual describe the controls on the receiver. You can also use the controls on the supplied remote if they have the same or similar names as those on the receiver. For details on the use of your remote, see:-
RM-AAE001 (page 56–66)
RM-US106A (page 67–71)

About area codes

The area code of the receiver you purchased is shown on the upper right portion of the rear panel (see the illustration below).

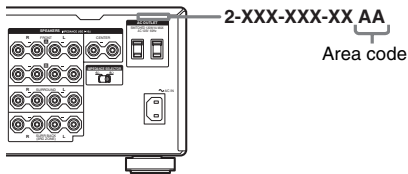

Any differences in operation, according to the area code, are clearly indicated in the text, for example, "Models of area code AA only".

This receiver incorporates Dolby* Digital and Pro Logic Surround and the DTS** Digital Surround System.

- * Manufactured under license from Dolby Laboratories.
"Dolby", "Pro Logic", "Surround EX" and the double-D symbol are trademarks of Dolby Laboratories.
- ** "DTS", "DTS-ES Extended Surround", and "Neo:6" are trademarks of Digital Theater Systems, Inc.

Table of Contents

Getting Started

- 1: Check how to hookup your components 5
 - 1a: Connecting components with digital audio output jacks 7
 - 1b: Connecting components with multi channel output jacks 10
 - 1c: Connecting components with only analog audio jacks 12
- 2: Connecting the antennas 14
- 3: Connecting speakers 15
- 4: Connecting the AC power cord 19
- 5: Setting up the speakers 20
- 6: Adjusting the speaker levels and balance 23
 - TEST TONE

Amplifier Operation

- Selecting the component 24
- Listening to multi channel sound 24
 - MULTI CH IN (DIRECT)
- Listening to FM/AM radio 25
- Presetting radio stations 26
- Changing the display 27
- About the indications in the display 28

Enjoying Surround Sound

- Using only the front speakers 30
- Enjoying higher fidelity sound 30
 - AUTO FORMAT DIRECT
- Selecting a sound field 32
- Selecting the surround back decoding mode 34
 - SURR BACK DECODING
- Setting the Surround Back Decoding Mode (SB DEC MODE) 35

Advanced Adjustments and Settings

- Assigning the audio input 37
 - DIGITAL ASSIGN
- Assigning the component video input 38
 - COMPONENT VIDEO ASSIGN
- Switching the audio input mode for digital components 38
 - INPUT MODE

- Customizing sound fields 39
- Adjusting the equalizer 40
- Advanced settings 41
- Custom install mode 47
- Storing the adjusted settings 48
 - USER PRESET

Other Operations

- Naming preset stations and inputs 49
- Changing the command mode of the receiver 50
- Using the Sleep Timer 50
- Selecting the speaker system 51
- Recording 51
- Listening to the sound in another zone 53
- CONTROL S Control System 55

Operations Using the Remote RM-AAE001

- Before you use your remote 56
- Remote button description 56
- Selecting the command mode of the remote 61
- Programming the remote 61
- Learning the commands of your components 64
- Performing several commands in sequence automatically (Macro Play) 66

Operations Using the Remote RM-US106A

- Before you use your remote 67
- Remote button description 67
- Changing button assignments 69
- 2nd (3rd) zone operations 71

Additional Information

- Precautions 72
- Troubleshooting 73
- Specifications 75
- List of button locations and reference pages 78
- Index Back cover

1: Check how to hookup your components

Steps 1a through 1c beginning on page 7 describe how to hook up your components to this receiver. Before you begin, refer to “Connectable components” below for the pages which describe how to connect each component.

After hooking up all your components, proceed to “2: Connecting the antennas” (page 14).

Connectable components

Component to be connected	Page
DVD player	
With digital audio output ^{a)}	7–8
With multi-channel audio output ^{b)}	10–11
With analog audio output only ^{c)}	7–8
TV monitor	
With component video input ^{d)}	8 or 11
With S-Video or composite video input only	13
Satellite tuner	
With digital audio output ^{a)}	7–8
With analog audio output only ^{c)}	7–8
Super Audio CD/CD player	
With digital audio output ^{a)}	9
With multi-channel audio output ^{b)}	10
With analog audio output only ^{c)}	12
MD/DAT deck	
With digital audio output ^{a)}	9
With analog audio output only ^{c)}	12
Tape deck, Analog disc turntable	12
Multi-channel decoder	10
VCR, video camera, video game, etc.	13

- a) Model with a DIGITAL OPTICAL OUTPUT or DIGITAL COAXIAL OUTPUT jack, etc.
 b) Model with MULTI CH OUTPUT jacks, etc. This connection is used to output the audio decoded by the component’s internal multi-channel decoder through this receiver.
 c) Model equipped only with AUDIO OUT L/R jacks, etc.
 d) Model with component video (Y, P_B/C_B/B-Y, P_R/C_R/R-Y) input jacks.

Required cords

The hookup diagrams on the subsequent pages assume the use of the following optional connection cords (**A** to **H**) (not supplied).

A Audio cord

White (L)
Red (R)



B Audio/video cord

Yellow (video)
White (L/audio)
Red (R/audio)



C Video cord

Yellow



D S-video cord



E Optical digital cord



F Coaxial digital cord



G Monaural audio cord

Black



Tip

Audio cord **A** can be torn into two monaural audio cords **G**.

H Component video cord

Green
Blue
Red

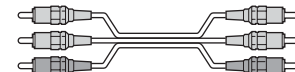

Notes

- Turn off the power to all components before making any connections.
- Be sure to make connections firmly to avoid hum and noise.
- When connecting an audio/video cord, be sure to match the color-coded pins to the appropriate jacks on the components: yellow (video) to yellow; white (left, audio) to white; and red (right, audio) to red.
- When connecting optical digital cords, insert the cord plugs straight in until they click into place.
- Do not bend or tie optical digital cords.

If you have Sony components with CONTROL S jacks

See “CONTROL S Control System” on page 55.

1a: Connecting components with digital audio output jacks

Hooking up a DVD player, TV monitor, or satellite tuner

For details on the required cords (A–H), see page 6.

1 Connect the audio jacks.

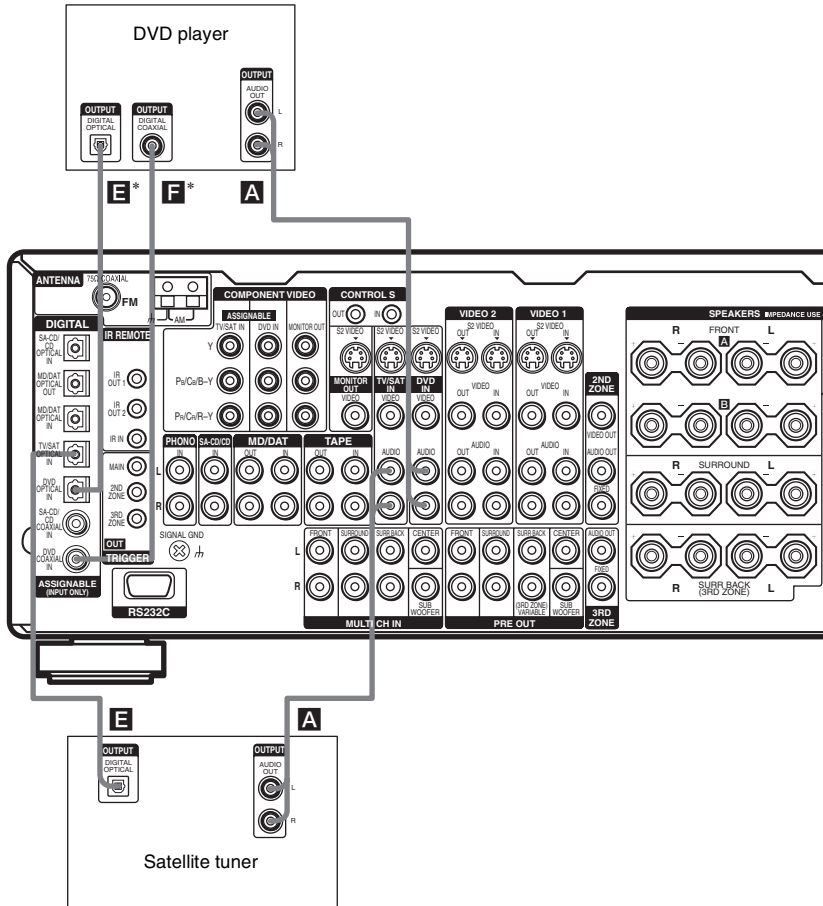

* Connect to either the DVD COAXIAL IN or the DVD OPTICAL IN jack. We recommend making connections to the DVD COAXIAL IN jack.

Note

You can listen to the sound of your TV by connecting your TV's audio output jacks to the TV/SAT AUDIO IN jacks on the receiver. In this case, do not connect the TV's video output jack to the TV/SAT VIDEO IN jack on the receiver.

continued

2 Connect the video jacks.

The following illustration shows how to connect a TV or satellite tuner and a DVD player with COMPONENT VIDEO (Y, P_B/C_B/B-Y, P_R/C_R/R-Y) output jacks. Connecting a TV with component video input jacks allows you to enjoy higher quality video. You can upconvert the video signals, and adjust the hue, etc. of the converted signals (page 43).

Notes

- On this receiver, standard video signals can be converted to component video or S-video signals, and S-video signals can be converted to component video signals. However, you cannot convert the component video signals to standard video or S-video signals.
- When standard video signals (composite video signals) or S-video signals from a VCR etc. are converted upward on this receiver and then output to your TV, depending on the status of the video signal output, the image on the TV screen may appear distorted horizontally or no image may be output.
- You cannot record the up convert signals from S-VIDEO OUT jacks.
- Depending on the monitor, noise may be produced or the picture may be distorted when the video player is turned on.

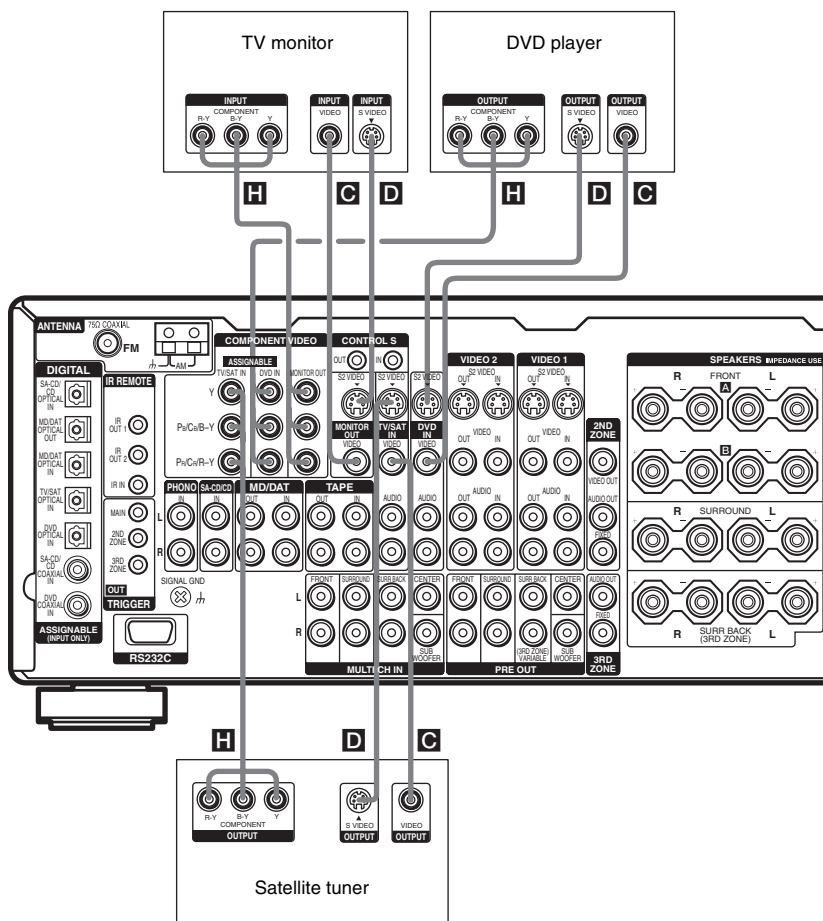

Hooking up a Super Audio CD/CD player or MD/DAT deck

For details on the required cords (A–H), see page 6.

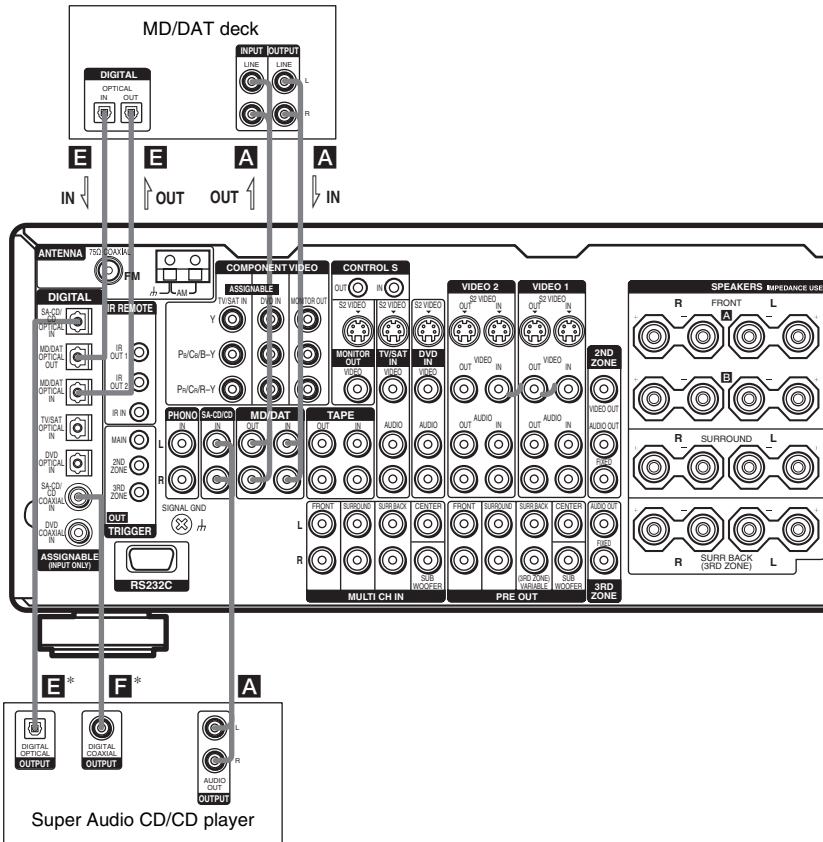

* Connect to either the SA-CD/CD COAXIAL IN or the SA-CD/CD OPTICAL IN jack. We recommend making connections to the SA-CD/CD COAXIAL IN jack.

If you want to connect several digital components, but cannot find an unused input

See “Assigning the audio input” (page 37).

Tips

- All the digital audio jacks are compatible with 32 kHz, 44.1 kHz, 48 kHz and 96 kHz sampling frequencies.
- You can also connect an LD player with a DOLBY DIGITAL RF OUT jack via an RF demodulator (You cannot connect an LD player’s DOLBY DIGITAL RF OUT jack directly to this unit’s digital input jacks). Refer to the operating instructions supplied with the RF demodulator.

Notes

- No sound is output when playing a Super Audio CD disc on a Super Audio CD player connected to the SA-CD/CD OPTICAL or COAXIAL IN jack on this receiver. Connect the player to the analog input jacks (SA-CD/CD IN jacks). Refer to the operating instructions supplied with the Super Audio CD player.
- You cannot make digital recordings of digital multi channel surround signals.

1b: Connecting components with multi channel output jacks

1 Connect the audio jacks.

If your DVD or Super Audio CD player is equipped with multi channel output jacks, you can connect it to this receiver's MULTI CH IN jacks to enjoy the multi channel sound. Alternatively, the multi channel input jacks can be used to connect an external multi channel decoder.

For details on the required cords (**A-H**), see page 6.

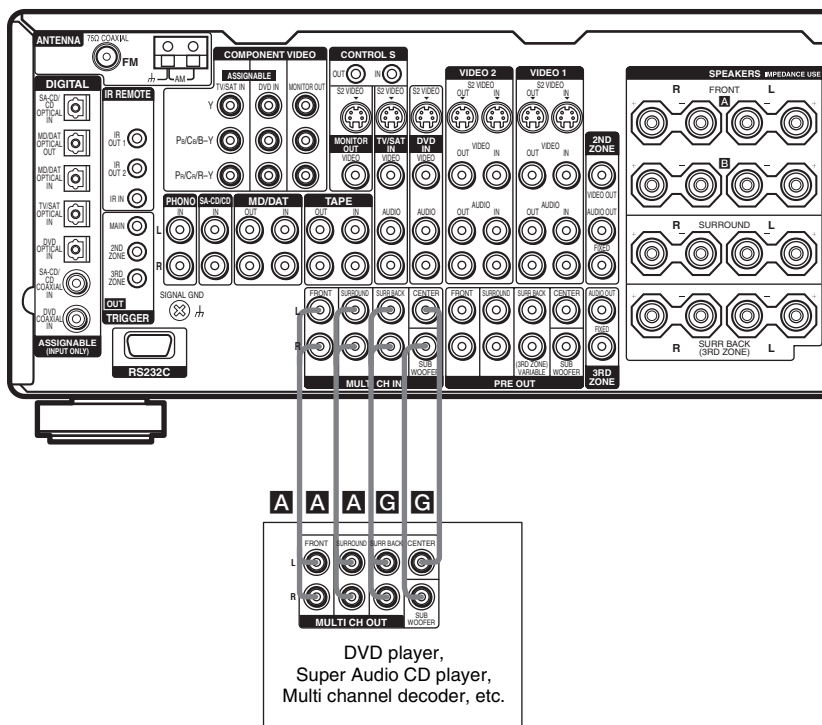

Tip

This connection also allows you to enjoy software with multi-channel audio recorded in formats other than the Dolby Digital and DTS.

Note

DVD and Super Audio CD players do not have SURR BACK terminals.

2 Connect the video jacks.

The following illustration shows how to connect a DVD player with COMPONENT VIDEO (Y, P_B/C_B/B-Y, P_R/C_R/R-Y) output jacks. Connecting a TV with component video input jacks allows you to enjoy higher quality video. You can upconvert the video signals, and adjust the hue, etc. of the converted signals (page 43).

Notes

- On this receiver, standard video signals can be converted to component video or S-video signals, and S-video signals can be converted to component video signals. However, you cannot convert the component video signals to standard video or S-video signals.
- When standard video signals (composite video signals) or S-video signals from a VCR etc. are converted upward on this receiver and then output to your TV, depending on the status of the video signal output, the image on the TV screen may appear distorted horizontally or no image may be output.
- Depending on the monitor, noise may be produced or the picture may be distorted when the video player is turned on.

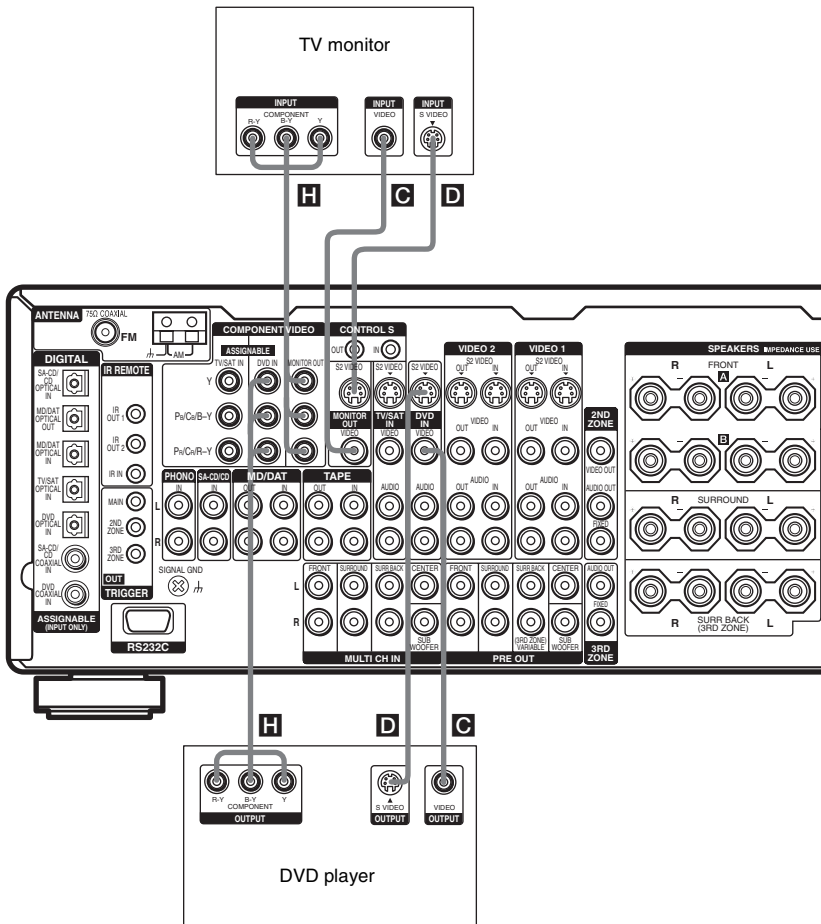

1c: Connecting components with only analog audio jacks

Hooking up audio components

For details on the required cords (**A-H**), see page 6.

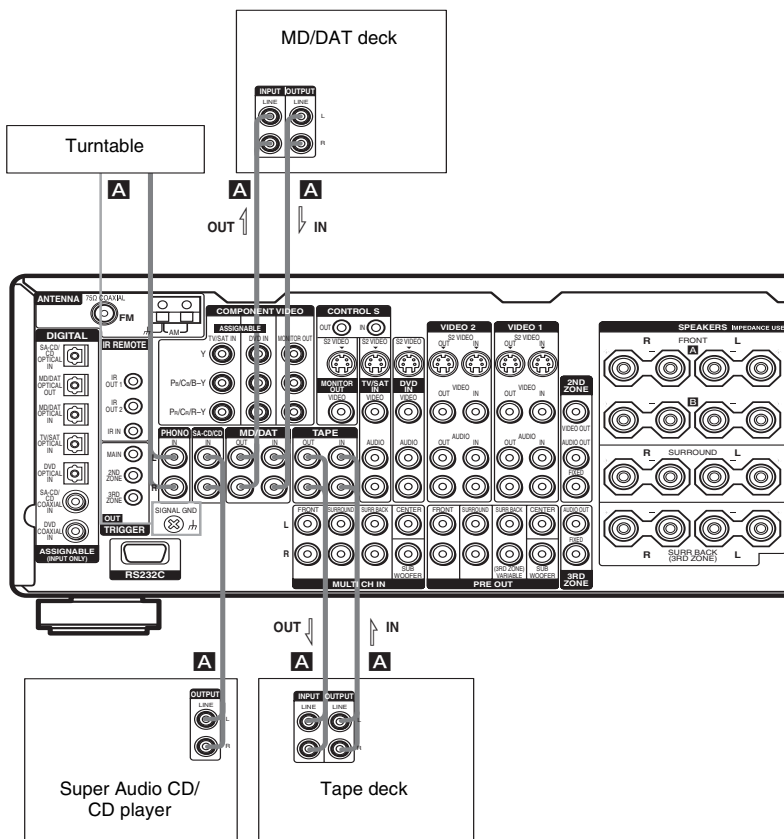

Note

If your turntable has a ground wire, connect it to the \hbar SIGNAL GND terminal.

Hooking up video components

If you connect your TV to the MONITOR jacks, you can watch the video from the selected input (page 24). You can also display the SPEAKER SET UP, LEVEL, SURR SET UP, EQUALIZER, CUSTOMIZE, TUNER, CIS and STREAM INFO menu settings and sound fields on your TV by pressing ON SCREEN on the remote.

For details on the required cords (**A**–**H**), see page 6.

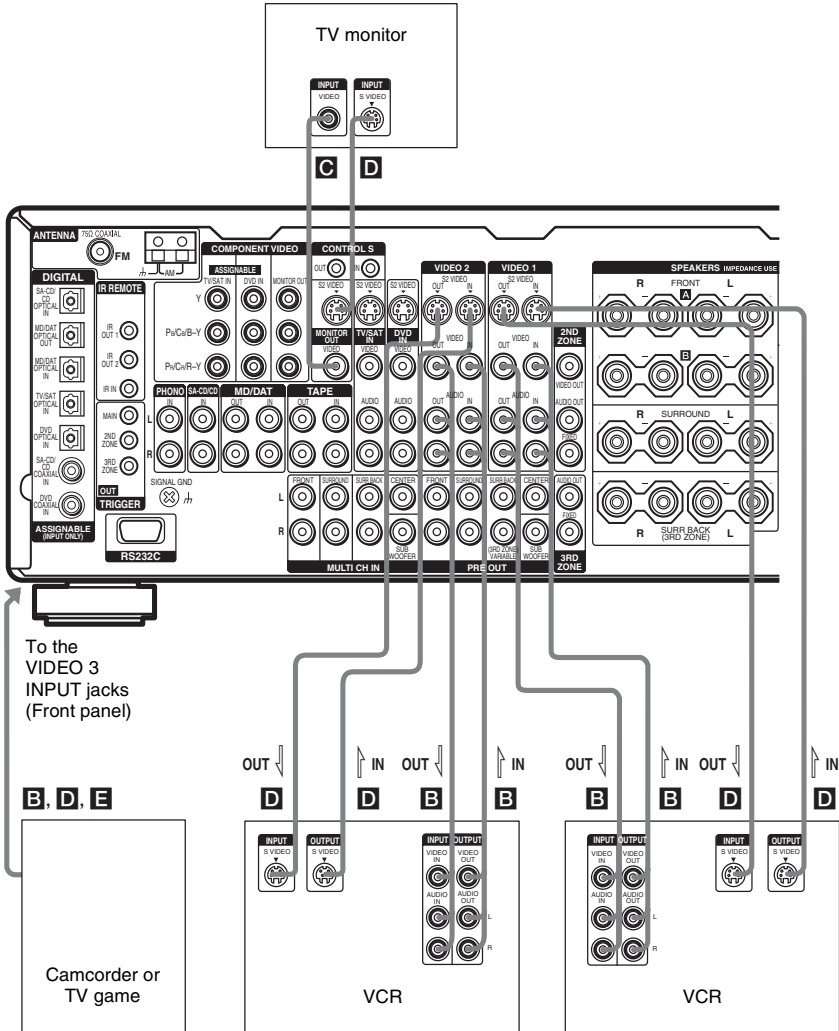

2: Connecting the antennas

Connect the supplied AM loop antenna and FM wire antenna.

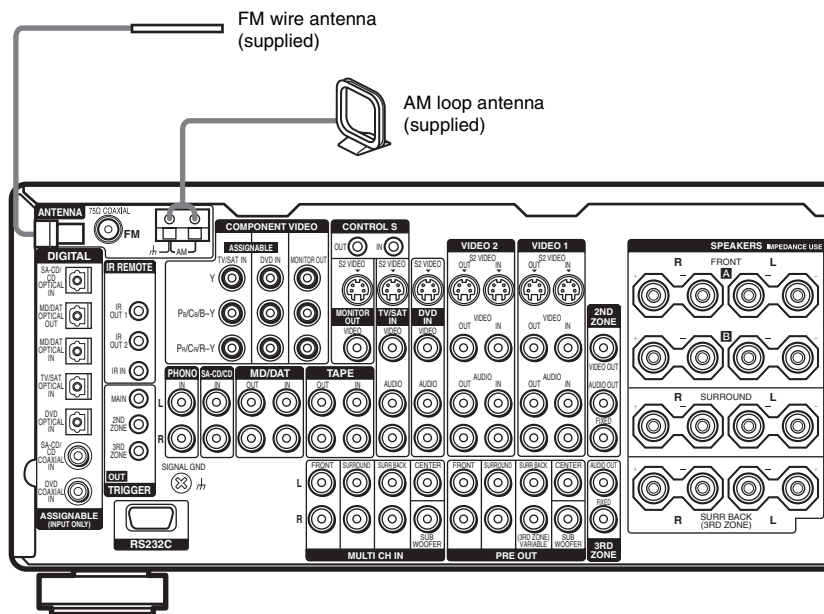

Notes

- To prevent noise pickup, keep the AM loop antenna away from the receiver and other components.
- Be sure to fully extend the FM wire antenna.
- After connecting the FM wire antenna, keep it as horizontal as possible.
- Do not use the ⏏ SIGNAL GND terminal for grounding the receiver.

3: Connecting speakers

Connect your speakers to the receiver. This receiver allows you to use a 9.1 channel system.

To fully enjoy theater-like multi channel surround sound requires five speakers (two front speakers, a center speaker, and two surround speakers) and a sub woofer (5.1 channel).

You can enjoy high fidelity reproduction of DVD software recorded in the Surround EX format if you connect one additional surround back speaker (6.1 channel) or two surround back speakers (7.1 channel) (see “Selecting the surround back decoding mode” on page 34).

You can even enjoy the 9.1 channel surround sound by connecting four surround speakers (see “9.1 CH SP SYSTEM” on page 42).

Example of 7.1 channel speaker system configuration

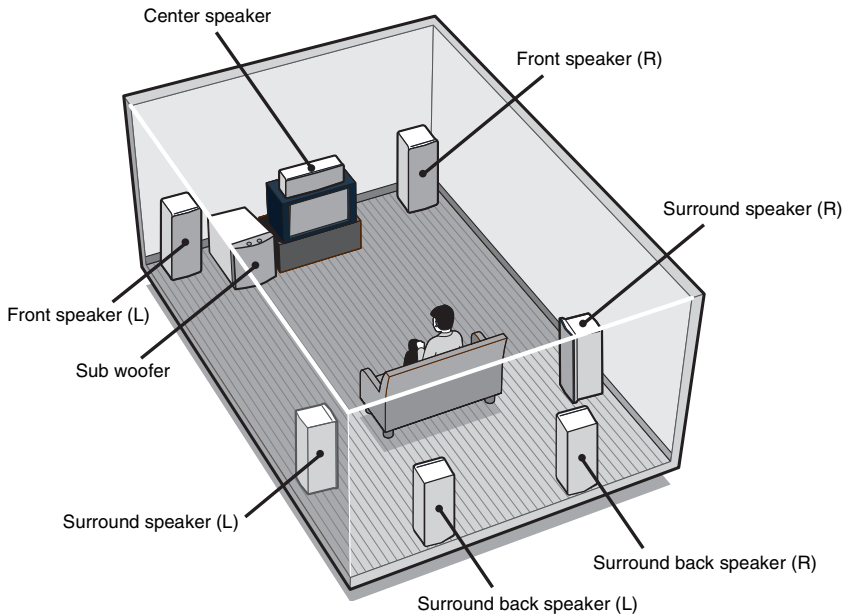

Tips

- When you connect 6.1 channel speaker system, place the surround back speaker behind the listening position (see “When placing only one surround back speaker” on page 21).
- Since the sub woofer does not emit highly directional signals, you can place it wherever you want.

continued

15^{US}

Required cords

A Speaker cords (not supplied)



B Monaural audio cord (not supplied)

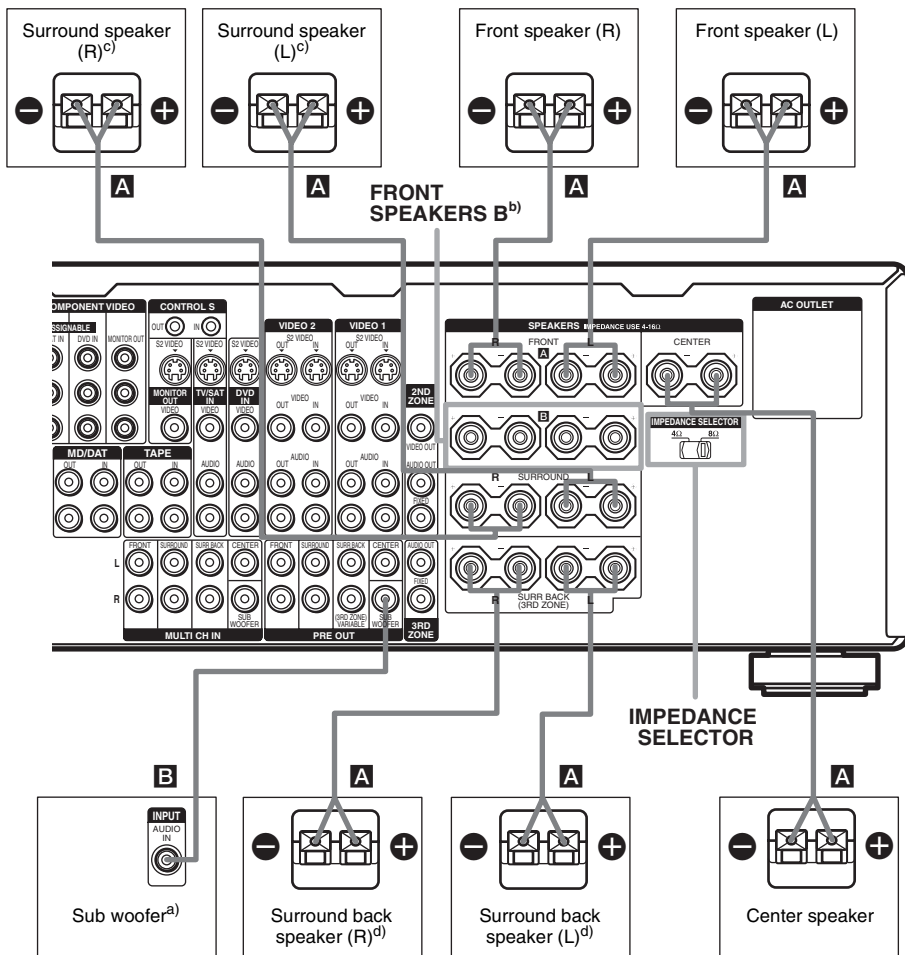

- a) When you connect a sub woofer with an auto standby function, turn off the function when watching movies.
- b) You can select the front speakers you want to use with SPEAKERS FRONT. For details, see “Selecting the speaker system” (page 51).
- c) You can connect two pairs of surround speakers to the SPEAKERS SURROUND jacks in parallel and select the surround speakers you want to use with SPEAKERS SURROUND. For details, see “9.1 CH SP SYSTEM” (page 42).
- d) If you connect only one surround back speaker, connect it to the SPEAKERS SURR BACK (3RD ZONE) L terminal. You can use the surround back speakers as a front right and front left speakers in the 3RD ZONE (page 17).

Tip

To connect certain speakers to another power amplifier, use the PRE OUT jacks. The same signal is output from both the SPEAKERS jacks and the PRE OUT jacks. For example, if you want to connect just the front speakers to another amplifier, connect that amplifier to the PRE OUT FRONT L and R jacks.

3RD ZONE hookup

You can use the surround back speakers as right and left speakers in the 3rd zone (see page 53). Make sure to connect correctly as indicated on the rear panel.

Tip

When outputting the sound in the 3rd zone, the source signal for the 3rd zone is output from PRE OUT SURR BACK jacks.

Speaker impedance

To enjoy the best possible multi channel surround, connect speakers with a nominal impedance of 8 ohms or higher to the FRONT, CENTER, SURROUND and SURROUND BACK terminals, and set the IMPEDANCE SELECTOR to "8Ω". Use the screwdriver to set the impedance selector to the correct position. Refer to the operating instructions supplied with your speakers if you are not sure of their impedance. (This information is often on the back of the speaker.)

Alternatively, you may connect speakers with nominal impedances between 4 and 8 ohms to any or all of the speaker terminals. However, be sure to set the IMPEDANCE SELECTOR to "4Ω" if you connect even one speaker with nominal impedance between 4 and 8 ohms.

Note

Be sure to turn the power off before adjusting the IMPEDANCE SELECTOR.

Enjoying the 9.1 channel speaker system

What is the 9.1 channel speaker system?

A large dubbing theater for recording movie soundtracks uses 10 surround speakers. However, in a small dubbing theater, only 2 speakers each are placed on the right, left, and back walls. Thus, the minimum setup for a dubbing theater is 9.1 channels. When 9.1 CH SP SYSTEM is set to YES, you can enjoy 9.1 channel speaker operation, just like a dubbing theater.

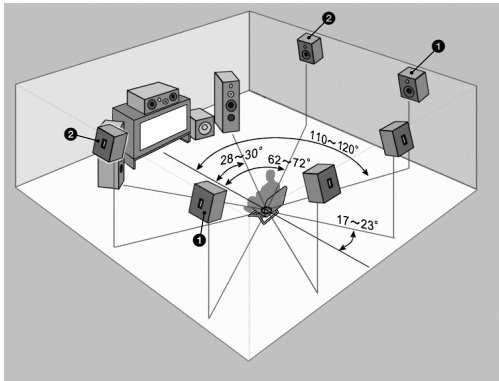

Arrange the speakers around the center of the room based on the angles shown in the illustration on the left. If you are unable to position the speakers according to the angles shown, place one set of surround speakers slightly forward of the listening position (toward the front speakers).

Although the center of the room is used as an axis for determining speaker placement, 9.1 channel speaker operation covers an extremely wide listening area which you can enjoy from anywhere in the room behind the central point.

When using the CINEMA STUDIO EX modes with the 9.1 channel system, be sure to set Virtual Speaker to OFF in SURR SET UP. (You can enjoy the surround effects of movies even without the use of virtual speakers since so many real speakers are used.)

In addition, unlike virtual speakers, the expressive capability of real speakers will vary depending on the speaker. Adjust the effect level so that the actor's lines sound natural and the impact of sound effects is nicely balanced.

The advantage of a 9.1 channel speaker system is a drastic improvement in the connection between the front (video) sound field and the surround sound field. Previously, we have employed virtual speaker technology to present this sound effect, but a real 9.1 channel multi channel surround system has a much wider effect area so that all family members can enjoy the surround effect. Of course, when seated in the middle of the listening position, you can enjoy the sound exactly as the movie director listened.

Tips for placing speakers

Place surround speakers ② between the front speakers and the listening position. Adjusting the position of these speakers improves the connection between the front and surround sound stage.

Tips for using the 9.1 channel speaker system

You can also use the CINEMA STUDIO EX modes with the 9.1 channel speaker system. In this case, the number of virtual surround speakers doubles (for a total of 12 virtual surround speakers).

However, this large number of speakers may narrow the surround effect area. Thus, it may be more effective to set "VIR.SPEAKERS" in the SURR SET UP menu to "OFF".

Please note that in most cases you can use the 9.1 channel setting for Super Audio CD and other pure audio sources without any adjustments. However, depending on the type of speakers you have and the way the music software was recorded, you may want to switch to 7.1 channel or 5.1 channel playback.

4: Connecting the AC power cord

Connect the supplied AC power cord to the AC IN terminal on the receiver, then connect the AC power cord to a wall outlet.

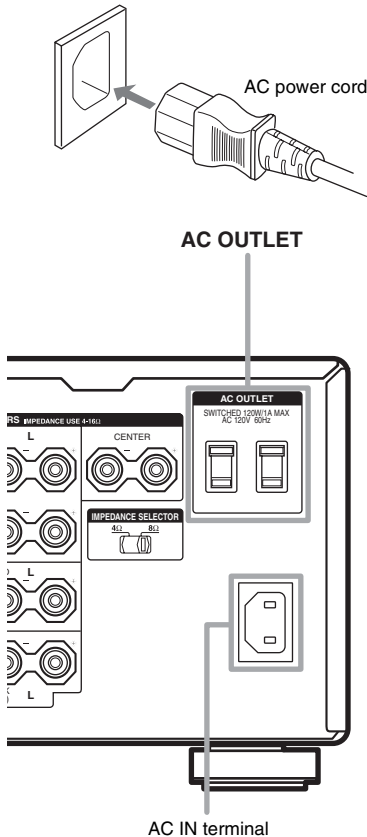

Before using the receiver

Performing initial setup operations

Before using the receiver for the first time, initialize the receiver by performing the following procedure.

This procedure can also be used to return settings you have made to their factory defaults.

- 1 Press I/⏻ on the receiver to turn off the receiver.
- 2 Hold down I/⏻ on the receiver for 5 seconds.
- 3 While “ENTER to Clear All” appears in the display, press MEMORY/ENTER on the receiver.

After “MEMORY CLEARING...” appears in the display for a while, “MEMORY CLEARED!” appears.

The following are reset to their factory settings.

- MASTER VOLUME.
- All settings in the SPEAKER SET UP, LEVEL, SURR SET UP, EQUALIZER, CUSTOMIZE, TUNER and CIS menus.
- The sound field memorized for each input and preset station.
- All preset stations.
- All index names for inputs and preset stations.

Notes

- The AC OUTLETs on the rear of the receiver is a switched outlet, which supplies power to the connected component only while the receiver is turned on.
- Make sure that the total power consumption of the components connected to the receiver’s AC OUTLETs does not exceed the wattage stated on the rear panel. Do not connect high-wattage electrical home appliances such as electric irons, fans, or TVs to this outlet. This may cause a malfunction.

5: Setting up the speakers

You can use the SPEAKER SET UP menu to set the size and distance of the speakers connected to this system.

1 Press I/⏻ to turn on the system.

2 Rotate MAIN MENU to select “SPEAKER SET UP”.

3 Rotate MENU to select the menu item you want.

For more information, see “Speaker setup parameters”.

Notes

- Certain setup parameters may be dimmed in the display. This means that the selected parameter is either unavailable or fixed and unchangeable due to sound field (pages 32–34) or other settings.
- Some speaker setup items may appear dimmed in the display. This means that they have been adjusted automatically due to other speaker settings. Depending on the settings, you may or may not be able to adjust certain speakers.

4 Rotate –/+ to select the parameter.

5 Repeat steps 3 and 4 until you have set all of the items that follow.

Speaker setup parameters

The initial settings are underlined.

■ SP EASY SET UP (Speaker easy setup)

- YES

You can set up your speakers automatically by selecting a pre-defined speaker pattern (see the supplied “Easy Setup Guide”).

- NO

Select to adjust the settings of each speaker manually.

■ SPEAKER PATTERN (Speaker setup pattern)

When “SP EASY SET UP” is set to “YES”, select the speaker setup pattern. Rotate –/+ to select the speaker setup pattern and press MEMORY/ENTER to enter the selection. Check your speaker pattern using the supplied “Easy Setup Guide”.

■ SUB WOOFER (Sub woofer)

- YES

If you connect a sub woofer, select “YES”.

- NO

If you did not connect a sub woofer, select “NO”. This activates the bass redirection circuitry and outputs the LFE signals from other speakers.

■ FRONT SP (Front speakers)

- LARGE

If you connect large speakers that will effectively reproduce bass frequencies, select “LARGE”. Normally, select “LARGE”.

When the sub woofer is set to “NO”, front speakers are automatically set to “LARGE”.

- SMALL

If the sound is distorted, or you feel a lack of surround effects when using multi channel surround sound, select “SMALL” to activate the bass redirection circuitry and output the front channel bass frequencies from the sub woofer. When the front speakers are set to “SMALL”, the center, surround and surround back speakers are also automatically set to “SMALL” (unless previously set to “NO”).

■ CENTER SP (Center speaker)

- LARGE

If you connect a large speaker that will effectively reproduce bass frequencies, select “LARGE”. Normally, select “LARGE”.

However, if the front speakers are set to “SMALL”, you cannot set the center speaker to “LARGE”.

- SMALL

If the sound is distorted, or you feel a lack of surround effects when using multi channel surround sound, select “SMALL” to activate the bass redirection circuitry and output the center channel bass frequencies from the front speakers (if set to “LARGE”) or sub woofer.

- NO or MIX

If you did not connect a center speaker, select “NO” or “MIX”. When set to “MIX”, the sound of the center speaker can be output from the front speakers without deteriorating the sound quality. The sound of the center channel will be output from the front speakers. When the multi channel input is selected. Whether the setting is “NO” or “MIX”.

■ SURROUND SP (Surround speakers)

The surround back speakers are set to the same setting.

- LARGE

If you connect large speakers that will effectively reproduce bass frequencies, select “LARGE”. Normally, select “LARGE”. However, if the front speakers are set to “SMALL”, you cannot set the surround speakers to “LARGE”.

- SMALL

If the sound is distorted, or you feel a lack of surround effects when using multi channel surround sound, select “SMALL” to activate the bass redirection circuitry and output the surround channel bass frequencies from the sub woofer or other “LARGE” speakers.

- NO

If you did not connect surround speakers, select “NO”.

■ SURR BACK SP (Surround back speakers)

When the surround speakers size parameter is set to “NO”, the surround back speakers selection parameter is also automatically set to “NO” and the setting cannot be changed.

- DUAL

If you connect two surround back speakers, select “DUAL”. The sound will be output to a maximum of 7.1 channels.

- SINGLE

If you connect only one surround back speaker, select “SINGLE”. The sound will be output to a maximum of 6.1 channels.

- NO

If you did not connect surround back speakers, select “NO”.

- ZONE-3

If you use the surround back speaker in the 3rd zone, select “ZONE-3”.

Tip

The “LARGE” and “SMALL” settings for each speaker determine whether or not the internal sound processor will cut the bass signal from that channel. When the bass is cut from a channel, the bass redirection circuitry sends the corresponding bass frequencies to the sub woofer or other “LARGE” speakers.

However, it best not to cut them, if possible. Therefore, even when using small speakers, you can set them to “LARGE” if you want to output the bass frequencies from that speaker. On the other hand, if you are using a large speaker, but prefer not to have bass frequencies output from that speaker, set it to “SMALL”.

If the overall sound level is lower than you prefer, set all speakers to “LARGE”. If there is not enough bass, you can use the equalizer to boost the bass levels. To adjust the equalizer, see page 40.

■ FRONT XX feet (Front speaker distance)

Initial setting: 10 feet

Lets you set the distance from your listening position to the front speakers (A). You can adjust from 3 to 23 feet in 1 foot steps.

If both front speakers are not placed an equal distance from your listening position, set the distance to the closest speaker.

When placing only one surround back speaker

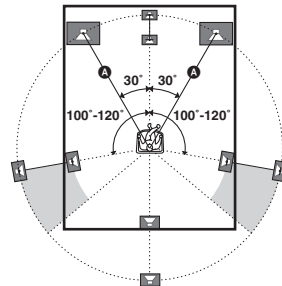

continued

When placing two surround back speakers
(The angle **B** should be the same)

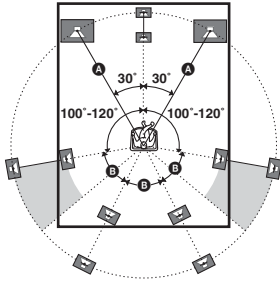

■ **CENTER XX feet**
(Center speaker distance)

Initial setting: 10 feet

Lets you set the distance from your listening position to the center speaker. You can adjust from 3 to 23 feet in 1 foot steps.

■ **SURROUND XX feet**
(Surround speaker distance)

Initial setting: 10 feet

Lets you set the distance from your listening position to the surround speakers. You can adjust from 3 to 23 feet in 1 foot steps.

If both surround speakers are not placed an equal distance from your listening position, set the distance to the closest speaker.

■ **SURR BACK XX feet**
(Surround back speaker distance)

Initial setting: 10 feet

Lets you set the distance from your listening position to the surround back speaker. You can adjust from 3 to 23 feet in 1 foot steps.

If you connect two surround back speakers and both surround back speakers are not placed an equal distance from your listening position.

■ **SUB WOOFER XX feet**
(Sub woofer distance)

Initial setting: 10 feet

Lets you set the distance from your listening position to the sub woofer. You can adjust from 3 to 23 feet in 1 foot steps.

Tip

The receiver lets you to input the speaker position in terms of distance. However, it is not possible to set the center speaker further than the front speakers. Also, the center speaker cannot be set more that 5 feet closer than the front speakers.

Likewise, the surround speakers can not be set farther away from the listening position than the front speakers. And they can be no more than 15 feet closer. This is because incorrect speaker placement is not conducive to the enjoyment of surround sound.

Please note that, setting the speaker distance closer than the actual location of the speakers will cause a delay in the output of the sound from that speaker. In other words, the speaker will sound like it is farther away.

For example, setting the center speaker distance 3–6 feet closer than the actual speaker position will create a fairly realistic sensation of being “inside” the screen.

If you cannot obtain a satisfactory surround effect because the surround speakers are too close, setting the surround speaker distance closer (shorter) than the actual distance will create a larger sound stage.

Adjusting these parameter while listening to the sound often results in much better surround sound. Give it a try!

For advanced speaker setups

Use the CUSTOMIZE menu and set “MENU EXPAND” to “ON”. This enables advanced setups including those of the heights of the surround speakers.

For details on “MENU EXPAND”, see page 41. For details on how to set the items, see page 43.

6: Adjusting the speaker levels and balance

— TEST TONE

Adjust the speaker levels and balance while listening the test tone from your listening position. Use the remote for the operation.

Tip

The receiver employs a test tone with a frequency centered at 800 Hz.

- 1** Press **I/⏻** on the remote to turn on the receiver.
- 2** Press **TEST TONE** on the remote.
“TEST TONE” in the LEVEL menu appears in the display and the test tone is output from each speaker in sequence.
- 3** Adjust the speaker level and balance using the LEVEL menu so that the level of the test tone sounds the same from each speaker.

For details on the LEVEL menu settings, see page 39.

Tip

To adjust the level of all speakers at the same time, press MASTER VOL +/- on the remote or turn MASTER VOLUME on the receiver.

- 4** Press **TEST TONE** again.

The test tone turns off.

To output the test tone only from a specific speaker

Set “TEST TONE” in the LEVEL menu to “FIX” (page 39). The test tone is output only from the selected speaker.

For more precise adjustment

You can output the test tone or sound source from two adjacent speakers to adjust their balance and level.

Set “MENU EXPAND” in the CUSTOMIZE menu to “ON” (page 41). Then select the two speakers you want to adjust using “PHASE NOISE” or “PHASE AUDIO” in the LEVEL menu (page 46).

Selecting the component

1 Rotate INPUT SELECTOR to select the input.

The selected input appears in the display.

To select the	Display
VCR	VIDEO 1 or VIDEO 2
Camcorder or TV game	VIDEO 3
DVD player	DVD
Satellite tuner	TV/SAT
Tape deck	TAPE
MD or DAT deck	MD/DAT
Super Audio CD or CD player	SA-CD/CD
Built-in tuner	FM or AM and frequency
Turntable	PHONO

2 Turn on the component and start playback.

3 Rotate MASTER VOLUME to adjust the volume.

To mute the sound

Press MUTING on the remote. To cancel, press MUTING on the remote again or turn MASTER VOLUME clockwise to raise the volume. Even if you turn off the receiver, the muting function works when you turn on the receiver again.

Notes on using headphones

- When headphones are connected, you can select only the following sound fields (page 33).
 - HEADPHONE (2CH)
 - HEADPHONE (DIRECT)
 - HEADPHONE (MULTI)
 - HEADPHONE THEATER
- When headphones are connected and you use the MULTI CH IN function (page 24), the sound of all channels may not output depending on the speaker settings.

Listening to multi channel sound

— MULTI CH IN (DIRECT)

You can select the audio directly from the components connected to the MULTI CH IN jacks. This enables you to enjoy high quality analog inputs like DVD or Super Audio CD. Surround effects are not activated when using this input.

Press MULTI CH IN to select the multi channel audio source.

The selected audio source is output.

When a center speaker or sub woofer is not connected

If you have set the center speaker to “NO” or “MIX”, or set the sub woofer to “NO” in the SPEAKER SET UP menu (page 20), and you activate the MULTI CH IN function, the analog center or sub woofer audio will be output from the front left and right speakers.

Listening to FM/AM radio

You can listen to FM and AM broadcasts through the built-in tuner. Before operation, make sure you have connected the FM and AM antennas to the receiver (see page 14).

Tip

The tuning scale is:

FM: 100 kHz

AM: 10 kHz*

* The AM tuning scale can be changed (see page 76).

Automatic tuning

- 1** Rotate **INPUT SELECTOR** to select tuner (“FM” or “AM”).
- 2** Press **FM/AM** to select “FM” or “AM”.
- 3** Press **TUNING +** or **TUNING -**.

Press **TUNING +** to scan from low to high; press **TUNING -** to scan from high to low.

The receiver stops scanning whenever a station is received.

In case of poor FM stereo reception

If the FM stereo reception is poor and “STEREO” flashes in the display, select monaural audio so that the sound will be less distorted.

- 1** Rotate **MAIN MENU** to select “TUNER”.
- 2** Rotate **MENU** to select “FM MODE”.
- 3** Rotate **-/+** to select “MONO”.

The FM reception switches to monaural.

Direct tuning

You can enter the frequency of the station you want directly. Use the remote for this operation.

- 1** Move the **easy scroll key** to select “TUNER”, then press the key repeatedly to select “FM” or “AM”.
You can also use **INPUT SELECTOR** on the receiver.
- 2** Press **D.TUNING** on the remote.
- 3** Press the **numeric buttons** to enter the frequency.

Example 1: FM 102.50 MHz

Select 1 → 0 → 2 → 5

Example 2: AM 1,350 kHz

Select 1 → 3 → 5 → 0

(You do not have to enter the last “0” when the tuning scale is set to 10 kHz.)

If you have tuned in an AM station, adjust the direction of the AM loop antenna for optimum reception.

If you cannot tune in a station and the entered numbers flash

Make sure you have entered the right frequency. If not, repeat step 3. If the entered numbers still flash, the frequency is not used in your area.

Presetting radio stations

You can preset up to 30 FM or AM stations. Then you can easily tune in the stations you often listen to.

Presetting radio stations

- 1 Rotate INPUT SELECTOR to select tuner (“FM” or “AM”).**
- 2 Press FM/AM to select “FM” or “AM”.**
- 3 Tune in the station that you want to preset using Automatic Tuning (page 25) or Direct Tuning (page 25).**

Switch the FM reception mode if necessary (page 25).
- 4 Press MEMORY/ENTER.**

“MEMORY” appears in the display for a few seconds. Do steps 5 to 6 before the display goes out.
- 5 Press PRESET TUNING + or PRESET TUNING – to select a preset number.**

If you want to switch the memory page, press SHIFT on the remote.
If “MEMORY” goes out before you select the preset number, start again from step 4.
- 6 Press MEMORY/ENTER again.**

The station is stored to the selected preset number.
If “MEMORY” goes out before you press MEMORY/ENTER, start again from step 4.
- 7 Repeat steps 2 to 6 to preset another station.**

Tuning to preset stations

- 1 Rotate INPUT SELECTOR to select tuner (“FM” or “AM”).**
- 2 Press PRESET TUNING + or PRESET TUNING – repeatedly to select the preset station you want.**

Each time you press the button, you can select the preset station as follows:

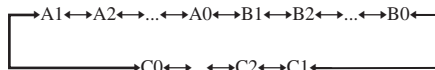

Using the remote

- 1 Move the easy scroll key to select “TUNER”, then press the key repeatedly to select “FM” or “AM”.**
- 2 Press PRESET/CH/D.SKIP +/- repeatedly to select the preset station you want.**

Changing the display

Changing the information in the display

You can check the sound field etc. by changing the information in the display.

Press DISPLAY repeatedly.

Each time you press DISPLAY, the display will change as follows.

All inputs except "FM" and "AM"

Index name and sound field name* ↔ Input name and sound field name

FM and AM

Preset station name and sound field name* ↔ Input name and sound field name

* Index name appears only when you have assigned one to the input or preset station (page 49). Index name does not appear when only blank spaces have been entered, or it is the same as the input name.

Displaying the input stream information

You can check the input stream information (about format, channel, etc.) of digital input signals. The input stream information also appears for 4 seconds when the receiver detects any changes in the digital input signal.

- 1 Rotate MAIN MENU to select "STREAM INFO".**
- 2 Rotate MENU.**
The input stream information appears.
- 3 Rotate -/+ for more information.**



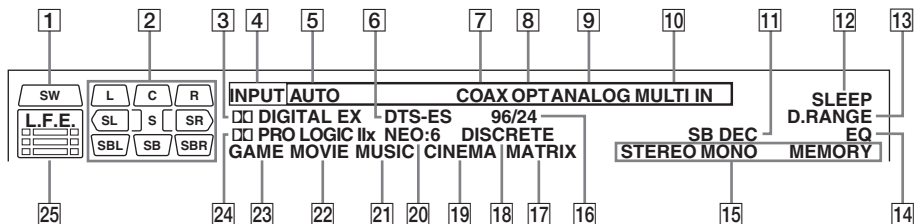

About the indications in the display



- 1 **SW:** Lights up when sub woofer selection is set to “YES” (page 20). While this indicator lights up, the receiver creates a sub woofer signal based on the LFE signal in the disc being played back or the low frequency components of the front channels. This indicator does not light during the 2CH STEREO mode.
- 2 **Playback channel indicators:** The letters (L, C, R, etc.) indicate the channels being played back. The boxes around the letters vary to show how the receiver downmixes the source sound (based on the speakers settings). L (Front Left), R (Front Right), C (Center (monaural)), SL (Surround Left), SR (Surround Right), S (Surround (monaural) or the surround components obtained by Pro Logic processing), SBL (Surround back Left), SBR (Surround back right), SB (Surround Back (the surround back components obtained by 6.1 channel decoding)), “ ” lights up when the 9.1 ch speaker system is activated.

Example:
Recording format (Front/Surround): 3/2
Output channel: When the surround speakers size parameter is set to “NO”
Sound Field: A.F.D. AUTO
A.F.D. 2CH SW in the SURR SET UP menu:
CREATE
(The initial setting is “OFF”)

SW	L	C	R
	SL		SR
- 3 **DIGITAL (EX):** Lights up when Dolby Digital signals are input. “EX” lights up when Dolby Digital EX signals are input. When playing a Dolby Digital format disc, be sure that you have made digital connections and that INPUT MODE is NOT set to “ANALOG 2CH FIXED” (page 38).
- 4 **INPUT:** Lights up constantly. One of the input indicators also lights up according to the current input.
- 5 **AUTO:** Lights up when INPUT MODE is set to “AUTO 2CH” (page 38).
- 6 **DTS (-ES):** Lights up when DTS signals are input. “-ES” lights up when DTS-ES signals are input. When playing a DTS format disc, be sure that you have made digital connections and that INPUT MODE is NOT set to “ANALOG 2CH FIXED” (page 38).
- 7 **COAX:** Lights up when the source signal is a digital signal being input through the COAXIAL terminal or when INPUT MODE is set to “COAXIAL FIXED” (page 38).
- 8 **OPT:** Lights up when the source signal is a digital signal being input through the OPTICAL terminal, or when INPUT MODE is set to “OPTICAL FIXED” (page 38).
- 9 **ANALOG:** Lights up when no digital signal is input to COAXIAL or OPTICAL jack, or when INPUT MODE is set to “ANALOG 2CH FIXED” (page 38).
- 10 **MULTI IN:** Lights up when “MULTI CH IN” is selected.
- 11 **SB DEC:** Lights up when surround back decoding is activated (page 34).
- 12 **SLEEP D.RANGE EQ:** Lights up when sleep range equalizer is activated.
- 13 **MEMORY:** Lights up when memory is activated.

- 12 SLEEP:** Lights up when sleep timer is activated.
- 13 D.RANGE:** Lights up when dynamic range compression is activated (page 46).
- 14 EQ:** Lights up when the equalizer is activated.
- 15 Tuner indicators:** Lights up when using the receiver to tune in radio stations, etc. See pages 25–26 for tuner operations.
- 16 96/24:** Lights up when the receiver is decoding DTS 96 kHz/24 bit signals.
- 17 MATRIX:** Lights up when DTS-ES Matrix decoding is activated.
- 18 DISCRETE:** Lights up when DTS-ES Discrete decoding is activated.
- 19 CINEMA:** Lights up when DTS Neo:6 Cinema decoding is activated.
- 20 NEO:6:** Lights up when DTS Neo:6 Cinema/Music decoding is activated.
- 21 MUSIC:** Lights up when Pro Logic II Music, Pro Logic Ix Music or DTS Neo:6 Music decoding is activated.
- 22 MOVIE:** Lights up when Pro Logic II Movie or Pro Logic Ix Movie decoding is activated.
- 23 GAME:** Lights up when Pro Logic II Game or Pro Logic Ix Game decoding is activated.
- 24  PRO LOGIC IIx:** “ PRO LOGIC” lights up when the receiver applies Pro Logic processing to 2 channel signals in order to output the center and surround channel signals. “ PRO LOGIC II” lights up when the Pro Logic II Movie/Music/Game decoder is activated. “ PRO LOGIC IIx” lights up when the Pro Logic IIx Movie/Music/Game decoder is activated. However, these indicators do not light up if both the center and surround speakers are set to “NO” and you select a sound field using the A.F.D. button.

Note

Dolby Pro Logic IIx decoding does not function for DTS format signals and for signals with a sampling frequency of more than 48 kHz.

- 25 L.F.E.:** Lights up when the disc being played back contains the LFE (Low Frequency Effect) channel. When the sound of the LFE channel signal is actually being reproduced, the bars underneath the letters lights up to indicate the level. Since the LFE signal is not recorded in all parts of the input signal the bar indication will fluctuate (and may turn off) during playback.

Enjoying Surround Sound

Using only the front speakers

In this mode, the receiver outputs the sound from the front L/R speakers only. There is no sound from the sub woofer.

Listening to 2 channel stereo sources (2CH STEREO)

Standard 2 channel stereo sources completely bypass the sound field processing and multi channel surround formats are downmixed to 2 channel.

Press 2CH.

“2CH STEREO” appears in the display and the receiver switches to the 2CH STEREO mode.

Notes

- Use the CUSTOMIZE menu and set “MENU EXPAND” to “ON”. For details, see page 41.
- No sound is output from the sub woofer in the 2CH STEREO mode. To listen to the 2 channel stereo sources using the front L/R speakers and a sub woofer, select “A.F.D. AUTO” and set “A.F.D. 2CH SW” in the SURR SET UP menu to “CREATE”.

Enjoying higher fidelity sound

— AUTO FORMAT DIRECT

The Auto Format Direct (A.F.D.) mode allows you to select the decoding mode you want for your audio sound.

A.F.D. mode	Decoding mode
A.F.D. AUTO	As encoded
PRO LOGIC	Dolby Pro Logic
PRO LOGIC II MOVIE	Dolby Pro Logic II
PRO LOGIC II MUSIC	
PRO LOGIC II GAME	
PRO LOGIC IIx MOVIE	Dolby Pro Logic IIx
PRO LOGIC IIx MUSIC	
PRO LOGIC IIx GAME	
Neo:6 Cinema	DTS Neo:6
Neo:6 Music	
MULTI STEREO	

Decoding the input audio signal automatically

In this mode, the receiver automatically detects the type of audio signal being input (Dolby Digital, DTS, standard 2 channel stereo, etc.) and performs the proper decoding if necessary. This mode presents the sound as it was recorded/encoded, without adding any surround effects. However, when “MENU EXPAND” in the CUSTOMIZE menu is set to “ON”, “A.F.D. 2CH SW” in the SURR SET UP is set to “CREATE” and if there are no low frequency signals (Dolby Digital LFE, etc.) it will generate a low frequency signal for output to the sub woofer.

Press A.F.D. repeatedly to select “A.F.D. AUTO”.

The receiver automatically detects the type of audio signal being input and performs the proper decoding if necessary.

Tip

In most cases, “A.F.D. AUTO” provides the most appropriate decoding. You may want to use SURR BACK DECODING (page 34) to match the input stream to the mode you prefer.

Enjoying stereo sound in multi channel (2 channel decoding mode)

This mode lets you specify the type of decoding for 2 channel audio sources. This receiver can reproduce 2 channel sound in 5 channels through Dolby Pro Logic II; 6 channels through DTS Neo:6; or 4 channels through Dolby Pro Logic. However, DTS 2CH sources are not decoded by DTS Neo:6; they are output in 2 channels.

Press A.F.D. repeatedly to select the 2 channel decoding mode.

■ PRO LOGIC

Performs Dolby Pro Logic decoding. The source recorded in 2 channel is decoded into 4.1 channels.

■ PRO LOGIC II MOVIE

Performs Dolby Pro Logic II Movie mode decoding. This setting is ideal for movies encoded in Dolby Surround. In Addition, this mode can reproduce sound in 5.1 channel when watching videos of overdubbed or old movies.

■ PRO LOGIC II MUSIC

Performs the Dolby Pro Logic II Music mode decoding. This setting is ideal for normal stereo sources such as CDs.

■ PRO LOGIC II GAME

Performs Dolby Pro Logic II Game mode decoding. This setting is ideal for video game softwares.

■ PRO LOGIC IIx MOVIE

Performs Dolby Pro Logic IIx Movie mode decoding. This setting expands Dolby Pro Logic II Movie or Dolby Digital 5.1 to discrete 7.1 movie channels.

■ PRO LOGIC IIx MUSIC

Performs Dolby Pro Logic IIx Music mode decoding. This setting shares hard “back” effects across all surround speakers.

■ PRO LOGIC IIx GAME

Performs Dolby Pro Logic IIx Game mode decoding. This setting delivers full-impact special effect signals panned to the surround speakers.

Note

Dolby Pro Logic IIx decoding does not function for DTS format signals and for signals with a sampling frequency of more than 48 kHz.

continued

■ Neo:6 Cinema

Performs the DTS Neo:6 Cinema mode decoding.

■ Neo:6 Music

Performs the DTS Neo:6 Music mode decoding. This setting is ideal for normal stereo sources such as CDs.

■ MULTI STEREO

Outputs the 2 channel L/R signals from all speakers.

If you connect a sub woofer

When the audio signal is 2 channel stereo or if the source signal does not include a LFE signal, the receiver generates a low frequency signal for output to the sub woofer. However the low frequency signal is not generated for “Neo:6 Cinema” or “Neo:6 Music” when all speakers are set to “LARGE”.

Selecting a sound field

You can take advantage of surround sound simply by selecting one of the receiver’s pre-programmed sound fields. They bring the exciting and powerful sound of movie theaters and concert halls into your home.

Selecting a sound field for movies

Press MOVIE repeatedly to select the sound field you want.

The selected sound field appears in the display.

Sound field

CINEMA STUDIO EX A **DCS**

CINEMA STUDIO EX B **DCS**

CINEMA STUDIO EX C **DCS**

V.MULTI DIMENSION **DCS**

About DCS (Digital Cinema Sound)

Sound fields with **DCS** marks use DCS technology.

DCS is the concept name of the surround technology for home theater developed by Sony. DCS uses the DSP (Digital Signal Processor) technology to reproduce the sound characteristics of an actual cinema cutting studio in Hollywood.

When played at home, DCS will create a powerful theater effect that mimics the artistic combination of sound and action as envisioned by the movie director.

■ CINEMA STUDIO EX A **DCS**

Reproduces the sound characteristics of the Sony Pictures Entertainment “Cary Grant Theater” cinema production studio. This is a standard mode, great for watching most any type of movies.

■ CINEMA STUDIO EX B **DCS**

Reproduces the sound characteristics of the Sony Pictures Entertainment “Kim Novak Theater” cinema production studio. This mode is ideal for watching science-fiction or action movies with lots of sound effects.

■ CINEMA STUDIO EX C DCS

Reproduces the sound characteristics of the Sony Pictures Entertainment scoring stage. This mode is ideal for watching musicals or films where orchestra music is featured in the soundtrack.

■ V.MULTI DIMENSION DCS

Creates 5 sets of virtual speakers from a single pair of actual surround speakers.

About CINEMA STUDIO EX modes

CINEMA STUDIO EX modes are suitable for watching motion picture DVDs (etc.), with multi channel surround effects. You can reproduce the sound characteristics of Sony Pictures Entertainment's dubbing studio in your home.



The CINEMA STUDIO EX modes consist of the following three elements.

- **Virtual Multi Dimension**
Creates 5 sets of virtual speakers from a single pair of actual surround speakers.
- **Screen Depth Matching**
Creates the sensation that the sound is coming from inside the screen like in theaters.
- **Cinema Studio Reverberation**
Reproduces the type of reverberation found in theaters.

The CINEMA STUDIO EX modes integrate these three elements simultaneously.

Tip

You can identify the encoding format of DVD software, etc. by looking at the logo on the package.

-  : Dolby Digital discs
-  : Dolby Surround encoded programs
-  : DTS Digital Surround encoded programs

Notes

- The effects provided by the virtual speakers may cause increased noise in the playback signal.
- When listening with sound fields that employ the virtual speakers, you will not be able to hear any sound coming directly from the surround speakers.

Selecting a sound field for music

Press **MUSIC** repeatedly to select the sound field you want.

The selected sound field appears in the display.

Sound field

D.CONCERT HALL A

D.CONCERT HALL B

CHURCH

JAZZ CLUB

LIVE CONCERT

STADIUM

SPORTS

■ D.CONCERT HALL A

Uses 3D sound imaging to reproduce the sound characteristics of the CONCERTGEBOUW in Amsterdam, which is famous for a large sound stage produced by reflectivity.

■ D.CONCERT HALL B

Uses 3D sound imaging to reproduce the sound characteristics of the MUSIKVEREIN in Vienna, which is famous for its hall resonance and unique reverberative sound.

■ CHURCH

Reproduces the acoustics of a stone church.

■ JAZZ CLUB

Reproduces the acoustics of a jazz club.

■ LIVE CONCERT

Reproduces the acoustics of a 300-seat live house.

■ STADIUM

Reproduces the feeling of a large open-air stadium.

■ SPORTS

Reproduces the feeling of sports broadcasting.

When the headphones are connected

You can select only from the following sound fields.

■ HEADPHONE (2CH)

Press 2CH or A.F.D. Outputs the sound in 2 channel (stereo). Standard 2 channel stereo sources completely bypass the sound field processing and multi channel surround formats are downmixed to 2 channels.

continued

■ HEADPHONE (DIRECT)

Press DIRECT. Outputs the signals without digital processing by the equalizer, sound field, etc.

■ HEADPHONE (MULTI)

Press MULTI CH. Outputs the analog signals input to the MULTI CH IN jacks.

■ HEADPHONE THEATER **DCS**

Allows you to experience a theater-like environment while listening through a pair of headphones.

To turn off the surround effect

Press 2CH, or press A.F.D. to select “A.F.D. AUTO”.

Listening to the sound without any adjustment

— (ANALOG) DIRECT

You can listen to the sound without adjusting the equalizer and surround effect. This function enables you to enjoy high quality analog sources.

Press DIRECT.

The DIRECT indicator lights up and the equalizer and sound fields are canceled.

Selecting the surround back decoding mode

— SURR BACK DECODING

This function lets you select the decoding mode for the surround back signals of the multi channel input stream.

By decoding the surround back signal of DVD software (etc.) recorded in Dolby Digital EX, DTS-ES Matrix, DTS-ES Discrete 6.1, etc. format, you can enjoy the surround sound intended by the filmmakers.

Press SURR BACK DECODING repeatedly to select the surround back decoding mode.

For details, see “How to select the surround back decoding mode” on page 34.

Tip

You can select the surround back decoding mode using “SB DECODING” in the CUSTOMIZE menu (page 41).

How to select the surround back decoding mode

You can select the surround back mode you want according to the input stream.

When you select “OFF”

Surround back decoding is not performed.

When you select “AUTO”

When the input stream contains the 6.1 channel decode flag^{a)}, the appropriate decoder is applied to decode the surround back signal.

Setting the Surround Back Decoding Mode (SB DEC MODE)

You can select surround back decoding only when SB DECODING is set to ON or AUTO and the input stream contains the Dolby Digital EX flag.

Input stream	Output channel	Applied surround back decoder
Dolby Digital 5.1	5.1 ^{e)}	—
Dolby Digital EX ^{b)}	6.1 ^{e)}	Matrix decoder depending on Surround Back Decoding Mode (SB DEC MODE), page 35
DTS 5.1	5.1 ^{e)}	—
DTS-ES Matrix 6.1 ^{c)}	6.1 ^{e)}	DTS Matrix decoder
DTS-ES Discrete 6.1 ^{d)}	6.1 ^{e)}	DTS Discrete decoder

When you select “ON”

SB DEC MODE setting is applied to 5.1 channel and 6.1 channel decode in the input stream (page 35).

- a) 6.1 channel decode flag is the information recorded in software like DVDs.
- b) Dolby Digital DVD that includes a Surround EX flag. The Dolby Corporation web page can help you distinguish Surround EX films.
- c) Software encoded with a flag to denote it has both Surround EX and 5.1 channel signals.
- d) Software encoded with both 5.1 channel signals and an extension stream designed for returning those signals to 6.1 discrete channels. Discrete 6.1 channel signals are DVD specific signals not used in movie theaters.
- e) When two surround back speakers are connected, the output channel will be 7.1 channels.

Notes

- There may be no sound from the surround back speaker in Dolby Digital EX mode. Some discs have no Dolby Digital EX flag even though the packages have Dolby Digital EX logos. In this case, select “ON”.
- SB DECODING MODE/SB DEC MODE is cancelled when Dolby Pro Logic IIx is selected in AUTO FORMAT DIRECT (A.F.D.) mode.

SB DEC MODE	Speaker setting	Applied surround back decoder
[DDEX]	7.1 ch	Matrix decoder conforms to Dolby Digital EX
	6.1 ch	Matrix decoder conforms to Dolby Digital EX
[PLIIx MV]	7.1 ch	Movie decoder conforms to Dolby Pro Logic IIx
	6.1 ch	Matrix decoder conforms to Dolby Digital EX
[PLIIx MS]	7.1 ch	Music decoder conforms to Dolby Pro Logic IIx
	6.1 ch	Music decoder conforms to Dolby Pro Logic IIx

Notes

- Matrix decoder conformed to Dolby Digital EX is applied regardless of the surround back decoder mode setup when a sound field for a movie is selected.
- Matrix decoder conformed to Dolby Digital EX is applied if the speaker setting is 6.1 channel and Movie decoder conformed to Pro Logic IIx is applied if the speaker setting is 7.1 channel. when you select Dolby PLIIx MS in the following conditions:
 - a Dolby Digital EX signal is input.
 - surround back decoder mode is set to AUTO.

Input Stream indicator

When AUTO FORMAT DIRECT mode is selected while the surround back decoder is activated, the current decoder's process is displayed a few seconds after the input stream is displayed.

When the decoder conforms to Dolby Digital EX

Input stream	after a few seconds	Current decoder's process
DOLBY DIGITAL [3/2.1]	⇒	DOLBY D EX [3/2.1]
DOLBY D EX [3/2.1]	⇒	DOLBY D EX [3/2.1]
DTS [3/2.1]	⇒	DTS [3/2.1] + DOLBY EX
DTS-ES Matrix [3/2.1]	⇒	DTS [3/2.1] + DOLBY EX
DTS-ES Discrete [3/3.1]	⇒	DTS [3/2.1] + DOLBY EX*

* When surround back decoder conforms to Dolby Digital EX, if you decode DTS-ES Discrete [3/3.1] signal, this unit also decodes the DTS-ES Discrete [3/2.1] signal.

When the current decoder conforms to Dolby Pro Logic IIx

Input stream	after a few seconds	Current decoder's process
DOLBY DIGITAL [3/2.1]	⇒	DOLBY D [3/2.1] + PLIIx
DOLBY D EX [3/2.1]	⇒	DOLBY D [3/2.1] + PLIIx
DTS [3/2.1]	⇒	DTS [3/2.1] + PLIIx
DTS-ES Matrix [3/2.1]	⇒	DTS [3/2.1] + PLIIx
DTS-ES Discrete [3/3.1]	⇒	DTS [3/2.1] + PLIIx**

** When surround back decoder conforms to Dolby Pro Logic IIx, if you decode the DTS-ES Discrete [3/3.1] signal, this unit also decodes the DTS-ES Discrete [3/2.1] signal.

Assigning the audio input

— DIGITAL ASSIGN

You can assign the digital audio input for other input. This function is convenient in the following cases.

When you have two DVD players and no digital audio input jack is available for the second DVD player.

Connect the first DVD player to the DVD COAXIAL IN jack and connect the second DVD player to the DVD OPTICAL IN jack. Also, connect the analog audio/video output jacks on the second DVD player to the VIDEO 2 INPUT jacks on the receiver.

Assign "DVD COAX" to DVD and assign "DVD OPT" to VIDEO 2.

- 1** Rotate MAIN MENU to select "CUSTOMIZE".
- 2** Rotate MENU to select "DIGITAL ASSIGN ?".
- 3** Press MEMORY/ENTER.
- 4** Rotate MENU to select the digital audio input you want to assign.
- 5** Rotate +/- to select the input you want to assign the digital audio input jack selected in step 4.

The input you can assign varies for each audio input. For details, see "Selectable audio inputs for each input" (page 37).

Selectable audio inputs for each input

VIDEO 3 OPT

VIDEO 1, VIDEO 2, VIDEO 3, TAPE

DVD COAX, DVD OPT

VIDEO 1, VIDEO 2, DVD, TAPE

TV/SAT OPT

VIDEO 1, VIDEO 2, TV/SAT, TAPE

MD/DAT OPT

VIDEO 1, VIDEO 2, MD/DAT, TAPE

SA-CD COAX, SA-CD OPT

VIDEO 1, VIDEO 2, SA-CD, TAPE

Notes

- You cannot assign several audio inputs to the same input.
- You cannot use the audio input for the original input when it is assigned to another input.
- When you assign the audio input, the INPUT MODE setting may change automatically (page 38).
- You cannot assign for TUNER.

Assigning the component video input

— COMPONENT VIDEO ASSIGN

You can assign a component video input for another visual input.

- 1** Rotate **MAIN MENU** to select “**CUSTOMIZE**”.
- 2** Rotate **MENU** to select “**COMPONENT V. ASSIGN ?**”.
- 3** Press **MEMORY/ENTER**.
- 4** Rotate **MENU** to select the component video input you want to assign.
- 5** Rotate **-/+** to select the input you want to assign the component video input jacks selected in step 4.

The input you can assign varies for each component video input. For details, see “Selectable component video inputs for each input” (page 38).

Selectable component video inputs for each input

DVD

NONE, VIDEO 1, VIDEO 2, VIDEO 3, DVD, TAPE, MD/DAT, SA-CD/CD

TV/SAT

NONE, VIDEO 1, VIDEO 2, VIDEO 3, TV/SAT, TAPE, MD/DAT, SA-CD/CD

Note

You cannot assign a visual input to more than one component video input.

Switching the audio input mode for digital components

— INPUT MODE

You can switch the audio input mode for components for which this receiver have digital audio input jacks.

- 1** Rotate **INPUT SELECTOR** to select the input.
- 2** Press **INPUT MODE** repeatedly to select the audio input mode.

The selected audio input mode appears in the display.

Audio input modes

- **AUTO 2CH**
Gives priority to the analog audio signals input to the AUDIO IN (L/R) jacks when there is no digital audio signals.
- **COAXIAL FIXED**
Specifies the digital audio signals input to the DIGITAL COAXIAL input jack.
- **OPTICAL FIXED**
Specifies the digital audio signals input to the DIGITAL OPTICAL input jacks.
- **ANALOG 2CH FIXED**
Specifies the analog audio signals input to the AUDIO IN (L/R) jacks.

Notes

- You cannot select the digital audio input which is assigned to another function by DIGITAL ASSIGN function (page 37).
- Some of the audio input modes do not appear depending on the input.

Customizing sound fields

By adjusting the SURR SET UP menu and LEVEL menu, you can customize the sound fields to suit your particular listening situation.

Note on the displayed items

The setup items you can adjust in each menu vary depending on the sound field. Certain setup parameters may be dimmed in the display. This means that the selected parameter is either unavailable or fixed and unchangeable.

Adjusting the SURR SET UP menu

You can customize the surround effects of the selected sound field. The settings are stored individually for each sound field.

- 1 Start playing a source encoded with multi channel surround effects (DVD, etc.).**
- 2 Rotate MAIN MENU to select “SURR SET UP”.**
- 3 Rotate MENU to select the parameter.**
For details, see “SURR SET UP menu parameters” below.
- 4 While monitoring the sound, rotate \pm to adjust the selected parameter.**
- 5 Repeat steps 3 and 4 to adjust the other parameters.**

SURR SET UP menu parameters

■ EFFECT LEVEL XXX% (Effect level)

Initial setting: 100%

Higher settings apply more surround effect. You can adjust from 20 % to 120 % in 5 % steps.

For advanced SURR SET UP menu adjustments

Use the CUSTOMIZE menu and set “MENU EXPAND [XXX]” to “ON” to enable advanced adjustments.

For details on “MENU EXPAND [XXX]”, see page 41.

For details on how to set the items, see page 45.

Adjusting the LEVEL menu

You can adjust the balance and level of each speaker. These settings are applied to all sound fields.

- 1 Start playing a source encoded with multi channel surround effects (DVD, etc.).**
- 2 Rotate MAIN MENU to select “LEVEL”.**
- 3 Rotate MENU to select the parameter.**
For details, see “LEVEL menu parameters” below.
- 4 While monitoring the sound, rotate \pm to adjust the selected parameter.**
- 5 Repeat steps 3 and 4 to adjust the other parameters.**

LEVEL menu parameters

■ TEST TONE (Test Tone)

Initial setting: OFF

Lets you output the test tone sequentially from each speaker. When set to “AUTO”, the test tone is output from each speaker automatically. When set to “FIX”, you can select which speaker will output the test tone.

■ FRONT L_R (Front speaker balance)

Initial setting: 0 (BALANCE)

Lets you adjust the balance between front left and right speakers. You can adjust from -8 dB to $+8$ dB in 0.5 dB steps.

■ CENTER XXX.X dB (Center speaker level)

■ SURROUND L XXX.X dB (Surround speaker (L) level)

■ SURROUND R XXX.X dB (Surround speaker (R) level)

■ SURR BACK XXX.X dB (Surround back speaker level)*

■ SURR BACK L XXX.X dB (Surround back (L) level)**

■ SURR BACK R XXX.X dB (Surround back (R) level)**

■ SUB WOOFER XXX.X dB (Sub woofer level)

Initial setting: 0 dB

You can adjust from -20 dB to $+10$ dB in 0.5 dB steps.

continued

■ MULTI CH SW XXX dB (Multi channel input sub woofer level)

Initial setting: 0 dB

Lets you increase the level of the MULTI CH IN sub woofer channel by +10 dB. This adjustment may be necessary when connecting a DVD player to the MULTI CH IN jacks. The sub woofer level from DVD players is 10 dB lower than Super Audio CD players.

* Only when the surround back speaker is set to "SINGLE" in the SPEAKER SET UP menu (page 20).

**Only when the surround back speaker is set to "DUAL" in the SPEAKER SET UP menu (page 21).

Note

When one of the following sound fields is selected, no sound is output from the sub woofer if all the speakers are set to "LARGE" in the SPEAKER SET UP menu. However, the sound will be output from the sub woofer if the digital input signal contains LFE (Low Frequency Effect) signals, or if the front or surround speakers are set to "SMALL".

- D.CONCERT HALL A
- D.CONCERT HALL B
- CHURCH
- JAZZ CLUB
- LIVE CONCERT
- STADIUM
- SPORTS

For advanced LEVEL menu adjustments

Use the CUSTOMIZE menu and set "MENU EXPAND" to "ON" to enable advanced adjustments.

For details on "MENU EXPAND", see page 41.
For details on how to set the items, see page 45.

Resetting sound fields to the initial settings

- 1** Press I/⏻ to turn off the power.
- 2** While holding down MUSIC, press I/⏻.
"S.F. Initialize" appears in the display and all sound fields are reset to the initial setting.

Adjusting the equalizer

You can adjust the tonal quality (bass, treble level) of each speaker using the EQUALIZER menu.

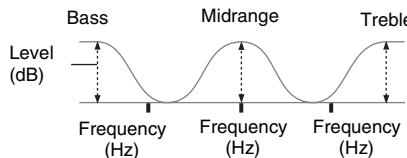

You can store up to 5 different equalizer settings in the equalizer bank (EQ PRESET [1]–[5]) and apply them. Initial setting: EQ PRESET [1]

- 1** Start playing a source encoded with multi channel surround effects (DVD, etc.).
- 2** Rotate MAIN MENU to select "EQUALIZER".
- 3** Rotate MENU to select "EQ PRESET".
- 4** Rotate -/+ to select the equalizer bank you want to adjust (EQ PRESET [1] – [5]).
- 5** Rotate MENU to select the parameter.
For details, see "EQUALIZER menu parameters" below.
- 6** While monitoring the sound, rotate -/+ to adjust the selected parameter.
- 7** Repeat steps 5 and 6 to adjust the other items.

EQUALIZER menu parameters

■ EQ PRESET (Preset equalizer selection)

■ FRONT BASS XXX dB
(Front speaker bass level)

■ FRONT TREBLE XXX dB
(Front speaker treble level)

■ CENTER BASS XXX dB
(Center speaker bass level)

■ CENTER MID XXX dB
(Center speaker midrange level)

Initial setting: 0 dB

You can adjust from -10 dB to +10 dB in 1 dB steps.

■ CENTER MID XXX Hz (Center speaker midrange frequency)

Initial setting: 1 kHz

You can adjust from 100 Hz to 10 kHz in 5 steps (100 Hz, 300 Hz, 1 kHz, 3 kHz, 10 kHz).

■ CENTER TREBLE XXX dB (Center speaker treble level)

■ SURR/SB BASS XXX dB (Surround/surround back speaker bass level)

■ SURR/SB TRE. XXX dB (Surround/surround back speaker treble level)

Initial setting: 0 dB

You can adjust from -10 dB to +10 dB in 1 dB steps.

■ PRESET X CLEAR (Equalizer bank clear)

You can reset the adjusted equalizer settings to the initial setting. For details, see “Clearing stored equalizer settings” (page 41).

Tip

Rotate BASS and TREBLE to adjust the front speaker bass and treble level.

To apply the stored equalizer

- 1 Rotate MAIN MENU to select “EQUALIZER”
- 2 Rotate MENU to select “EQ PRESET”.
- 3 Rotate \pm to select “EQ PRESET [1] – [5]”.

Clearing stored equalizer settings

- 1 Rotate MAIN MENU to select “EQUALIZER”.
- 2 Rotate MENU to select “EQ PRESET”.
- 3 Rotate \pm to select the equalizer (EQ PRESET [1] – [5]) you want to clear.
- 4 Rotate MENU to select “PRESET X CLEAR”.
“X” is the number of the selected equalizer bank.
- 5 Rotate \pm to select “YES”, then press MEMORY/ENTER.
“Are you sure?” appears in the display.
- 6 Rotate \pm to select “YES”, then press MEMORY/ENTER.
“PRESET X CLEARED!” appears in the display and the adjusted contents of the selected equalizer bank are cleared.

Advanced settings

Using the CUSTOMIZE menu to adjust the receiver

You can adjust various receiver settings using the CUSTOMIZE menu.

- 1 Rotate MAIN MENU to select “CUSTOMIZE”.
- 2 Rotate MENU to select the parameter.
For details, see “CUSTOMIZE menu parameters” below.
- 3 Rotate \pm to adjust the selected parameter.
- 4 Repeat steps 2 and 3 to adjust the other items.

CUSTOMIZE menu parameters

The initial setting is underlined.

■ MENU EXPAND [XXX] (Menu expanding)

- ON

The advanced parameters for the SPEAKER SET UP, SURR SET UP and LEVEL menus are displayed and can be adjusted.

For details on each setup item, see pages 20, 39 and the following pages.

- OFF

The advanced parameters are not displayed.

■ DTS 96/24 DEC. [XXXX] (DTS 96/24 decoding mode)

- AUTO

When a DTS 96/24 signal is input, it is played back at 96 kHz sampling frequencies.

- OFF

Even when a DTS 96/24 signal is input, it is played back at 48 kHz sampling frequencies.

Note

This parameter is valid only in the A.F.D. mode (page 30). In other sound fields, this parameter is always set to “OFF”.

■ SB DECODING [XXXXXX] (Surround back decoding mode)

You can use the CUSTOMIZE menu to set the surround back decoding mode. See page 34.

- AUTO

- ON
- OFF

■ SB DEC MODE [XXXXXXX] (SB DEC MODE)

You can use the CUSTOMIZE menu to set the SB DEC mode, see page 41.

- DDEX
- PLLIx MV
- PLLIx MS

Note

This parameter is valid only in A.F.D. mode (page 30).

■ 9.1 CH SP SYSTEM [XXX] (9.1 ch speaker system)

- YES

When two pairs of speakers are connected to SURROUND SPEAKERS in parallel and a pair of speakers are connected to SURR BACK SPEAKERS terminal.

- NO

When only a pair of speakers are connected to either SURROUND SPEAKERS terminals.

Notes

- This function is valid when surround back speakers is set to DUAL only.
- When the IMPEDANCE SELECTOR is set to “8Ω”, connect the speakers with a nominal impedance of 16 ohm or higher. When the IMPEDANCE SELECTOR is set to “4Ω”, connect the speakers with a nominal impedance of 8 ohms or higher. For details, see “Speaker impedance” page 17.

■ A/V SYNC [XXX ms] (Time alignment)

Initial setting: 0 ms

Lets you delay the output of audio to adjust the gap between video and audio. You can adjust from 0 ms to 200 ms in 10 ms steps.

■ S.FIELD LINK [XXX] (Sound field link)

- ON

Lets you apply the last selected sound field to an input whenever it is selected. For example, if you select STADIUM for the SA-CD/CD input, then change to a different input and return to SA-CD/CD, STADIUM will automatically be applied again.

- OFF

Sound field link is not activated.

■ DEC. PRIORITY [XXXX] (Digital audio input decoding priority)

Lets you specify the input mode for the digital signal input to the DIGITAL IN jacks.

The initial setting is “AUTO” for VIDEO 1, VIDEO 2, VIDEO 3, TV/SAT, TAPE, TUNER and PHONO, and “PCM” for DVD, MD/DAT and SA-CD/CD. You can use DECODE PRIORITY on the front panel.

- AUTO

Automatically switches the input mode between DTS, Dolby Digital, or PCM.

- PCM

PCM signals are given priority (to prevent the interruption when playback starts). Even when other signals are input, the sound is output. When set to “AUTO” and the sound from the digital audio jacks (for CD, etc.) is interrupted when playback starts, set to “PCM”.

■ DUAL MONO [XXXXXXXX] (Digital broadcast language selection)

Lets you select the language you want to listen to during digital broadcast. This feature only functions for Dolby Digital sources.

- MAIN/SUB

Sound of the main language will be output through the front left speaker and sound of the sub language will be output through the front right speaker simultaneously.

- MAIN

Sound of the main language will be output.

- SUB

Sound of the sub language will be output.

- MAIN+SUB

Mixed sound of both the main and sub languages will be output.

■ OSD H.POSITION[XX] (OSD horizontal position)

Initial setting: 4

Lets you adjust the position of the on-screen display horizontally. You can adjust from 0 to 64.

■ OSD V.POSITION [XX] (OSD vertical position)

Initial setting: 4

Lets you adjust the position of the on-screen display vertically. You can adjust from 0 to 32.

■ DIMMER [XX % DOWN] (Brightness of the display)

Lets you adjust the brightness of the display. The DIMMER indicator is lights up when dimmer is activated. When you set to turn off the display completely, the MULTI CHANNEL DECODING indicator is also turned off.

■ UP YUV HUE [XX] (Video hue level)

Initial setting: 4

Lets you adjust the hue of the images when you upconvert the video or S-video signals to component video signals. You can adjust from 1 to 7.

■ UP YUV COLOR [XX] (Video chroma level)

Initial setting: 4

Lets you adjust the chroma of the images when you upconvert the video or S-video signals to component video signals. You can adjust from 1 to 7.

**■ DIGITAL ASSIGN ?
(Digital audio input assignment)**

Lets you assign the digital audio input to other input. For details, see "Assigning the audio input" on page 37.

**■ COMPONENT V. ASSIGN ?
(Component Video Assign)**

Lets you assign the component video input to another visual input. For details, see "Assigning the component video input" on page 38.

**■ D.POWER [XXXXXXXXX]
(Digital Power management)**

- AUTO

Lets you turn off the power of the unnecessary digital circuits automatically when outputting the analog audio signals using the ANALOG DIRECT or MULTI CH IN DIRECT function. You can enjoy high quality analog audio without the influence of digital circuits.

- ALWAYS ON

Lets you keep the power of digital circuits on. Select if you do not like the time lag that occurs with the "AUTO OFF" setting when digital circuits are turned on, etc.

**■ USER PRESET MEM.? [X]
(User preset memory)**

Lets you store the adjusted sound field settings, etc. For details, see "Storing the adjusted settings" on page 48.

**■ NAME IN? [XXXXXXXXX]
(Naming inputs)**

Lets you set the name of inputs selected with INPUT SELECTOR. For details, see "Naming preset stations and inputs" on page 49.

**Advanced SPEAKER SET UP
menu parameters**

When "MENU EXPAND [XXX]" is set to "ON", all of the following parameters are displayed and adjustable.

See page 20 for the SPEAKER SET UP menu adjustments. Initial settings are underlined.

**All SPEAKER SET UP menu
parameters**

 SP EASY SET UP

 SPEAKER PATTERN

 SUB WOOFER

 FRONT SP

 CENTER SP

 SURROUND SP

 SURR BACK SP

 FRONT XX feet

 CENTER XX feet

 SURROUND XX feet

 SURR BACK XX feet

 SUB WOOFER XX feet

 DISTANCE UNIT*

 SP POSI.*

 SP CROSSOVER > XXX Hz*

* Adjustable only when "MENU EXPAND [XXX]" is set to "ON".

■ DISTANCE UNIT (Distance unit)

Lets you select the unit of measure for setting distances.

- feet

The distance is displayed in feet.

- meter

The distance is displayed in meters.

continued

■ SP POSI.

(Surround speaker position)*

Lets you specify the location of your surround speakers for proper implementation of the surround effects in the Cinema Studio EX modes (page 32).

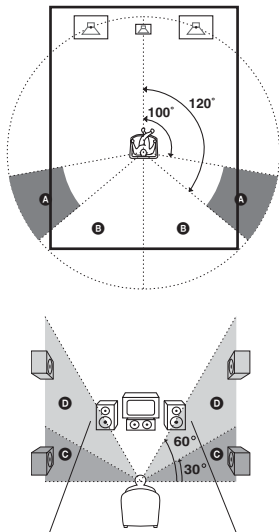

• SIDE/LOW

Select if the location of your surround speakers corresponds to section **A** and **C**.

• SIDE/HIGH

Select if the location of your surround speakers corresponds to section **A** and **D**.

• BEHD/LOW

Select if the location of your surround speakers corresponds to section **B** and **C**.

• BEHD/HIGH

Select if the location of your surround speakers corresponds to section **B** and **D**.

* This setup item is not available when the surround speaker parameter is set to "NO" (page 21).

Tip

Surround speaker position is designed specifically for implementation of the Cinema Studio EX modes.

For other sound fields, speaker position is not so critical. Those sound fields were designed under the premise that the surround speakers would be located behind the listening position, but presentation remains fairly consistent even with the surround speakers positioned at a rather wide angle. However, if the speakers are pointing toward the listener from the immediate left and right of the listening position, the surround effects becomes unclear unless set to "SIDE". Nevertheless, each listening environment has many variables, like wall reflections, and you may obtain better results using "BEHD" if your speakers are located high above the listening position, even if they are to the immediate left and right.

Therefore, although it may result in a setting contrary to the above explanation, we recommend that you playback multi channel surround encoded software and select the setting that provides a good sense of spaciousness and that best succeeds in forming a cohesive space between the surround sound from the surround speakers and the sound of the front speakers. If you are not sure which sounds best, select "BEHD" and then use the speaker distance parameter and speaker level adjustments to obtain proper balance.

■ SP CROSSOVER > XXX Hz (Speaker crossover frequency)

Initial setting: 100 Hz

Lets you set the bass crossover frequency of speakers set to "SMALL" in the SPEAKER SET UP menu. You can adjust from 40 Hz to 160 Hz in 10 Hz steps.

Advanced SURR SET UP menu parameters

When “MENU EXPAND” is set to “ON”, all of the following parameters are displayed and adjustable.

See page 39 for the SURR SET UP menu adjustments. Initial settings are underlined.

All SURR SET UP menu parameters

EFFECT LEVEL

C. WIDTH L_C_R*

DIMENSION F_I_S*

PANORAMA MODE*

FRONT REVERB*

SCREEN DEPTH*

VIR.SPEAKERS*

A.F.D. 2CH SW*

* Adjustable only when “MENU EXPAND” is set to “ON”.

■ C. WIDTH L_C_R (Center width control)

Initial setting: (3)

Lets you perform further adjustments for Dolby Pro Logic II Music and Dolby Pro Logic Ix Music mode decoding. You can set this parameter only when A.F.D. mode is set to “PRO LOGIC II MUSIC” or “PRO LOGIC Ix MUSIC” (page 30).

You can adjust the distribution of the center channel signal, generated through the Dolby Pro Logic II or Dolby Pro Logic Ix decoding, to the L/R speakers.

■ DIMENSION F_I_S (Dimension control)

Initial setting: midpoint (0)

Lets you perform further adjustments for Dolby Pro Logic II Music and Dolby Pro Logic Ix Music mode decoding. You can set this parameter only when A.F.D. mode is set to “PRO LOGIC II MUSIC” or “PRO LOGIC Ix MUSIC” (page 30).

You can adjust the difference between the front channels and the surround channels.

■ PANORAMA MODE (Panorama mode)

Lets you perform further adjustments for Dolby Pro Logic II Music and Dolby Pro Logic Ix Music mode decoding. You can set this parameter only when A.F.D. mode is set to “PRO LOGIC II MUSIC” or “PRO LOGIC Ix MUSIC” (page 30).

• ON

Lets you enjoy the surround sound by spreading the sound field of front speakers to the left and right of the listening position (panorama mode).

• OFF

Panorama mode is not activated.

■ FRONT REVERB (Front reverberation)

This parameter is especially for “D.CONCERT HALL A/B” (page 33). This parameter lets you adjust the amount of reverberations to add to the front signals according to the original reverberations in the source.

• STD

Normally, select “STD”.

• WET

Select to increase front reverberations.

■ SCREEN DEPTH (Screen depth)

Lets you create the sensation that the sound of the front speakers comes from inside the screen in your listening room, like theatres.

• ON

Lets you create the sensation that the sound comes from a very large screen with a great amount of screen depth.

• OFF

This function is not activated.

Note

This parameter is only available for Cinema Studio EX modes.

■ VIR.SPEAKERS (Virtual speakers)

This parameter is especially for the Cinema Studio EX modes (page 32).

• ON

The virtual speakers are created.

• OFF

The virtual speakers are not created.

■ A.F.D. 2CH SW (Creating, low frequency signals)

• CREATE

Lets you create low frequency signals for output to the subwoofer when “A.F.D. AUTO” is selected.

• OFF

Low frequency signals are not created.

continued

Advanced LEVEL menu parameters

When “MENU EXPAND” is set to “ON”, all of the following parameters are displayed and adjustable.

See page 39 for the LEVEL menu adjustments. Initial settings are underlined.

All LEVEL menu parameters

TEST TONE
PHASE NOISE ^{a)}
PHASE AUDIO ^{a)}
FRONT L_I_R
CENTER XXX.X dB
SURROUND L XXX.X dB
SURROUND R XXX.X dB
SURR BACK XXX.X dB ^{b)}
SURR BACK L XXX.X dB ^{c)}
SURR BACK R XXX.X dB ^{c)}
SUB WOOFER XXX.X dB
MULTI CH SW XXX dB
D.RANGE COMP. ^{a)}

a) Adjustable only when “MENU EXPAND” is set to “ON”.

b) When surround back speaker is set to “SINGLE” (page 21).

c) When surround back speaker is set to “DUAL” (page 21).

■ PHASE NOISE (Phase noise)

Initial setting: OFF

Lets you output the test tone sequentially from adjacent speakers.

■ PHASE AUDIO (Phase audio)

Initial setting: OFF

Lets you output the front 2 channel source sound (instead of the test tone) sequentially from adjacent speakers.

■ D.RANGE COMP. (Dynamic range compressor)

Lets you compress the dynamic range of the sound track. This may be useful when you want to watch movies at low volumes late at night.

- OFF
The dynamic range is not compressed.
- STD
The dynamic range is compressed as intended by the recording engineer.
- MAX
The dynamic range is compressed dramatically.

Tip

Dynamic range compressor lets you compress the dynamic range of the soundtrack based on the dynamic range information included in the Dolby Digital signal. “STD” is the standard setting, but it only enacts light compression.

Therefore, we recommend using the “MAX” setting. This greatly compresses the dynamic range and lets you view movies late at night at low volumes. Unlike analog limiters, the levels are predetermined and provide a very natural compression.

Note

Dynamic range compression is possible with Dolby Digital sources only.

Custom install mode

This receiver features the custom install modes described below. Depending on how you intend to use these features, use of these modes may require additional equipment (available separately) or modification of your listening environment. Please consult the retailer where you purchased this receiver for more information.

- 1 Rotate MAIN MENU to select “CIS”.**
- 2 Rotate MENU to select the parameter.**
For details, see “CIS menu parameters” below.
- 3 Rotate –/+ to select the setting you want.**
- 4 Repeat steps 2 and 3 to adjust the other items.**

CIS menu parameters

Initial settings are underlined.

■ 2ND ZONE (2nd zone source)

■ 3RD ZONE (3rd zone source)

Lets you select the source signals (analog audio and video signals for 2nd zone; only analog audio signals for 3rd zone) you want to output in the 2nd zone or 3rd zone (except PHONO). When you select “SOURCE”, the signals of the current input is output.

Tips

- Only signals from components connected to the analog input jacks are output through the 2ND ZONE or 3RD ZONE jacks. No signal is output from components connected to only the digital input jacks.
- When “SOURCE” is selected, the signals input to the MULTI CH IN jacks are not output from the 2ND ZONE or 3RD ZONE jacks even when MULTI CH IN function is used. The 2 channel analog audio signals of the current input is output.

■ INSTALLER MODE (RS232C control)

- ON
The receiver can receive commands from the RS232C port even when the power is off (standby mode).
- OFF
The receiver does not receive commands from the RS232C port when the power is off (standby mode).

■ 12V TRIG. MAIN (12 V trigger for the main receiver)

■ 12V TRIG. 2ND (12 V trigger for the 2nd zone)

■ 12V TRIG. 3RD (12 V trigger for the 3rd zone)

Lets you turn on or off the external equipment by outputting 12V triggers when the receiver is turned on or off. For example, you can automatically unroll your video screen when you turn on the receiver.

• OFF

Lets you turn off output of 12V triggers even when the main receiver is turned on.

• CTRL

Lets you turn on or off the output of 12V triggers manually by the CIS command of the IR remote or RS232C control.

• ZONE

Lets you turn on output of 12V triggers when the main receiver or the receiver in each zone is turned on.

• INPUT (for “12V TRIG. MAIN” only)

Lets you turn on output of 12V triggers when the main receiver is turned on, depending on the setting of each input. See “To set the 12V trigger setting for each input” (page 47).

• MAIN (for “12V TRIG. 2ND” and “12V TRIG. 3RD” only)

Lets you link 2nd or 3rd zone trigger operation to the main receiver.

To set the 12V trigger setting for each input

The initial setting is “ON” for VIDEO 1, VIDEO 2, VIDEO 3, DVD and TV/SAT and “OFF” for other inputs. To set this setting, you can use only the controls on the front panel.

- 1 Select “INPUT” in “12V TRIG. MAIN”.**
- 2 Press MEMORY/ENTER.**
- 3 Rotate MENU to select the input.**
- 4 Rotate –/+ to select “ON” to activate 12V trigger or select “OFF” to deactivate.**
- 5 Press MEMORY/ENTER.**

Storing the adjusted settings

— USER PRESET

You can store the adjusted sound field settings, etc. as USER PRESET up to 3 and can easily apply.

Setting the USER PRESET

- 1 Adjust the sound field, etc.**
For the settings you can store, see “Settings that can be stored in USER PRESET”.
- 2 Rotate MAIN MENU to select “CUSTOMIZE”.**
- 3 Rotate MENU to select “USER PRESET MEM.? [X]”.**
- 4 Rotate -/+ to select the USER PRESET number.**
- 5 Press MEMORY/ENTER.**
- 6 To store other settings, repeat steps 1 to 5.**

Settings that can be stored in USER PRESET

- Input selected by the INPUT SELECTOR
- INPUT MODE setting
- Selected sound field
- MULTI CH IN setting
- DIRECT setting
- C.WIDTH setting
- DIMENSION setting
- PANORAMA MODE setting
- EFFECT LEVEL setting
- FRONT REVERB setting
- SCREEN DEPTH setting
- VIR.SPEAKERS setting
- Tuner settings (band, frequency, stereo/mono setting, preset number)

To use the USER PRESET

- 1 Press USER PRESET repeatedly to select the USER PRESET you want.**
- 2 Press MEMORY/ENTER.**

Note

When the DIGITAL ASSIGN setting is changed after you store a USER PRESET and if the stored INPUT MODE setting cannot be used, a selectable setting is applied automatically.

Example:

- *¹ Use the DIGITAL ASSIGN function to assign “DVD OPT” to “TAPE”.
- *² Set the INPUT MODE of TAPE to “AUTO 2CH” or “OPTICAL FIXED”, then store in the USER PRESET.
- *³ Use the DIGITAL ASSIGN function to assign “DVD OPT” to “DVD”.
- *⁴ Select the USER PRESET stored in example 2). The INPUT MODE of TAPE is automatically set to “ANALOG 2CH FIXED”. You cannot select “AUTO 2CH” or “OPTICAL FIXED”.

Naming preset stations and inputs

You can enter a name of up to 8 characters for preset stations and inputs selected with INPUT SELECTOR, and display it in the receiver's display.

To index a preset station

- 1 Rotate INPUT SELECTOR to select tuner ("FM" or "AM").**
- 2 Press FM/AM to select "FM" or "AM".**
- 3 Tune in the preset station you want to create an index name for (page 26).**
- 4 Rotate MAIN MENU to select "TUNER".**
- 5 Rotate MENU to select "NAME IN?".**
- 6 Press MEMORY/ENTER.**

The cursor flashes and you can select a character. Follow the procedure of "To create an index name" page 49.

To index an input

- 1 Rotate INPUT SELECTOR to select an input you want to create an index name for.**
- 2 Rotate MAIN MENU to select "CUSTOMIZE".**
- 3 Rotate MENU to select "NAME IN?".**
- 4 Press MEMORY/ENTER.**

The cursor flashes and you can select a character. Follow the procedure of "To create an index name" page 49.

To create an index name

- 1 Use MENU and -/+ to create an index name.**

Rotate -/+ to select a character, then rotate MENU to move the cursor to the next position.

Tips

- You can select the character type as follows by rotating -/+.
Alphabet (upper case) → Numbers → Symbols
- To enter a blank space, rotate -/+ until a blank space appears in the display.
- If you made a mistake, rotate MENU until the character you want to change flashes, then rotate -/+ to select the correct character.

- 2 Press MEMORY/ENTER.**

The entered name is registered.

Changing the command mode of the receiver

This function is useful when you use 2 Sony receivers in the same room.

- 1 Turn off the receiver.**
- 2 Hold down INPUT MODE and press I/⏻ to turn on the receiver.**

“COMMAND MODE [AVX]” appears in the display. Each time you repeat the procedure above, the display changes as follows:

COMMAND MODE [AV1] ↔
COMMAND MODE [AV2]

Tip

The initial setting is “COMMAND MODE [AV2]”.

Notes

- The initial setting for the command mode of the supplied remote is “AV2”.
- If the command mode of the receiver and the remote is different, you cannot use the remote to operate the receiver.

Using the Sleep Timer

You can set the receiver to turn off automatically at a specified time by using the remote.

Press ALT, then press SLEEP repeatedly while the power is on.

Each time you select or press SLEEP, the display changes cyclically as follows:
2:00:00 → 1:30:00 → 1:00:00 → 0:30:00 → OFF

While using Sleep Timer, “SLEEP” lights up in the display.

Tip

To check the remaining time before the receiver turns off, press ALT, then press SLEEP. The remaining time appears in the display.

Selecting the speaker system

Set the SPEAKERS switch according to the front speakers you want to drive.

Set to	To select
A	The speakers connected to the FRONT SPEAKERS A terminals.
B	The speakers connected to the FRONT SPEAKERS B terminals.
A+B*	The speakers connected to both the FRONT SPEAKERS A and FRONT SPEAKERS B terminals (parallel connection).
OFF	No speaker output. (All the sound output from SPEAKERS and PRE OUT jacks are turned off.)

* When the IMPEDANCE SELECTOR is set to “8Ω”, connect the speakers with a nominal impedance of 16 ohm or higher. When the IMPEDANCE SELECTOR is set to “4Ω”, connect the speakers with a nominal impedance of 8 ohms or higher. For details, see “Speaker impedance” page 17.

Recording

Before you begin, make sure you have connected all components properly.

Recording on an audio tape or MiniDisc

You can record on a MiniDisc or cassette tape using the receiver. See the operating instructions of your cassette deck or MD deck if you need help.

- 1 Select the component to be recorded.**
- 2 Prepare the component for playing.**
For example, insert a CD into the CD player.
- 3 Insert a blank tape or MD into the recording deck and adjust the recording level, if necessary.**
- 4 Start recording on the recording deck, then start playback on the playback component.**

Notes

- You cannot record a digital audio signal using a component connected to the analog TAPE OUT or MD/DAT OUT jacks. To record a digital audio signal, connect a digital component to the MD/DAT OPTICAL OUT jacks.
- Sound adjustments do not affect the signal output from the TAPE OUT or MD/DAT OUT jacks.
- The analog audio signals of the current input is output from the TAPE OUT or MD/DAT OUT jacks.
- The signals input to the MULTI CH IN jacks are not output from the TAPE OUT or MD/DAT OUT jacks even when MULTI CH IN is being used. The analog audio signals of the current or previously used input are output.

Recording on a video tape

You can record from a VCR, a TV, or an LD player using the receiver. You can also add audio from a variety of audio sources when editing a video tape. See the operating instructions of your VCR if you need help.

- 1 Select the program source to be recorded.**
- 2 Prepare the component for playing.**

For example, insert the laser disc you want to record into the LD player.
- 3 Insert a blank video tape into the VCR (VIDEO 1 or VIDEO 2) for recording.**
- 4 Start recording on the recording VCR, then start playing the video tape or laser disc you want to record.**

Notes

- You cannot record a digital audio signal using a component connected to the analog VIDEO 1 OUT or VIDEO 2 OUT jacks.
- Make sure to make both digital and analog connections to the TV/SAT or DVD inputs. Analog recording is not possible if you make only digital connections.
- Some sources contain copy guards to prevent recording. In this case, you may not be able to record from the sources.
- The analog audio signals of the current input are output from the VIDEO 1 OUT or VIDEO 2 OUT jacks.
- The signals input to the MULTI CH IN jacks are not output from VIDEO 1 OUT or VIDEO 2 OUT jacks even when MULTI CH IN is being used. The analog audio signals of the current or previously used input are output.

Listening to the sound in another zone

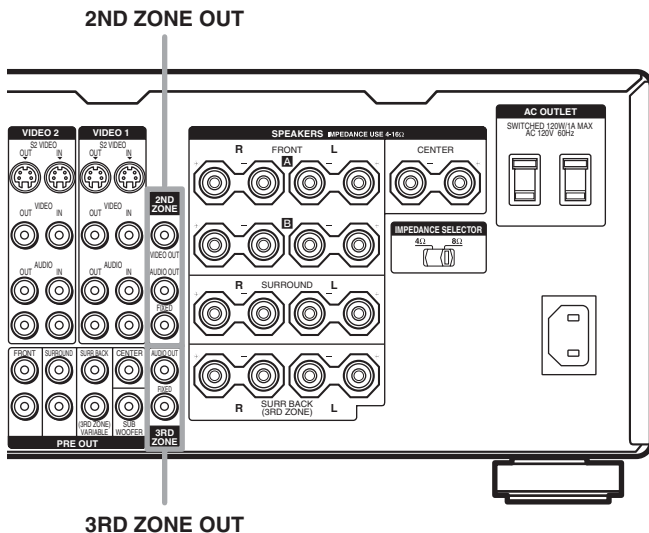

You can select analog audio/video signals for output to the 2nd zone or audio signals for the 3rd zone. For details on the connection, see page 54.

Use the remote RM-US106A for the operation (page 67–71).

1 On the remote, press 2ND ZONE or 3RD ZONE.

The remote switches to the 2nd zone or 3rd zone mode.

2 Press I/⏻.

3 Turn on the amplifier in the 2nd or 3rd zone.

Skip step 3, if you connect the SPEAKERS to the SURR BACK (3RD ZONE) terminals.

4 Press one of the input buttons on the remote to select the source signals you want to output.

For the 2nd zone, analog video and audio signals are output. For the 3rd zone, only analog audio signals are output. When you select “SOURCE”, the signals of the current input are output.

5 Press MASTER VOL +/- on the remote to adjust the volume of the 3rd zone.

You can only adjust the surround back speaker volume in 3rd zone.

The default setting of the volume is $-\infty$ dB (no sound output).

Tips

- Even when this receiver is turned off, the receiver in the 2nd zone or 3rd zone remains turned on. To turn off all receivers, press I/⏻ and AV I/⏻ on the remote at the same time (SYSTEM STANDBY).
- Only signals from components connected to the analog input jacks are output through the 2ND ZONE OUT or 3RD ZONE OUT jacks. No signals are output from components connected to only the digital input jacks.
- When “SOURCE” is selected, the signals input to the MULTI CH IN jacks are not output from the 2ND ZONE OUT or 3RD ZONE OUT jacks even when MULTI CH IN is selected. The analog audio signals of the current function are output.

continued

2nd zone connections

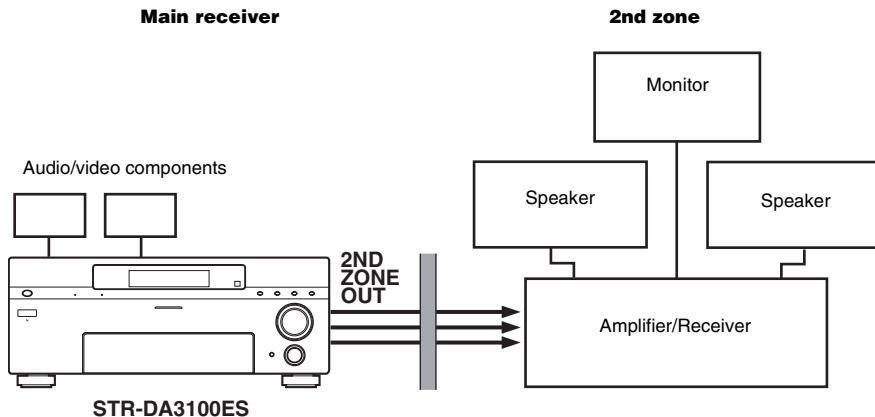

3rd zone connections

1) 3RD ZONE AUDIO OUT jacks

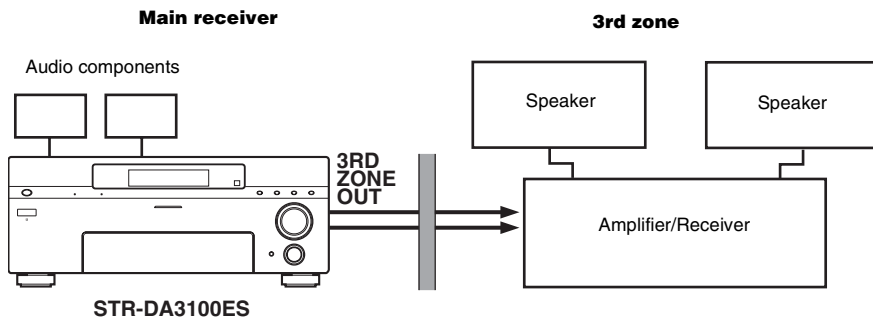

2) SURR BACK (3RD ZONE) SPEAKER terminals

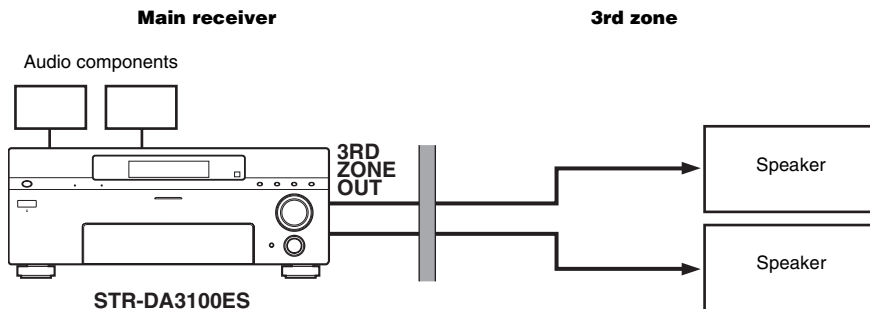

CONTROL S Control System

Using CONTROL S Control System

If you have a CONTROL S-compatible Sony TV, satellite tuner, monitor, DVD player or VCR, use a control S connecting cord (not supplied) to connect the CTRL S IN (for TV, satellite tuner, or monitor) or CTRL S OUT (for VCR, etc.) jack on the receiver to the appropriate CONTROL S jack on the respective component. Refer to the operating instructions supplied with your TV, satellite tuner, monitor, VCR, etc., for details.

If you connect the CTRL S OUT jack on another component to the CTRL S IN jack on this unit

Example

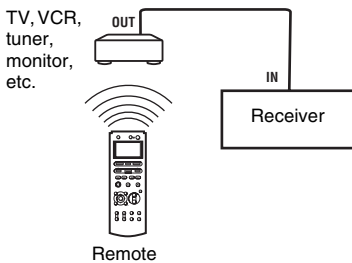

The remote sensor on the CTRL S OUT component receives remote codes the same way as the remote sensor on this unit. This is useful if you have placed this unit in a rack, etc.

If you connect the CTRL S IN jack on another component to the CTRL S OUT jack on this unit

Example

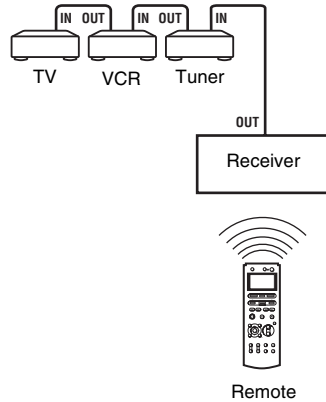

The remote sensor on this unit receives remote codes the same way as the remote sensor on the CTRL S IN component. This is useful if you place the other component away from this unit.

Operations Using the Remote RM-AAE001

You can use the remote RM-AAE001 to operate the components in your system.

Before you use your remote

Inserting batteries into the remote

Insert R6 (size-AA) batteries with the + and – properly oriented in the battery compartment. When using the remote, point it at the remote sensor  on the receiver.

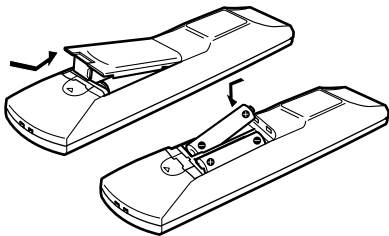

Tip



Under normal conditions, the batteries should last for about 6 months. When the remote no longer operates the receiver, replace all batteries with new ones.

Notes

- Do not leave the remote in an extremely hot or humid place.
- Do not use a new battery with an old one.
- Do not expose the remote sensor to direct sunlight or lighting apparatuses. Doing so may cause a malfunction.
- If you do not use the remote for an extended period of time, remove the batteries to avoid possible damage from battery leakage and corrosion.

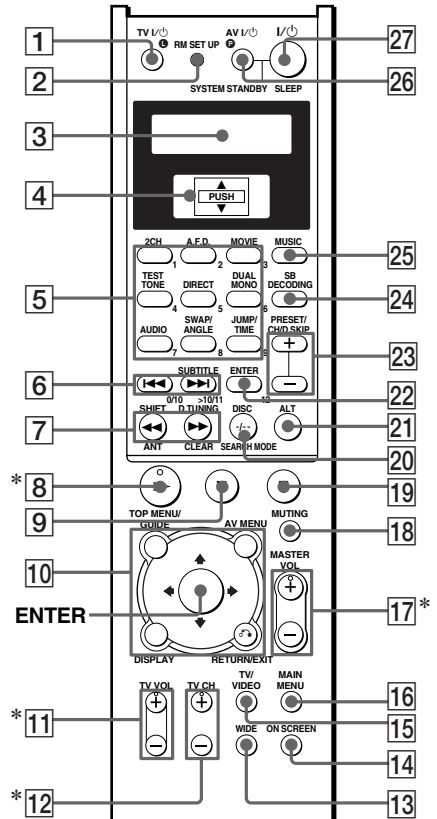
Remote button description



* The ,  and  buttons have a tactile dot. Use the tactile dot as a reference when operating the receiver and other audio/video components.

The tables below show the settings of each button.

Remote Button	Operations	Function
A.F.D. [5]	Receiver	Selects the decoding mode for audio sound.
ALT [21]	Remote	When ALT button lights up, it changes remote key function to activate those buttons with orange printing.
ANT [7]	VCR/ Satellite tuner	Selects output signal from the antenna terminal: TV signal or VCR program.
AUDIO [5]	TV/VCR/ DVD player/ Satellite tuner/ Blu-ray disc recorder/ Hard disc recorder/PSX	Changes the sound to Multiplex, Bilingual or Multi channel TV Sound.
AV MENU [10]	VCR/ Satellite tuner/ DVD player/ Blu-ray disc recorder/ Hard disc recorder/PSX	Displays menu.
AV I/O [26]	TV/VCR/ CD player/ VCD player/ LD player/ DVD player/ MD deck/ Satellite tuner/ Blu-ray disc recorder/ Hard disc recorder/PSX	Turns the audio and video components on or off.
CLEAR [7]	DVD player/ CD player/ Satellite tuner/ Blu-ray disc recorder/PSX	Clears a mistake when you press the incorrect numeric buttons or returns to continuous playback etc.
DIRECT [5]	Receiver	Selects 2CH ANALOG DIRECT.
DISC [20]	CD player/ VCD player	Selects a disc directly (multi-disc changer only).

Remote Button	Operations	Function
Display [3]	Remote	Shows the selected input, macro list and command mode of the remote.
DISPLAY [10]	TV/VCR/ VCD player/ LD player/ DVD player/ Receiver/ CD player/ MD deck/ Blu-ray disc recorder/ Hard disc recorder/PSX/ Satellite tuner	Selects information displayed on the TV screen.
D.TUNING [7]	Receiver	Enters direct tuning mode.
DUAL MONO [5]	Receiver	Selects the language you want during digital broadcast.
Easy scroll key (PUSH) [4]	Remote	Move to select the input and press to enter the selection. The components are factory assigned to the inputs as shown on page 60.
ENTER [10]	Receiver/ VCR/ Satellite tuner/ DVD player	Enters the selection.
ENTER [22]	TV/VCR/ Satellite tuner/ LD player/ MD deck/ DAT deck/ Tape deck/ Blu-ray disc recorder/ Hard disc recorder/PSX	After selecting a channel, disc or track using the numeric buttons, press to enter the value.
JUMP/TIME [5]	TV/ Satellite tuner/ Blu-ray disc recorder	Toggles between the previous and the current channels.
	CD player/ VCD player/ DVD player/ MD deck	Shows the time or displays the playing time of disc, etc.

continued

Remote Button	Operations	Function
MAIN MENU 16	Receiver	Selects the menu of the receiver.
MASTER VOL +/- 17	Receiver	Adjusts the master volume of the receiver.
MOVIE 5	Receiver	Selects the pre-programmed sound fields for movie.
MUSIC 25	Receiver	Selects the pre-programmed sound fields for music.
MUTING 18	Receiver	Mutes the sound from the receiver.
ON SCREEN 14	Receiver	Displays the menus of the receiver on the TV screen.
PRESET/CH/ D.SKIP +/- 23	Receiver TV/VCR/ Satellite tuner/ Blu-ray disc recorder/Hard disc recorder	Selects preset stations. Selects preset channels.
	CD player/ VCD player/ DVD player/ MD deck/ LD player	Skips discs (multi-disc changer only).
RETURN/EXIT 10	VCD player/ LD player/ DVD player Satellite tuner	Returns to the previous menu. Exits the menu.
RM SET UP 2	Remote	To set up the remote.
SB DECODING 24	Receiver	Selects the surround back decoding modes.
SEARCH MODE 20	DVD player	Selects searching mode. Press to select the unit for search (track, index, etc.)
SHIFT 7	Receiver	Selects a memory page for presetting radio stations or tuning to preset stations.





Remote Button	Operations	Function
SLEEP 27	Receiver	Activates the sleep function and the duration which the receiver turns off automatically.
SUBTITLE 6	DVD player	Changes the subtitles.
SWAP*/ANGLE 5	TV DVD player/ Blu-ray disc recorder	Swaps the small and large picture. Selects viewing angle or changes the angles.
SYSTEM STANDBY (Press AV I/⏻ 26 and I/⏻ 27 at the same time)	Receiver/ TV/VCR/ Satellite tuner/ CD player/ VCD player/ LD player/ DVD player/ MD deck/ DAT deck	Turns off the receiver and other Sony audio/video components.
TEST TONE 5	Receiver	Outputs test tone.
TOP MENU/ GUIDE 10	DVD player Satellite tuner/ Blu-ray disc recorder/ Hard disc recorder/PSX	Displays DVD title. Displays guide menu.
TV CH +/- 12	TV	Selects preset TV channels.
TV/VIDEO 15	TV	Selects input signal: TV input or video input.
TV VOL +/- 11	TV	Adjusts the volume of the TV.
TV I/⏻ 1	TV	Turns the TV on or off.
WIDE 13	TV	Selects the wide picture mode.

* Only for Sony TVs with the picture-in-picture function.

Remote Button	Operations	Function
1-9 5 and 0/10 6	Receiver	Use with SHIFT to preset radio station or tuning to preset stations and with D.TUNING for direct tuning.
	CD player/ VCD player/ LD player/ DVD player/ MD deck/ DAT deck	Selects track numbers. 0/10 selects track 10.
	TV/VCR/ Satellite tuner/ Blu-ray disc recorder/ Hard disc recorder/PSX	Selects channel numbers.
2CH 5	Receiver	Selects 2CH STEREO mode.
>10/11 6	CD player/ VCD player/ LD player/ MD deck/ Tape deck/ TV/VCR/ Satellite tuner/ Blu-ray disc recorder/ Hard disc recorder/PSX	Selects track numbers over 10.
-/-- 20	TV/ Satellite tuner/ Blu-ray disc recorder/ Hard disc recorder/PSX	Selects the channel entry mode, either one or two digit.
I/⏻ 27	Receiver	Turns the receiver on or off.
⏮/⏭ 6	VCR/ CD player/ VCD player/ DVD player/ LD player/ MD deck/ DAT deck/ Tape deck/ Blu-ray disc recorder/ Hard disc recorder/PSX	Skips tracks.

Remote Button	Operations	Function
⏮/⏭ 7	CD player/ VCD player/ DVD player/ LD player/ MD deck/ Blu-ray disc recorder/ Hard disc recorder/PSX	Searches tracks in the forward or backward direction.
	VCR/ DAT deck/ Tape deck	Fastforwards or rewinds.
▶ 8	VCR/ CD player/ VCD player/ LD player/ DVD player/ MD deck/ DAT deck/ Tape deck/ Blu-ray disc recorder/ Hard disc recorder/PSX	Starts playback.
⏸ 9	VCR/ CD player/ VCD player/ LD player/ DVD player/ MD deck/ DAT deck/ Tape deck/ Blu-ray disc recorder/ Hard disc recorder/PSX	Pauses playback or record. (Also start recording with components in record standby.)
■ 19	VCR/ CD player/ VCD player/ LD player/ DVD player/ MD deck/ DAT deck/ Tape deck/ Blu-ray disc recorder/ Hard disc recorder/PSX	Stops playback.
⬆/⬇ 10	Receiver	Selects a menu item.
⬅/➡ 10	Receiver	Adjusts or changes the setting.

continued

Remote Button	Operations	Function
 	VCR/ Satellite tuner/ DVD player/ Blu-ray disc recorder/ Hard disc recorder/PSX	Selects a menu item.
 	VCD player/ LD player/ DVD player/ Blu-ray disc recorder/ Hard disc recorder/PSX	Returns to the previous menu or exits the menu.

Selecting the input, macro list and command mode of the remote

Move the Easy scroll key (PUSH) to select the input and press to enter the selection. The components are factory assigned to the inputs as shown below.

Display	Function
VIDEO 1	To watch VCR. (VTR mode 3)
VIDEO 2	To watch VCR. (VTR mode 1)
VIDEO 3	To watch VCR. (VTR mode 2)
DVD	To watch DVD.
TV/SAT	To watch TV programs or satellite tuner.
TAPE	To listen to audio tape.
MD/DAT	To listen to minidisc or DAT deck.
MD/TAPE	To listen to minidisc or audio tape.
SA-CD	To listen to Super Audio CD or compact disc.
TUNER	To listen to radio programs.
PHONO	To listen to turntable.
MULTI	To listen and watch components connected to the MULTI CH IN jacks on the receiver.
M1, M2*	(Macro List)

* For details, see page 66.

Notes

- Some functions explained in this section may not work depending on the model.
- The above explanation is intended to serve as an example only. Therefore, depending on the component the above operation may not be possible or may operate differently than described.
- When you select the input (VIDEO 1, VIDEO 2, VIDEO 3, DVD, TV/SAT), the input mode of the TV might not switch to the corresponding input mode that you want. In this case, press the TV/VIDEO button to switch the input mode of the TV.
- To activate the buttons with orange printing, press ALT first before pressing the buttons.

Selecting the command mode of the remote

Set the remote command mode using the RM SET UP button and Easy scroll key (PUSH). Use a suitable tool to press the RM SET UP button.

Selecting the command mode

You can switch the command mode (AV1 and AV2) of the remote. If the command mode of the receiver and the remote is different, you cannot use the remote to operate the receiver. The initial setting is AV2. To change the command mode of the receiver, see page 75.

- 1 Hold down RM SET UP and press I/⏻.**
- 2 Move the Easy scroll key (PUSH) to select "MAIN".**
- 3 Press PUSH.**
- 4 Move the Easy scroll key (PUSH) to select "AV1" or "AV2".**
- 5 Press PUSH.**

The indicator lights up once (twice for AV2), then the command mode switches. You will be able to see your selection (AV1 or AV2) in the display.

To reset the remote to factory settings

Press I/⏻, AV I/⏻ and MASTER VOL – at the same time.

The indicator flashes 3 times, then goes off.

Note

For details on "Changing the command mode of the receiver", see page 50.

Programming the remote

You can program the remote to control non-Sony components by changing the code. Once the control signals have been memorized, you can use those components as part of your system.

Furthermore, you can also program the remote for Sony components that the remote is unable to control. Note that the remote can only control components that accept infrared wireless control signals.

- 1 Hold down RM SET UP and press AV I/⏻.**
The indicator lights up and "IR SET" appears in the display.
- 2 Move the Easy scroll key (PUSH) to select the input (including TV I/⏻) for the component you want to control.**

For example, if you are going to control a CD player, select SA-CD.

- 3 Press PUSH.**
- 4 Press the numeric buttons to enter the numeric code (or one of the codes if more than one code exists) corresponding to the component and the maker of the component you want to control.**

See the tables on pages 62–64 for information on the numeric code(s) corresponding to the component and the maker of the component (the first digit and the last two digits of the numeric code correspond to the category and the maker's code respectively.)

- 5 Press ENTER.**
Once the numeric code has been verified, the indicator slowly flashes twice and the remote automatically exits the programming mode.
- 6 Repeat steps 1 to 5 to control other components.**

To cancel programming

Press RM SET UP during any step. The remote automatically exits the programming mode.

To activate the input after programming

Press the programmed button to activate the input you want.

If programming is unsuccessful, check the following:

- If the indicator does not light up in step 1, the batteries are weak. Replace both batteries.
- If the indicator flashes 4 times in quick succession while entering the numeric code, an error has occurred. Start again from step 1.

Notes

- The indicator turns off while a valid button is pressed.
- In step 2, if you press TV I/⏻, only TV VOL +/-, TV CH +/-, TV/VIDEO and WIDE buttons are reprogrammed.
- For the numeric codes, only the first three numbers entered are valid.

To clear the memory of the remote

To clear all programmed and learned signals, do the following to reset the remote to factory settings.

Press I/⏻, AV I/⏻ and MASTER VOL – at the same time.

The indicator flashes 3 times, then goes off.

The numeric codes corresponding to the component and the maker of the component

Use the numeric codes in the tables below to control non-Sony components and also Sony components that the remote is normally unable to control. Since the remote signal that a component accepts differs depending on the model and year of the component, more than one numeric code may be assigned to a component. If you fail to program your remote using one of the codes, try using other codes.

Notes

- The numeric codes are based on the latest information available for each brand. There is a chance, however, that your component will not respond to some or all of the codes.
- All of the input buttons on this remote may not be available when used with your particular component.

To control a CD player

Maker	Code(s)
SONY	101, 102, 103
DENON	104, 123
JVC	105, 106, 107
KENWOOD	108, 109, 110
MAGNAVOX	111, 116
MARANTZ	116
ONKYO	112, 113, 114
PANASONIC	115
PHILIPS	116
PIONEER	117
TECHNICS	115, 118, 119

To control a DAT deck

Maker	Code(s)
SONY	203
PIONEER	219

To control an MD deck

Maker	Code(s)
SONY	301
DENON	302
JVC	303
KENWOOD	304

To control a tape deck

Maker	Code(s)
SONY	201, 202
DENON	204, 205
KENWOOD	206, 207, 208, 209
NAKAMICHI	210
PANASONIC	216
PHILIPS	211, 212
PIONEER	213, 214
TECHNICS	215, 216
YAMAHA	217, 218

To control an LD player

Maker	Code(s)
SONY	601, 602, 603
PIONEER	606

To control a video CD player

Maker	Code(s)
SONY	605

To control a VCR

Maker	Code(s)
SONY	701, 702, 703, 704, 705, 706
AIWA*	710, 750, 757, 758
BLAUPUNKT	740
EMERSON	750
GENERAL ELECTRIC	722, 730
HITACHI	722, 729, 741
JVC	726, 727, 728, 736
MAGNAVOX	730, 731, 738
NEC	736
PANASONIC	729, 730, 737, 738, 739, 740
PHILIPS	729, 730, 731
PIONEER	729
RCA/PROSCAN	722, 729, 730, 731, 741, 747
TOSHIBA	747

* If an AIWA VCR does not work even though you enter the code for AIWA, enter the code for Sony instead.

To control a DVD player

Maker	Code(s)
SONY	401, 402, 403
PANASONIC	406, 408
PHILIPS	407
PIONEER	409
TOSHIBA	404
DENON	405

To control a TV

Maker	Code(s)
SONY	501, 502
AIWA	539
DAEWOO	504, 505, 506, 515, 544
FISHER	508
GOLDSTAR	503, 512, 515, 517, 534, 544, 556
GRUNDIG	511, 533, 534
HITACHI	513, 514, 515, 544, 557
ITT/NOKIA	521, 522
JVC	516
MAGNAVOX	503, 518, 544
MITSUBISHI/MGA	503, 519, 527, 544
NEC	503, 520, 544, 554
PANASONIC	509, 524, 553
PHILIPS	515, 518, 557
PIONEER	509, 525, 526, 551
RCA/PROSCAN	510, 523, 529, 544
SAMSUNG	503, 515, 531, 532, 534, 544, 556, 557
SANYO	508, 545
SHARP	535
THOMSON	530, 537, 547, 549
TOSHIBA	535, 539, 541, 551
TELEFUNKEN	537, 547, 549, 558
ZENITH	542, 543

continued

To control a satellite tuner or cable box

Maker	Code(s)
SONY	801, 802, 803, 804
JERROLD/G.I.	806, 807, 808, 809, 810, 811, 812, 813, 814
PANASONIC	818
RCA	805, 819
S. ATLANTA	815, 816, 817

To control a tuner

Maker	Code(s)
SONY	002, 003, 004, 005

To control a hard disc recorder

Maker	Code(s)
SONY	307, 308, 309

To control a blu-ray disc recorder

Maker	Code(s)
SONY	310, 311, 312

To control a PSX

Maker	Code(s)
SONY	313, 314, 315

Learning the commands of your components

By using the Learning function, it is possible for this remote to perform learned commands.

Setting remote control codes that are not stored in the remote

When a remote control code is not one of the presets stored in the remote, it is possible for the remote to learn the code using the Learning function.

- 1 Hold down RM SET UP and press TV I/⏪.**
The indicator lights up and “LEARN” appears in the display.
- 2 Move the Easy scroll key (PUSH) to select the input (including TV I/⏪) for the component you want to control.**
For example, if you are going to learn an operation for a CD player, select SA-CD.
- 3 Press PUSH.**
- 4 Press the button you want to use for the Learning function.**
The indicator turns off while a valid button is pressed, then flashes slowly.
- 5 Point the remote control code receiver section of the remote towards the receiver/transmitter on the remote control to be learned.**

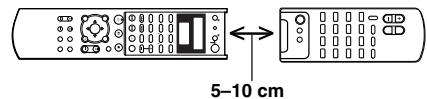

6 Press the appropriate button on the remote control to be learned to send the remote button code.

Lightly pressing the button once should be sufficient.

If learning is completed successfully, the indicator slowly flashes twice and the remote automatically exits the learning mode.

When learning is not completed successfully, the indicator flashes 4 times in quick succession and the procedure returns to step 6.

If the memory of the remote is already full, the indicator flashes 8 times in quick succession and the remote automatically exits the learning mode.

Notes

- You can program more than 80 keys for the Learning function. In some cases, you may not be able to program even if you have not programmed 80 buttons. The number of buttons you can program for each input button are shown in the following table.

Input	Number of Buttons you can program
VIDEO 1, VIDEO 2, DVD	78 keys
VIDEO 3, TV/SAT, TAPE	78 keys
MD/DAT, SA-CD/CD, TUNER	78 keys
PHONO, MULTI CH	52 keys
TV buttons, (TV I/⏻), TV VOL +/-, TV CH +/-, WIDE, TV/VIDEO	7 keys

- In steps 2 and 4, the indicator turns off while a valid button is pressed.
- In step 4, if several buttons that can be used for learning are pressed, only the last pressed button is valid. The indicator flashes slowly, it turns ON while a valid button is pressed.
- In step 6, if a button that can be used for learning is pressed, the new button is selected and the learning procedure returns to the beginning of step 6.

To activate the input source after programming

Press the programmed button to activate the input you want.

To cancel learning

Press RM SET UP during any step. The remote automatically exits the learning mode.

To clear the learned codes

Start over from step 1. After step 4, press TV I/⏻ for more than 2 seconds. The indicator lights up twice slowly and the learned code is cleared. If TV I/⏻ is pressed less than 2 seconds, the learning procedure returns to the beginning of step 6.

When a learned code is cleared, if the button was previously programmed for another input selector, the programmed code for that button can be used.

To clear the memory of the remote

To clear all programmed and learned signals, do the following to reset the remote to factory settings.

Press I/⏻, AV I/⏻ and MASTER VOL – at the same time.

The indicator flashes 3 times, then goes off.

To use a command that has been learned

When selecting a learned input, press the learned button for that input.

Performing several commands in sequence automatically (Macro Play)

The Macro Play function lets you link several IR codes in a sequential order as a single command. The remote provides 2 macro lists (M1 and M2). You can specify up to 10 IR codes for each macro list.

Setting the sequence of IR codes

- 1 Hold down RM SET UP and press TV I/⏻.**

The indicator lights up and “LEARN” appears in the display.
- 2 Move the Easy scroll key (PUSH) to select “M1” or “M2”.**
- 3 Press the numeric buttons to select the macro step number.**

For example, to program step 1, press 1. The indicator flashes slowly.
- 4 Point the remote control code receiver section of the remote towards the receiver/transmitter on the remote control to be learned.**
- 5 Press the appropriate button on the remote control to be learned to send the remote button code.**

Lightly pressing the button once should be sufficient.

If learning is completed successfully, the indicator slowly flashes twice and the remote automatically exits the learning mode.

When learning is not completed successfully, the indicator flashes 4 times in quick succession and the procedure returns to step 5.
- 6 Repeat steps 1 through 5 to program up to 10 IR codes.**

Tip

If programming is unsuccessful, check the following:

- If the indicator does not light up in step 1, the batteries are weak. Replace both batteries.
- If the indicator lights 4 times in quick succession in step 4, an error has occurred. Start again from step 1.

To cancel programming

Press RM SET UP during any step. The remote automatically exits the macro setting mode.

To delay the output of an IR code

Delay each macro step individually. In step 3, press PUSH within 2 seconds.

1 second delay is programmed at this program step. The indicator lights up twice slowly, then the remote automatically exits the macro setting mode.

To clear the programmed IR codes

Clear each macro step individually. In step 3, press PUSH for more than 2 seconds.

The IR code is cleared. The indicator lights up twice slowly, then the remote automatically exits the macro setting mode.

To start macro play

Move the Easy scroll key (PUSH) to select “M1” or “M2”.

Note

If the Macro Play function does not work properly, program a delay between each operation. See “To delay the output of an IR code”.

Operations Using the Remote RM-US106A

You can use the remote RM-US106A to operate 2ND ZONE out and 3RD ZONE out only. You cannot control the receiver directly with this remote.

Before you use your remote

Inserting batteries into the remote

Insert R6 (size-AA) batteries with the + and - properly oriented in the battery compartment.

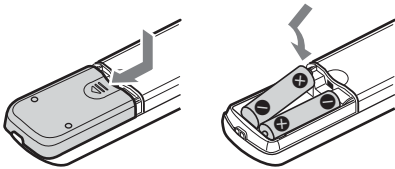

Tip

Under normal conditions, the batteries should last for about 6 months. When the remote no longer operates the receiver, replace all batteries with new ones.

Notes

- Do not leave the remote in an extremely hot or humid place.
- Do not use a new battery with an old one.
- Do not expose the remote sensor to direct sunlight or lighting apparatuses. Doing so may cause a malfunction.
- If you don't use the remote for an extended period of time, remove the batteries to avoid possible damage from battery leakage and corrosion.

Remote button description

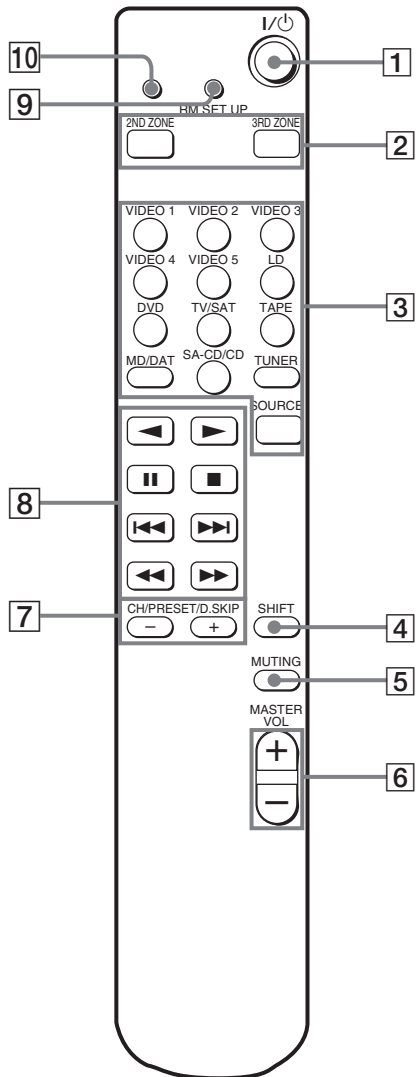

continued

The tables below show the settings of each button.

Remote Button	Operations	Function
CH/	Receiver	Selects preset stations.
PRESET/ D.SKIP	TV/VCR/ Satellite tuner	Selects preset channels.
+/- [7]	CD player/ VCD player/ DVD player/ MD deck	Skips discs (multi-disc changer only).
DVD [3]	Receiver	To select DVD.
LD* [3]	Receiver	To select LD.
MASTER VOL +/- [6]	Receiver	Adjust the volume level of 2ND ZONE or 3RD ZONE output.
MD/DAT [3]	Receiver	To listen to minidisc or DAT deck.
MUTING [5]	Receiver	To mute the sound.
RMSET UP [9]	TV/VCR/ Satellite tuner/ CD player/ VCD player/ DVD player/ MD deck/ DAT deck	To change the category of buttons.
RMSET UP indicator [10]	TV/VCR/ Satellite tuner/ CD player/ VCD player/ DVD player/ MD deck/ DAT deck	Lights up when RM SET UP button in use.
SA-CD/CD [3]	Receiver	To listen to Super Audio CD or compact disc.
SHIFT [4]	Tuner	To select a memory page for presetting radio stations or tuning to preset stations.
SOURCE [3]	Receiver	The current input selected for the main receiver.
TAPE [3]	Receiver	To listen to audio tape.
TUNER [3]	Receiver	To listen to radio programs.
TV/SAT [3]	Receiver	To select TV or satellite tuner.
VIDEO 1 [3]	Receiver	To select VCR. (VTR mode 3)
VIDEO 2 [3]	Receiver	To select VCR. (VTR mode 1)

Remote Button	Operations	Function
VIDEO 3 [3]	Receiver	To select VCR. (VTR mode 2)
VIDEO 4* [3]	Receiver	To select VCR. (VTR mode 4)
VIDEO 5* [3]	Receiver	To select VCR. (VTR mode 5)
2ND ZONE [2]	Receiver	To select the command mode of the remote.
3RD ZONE [2]	Receiver	To select the command mode of the remote.
I/⏻ [1]	Receiver	To turn the receiver in the 2ND ZONE and 3RD ZONE on or off.
⏮/⏭ [8]	CD player/ VCD player/ DVD player/ LD player/ MD deck	Searches tracks in the forward or backward direction.
	VCR/ DAT deck/ Tape deck	Fastforwards or rewinds.
⏮/⏭ [8]	VCR/ CD player/ VCD player/ LD player/ DVD player/ MD deck/ DAT deck/ Tape deck	Skips tracks.
⏮/⏭ [8]	VCR/ CD player/ VCD player/ LD player/ DVD player/ MD deck/ DAT deck/ Tape deck	Starts playback.
⏸ [8]	VCR/ CD player/ VCD player/ LD player/ DVD player/ MD deck/ DAT deck/ Tape deck	Pauses playback or recording. (Also starts recording with components in recording standby.)
■ [8]	VCR/ CD player/ VCD player/ LD player/ DVD player/ MD deck/ DAT deck/ Tape deck	Stops playback.

* The button is not available.

Notes

- Some functions explained in this section may not work depending on the model.
- The above explanation is intended to serve as an example only. Therefore, depending on the component the above operation may not be possible or may operate differently than described.

Changing button assignments

You can change the factory settings of the input buttons to suit the components in your system. For example, if you connect a LD player to the VIDEO 2 jacks on the receiver, you can set the VIDEO 2 button on this remote to control the LD player.

Note, however, that the settings of the TUNER button cannot be changed.

1 Press RM SET UP for more than 2 seconds.

The indicator lights up.

2 Press the input button you want to change the assignment of.

The indicator turns off once and turns on again when a valid button is pressed. Only the first input button that is pressed will be registered.

Example: Press VIDEO 2.

3 Referring to the table below, press the input button for the category you want.

The indicator turns off when a valid button is pressed.

Example: Press DVD twice.

4 Press SOURCE.

The new assignment is registered.

The indicator slowly lights up twice, then goes off.

To cancel

Press RM SET UP during any step.

Tips

- If the operation is unsuccessful, the indicator flashes four times and the remote automatically exits the button assignment mode. In this case, the new assignment is not registered and the previous setting remains.
- Use a suitable tool to press RM SET UP button.

continued

Notes

- If you do not press a button during step 2 through 4 within 60 seconds, the remote automatically exits the button assignment mode. Start again from step 1.
- In step 3, if you press the same button more than the possible number of categories that can be selected, only the last category is registered for the new assignment.

Valid buttons and the corresponding categories

Corresponding categories	Press
VTR-1	VIDEO 1 once
VTR-2	VIDEO 2 once
VTR-3	VIDEO 3 once
VTR-4	VIDEO 1 twice
VTR-5	VIDEO 2 twice
VTR-6	VIDEO 3 twice
DVD player	DVD once
LD player	DVD twice
TV	TV/SAT once
SAT	TV/SAT twice
Tape deck-A	TAPE once
Tape deck-B	TAPE twice
MD deck	MD/DAT once
DAT deck	MD/DAT twice
CD player-1	SA-CD/CD once
CD player-2	SA-CD/CD twice
CD player-3	SA-CD/CD three times
VIDEO CD player	VIDEO1, then SA-CD/CD

To clear all remote button assignments

Hold down RM SET UP, then press I/⏻.

The remote is reset to its factory-setting.

2nd (3rd) zone operations

When using a Sony receiver as an amplifier in the 2nd (or 3rd) zone and it is connected to the main receiver using an IR repeater (not supplied) as shown below, the following operations are possible.

- Switching the output source for the 2ND (or 3RD) ZONE OUT jacks.
- Switching the Sony receiver's power on or off in the 2nd (or 3rd) zone.
- Adjusting the volume of the Sony receiver in the 2nd (or 3rd) zone.

Perform the following operation to set the command mode of the remote to 2ND ZONE or 3RD ZONE.

Press 2ND ZONE or 3RD ZONE.

The command mode has been set to the 2nd or 3rd zone mode.

Example of controlling the amplifier in the 2nd room

To	Do the following
Turn the power on or off	Press I/⏻.
Listen to the sound of the SA-CD/CD player connected to the SA-CD/CD input jacks	Press SA-CD/CD, then press ▶.
Adjust the volume	Press MASTER VOLUME +/-.

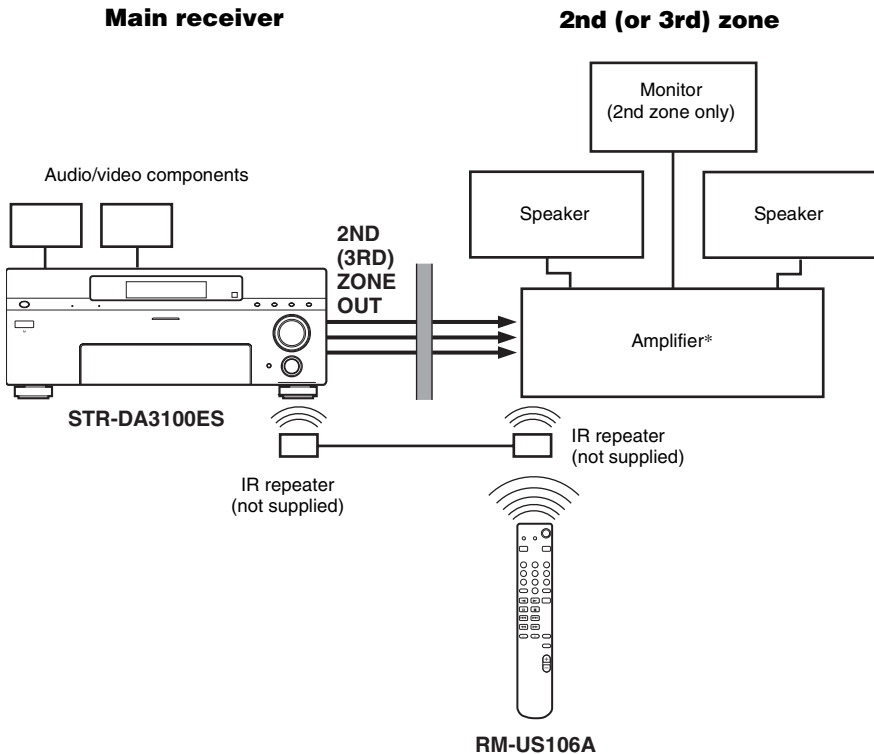

* You can connect the speakers directly to SPEAKERS SURR BACK (3RD ZONE) terminals.

Additional Information

Precautions

On safety

Should any solid object or liquid fall into the cabinet, unplug the receiver and have it checked by qualified personnel before operating it any further.

On power sources

- Before operating the unit, check that the operating voltage is identical with your local power supply. The operating voltage is indicated on the nameplate at the rear of the receiver.
- The unit is not disconnected from the AC power source (mains) as long as it is connected to the wall outlet, even if the unit itself has been turned off.
- If you are not going to use the receiver for a long time, be sure to disconnect the receiver from the wall outlet. To disconnect the AC power cord, grasp the plug itself; never pull the cord.
- One blade of the plug is wider than the other for the purpose of safety and will fit into the wall outlet only one way. If you are unable to insert the plug fully into the outlet, contact your dealer.
- AC power cord must be changed only at the qualified service shop.

On heat buildup

Although the unit heats up during operation, this is not a malfunction. If you continuously use this unit at a large volume, the cabinet temperature of the top, side and bottom rises considerably. To avoid burning yourself, do not touch the cabinet.

On placement

- Place the receiver in a location with adequate ventilation to prevent heat buildup and prolong the life of the receiver.
- Do not place the receiver near heat sources, or in a place subject to direct sunlight, excessive dust or mechanical shock.
- Do not place anything on top of the cabinet that might block the ventilation holes and cause malfunctions.

On operation

Before connecting other components, be sure to turn off and unplug the receiver.

On cleaning

Clean the cabinet, panel and controls with a soft cloth slightly moistened with a mild detergent solution. Do not use any type of abrasive pad, scouring powder or solvent such as alcohol or benzine.

If you have any question or problem concerning your receiver, please consult your nearest Sony dealer.

Troubleshooting

If you experience any of the following difficulties while using the receiver, use this troubleshooting guide to help you remedy the problem. Should any problem persist, consult your nearest Sony dealer.

There is no sound no matter which component is selected.

- Check that both the receiver and all components are turned on.
- Check that the MASTER VOLUME control is not set at $-\infty$ dB.
- Check that the SPEAKERS is not set to “OFF” (page 51).
- Check that all speaker cords are connected correctly.
- Press MUTING on the remote to cancel the muting function.

There is no sound from a specific component.

- Check that the component is connected correctly to the audio input jacks for that component.
- Check that the cord(s) used for the connection is (are) fully inserted into the jacks on both the receiver and the component.

There is no sound from one of the front speakers.

- Connect a pair of headphones to the PHONES jack to verify that sound is output from the headphones. If only one channel is output from the headphones, the component may not be connected to the receiver correctly. Check that all the cords are fully inserted into the jacks on both the receiver and the component. If both channels are output from the headphones, the front speaker may not be connected to the receiver correctly. Check the connection of the front speaker which is not outputting any sound.
- Make sure you have not connected only the L or R jack to a monaural component. Use a monaural-stereo cable (not supplied) and connect it to both the L and R jacks. However, there will be no sound from the center speaker when a sound field (PRO LOGIC, etc.) is selected. When the center speaker is set to “NO”, sound is output only from front L/R speakers.

There is no sound or only a very low-level sound is heard.

- Check that the speakers and components are connected securely.
- Check that you have selected the correct component with INPUT SELECTOR.
- Check that the SPEAKERS is not set to “OFF” (page 51).
- Check that the headphones are not connected.
- Press MUTING on the remote to cancel the muting function.
- The protective device on the receiver has been activated. Turn off the receiver, eliminate the short-circuit problem and turn on the power again.

There is no sound from analog 2 channel sources.

- Check that the DIGITAL ASSIGN function is not used to assign the audio input of other input to the selected input (page 37).
- Check that the INPUT MODE is not set to “COAXIAL FIXED” nor “OPTICAL FIXED” for the selected input (page 38).
- Check that the MULTI CH IN function is not selected.

There is no sound from digital sources (from COAXIAL or OPTICAL input jack).

- Check that the DIGITAL ASSIGN function is not used to assign the audio input of other input to the selected input (page 37).
- Check that the INPUT MODE is not set to “ANALOG 2CH FIXED” (page 38). Check that the INPUT MODE is not set to “COAXIAL FIXED” for the sources from OPTICAL input jack, nor set to “OPTICAL FIXED” for the sources from COAXIAL input jack.
- Check that the MULTI CH IN function is not selected.

The left and right sounds are unbalanced or reversed.

- Check that the speakers and components are connected correctly and securely.
- Adjust balance parameters in the LEVEL menu.

There is severe hum or noise.

- Check that the speakers and components are connected securely.
- Check that the connecting cords are away from a transformer or motor, and at least 3 meters away from a TV set or fluorescent light.
- Move your TV away from the audio components.
- Make sure you have grounded \hbar SIGNAL GND terminal (only when a turntable is connected).
- The plugs and jacks are dirty. Wipe them with a cloth slightly moistened with alcohol.

There is no sound from the center speaker.

- Make sure the sound field function is on (press A.F.D., MOVIE or MUSIC).
- Select the CINEMA STUDIO EX mode (page 32).
- Adjust the speaker level (page 23, 39).
- Make sure the center speaker is set to either “SMALL” or “LARGE” (page 20).

There is no sound from the surround back speakers.

- Some discs have no Dolby Digital EX flag even though the packages have Dolby Digital EX logos. In this case, set “SB DECODING” to ON (page 41).

There is no sound or only a very low-level sound is heard from the surround/surround back speakers.

- Make sure the sound field function is on (press A.F.D., MOVIE or MUSIC).
- Select a CINEMA STUDIO EX mode (page 32).
- Adjust the speaker level (page 23, 39).
- Make sure the surround speakers are set to either “SMALL” or “LARGE” (page 21).
- Make sure the surround back speaker is set to either “DUAL” or “SINGLE” (page 21).

There is no sound from sub woofer.

- When all speakers are set to “LARGE” and “Neo:6 Cinema” or “Neo:6 Music” is selected, there is no sound from the sub woofer.

The surround effect cannot be obtained.

- Make sure the sound field function is on (press A.F.D., MOVIE or MUSIC).
- Sound fields do not function for the signals with a sampling frequency of more than 48 kHz.

Dolby Digital or DTS multi channel sound is not reproduced.

- Check that the playing DVD, etc. is recorded in Dolby Digital or DTS format.
- When connecting the DVD player, etc. to the digital input jacks of this receiver, check the audio setting (settings for the audio output) of the connected component.

Recording cannot be done.

- Check that the components are connected correctly.
- Select the source component with INPUT SELECTOR.

The FM reception is poor.

- Use a 75-ohm coaxial cable (not supplied) to connect the receiver to an outdoor FM antenna as shown below. If you connect the receiver to an outdoor antenna, ground it against lightning. To prevent a gas explosion, do not connect the ground wire to a gas pipe.

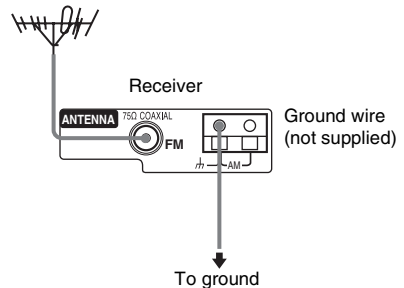
Outdoor FM antenna

Radio stations cannot be tuned in.

- Check that the antennas are connected securely. Adjust the antennas and connect an external antenna if necessary.
- The signal strength of the stations is too weak (when tuning in with automatic tuning). Use direct tuning.
- Make sure you set the tuning interval correctly (when tuning in AM stations with direct tuning).
- No stations have been preset or the preset stations have been cleared (when tuning by scanning preset stations). Preset the stations (page 26).
- Press DISPLAY so that the frequency appears in the display.

There is no picture or an unclear picture appears on the TV screen or monitor.

- Select the appropriate input on the receiver.
- Set your TV to the appropriate input mode.
- Move your TV away from the audio components.
- Connect your TV to the receiver using the same type of connecting cord as the one used to connect the receiver and video component (pages 8, 11 and 13).

Remote control

The remote does not function.

- Point the remote at the remote sensor on the receiver.
- Remove any obstacles in the path between the remote and the receiver.
- Replace all the batteries in the remote with new ones, if they are weak.
- Check if the command modes of the receiver and the remote is the same. If the command mode of the receiver and the remote is different, you cannot operate the receiver with the remote. To switch the command mode of the receiver, press **I/⏪** while pressing INPUT MODE. Each time you press **I/⏪**, the command mode switches between “COMMAND MODE [AV2]” and “COMMAND MODE [AV1]”. (The initial setting is “COMMAND MODE [AV2]”.) To switch the command mode of the remote, see “Selecting the command mode of the remote” on page 61.
- Make sure you select the correct input on the remote.

Error messages

If there is a malfunction, the display shows a code of two numbers and a message. You can check the condition of the system by the message. Refer to the following table to solve the problem. If any problem persists, consult your nearest Sony dealer.

DECODE ERROR/CHECK CODE 01

Appears when the signal which the receiver cannot decode (ex. DTS-CD) is input when “DEC. PRIORITY” in the CUSTOMIZE menu is set to “PCM”. Set to “AUTO”.

PROTECTOR/CHECK CODE 11

Irregular current is output from the speakers. The receiver will automatically turn off after a few seconds. Check the speaker connection and turn on the power again. If this problem persists, turn off the receiver and consult your nearest Sony dealer.

Reference sections for clearing the memory

To clear	See
All memorized settings	page 19
Customized sound fields	page 40

Specifications

AUDIO POWER SPECIFICATIONS

POWER OUTPUT AND TOTAL HARMONIC DISTORTION: (Models of area code U only)

With 8 ohm loads, both channels driven, from 20 – 20,000 Hz; rated 120 watts per channel minimum RMS power, with no more than 0.05% total harmonic distortion from 250 milliwatts to rated output.

Amplifier section

POWER OUTPUT

Rated Power Output at Stereo Mode¹⁾
(8 ohms 20 Hz – 20 kHz, THD 0.05%)
120 W + 120 W
(4 ohms 20 Hz – 20 kHz, THD 0.09%)
100 W + 100 W

Reference Power Output¹⁾

(8 ohms 20 Hz – 20 kHz, THD 0.05%)
FRONT²⁾: 120 W + 120 W
CENTER²⁾: 120 W
SURR²⁾: 120 W + 120 W
SURR BACK²⁾: 120 W + 120 W
(4 ohms 20 Hz – 20 kHz, THD 0.09%)
FRONT²⁾: 100 W + 100 W
CENTER²⁾: 100 W
SURR²⁾: 100 W + 100 W
SURR BACK²⁾: 100 W + 100 W

1) Measured under the following conditions:
120 V AC, 60 Hz

2) Depending on the sound field settings and the source, there may be no sound output.

Frequency response

PHONO	RIAA equalization curve ±0.5 dB
MULTI CH IN, SA-CD/CD, TAPE, MD/DAT, DVD, TV/SAT, VIDEO 1, 2, 3	10 Hz – 100 kHz +0.5/ -2 dB (When MULTI CH IN DIRECT and ANALOG DIRECT is activated)

Inputs (Analog)

PHONO	Sensitivity: 2.5 mV Impedance: 50 k Ohms S/N ³ : 86 dB (A, 2.5 mV ⁴)
MULTI CH IN, SA-CD/CD, TAPE, MD/DAT, DVD, TV/SAT, VIDEO 1, 2, 3	Sensitivity: 150 mV Impedance: 50 k Ohms S/N ³ : 100 dB (A, 150 mV ⁴)

3) INPUT SHORT.

4) Weighted network, input level.

Inputs (Digital)

SA-CD/CD, DVD (Coaxial)	Impedance: 75 Ohms S/N: 100 dB (A, 20 kHz LPF)
SA-CD/CD, DVD, TV/SAT, MD/DAT, VIDEO3 (Optical)	S/N: 100 dB (A, 20 kHz LPF)

Outputs

TAPE, MD/DAT (REC OUT), VIDEO 1, 2 (AUDIO OUT)	Voltage: 150 mV Impedance: 10 k Ohms
FRONT L/R, CENTER, SURROUND L/R, SURROUND BACK (L/R), SUB WOOFER	Voltage: 2 V Impedance: 1 k Ohms

EQUALIZER

Gain levels	±10 dB, 1 dB step
-------------	-------------------

FM tuner section

Tuning range	87.5 - 108.0 MHz
Antenna	FM wire antenna
Antenna terminals	75 ohms, unbalanced
Sensitivity	
Mono:	18.3 dBf, 2.2 μV/75 ohms
Stereo:	38.3 dBf, 22.5 μV/75 ohms
Useable sensitivity	11.2 dBf, 1 μV/75 ohms
S/N	
Mono:	76 dB
Stereo:	70 dB
Harmonic distortion at 1 kHz	
Mono:	0.3%
Stereo:	0.5%
Separation	45 dB at 1 kHz
Frequency response	30 Hz - 15 kHz, +0.5/-2 dB
Selectivity	60 dB at 400 kHz

AM tuner section

Tuning range	530 - 1,710 kHz ⁵ (With 10-kHz tuning scale) 531 - 1,710 kHz ⁵ (With 9-kHz tuning scale)
Antenna	Loop antenna
Usable sensitivity	50 dB/m (at 1,000 kHz or 999 kHz)
S/N	54 dB (at 50 mV/m)
Harmonic distortion	0.5% (50 mV/m, 400 Hz)
Selectivity	
At 9 kHz:	35 dB
At 10 kHz:	40 dB

5) You can change the AM tuning scale to 9 kHz or 10 kHz. After tuning in any AM station, turn off the receiver. While holding down PRESET TUNING + or TUNING +, press I/⏪. All preset stations will be erased when you change the tuning scale. To reset the scale to 10 kHz (or 9 kHz), repeat the procedure.

Video section

Inputs/Outputs

Video:	1 Vp-p, 75 ohms
S-video:	Y: 1 Vp-p, 75 ohms C: 0.286 Vp-p, 75 ohms
COMPONENT VIDEO:	Y: 1 Vp-p, 75 ohms P _B /C _B /B-Y: 0.7 Vp-p, 75 ohms P _R /C _R /R-Y: 0.7 Vp-p, 75 ohms 80 MHz HD Pass Through

General

Power requirements	120 V AC, 60 Hz
--------------------	-----------------

Power consumption

Area code	Power consumption
U	450 W
CA	490 VA

Power consumption (during standby mode)

	1 W
AC outlets	2 switched, 120 W/1A MAX
Dimensions	430 × 175 × 470 mm including projecting parts and controls
Mass (Approx.)	21.0 kg

Supplied accessories

FM wire antenna (1)

AM loop antenna (1)

AC power cord (1)

Remote commander RM-AAE001 (1)

Remote commander RM-US106A (1)

R6 (size-AA) batteries (4)

For details on the area code of the component you are using, see page 3.

Design and specifications are subject to change without notice.

List of button locations and reference pages

How to use this page

Use this page to find the location of buttons and other parts of the system that are mentioned in the text.

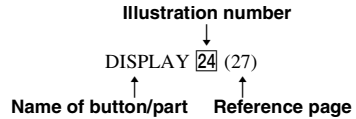

Main unit

ALPHABETICAL ORDER

A.F.D. **7** (30, 31, 34)
BASS **34** (41)
DECODE PRIORITY **25** (42)
Digital Cinema Sound indicator
5
DIMMER indicator **3** (42)
DIRECT **26** (34)
DIRECT indicator **2** (34)
DISPLAY **24** (27)
Display **4** (28)
ESCUTCHEON LID **15**
FM/AM **21** (25, 49)
INPUT MODE **12** (38, 50)
INPUT SELECTOR **11** (24, 25,
26, 38, 49)
IR receptor **16**
MAIN MENU **32** (20, 25, 27, 37,
38, 39, 40, 41, 47, 48, 49)
MASTER VOLUME **10** (24)
MEMORY/ENTER **22** (26, 37,
49)
MENU **31** (20, 25, 27, 37, 38, 39,
40, 41, 47, 48, 49)
MOVIE **8** (32)
MULTI CH IN **27** (24)
MULTICHANNEL DECODING
indicator **14**
MUSIC **9** (33, 40)
PHONES jack **17**
PRESET TUNING -/+ **19** (26)
SPEAKERS switch **18** (51)
SURR BACK DECODING **28**
(34)
TREBLE **33** (41)
TUNING -/+ **20** (25)
USER PRESET **23** (48)
VIDEO 3 INPUT jacks **29** (13)

NUMBERS AND SYMBOLS

2CH **6** (30)
I/⏻ (power) **1** (19, 20, 50)
-/+ **30** (20, 25, 37, 38, 39, 40, 41,
47, 48, 49)
▼ OPEN **13**

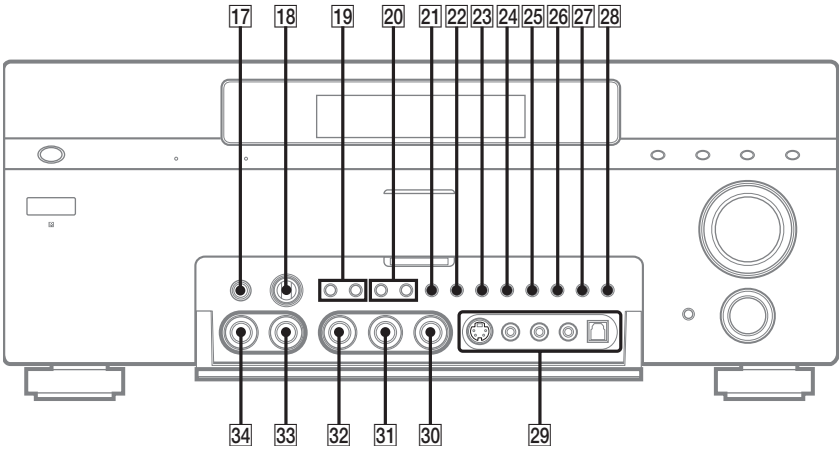
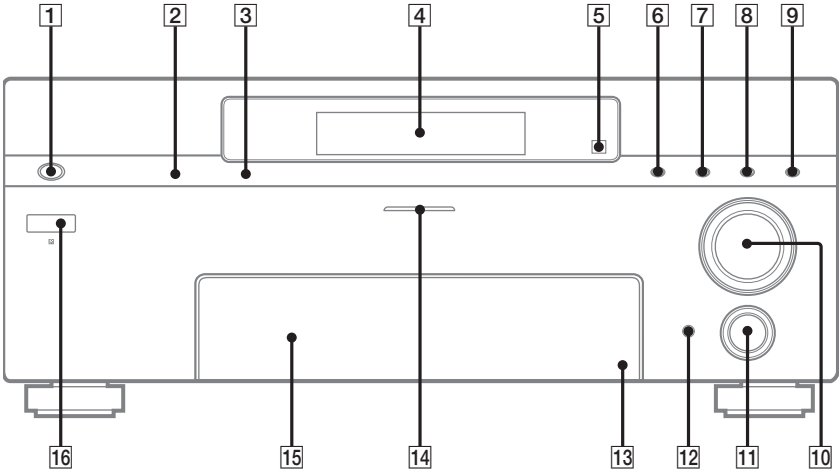

Index

A

- Adjusting
 - CIS parameters 47
 - CUSTOMIZE parameters 41
 - EQUALIZER parameter 40
 - LEVEL parameter 23, 39, 46
 - speaker level 23
 - SPEAKER SET UP parameters 20, 43
 - SURR SET UP parameters 39, 45
- Automatic tuning 25

C

- Changing
 - display 27
 - effect level 39
- CIS 47
- CIS menu 47
- Clearing receiver's memory 19
- CONTROL S 55
- Crossover frequency 44
- CUSTOMIZE menu 41

D

- Digital Cinema Sound 32
- Direct tuning 25
- DUAL MONO 42
- Dubbing. *See* Recording

E

- Editing. *See* Recording
- Effect level 39
- EQUALIZER menu 40

I

- Indexing. *See* Naming

L

- Labeling. *See* Naming
- LEVEL menu 39, 46

N

- Naming 49

P

- Preset stations
 - how to 26
 - how to tune 26

R

- Recording
 - on a video tape 52
 - on an audio tape or MD 51

S

- Selecting
 - component 24
 - front speaker system 51
 - sound field 32–33
- Sleep Timer 50
- Sound field
 - customizing 39
 - pre-programmed 32–33
 - resetting 40
 - selecting 32–33
- SPEAKER SET UP menu 20, 43
- Speakers
 - adjusting speaker volume 23
 - connection 15
 - impedance 17
 - placement 15, 18
- Supplied accessories 77
- SURR SET UP menu 39, 45

T

- Test tone 23
- TUNER menu 25, 49
- Tuning
 - automatically 25
 - directly 25
 - preset stations 26

Free Manuals Download Website

<http://myh66.com>

<http://usermanuals.us>

<http://www.somanuals.com>

<http://www.4manuals.cc>

<http://www.manual-lib.com>

<http://www.404manual.com>

<http://www.luxmanual.com>

<http://aubethermostatmanual.com>

Golf course search by state

<http://golfingnear.com>

Email search by domain

<http://emailbydomain.com>

Auto manuals search

<http://auto.somanuals.com>

TV manuals search

<http://tv.somanuals.com>