

SONY

3-860-902-13(1)

FM Stereo FM-AM Receiver

Operating Instructions

STR-DA80ES

© 1997 by Sony Corporation

WARNING

To prevent fire or shock hazard, do not expose the unit to rain or moisture.

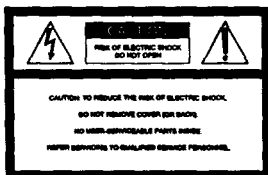

This symbol is intended to alert the user to the presence of uninsulated "dangerous voltage" within the product's enclosure that may be of sufficient magnitude to constitute a risk of electric shock to persons.



This symbol is intended to alert the user to the presence of important operating and maintenance (servicing) instructions in the literature accompanying the appliance.

INFORMATION

This equipment has been tested and found to comply with the limits for a Class B digital device, pursuant to Part 15 of the FCC Rules.

These limits are designed to provide reasonable protection against harmful interference in a residential installation. This equipment generates, uses, and can radiate radio frequency energy and, if not installed and used in accordance with the instructions, may cause harmful interference to radio communications. However, there is no guarantee that interference will not occur in a particular installation. If this equipment does cause harmful interference to radio or television reception, which can be determined by turning the equipment off and on, the user is encouraged to try to correct the interference by one or more of the following measures:

- Reorient or relocate the receiving antenna.
- Increase the separation between the

equipment and receiver.

- Connect the equipment into an outlet on a circuit different from that to which the receiver is connected.
- Consult the dealer or an experienced radio/TV technician for help.

CAUTION

You are cautioned that any changes or modification not expressly approved in this manual could void your authority to operate this equipment.

Note to CATV system installer:

This reminder is provided to call CATV system installer's attention to Article 820-40 of the NEC that provides guidelines for proper grounding and, in particular, specifies that the cable ground shall be connected to the grounding system of the building, as close to the point of cable entry as practical.

Owner's Record

The model and serial numbers are located on the rear of the unit. Record the serial number in the space provided below. Refer to them whenever you call upon your Sony dealer regarding this product.

Model No. STR-DA80ES

Serial No. _____

For the customers in Canada

CAUTION

TO PREVENT ELECTRIC SHOCK, DO NOT USE THIS POLARIZED AC PLUG WITH AN EXTENSION CORD, RECEPTACLE OR OTHER OUTLET UNLESS THE BLADES CAN BE FULLY INSERTED TO PREVENT BLADE EXPOSURE.

Precautions

On safety

- Should any solid object or liquid fall into the cabinet, unplug the receiver and have it checked by qualified personnel before operating it any further.

On power sources

- Before operating the receiver, check that the operating voltage is identical with your local power supply. The operating voltage is indicated on the nameplate at the rear of the receiver.
- The receiver is not disconnected from the AC power source as long as it is connected to the wall outlet, even if the receiver itself has been turned off.
- If you are not going to use the receiver for a long time, be sure to disconnect the receiver from the wall outlet. To disconnect the AC power cord, grasp the plug itself; never pull the cord.
- One blade of the plug is wider than the other for the purpose of safety and will fit into the wall outlet only one way. If you are unable to insert the plug fully into the outlet, contact your dealer.
- Should the AC power cord need to be changed, have it done at a qualified service shop only.

On placement

- Place the receiver in a location with adequate ventilation to prevent heat buildup and prolong the life of the receiver.
- Do not place the receiver near heat sources, or in a place subject to direct sunlight, excessive dust or mechanical shock.
- Do not place anything on top of the cabinet that might block the ventilation holes and cause malfunctions.

On operation

- Before connecting other components, be sure to turn off and unplug the receiver.

On cleaning

- Clean the cabinet, panel and controls with a soft cloth slightly moistened with a mild detergent solution. Do not use any type of abrasive pad, scouring powder or solvent such as alcohol or benzene.

If you have any question or problem concerning your receiver, please consult your nearest Sony dealer.

About This Manual

The instructions in this manual are for model STR-DA80ES. In this manual, the USA and Canadian STR-DA80ES is used for illustration purposes unless stated otherwise. Any difference in operation is clearly indicated in the text, for example, "USA and Canadian models only."

Conventions

- The instructions in this manual describe the controls on the receiver. You can also use the controls on the remote if they have the same or similar names as those on the receiver.
- A "Quick Reference Guide" is supplied on page 39.
- The "Remote Button Descriptions" section on page 36 provides an overview of the remote buttons.
- The following icons are used in this manual:



Indicates that you can use only the remote to do the task.



Indicates hints and tips for making the task easier.

This receiver incorporates the Dolby* Pro Logic Surround system.

- * Manufactured under license from Dolby Laboratories Licensing Corporation. DOLBY, the double-D symbol , "AC-3," and "PRO LOGIC" are trademarks of Dolby Laboratories Licensing Corporation.

TABLE OF CONTENTS

Getting Started

Unpacking	4
Hookup Overview	4
Antenna Hookups	5
Audio Component Hookups	6
Speaker System Hookups	7
TV/VCR Hookups	9
Digital Component Hookups	10
AC Hookups	12
Before You Use Your Receiver	12

Receiver Operations

Selecting a Component	13
Receiving Broadcasts	15
Presetting Radio Stations	16
Indexing Preset Stations and Program Sources	17
Recording	18
Using the Sleep Timer	19

Dolby Surround Setup

Dolby Digital	20
---------------	----

Sound Adjustment

Using Pre-programmed Sound Fields	22
Customizing the Sound Fields	24

Advanced Remote Operations

Operating One Component While Using Another (background operation)	28
Changing the Factory Setting of a FUNCTION Button	28
Programming the Remote	29

Additional Information

Troubleshooting	30
Specifications	31
Glossary	33
Table of Functions of the SET UP Button	34
Rear Panel Descriptions	35
Remote Button Descriptions	36

Index

Quick Reference Guide

Getting Started

Unpacking

Check that you received the following items with the receiver:

- FM wire antenna (1)
- AM loop antenna (1)
- Remote commander RM-P501 (remote) (1)
- Size AA (R6) batteries (2)

Inserting batteries into the remote

Insert two size AA (R6) batteries with the + and - on the battery compartment. When using the remote, point it at the remote sensor ■ on the receiver.

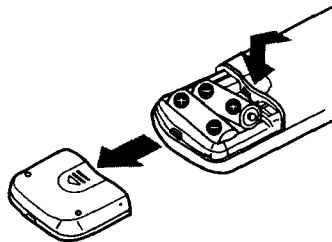

⚡ When to replace batteries

Under normal use, the batteries should last for about 6 months. When the remote no longer operates the receiver, replace both batteries with new ones.

Notes

- Do not leave the remote in an extremely hot or humid place.
- Do not use a new battery with an old one.
- Do not expose the remote sensor to direct sunlight or lighting apparatuses. Doing so may cause a malfunction.
- If you don't use the remote for an extended period of time, remove the batteries to avoid possible damage from battery leakage and corrosion.

Hookup Overview

The receiver allows you to connect and control the following audio/video components. Follow the hookup procedures for the components that you want to connect to the receiver on the pages specified. To learn the locations and names of each jacks, see "Rear Panel Descriptions" on page 35.

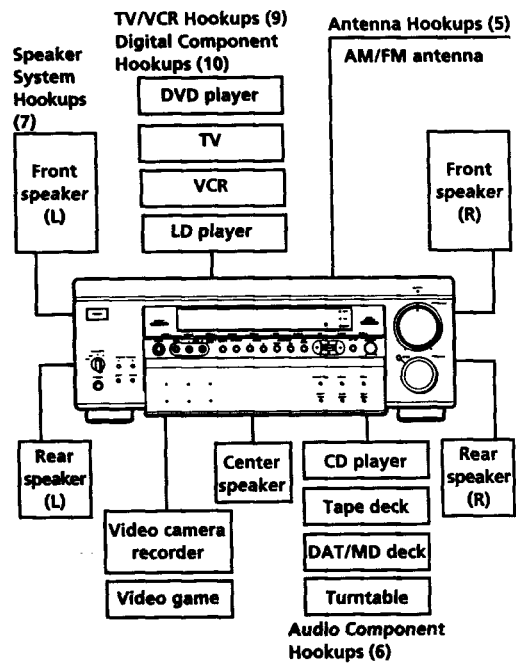

Before you get started

- Turn off the power to all components before making any connections.
- Do not connect the AC power cords until all of the connections are completed.
- Be sure to make connections firmly to avoid hum and noise.
- When connecting an audio/video cable, be sure to match the color-coded pins to the appropriate jacks on the components: Yellow (video) to Yellow; White (left, audio) to White; and Red (right, audio) to Red.

Antenna Hookups

Overview

This section describes how to connect AM and FM antennas to the receiver. If you want to receive radio broadcasts with the receiver, complete these connections first, then go to the following pages.

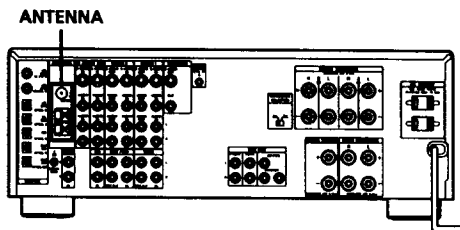

What antennas will I need?

- FM wire antenna (supplied) (1)
- AM loop antenna (supplied) (1)



Hookups

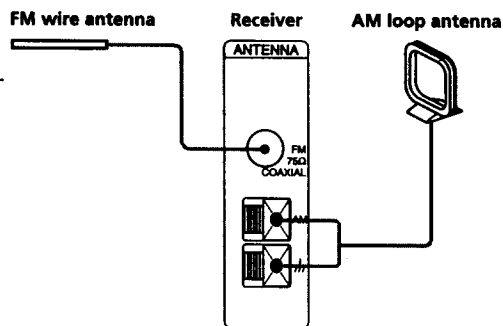

After connecting the wire antenna, keep it as horizontal as possible.

- 💡 **If you have poor FM reception**
Connect a 75-ohm coaxial cable (not supplied) to an FM outdoor antenna.

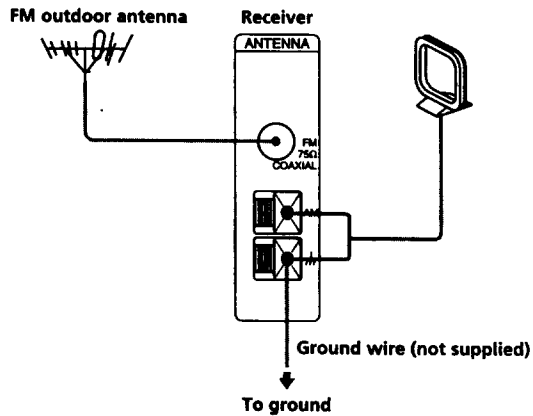

Important

If you connect an outdoor antenna, ground it against lightning. To prevent a gas explosion, do not connect the ground wire to a gas pipe.

Notes

- Do not use \neq SIGNAL GND for this connection.
- To prevent noise pickup, keep the AM loop antenna away from the receiver and TV.

Getting Started

Audio Component Hookups

Overview

This section describes how to connect your audio components to the receiver. If you want to use the receiver as an amplifier, complete these connections. For digital connections, see "Digital Component Hookups" on page 10.

S-LINK CTRL A1 IN (USA and Canadian models only)

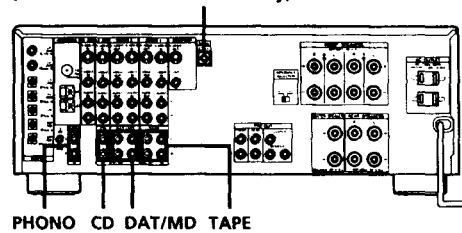

What cords will I need?

Audio cords (not supplied) (1 for each CD player and turntable; 2 for each tape deck, DAT deck, or MD deck)

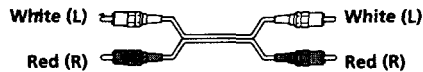

Hookups

The arrow  indicates signal flow.

CD player

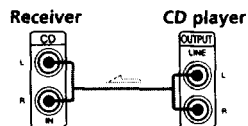

Tape deck

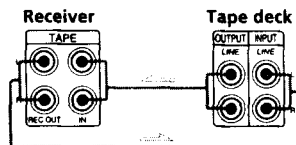

DAT deck or MD deck

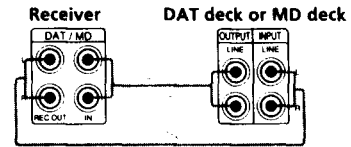

Turntable

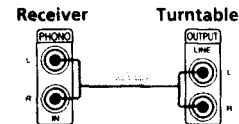

If your turntable has an earth lead

To prevent hum, connect the earth lead to the ϕ SIGNAL GND terminal on the receiver.

CONTROL A1 Hookups (USA and Canadian models only)

- If you have a CONTROL A1 compatible Sony CD player, tape deck, or MD deck

Use a CONTROL A1 cord (not supplied) to connect the S-LINK CTRL A1 jack on the CD player, tape deck, or MD deck to the S-LINK CTRL A1 jack on the receiver. Refer the separate manual "CONTROL-A1 Control System" and the Operating Instructions supplied with your CD player, tape deck, or MD deck for details.

- If you have a Sony CD changer with a COMMAND MODE selector

If the CD changer's COMMAND MODE selector can be switched between CD 1, CD 2, and CD 3, be sure to set the command mode to "CD 1" and connect the changer to the CD jacks on the receiver.

However, if you have a Sony CD changer with VIDEO OUT jacks, set the command mode to "CD 2" and connect the changer to the VIDEO 2 jacks on the receiver.

You can display the operating status of the component connected to the S-LINK CTRL A1 jack (USA and Canadian models only)

- 1 Press SET UP repeatedly to select OTHER SETUP.
- 2 Use the digital processing control buttons (▲ / ▼) to select CONTROL-A1.
- 3 Use the digital processing control buttons (▲ / ▼) to select the setting you want by referring to the following table.

To	Select
Display "PLAY," "STOP," "PAUSE," or "REC" for about 8 seconds when the operation switches	AUTO
Display "PLAY," "STOP," "PAUSE," "REC," or the contents of a disc or track memo of a CD or MD whenever you press the DISPLAY button	FIX
Turn off the operation status display	OFF

Notes

- This setting is effective only when the receiver is set to TAPE, DAT/MD, VIDEO 2, or CD (see page 13). For VIDEO 2, the CD changer command mode must be "CD 2" and the CD changer must be connected to the VIDEO 2 jacks on the receiver. For CD, the CD changer command mode must be "CD 1" and the CD changer must be connected to the CD jacks on the receiver.
- If the disc or track memo contains a character that the receiver cannot display, "-" appears for that character.
- When the Mega Control function of the CD player is active, the operating status of the main player is displayed.

Speaker System Hookups

Overview

This section describes how to connect your speakers to the receiver. Although front (left and right) speakers are required, center and rear speakers are optional. Adding center and rear speakers will enhance the surround effects. Connecting an active woofer will increase bass response.

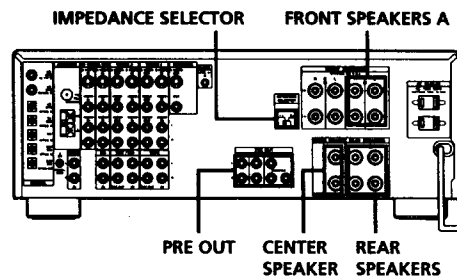

What cords will I need?

Speaker cord (not supplied) (1 for each speaker)



Twist the stripped ends of the cord about 2/3 inch (15 mm). Be sure to match the speaker cord to the appropriate terminal on the components: + to + and - to -. If the cords are reversed, the sound will be distorted and will lack bass.

Hookups

Front speakers

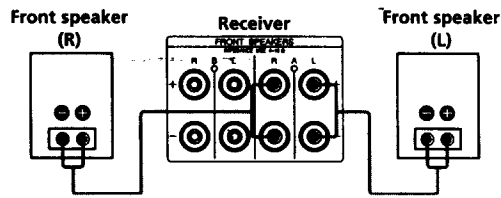

(Continued)

Getting Started

To connect the speaker cords

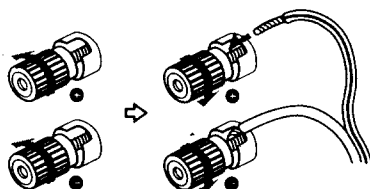

Rear and center speakers

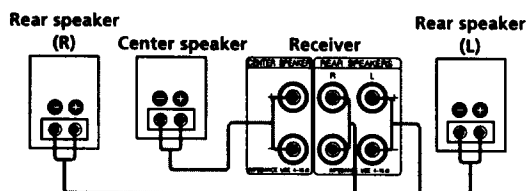

💡 If you have an additional front speaker system
Connect them to the FRONT SPEAKERS B terminals.

💡 If you have an active woofer
Connect the active woofer to a PRE OUT WOOFER jack.

Note

If you use front speakers with low maximum power input, adjust the volume carefully to avoid excessive output on the speakers.

Speaker placement

For the best possible surround sound, we recommend:

- The best quality speakers possible
- Front, center, and rear speakers of equivalent size and quality
- Positioning of speakers at the same distance from the listening position (A).

The center speaker, however, may be moved closer, but not beyond the straight line connecting the two front speakers (B). The rear speakers may also be closer to listening position than the front speakers (C), to suit the configuration of your room. If the surround effect is still inadequate, adjust the CENTER DELAY and REAR DELAY parameters (see page 21).

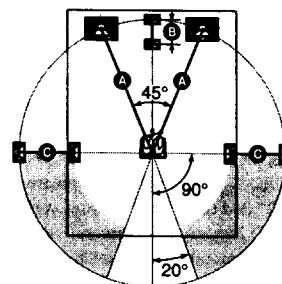

Notes

- Do not place the center or rear speakers farther away from the listening position than the front speakers.
- When mounting the rear speakers on side walls perpendicular to the listening position they should be placed 60 - 90 cm above the listening position.

Depending on the shape of your room (etc.), you may wish to place the rear speakers behind you instead of on the side walls. One advantage of this placement is that you can use a pair of large floor standing speakers matching your front speakers.

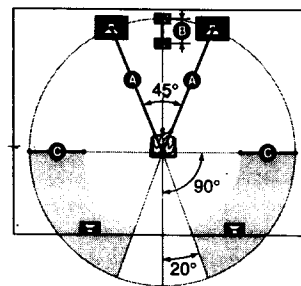

Note

If you place the rear speakers behind you, be sure to check the speaker location setting in the SPEAKER SETUP menu when using VIRTUAL MULTI REAR and VIRTUAL REAR SHIFT sound fields (see page 23 for details).

Selecting the impedance

Set the IMPEDANCE SELECTOR for all the speakers as indicated in the table below. Check the instruction manual of your speakers if you're not sure of the impedance. (This information is usually printed on a label on the back of the speaker.)

If nominal impedance of your speaker is	Set IMPEDANCE SELECTOR to
Between 4 and 8 ohms	4 Ω
8 ohms or higher	8 Ω

Selecting the speaker system

If you connect only one set of front speakers, set the SPEAKERS selector on the front panel to A. If you connect two sets of front speakers, see the following:

To drive	Set SPEAKERS selector to
Speaker system A (connected to the FRONT SPEAKERS A terminals)	A
Speaker system B (connected to the FRONT SPEAKERS B terminals)	B
Both speaker systems A and B (parallel connection)	A+B

Notes

When you connect 2 sets of front speakers and set the SPEAKERS selector on the front panel to A + B, make sure that:

- The nominal impedance of the both sets of speakers are 8 ohms or higher.
- The IMPEDANCE SELECTOR is set to 4 Ω.



To connect any speaker pair through an amplifier

Connect the amplifier to the PRE OUT jacks of the receiver to output the PRE OUT jack signals from the amplifier's speaker terminals. The signals output from the PRE OUT jacks are identical to those output from the speaker terminals of the receiver.

You can then connect any pair of speakers (e.g., the front speakers) to the amplifier's speaker terminals.

TV/VCR Hookups

Overview

This section describes how to connect video components to the receiver.

For digital connections, see "Digital Component Hookups" on page 10.

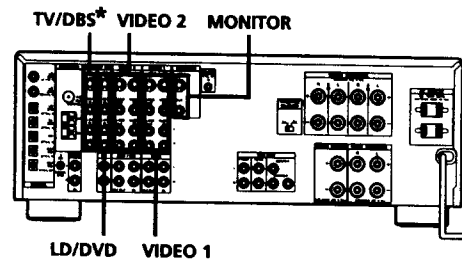

* TV/DBS: USA, Canadian, and Australian models
TV: other models

What cables will I need?

- Audio/video cable (not supplied) (1 for each TV or LD player; 2 for each VCR)

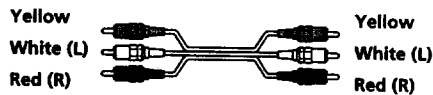

- Video cable (not supplied) (1 for a TV monitor)



If you want to watch high quality video images

You can use an S-VIDEO cable for the TV/DBS, LD, VIDEO 1/2/3, and MONITOR jacks.

Note

The signal input from the S VIDEO IN jack is not output to the normal VIDEO OUT jack. Nor is the signal input from the VIDEO IN jack output to the S VIDEO OUT jack.

Hookups

The arrow \Rightarrow indicates signal flow.

TV or Digital Broadcasting System (DBS) tuner
DBS tuners can be used with the USA, Canadian, and Australian models.

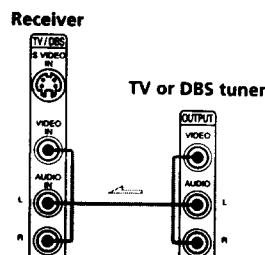

(Continued)

Getting Started

TV monitor

If you use a TV monitor, do not connect anything to the TV/DBS VIDEO IN jack.

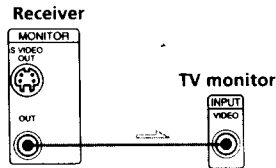

VCR (via the VIDEO 1/2 jacks)

If you have two VCRs, connect the second one to the VIDEO 2 jacks.

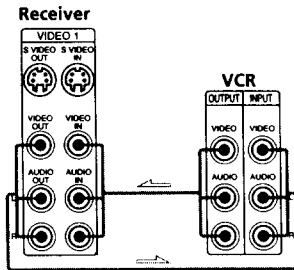

Video camera recorder or video game

Use the VIDEO 3 INPUT jacks on the front panel.

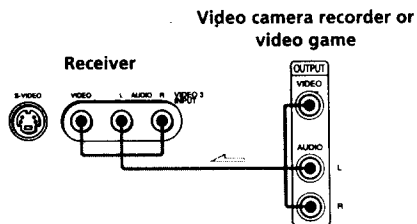

LD player or DVD player

If you have an additional LD player or DVD player, connect it to the VIDEO 2 jacks.

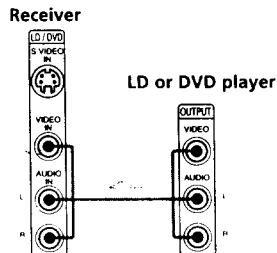

Digital Component Hookups

Overview

This section describes how to connect a LD/DVD player, TV, DBS tuner, DAT/MD deck, and CD player equipped with digital jack(s) to the receiver. If you use a digital component, select the appropriate input mode for the component (see page 13).

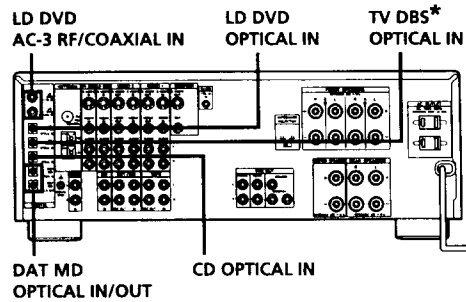

* TV DBS OPTICAL IN: USA, Canadian, and Australian models
TV OPTICAL IN: other models

What cords will I need?

- Optical digital connecting cord (not supplied) (1 for a DVD, LD, CD player, TV, or DBS tuner; 2 for a DAT or MD deck)

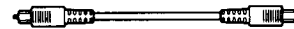

- Coaxial digital connecting cord (not supplied) (1 for a DVD or LD player)

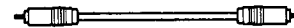

Hookups

The arrow \Rightarrow indicates signal flow.

DVD or LD player

Connect the DVD/LD player either to the LD DVD COAXIAL IN or OPTICAL IN jack.

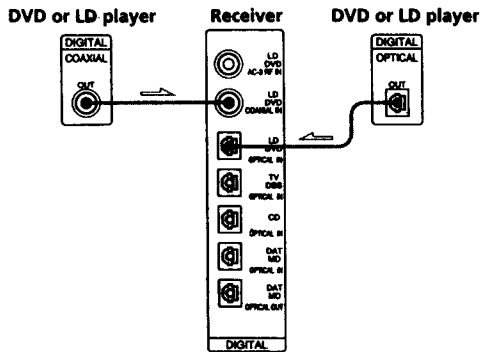

If your LD player has an RF output jack, connect it to the LD DVD AC-3 RF IN jack of the receiver as shown below.

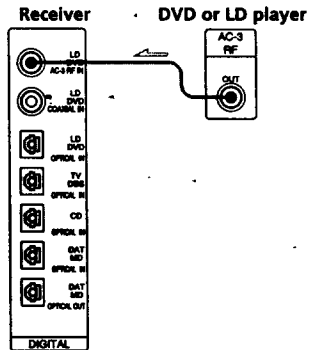

TV or DBS tuner

DBS tuners can be used with the USA, Canadian, and Australian models.

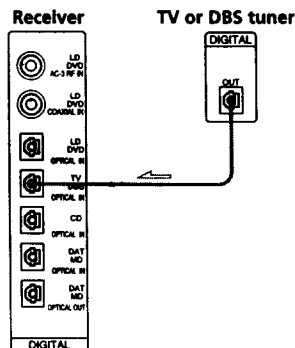

CD player

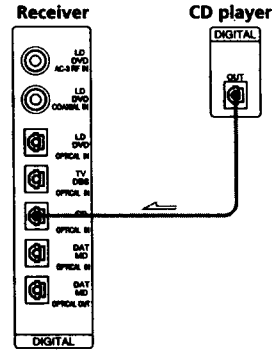

DAT or MD deck

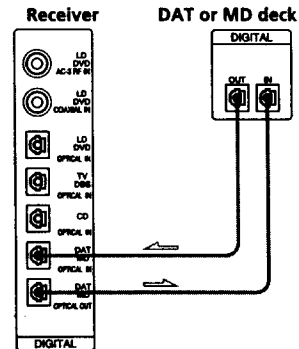

Warning regarding the playback of DAT/MD sources
When playing DAT/MD sources through the receiver, do not play a DAT/MD that contains digital recordings made from a DVD player whose digital output was set to "DOLBY DIGITAL." High volume will be output which may damage the receiver and your speakers.

Notes

- This receiver is compatible only with digital components using 32, 44.1, or 48-kHz sampling frequencies and not compatible with 96 kHz.
- Be sure to connect digital components (CD player, DAT/MD deck, etc.) to the analog jacks as well as the digital jacks in order to do analog recording.

Getting Started

AC Hookups

Setting the voltage selector (only on the models supplied with the voltage selector)

Check that the voltage selector on the rear panel of the receiver is set to the local power supply voltage. If not, set the selector to the correct position using a screwdriver before connecting the AC power cord to a wall outlet.

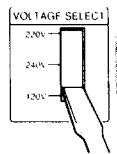

Connecting the AC power cord

Connect the AC power cord from this receiver and from your audio/video components to a wall outlet. If you connect other audio components to AC OUTLET on the receiver, the receiver can supply power to the connected component(s) so you can turn on/off whole system when you turn on/off the receiver. Note that only one switched AC outlet is supplied with the Australian model.

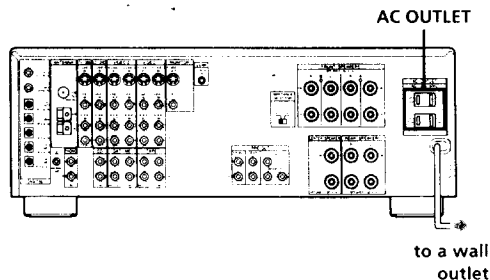

Caution

Make sure that the total power consumption of the component(s) connected to receiver's AC OUTLET does not exceed the wattage stated on the rear panel. Do not connect high-wattage electrical home appliances such as electric irons, fans, or TVs to this outlet.

Before You Use Your Receiver

Before you start using your receiver, make sure that you have:

- Turned MASTER VOL to the leftmost position (0).
- Selected the appropriate speaker system. (For details, see "Selecting the speaker system" on page 9.)
- Set BALANCE to the center position.

Turn on the receiver and check the following indicator.

- Press MUTING on the remote if "MUTING" appears in the display.

Clearing the receiver's memory

Before you use your receiver for the first time or when you want to clear the receiver's memory, do the procedure below.

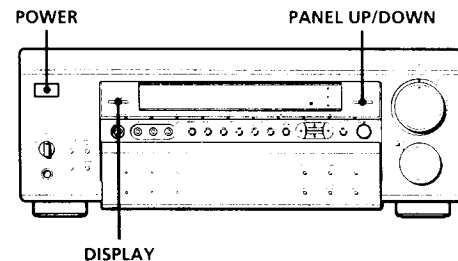

- 1 Turn off the receiver.
- 2 Press down DISPLAY, PANEL UP/DOWN, and POWER simultaneously. The contents of the memory (preset station and other parameter settings) are erased.

Receiver Operations

Selecting a Component

To listen to or watch a connected component, first select the function on the receiver or with the remote. Before you begin, make sure you have:

- Connected all components securely and correctly as indicated on pages 4 to 12.
- Turned MASTER VOL to the leftmost position (0) to avoid damaging your speakers.
- Pressed PANEL UP/DOWN to access the buttons inside of the front cover.

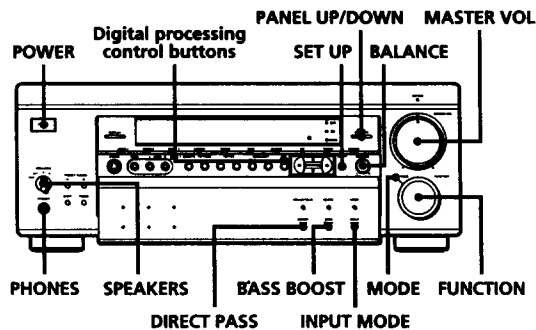

- 1 Press POWER to turn on the receiver.
- 2 Select the component you want to use:

To watch or listen to	Rotate FUNCTION to light up
Video tapes	VIDEO 1 or VIDEO 2
Video camera recorder or video game	VIDEO 3
Laser discs or DVD discs	LD/DVD
TV programs	TV/DBS*
Audio tapes	TAPE
Digital Audio Tapes (DAT) or MiniDiscs (MD)	DAT/MD
Compact Discs (CD)	CD
Radio programs	TUNER
Records	PHONO

* DBS tuners can be used with the USA, Canadian, and Australian models.

- 3 Turn on the component, for example, a CD player, and then start playing.
To tune in radio stations on this receiver, see "Receiving Broadcasts" on page 15.

- 4 Turn MASTER VOL to adjust the volume.
To adjust the volume of the TV's speakers, use the volume control on the TV.

To enjoy any video source and any audio source at the same time

Do the procedure below to select and play any video source in combination with any audio source.

- 1 Select a program source.
- 2 Select one of the available program source.

To select	Press MODE repeatedly to display
VCR, LD/DVD player, or TV	V : ... (VISUAL SELECT)
Tape deck, DAT/MD deck, CD player, tuner, or turntable	A : ... (AUDIO SELECT)

To listen to digital program sources

Do the procedure below.

- 1 Do Steps 1 and 2 above to select the component.
- 2 Press INPUT MODE repeatedly to select input mode for the component.

When you select	The receiver selects
AUTO INPUT	the component connected to the following jack(s) depending on the component selected in Step 1 above (listed in order of priority): When you selected LD/DVD: 1 LD DVD AC-3 RF IN jack 2 LD DVD COAXIAL IN jack 3 LD DVD OPTICAL IN jack 4 LD/DVD (analog) jacks When you selected TV/DBS, CD, or DAT/MD: 1 the OPTICAL jack 2 the analog jacks
DIGITAL (AC-3 RF)	the component connected to the LD DVD AC-3 RF IN jack (appears only when you selected LD/DVD in Step 1)
DIGITAL (COAXIAL)	the component connected to the LD DVD COAXIAL IN jack
DIGITAL (OPTICAL)	the component connected to the OPTICAL jack
ANALOG INPUT	the component connected to the analog jacks

(Continued)

Receiver Operations

To	Do this
Mute the sound 	Press MUTING on the remote. Press again to restore the sound.
Reinforce the bass	Press BASS BOOST to light up the button
Adjust the balance of front speakers	Turn BALANCE left or right

 **When you listen with headphones**
Connect the headphones to the **PHONES** jack and set **SPEAKERS** to OFF.

 **When you want to enjoy high quality sound**
Press **DIRECT PASS** to bypass the tone controls, bass reinforcement, and surround effects. The **DIRECT PASS** button lights up.

 **You can adjust the brightness of the display**

- 1 Press **SET UP** repeatedly to select **OTHER SETUP**.
- 2 Use the digital processing control buttons (\blacktriangle / \blacktriangledown) to select **DIMMER**.
- 3 Use the digital processing control buttons (\blacktriangle / \blacktriangledown) to adjust the brightness.

Watching TV/video programs

To watch	Do this
TV programs	Turn on both the TV and the receiver and rotate FUNCTION repeatedly until the TV/DBS indicator lights up
Videos, laser discs or DVD	<ol style="list-style-type: none"> 1 Rotate FUNCTION to select the component (for example, VIDEO 1). 2 Turn on the TV and set the TV's video input to match your video component. 3 Turn on the component (VCR, LD/DVD player), and start playback.

 **When you watch TV or video programs**
We recommend you play audio portion through the receiver instead of your TV's speakers. This lets you take advantage of the receiver's surround sound effects, like Dolby Surround, and lets you use the receiver's remote to control the audio.
Turn off the speakers on your TV before you start so you can enjoy the surround sound from your receiver.

Using the remote

The remote lets you operate the receiver and the Sony components that are connected to it.

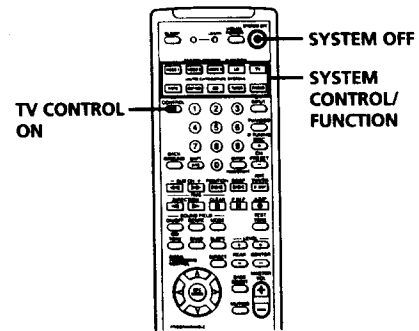

1 Press one of the **SYSTEM CONTROL/FUNCTION** buttons to select the component you want to use.
The receiver and the selected component turn on. The **SYSTEM CONTROL/FUNCTION** buttons on the remote are factory-set as follows:

To watch or listen to	Press
Video tapes	VIDEO 1 (VTR 3*), VIDEO 2 (VTR 1*) or VIDEO 3 (VTR 2*)
Laser discs or Digital Video Discs (DVD)	LD
TV programs	TV
Audio tapes	TAPE
Digital Audio Tapes (DAT) or MiniDiscs (MD)	DAT/MD
Compact Discs (CD)	CD
Radio programs	TUNER
Records	PHONO

* Sony VCRs are operated with a VTR 1, 2, or 3 setting that corresponds to Beta, 8mm, and VHS, respectively.

Note

Pressing a **SYSTEM CONTROL/FUNCTION** button will activate the component indicated for that button (i.e., the component connected to the respective connector). If, however, the connected component is different from the one indicated for the button, the component will not be activated when the button is pressed only once.

For example, to watch Sony LD player connected to the **VIDEO 2** jacks (as shown on page 10):
Press **VIDEO 2** to switch the function, then press **LD** to set the remote control to operate the LD player.

If you want to change the factory setting of a button

See page 28.

If the component does not turn on

Press the power switch on the component.

- 2 Start playing.
See "Remote Button Descriptions" on page 36 for details.

To turn off the components

Press SYSTEM OFF. This will also turn off the video/ audio component(s) connected to AC OUTLET on the back of this unit at the same time.

**If you use a Sony TV**

When you press TV to watch a TV program, the TV turns on and switches to the TV input. The TV also turns on automatically and switches to the appropriate video input when you press VIDEO 1 or VIDEO 2. If the TV does not switch to the appropriate input automatically, press TV/VIDEO on the remote.

**Watching TV without the receiver (for Sony TVs only)**

Press TV CONTROL ON to set the remote to operate TV functions only. When you press this button, the TV turns on and switches to the TV input. If the TV does not automatically switch to the TV input, press TV/VIDEO.

Making components selectable/unselectable

You can do these settings so that certain components become unselectable even if you rotate FUNCTION.

- 1 Press SET UP repeatedly to select FUNCTION HOOKUP.
- 2 Use the digital processing control buttons (▲ / ▼) to select a component.
- 3 Use the digital processing control buttons (◆ / ▶) to select CONNECT (selectable) or NO (unselectable).

Notes

- When the receiver accepts the signal from the S-LINK CTRL A1 jack to select that component which is set to NO on the receiver, the setting changes to YES automatically and the component is selected (USA and Canadian models only).
- If you try to select the component which is set to NO using the remote, "NO CONNECTION" appears in the display.

Receiving Broadcasts

This receiver lets you enter a station's frequency directly by using the numeric buttons (direct tuning). If you don't know the frequency of the station you want, see "Receiving broadcasts by scanning stations (automatic tuning)" on page 16.

Before you begin, make sure you have:

- Connected an FM/AM antenna to the receiver as indicated on page 5.
- Selected the appropriate speaker system. (For details, see "Selecting the speaker system" on page 9.)

POWER DISPLAY FM MODE

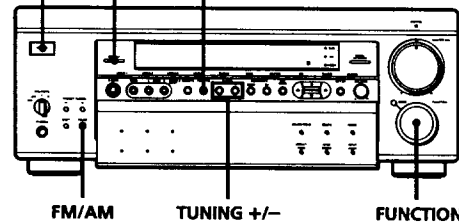

- 1 Press POWER to turn on the receiver.
- 2 Press TUNER on the remote.
The last received station is tuned in.
- 3 Press FM/AM to select FM or AM stations.
- 4 Press D.TUNING on the remote.
- 5 Press the numeric buttons on the remote to enter the frequency.

Example 1: FM 102.50 MHz

① • ② • ⑤ • ⑤ • ①

Example 2: AM 1350kHz

(You don't have to enter the last "0." (USA and Canadian models only))

① • ③ • ⑤

- 6 When you tune in AM stations, adjust the direction of the AM loop antenna for optimum reception.

To receive other stations

Repeat Steps 3 to 5.

(Continued)

Receiver Operations

If the STEREO indicator remains off
Press FM MODE even when an FM stereo broadcast is received.

If an FM stereo program is distorted
The STEREO indicator flashes. Press FM MODE to change to monaural (MONO). You will not have the stereo effect but the distortion will be reduced. To return to the auto stereo mode, press this button again.

If you cannot tune in a station and the entered numbers are flashing
Make sure you've entered the right frequency. If not, press D.TUNING and reenter the frequency you want. If the entered numbers still flash, the frequency is not used in your area.

To watch FM simulcast TV programs
Make sure that you tune in the simulcast program on both the TV (or VCR) and the receiver.

If you enter a frequency not covered by the tuning interval
The entered value is automatically rounded up or down to the closest covered value.

Tuning intervals for direct tuning are:

FM: 50 kHz intervals

AM: 10 kHz intervals (USA and Canadian models only; to change to 9 kHz intervals, see page 32.)
9 kHz intervals (Australian model only)
9 kHz intervals (models for all other countries; to change to 10 kHz intervals, see page 32.)

Receiving broadcasts by scanning stations (automatic tuning)

If you don't know the frequency of the radio station you want, you can have the receiver scan all the receivable stations to locate the one you want.

- 1 Rotate FUNCTION until the TUNER indicator lights up.
The last received station is tuned in.
- 2 Press DISPLAY so that the frequency appears in the display.
- 3 Press FM/AM to select FM or AM.
- 4 Press TUNING + or -.
Press the + button for a higher station number; press the - button for a lower one. When you tune past either end of the band, the receiver automatically jumps to the opposite end and continues scanning in the same direction. Every time a station is received, the receiver stops scanning. To continue scanning, press the button again.

Presetting Radio Stations

You'll most likely want to preset the receiver with the radio stations you listen to often so that you don't have to tune in the station every time. The receiver can store a total of 30 FM or AM stations. You can store the stations on preset numbers combining 3 characters (A, B and C) and numbers (0-9). For example, you can store a station as preset number A1, B6, or C9.

PRESET TUNING +/-

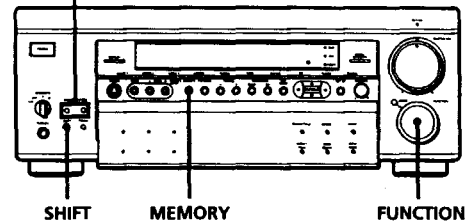

- 1 Rotate FUNCTION until the TUNER indicator lights up.
The last received station is tuned in.
- 2 Tune in the station you want.
If you are not familiar with how to tune in a station, see "Receiving Broadcasts" on page 15.
- 3 Press MEMORY.
"MEMORY" appears for a few seconds.
Do Steps 4 and 5 before "MEMORY" goes out.
- 4 Press SHIFT to select a memory page (A, B or C).
Each time you press SHIFT, the letter "A," "B" or "C" appear in the display.
- 5 Press PRESET +/- to specify the preset number, and then press MEMORY.
"MEMORY" goes out and the selected station is preset.

If "MEMORY" goes out before you specify the preset number, start again from Step 3.
- 6 Repeat Steps 2 to 5 to preset other stations.

To change a preset station

Preset a new station on the number you want to change.

Note

If the AC power cord is disconnected for about one week, the preset stations will be cleared from the receiver's memory, and you will have to preset the stations again.

Tuning preset stations (preset tuning)

You can tune directly to a preset station by entering its preset number. If you don't know which stations are preset on which numbers, you can tune by scanning the preset stations.

- 1 Press TUNER on the remote.
The last received station is tuned in.
- 2 Press SHIFT to select a memory page (A, B or C), then press the numeric button on the remote.
For example, select A and then press 7 to tune in the station preset as A7.

**You can tune by scanning the preset stations**

Rotate FUNCTION until the TUNER indicator lights up, and then press DISPLAY so that the frequency display appears. Then press PRESET TUNING + or - to select the station you want. Each time you press the buttons, the preset numbers change as follows:

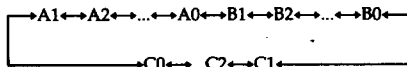
**Indexing Preset Stations and Program Sources**

You can enter a name of up to 8 characters for preset stations (station index) and program sources. These index names (for example, "VHS") appear in the receiver's display when a station or program source is selected.

Note that no more than one name can be entered for each preset station or program source.

This function is useful for distinguishing components of the same kind; 2 VCRs, for example, can be specified as "VHS" and "8MM," respectively. It is also handy for identifying components connected to jacks meant for another type of component; for example, a second CD player connected to the DAT/MD jacks.

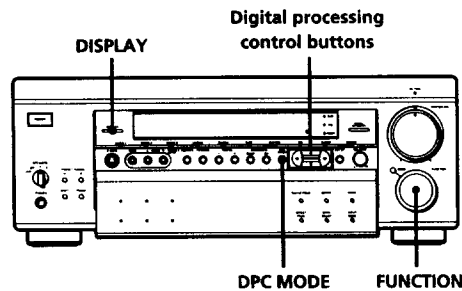

- 1 **To index a preset station**
Rotate FUNCTION until the TUNER indicator lights up.
The last station you received is tuned in.
- To index a program source**
Select the program source (component) to be named, then go to Step 3.
- 2 Tune in the preset station you want to create an index for.
If you are not familiar with how to tune in preset stations, see "Tuning preset stations (preset tuning)" on this page.
- 3 Press DPC MODE repeatedly until the INDEX indicator lights up.
- 4 Create an index name by using the digital processing control buttons as follows:
Press ▲ or ▼ to select a character, and then press → to move the cursor to the next position.
The index name is stored automatically.

(Continued)

Receiver Operations

To insert a space

Press \blacktriangle or \blacktriangledown until a blank space appears in the display (the space is between " " and "A").

If you've made a mistake

Press \blacktriangle or \blacktriangledown repeatedly until the character you want to change flashes. Then select the right character.

To assign index names to other stations

Repeat Steps 2 to 4.

-  You can display either the preset station name (program source name) or frequency (component originally meant for the selected jacks). Each time you press DISPLAY, the display switches between the frequency (or component originally meant for the selected jacks) and the preset station name (program source name).

Recording

This receiver makes it easy to record to and from the components connected to the receiver. You don't have to connect playback and recording components directly: once you select a program source on the receiver, you can record and edit as you normally would using the controls on each component.

Before you begin, make sure you've connected all components properly.

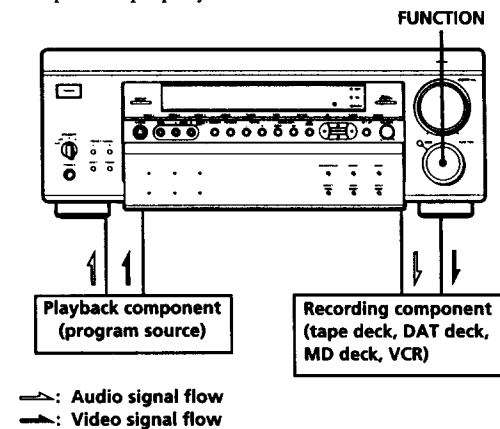

Recording on an audio tape or MiniDisc

You can record on a cassette tape, Digital Audio Tape or MiniDisc using the receiver. See the instruction manual of your cassette deck, DAT deck, or MD deck if you need help.

- 1 Select the component to be recorded.
- 2 Set the component to be ready for playing. For example, insert a CD into the CD player.
- 3 Insert a blank tape or an MD into the recording deck and adjust the recording level, if necessary.
- 4 Start recording on the recording deck and then start playing the component.

Notes

- The signal input from a digital jack is not output to the analog REC OUT jacks. To do analog recording, be sure to connect the component to the analog input jacks.
- Sound adjustments do not affect the signal output from the DAT MD OPTICAL OUT, DAT/MD REC OUT, and TAPE REC OUT jacks.

Recording on a video tape

You can record from a VCR, a TV, or an LD player using the receiver. You can also add audio from a variety of audio sources when editing a video tape. See your VCR or LD player's instruction manual if you need help.

- 1 Select the program source to be recorded.
- 2 Set the component to be ready for playing. For example, insert the laser disc you want to record from into the LD player.
- 3 Insert a blank video tape into the VCR (VIDEO 1 or VIDEO 2) for recording.
- 4 Start recording on the recording VCR and then start playing the video tape or laser disc you want to record.

 **You can record sound from a different audio source onto a video tape while copying from a video tape or laser disc**

Locate the point where you want to start recording from another audio source, select the program source, then start playback. The audio from that source will be recorded onto the audio track of the video tape instead of the audio from the original.

To resume audio recording from the original, select the video source again.

Note

The signal input from a digital jack is not output to the analog output jacks. To do analog recording, be sure to connect the component to the analog input jacks.

Using the Sleep Timer

You can set the receiver to turn off automatically at a time you specify.

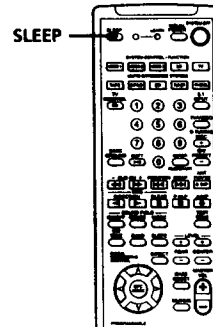

Press SLEEP on the remote while the power is on. Each time you press SLEEP, the time changes as shown below.

→ 2:00:00 → 1:30:00 → 1:00:00 → 0:30:00 → OFF →

The display dims after you specify the time.

 **You can freely specify the time**

Press SLEEP first, then specify the time you want using the digital processing control buttons (\wedge or \vee). The sleep time changes in 1 minute intervals. You can specify up to 5 hours.

 **You can check the time remaining before the receiver turns off**

Press SLEEP. The remaining time appears in the display.

Dolby Digital

To obtain the best possible surround sound, first specify the type of speakers you have connected and the location of the rear speakers. Then use the test tone to adjust the speaker volumes to the same level.

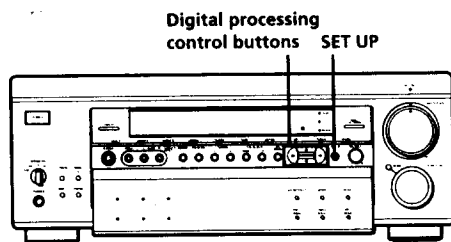

Specifying the speaker type and the location of the rear speakers

- 1 Press SET UP repeatedly to select SPEAKER SETUP.
- 2 Use the digital processing control buttons (▲ / ▼) to select the parameter to be set and use the buttons (◀ / ▶) to select the setting.

FRONT SP. (front speaker)

- If you connect large speakers that will effectively reproduce bass frequencies, select "LARGE."
- When a Dolby Digital sound source (indicated by the lighting of the DISCRETE indicator) produces an inadequate surround effect, or when cracking occurs in the sound output, select "SMALL" to activate the Dolby Digital (AC-3) bass redirection circuitry and output the front channel bass frequencies from the subwoofer or other "LARGE" speakers.

CENTER SP. (center speaker)

- If you connect large speakers that will effectively reproduce bass frequencies, select "LARGE."
- When a Dolby Digital sound source (indicated by the lighting of the DISCRETE indicator) produces an inadequate surround effect, or when cracking occurs in the sound output, select "SMALL" to activate the Dolby Digital (AC-3) bass redirection circuitry and output the center channel bass frequencies from the front speakers, subwoofer or other "LARGE" speakers.
- If you do not connect the center speaker, select "NO."

REAR SP. (rear speaker)

- If you connect large speakers that will effectively reproduce bass frequencies, select "LARGE."
- When a Dolby Digital sound source (indicated by the lighting of the DISCRETE indicator) produces an inadequate surround effect, or when cracking occurs in the sound output, select "SMALL" to activate the Dolby Digital (AC-3) bass redirection circuitry and output the rear channel bass frequencies from the subwoofer or other "LARGE" speakers.
- If you do not connect rear speakers, select "NO."

REAR SP. (rear speaker place)

This parameter lets you specify the location of your rear speakers for proper implementation of the Digital Cinema Sound VIRTUAL REAR SHIFT and VIRTUAL MULTI REAR sound fields. Refer to the illustration below.

- Set to SIDE if the location of your rear speakers corresponds to section A.
- Set to BEHIND if the location of your rear speakers corresponds to section B.

This setting affects only the VIRTUAL REAR SHIFT and VIRTUAL MULTI REAR sound fields.

Note that this parameter does not appear when the REAR SP. (rear speaker) parameter is set to "NO."

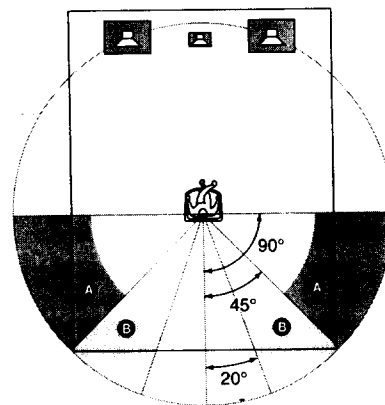

SUB WOOFER (subwoofer selection)

- If you connect a subwoofer, select "YES" to output the LFE (low frequency extension) channel from subwoofer.
- If you do not connect a subwoofer, select "NO." activates the Dolby Digital (AC-3) bass redirection circuitry and outputs the LFE signals from other speakers.

- 💡 If you feel the surround effect is inadequate**
Do the procedure below to adjust the delay time for the center and rear speakers.
- 1 Press SET UP repeatedly to select OTHER SETUP.
 - 2 Use the digital processing control buttons (◀ / ▶) to select CENTER DELAY or REAR DELAY and use the buttons (◆ / ◆) to select the delay time.

Adjusting the speaker volume

Use the remote while seated in your listening position to adjust the volume of each speaker.

Note

This receiver incorporates a new test tone with a frequency centered at 800 Hz for easier speaker volume adjustment.

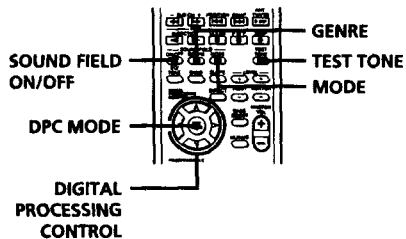

- 1 Press SOUND FIELD ON/OFF to turn on the sound field.
- 2 Press GENRE repeatedly to select "DOLBY."
- 3 Press MODE to select "NORMAL SURROUND" or "ENHANCED SURROUND."
- 4 Press DPC MODE repeatedly until the SUR indicator lights up.
- 5 Press TEST TONE.
You will hear the test tone from each speaker in sequence.

- 6 From your listening position, use the digital processing control buttons (∧ / ∨) to select the parameter to be set and use the buttons (< / >) to select the setting so that the test tone can be heard at the same level from all speakers.

To adjust	Select	And set between
rear speaker balance	REAR L R	L (left) and R (right)
rear speaker level	REAR	-20.0dB and +10.0dB (in 0.5 dB steps)
center speaker level	CENTER	-20.0dB and +10.0dB (in 0.5 dB steps)
subwoofer level	SUB WOOFER	-20.0dB and +10.0dB (in 0.5 dB steps)

During adjustment of the respective speaker level/balance, the test tone is output from the speaker(s) only.

After adjusting the subwoofer level, the test tone turns off automatically.

To turn off the test tone

Press TEST TONE.

Notes

- Be sure to select "NORMAL SURROUND" or "ENHANCED SURROUND" before outputting the test tone.

Sound Adjustment

Using Pre-programmed Sound Fields

You can take advantage of surround sound simply by selecting one of the pre-programmed sound fields according to the program you want to play.

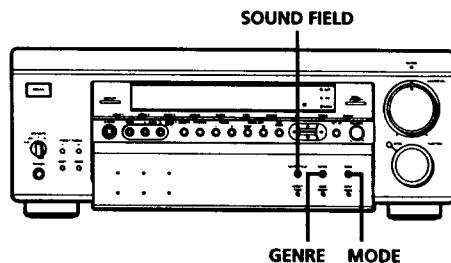

- 1** Press SOUND FIELD to turn on the sound field. One of the indicators lights up in the display.
- 2** Press GENRE to select the type of sound field you desire.
- 3** Press MODE to select the mode you desire from the respective genre. Select the appropriate sound field according to the chart shown at right.

To play without surround effects

Select "ACOUSTIC" from MUSIC. The surround effects are defeated but you can still adjust the equalizer parameters (see page 26).

To turn off the sound fields

Press SOUND FIELD.

You can find Dolby Surround-encoded software by looking at the packaging

However, some videos, laser discs, and DVD discs may use Dolby Surround sound even if it's not indicated on the package.

Sound fields

GENRE	MODE	To
DOLBY TM	NORMAL SURROUND	Decode programs processed with Dolby Surround
	ENHANCED SURROUND	Provide a greater sense of presence from Dolby Digital sources with monaural rear channel sound
MOVIE	CINEMA STUDIO A	Reproduce the sound characteristics of the Sony Pictures Entertainment "C Grant Theater" cinema production studio
	CINEMA STUDIO B	Reproduce the sound characteristics of the Sony Pictures Entertainment "I Novak Theater" cinema production studio
	CINEMA STUDIO C	Reproduce the sound characteristics of the Sony Pictures Entertainment scoring stage
	SMALL THEATER	Add the acoustic reflectance of a theater to decoded Dolby Surround signals
	MEDIUM THEATER	
	LARGE THEATER	
	NIGHT THEATER	Watch a movie at low volume during the night-time
	MONO MOVIE	Create a theater-like environment from movie with 2 channel monaural soundtracks
3D	VIRTUAL ENHANCED A	Use 3D sound imaging to create virtual rear speakers from the sound of the front speakers without using rear speakers as shown in illustration (A) on page 2
	VIRTUAL ENHANCED B	Use 3D sound imaging to create virtual rear speakers from the sound of the front speakers without using rear speakers as shown in illustration (B) on page 2

GENRE	MODE	To
3D	VIRTUAL REAR SHIFT	Use 3D sound imaging to shift the sound of the rear speakers away from the actual position as shown in the illustration ㉑. The shift position differs according to the REAR SP. setting (see page 20).
	VIRTUAL MULTI REAR	Use 3D sound imaging to create an array of virtual rear speakers from a single pair of actual rear speakers as shown in the illustration ㉒. The position of the virtual speakers differs according to the REAR SP. setting (see page 20).
MUSIC	SMALL HALL	Reproduce the acoustics of a rectangular concert hall. Ideal for soft acoustic sounds.
	LARGE HALL	
	SMALL OPERA HOUSE	Reproduce the acoustics of an opera house
	LARGE OPERA HOUSE	
	SMALL JAZZ CLUB	Reproduce the acoustics of a jazz club
	LARGE JAZZ CLUB	
	CHURCH	Reproduce the acoustics of a church
	LIVE HOUSE	Reproduce the acoustics of a live house
ACOUSTIC ²⁾	Reproduce normal 2 channel stereo. (No surround effects)	
	KARAOKE ³⁾	Reduce the vocals of a normal 2 channel music source
SPORTS	ARENA	Reproduce the feeling of being in a front row of a large concert arena. Great for rock music.
	STADIUM	Reproduce the feeling of a large open-air stadium. Great for sporting events or electric sounds.
GAME	GAME	Obtain maximum audio impact from video game software

1) Be sure to adjust the volume level of the center and/or rear speakers to get the most out of the Dolby Digital (AC-3) Surround Sound (page 21).

2) The hookups of the center and/or rear speakers are unnecessary.

3) This parameter has no effect on the music source that has separate vocal channel (e.g., a Video CD containing karaoke tracks).

㉑ VIRTUAL ENHANCED A

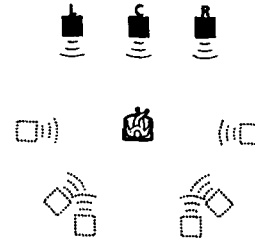

㉒ VIRTUAL ENHANCED B

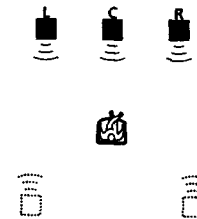

㉓ VIRTUAL REAR SHIFT

When REAR SP. is set to SIDE*

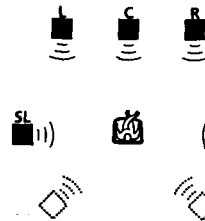

When REAR SP. is set to BEHIND*

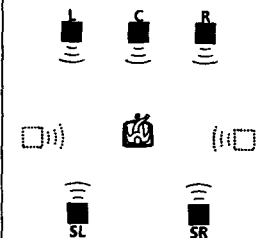

㉔ VIRTUAL MULTI REAR

When REAR SP. is set to SIDE*

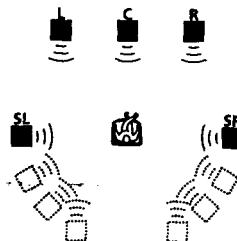

When REAR SP. is set to BEHIND*

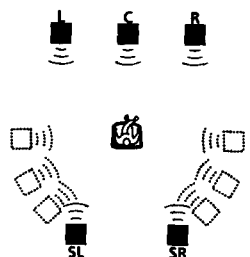

L: front speakers (left)
 R: front speakers (right)
 C: center speaker
 SL: rear speaker (left)
 SR: rear speaker (right)
 □: virtual speaker

* See page 20 for details on how to set the rear speaker place.

(Continued)

Sound Adjustment

Relationship between a Dolby-surround-sound-encoded source and sound output from the receiver

Sound output from the receiver for a Dolby-surround-sound-encoded source will differ according to the contents of the sound source and the settings on the receiver, as described below.

- For a sound source consisting of Discrete data
When the DOLBY NORMAL SURROUND or ENHANCED SURROUND sound field is selected or the DIRECT PASS button is on:

The DISCRETE indicator lights up and the sound is decoded and output as is for all Dolby Digital sound channels in the source.

When a sound field other than ACOUSTIC and KARAOKE* is selected:

The DISCRETE indicator lights up and all Dolby Digital sound channels in the source are processed with the sound field before being output.

When the ACOUSTIC sound field is selected or the sound field is turned off:

The sound source is downmixed to 2 channels (L/R stereo) and output. When the ACOUSTIC sound field is selected, you can adjust the equalizer parameters (see page 26).

- For a sound source with Dolby Pro Logic data
When the DOLBY NORMAL SURROUND or ENHANCED SURROUND sound field is selected or the DIRECT PASS button is on:

"PRO LOGIC" appears and the Dolby Pro Logic sound is decoded and output.

When a sound field other than ACOUSTIC is selected:

The sound source is processed with the sound field before being output. If the sound field genre is MOVIE (excluding MONO MOVIE sound field) or 3D, "PRO LOGIC" appears in the display and Dolby Pro Logic sound is decoded and output.

When the ACOUSTIC sound field is selected or the sound field is turned off:

The sound source is downmixed to 2 channels (L/R stereo) and output. When the ACOUSTIC sound field is selected, you can adjust the equalizer parameters (see page 26).

- * The KARAOKE sound field reduces the level of the vocal component which is located at the center of 2-channel stereo sound. Since this sound field downmixes a 5-channel Dolby Digital source to two channels and processes it in the same way, the DISCRETE indicator does not light up in KARAOKE mode.

Customizing the Sound Fields

Each sound field is composed of a tone parameter (bass / treble) and surround sound parameters — variables of sound that create the sound image. You can customize the sound fields by adjusting some of the sound parameters to suit your listening situation. Also, since this receiver uses Digital Signal Processing (DSP), you can adjust the sound parameters electronically. DSP automatically converts analog audio signals to digital, which lets you adjust the sound with virtually no degradation in sound quality.

Once you customize the sound fields, they are stored in memory unless the receiver is unplugged for about a week. To change a customized sound field, make adjustments to the sound field.

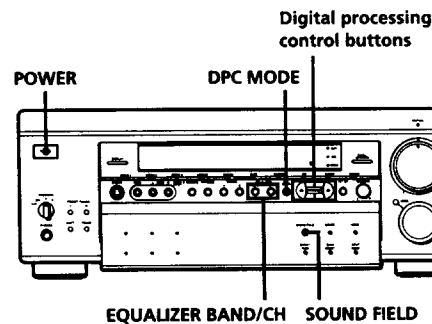

Adjustable parameters for each sound field

GENRE	MODE	EFFECT	WALL/SEAT (F-R/L-R)	REV	LFE MIX	D. COMP	R (BAL/LEV)	W LEV*	C LEV*	EQ
DOLBY	NORMAL				●	●	●	●	●	●
	ENHANCED				●	●	●	●	●	●
MOVIE	C STUDIO A	●			●	●	●	●	●	●
	C STUDIO B	●			●	●	●	●	●	●
	C STUDIO C	●			●	●	●	●	●	●
	S THEATER	●	●		●	●	●	●	●	●
	M THEATER	●	●		●	●	●	●	●	●
	L THEATER	●	●		●	●	●	●	●	●
	N THEATER	●	●		●	●	●	●	●	●
	MONO MOVIE	●	●		●	●	●	●	●	●
3D	VIRTUAL ENHANCED A	●			●	●	●	●	●	●
	VIRTUAL ENHANCED B	●			●	●	●	●	●	●
	VIRTUAL REAR SHIFT	●			●	●	●	●	●	●
	VIRTUAL MULTI REAR	●			●	●	●	●	●	●
MUSIC	S HALL	●	●		●	●	●	●	●	●
	L HALL	●	●		●	●	●	●	●	●
	S OPERA HOUSE	●	●		●	●	●	●	●	●
	L OPERA HOUSE	●	●		●	●	●	●	●	●
	S JAZZ CLUB	●	●		●	●	●	●	●	●
	L JAZZ CLUB	●	●		●	●	●	●	●	●
	CHURCH	●	●		●	●	●	●	●	●
	LIVE HOUSE	●	●		●	●	●	●	●	●
	ACOUSTIC								●	
	KARAOKE	●			●				●	
SPORTS	ARENA	●	●		●	●	●	●	●	●
	STADIUM	●	●		●	●	●	●	●	●
GAME	GAME	●	●		●	●	●	●	●	

EFFECT: effect level

WALL: wall type

SEAT (F-R/L-R): seat position (front-rear/left-right)

REV: reverberation time

LFE MIX: low frequency effect mix

D. COMP: dynamic range compression

R (BAL/LEV): rear speaker's balance/level

W LEV: subwoofer level

C LEV: center speaker level

EQ: equalizer parameter

* The settings of these parameters are not stored separately for each sound field. They effect all the sound fields.

Notes

- All the sound fields can be used with Dolby Digital (AC-3) sound sources.
- The EFFECT parameter allows you to adjust the overall presence of the sound field.
- The volume of the rear speakers, subwoofer, and center speaker can still be adjusted even when the DIRECT PASS button lights up.

Before you get started

To take advantage of Dolby Surround sound, go to "Dolby Digital" on page 20. This section describes how to adjust the levels of your speaker system and customize the DOLBY sound field.

Sound Adjustment



Adjusting the equalizer parameters

Adjust the equalization (bass or treble) of the front, center and rear speakers for optimum sound. The following adjustments effect all sound fields simultaneously.

- 1 While playing a component, press DPC MODE repeatedly until the EQ indicator lights up.
- 2 Press EQUALIZER CH repeatedly to select the parameter to be set. Then press EQUALIZER BAND repeatedly to select the level or frequency of the selected speaker, and then use the buttons (◀ / ▶) to select the setting.

To set	Select	And set between
bass level of the front speakers	F: BASS	-10.0dB and +10.0dB (in 0.5 dB steps)
bass frequency of the front speakers	F: BASS	99Hz and 992Hz (in 21 levels)
treble level of the front speakers	F: TREBLE	-10.0dB and +10.0dB (in 0.5 dB steps)
treble frequency of the front speakers	F: TREBLE	1.0kHz and 8.6kHz (in 21 levels)
bass level of the center speaker	C: BASS	-10.0dB and +10.0dB (in 0.5 dB steps)
bass frequency of the center speaker	C: BASS	99Hz and 992Hz (in 21 levels)
treble level of the center speaker	C: TREBLE	-10.0dB and +10.0dB (in 0.5 dB steps)
treble frequency of the center speaker	C: TREBLE	1.0kHz and 8.6kHz (in 21 levels)
bass level of the rear speakers	R: BASS	-10.0dB and +10.0dB (in 0.5 dB steps)
bass frequency of the rear speakers	R: BASS	99Hz and 992Hz (in 21 levels)
treble level of the rear speakers	R: TREBLE	-10.0dB and +10.0dB (in 0.5 dB steps)
treble frequency of the rear speakers	R: TREBLE	1.0kHz and 8.6kHz (in 21 levels)

- 3 Repeat Step 2 if necessary.

 You can turn off the equalizer adjustments without erasing them  Press EQ/TONE on the remote.

Note

You may hear some noise as you adjust the parameters.

Adjusting the effect and surround sound parameters

Change the surround parameters to fit your listening situation. See the chart on page 25 for parameters you can adjust in each sound field.

- 1 Press DPC MODE repeatedly until the SUR indicator lights up.
- 2 Use the digital processing control buttons (▲ / ▼) to select the parameter to be set and use the buttons (◀ / ▶) to select the setting.

To	Select	And set between
set the overall presence of the sound field ¹⁾	EFFECT	0% and 100%
set the level of the high frequencies to alter the sonic character of your listening environment	WALL TYPE	S (soft wall) and H (hard wall) (in 17 levels)
select your seat position (front or rear) to simulate the acoustics of the selected position	SEAT	F (front) and R (rear) (in 17 levels)
select your seat position (left or right) to simulate the acoustics of the selected position	SEAT	L (left) and R (right) (in 17 levels)
set the length of time required for the reverberation from a given sound to attenuate to -60 dB	REVERB	S (short) and L (long) (in 17 levels)
attenuate the level of the LFE (Low Frequency Extension) channel output from the subwoofer ²⁾	LFE MIX	MUTE, -20.0dB and 0dB (in 0.5 dB steps)
compress the dynamic range of the sound track	D.RANGE COMP	OFF, 0.1 to 0.9, STI MAX ³⁾

- 1) When the sound field is KARAOKE, this parameter adjusts the vocal presence. The higher the setting, less dominant the vocal sound.

- 2) The adjustment of this parameter does not affect the level of the bass frequencies sent to the subwoofer from the front, center, or rear channels via the bass redirection circuitry. Setting this parameter to 0dB outputs the full LFE signal at the mix level determined by the recording engineer. Selecting MUTE mutes the sound of the LFE channel from the subwoofer. However, the low frequency sounds of the front, center, and rear speakers are output from the subwoofer according to the setting of each speaker (page 20).
- 3) Setting this parameter to OFF reproduces the sound track with no dynamic range compression. STD reproduces the sound track with the full dynamic range as intended by the recording engineer. MAX provides a dramatic compression of the dynamic range.

Resetting customized sound fields to the factory settings

- 1 If the power is on, press POWER to turn off the power.
- 2 Hold down SOUND FIELD and press POWER. "SURR CLEAR!" appears in the display and all the sound fields are reset at once.

Advanced Remote Operations

Operating One Component While Using Another (background operation)

You can temporarily operate other components while listening to or watching a program.

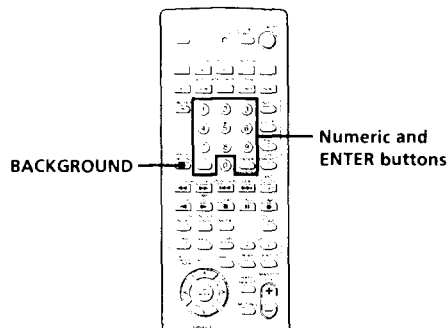

- 1 Hold down BACKGROUND.
- 2 Press both the corresponding button of the component you're going to use (see the table below) and one of the following buttons at the same time: VISUAL POWER, TV/VIDEO, CH/PRESET +/-, ANT TV/VTR, D.SKIP, ►, ◀, ■, ◀◀/▶▶, ◀◀/▶▶, II, ●.

Example: To start recording on a tape deck while listening to a CD
While holding down BACKGROUND, press 4 (or 5) and press ● + ► at the same time.

The following buttons correspond to the components.

The button	Corresponds to
1	CD player
2	DAT deck
3	MD deck
4	Tape deck A
5	Tape deck B
6	LD player
7	VCR (remote control mode VTR 1*)
8	VCR (remote control mode VTR 2*)
9	VCR (remote control mode VTR 3*)
10	DPS tuner
ENTER	DVD player

* Sony VCRs are operated with a VTR 1, 2 or 3 setting that corresponds to Beta, 8mm, and VHS, respectively.

Changing the Factory Setting of a FUNCTION Button

If the factory settings of the FUNCTION buttons (page 14) don't match your system components, you can change them. For example, if you connect a Sony LD player to the VIDEO 2 jacks, you can assign the VIDEO 2 button to set the remote to control the LD player.

Note that the settings of the TUNER and PHONO buttons cannot be changed.

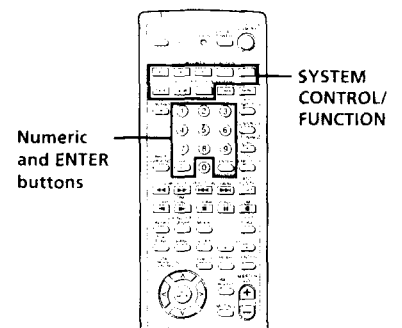

- 1 Hold down the SYSTEM CONTROL/FUNCTION button whose function you want to change (VIDEO 2, for example).
- 2 Press the corresponding numeric button of the component you want to assign to the SYSTEM CONTROL/FUNCTION button (6 - LD player, for example).

For the numeric buttons, see the table in "Operating One Component While Using Another" on this page.

Now you can use the VIDEO 2 button to control your Sony LD player.

To reset the setting to the factory setting.

Repeat the above procedure.

Programming the Remote

The RM-P501 remote included with the receiver can control non-Sony components by "learning" the control signals from their remotes. Once this remote learns the other components signals, you can use these components as part of your system. Additionally, if you have any Sony components that fail to operate with this remote, use this programming function. This remote can "learn" signals only from other infrared wireless remotes. Before you program signals, make sure that the two remotes:

- Face straight at each other (see Step 3 below)
- Are placed at a distance of about 2 inches (5 cm)
- Are not moved during programming

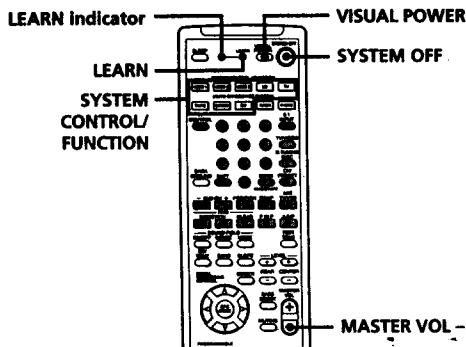

- 1** Press the SYSTEM CONTROL / FUNCTION button of the component you want to program (except the TUNER and PHONO buttons). For example, if you want to program a CD player's remote, press CD.
- 2** Press LEARN to turn on the LEARN indicator.
- 3** Press the button on this unit's remote that is to "learn" the signal from the other remote. The LEARN indicator flashes slowly. Use only the shaded buttons shown above (see "Remote Button Descriptions" on page 36 for the buttons you can use to operate each component).

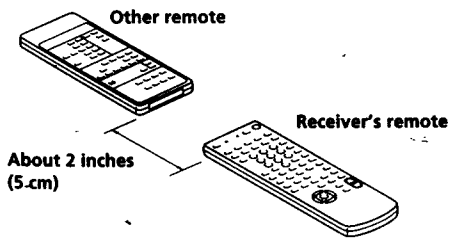

If the LEARN indicator flashes rapidly
You cannot use the button you've pressed.

- 4** On the other remote, select the function that the receiver's remote is to "learn" and hold down its button until the LEARN indicator lights steadily.
- 5** Repeat Steps 3 and 4 to program other buttons. Note that each button can only "learn" one signal from another remote.
- 6** Press LEARN. After the LEARN indicator turns off, you can control the other component with the programmed buttons.

💡 When you program the recording signal
Use the ● button to memorize the signal.

💡 If you cannot successfully program signals, check the following:

- If the LEARN indicator does not light up at all, the batteries are weak. Replace both batteries.
- If the LEARN indicator does not flash or light up in Step 3 or 4, there is interference. Clear the signal as described in "Clearing the programmed signals" below and program again from the beginning.
- The two remotes are placed too far apart. Make sure they are only 2 inches apart.
- If you don't proceed to the following steps within about 1 minute during Steps 2 and 3, the remote automatically exits learning mode. Start again from Step 2.
- If the memory in the remote has become full (If you program signals of Sony components, you can store about 60 signals.), you can program a new signal on a previously programmed button, but the new signal will replace the previously programmed one.

Notes

- You cannot turn on programmed components by pressing a SYSTEM CONTROL / FUNCTION button. You have to turn on the component's power switch.
- Do not program remote signals of air conditioners or other household appliances.

Clearing the programmed signals

To clear all the programmed signals, do the following. The button's functions are reset to the factory-preset.

- 1** Press LEARN to turn on the LEARN indicator.
- 2** Hold down SYSTEM OFF, VISUAL POWER, and MASTER VOL - until the LEARN indicator flashes three times and then turns off.

Additional Information

Troubleshooting

If you experience any of the following difficulties while using the receiver, use this troubleshooting guide to help you remedy the problem. Should any problem persist, consult your nearest Sony dealer.

There's no sound or only a very low-level sound is heard.

- Check that the speakers and components are connected securely.
- Make sure you select the correct component on the receiver.
- Make sure you set the SPEAKERS selector correctly (see page 9).
- Press MUTING on the remote if "MUTING" is shown in the display.
- The protective device on the receiver has been activated because of a short circuit. Turn off the receiver, eliminate the short-circuit problem and turn on the power again.

The left and right sounds are unbalanced or reversed.

- Check that the speakers and components are connected correctly and securely.
- Adjust the BALANCE control.

Severe hum or noise is heard.

- Check that the speakers and components are connected securely.
- Check that the connecting cords are away from a transformer or motor, and at least 10 feet (3 meters) away from a TV set or fluorescent light.
- Place your TV away from the audio components.
- Make sure you connect a ground wire to the SIGNAL GND terminal.
- The plugs and jacks are dirty. Wipe them with a cloth slightly moistened with alcohol.

No sound is heard from the center speaker.

- Select a DOLBY or MOVIE (except MONO MOVIE) sound field (see page 22).
- Select the appropriate speaker type and the location of the rear speakers (see page 20).
- Adjust the speaker volume appropriately (see page 21).

A component cannot be selected.

- Check the FUNCTION HOOKUP setting of the component (see page 15).

Recording cannot be made.

- Check that the components are connected correctly.
- Select the source component with the FUNCTION control.
- You cannot record audio from a program source connected to the LD DVD AC-3 RF/COAXIAL/OPTICAL IN or LD jacks (see page 11).

No sound or only a very low-level sound is heard from the rear speakers.

- Select the appropriate size of the rear speakers (see page 20).
- Adjust the speaker volume appropriately (see page 21).
- Make sure you turned on the sound field function.

Radio stations cannot be tuned in.

- Check that the antennas are connected securely. Adjust the antennas and connect an external antenna if necessary.
- The signal strength of the stations is too weak (when you tune in with automatic tuning). Use direct tuning.
- Make sure you set the tuning interval correctly (when you tune in AM stations with automatic tuning) (see pages 16 and 32).
- No stations have been preset or the preset stations have been cleared (when you tune in with scanning preset stations). Preset the stations (see page 16).
- Press DISPLAY so that the frequency appears in the display (when you tune with automatic tuning).

Surround effect cannot be obtained.

- Turn on the sound field function.

No picture or an unclear picture appears on the TV screen or on the monitor.

- Select the appropriate function on the receiver.
- Set your TV to the appropriate input mode (press TV/VIDEO on the remote for Sony TVs).
- Place your TV away from the audio components.

The remote does not function.

- Point the remote at the remote sensor  on the receiver.
- Remove the obstacles in the path of the remote and the receiver.
- Replace both batteries in the remote with new ones if they are weak.
- Make sure you select the correct function on the remote.
- Pressing TV CONTROL ON sets the remote to operate the TV only. In this case, press one of the SYSTEM CONTROL/FUNCTION buttons before operating the receiver (etc.).
- Press POWER on the main unit to turn on the receiver and check the FUNCTION HOOKUP setting of the component you want to use. the component is set to NO, the receiver and the component will not turn on when you press respective SYSTEM CONTROL/FUNCTION button.

Specifications

AUDIO POWER SPECIFICATIONS

POWER OUTPUT AND TOTAL HARMONIC DISTORTION

With 8-ohm load, both channels driven, from 20 - 20,000 Hz, rated 100 watts per channel, minimum RMS power, with no more than 0.09% total harmonic distortion from 250 milliwatts to rated output (USA model only).

Amplifier section

POWER OUTPUT

Stereo mode (8 ohms 20 Hz - 20 kHz, THD 0.05%)
100 W + 100 W

Surround mode (8 ohms at 1 kHz, THD 0.05%)

Front: 100 W/ch
Center¹⁾: 100W
Rear¹⁾: 100 W/ch
1) Depending on the sound field settings and the source, sound will not be output.

Dynamic power output

155 W + 155 W, 8 ohms
220 W + 220 W, 4 ohms

Harmonic distortion at rated output

Less than 0.05% (with DIRECT PASS on)

Frequency response

PHONO:
RIAA equalization curve
±0.5 dB
CD, TAPE, DAT/MD, VIDEO 1, 2, 3, LD/DVD, TV (/DBS):
10 Hz - 50 kHz ± 0.5 dB (with DIRECT PASS on)

Inputs

	Sensitivity	Impedance	S/N (weighting network, input level)
PHONO	2.5 mV	50 kilohms	75 dB ²⁾ (A, 2.5 mV)
CD	200 mV		
TAPE, DAT/MD, VIDEO 1, 2, 3, LD, TV/DBS	200 mV	50 kilohms	82 dB ²⁾ (A, 150 mV)
LD DVD AC-3 RF IN	—	75 Ω	100 dB (A, 20kHz, LFF)
LD DVD COAXIAL IN	0.5 V _{p-p}	75 Ω	100 dB (A, 20kHz, LFF)
LD DVD/TV (DBS)/CD/DAT MD OPTICAL IN	—	—	100 dB (A, 20kHz, LFF)

²⁾ 78 IHF

Outputs

VIDEO 1, 2 AUDIO OUT:
Voltage: 200 mV,
Impedance: 1 kilohm
PRE OUT
Voltage: 2 V_{rms}
Impedance: 1 kilohm
PHONES:
Accepts low and high impedance headphones

BASS BOOST +6 dB at 70 Hz

Digital signal processor section

Modulation (A/D conversion)

High Density Linear Converter

Demodulation (D/A conversion)

High Density Linear Converter (Advanced pulse D/A converter)

Sampling frequency

48 kHz

Surround

LFE MIX:

MUTE, -20 - 0 dB, 0.5 dB step

D. RANGE COMP:

OFF, 0.1 - 0.9, STD, MAX

REAR level:

-20 - +10 dB, 0.5 dB step

CENTER level:

-20 - +10 dB, 0.5 dB step

SUB WOOFER level:

-20 - +10 dB, 0.5 dB step

EFFECT:

21-step adjustable

WALL:

17-step adjustable

SEAT F/R:

17-step adjustable

SEAT L/R:

17-step adjustable

REBERB time:

17-step adjustable

Depending on the sound field, some parameters may not be adjustable (see page 25).

Equalizer

BAND: BASS/TREBLE

Turnover frequency:

Bass: 99 Hz - 992 Hz

Treble: 1.0 kHz - 8.6 kHz

Level: ±10 dB, 0.5 dB step

FM tuner section

Tuning range 87.5 - 108.0 MHz

Antenna terminals

75 ohms, unbalanced

Sensitivity

Mono: 18.3 dBf, 4.5 μ V

Stereo: 38.3 dBf, 45 μ V

Usable sensitivity

11.2 dBf, 2 μ V (IHF)

S/N

Mono: 76 dB

Stereo: 70 dB

Harmonic distortion at 1 kHz

Mono: 0.3%

Stereo: 0.5%

Separation

45 dB at 1 kHz

Frequency response

30 Hz - 15 kHz ± 0.5 dB

Selectivity

60 dB at 400 kHz

Additional Information

AM tuner section

Tuning range With 10 kHz interval:
 530 - 1710 kHz (USA and Canadian model only³⁾)
 530 - 1610 kHz (models for all other countries except for Australia)
 With 9 kHz interval:
 531 - 1710 kHz (USA and Canadian model only)
 531 - 1602 kHz (Australian model and models for all other countries³⁾)

Antenna Loop antenna

Usable sensitivity 50 dB/m (at 1,000 kHz or 999 kHz)

S/N 54 dB (at 50 mV/m)

Harmonic distortion 0.5 % (50 mV/m, 400 kHz)

Selectivity At 9 kHz: 35 dB
 At 10 kHz: 40 dB

3) You can change the AM tuning interval to 9 kHz (USA and Canadian models only) or to 10 kHz (models for all other countries except for Australia). After tuning in any AM station, turn off the receiver. Hold down the PRESET TUNING + button and press the POWER button. All preset stations will be erased when you change the interval. To reset the interval to 10 kHz (or 9 kHz), repeat the procedure.

Video section

Inputs VIDEO : 1 Vp-p 75 ohms
 S VIDEO:
 Y: 1 Vp-p 75 ohms
 C: 0.286 Vp-p 75 ohms

Outputs VIDEO : 1 Vp-p 75 ohms
 S VIDEO:
 Y: 1 Vp-p 75 ohms
 C: 0.286 Vp-p 75 ohms

General

System Tuner section:
 PLL quartz-locked digital synthesizer system
 Preamplifier section:
 Low-noise NF type equalizer
 Power amplifier section:
 Pure-complementary parallel P. P.

Power requirements
 USA and Canadian models:
 120 V AC, 60 Hz
 Australian model:
 240 V AC, 50 Hz
 Other models:
 120/220/240 V AC selectable, 50/60 Hz

Power consumption
 USA model: 340 W
 Canadian model: 500 VA
 Australian model: 380 W
 Other models: 380 W

AC outlets USA and Canadian models:
 2 switched, total
 120 W
 Australian model:
 1 switched, maximum
 100 W
 Other models:
 2 switched, total
 100 W

Dimensions 430 × 160 × 435 (440⁴⁾) mm
 (17 × 6 ³/₈ × 17 ¹/₄ (17 ³/₈) inches) including projecting parts and controls

4) When the front cover is open

Mass (Approx.) 15.9 kg (35 lb 1 oz)

Supplied accessories
 See page 4.

Design and specifications are subject to change without notice.

Glossary

Center mode

Setting of speakers to enhance Dolby Pro Logic Surround mode. To obtain the best possible surround sound, specify the type of each speaker (page 20) according to your speaker system.

For your reference, the following table shows the relationship between the speaker type parameters and the center mode.

FS	CS	RS	C.Mode
SMALL	SMALL	SMALL	—
LARGE	SMALL	SMALL	NORMAL
SMALL	SMALL	LARGE	—
LARGE	SMALL	LARGE	NORMAL
LARGE	LARGE	SMALL	WIDE
LARGE	LARGE	LARGE	WIDE
SMALL	LARGE	SMALL	—
SMALL	LARGE	LARGE	—
SMALL	NO	SMALL	—
LARGE	NO	SMALL	PHANTOM
LARGE	NO	LARGE	PHANTOM
SMALL	NO	LARGE	—
LARGE	SMALL	NO	—
LARGE	LARGE	NO	3CH LOGIC
SMALL	SMALL	NO	—
SMALL	LARGE	NO	—

FS: Front speaker size

CS: Center speaker size

RS: Rear speaker size

C.Mode: Dolby Pro Logic center mode

Delay time

Time lag between the surround sound output from front speakers and rear speakers. By adjusting the delay time of the rear speakers, you can obtain the feeling of presence. Make the delay time longer when you have placed the rear speakers in a small room or close to your listening position, and make it shorter when you have placed them in a large room or apart from your listening position.

Dolby Digital (AC-3)

This is a new digital surround system proposed to reproduce Dolby SR-D (the 3 dimensional sound system developed for use in movie theaters) in the home. This technology allows you to enjoy the full 5.1 ch soundtrack intended by the filmmaker, in the comfort of your own home.

Dolby Pro Logic Surround

Decoding system of Dolby Surround sound standardized in TV programs and movies. Compared with the former Dolby Surround system, Dolby Pro Logic Surround improves sound image by using four separate channels: off-screen audio effects, on-screen dialog, left-to-right panning, and music. These channels manipulate the sound to be heard and enhance the action as it happens on the screen. To take advantage of Dolby Pro Logic, you should have at least one pair of rear speakers and/or one center speaker. You also need to select the appropriate center mode to enjoy a full effect.

Effect level

Combination of the level of early reflections and reverberation. You can adjust the effect level in 6 levels. As you select higher levels, the room becomes "live," and as you select lower levels, the room becomes "dead."

Parameter

Variable of sound that composes sound image, such as tone or delay time. You can customize the pre-programmed sound fields by adjusting parameters to suit your listening situation.

Sound field

Sound pattern produced by a sounding source or sources in a given environment due to direct and reflected sounds and the acoustics of the environment.

Surround sound

Sound that consists of three elements: direct sound, early reflected sound (early reflections) and reverberative sound (reverberation). The acoustics where you hear the sound affect the way these three sound elements are heard. These sound elements are combined in such a way that you can actually feel the size and the type of a concert hall.

• Types of sound

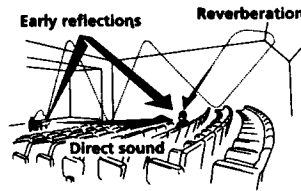

• Transition of sound from rear speakers

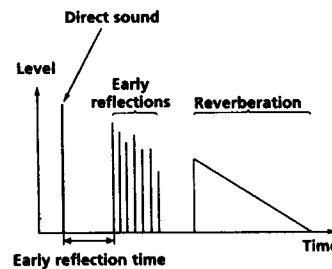

Additional Information

Table of Functions of the SET UP Button

You can make various settings using the SET UP button on the main unit and the digital processing control buttons. Operations related to each menu are explained in the previous sections. The table below describes how to access each menu.

Press SET UP repeatedly to select*	Press \uparrow or \downarrow to select	Then press \leftarrow or \rightarrow to select	See page
SPEAKER SETUP	FRONT SP.	LARGE or SMALL	20
	CENTER SP.	LARGE, SMALL, or NO	20
	REAR SP.		
	REAR SP.	SIDE or BEHIND	20
	SUB WOOFER	YES or NO	20
FUNCTION HOOKUP	VIDEO 1	CONNECT or NO	15
	VIDEO 2		
	LD/DVD		
	TV/DBS		
	TAPE		
	DAT/MD		
	CD		
OTHER SETUP	PHONO		
	CENTER DELAY	0 to 5ms (in 1 ms steps)	21
	REAR DELAY	0 to 15ms (in 5 ms steps)	21
	DIMMER	among 4 levels of brightness	14
	CONTROL A1 (USA and Canadian models only)	AUTO, FIX, or OFF	7

* "PLEASE PUSH CURSOR" appears in the display after 4 seconds you press the SET UP button.

Rear Panel Descriptions

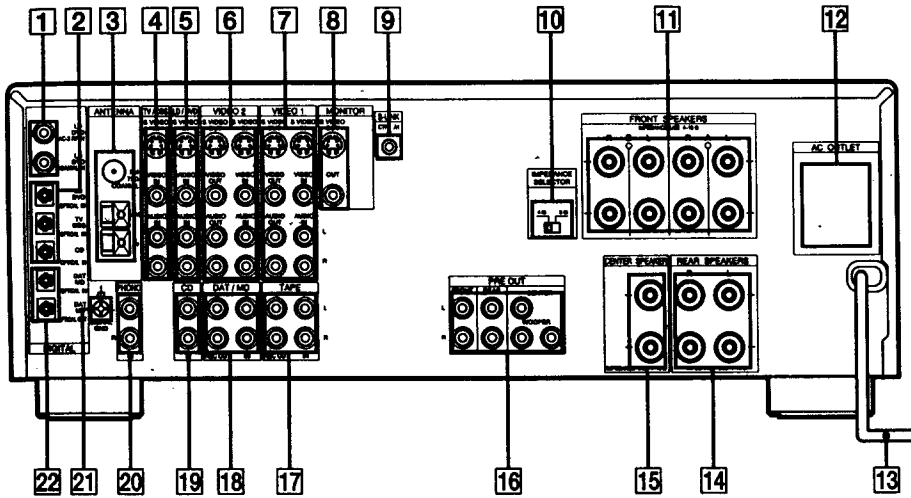

- | | | |
|---|---|--|
| <p>1 LD DVD AC-3 RF/COAXIAL IN</p> <p>2 LD DVD/TV DBS/CD OPTICAL IN (USA, Canadian, and Australian models)</p> <p>3 ANTENNA (AM/FM)</p> <p>4 TV/DBS (USA, Canadian, and Australian models)</p> <p>5 LD/DVD</p> | <p>6 VIDEO 2</p> <p>7 VIDEO 1</p> <p>8 MONITOR</p> <p>9 S-LINK CTRL A1 IN (USA and Canadian models only)</p> <p>10 IMPEDANCE SELECTOR</p> <p>11 FRONT SPEAKERS (A/B)</p> <p>12 AC OUTLET
(Outlet shape and position varies according to destination)</p> | <p>13 AC power cord</p> <p>14 REAR SPEAKERS</p> <p>15 CENTER SPEAKER</p> <p>16 PRE OUT</p> <p>17 TAPE</p> <p>18 DAT/MD</p> <p>19 CD</p> <p>20 PHONO</p> <p>21 ϕ SIGNAL GND</p> <p>22 DAT MD OPTICAL IN/OUT</p> |
|---|---|--|

Remote Button Descriptions

Page numbers in parentheses refer to procedures that use the remote button. In these procedures, the remote button is either required or used in place of a main-unit button with the same function and name (or a similar name). Refer to the table on the next page for an explanation of remote buttons not indicated below or for remote buttons without a corresponding button on the main unit.

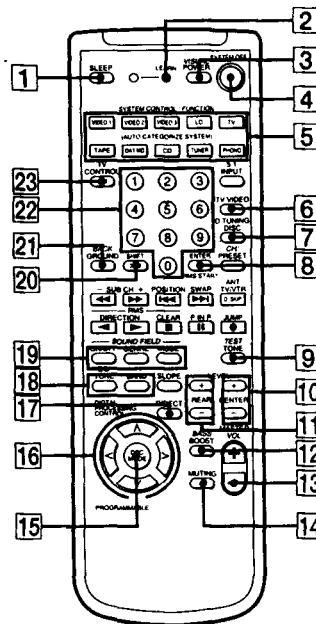

- | | | |
|--|---|--|
| 1 SLEEP (19) | 9 TEST TONE (21) | 17 DIRECT (14, 15) |
| 2 LEARN (29) | 10 CENTER LEVEL +/- (21) | 18 EQ/TONE/BAND (26) |
| 3 VISUAL POWER (29) | 11 REAR LEVEL +/- (21) | 19 SOUND FIELD ON/OFF/
GENRE/MODE (21, 22, 27) |
| 4 SYSTEM OFF (15, 29) | 12 BASS BOOST (14) | 20 SHIFT (16, 17) |
| 5 SYSTEM CONTROL/
FUNCTION (13-17, 28, 29) | 13 MASTER VOL +/- (13, 29) | 21 BACKGROUND (28) |
| 6 TV/VIDEO (15) | 14 MUTING (14) | 22 Numeric buttons (15-17, 28) |
| 7 D.TUNING (15) | 15 DPC MODE (17, 21, 26) | 23 TV CONTROL ON (15) |
| 8 ENTER (28) | 16 DIGITAL PROCESSING
CONTROL (14, 15, 17-21, 26) | |

Additional Information

Remote Button	Operates	Function
0-9, >10	Receiver	Selects preset numbers.
	CD player/MD deck/LD player	Selects track numbers. 0 selects track 10.
	TV/VCR	Selects channel numbers.
CH/PRESET +/-	Receiver	Scans and selects preset stations.
	TV/VCR	Selects preset channels.
DISC	CD player	Selects discs (CD player with multi-disc changer only).
D. SKIP	CD player	Skips discs (CD player with multi-disc changer only).
◀▶	CD/DVD player	Searches tracks (forward or backward).
	Tape deck/MD deck/VCR/LD player	Fast forwards or rewinds.
◀▶▶▶	CD/DVD player/MD deck/LD player	Skips tracks.
⏸	CD/DVD player/Tape deck/MD deck/LD player/VCR	Pauses play or record. (Also starts recording with components in record standby.)
▶	CD/DVD player/Tape deck/MD deck/LD player/VCR	Starts play.
■	CD/DVD player/Tape deck/MD deck/LD player/VCR	Stops play.
◀	Tape deck	Starts play on the reverse side.
●	Tape deck	Sets tape decks to the record standby mode.
● + ▶	Tape deck/MD deck/VCR	Starts recording when pressed with ▶ (or ◀ on tape deck).

Remote Button	Operates	Function
RMS DIRECTION	Tape deck	Selects tape direction (for tape decks with the RMS* function).
RMS CLEAR	Tape deck	Clears RMS* program (for tape decks with the RMS function).
RMS DIRECTION ◀▶	Tape deck	Programs tracks (tape deck with the RMS* function only).
ENTER	TV/VCR/DBS tuner/CD player	Changes channels/discs when used with 0-9.
VISUAL POWER	DVD/TV/VCR/DBS tuner/LD player	Turns on or off the power.
-/--	TV	Selects the channel entry mode, either one or two digit (in Europe only).
SUB CH +/-	TV	Selects preset channels for the small picture.**
POSITION	TV	Changes the position of the small picture.**
SWAP	TV	Swaps the small and the large picture.**
P IN P	TV	Activates the picture-in-picture function.**
JUMP	TV	Jumps back and forth between the previous and current channels.
ANT TV/VTR	VCR	Selects output signal from the antenna terminal: TV signal or VCR program.
MASTER VOL +/-	TV	Normally, adjusts the master volume of the receiver. If TV CONTROL ON was pressed, it adjusts the volume on the TV.
MUTING	TV	Normally, mutes the sound from the receiver. If TV CONTROL ON was pressed, the sound on the TV itself is muted.
5.1 INPUT	—	Not applicable.
SLOPE	—	Not applicable.

* RMS: Random Music Sensor

** Only for Sony TVs with the picture-in-picture function

Index

A

- Adjusting
 - delay time 21
 - effect and surround sound parameters 26
 - equalizer parameters 26
 - speaker volume 21
- Automatic tuning 16

B

- Background operation 28
- Battery 4

C

- Center mode 33
- Connecting. *See* Hookups
- Customizing
 - remote 28, 29
 - sound field 24-27

D

- Delay time 21, 33
- Direct tuning 15
- Dolby Digital 33
- Dolby Pro Logic Surround 33
- Dolby Surround setup 20, 21
- Dubbing. *See* Recording

E, F, G

- Editing. *See* Recording
- Effect level 25, 33

H

- Hookups
 - AC power cord 12
 - antennas 5
 - audio components 6
 - CONTROL A1 6
 - digital components 10, 11
 - overview 4
 - speakers 7-9
 - TV/VCRs 9, 10

I, J, K

- Indexing preset station and program source 17, 18

L

- Labeling. *See* Indexing

M, N, O

- Making components selectable/unselectable 15

P, Q

- Parameter 25-27, 33
- Preset number 16
- Preset station 16, 17
- Preset tuning 17

R

- Receiving broadcasts
 - by scanning stations. *See* Automatic tuning
 - directly. *See* Direct tuning
 - using preset stations. *See* Preset tuning
- Recording
 - on an audio tape or MD 18
 - on a video tape 19

Remote

- changing the setting 28
- clearing the signals 29
- controlling non-Sony components 29
- background operation 28
- programming 29

S

- Scanning
 - preset stations. *See* Preset tuning
 - radio stations 16
- Selecting a component
 - input mode 13
 - on the main unit 13, 14
 - using the remote 14, 15
- Sleep timer 19
- Sound field
 - adjustable parameters 25
 - customizing 24-27
 - pre-programmed 22-24, 33
 - resetting 27
- Speakers
 - connection 7-9
 - impedance 9
 - placement 8
 - selecting speaker system 9
 - specifying the speaker type and location of the rear speakers 20
- Supplied accessories 4
- Surround sound 20, 21, 33

T

- Test tone 21
- Tuning. *See* Receiving broadcasts

U, V

- Unpacking 4

W, X, Y, Z

- Watching TV/video programs 14

Names of controls

Buttons

- BACKGROUND 28
- BASS BOOST 14
- DIRECT PASS 14, 15
- DISPLAY 12, 16-18
- DPC MODE 17, 21, 26
- ENTER 28
- EQUALIZER BAND/CH 26
- FM/AM 15, 16
- FM MODE 16
- GENRE 21, 22
- INPUT MODE 13
- LEARN 29
- MEMORY 16
- MODE 21, 22
- MUTING 12, 14
- PANEL UP/DOWN 12, 13
- PRESET TUNING +/- 16
- SET UP 7, 14, 15, 20, 21
- SHIFT 16, 17
- SLEEP 19
- SOUND FIELD 21, 22, 27

- SYSTEM CONTROL/
FUNCTION 14, 28, 29
- SYSTEM OFF 15, 29
- TEST TONE 21
- TUNING +/- 16
- TV CONTROL ON 15
- ◆/◆/◆/◆ (digital processing control) 7, 14, 15, 17-21, 26
- Numeric buttons 15-17, 28

Switch and selector

- FUNCTION 13-17
- IMPEDANCE SELECTOR 9
- POWER 12, 13, 15, 27
- SPEAKERS 9, 14

Connectors and terminals

- ANTENNA (FM/AM) 5
- CENTER SPEAKER 8
- FRONT SPEAKERS A/B 7
- REAR SPEAKER 8
- ♯ SIGNAL GND 5, 6

Controls

- BALANCE 12, 14
- MASTER VOL 12, 13, 29

Jacks

- CD 6
- CD OPTICAL IN 11
- DAT/MD 6
- DAT MD OPTICAL IN/OUT 11
- LD 10
- LD DVD AC-3 RF/COAXIAL IN 11
- LD DVD OPTICAL IN 11
- MONITOR 9, 10
- PHONES 14
- PHONO 6
- PRE OUT 8, 9
- S-LINK CTRL A1 IN 6
- TAPE 6
- TV (/DBS) 9
- TV (DBS) OPTICAL IN 11
- VIDEO 1/2 6, 7, 9, 10

Indicators

- INDEX 17
- LEARN 29
- STANDBY 13, 15
- SUR 21, 26
- EQ 26

Other

- AC OUTLET 12
- ⊠ 4

Receiving Broadcasts

(direct tuning)

Example: Receiving FM 102.50 MHz

 Press TUNER on the remote.

↓
 Select FM.

↓
 (on the remote)

↓
① ② ③ ④ ⑤ ⑥
(on the remote)

Display

FM 102.50MHz

Scanning Radio Stations





(automatic tuning)

Example: Scanning FM stations

 Rotate until the TUNER indicator lights up.

↓
 Select the frequency display.

↓
 Select FM.

↓
 
↓
 

(To continue scanning.)

Receiving Preset Stations

Example: Receiving station number A7

 Press TUNER on the remote.

↓
 Select A.
(on the remote)

↓
⑦ (on the remote)

Scanning Preset Stations

 Rotate until the TUNER indicator lights up.

↓
 Select the frequency display.

↓
 

Selecting a Component

Example1: Playing a CD

 Rotate until the CD indicator lights up.

↓
Turn on the CD player.

↓
Start playing.

Example2: Watching a video tape

 Rotate until the VIDEO 1 indicator lights up.

↓
Turn on the VCR.

↓
Start playing.

Using Pre-programmed Sound Fields

Example: Watching a Dolby Surround-encoded movie on a laser disc player connected to LD

 Rotate until the LD/DVD indicator lights up.

↓
SOUND FIELD



↓

GENRE



↓

MODE



Press repeatedly to select DOLBY.

Press repeatedly to select NORMAL SURROUND or ENHANCED SURROUND.

↓
Turn on the LD player.

↓
Start playing.

Free Manuals Download Website

<http://myh66.com>

<http://usermanuals.us>

<http://www.somanuals.com>

<http://www.4manuals.cc>

<http://www.manual-lib.com>

<http://www.404manual.com>

<http://www.luxmanual.com>

<http://aubethermostatmanual.com>

Golf course search by state

<http://golfingnear.com>

Email search by domain

<http://emailbydomain.com>

Auto manuals search

<http://auto.somanuals.com>

TV manuals search

<http://tv.somanuals.com>