

FM Stereo FM/AM Receiver

Operating Instructions

STR-DE497

WARNING

To prevent fire or shock hazard, do not expose the unit to rain or moisture.

To prevent fire, do not cover the ventilation of the apparatus with newspapers, table-cloths, curtains, etc. And don't place lighted candles on the apparatus.

To prevent fire or shock hazard, do not place objects filled with liquids, such as vases, on the apparatus.

Do not install the appliance in a confined space, such as a bookcase or built-in cabinet.



Don't throw away batteries with general house waste; dispose of them correctly as chemical waste.

Except for customers in Europe



ENERGY STAR[®] is a U.S. registered mark. As an ENERGY STAR[®] partner, Sony Corporation has determined that this product meets the ENERGY STAR[®] guidelines for energy efficiency.

About This Manual

- The instructions in this manual are for model STR-DE497. Check your model number by looking at the lower right corner of the front panel.
- The instructions in this manual describe the controls on the receiver. You can also use the controls on the supplied remote if they have the same or similar names as those on the receiver. For details on the use of your remote, see pages 38-41.

About area codes

The area code of the receiver you purchased is shown on the lower portion of the rear panel (see the illustration below).

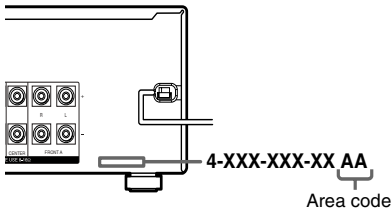

Any differences in operation, according to the area code, are clearly indicated in the text, for example, "Models of area code AA only".

This receiver incorporates Dolby* Digital and Pro Logic Surround and the DTS** Digital Surround System.

* Manufactured under license from Dolby Laboratories.

"Dolby", "Pro Logic" and the double-D symbol are trademarks of Dolby Laboratories.

**"DTS" and "DTS Digital Surround" are registered trademarks of Digital Theater Systems, Inc.

Table of Contents

Getting Started

- 1: Check how to hookup your components 5
 - 1a: Connecting components with digital audio output jacks 7
 - 1b: Connecting components with multi channel output jacks..... 10
 - 1c: Connecting components with only analog audio jacks 12
- 2: Connecting the antennas 14
- 3: Connecting speakers 15
- 4: Connecting the AC power cord 17
- 5: Setting up the speakers 18
- 6: Adjusting the speaker levels and balance 20
 - TEST TONE

Amplifier Operation

- Selecting the component 21
- Listening to multi channel sound 21
 - MULTI CH IN
- Listening to FM/AM radio 22
- Storing FM stations automatically 23
 - AUTOBETICAL
(Models of area code CEL, CEK only)
- Presetting radio stations 23
- Using the Radio Data System (RDS).... 24
 - (Models of area code CEL, CEK only)
- Changing the display 26
- About the indications in the display 27

Enjoying Surround Sound

- Using only the front speakers 28
- Enjoying higher fidelity sound 28
 - AUTO FORMAT DIRECT
- Selecting a sound field 29

Advanced Adjustments and Settings

- Switching the audio input mode for digital components 31
 - INPUT MODE
- Customizing sound fields 31
- Adjusting the tone 33
- Advanced settings 33

Other Operations

- Naming preset stations and inputs 35
- Using the Sleep Timer 36
- Selecting the speaker system 36
- Recording 37

Operations Using the Remote RM-U306B

- Before you use your remote 38
- Remote button description 38
- Changing the factory setting of an input button 41

Additional Information

- Precautions 42
- Troubleshooting 43
- Specifications 45
- List of button locations and reference pages 48
- Index 50

1: Check how to hookup your components

Steps 1a through 1c beginning on page 7 describe how to hook up your components to this receiver. Before you begin, refer to “Connectable components” below for the pages which describe how to connect each component.

After hooking up all your components, proceed to “2: Connecting the antennas” (page 14).

Connectable components

Component to be connected	Page
DVD player	
With digital audio output ^{a)}	7–8
With multi channel audio output ^{b)}	10–11
With analog audio output only ^{c)}	7–8
TV monitor	
With composite video input only	8, 11 or 13
Satellite tuner	
With digital audio output ^{a)}	7–8
With analog audio output only ^{c)}	7–8
Super Audio CD/CD player	
With digital audio output ^{a)}	9
With multi channel audio output ^{b)}	10
With analog audio output only ^{c)}	12
MD/Tape deck	
With analog audio output only ^{c)}	12
Multi channel decoder	10
VCR	13

- a) Model with a DIGITAL OPTICAL OUTPUT or DIGITAL COAXIAL OUTPUT jack, etc.
 b) Model with a MULTI CH OUTPUT jacks, etc. This connection is used to output the audio decoded by the component’s internal multi channel decoder through this receiver.
 c) Model equipped only with AUDIO OUT L/R jacks, etc.

Required cords

The hookup diagrams on the subsequent pages assume the use of the following optional connection cords (**A** to **F**) (not supplied).

A Audio cord

White (L)
Red (R)



B Audio/video cord

Yellow (video)
White (L/audio)
Red (R/audio)



C Video cord

Yellow



D Optical digital cord



E Coaxial digital cord



F Monaural audio cord

Black



Tip

Audio cord **A** can be torn into two monaural audio cords **F**.

Notes

- Turn off the power to all components before making any connections.
- Be sure to make connections firmly to avoid hum and noise.
- When connecting an audio/video cord, be sure to match the color-coded pins to the appropriate jacks on the components: yellow (video) to yellow; white (left, audio) to white; and red (right, audio) to red.
- When connecting optical digital cords, insert the cord plugs straight in until they click into place.
- Do not bend or tie optical digital cords.

1a: Connecting components with digital audio output jacks

Hooking up a DVD player or satellite tuner

For details on the required cords (A–F), see page 6.

1 Connect the audio jacks.

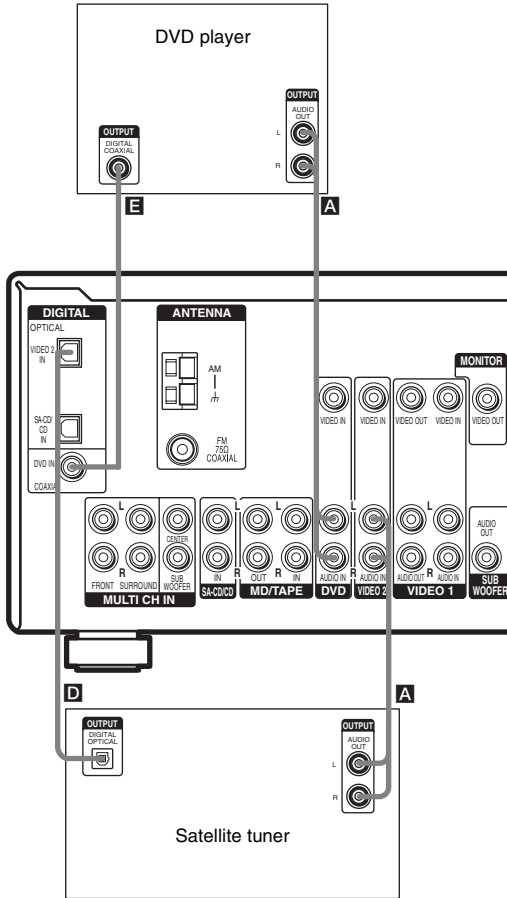

Note

You can listen to the sound of your TV by connecting your TV's audio output jacks to the VIDEO 2 AUDIO IN jacks on the receiver. In this case, do not connect the TV's video output jack to the VIDEO 2 VIDEO IN jack on the receiver.

continued

2 Connect the video jacks.

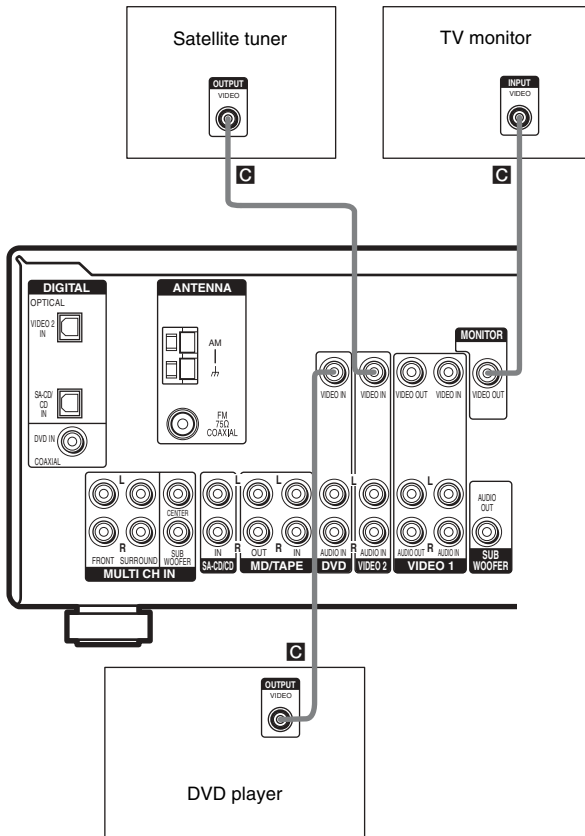

Hooking up a Super Audio CD/CD player

For details on the required cords (**A**–**F**), see page 6.

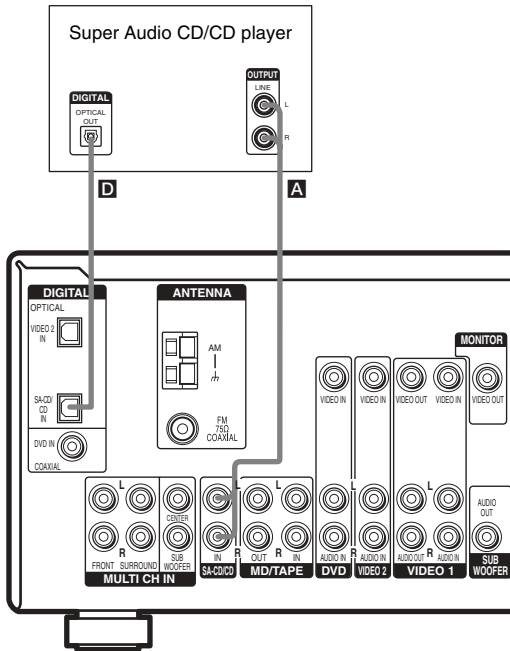

Tip

All the digital audio jacks are compatible with 32 kHz, 44.1 kHz, 48 kHz and 96 kHz sampling frequencies.

Note

The sound is not output when you play a Super Audio CD on the Super Audio CD player connected to the SA-CD/CD OPTICAL IN jack on this receiver. Connect to the analog input jacks (SA-CD/CD IN jacks). Refer to the operating instructions supplied with the Super Audio CD player.

1b: Connecting components with multi channel output jacks

1 Connect the audio jacks.

If your DVD or Super Audio CD player is equipped with multi channel output jacks, you can connect it to this receiver's MULTI CH IN jacks to enjoy the multi channel sound. Alternatively, the multi channel input jacks can be used to connect an external multi channel decoder. For details on the required cords (A-F), see page 6.

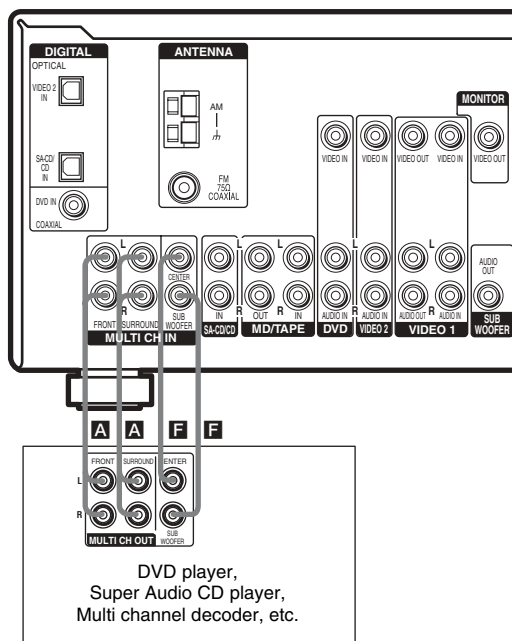

Tip

This connection also allows you to enjoy software with multi channel audio recorded in formats other than the Dolby Digital and DTS.

Note

When you make connections to the MULTI CH IN jacks, you will need to adjust the level of the surround speakers and sub woofer using the controls on the connected component.

2 Connect the video jacks.

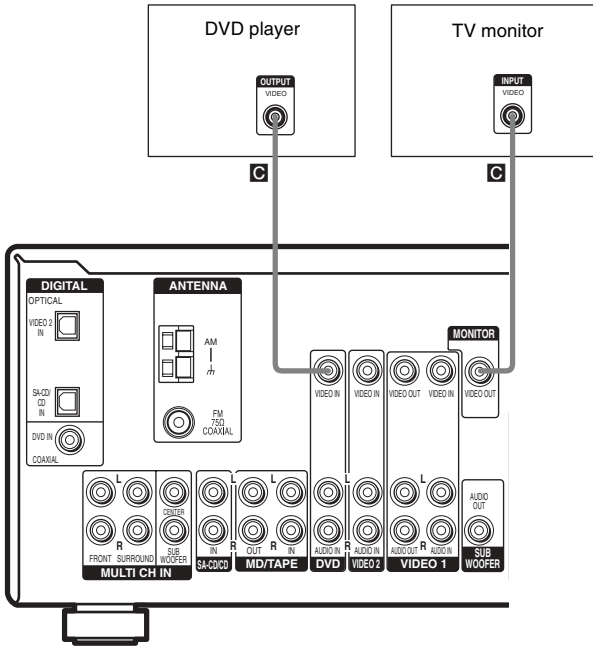

1c: Connecting components with only analog audio jacks

Hooking up audio components

For details on the required cords (**A–F**), see page 6.

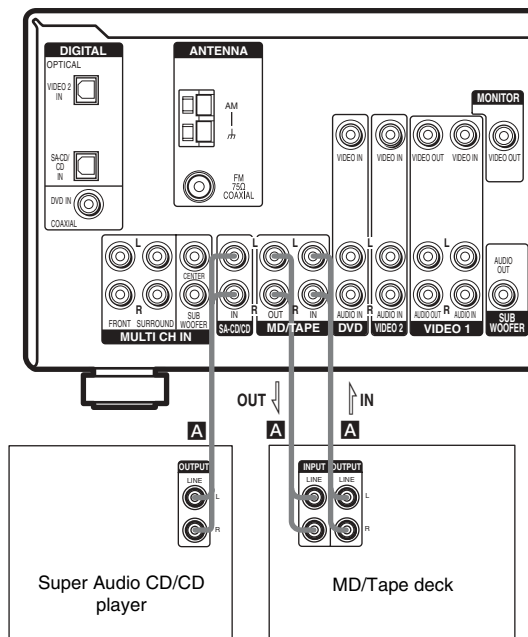

Hooking up video components

If you connect your TV to the MONITOR VIDEO OUT jack, you can watch the video from the selected input (page 21). For details on the required cords (**A–F**), see page 6.

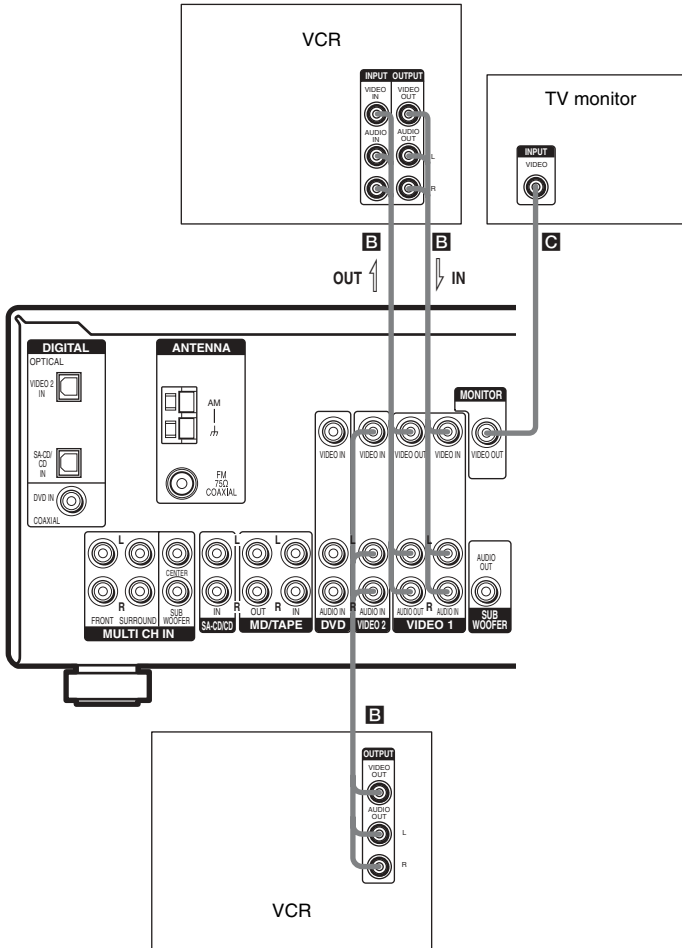

2: Connecting the antennas

Connect the supplied AM loop antenna and FM wire antenna.

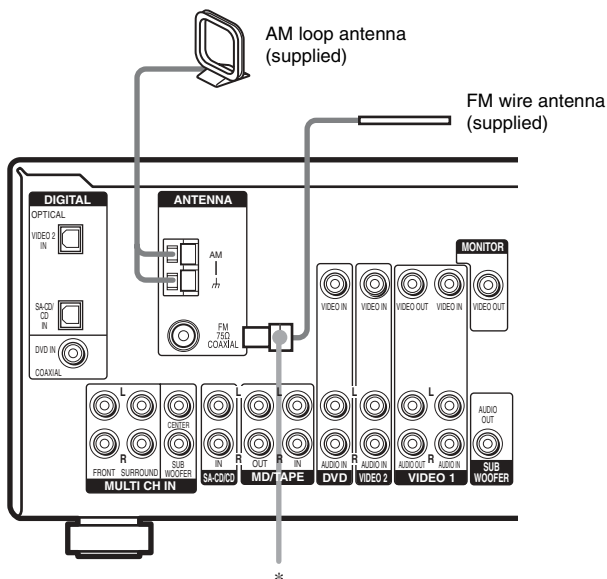

* The shape of the connector varies depending on the area code.

Notes

- To prevent noise pickup, keep the AM loop antenna away from the receiver and other components.
- Be sure to fully extend the FM wire antenna.
- After connecting the FM wire antenna, keep it as horizontal as possible.

3: Connecting speakers

Connect your speakers to the receiver. This receiver allows you to use a 5.1 channel speaker system. To fully enjoy theater-like multi channel surround sound requires five speakers (two front speakers, a center speaker, and two surround speakers) and a sub woofer (5.1 channel).

Example of 5.1 channel speaker system configuration

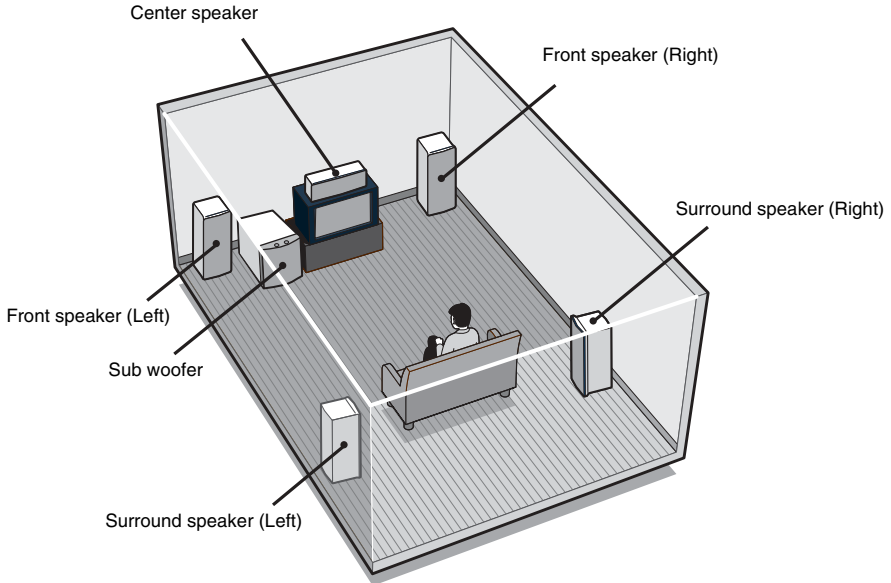

Tip

Since the sub woofer does not emit highly directional signals, you can place it wherever you want.

Required cords

A Speaker cords (not supplied)

(+)
(-)



B Monaural audio cord (not supplied)

Black

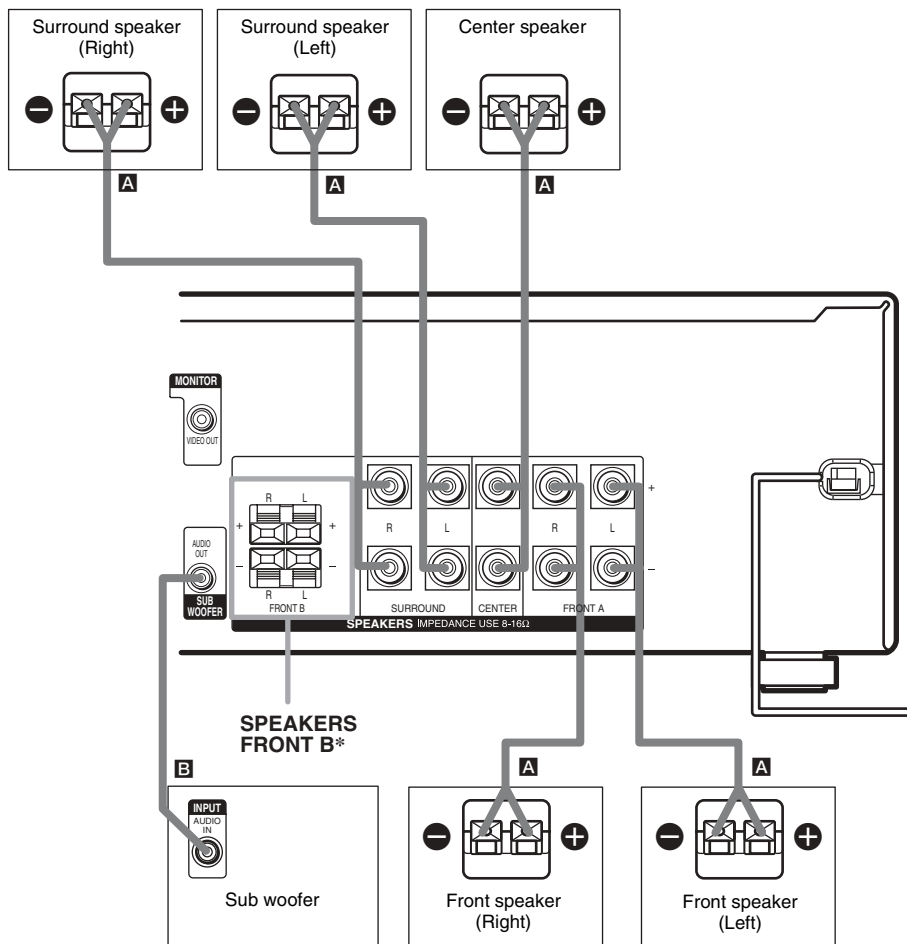

* If you have an additional front speaker system, connect them to the SPEAKERS FRONT B* terminals. You can select the front speakers you want to use with the SPEAKERS (OFF/A/B/A+B) button. For details, see “Selecting the speaker system” (page 36).

4: Connecting the AC power cord

Setting the voltage selector

If your receiver has a voltage selector on the rear panel, check that the voltage selector is set to the local power supply voltage. If not, use a screwdriver to set the selector to the correct position before connecting the AC power cord to a wall outlet.

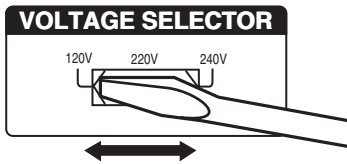

Connecting the AC power cord

Connect the AC power cord to a wall outlet.

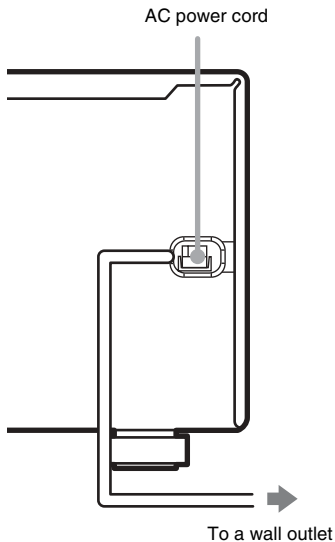

Performing initial setup operations

Before using the receiver for the first time, initialize the receiver by performing the following procedure.

This procedure can also be used to return settings you have made to their factory defaults. Use the buttons on the receiver for the operation.

1 Press I/⏻ to turn off the receiver.

2 Hold down I/⏻ for 5 seconds.

“PUSH” and “ENTER” appears in the display alternately.

3 Press ENTER.

“CLEARING” appears in the display for a while, then “CLEARED” appears.

The following are reset to their factory settings.

- All settings in the SET UP, LEVEL, TONE and CUSTOMIZE menus.
- The sound field memorized for each input and preset station.
- All sound field parameters.
- All preset stations.
- All index names for inputs and preset stations.
- MASTER VOLUME -/+ is set to “VOL MIN”.

5: Setting up the speakers

You can use the SET UP menu to set the size, distance and location of the speakers connected to this receiver.

1 Press I/⏻ to turn on the receiver.

2 Press MAIN MENU repeatedly to select “<SET UP>”.

3 Press < or > repeatedly to select the parameter you want to adjust.

For details, see “Speaker setup parameters” below.

Note

Some speaker setup items may appear dimmed in the display. This means that they have been adjusted automatically due to other speaker settings or may not be adjustable.

4 Press + or – repeatedly to select the setting you want.

The setting is entered automatically.

Note

Press ENTER on the receiver if you select the setting for “SP. PAT. X–X”.

5 Repeat steps 3 and 4 until you have set all of the items that follow.

Speaker setup parameters

The initial settings are underlined.

■ XXXX SET (Speaker easy setup)

• EASY

If you want to set up your speakers automatically, select “EASY SET”. You can select a pre-defined speaker pattern (see the supplied “Easy Setup Guide”).

• NORM

If you want to adjust the settings of each speaker manually, select “NORM SET”.

■ SP. PAT. X–X (Speaker setup pattern)

When you select “EASY SET”, select the speaker setup pattern. Press + or – repeatedly to select the speaker setup pattern and press ENTER to enter the selection. Check your speaker pattern using the supplied “Easy Setup Guide”.

■ S.W. XXX (SUB WOOFER) (Sub woofer selection)

• YES

If you connect a sub woofer, select “YES”.

• NO

If you did not connect a sub woofer, select “NO”. The front speakers are automatically set to “LARGE” and you cannot change this setting. This activates the bass redirection circuitry and outputs the LFE signals from other speakers.

- In order to take full advantage of the Dolby Digital bass redirection circuitry, we recommend that you set the cut off frequency on the sub woofer as high as possible.

■ XXXXX (FRONT) (Front speaker size)

• LARGE

If you connect large speakers that will effectively reproduce bass frequencies, select “LARGE”. Normally, select “LARGE”.

• SMALL

If the sound is distorted, or you feel a lack of surround effects when using multi channel surround sound, select “SMALL” to activate the bass redirection circuitry and output the front channel bass frequencies from the sub woofer. When the front speakers are set to “SMALL”, the center and surround speakers are also automatically set to “SMALL” (unless previously set to “NO”).

■ XXXXX (CENTER) (Center speaker size)

• LARGE

If you connect a large speaker that will effectively reproduce bass frequencies, select “LARGE”. Normally, select “LARGE”. However, if the front speakers are set to “SMALL”, you cannot set the center speaker to “LARGE”.

• SMALL

If the sound is distorted, or you feel a lack of surround effects when using multi channel surround sound, select “SMALL” to activate the bass redirection circuitry and output the center channel bass frequencies from the front speakers (if set to “LARGE”) or sub woofer.^{a)}

- NO

If you did not connect a center speaker, select “NO”. The sound of the center channel will be output from the front speakers.^{b)}

-  **XXXXX (SURROUND)**
(Surround speaker size)

- **LARGE**

If you connect large speakers that will effectively reproduce bass frequencies, select “LARGE”. Normally, select “LARGE”. However, if the front speakers are set to “SMALL”, you cannot set the surround speakers to “LARGE”.

- **SMALL**

If the sound is distorted, or you feel a lack of surround effects when using multi channel surround sound, select “SMALL” to activate the bass redirection circuitry and output the surround channel bass frequencies from the sub woofer or other “LARGE” speakers.

- NO

If you did not connect surround speakers, select “NO”.^{c)}

Tips

- a) – c) correspond to the following Dolby Pro Logic modes

- NORMAL
- PHANTOM
- 3 STEREO

- The “LARGE” and “SMALL” settings for each speaker determine whether the internal sound processor will cut the bass signal from that channel. When the bass is cut from a channel, the bass redirection circuitry sends the corresponding bass frequencies to the sub woofer or other “LARGE” speakers.

However, since bass sounds have a certain amount of directionality, it is best not to cut them, if possible. Therefore, even when using small speakers, you can set them to “LARGE” if you want to output the bass frequencies from that speaker. On the other hand, if you are using a large speaker, but prefer not to have bass frequencies output from that speaker, set it to “SMALL”.

If the overall sound level is lower than you prefer, set all speakers to “LARGE”. If there is not enough bass, you can use the BASS parameter in the TONE menu to boost the bass levels. To adjust the bass, see page 33.

-  **DIST. X.X m**
(Front speaker distance)

Initial setting: 3.0 m

Lets you set the distance from your listening position to the front speakers (A). You can adjust from 1.0 meter to 7.0 meters in 0.1 meter steps.

If both front speakers are not placed an equal distance from your listening position, set the distance to the closest speaker.

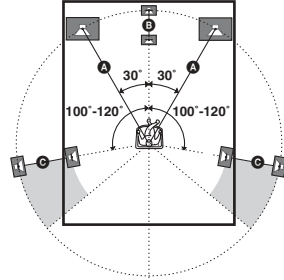

-  **DIST. X.X m**
(Center speaker distance)

Initial setting: 3.0 m

Lets you set the distance from your listening position to the center speaker. Center speaker distance should be set from a distance equal to the front speaker distance (A) to a distance 1.5 meters closer to your listening position (B).

-  **DIST. X.X m**
(Surround speaker distance)

Initial setting: 3.0 m

Lets you set the distance from your listening position to the surround speakers. Surround speaker distance should be set from a distance equal to the front speaker distance (A) to a distance 4.5 meters closer to your listening position (C).

If both surround speakers are not placed an equal distance from your listening position, set the distance to the closest speaker.

Tip

The receiver lets you to input the speaker position in terms of distance. However, it is not possible to set the center speaker further than the front speakers. Also, the center speaker cannot be set more than 1.5 meters closer than the front speakers.

Likewise, the surround speakers cannot be set further away from the listening position than the front speakers. And they can be no more than 4.5 meters closer.

This is because incorrect speaker placement is not conducive to the enjoyment of surround sound.

Please note that, setting the speaker distance closer than the actual location of the speakers will cause a delay in the output of the sound from that speaker. In other words, the speaker will sound like it is further away. For example, setting the center speaker distance 1–2 meters closer than the actual speaker position will create a fairly realistic sensation of being “inside” the screen. If you cannot obtain a satisfactory surround effect because the surround speakers are too close, setting the surround speaker distance closer (shorter) than the actual distance will create a larger sound stage. Adjusting these parameter while listening to the sound often results in much better surround sound. Give it a try!

■ PL. XXXX (Surround speaker placement)*

Lets you specify the height of your surround speakers for proper implementation of the surround effects of the Cinema Studio EX modes (page 29).

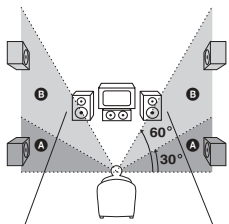

• LOW

Select if the height of your surround speakers corresponds to section **A**.

• HIGH

Select if the height of your surround speakers corresponds to section **B**.

* This setup item is not available when the surround speaker size parameter is set to “NO”.

6: Adjusting the speaker levels and balance

— TEST TONE

Adjust the speaker levels and balance while listening to the test tone from your listening position. Use the remote for the operation.

Tip

The receiver employs a test tone with a frequency centered at 800 Hz.

1 Press I/⏻ to turn on the receiver.

2 Press TEST TONE.

“T. TONE” appears in the display and the test tone is output from each speaker in sequence.

Front (left) → Center → Front (right) → Surround (right) → Surround (left) → Sub woofer

3 Adjust the speaker levels and balance using the LEVEL menu so that the level of the test tone sounds the same from each speaker.

For details on the LEVEL menu settings, see page 31.

Tips

- To adjust the level of all speakers at the same time, press MASTER VOL +/- on the remote or turn MASTER VOLUME +/- on the receiver.
- The adjusted value are shown in the display during adjustment.

4 Press TEST TONE again after adjustment.

The test tone turns off.

Notes

- The test tone cannot be used when MULTI CH IN function is used.
- Although these adjustments can also be made via the front panel using the LEVEL menu (when the test tone is output, the receiver switches to the LEVEL menu automatically), we recommend you follow the procedure described above and adjust the speaker levels from your listening position using the remote.

Selecting the component

1 Press input buttons to select the input.

To select the	Press
VCR	VIDEO 1 or VIDEO 2
Satellite tuner	VIDEO 2
DVD player	DVD
MD or tape deck	MD/TAPE
Super Audio CD or CD player	SA-CD/CD
Built-in tuner (FM/AM)	TUNER FM/AM

The selected input appears in the display.

2 Turn on the component and start playback.

Note

If you select the VCR or DVD player, set the TV's video input to match the component you selected.

3 Turn MASTER VOLUME \rightarrow / \leftarrow to adjust the volume.

Note

To avoid damaging your speakers, make sure that you turn down the volume before you turn off the receiver.

To mute the sound

Press **MUTING** on the remote.

The muting function will be canceled when you do the following.

- Press **MUTING** on the remote again.
- Turn the power off.
- Increase the volume.

To use the headphones

Connect the headphones to the **PHONES** jack.

When the headphones are connected, speaker output is automatically canceled and "SP A" and "SP B" do not light up in the display.

Listening to multi channel sound

— MULTI CH IN

You can select the audio directly from the components connected to the **MULTI CH IN** jacks. This enables you to enjoy high quality analog inputs such as DVD or Super Audio CD. When **MULTI CH IN** is selected, the tone and sound field cannot be used.

Press **MULTI CH IN**.

Press again to cancel the **MULTI CH IN** function.

When **MULTI CHANNEL DECODING** indicator lights up

The **MULTI CHANNEL DECODING** indicator lights up when the receiver is decoding multi channel sources.

However, this indicator does not light up if you select **2CH STEREO** mode.

Listening to FM/AM radio

You can listen to FM and AM broadcasts through the built-in tuner. Before operation, make sure you have connected the FM and AM antennas to the receiver (see page 14).

Tip

The tuning scale differs depending on the area code as shown in the following table. For details on area codes, see page 3.

Area code	FM	AM
CEL, CEK, SP, TW, KR, AU	50 kHz	9 kHz
E2/E3	50 kHz	9 kHz*

* The AM tuning scale can be changed (see page 47).

Automatic tuning

If you do not know the frequency of the station you want, you can let the receiver scan all available stations in your area.

1 Press TUNER FM/AM repeatedly to select the FM or AM band.

The last received station is tuned in.

2 Press TUNING + or TUNING –.

Press TUNING + to scan from low to high; press TUNING – to scan from high to low.

The receiver stops scanning whenever a station is received.

Tip

If “STEREO” flashes in the display and the FM stereo reception is poor, press FM MODE to change to monaural (MONO). You will not be able to enjoy the stereo effect, but the sound will be less distorted. To return to stereo mode, press FM MODE again.

Direct tuning

You can enter the frequency of the station you want directly. Use the remote for the operation.

1 Press TUNER repeatedly to select the FM or AM band.

The last received station is tuned in.

Tip

You can also use TUNER FM/AM on the receiver.

2 Press D.TUNING.

3 Press the numeric buttons to enter the frequency.

Example 1: FM 102.50 MHz

Press 1 → 0 → 2 → 5 → 0

Example 2: AM 1,350 kHz

(You do not have to enter the last “0” when the tuning scale is set to 10 kHz.)

Press 1 → 3 → 5 → 0

If you have tuned in an AM station, adjust the direction of the AM loop antenna for optimum reception.

If you cannot tune in a station and the entered numbers flash

Make sure you have entered the right frequency.

If not, repeat steps 2 and 3. If the entered numbers still flash, the frequency is not used in your area.

Storing FM stations automatically

— *AUTOBETICAL*

(Models of area code CEL, CEK only)

This function lets you store up to 30 FM and FM RDS stations in alphabetical order without redundancy. Additionally, it only stores the stations with the clearest signals.

If you want to store FM or AM stations one by one, see “Presetting radio stations”.

1 Press I/⏻ to turn off the receiver.

2 Hold down MEMORY and press I/⏻ to turn the receiver back on.

“AUTO-BETICAL SELECT” appears in the display and the receiver scans and stores all the FM and FM RDS stations in the broadcast area.

For RDS stations, the tuner first checks for stations broadcasting the same program, then stores only the one with the clearest signal. The selected RDS stations are sorted alphabetically by their Program Service name, then assigned a 2-character preset code. For more details on RDS, see page 24.

Regular FM stations are assigned 2-character preset codes and stored after the RDS station.

When done, “FINISH” appears in the display momentarily and the receiver returns to the normal operation.

Notes

- Do not press any button on the receiver or supplied remote during autobetrical operation, except I/⏻.
- If you move to another area, repeat this procedure to store stations in your new area.
- For details on tuning the stored stations, see “Tuning to preset stations”.
- If you move the antenna after storing stations with this procedure, the stored settings may no longer be valid. If this happens, repeat this procedure to store the stations again.

Presetting radio stations

You can preset up to 30 FM or AM stations. Then you can easily tune in the stations you often listen to.

Presetting radio stations

1 Press TUNER FM/AM repeatedly to select the FM or AM band.

The last received station is tuned in.

2 Tune in the station that you want to preset using Automatic Tuning (page 22) or Direct Tuning (page 22).

3 Press MEMORY.

“MEMORY” appears in the display for a few seconds. Do steps 4 to 5 before the display goes out.

4 Press PRESET TUNING + or PRESET TUNING – repeatedly to select a preset station number.

Each time you press the button, you can select the preset station number as follows:

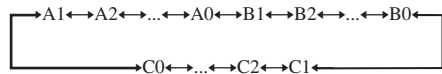

If “MEMORY” goes out before you select the preset station number, start again from step 3.

Tip

You can also use the remote to select a preset station number. Press SHIFT repeatedly to select a memory page (A, B or C) and then press the numeric buttons to select a preset number.

5 Press MEMORY again.

The station is stored to the selected preset number.

If “MEMORY” goes out before you press MEMORY, start again from step 3.

6 Repeat steps 2 to 5 to preset another station.

continued

Tuning to preset stations

- 1 Press TUNER FM/AM repeatedly to select the FM or AM band.

The last received station is tuned in.

- 2 Press PRESET TUNING + or PRESET TUNING – repeatedly to select the preset station you want.

Each time you press the button, you can select the preset station as follows:

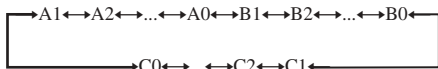

Using the remote

- 1 Press TUNER repeatedly to select the FM or AM band.
- 2 Press CH/PRESET –/+ repeatedly to select the preset station you want.

To select the preset station directly

Press the numeric buttons on the remote.

The preset station of the selected number in the current memory page is tuned in. Press SHIFT repeatedly on the remote to change the memory page.

Using the Radio Data System (RDS)

(Models of area code CEL, CEK only)

This receiver also allows you to use RDS (Radio Data System), which enables radio stations to send additional information along with the regular program signal. You can also display RDS information.

Notes

- RDS is operable only for FM stations.
- Not all FM stations provide RDS service, nor do they provide the same types of services. If you are not familiar with the RDS services in your area, check with your local radio stations for details.

Receiving RDS broadcasts

Simply select a station on the FM band using automatic tuning (page 22), direct tuning (page 22), or preset tuning (page 24).

When you tune in a station that provides RDS services, the RDS indicator lights up and the program service name appears in the display.

Note

RDS may not work properly if the station you tuned to is not transmitting the RDS signal properly or if the signal strength is weak.

Displaying RDS information

While receiving an RDS station, press **DISPLAY** repeatedly.

Each time you press the button, RDS information on the display changes cyclically as follows:

Program Service name → Frequency → Program Type indication^{a)} → Radio Text indication^{b)} → Current Time indication (in 24-hour system) → Sound field currently applied

^{a)} Type of program being broadcast (see page 25).

^{b)} Text messages sent by the RDS station.

Notes

- If there is an emergency announcement by government authorities, "ALARM" flashes in the display.
- When the message consists of 9 characters or more, the message scrolls across the display.
- If a station does not provide a particular RDS service, "NO XXXX" (such as "NO TEXT") appears in the display.

Description of program types

Program type indication	Description
NEWS	News programs
AFFAIRS	Topical programs that expand on current news
INFO	Programs offering information on a wide spectrum of subjects, including consumer affairs and medical advice
SPORT	Sports programs
EDUCATE	Educational programs, such as "how-to" and advice programs
DRAMA	Radio plays and serials
CULTURE	Programs about national or regional culture, such as language and social concerns
SCIENCE	Programs about the natural sciences and technology
VARIED	Other types of programs such as celebrity interviews, panel games, and comedy
POP M	Popular music programs
ROCK M	Rock music programs
EASY M	Easy Listening

Program type indication	Description
LIGHT M	Instrumental, vocal, and choral music
CLASSICS	Performances of major orchestras, chamber music, opera, etc.
OTHER M	Music that does not fit into any categories above, such as Rhythm & Blues and Reggae
WEATHER	Weather information
FINANCE	Stock market reports and trading, etc.
CHILDREN	Programs for children
SOCIAL	Programs about people and the things that affect them
RELIGION	Programs of religious content
PHONE IN	Programs where members of the public express their views by phone or in a public forum
TRAVEL	Programs about travel. Not for announcements that are located by TP/TA
LEISURE	Programs on recreational activities such as gardening, fishing, cooking, etc.
JAZZ	Jazz programs
COUNTRY	Country music programs
NATION M	Programs featuring the popular music of the country or region
OLDIES	Programs featuring oldies music
FOLK M	Folk music programs
DOCUMENT	Investigative features
NONE	Any programs not defined above

Changing the display

Changing the information in the display

You can check the sound field etc. by changing the information in the display.

Press DISPLAY repeatedly.

Each time you press DISPLAY, the display will change cyclically as follows.

Index name of the input* → Selected input → Sound field currently applied

When the tuner is selected

Program Service name** or preset station name*
→ Frequency → Program Type indication**
→ Radio Text indication** → Current Time indication (in 24-hour system)** → Sound field currently applied.

* Index name appears only when you have assigned one to the input or preset station (page 35). Index name does not appear when only blank spaces have been entered, or it is the same as the input name.

** During RDS reception only. (Models of area code CEL, CEK only. See page 25).

Adjusting the brightness of the display

Press DIMMER repeatedly.

The brightness of the display will change in 3 steps.

About the indications in the display

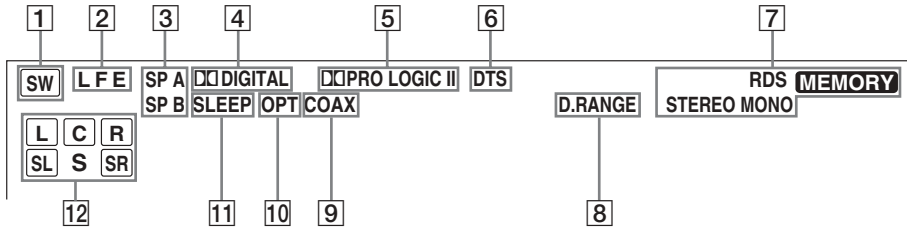

- 1 **SW:** Lights up when sub woofer selection is set to “YES” (page 18) and audio signal is output from the SUB WOOFER jack.
- 2 **LFE:** Lights up when the disc being played back contains the LFE (Low Frequency Effect) channel and the LFE channel signal is actually being reproduced.
- 3 **SP A/SP B:** Lights up in accordance with the speaker system being used (A or B). Turns off when speaker output is turned off or when headphones are connected.
- 4 **DIGITAL:** Lights up when the receiver is decoding signals recorded in the Dolby Digital format.
- 5 **PRO LOGIC II:** “PRO LOGIC” lights up when the receiver applies Pro Logic processing to 2 channel signals in order to output the center and surround channel signals. “PRO LOGIC II” lights up when the Pro Logic II Movie/Music decoder is activated. However, both indicators do not light up if both the center and surround speakers are set to “NO” and “A.F.D. AUTO”, “DOLBY PL”, “PLII MOV” or “PLII MUS” is selected.
- 6 **DTS:** Lights up when DTS signals are input.

Note

Dolby Pro Logic and Dolby Pro Logic II decoding do not function for DTS format signals.

- 7 **Tuner indicators:** Lights up when using the receiver to tune in radio stations, etc. See pages 22–25 for tuner operations.

Note

“RDS” appears for models of area code CEL, CEK only.

- 8 **D.RANGE:** Lights up when dynamic range compression is activated (page 32).
- 9 **COAX:** Lights up when the source signal is a digital signal being input through the COAXIAL terminal.
- 10 **OPT:** Lights up when the source signal is a digital signal being input through the OPTICAL terminal.
- 11 **SLEEP:** Lights up when sleep timer is activated.
- 12 **Playback channel indicators:** The letters (L, C, R, etc.) indicate the channels being played back. The boxes around the letters vary to show how the receiver downmixes the source sound (based on the speakers settings).

L (Front Left), R (Front Right), C (Center (monaural)), SL (Surround Left), SR (Surround Right), S (Surround (monaural) or the surround components obtained by Pro Logic processing))

Example:

Recording format (Front /Surround): 3/2
Output channel: Surround speakers absent
Sound Field: A.F.D. AUTO



When playing a DTS format disc, be sure that you have made digital connections and that INPUT MODE is not set to “ANALOG” (page 31).

Enjoying Surround Sound

Using only the front speakers

In this mode, the receiver outputs the sound from the front left/right speakers only. There is no sound from the sub woofer.

Listening to 2 channel stereo sources (2CH STEREO)

Standard 2 channel stereo sources completely bypass the sound field processing and multi channel surround formats are downmixed to 2 channel.

Press 2CH.

“2CH ST.” appears in the display and the receiver switches to the 2CH STEREO mode.

Note

No sound is output from the sub woofer in the 2CH STEREO mode. To listen to the 2 channel stereo sources using the front left/right speakers and a sub woofer, set to the A.F.D. mode.

Enjoying higher fidelity sound

— AUTO FORMAT DIRECT

The Auto Format Direct (A.F.D.) mode allows you to select the decoding mode you want for your audio sound.

A.F.D. mode (Display)	Decoding mode
A.F.D. AUTO (A.F.D. AUTO)	As encoded
PRO LOGIC (DOLBY PL)	Dolby Pro Logic
PRO LOGIC II MOVIE (PLII MOV)	Dolby Pro Logic II
PRO LOGIC II MUSIC (PLII MUS)	

Decoding the input audio signal automatically

In this mode, the receiver automatically detects the type of audio signal being input (Dolby Digital, DTS, standard 2 channel stereo, etc.) and performs the proper decoding if necessary. This mode presents the sound as it was recorded/encoded, without adding any surround effects. However, if there are no low frequency signals (Dolby Digital LFE, etc.) it will generate a low frequency signal for output to the sub woofer.

Press A.F.D. repeatedly to select “A.F.D. AUTO”.

The receiver automatically detects the type of audio signal being input and performs the proper decoding if necessary.

Enjoying stereo sound in multi channel (2 channel decoding mode)

This mode lets you specify the type of decoding for 2 channel audio sources. This receiver can reproduce 2 channel sound in 5 channels through Dolby Pro Logic II or 4 channels through Dolby Pro Logic.

Press A.F.D. repeatedly to select the 2 channel decoding mode.

The selected type of decoding appears in the display.

■ DOLBY PL (PRO LOGIC)

Performs Dolby Pro Logic decoding. The source recorded in 2 channel is decoded into 4.1 channels.

■ PLII MOV (PRO LOGIC II MOVIE)

Performs Dolby Pro Logic II Movie mode decoding. This setting is ideal for movies encoded in Dolby Surround. In addition, this mode can reproduce sound in 5.1 channel when watching videos of overdubbed or old movies.

■ PLII MUS (PRO LOGIC II MUSIC)

Performs Dolby Pro Logic II Music mode decoding. This setting is ideal for normal stereo sources such as CDs.

Note

Dolby Pro Logic and Dolby Pro Logic II decoding does not function for DTS format signals.

If you connect a sub woofer

When the audio signal is 2 channel stereo or if the source signal does not include a LFE signal, the receiver generates a low frequency signal for output to the sub woofer.

Selecting a sound field

You can take advantage of surround sound simply by selecting one of the receiver's pre-programmed sound fields. They bring the exciting and powerful sound of movie theaters and concert halls into your home.

Selecting a sound field for movies

Press MOVIE repeatedly to select the sound field you want.

The selected sound field appears in the display.

Sound field	Display
CINEMA STUDIO EX A DCS	C.ST.EX A
CINEMA STUDIO EX B DCS	C.ST.EX B
CINEMA STUDIO EX C DCS	C.ST.EX C

About DCS (Digital Cinema Sound)

Sound fields with **DCS** marks use DCS technology.

DCS is the concept name of the surround technology for home theater developed by Sony. DCS uses the DSP (Digital Signal Processor) technology to reproduce the sound characteristics of an actual cinema cutting studio in Hollywood.

When played at home, DCS will create a powerful theater effect that mimics the artistic combination of sound and action as envisioned by the movie director.

■ C.ST.EX A (CINEMA STUDIO EX A) **DCS**

Reproduces the sound characteristics of the Sony Pictures Entertainment "Cary Grant Theater" cinema production studio. This is a standard mode, great for watching most any type of movies.

■ C.ST.EX B (CINEMA STUDIO EX B) **DCS**

Reproduces the sound characteristics of the Sony Pictures Entertainment "Kim Novak Theater" cinema production studio. This mode is ideal for watching science-fiction or action movies with lots of sound effects.

continued

■ C.ST.EX C (CINEMA STUDIO EX C) DCS

Reproduces the sound characteristics of the Sony Pictures Entertainment scoring stage. This mode is ideal for watching musicals or films where orchestra music is featured in the soundtrack.

About CINEMA STUDIO EX modes

CINEMA STUDIO EX modes are suitable for watching motion picture DVDs (etc.), with multi channel surround effects. You can reproduce the sound characteristics of Sony Pictures Entertainment's dubbing studio in your home.

The CINEMA STUDIO EX modes consist of the following three elements.

- Virtual Multi Dimension
Creates 5 sets of virtual speakers from a single pair of actual surround speakers.
- Screen Depth Matching
Creates the sensation that the sound is coming from inside the screen like in theaters.
- Cinema Studio Reverberation
Reproduces the type of reverberation found in theaters.

The CINEMA STUDIO EX modes integrate these three elements simultaneously.

Notes

- The effects provided by the virtual speakers may cause increased noise in the playback signal.
- When listening with sound fields that employ the virtual speakers, you will not be able to hear any sound coming directly from the surround speakers.

Selecting a sound field for music

Press **MUSIC** repeatedly to select the sound field you want.

The selected sound field appears in the display.

Sound field	Display
HALL	HALL
JAZZ CLUB	JAZZ
LIVE CONCERT	CONCERT

■ HALL

Reproduces the acoustics of a classical concert hall.

■ JAZZ (JAZZ CLUB)

Reproduces the acoustics of a jazz club.



■ CONCERT (LIVE CONCERT)

Reproduces the acoustics of a 300-seat live house.

To turn off the surround effect

Press 2CH to select "2CH ST." or press A.F.D. repeatedly to select "A.F.D. AUTO".

Tips

- The receiver lets you apply the last selected sound field to an input whenever it is selected (Sound Field Link). For example, if you select HALL for the SA-CD/CD input, then change to a different input and then return to SA-CD/CD, HALL will automatically be applied again.
- You can identify the encoding format of DVD software, etc. by looking at the logo on the package.
 -  : Dolby Digital discs
 -  : Dolby Surround encoded programs
 -  : DTS Digital Surround encoded programs

Notes

- Sound fields do not function for the signals with a sampling frequency of more than 48 kHz.
- When one of the following sound fields are selected, no sound is output from the sub woofer if all the speakers are set to "LARGE" in the SET UP menu. However, the sound will be output from the sub woofer if the digital input signal contains LFE (Low Frequency Effect) signals, or if the front, center, or surround speakers are set to "SMALL".
 - HALL
 - JAZZ CLUB
 - LIVE CONCERT

Switching the audio input mode for digital components

— INPUT MODE

You can switch the audio input mode for components which have digital audio input jacks.

- 1 Press input buttons to select the input.**
- 2 Press INPUT MODE repeatedly to select the audio input mode.**

The selected audio input mode appears in the display.

Audio input modes

- **AUTO IN**
Gives priority to digital signals when there are both digital and analog connections. If there are no digital signals, analog is selected.
- **COAX IN**
Specifies the digital audio signals input to the DIGITAL COAXIAL input jack.
- **OPT IN**
Specifies the digital audio signals input to the DIGITAL OPTICAL input jacks.
- **ANALOG**
Specifies the analog audio signals input to the AUDIO IN (L/R) jacks.

Note

When signals with a sampling frequency of more than 48 kHz is input, the tone and sound field cannot be used.

Customizing sound fields

By adjusting the LEVEL menu, you can customize the sound fields to suit your particular listening situation.

Note on the displayed items

The setup items you can adjust in each menu vary depending on the sound field. Certain setup parameters may be dimmed in the display. This means that the selected parameter is either unavailable or fixed and unchangeable.

Adjusting the LEVEL menu

You can adjust the balance and level of each speaker. These settings are applied to all sound fields except for the effect level parameter. The effect level parameter settings are stored individually for each sound field.

- 1 Start playing a source encoded with multi channel surround effects (DVD, etc.).**
- 2 Press MAIN MENU repeatedly to select “<LEVEL>”.**
- 3 Press < or > repeatedly to select the parameter you want to adjust.**
For details, see “LEVEL menu parameters” below.
- 4 While monitoring the sound, press + or – repeatedly to select the setting you want.**
The setting is entered automatically.
- 5 Repeat steps 3 and 4 to adjust the other parameters.**

LEVEL menu parameters

The initial setting is underlined>.

-   **BAL. L/R XX**
(Front speaker balance)

Initial setting: BALANCE (0)

Lets you adjust the balance between front left and right speakers. You can adjust in the range of BAL. L (+1 to +8), BALANCE (0), BAL. R (+1 to +8) in 17 steps.

■ **CTR XXX dB**
(Center speaker level)

■ **SUR.L. XXX dB**
(Surround speaker (left) level)

■ **SUR.R. XXX dB**
(Surround speaker (right) level)

■ **S.W. XXX dB**
(Sub woofer level)

Initial setting: 0 dB

You can adjust from -10 dB to +10 dB in 1 dB steps.

■ **COMP. XXX**
(Dynamic range compressor)

Lets you compress the dynamic range of the sound track. This may be useful when you want to watch movies at low volumes late at night.

• **OFF**

The dynamic range is not compressed.

• **STD**

The dynamic range is compressed as intended by the recording engineer.

• **MAX**

The dynamic range is compressed dramatically.

Tip

Dynamic range compressor lets you compress the dynamic range of the soundtrack based on the dynamic range information included in the Dolby Digital signal. We recommend using the "MAX" setting. This greatly compresses the dynamic range and lets you view movies late at night at low volumes. Unlike analog limiters, the levels are predetermined and provide a very natural compression.

Note

Dynamic range compression is possible with Dolby Digital sources only.

■ **EFCT. XXX (Effect level)**

Initial setting: STD

Lets you adjust the "presence" of the surround effect.

Resetting sound fields to the initial settings

Use the buttons on the receiver for the operation.

1 Press I/⏻ to turn off the power.

2 While holding down 2CH, press I/⏻.

"SF. CLR." appears in the display and all sound fields are reset to the initial setting.

Adjusting the tone

You can adjust the tonal quality (bass, treble level) of the front speakers using the TONE menu.

- 1 Start playing a source encoded with multi channel surround effects (DVD, etc.).**
- 2 Press MAIN MENU repeatedly to select “<TONE>”.**
- 3 Press < or > repeatedly to select the parameter you want to adjust.**
For details, see “TONE menu parameters” below.
- 4 While monitoring the sound, press + or – repeatedly to select the setting you want.**
The setting is entered automatically.
- 5 Repeat steps 3 and 4 to adjust the other items.**

Note

You cannot adjust the tone when the receiver is decoding signals with a sampling frequency of more than 48 kHz.

TONE menu parameters

- **BASS XX dB**
(Front speaker bass level)
- **TREB. XX dB**
(Front speaker treble level)

Initial setting: 0 dB

You can adjust from -6 dB to +6 dB in 1 dB steps.

Advanced settings

Using the CUSTOMIZE menu to adjust the receiver

You can adjust various receiver settings using the CUSTOMIZE menu.

- 1 Press MAIN MENU repeatedly to select “<CUSTOM>”.**
- 2 Press < or > repeatedly to select the parameter you want to adjust.**
For details, see “CUSTOMIZE menu parameters” below.
- 3 Press + or – repeatedly to select the setting you want.**
The setting is entered automatically.
- 4 Repeat steps 2 and 3 to adjust the other items.**

CUSTOMIZE menu parameters

The initial setting is underlined>.

■ DEC. XXXX (Digital audio input decoding priority)

Lets you specify the input mode for the digital signal input to the DIGITAL IN jacks.

The initial setting is “DEC. AUTO” for VIDEO 2 and “DEC. PCM” for DVD and SA-CD/CD.

- AUTO
Automatically switches the input mode between DTS, Dolby Digital, or PCM.
- PCM
PCM signals are given priority (to prevent the interruption when playback starts). Even when other signals are input, the sound is output. However, this receiver cannot decode DTS-CD when set to “DEC. PCM”.

Note

When set to “DEC. AUTO” and the sound from the digital audio jacks (for CD, etc.) is interrupted when playback starts, set to “DEC. PCM”.

■ DUAL XXX

(Digital broadcast language selection)

Lets you select the language you want to listen to during digital broadcast. This feature only functions for Dolby Digital sources.

- **M/S (Main/Sub)**
Sound of the main language will be output through the front left speaker and sound of the sub language will be output through the front right speaker simultaneously.
- **M (Main)**
Sound of the main language will be output.
- **S (Sub)**
Sound of the sub language will be output.
- **M+S (Main + Sub)**
Mixed sound of both the main and sub languages will be output.

■ NAME IN

(Naming preset stations and inputs)

Lets you set the name of preset stations and inputs selected with input buttons. For details, see “Naming preset stations and inputs” on page 35.

Naming preset stations and inputs

You can enter a name of up to 8 characters for preset stations and inputs selected with input buttons, and display it in the receiver's display. Use the buttons on the receiver for the operation.

1 To index a preset station

Press TUNER FM/AM repeatedly to select the FM or AM band, then tune in the preset station you want to create an index name for (page 24).

To index an input

Press the input button to select the input you want to create an index name for.

2 Press MAIN MENU repeatedly to select “<CUSTOM>”.

3 Press < or > repeatedly to select “NAME IN”.

4 Press ENTER.

The cursor flashes and you can select a character.

5 Use < or > and + or – to create an index name.

Press + or – repeatedly to select a character, then press > to move the cursor to the next position.

Tips

- You can select the character type as follows by pressing + or – repeatedly.
Alphabet (upper case) → Numbers → Symbols
- To enter a blank space, press + or – repeatedly until a blank space appears in the display.
- If you made a mistake, press < or > repeatedly until the character you want to change flashes, then press + or – repeatedly to select the correct character.

6 Press ENTER to store the index name.

Note (Models of area code CEL, CEK only)

When you name an RDS station and tune in the station, the Program Service name appears instead of the name you entered. (You cannot change the name of a Program Service name. The name you entered will be overwritten by the Program Service name.)

Using the Sleep Timer

You can set the receiver to turn off automatically at a specified time. Use the remote for the operation.

Press SLEEP repeatedly while the power is on.

Each time you press SLEEP, the display changes cyclically as follows:

2-00-00 → 1-30-00 → 1-00-00 → 0-30-00 → OFF

While using Sleep Timer, "SLEEP" lights up in the display.

Tip

To check the remaining time before the receiver turns off, press SLEEP. The remaining time appears in the display. If you press SLEEP again, the sleep timer will be canceled.

Selecting the speaker system

You can select the front speaker system you want to use.

Press SPEAKERS (OFF/A/B/A+B) repeatedly to select the front speaker system you want to use.

The selected speaker system appears in the display. To turn off the speaker output, press SPEAKERS (OFF/A/B/A+B) repeatedly until "SP A" and "SP B" indication turn off.

The speaker system

- SP A
The speakers connected to the SPEAKERS FRONT A terminals.
- SP B
The speakers connected to the SPEAKERS FRONT B terminals.
- SP A and SP B
The speakers connected to both the SPEAKERS FRONT A and B terminals (parallel connection).

Recording

Before you begin, make sure you have connected all components properly.

Recording on an audio tape or MiniDisc

You can record on a cassette tape or MiniDisc using the receiver. See the operating instructions of your cassette deck or MD deck if you need help.

- 1 Select the component to be recorded.**
- 2 Prepare the component for playing.**
For example, insert a CD into the CD player.
- 3 Insert a blank tape or MD into the recording deck and adjust the recording level, if necessary.**
- 4 Start recording on the recording deck, then start playback on the playback component.**

Notes

- Sound adjustments do not affect the signal output from the MD/TAPE OUT jacks.
- The analog audio signals of the current input is output from the MD/TAPE OUT jacks.
- The signals input to the MULTI CH IN jacks are not output from the MD/TAPE OUT jacks even when MULTI CH IN is being used. The analog audio signals of the current or previously used input are output.
- Some sources contain copy guards to prevent recording. In this case, you may not be able to record from the sources.

Recording on a video tape

You can record from a VCR, a TV or a DVD using the receiver. You can also add audio from a variety of audio sources when editing a video tape. See the operating instructions of your VCR or DVD player if you need help.

- 1 Select the program source to be recorded.**
- 2 Prepare the component for playing.**
For example, insert a video tape you want to record into VCR.
- 3 Insert a blank video tape into the VCR (VIDEO 1) for recording.**
- 4 Start recording on the recording VCR, then start playing the video tape or DVD you want to record.**

Tip

You can record the sound from any audio source onto a video tape while copying from a video tape or DVD. Locate the point where you want to start recording from another audio source, select the program source, then start playback. The audio from that source will be recorded onto the audio track of the video tape instead of the audio from the original medium. To resume audio recording from the original medium, select the video source again.

Notes

- You cannot record a digital audio signal using a component connected to the analog VIDEO 1 OUT jacks.
- Make sure to make both digital and analog connections to the VIDEO 2 and DVD inputs. Analog recording is not possible if you make only digital connections.
- The analog audio signals of the current input are output from the VIDEO 1 OUT jacks.
- The signals input to the MULTI CH IN jacks are not output from VIDEO 1 OUT jacks even when MULTI CH IN is being used. The analog audio signals of the current or previously used input are output.

Operations Using the Remote RM-U306B

You can use the remote RM-U306B to operate the components in your system.

Before you use your remote

Inserting batteries into the remote

Insert R6 (size-AA) batteries with the + and – properly oriented in the battery compartment. When using the remote, point it at the remote sensor  on the receiver.

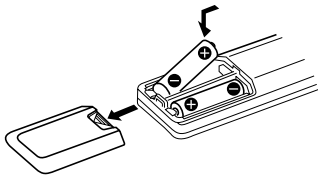

Tip

Under normal conditions, the batteries should last for about 6 months. When the remote no longer operates the receiver, replace all batteries with new ones.

Notes

- Do not leave the remote in an extremely hot or humid place.
- Do not use a new battery with an old one.
- Do not expose the remote sensor to direct sunlight or lighting apparatuses. Doing so may cause a malfunction.
- If you don't use the remote for an extended period of time, remove the batteries to avoid possible damage from battery leakage and corrosion.

Remote button description

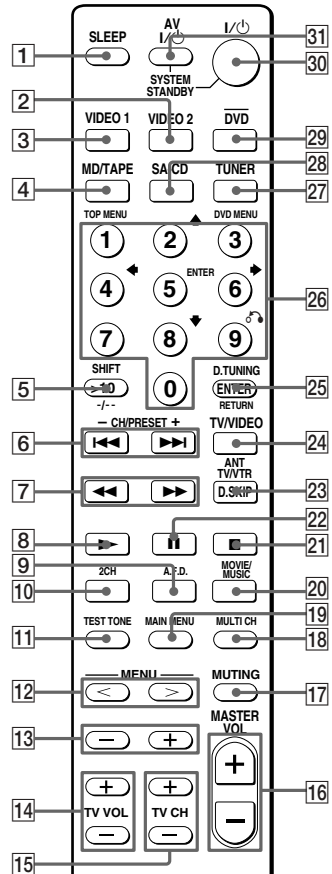











The tables below show the settings of each button.











Remote Button	Operations	Function
A.F.D. 9	Receiver	Selects the decoding mode for audio sound.



Remote Button	Operations	Function
ANT TV/VTR 23	VCR	Selects output signal from the antenna terminal: TV signal or VCR program.
AV I/⏻ 31	TV/VCR/ CD player/ VCD player/ LD player/ DVD player/ MD deck/ DAT deck	Turns the audio and video components on or off.
CH/PRESET	Receiver	Selects preset stations.
-/+ 6	TV/VCR/ Satellite tuner	Selects preset channel.
D.SKIP 23	CD player/ VCD player/ DVD player/ MD deck	Skips discs (multi-disc changer only).
D.TUNING 25	Receiver	Enters direct tuning mode.
DVD 29	Receiver	To watch DVD.
DVD MENU 26	DVD player	Displays DVD menu.
ENTER 25	TV/VCR/ Satellite tuner/ LD player/ MD deck/ DAT deck/ Tape deck	After selecting a channel, disc or track using the numeric buttons, press to enter the value.
ENTER 26	DVD player	Enters the selection.
MAIN MENU 19	Receiver	Selects the menu of the receiver.
MASTER VOL +/- 16	Receiver	Adjusts the master volume of the receiver.
MD/TAPE 4	Receiver	To listen to Minidisc or audio tape.

Remote Button	Operations	Function
MENU </> 12	Receiver	Selects a menu item.
MENU -/+ 13	Receiver	Adjusts or changes the setting.
MOVIE/MUSIC 20	Receiver	Selects the pre-programmed sound fields for movie and music.
MULTI CH 18	Receiver	Selects MULTI CH IN source.
MUTING 17	Receiver	Mutes the sound from the receiver.
RETURN 25	VCD player	Returns to the previous menu.
SA-CD 28	Receiver	To listen to Super Audio CD or compact disc.
SHIFT 5	Receiver	Selects a memory page for presetting radio stations or tuning to preset stations.
SLEEP 1	Receiver	Activates the sleep function and the duration which the receiver turns off automatically.
SYSTEM STANDBY (Press AV I/⏻ 31 and I/⏻ 30 at the same time)	Receiver/TV/ VCR/Satellite tuner/ CD player/ VCD player/ LD player/ DVD player/ MD deck/ DAT deck	Turns off the receiver and other Sony audio/video components.
TEST TONE 11	Receiver	Outputs test tone.
TOP MENU 26	DVD player	Displays DVD title.

continued

Remote Button	Operations	Function
TUNER 	Receiver	To listen to radio programs.
TV CH +/- 	TV	Selects preset TV channels.
TV/VIDEO 	TV	Selects input signal: TV input or video input.
TV VOL +/- 	TV	Adjusts the volume of the TV.
VIDEO 1 	Receiver	To watch VCR. (VTR mode 3)
VIDEO 2 	Receiver	To watch VCR. (VTR mode 1)
0-9 	Receiver	Use with SHIFT to preset radio station or tuning to preset stations and with D.TUNING for direct tuning.
	CD player/ VCD player/ LD player/ MD deck/ DAT deck	Selects track numbers. 0 selects track 10.
	TV/VCR/ Satellite tuner	Selects channel numbers.
2CH 	Receiver	Selects 2CH STEREO mode.
>10 	CD player/ VCD player/ LD player/ MD deck	Selects track numbers over 10.
-/-- 	TV	Selects the channel entry mode, either one or two digit.
I/⏻ 	Receiver	Turns the receiver on or off.

Remote Button	Operations	Function
 	VCR/ CD player/ VCD player/ LD player/ DVD player/ MD deck/ DAT deck/ Tape deck	Skips tracks.
 	CD player/ VCD player/ DVD player	Searches tracks in the forward or backward direction.
	VCR/ LD player/ MD deck/ DAT deck/ Tape deck	Fastforwards or rewinds.
 	VCR/ CD player/ VCD player/ LD player/ DVD player/ MD deck/ DAT deck/ Tape deck	Starts playback.
 	VCR/ CD player/ VCD player/ LD player/ DVD player/ MD deck/ DAT deck/ Tape deck	Pauses playback or recording. (Also starts recording with components in recording standby.)
 	VCR/ CD player/ VCD player/ LD player/ DVD player/ MD deck/ DAT deck/ Tape deck	Stops playback.

Remote Button	Operations	Function
	DVD player	Returns to the previous menu or exits the menu.
	DVD player	Selects a menu item.

Notes

- When you press the input buttons (VIDEO 1, VIDEO 2, DVD), the input mode of the TV might not switch to the corresponding input mode that you want. In this case, press the TV/VIDEO button to switch the input mode of the TV.
- Some functions explained in this section may not work depending on the model of the receiver.
- The above explanation is intended to serve as an example only. Therefore, depending on the component the above operation may not be possible or may operate differently than described.

Changing the factory setting of an input button

If the factory settings of the input buttons do not match your system components, you can change them. For example, if you have a tape deck and you do not have an MD deck, you can assign the MD/TAPE button to your tape deck.

Note that the settings of the TUNER button cannot be changed.

1 Hold down the input button whose input you want to change (for example, MD/TAPE).

2 Press the corresponding button of the component you want to assign to the input button (for example, 4 – Tape deck).

The following buttons are assigned to select the input:

To operate	Press
CD player	1
DAT deck	2
MD deck	3
Tape deck A	4
Tape deck B	5
LD player	6
VCR (command mode VTR 1*)	7
VCR (command mode VTR 2*)	8
VCR (command mode VTR 3*)	9
TV	0
DSS (Digital Satellite Receiver)	>10
DVD player	ENTER
VCD player	

*Sony VCRs are operated with a VTR 1, 2 or 3 setting. These correspond to Beta, 8mm and VHS respectively.

Now you can use the MD/TAPE button to control the tape deck.

To reset a button to its factory setting

Repeat the above procedure.

To reset all the input buttons to their factory setting

Press I/⏻, AV I/⏻ and MASTER VOL – at the same time.

Additional Information

Precautions

On safety

Should any solid object or liquid fall into the cabinet, unplug the receiver and have it checked by qualified personnel before operating it any further.

On power sources

- Before operating the receiver, check that the operating voltage is identical with your local power supply. The operating voltage is indicated on the nameplate at the rear of the receiver.
- The receiver is not disconnected from the AC power source (mains) as long as it is connected to the wall outlet, even if the receiver itself has been turned off.
- If you are not going to use the receiver for a long time, be sure to disconnect the receiver from the wall outlet. To disconnect the AC power cord, grasp the plug itself; never pull the cord.
- AC power cord must be changed only at the qualified service shop.

On heat buildup

Although the receiver heats up during operation, this is not a malfunction. If you continuously use this receiver at a large volume, the cabinet temperature of the top, side and bottom rises considerably. To avoid burning yourself, do not touch the cabinet.

On placement

- Place the receiver in a location with adequate ventilation to prevent heat buildup and prolong the life of the receiver.
- Do not place the receiver near heat sources, or in a place subject to direct sunlight, excessive dust or mechanical shock.
- Do not place anything on top of the cabinet that might block the ventilation holes and cause malfunctions.
- Use caution when placing the receiver on surfaces that have been specially treated (with wax, oil, polish, etc.) as staining or discoloration of the surface may result.

On operation

Before connecting other components, be sure to turn off and unplug the receiver.

On cleaning

Clean the cabinet, panel and controls with a soft cloth slightly moistened with a mild detergent solution. Do not use any type of abrasive pad, scouring powder or solvent such as alcohol or benzine.

If you have any question or problem concerning your receiver, please consult your nearest Sony dealer.

Troubleshooting

If you experience any of the following difficulties while using the receiver, use this troubleshooting guide to help you remedy the problem.

There is no sound or only a very low-level sound no matter which component is selected.

- Check that the speakers and components are connected securely and correctly.
- Check that both the receiver and all components are turned on.
- Check that you have selected the correct component on the receiver.
- Check that MASTER VOLUME -/+ is not set at "VOL MIN".
- Check that the SPEAKERS (OFF/A/B/A+B) is not set to off (page 36).
- Check that the headphones are not connected.
- Press MUTING on the remote to cancel the muting function.

There is no sound from a specific component.

- Check that the component is connected correctly to the audio input jacks for that component.
- Check that the cord(s) used for the connection is (are) fully inserted into the jacks on both the receiver and the component.
- Check that you have selected the correct component on the receiver.

There is no sound from one of the front speakers.

- Connect a pair of headphones to the PHONES jack to verify that sound is output from the headphones. If only one channel is output from the headphones, the component may not be connected to the receiver correctly. Check that all the cords are fully inserted into the jacks on both the receiver and the component. If both channels are output from the headphones, the front speaker may not be connected to the receiver correctly. Check the connection of the front speaker which is not outputting any sound.

There is no sound from analog 2 channel sources.

- Check that the INPUT MODE is not set to "COAX IN" or "OPT IN" (page 31).
- Check that you have not selected "MULTI CH IN".

There is no sound from digital sources (from COAXIAL or OPTICAL input jack).

- Check that the INPUT MODE is not set to "ANALOG" (page 31). Check that the INPUT MODE is not set to "COAX IN" for the sources from OPTICAL input jack, or set to "OPT IN" for the sources from COAXIAL input jack.
- Check that you have not selected "MULTI CH IN".

The left and right sounds are unbalanced or reversed.

- Check that the speakers and components are connected correctly and securely.
- Adjust balance parameters in the LEVEL menu.

There is severe hum or noise.

- Check that the speakers and components are connected securely.
- Check that the connecting cords are away from a transformer or motor, and at least 3 meters away from a TV set or fluorescent light.
- Move your TV away from the audio components.
- The plugs and jacks are dirty. Wipe them with a cloth slightly moistened with alcohol.

There is no sound or only a very low-level sound is heard from the center or/and surround speaker.

- Make sure the sound field function is on (press A.F.D., MOVIE or MUSIC).
- Select the CINEMA STUDIO EX mode (page 29).
- Adjust the speaker level (page 20).
- Make sure the center or/and surround speaker size parameter is set to either "SMALL" or "LARGE" (page 18).

There is no sound from the sub woofer.

- Check that the sub woofer is connected correctly and securely.
- Make sure the sub woofer selection parameter is set to "YES" (page 18).
- There is no sound output from the sub woofer depending on the sound field.

The surround effect cannot be obtained.

- Make sure the sound field function is on (press A.F.D., MOVIE or MUSIC).
- Sound fields do not function for the signals with a sampling frequency of more than 48 kHz.

Dolby Digital or DTS multi channel sound is not reproduced.

- Check that the playing DVD, etc. is recorded in Dolby Digital or DTS format.
- When connecting the DVD player, etc. to the digital input jacks of this receiver, check the audio setting (settings for the audio output) of the connected component.

Recording cannot be done.

- Check that the components are connected correctly.
- Select the source component with input buttons.
- Make sure that INPUT MODE is set to "ANALOG" (page 31) before recording from a digital component connected to the analog MD/TAPE terminals.

The FM reception is poor.

- Use a 75-ohm coaxial cable (not supplied) to connect the receiver to an outdoor FM antenna as shown below. If you connect the receiver to an outdoor antenna, ground it against lightning. To prevent a gas explosion, do not connect the ground wire to a gas pipe.

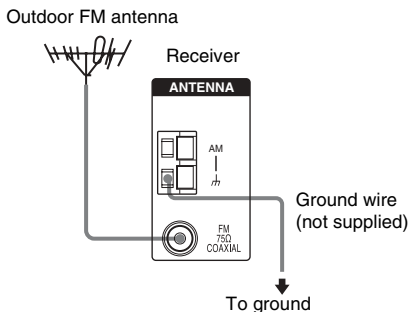

Radio stations cannot be tuned in.

- Check that the antennas are connected securely. Adjust the antennas and connect an external antenna if necessary.
- The signal strength of the stations is too weak (when tuning in with automatic tuning). Use direct tuning.
- Make sure you set the tuning interval correctly (when tuning in AM stations with direct tuning).
- No stations have been preset or the preset stations have been cleared (when tuning by scanning preset stations). Preset the stations (page 23).
- Press DISPLAY repeatedly so that the frequency appears in the display.

RDS does not work.*

- Make sure that you are tuned to an FM RDS station.
- Select a stronger FM station.

The RDS information that you want does not appear.*

- Contact the radio station and find out whether they actually provide the service in question. If so, the service may be temporarily out of order.

There is no picture or an unclear picture appears on the TV screen or monitor.

- Select the appropriate input on the receiver.
- Set your TV to the appropriate input mode.
- Move your TV away from the audio components.

* Models of area code CEL, CEK only.

Remote control

The remote does not function.

- Point the remote at the remote sensor  on the receiver.
- Remove any obstacles in the path between the remote and the receiver.
- Replace all the batteries in the remote with new ones, if they are weak.
- Make sure you select the correct input on the remote.

Error message

If there is a malfunction, the display shows a message.

PROTECT

Irregular current is output from the speakers. The receiver will automatically turn off after a few seconds. Check the speaker connection and turn on the power again. If this problem persists, consult your nearest Sony dealer.

If you are unable to remedy the problem using the troubleshooting guide

Clearing the receiver's memory may remedy the problem (page 17). However, note that all memorized settings will be reset to their factory settings and you will have to readjust all settings on the receiver.

If the problem persists

Consult your nearest Sony dealer.

Reference sections for clearing the receiver's memory

To clear	See
All memorized settings	page 17
Customized sound fields	page 32

Specifications

Amplifier section

POWER OUTPUT

Models of area code CEL, CEK

Rated Power Output at Stereo Mode
(8 ohms 1 kHz, THD 0.7%)

80 W + 80 W¹⁾

Reference Power Output¹⁾
(8 ohms 1 kHz, THD 0.7%)

FRONT²⁾: 80 W/ch

CENTER²⁾: 80 W

SURR²⁾: 80 W/ch

Models of area code AU

Rated Power Output at Stereo Mode
(8 ohms 20 Hz – 20 kHz, THD 0.09%)

50 W + 50 W¹⁾

(8 ohms 1 kHz, THD 0.7%)

80 W + 80 W¹⁾

Reference Power Output¹⁾
(8 ohms 20 Hz – 20 kHz, THD 0.09%)

FRONT²⁾: 50 W/ch

CENTER²⁾: 50 W

SURR²⁾: 50 W/ch

(8 ohms 1 kHz, THD 0.7%)

FRONT²⁾: 80 W/ch

CENTER²⁾: 80 W

SURR²⁾: 80 W/ch

(8 ohms 1 kHz, THD 10%)

FRONT²⁾: 100 W/ch

CENTER²⁾: 100 W

SURR²⁾: 100 W/ch

Models of area code KR

Rated Power Output at Stereo Mode
(8 ohms 1 kHz, THD 0.7%)

80 W + 80 W¹⁾

70 W + 70 W³⁾

(8 ohms 1 kHz, THD 10%)

FRONT²⁾: 100 W/ch

CENTER²⁾: 100 W

SURR²⁾: 100 W/ch

Models of other area code

Rated Power Output at Stereo Mode

(8 ohms 1 kHz, THD 0.7%)

80 W + 80 W¹⁾

Reference Power Output¹⁾

(8 ohms 1 kHz, THD 10%)

FRONT²⁾: 100 W/ch

CENTER²⁾: 100 W

SURR²⁾: 100 W/ch

1) Measured under the following conditions:

Area code	Power requirements
SP, CEL, CEK, KR	230 V AC, 50 Hz
E2/E3, AU	240 V AC, 50 Hz
TW	110 V AC, 60 Hz

2) Depending on the sound field settings and the source, there may be no sound output.

3) Measured under the following conditions:

Area code	Power requirements
KR	220 V AC, 50 Hz

Frequency response

MULTI CH IN, SA-CD/CD, MD/TAPE, DVD, VIDEO 1, 2	10 Hz – 70 kHz +0.5/-2 dB (with sound field and tone bypassed)
---	--

Inputs (Analog)

MULTI CH IN, SA-CD/CD, MD/TAPE, DVD, VIDEO 1, 2	Sensitivity: 500 mV Impedance: 50 kilohms S/N ⁴⁾ : 96 dB (A, 500 mV ³⁾)
---	---

4) INPUT SHORT (with sound field and tone bypassed).

5) Weighted network, input level.

Inputs (Digital)

DVD (Coaxial)	Sensitivity: – Impedance: 75 ohms S/N: 100 dB (A, 20 kHz LPF)
VIDEO 2, SA-CD/CD (Optical)	Sensitivity: – Impedance: – S/N: 100 dB (A, 20 kHz LPF)

Outputs (Analog)

MD/TAPE (OUT), VIDEO 1 (AUDIO OUT)	Voltage: 500 mV Impedance: 10 kilohms
SUB WOOFER	Voltage: 2 V Impedance: 1 kilohms

TONE

Gain levels	±6 dB, 1 dB step
-------------	------------------

FM tuner section

Tuning range	87.5 - 108.0 MHz
Antenna	FM wire antenna
Antenna terminals	75 ohms, unbalanced
Intermediate frequency	10.7 MHz
Sensitivity	
Mono:	18.3 dBf, 2.2 μV/75 ohms
Stereo:	38.3 dBf, 22.5 μV/75 ohms
Useable sensitivity	11.2 dBf, 1 μV/75 ohms
S/N	
Mono:	76 dB
Stereo:	70 dB
Harmonic distortion at 1 kHz	
Mono:	0.3%
Stereo:	0.5%
Separation	45 dB at 1 kHz
Frequency response	30 Hz – 15 kHz, +0.5/-2 dB
Selectivity	60 dB at 400 kHz

AM tuner section

Tuning range	
Models of area code E2/E3	
With 10-kHz tuning scale:	530 – 1,610 kHz ⁶⁾
With 9-kHz tuning scale:	531 – 1,602 kHz ⁶⁾
Models of area code CEL, CEK, SP, AU, TW, KR	
With 9-kHz tuning scale:	531 – 1,602 kHz
Antenna	Loop antenna
Intermediate frequency	450 kHz
Usable sensitivity	50 dB/m (at 1,000 kHz or 999 kHz)
S/N	54 dB (at 50 mV/m)
Harmonic distortion	0.5% (50 mV/m, 400 Hz)
Selectivity	
At 9 kHz:	35 dB
At 10 kHz:	40 dB

- 6) You can change the AM tuning scale to 9 kHz or 10 kHz. After tuning in any AM station, turn off the receiver. While holding down PRESET TUNING + or TUNING +, press I/⏏. All preset stations will be erased when you change the tuning scale. To reset the scale to 10 kHz (or 9 kHz), repeat the procedure.

Video section

Inputs/Outputs	
Video:	1 Vp-p, 75 ohms

General

Power requirements

Area code	Power requirements
CEL, CEK	230 V AC, 50/60 Hz
SP, KR	220 – 230 V AC, 50/60 Hz
E2/E3	120/220/240 V AC, 50/60 Hz
AU	240 V AC, 50 Hz
TW	110 V AC, 50/60 Hz

Power consumption

Area code	Power consumption
CEL, CEK, SP, AU, E2/E3, KR	180 W
TW	440 W

Power consumption (during standby mode)
0.3 W

Dimensions (w/h/d) (Approx.)
430 × 145 × 310.5 mm
including projecting parts
and controls

Mass (Approx.) 7.5 kg

Supplied accessories

FM wire antenna (1)
AM loop antenna (1)
Remote commander RM-U306B (1)
R6 (size-AA) batteries (2)

For details on the area code of the component you are using, see page 3.

Design and specifications are subject to change without notice.

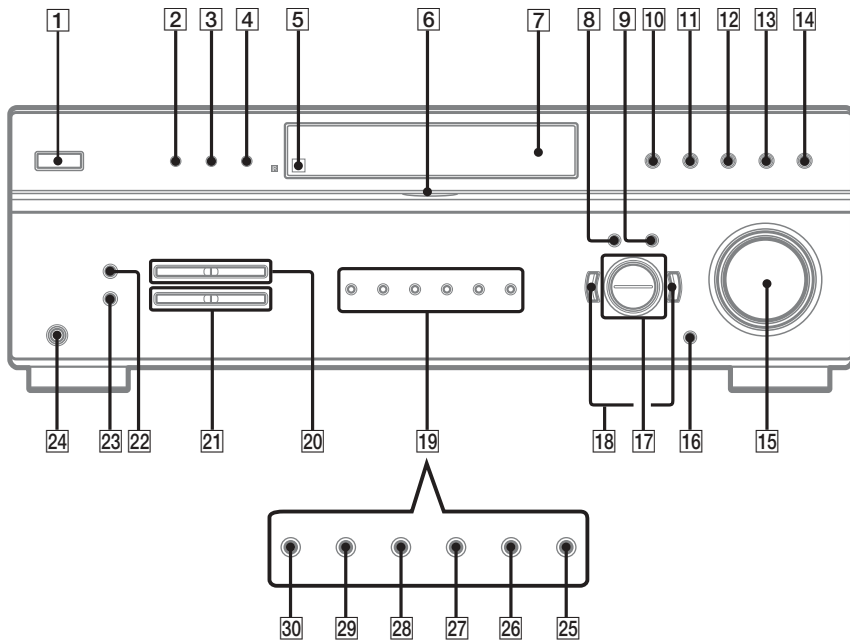

Index

A

- Adjusting
 - CUSTOMIZE parameters 33
 - LEVEL parameters 31
 - SET UP parameters 18
 - speaker levels and balance 20
 - TONE parameters 33
- Automatic tuning 22

C

- Changing
 - display 26
- Clearing receiver's memory 17
- CUSTOMIZE menu 33

D

- Digital Cinema Sound 29
- Direct tuning 22
- Dual Mono 34
- Dubbing. *See* Recording

E

- Editing. *See* Recording

I

- Indexing. *See* Naming

L

- Labeling. *See* Naming
- LEVEL menu 31

N

- Naming 35

P

- Preset stations
 - how to 23
 - how to tune 24

R

- RDS 24
- Recording
 - on a video tape 37
 - on an audio tape or MD 37

S

- Selecting
 - component 21
 - front speaker system 36
 - sound field 29–30
- SET UP menu 18
- Sleep Timer 36
- Sound field
 - customizing 31
 - pre-programmed 29–30
 - resetting 32
 - selecting 29–30
- Speakers
 - adjusting speaker levels and balance 20
 - connection 15
 - placement 15
- Supplied accessories 46

T

- Test tone 20
- TONE menu 33
- Tuning
 - automatically 22
 - directly 22
 - to preset stations 24

Free Manuals Download Website

<http://myh66.com>

<http://usermanuals.us>

<http://www.somanuals.com>

<http://www.4manuals.cc>

<http://www.manual-lib.com>

<http://www.404manual.com>

<http://www.luxmanual.com>

<http://aubethermostatmanual.com>

Golf course search by state

<http://golfingnear.com>

Email search by domain

<http://emailbydomain.com>

Auto manuals search

<http://auto.somanuals.com>

TV manuals search

<http://tv.somanuals.com>