

# ***FM Stereo FM-AM Receiver***

---

Operating Instructions \_\_\_\_\_

**GB**

## **Owner's Record**

The model and serial numbers are located on the rear panel. Record the serial number in the space provided below. Refer to them whenever you call upon your Sony dealer regarding this product.

Model No. STR-DE685

Serial No. \_\_\_\_\_

## ***STR-DE685***

## WARNING

**To prevent fire or shock hazard, do not expose the unit to rain or moisture.**

To prevent fire, do not cover the ventilation of the apparatus with newspapers, table-cloths, curtains, etc. And don't place lighted candles on the apparatus.

To prevent fire or shock hazard, do not place objects filled with liquids, such as vases, on the apparatus.



Don't throw away the battery with general house waste, dispose of it correctly as chemical waste.

Do not install the appliance in a confined space, such as a bookcase or built-in cabinet.

### For customers in the United States

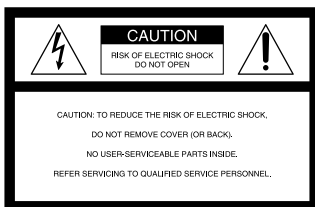

This symbol is intended to alert the user to the presence of uninsulated "dangerous voltage" within the product's enclosure that may be of sufficient magnitude to constitute a risk of electric shock to persons.



This symbol is intended to alert the user to the presence of important operating and maintenance (servicing) instructions in the literature accompanying the appliance.

### WARNING

This equipment has been tested and found to comply with the limits for a Class B digital device, pursuant to Part 15 of the FCC Rules. These limits are designed to provide reasonable protection against harmful interference in a residential installation. This equipment generates, uses, and can radiate radio frequency energy and, if not installed and used in accordance with the instructions, may cause harmful interference to radio communications. However, there is no guarantee that interference will not occur in a particular installation. If this equipment does cause harmful interference to radio or television reception, which can be determined by turning the equipment off and on, the user is encouraged to try to correct the interference by one or more of the following measures:

- Reorient or relocate the receiving antenna.
- Increase the separation between the equipment and receiver.
- Connect the equipment into an outlet on a circuit different from that to which the receiver is connected.
- Consult the dealer or an experienced radio/TV technician for help.

### CAUTION

You are cautioned that any changes or modification not expressly approved in this manual could void your authority to operate this equipment.

### Note to CATV system installer:

This reminder is provided to call CATV system installer's attention to Article 820-40 of the NEC that provides guidelines for proper grounding and, in particular, specifies that the cable ground shall be connected to the grounding system of the building, as close to the point of cable entry as practical.

### For customers in Canada

### CAUTION

**TO PREVENT ELECTRIC SHOCK, DO NOT USE THIS POLARIZED AC PLUG WITH AN EXTENSION CORD, RECEPTACLE OR OTHER OUTLET UNLESS THE BLADES CAN BE FULLY INSERTED TO PREVENT BLADE EXPOSURE.**



ENERGY STAR® is a U.S. registered mark.

As an ENERGY STAR® partner, Sony Corporation has determined that this product meets the ENERGY STAR® guidelines for energy efficiency.

This receiver incorporates Dolby\* Digital and Pro Logic Surround and the DTS\*\* Digital Surround System.

\* Manufactured under license from Dolby Laboratories.

"Dolby", "Pro Logic" and the double-D symbol are trademarks of Dolby Laboratories.

\*\* "DTS" and "DTS Digital Surround" are registered trademarks of Digital Theater Systems, Inc.

# Table of Contents

## List of Button Locations and Reference Pages

Main unit .....	5
-----------------	---

## Hooking Up the Components

Required cords .....	6
Antenna hookups .....	7
Audio component hookups .....	8
Video component hookups .....	9
Digital component hookups .....	10
Multi channel input hookups .....	12
Other hookups .....	13

## Hooking Up and Setting Up the Speaker System

Speaker system hookups .....	15
Performing initial setup operations .....	17
Multi channel surround setup .....	17
Checking the connections .....	22

## Basic Operations

Selecting the component .....	23
Changing the display .....	24

## Enjoying Surround Sound

Automatically decoding the input audio signal .....	25
Selecting a sound field .....	25
Using only the front speakers (2 Channel Stereo) .....	27
Enjoying stereo sound in multi channel (Dolby Pro Logic II) .....	27
Understanding the multi channel surround displays .....	28
Customizing sound fields .....	29

## Receiving Broadcasts

Storing FM stations automatically (AUTOBETICAL) <sup>1)</sup> .....	32
Direct tuning .....	32
Automatic tuning .....	33
Preset tuning .....	33
Using the Radio Data System (RDS) <sup>1)</sup> ....	35

## Other Operations

Naming preset stations and program sources .....	37
Recording .....	37
Using the Sleep Timer .....	38
Adjustments using the SET UP button .....	38
CONTROL A1II control system .....	39

## Operations Using the Remote RM-PP411<sup>2)</sup>

Before you use your remote .....	42
Remote button description .....	42
Selecting the mode of the remote .....	45
Programming the remote .....	46

## Operations Using the Remote RM-U305C<sup>3)</sup>

Before you use your remote .....	49
Remote button description .....	49
Changing the factory setting of a function button .....	52

## Additional Information

Precautions .....	53
Troubleshooting .....	53
Specifications .....	56
Tables of settings using SURR, LEVEL, EQ, and SET UP buttons .....	59
Adjustable parameters for each sound field .....	Back page

<sup>1)</sup> Models of area code CEL, CEK only.

<sup>2)</sup> Models of area code U, CA only.

<sup>3)</sup> Except for models of area code U, CA.

## About This Manual

The instructions in this manual are for model STR-DE685. Check your model number by looking at the lower right corner of the front panel.

### About area codes

The area code of the receiver you purchased is shown on the lower portion of the rear panel (see the illustration below).

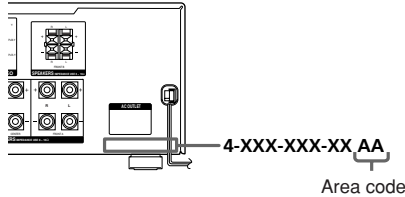

Any differences in operation, according to the area code, are clearly indicated in the text, for example, "Models of area code AA only".

### Tip

The instructions in this manual describe the controls on the receiver. You can also use the controls on the supplied remote if they have the same or similar names as those on the receiver. For details on the use of your remote, see

- pages 42–48 for RM-PP411 (models of area code U, CA only).
- pages 49–52 for RM-U305C (except for models of area code U, CA)

## Note for the supplied remote

### For RM-PP411 (Models of area code U, CA only)

The TV/SAT, PHONO, SOURCE, MPX/DUAL, ANALOG DIRECT, 12 and ON SCREEN buttons on the remote are not available.

### For RM-U305C (Except for models of area code U, CA)

The TV/SAT and PHONO buttons on the remote are not available.

## Demonstration Mode

The demonstration will activate the first time you turn on the power. When the demonstration starts, the following message appears in the display:

"NOW DEMONSTRATION MODE IF YOU FINISH DEMONSTRATION PLEASE PRESS POWER KEY WHILE THIS MESSAGE APPEARS IN THE DISPLAY THANK YOU"

### To cancel the demonstration

Press I/⏻ to turn the receiver off while the above message is being displayed. The next time you turn the receiver on, the demonstration will not appear.

### To view the demonstration

Hold down SET UP and press I/⏻ to turn on the power.

### Notes

- Running the demonstration will clear the receiver's memory. For details on what will be cleared, see "Clearing the receiver's memory" on page 17.
- There will be no sound when the demonstration mode is activated.
- You cannot cancel demonstration if you did not press I/⏻ while the above message is being displayed. To cancel demonstration after the above message appears, press I/⏻ twice to activate the demonstration again. Then, press I/⏻ while the above message is being displayed.

## How to use this page

Use this page to find the location of buttons that are mentioned in the text.

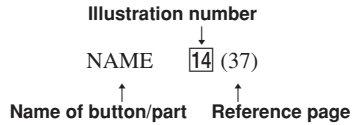

## Main unit

### ALPHABETICAL ORDER

#### 0 - 9

2 CH **31** (27)

#### A - D

A.DEC **33** (25, 27)

AM (Except for models of area code CEL, CEK) **37** (32, 33)

AUX **27** (23)

CD/SACD **23** (23)

CINEMA STUDIO EX A,B,C **16** (26)

Digital Cinema Sound (indicator) **17** (25)

DIMMER **5** (24)

DISPLAY **4** (24, 35, 55)

Display **15** (24)

DVD/LD **26** (23)

#### E - K

ENTER **34** (37)

EQ **9** (31, 59)

EQUALIZER **18** (31)

FM (Except for models of area code CEL, CEK) **38** (32, 33)

FM/AM (Models of area code CEL, CEK only) **37** (32, 33)

FM MODE (Models of area code CEL, CEK only) **38**, (Except for models of area code CEL, CEK) **39** (33)

INPUT MODE **19** (23)

IR (receptor) **6** (42, 49, 55)

Jog dial **36** (18, 29, 31, 37, 38)

#### L - O

LEVEL **12** (18, 22, 29, 59)

MASTER VOLUME **28** (22, 53)

MD/TAPE **21** (23)

MEMORY **41** (32, 34)

MODE **32** (26, 31, 54)

MULTI CHANNEL DECODING (indicator) **11** (23)

MULTI CH IN **30** (23)

MUTING **29** (24, 53)

NAME **14** (37)

#### P - S

PHONES (jack) **3** (24, 54)

PRESET/PTY SELECT +/- (Models of area code CEL, CEK only) **7** (34, 35)

PRESET TUNING +/- (Except for models of area code CEL, CEK) **7** (34, 57)

PTY (Models of area code CEL, CEK only) **39** (35)

SET UP **13** (4, 18, 38, 59)

SHIFT **40** (34)

SPEAKERS A/B **2** (24, 29, 53)

SURR **10** (29, 59)

#### T - Z

TUNER **25** (23, 33, 34, 37)

TUNING +/- **8** (33)

VIDEO 1 **20** (23)

VIDEO 2 **22** (23)

VIDEO 3 **24** (23)

VIDEO 3 INPUT (jacks) **42** (9)

### BUTTON DESCRIPTIONS

I/⏻ (power) **1** (4, 17, 22, 31, 32, 57)

</> **35** (18, 29, 31, 37, 38)

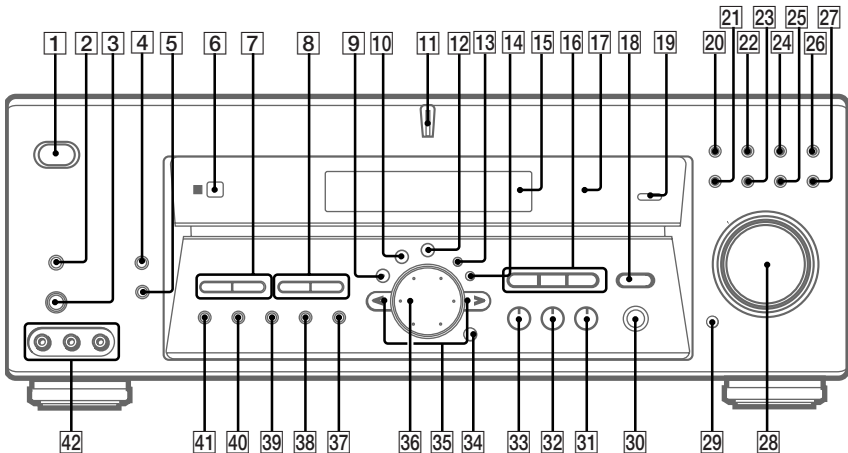

## Required cords

### A Audio cord (not supplied)

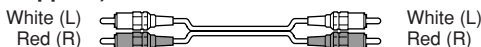

### B Audio/video cord (not supplied)



### C Video cord (not supplied)



### D Optical digital cord (not supplied)



### E Coaxial digital cord (not supplied)

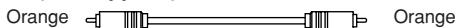

### F Monaural audio cord (not supplied)



### G Monaural mini-plug cord (not supplied)

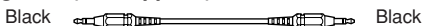

## Before you get started

- Turn off the power to all components before making any connections.
- Do not connect the AC power cord until all of the connections are completed.
- Be sure to make connections firmly to avoid hum and noise.
- When connecting an audio/video cord, be sure to match the color-coded pins to the appropriate jacks on the components: yellow (video) to yellow; white (left, audio) to white; and red (right, audio) to red.
- When you connect optical digital cords, insert the cord plugs straight in until they click into place.
- Do not bend or tie the optical digital cord.

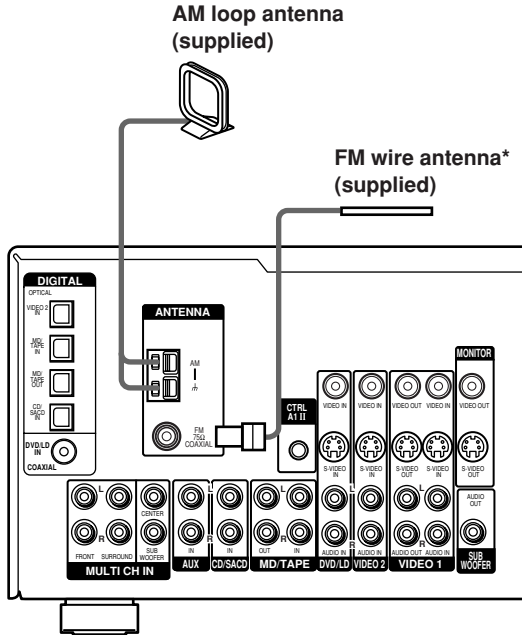

\* The shape of the connector varies depending on the area code.

## Notes on antenna hookups

- To prevent noise pickup, keep the AM loop antenna away from the receiver and other components.
- Be sure to fully extend the FM wire antenna.
- After connecting the FM wire antenna, keep it as horizontal as possible.

# Audio component hookups

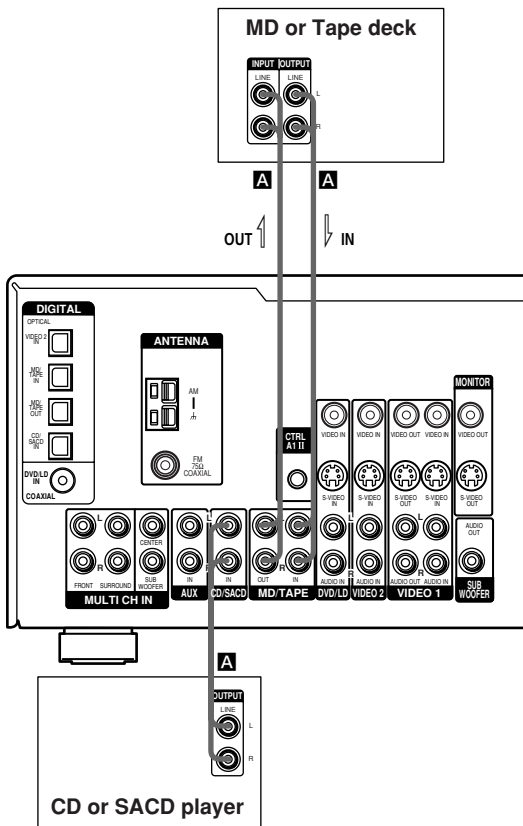



# Video component hookups

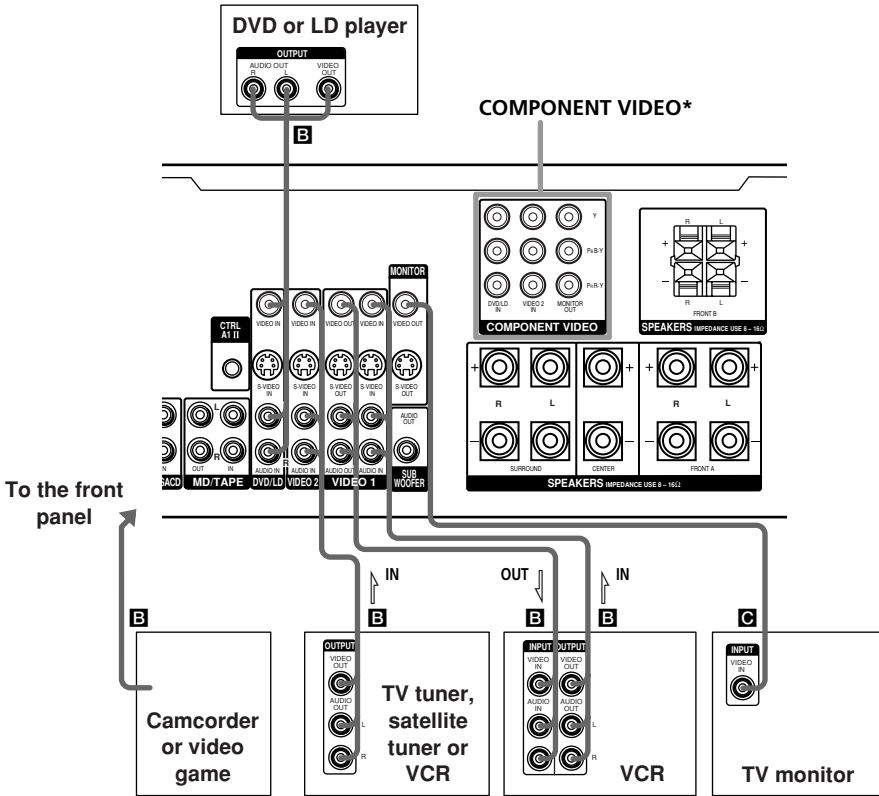

\* Except for models of area code CEL, CEK.

## Note on video component hookups

You can connect your TV's audio output jacks to the VIDEO 2 AUDIO IN jacks on the receiver and apply sound effects to the audio from the TV. In this case, do not connect the TV's video output jack to the VIDEO 2 VIDEO IN jack on the receiver. If you are connecting a separate TV tuner (or satellite tuner), connect both the audio and video output jacks to the receiver as shown above.

If you have a DVD player, TV, satellite tuner or LD player with COMPONENT VIDEO (Y, B-Y, R-Y) output jacks and a monitor with COMPONENT VIDEO input jacks, use a video cord (not supplied) to connect to the receiver.

## Tip

When using the S-video jacks instead of the video jacks, your monitor must also be connected via an S-video jack. S-video signals are on a separate bus from the video signals and will not be output through the video jacks.

## Note

On this receiver, the component video signals are not compatible with S-video signals or video signals.

## Digital component hookups

Connect the digital output jacks of your DVD player and satellite tuner (etc.) to the receiver's digital input jacks. To fully enjoy multi channel surround sound, five speakers (two front speakers, two surround speakers, and a center speaker) and a sub woofer are required. You can also connect an LD player with an RF OUT jack via an RF demodulator, like the Sony MOD-RF1 (not supplied).

### Note

You cannot connect an LD player's DOLBY DIGITAL RF OUT jack directly to this unit's digital input jacks. You must first convert the RF signal to either an optical or coaxial digital signal. For details, see "Troubleshooting" on page 53.

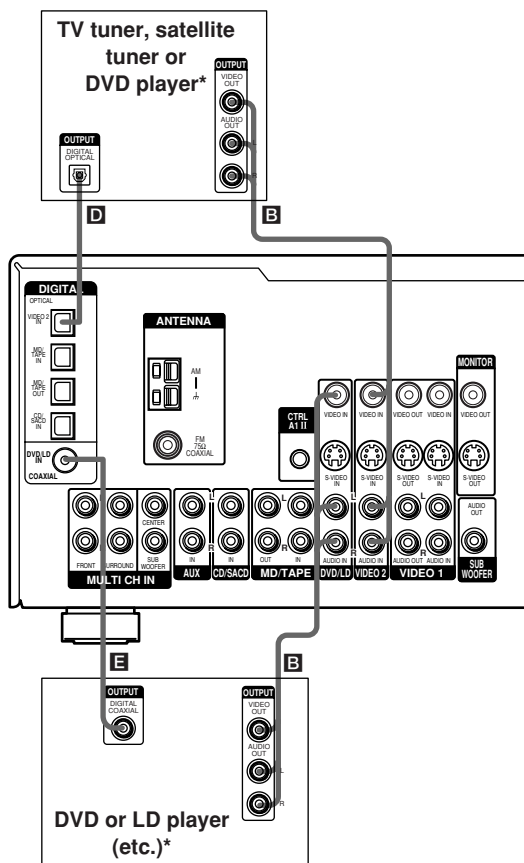

\* Make either coaxial or optical connections. We recommend making coaxial connections instead of optical connections.

Connect the digital output jacks of your MD or tape deck to the receiver's digital input jack and connect the digital input jacks of your MD or tape deck to the receiver's digital output jack. These connections allow you to make digital recordings of TV broadcasts, etc.

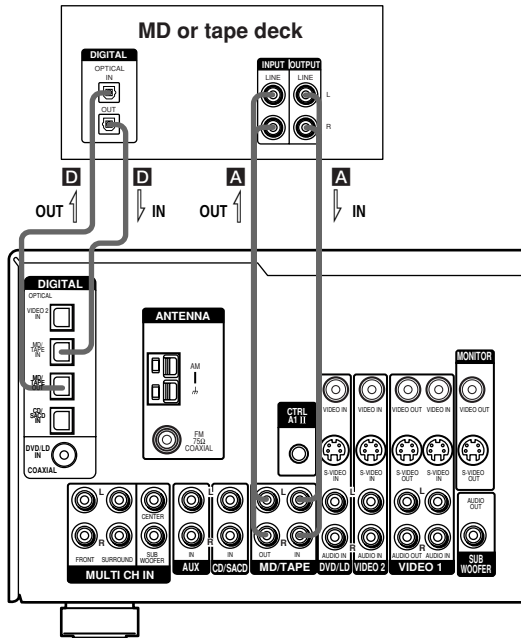

**Notes**

- You cannot make digital recordings when the source is a multi channel digital source.
- All the OPTICAL and COAXIAL jacks are compatible with 96 kHz, 48 kHz, 44.1 kHz and 32 kHz sampling frequencies.
- It is not possible to record analog signals to the components connected to MD/TAPE and VIDEO jacks with only digital connections. To record analog signals, make analog connections. To record digital signals, make digital connections.
- The sound is not output when you play a SACD disc on the SACD player connected to the CD/SACD OPTICAL IN jack on this unit. Connect to the analog input jacks (CD/SACD IN jacks). Refer to the operating instructions supplied with the SACD player.

# Multi channel input hookups

Although this receiver incorporates a multi channel decoder, it is also equipped with multi channel input jacks. These connections allow you to enjoy multi channel software encoded in formats other than Dolby Digital and DTS. If your DVD player is equipped with multi channel output jacks, you can connect them directly to the receiver to enjoy the sound of the DVD player's multi channel decoder. Alternatively, the multi channel input jacks can be used to connect an external multi channel decoder.

To fully enjoy multi channel surround sound, five speakers (two front speakers, two surround speakers, and a center speaker) and a sub woofer are required. Refer to the operating instructions supplied with your DVD player, multi channel decoder, etc., for details on the multi channel hookups.

## Notes

- When using the connections described below, adjust the level of the surround speakers and sub woofer from the DVD player or multi channel decoder.
- See page 15 for details on speaker system hookup.

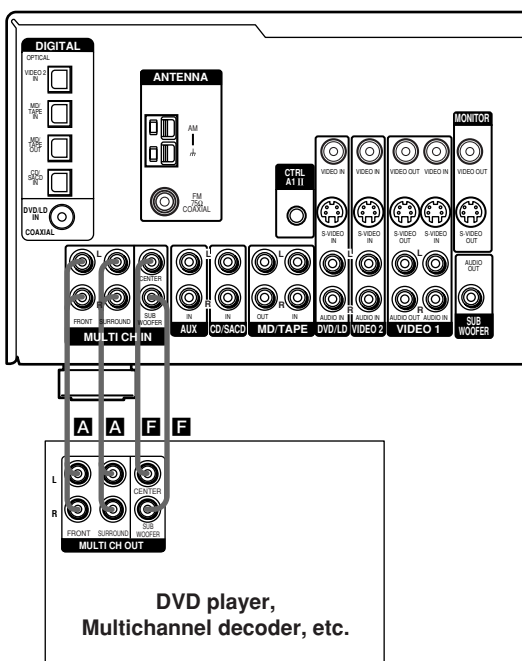

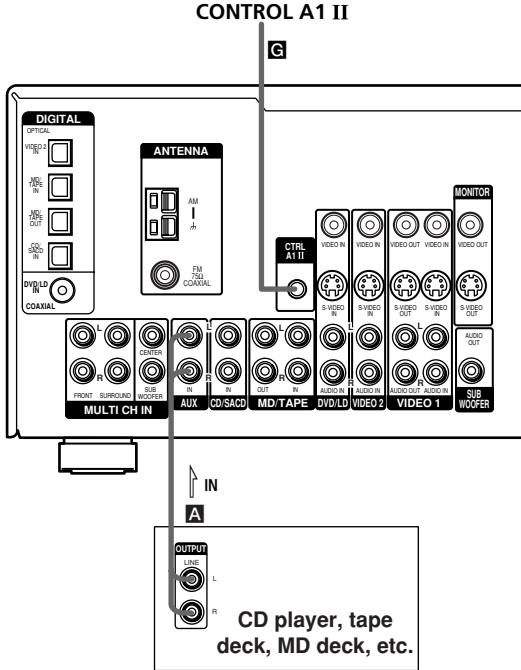

## CONTROL A1 II hookup

- If you have a CONTROL A1 II compatible Sony CD player, SACD player, tape deck, or MD deck

Use a monaural mini-plug cord (not supplied) to connect the CONTROL A1 II jack on the CD player, SACD player, tape deck, or MD deck to the CTRL A1 II jack on the receiver. Refer to “CONTROL A1 II control system” on page 39 and the operating instructions supplied with your CD player, SACD player, tape deck, or MD deck for details.

### Note

If you make CONTROL A1 II connections from the receiver to an MD deck that is also connected to a computer, do not operate the receiver while using the “Sony MD Editor” software. This may cause a malfunction.

- If you have a Sony CD changer with a COMMAND MODE selector

If your CD changer’s COMMAND MODE selector can be set to CD 1, CD 2, or CD 3, be sure to set the command mode to “CD 1” and connect the changer to the CD jacks on the receiver.

However, if you have a Sony CD changer with VIDEO OUT jacks, set the command mode to “CD 2” and connect the changer to the VIDEO 2 jacks on the receiver.

continued

Other hookups (continued)

## AUX AUDIO In hookup

If you have an individual audio component (except PHONO)

Use the audio cords to connect the LINE OUT jacks on the CD player, tape deck or MD deck to the AUX IN jacks on the receiver so that you can listen to stereo sources in surround sound.

## Setting the voltage selector

If your receiver has a voltage selector on the rear panel, check that the voltage selector is set to the local power supply voltage. If not, use a screwdriver to set the selector to the correct position before connecting the AC power cord to a wall outlet.

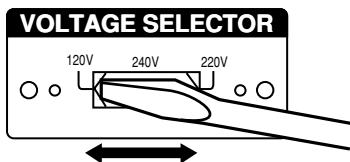

## Connecting the AC power cord

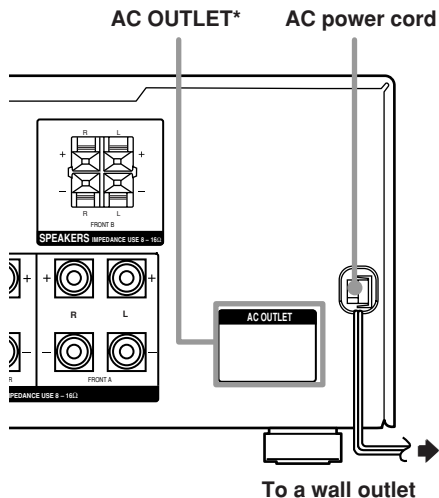

\* Except for models of area code AR

The configuration, shape, and number of AC outlets vary according to the model and country to which the receiver is shipped.

Before connecting the AC power cord of this receiver to a wall outlet, connect the speaker system to the receiver (page 15).

Connect the AC power cord(s) of your audio/video components to a wall outlet.

If you connect other audio/video components to the AC OUTLET(s) on the receiver, the receiver will supply power to the connected component(s), allowing you to turn the whole system on or off when you turn the receiver on or off.

### Caution

Make sure that the total power consumption of the component(s) connected to the receiver's AC OUTLET(s) does not exceed the wattage stated on the rear panel. Do not connect high-wattage electrical home appliances such as electric irons, fans, or TVs to this outlet.

## Speaker system hookups

### Required cords

#### A Speaker cords (not supplied)

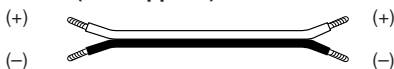

#### B Monaural audio cord (not supplied)

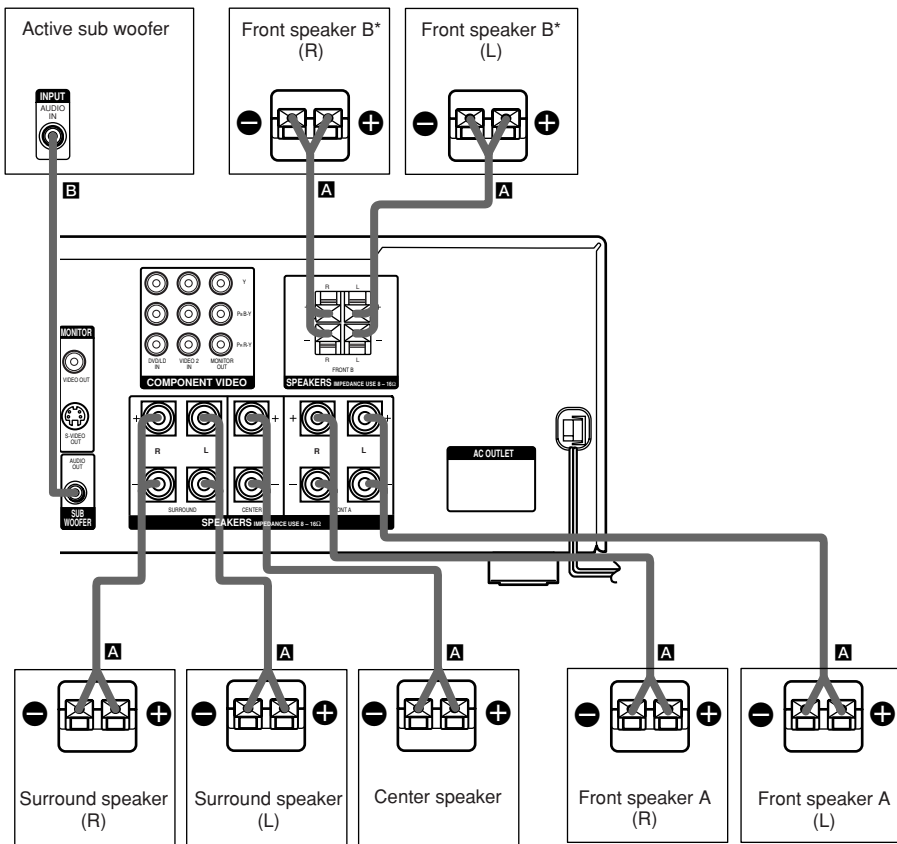
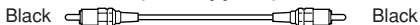

\* If you have an additional front speaker system, connect them to the SPEAKERS FRONT B terminals.

continued

## Speaker system hookups (continued)

### Notes

- Twist the stripped ends of the speaker cords about 10 mm (2/3 inch). Be sure to match the speaker cord to the appropriate terminal on the components: + to + and – to –. If the cords are reversed, the sound will be distorted and will lack bass.
- If you use speakers with low maximum input rating, adjust the volume carefully to avoid excessive output on the speakers.

## To avoid short-circuiting the speakers

Short-circuiting of the speakers may damage the receiver. To prevent this, make sure to take the following precautions when connecting the speakers.

**Make sure the stripped ends of each speaker cord does not touch another speaker terminal, the stripped end of another speaker cord, or the metal parts of the receiver.**

### Examples of poor conditions of the speaker cord

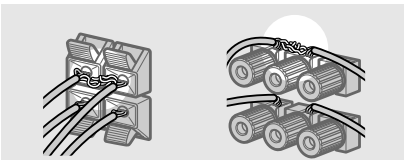

**Stripped speaker cord is touching another speaker terminal.**

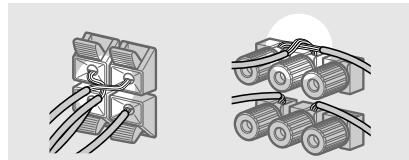

**Stripped cords are touching each other due to excessive removal of insulation.**

**After connecting all the components, speakers, and AC power cord, output a test tone to check that all the speakers are connected correctly. For details on outputting a test tone, see page 22.**

If no sound is heard from a speaker while outputting a test tone or a test tone is output from a speaker other than the one whose name is currently displayed on the receiver, the speaker may be short-circuited. If this happens, check the speaker connection again.

## To avoid damaging your speakers

Make sure that you turn down the volume before you turn off the receiver. When you turn on the receiver, the volume remains at the level you turn off the receiver.



## Performing initial setup operations

Once you have hooked up the speakers and turned on the power, clear the receiver's memory. Then specify the speaker parameters (size, position, etc.) and perform any other initial setup operations necessary for your system.

### Tip

To check the audio output during settings (to set up while outputting the sound), check the connection (page 22).

## Clearing the receiver's memory

Before using your receiver for the first time, or when you want to clear the receiver's memory, do the following.

This procedure is not necessary if the demonstration activates when you turn on the power.

### 1 Turn off the receiver.

### 2 Hold down I/⏻ for 5 seconds.

The demonstration starts (page 4) and all of the following items are reset or cleared:

- All preset stations are reset or cleared.
- All sound field parameters are reset to their factory settings.
- All index names (of preset stations and program sources) are cleared.
- All SET UP parameters are reset to their factory settings.
- The sound field memorized for each program source and preset stations are cleared.
- The master volume is set to VOL MIN.

## Performing initial setup operations

Before using your receiver for the first time, adjust SET UP parameters so that the receiver correspond to your system. For the adjustable parameters, see the table on page 59. See pages 17–22 for speaker settings and pages 38–39 for other settings.

## Multi channel surround setup

For the best possible surround sound, all speakers should be the same distance from the listening position (A).

However, the receiver lets you place the center speaker up to 1.5 meters (5 feet) closer (B) and the surround speakers up to 4.5 meters (15 feet) closer (C) to the listening position.

The front speakers can be placed from 1.0 to 12.0 meters (3 to 40 feet) from the listening position (A).

You can place the surround speakers either behind you or to the side, depending on the shape of your room (etc.).

When placing surround speakers to your side

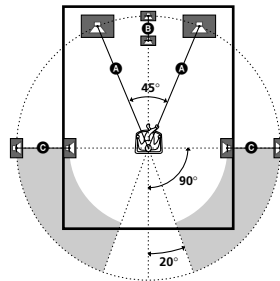

continued

## Multi channel surround setup (continued)

When placing surround speakers behind you

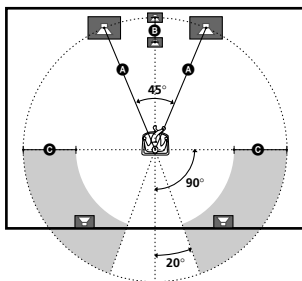

### Note

Do not place the center speaker farther away from the listening position than the front speakers.

## Normal Speaker and Micro Satellite Speaker

If you are using	Select
Normal Speakers	NORM. SP.
Micro Satellite Speakers	MICRO SP.

The speaker size and the sub woofer selection has been preset to NORM. SP. You can adjust the speaker size and sub woofer selection when you select NORM. SP. (pages 18–19)

To select MICRO SP., turn off the power, then turn on again while pressing LEVEL. (To reset to NORM. SP., do the same procedure.)

When you select MICRO SP., the speaker size and sub woofer selection has been configurated as follows:

Speaker	Settings
FRONT	SMALL
CENTER	SMALL
SURROUND	SMALL
SUB WOOFER	YES

You cannot change the configuration if you select MICRO SP.

### Tip

The setting for Micro Satellite Speaker (MICRO SP.) has been programmed to optimize the sound balance. If you use Sony's Micro Satellite Speakers, select MICRO SP.

### Caution

When you use Micro Satellite Speakers and the speaker size is set to "LARGE", you may not obtain the correct soundstage. The speaker may also be damaged at high volume position.

## Specifying the speaker parameters

- 1 Press SET UP.
- 2 Press < or > to select the parameter you want to adjust.
- 3 Turn the jog dial to select the setting you want.  
The setting is entered automatically.
- 4 Repeat steps 2 and 3 until you have set all of the parameters that follow.

### Initial settings

Parameter	Initial setting
[L] [R] (FRONT)	LARGE*
[C] (CENTER)	LARGE*
[SL] [SR] (SURROUND)	LARGE*
[SW] (SUB WOOFER) S.W. XXX	YES*
[L] [R] DIST. XX.X m (ft.)**	5.0 m (16 ft.)**
[C] DIST. XX.X m (ft.)**	5.0 m (16 ft.)**
[SL] [SR] DIST. XX.X m (ft.)**	3.5 m (11 ft.)**
[SL] [SR] PL. XXX	BEHD.
[SL] [SR] HGT. XXX	LOW

\* You can set this parameter only when you select NORM. SP.

\*\* Models of area code U, CA only.

### ■ Front speaker size ( )

- If you connect large speakers that will effectively reproduce bass frequencies, select “LARGE”. Normally, select “LARGE”.
- If the sound is distorted, or you feel a lack of surround effects when using multi channel surround sound, select “SMALL” to activate the bass redirection circuitry and output the front channel bass frequencies from the sub woofer.
- When the front speakers are set to “SMALL”, the center and surround speakers are also automatically set to “SMALL” (unless previously set to “NO”).

### ■ Center speaker size ( )

- If you connect a large speaker that will effectively reproduce bass frequencies, select “LARGE”. Normally, select “LARGE”. However, if the front speakers are set to “SMALL”, you cannot set the center speaker to “LARGE”.
- If the sound is distorted, or you feel a lack of surround effects when using multi channel surround sound, select “SMALL” to activate the bass redirection circuitry and output the center channel bass frequencies from the front speakers (if set to “LARGE”) or sub woofer.\*1
- If you do not connect a center speaker, select “NO”. The sound of the center channel will be output from the front speakers.\*2

### ■ Surround speaker size ( )

- If you connect large speakers that will effectively reproduce bass frequencies, select “LARGE”. Normally, select “LARGE”. However, if the front speakers are set to “SMALL”, you cannot set the surround speakers to “LARGE”.
- If the sound is distorted, or you feel a lack of surround effects when using multi channel surround sound, select “SMALL” to activate the bass redirection circuitry and output the surround channel bass frequencies from the sub woofer or other “LARGE” speakers.
- If you do not connect surround speakers, select “NO”.\*3

#### Tip

\*1–\*3 correspond to the following Dolby Pro Logic modes

- \*1 NORMAL
- \*2 PHANTOM
- \*3 3 STEREO

#### Tip

Internally, the LARGE and SMALL settings for each speaker determine whether or not the internal sound processor will cut the bass signal from that channel. When the bass is cut from a channel, the bass redirection circuitry sends the corresponding bass frequencies to the sub woofer or other “LARGE” speakers.

However, since bass sounds have a certain amount of directionality, it is best not to cut them, if possible. Therefore, even when using small speakers, you can set them to “LARGE” if you want to output the bass frequencies from that speaker. On the other hand, if you are using a large speaker, but prefer not to have bass frequencies output from that speaker, set it to “SMALL”.

If the overall sound level is lower than you prefer, set all speakers to “LARGE”. If there is not enough bass, you can use the equalizer to boost the bass levels. To adjust the equalizer, see page 31.

**continued**

## Multi channel surround setup (continued)

### ■ Sub woofer selection ( S.W. XXX)

- If you connect a sub woofer, select “YES”.
- If you do not connect a sub woofer, select “NO”. This activates the bass redirection circuitry and outputs the LFE signals from other speakers.
- In order to take full advantage of the Dolby Digital bass redirection circuitry, we recommend setting the sub woofer’s cut off frequency as high as possible.

### ■ Front speaker distance ( DIST. XX.X m (ft.))

Set the distance from your listening position to the front speakers ( **A** on page 17).

### ■ Center speaker distance ( DIST. XX.X m (ft.))

Set the distance from your listening position to the center speaker. Center speaker distance should be set from a distance equal to the front speaker distance ( **A** on page 17) to a distance 1.5 meters (5 feet) closer to your listening position ( **B** on page 17).

### ■ Surround speaker distance ( DIST. XX.X m (ft.))

Set the distance from your listening position to the surround speakers. Surround speaker distance should be set from a distance equal to the front speaker distance ( **A** on page 17) to a distance 4.5 meters (15 feet) closer to your listening position ( **C** on page 17).

### Tip

The receiver allows you to input the speaker position in terms of distance. However, it is not possible to set the center speaker further than the front speakers. Also, the center speaker cannot be set more than 1.5 meters (5 feet) closer than the front speakers. Likewise, the surround speakers can not be set farther away from the listening position than the front speakers. And they can be no more than 4.5 meters (15 feet) closer.

This is because incorrect speaker placement is not conducive to enjoy surround sound.

Please note that, setting the speaker distance closer than the actual location of the speakers will cause a delay in the output of the sound from that speaker. In other words, the speaker will sound like it is farther away.

For example, setting the center speaker distance 1~2 m (3~6 feet) closer than the actual speaker position will create a fairly realistic sensation of being “inside” the screen. If you cannot obtain a satisfactory surround effect because the surround speakers are too close, setting the surround speaker distance closer (shorter) than the actual distance will create a larger sound stage.

Adjusting these parameter while listening to the sound often results in much better surround sound. Give it a try!

## ■ Surround speaker position ( PL. XXX)\*

This parameter lets you specify the location of your surround speakers for proper implementation of the Digital Cinema Sound surround modes. Refer to the illustration below.

- Select “SIDE” if the location of your surround speakers corresponds to section **A**.
- Select “MID” if the location of your surround speaker corresponds to section **B**.
- Select “BEHD.” if the location of your surround speakers corresponds to section **C**.

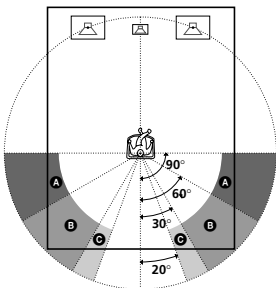



## ■ Surround speaker height ( HGT. XXX)\*

This parameter lets you specify the height of your surround speakers for proper implementation of the Digital Cinema Sound surround modes. Refer to the illustration below.

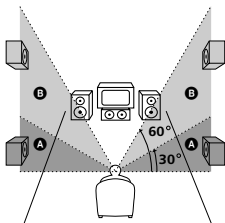
- Select “LOW” if the location of your surround speakers corresponds to section **A**.
- Select “HIGH” if the location of your surround speakers corresponds to section **B**.



\* These parameters are not available when “Surround speaker size (   )” is set to “NO”.

### Tip

The surround speaker position parameter is designed specifically for implementation of the Digital Cinema Sound modes with virtual elements.

With the Digital Cinema Sound modes, speaker position is not as critical as other modes. All modes with virtual elements were designed under the premise that the surround speaker would be located behind the listening position, but presentation remains fairly consistent even with the surround speakers positioned at a rather wide angle. However, if the speakers are pointing towards the listener from the immediate left and right of the listening position, the sound fields with virtual elements will not be effective unless the surround speaker position parameter is set to “PL. SIDE”.

Nevertheless, each listening environment has many variables, like wall reflections, and you may obtain better results using “PL. MID.” and “PL. BEHD.” if your speakers are located high above the listening position, even if they are to the immediate left and right.

Therefore, although it may result in a setting contrary to the “Surround speaker position” explanation, we recommend that you playback multi channel surround encoded software and listen to the effect each setting has on your listening environment. Choose the setting that provides a good sense of spaciousness and that best succeeds in forming a cohesive space between the surround sound from the surround speakers and the sound of the front speakers. If you are not sure which sounds best, select “PL. BEHD.” and then use the speaker distance parameter and speaker level adjustments to obtain proper balance.

continued

## Multi channel surround setup (continued)

### Adjusting the speaker level

Use the remote while seated in your listening position to adjust the level of each speaker.

#### Note

The receiver incorporates a new test tone with a frequency centered at 800 Hz for easier speaker level adjustment.

**1** Press I/⏻ to turn on the receiver.

**2** Press TEST TONE on the remote.

“T. TONE” appears in the display and you will hear the test tone from each speaker in sequence.

**3** Adjust the LEVEL parameters so that the level of the test tone from each speaker sounds the same when you are in your main listening position.

Press LEVEL to adjust the balance and level of speakers. For details on the LEVEL menu, see page 29.

While adjusting, the test tone is output from the speaker whose adjustment is performed.

**4** Press TEST TONE again to turn off the test tone.

#### Tip

You can adjust the level of all speakers at the same time. Turn MASTER VOLUME on the main unit or press MASTER VOL +/- on the remote.

#### Notes

- The test tone cannot be output when the receiver is set to MULTI CH IN.
- The adjusted value are shown in the display during adjustment.
- Although these adjustments can also be made via the front panel using the LEVEL menu (when the test tone is output, the receiver switches to the LEVEL menu automatically), we recommend you follow the procedure described above and adjust the speaker levels from your listening position using the remote.

## Checking the connections

After connecting all of your components to the receiver, do the following to verify that the connections were made correctly.

**1** Press I/⏻ to turn on the receiver.

**2** Turn on the component that you connected (e.g., CD player or tape deck).

**3** Press the function button to select the component (program source).

**4** Start playing.

If you do not obtain normal sound output after performing this procedure, see “Troubleshooting” on page 53 and take the appropriate measures to correct the problem.

## Selecting the component

### Function buttons

Press the function button to select the component you want to use.

To select	Press
VCR	VIDEO 1 or VIDEO 2
TV or satellite tuner	VIDEO 2
Camcorder or video game	VIDEO 3
DVD or LD player	DVD/LD
MD or Tape deck	MD/TAPE
CD or SACD player	CD/SACD
Built in tuner	TUNER
An audio component	AUX

After turning on the component you selected, select the component and play the program source.

- After selecting VCR, camcorder, video game, DVD player, or LD player, turn on the TV and set the TV's video input to match the component you selected.

### INPUT MODE

Press INPUT MODE to select the input mode for your digital components. Each time you press the button, the input mode of the currently selected component switches.

Select	To
AUTO IN	Give priority to digital signals when there are both digital and analog connections. If there are no digital signals, analog is selected.
COAX IN	Specify the digital audio signals input to the DIGITAL COAXIAL input jacks.
OPT IN	Specify the digital audio signals input to the DIGITAL OPTICAL input jacks.
ANALOG	Specify the analog audio signals input to the AUDIO IN (L/R) jacks.

#### Note

When the 96 kHz digital signal is input, the equalizer and surround effects are turned off.

### MULTI CH IN

Press MULTI CH IN to enjoy the audio source connected to the MULTI CH IN jacks. You can adjust balance and level of all the speakers. When this function is on, the equalizer and surround effects are turned off.

### MULTI CHANNEL DECODING indicator

This indicator lights up when the unit is decoding signals recorded in a multi channel format.

continued

## SPEAKERS A/B

Press SPEAKERS A/B button to output the sound from the speakers connected to the SPEAKERS FRONT terminals.

Each time you press the button, the display changes cyclically as follows:

SP. A → SP. B → SP. OFF

To drive	Select
Speaker System A (Connected to the SPEAKERS FRONT A terminals)	SP. A
Speaker System B (Connected to the SPEAKERS FRONT B terminals)	SP. B

When you select “SP. OFF”, no sound will be output from your speakers and “SP. OFF” lights up in the display.

## MUTING

Press MUTING to mute the sound. The muting function is canceled when you turn the power on or turn the MASTER VOLUME clockwise to turn the volume up.

## PHONES

Use to connect headphones.

- When the headphones are connected, speaker output is automatically canceled and “SP. OFF” lights up in the display.

## Changing the display

### DISPLAY

Each time you press DISPLAY, the display changes cyclically as follows:

Index name of the component\* → Selected component → Sound field applied to the program source

#### When the tuner is selected

Index name of the preset station\* or program station name\*\* → Frequency → Program type indication\*\* → Radio text\*\* → Current time\*\* → Sound field applied to the band or the preset station

\* Index name appears only when you have assigned one to the component or preset station (page 37). Index name does not appear when only blank spaces have been entered, or it is the same as the function.

\*\* During RDS reception only. (Models of area code CEL, CEK only. See page 35).

### DIMMER

Press DIMMER repeatedly to adjust the brightness of the display (3 steps). However, when you press any button, the display becomes the brightest setting temporary.



You can take advantage of surround sound simply by selecting one of the receiver's pre-programmed sound fields. They bring the exciting and powerful sound of movie theaters and concert halls into your home. You can also customize the sound fields to obtain the sound you want by changing the surround parameter. To fully enjoy surround sound, you must register the number and location of your speakers. See "Multi channel surround setup" starting from page 17 to set the speaker parameters before enjoying surround sound.

### Automatically decoding the input audio signal

#### Press A.DEC.

"AUTO DEC." appears in the display.

This mode automatically detects the type of audio signal being input (Dolby Digital, DTS, or standard 2 channel stereo) and performs the proper decoding if necessary. This mode presents the sound as it was recorded/encoded, without adding any effects (e.g. reverberation).

However, if there are no low frequency signals (Dolby Digital LFE, etc.) it will generate a low frequency signal for output to the sub woofer.

## Selecting a sound field

You can enjoy surround sound simply by selecting one of the pre-programmed sound fields according to the program you want to listen to.

Sound field	Display
Normal Surround	NORM.SURR.
Cinema Studio EX A	C.ST.EX A <b>DCS</b>
Cinema Studio EX B	C.ST.EX B <b>DCS</b>
Cinema Studio EX C	C.ST.EX C <b>DCS</b>
Hall	HALL
Jazz Club	JAZZ
Live Concert	CONCERT
Game	GAME

#### About DCS (Digital Cinema Sound)

The sound fields with **DCS** mark use DCS technology. When these sound fields are selected, "Digital Cinema Sound" indicator in the display lights up.

In collaboration with Sony Pictures Entertainment, Sony measured the sound environment of their studios and integrated the data of the measurement and Sony's own DSP (Digital Signal Processor) technology to develop "Digital Cinema Sound". In a home theater, "Digital Cinema Sound" simulates an ideal movie theater sound environment based on the preference of the movie director.

### Enjoying movies with Cinema Studio EX

Cinema Studio EX is ideal for enjoying the movie software encoded with multi channel format, such as the Dolby Digital DVD. This mode reproduces the sound characteristics of Sony Pictures Entertainment's studios.

continued

## Selecting a sound field (continued)

### Press CINEMA STUDIO EX A, B or C.

The selected sound field is indicated in the display.

#### ■ C.ST.EX A (Cinema Studio EX A)

Reproduces the sound characteristics of the Sony Pictures Entertainment “Cary Grant Theater” cinema production studio. This is a standard mode, great for watching most any type of movie.

#### ■ C.ST.EX B (Cinema Studio EX B)

Reproduces the sound characteristics of the Sony Pictures Entertainment “Kim Novak Theater” cinema production studio. This mode is ideal for watching science-fiction or action movies with lots of sound effects.

#### ■ C.ST.EX C (Cinema Studio EX C)

Reproduces the sound characteristics of the Sony Pictures Entertainment scoring stage. This mode is ideal for watching musicals or classic films where music is featured in the soundtrack.

### About Cinema Studio EX

Cinema Studio EX consists of the following three elements.

- Virtual Multi Dimension  
Creates 5 sets of virtual speakers surrounding the listener from a single pair of actual surround speakers.
- Screen Depth Matching  
In a movie theater, sound seems to come from inside the image reflected on the movie screen. This element creates the same sensation in your listening room by shifting the sound of the front speakers “into” the screen.
- Cinema Studio Reverberation  
Reproduces the reverberations peculiar to a movie theater.

Cinema Studio EX is the integrated mode which operates these elements simultaneously.

### Tip

You can select Cinema Studio EX by pressing MODE repeatedly.

### Notes

- The effects provided by the virtual speakers may cause increased noise in the playback signal.
- When listening with sound fields that employ the virtual speakers, you will not be able to hear any sound coming directly from the surround speakers.

## Selecting other sound fields

### Press MODE repeatedly to select the sound field you want.

The current sound field is indicated in the display.

#### ■ NORM.SURR. (Normal Surround)

Software with multi channel surround audio signals is played back according to the way it was recorded. Software with 2 channel audio signals is decoded with Dolby Pro Logic to create surround effects.

#### ■ HALL

Reproduces the acoustics of a rectangular concert hall.

#### ■ JAZZ (Jazz Club)

Reproduces the acoustics of a jazz club.

#### ■ CONCERT (Live Concert)

Reproduces the acoustics of a 300-seat live concert.

#### ■ GAME

Obtains maximum audio impact from video game software.

### To turn the surround effect off

Press A,DEC or 2CH.

**Tips**

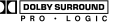
- The receiver lets you apply the last selected sound field to a program source whenever it is selected (Sound Field Link). For example, if you listen to CD with “JAZZ” as the sound field, change to a different program source, then return to CD, “JAZZ” will be applied again.
- You can identify the encoding format of program software by looking at its packaging.  
Dolby Digital discs are labeled with the  logo, and Dolby Surround encoded programs are labeled with the  logo.
- When sound signals with a sampling frequency of 96 kHz are input, the sound signals are output in stereo automatically, and the sound field is turned off.

## Using only the front speakers (2 Channel Stereo)

**Press 2CH.**

“2CH ST.” appears in the display.

This mode outputs the sound from the front left and right speakers only. Standard 2 channel (stereo) sources completely bypass the sound field processing. Multi channel surround formats are downmixed to 2 channel.

**Notes**

- No sound is output from the sub woofer when “2CH ST.” is selected. To listen to 2 channel (stereo) sources using the front left and right speakers and a sub woofer, press A.DEC to select “AUTO DEC.”
- When you select “Micro Satellite Speaker” (page 18), internal sound processor will automatically redirect bass sound to sub woofer. If you want to listen to two channel (stereo) sources under this setting, we recommend that you choose “AUTO DEC.” mode so that you can take advantage of your sub woofer to obtain the correct bass signal.

## Enjoying stereo sound in multi channel (Dolby Pro Logic II)

The receiver can reproduce the stereo sound in multi channel through Dolby Pro Logic II. You can activate the decoder using the SET UP menu. For details, see page 38.

# Understanding the multi channel surround displays

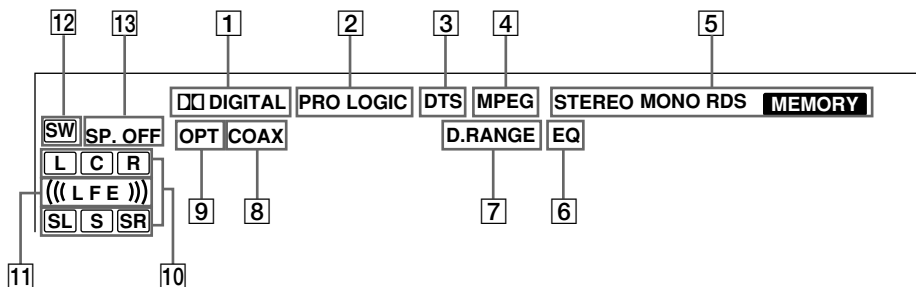

**1** **DIGITAL**: Lights up when the receiver is decoding signals recorded in the Dolby Digital format.

**2** **PRO LOGIC**: Lights up when the receiver applies Pro Logic processing to 2 channel signals in order to output the center and surround channel signals. However, this indicator does not light if the center and surround speakers are set to “NO”, and “AUTO DEC.” or “NORM.SURR.” is selected.

**Note**

Pro Logic decoding does not function for MPEG format signals.

**3** **DTS**: Lights up when DTS signals are input.

**Note**

When playing a DTS format disc, be sure that you have made digital connections and that INPUT MODE is NOT set to “ANALOG” (page 23).

**4** **MPEG**: Lights up when MPEG signals are input.

**Note**

Only the front 2 channels are compatible with MPEG format. Multi channel surround sound is downmixed and output from the front 2 channels.

**5** **Tuner indicators**: Lights up when using the receiver to tune in radio stations, etc. See pages 32–36 for tuner operations.

**Note**

“RDS” only appears for models of area code CEL, CEK only.

**6** **EQ**: Lights up when the equalizer functions.

**7** **D.RANGE**: Lights up when dynamic range compression is activated. See page 30 to adjust the dynamic range compression.

**8** **COAX**: Lights up when the source signal is a digital signal being input through the COAXIAL terminal.

**9** **OPT**: Lights up when the source signal is a digital signal being input through the OPTICAL terminal.

**10** **Playback channel indicators**: The letters (L, C, R, etc.) indicate the channels being played back. The boxes around the letters vary to show how the receiver downmixes the source sound (based on the speakers settings). When using sound fields like “C.ST.EX”, the receiver adds reverberation based on the source sound.

L (Front Left), R (Front Right), C (Center (monaural)), SL (Surround Left), SR (Surround Right), S (Surround (monaural) or the surround components obtained by Pro Logic processing))

**Example:**

Recording format (Front /Surround): 3/2  
Output channel: Surround speakers absent  
Sound Field: AUTO DEC.

**L** **C** **R**

**SL** **SR**

- 11 **(( L F E ))**: Lights up when the disc being played back contains the LFE (Low Frequency Effect) channel and when the sound of the LFE channel signal is actually being reproduced.
- 12 **SW**: Lights up when sub woofer selection is set to “YES” (page 20) and the audio signal is output from the SUB WOOFER jacks.
- 13 **SP. OFF**: Lights up when headphones are inserted or the SPEAKERS A/B button is set to “SP. OFF”.

## Customizing sound fields

By adjusting the surround parameters and the equalization of the front speakers, you can customize the sound fields to suit your particular listening situation.

Once you customize a sound field, the changes are stored in the memory indefinitely. You can change a customized sound field any time by making new adjustments to the parameters.

See the tables on back page for the parameters available in each sound field.

### To get the most from multi channel surround sound

Position your speakers and do the procedures described in “Multi channel surround setup” starting from page 17 before you customize a sound field.

### Adjusting the surround parameter

The SURR menu contains parameter that let you customize various aspects of the current sound field. The settings are stored individually for each sound field.

- 1 **Start playing a program source encoded with multi channel surround sound.**

### 2 Press SURR.

The button lights up and the first parameter is displayed.

### 3 Turn the jog dial to select the setting you want.

The setting is entered automatically.

#### Initial settings

Parameter	Initial setting
EFFECT	(depends on the sound field)

### Effect level (EFFECT)

Lets you adjust the “presence” of the current surround effect.

### Adjusting the level parameters

The LEVEL menu contains parameters that let you adjust the balance and volumes of each speaker. The settings are applied to all sound fields.

- 1 **Start playing a program source encoded with multi channel surround sound.**

### 2 Press LEVEL.

The button lights up and the first parameter is displayed.

- 3 **Press < or > to select the parameter you want to adjust.**



### 4 Turn the jog dial to select the setting you want.

The setting is entered automatically.

continued

## Customizing sound fields (continued)

### Initial settings

Parameter	Initial setting
  BAL. L/R XXX*	BALANCE
CTR XXX dB*	0 dB
SUR.L. XXX dB*	0 dB
SUR.R. XXX dB*	0 dB
S.W. XXX dB*	0 dB
L.F.E. XXX dB	0 dB
 COMP. XXX	OFF

\* The parameters can be adjusted separately for MULTI CH IN.

### Front balance ( BAL. L/R XXX)

Lets you adjust the balance between front left and right speakers.

### Center level (CTR XXX dB)

Lets you adjust the level of the center speaker.

### Surround left level (SUR.L. XXX dB)

Lets you adjust the level of the surround left speaker.

### Surround right level (SUR.R. XXX dB)

Lets you adjust the level of the surround right speaker.

### Sub woofer level (S.W. XXX dB)

Lets you adjust the level of the sub woofer.

### LFE (Low Frequency Effect) mix level (L.F.E. XXX dB)

Lets you attenuate the level of the LFE (Low Frequency Effect) channel output from the sub woofer without effecting the level of the bass frequencies sent to the sub woofer from the front, center or surround channels via the Dolby Digital or DTS bass redirection circuitry.

- For LFE mix level, “0 dB” outputs the full LFE signal at the mix level determined by the recording engineer.
- To mute the sound of the LFE channel from the sub woofer, select “OFF”. However, the low frequency sounds of the front, center, or surround speakers are output from the sub woofer according to the settings made for each speaker in the speaker setup (pages 17–21).

### Dynamic range compressor ( COMP. XXX)

Lets you compress the dynamic range of the sound track. This may be useful when you want to watch movies at low volumes late at night. We recommend using the “MAX” setting.

- To reproduce the sound track with no compression, select “OFF”.
- To reproduce the sound track with the dynamic range intended by the recording engineer, select “STD”.
- To compress the dynamic range in small steps to achieve the sound you desire, select “0.1”–“0.9”.
- To reproduce a dramatic compression of the dynamic range, select “MAX”.

### Note

Dynamic range compression is possible with Dolby Digital sources only.

## Adjusting the equalizer

The EQ menu lets you adjust the equalization of the front speakers. The settings are stored individually for each sound field.

**1 Start playing a program source encoded with multi channel surround sound.**

**2 Press EQ.**

The button lights up and the first parameter is displayed.

**3 Press < or > to select the parameter (gain (dB)) you want to adjust.**

**4 Turn the jog dial to select the setting you want.**

The setting is entered automatically.

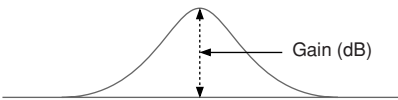

### To turn on/off the equalizer

Press EQUALIZER. The EQ indicator in the display lights up when the equalizer is turned on. When you adjust the equalizer using the EQ parameters, the settings are stored separately for each sound field and can be reproduced whenever you turn on the equalizer.

### Front speaker bass adjustment (Gain)

Lets you adjust the gain of bass.

### Front speaker treble adjustment (Gain)

Lets you adjust the gain of treble.

## Resetting customized sound fields to the factory settings

**1 If the power is on, press I/⏻ to turn off the power.**

**2 Hold down MODE and press I/⏻.**

“SF. CLR.” appears in the display and all sound fields are reset at once.

Before receiving broadcasts, make sure you have connected FM and AM antennas to the receiver (page 7).

### Storing FM stations automatically (AUTOBETICAL)

#### (Models of area code CEL, CEK only)

This function lets you store up to 30 FM and FM RDS stations in alphabetical order without redundancy. Additionally, it only stores the stations with the clearest signals.

If you want to store FM or AM stations one by one, see “Presetting radio stations” on page 34.

**1** Press I/⏻ to turn off the receiver.

**2** Hold down MEMORY and press I/⏻ to turn the receiver back on.

“AUTO-BETICAL SELECT” appears in the display and the receiver scans and stores all the FM and FM RDS stations in the broadcast area.

For RDS stations, the tuner first checks for stations broadcasting the same program, then stores only the one with the clearest signal. The selected RDS stations are sorted alphabetically by their Program Service name, then assigned a 2-character preset code. For more details on RDS, see page 35.

Regular FM stations are assigned 2-character preset codes and stored after the RDS station.

When done, “FINISH” appears in the display momentarily and the receiver returns to the normal operation.

#### Notes

- Do not press any button on the receiver or supplied remote during autobetrical operation.
- If you move to another area, repeat this procedure to store stations in your new area.
- For details on tuning the stored stations, see page 34.
- If you move the antenna after storing stations with this procedure, the stored settings may no longer be valid. If this happens, repeat this procedure to store the stations again.

### Direct tuning

You can enter a frequency of the station you want directly by using the numeric buttons on the supplied remote. For details on the buttons used in this section, see pages 42–48 for remote RM-PP411 and pages 49–52 for remote RM-U305C.

**1** Press TUNER on the remote.

The last received station is tuned in.

**2** Press FM\* or AM\* to select the FM or AM band.

**3** Press D. TUNING on the remote.

**4** Press the numeric buttons to enter the frequency.

Example 1: FM 102.50 MHz

① → ② → ⑤ → ①

Example 2: AM 1350 kHz

(You don't have to enter the last “0” when the tuning scale is set to 10 kHz.)

① → ③ → ⑤ → ①

**If you cannot tune in a station and the entered numbers flash**

Make sure you've entered the right frequency. If not, repeat steps 3 and 4.

If the entered numbers still flash, the frequency is not used in your area.

\* For models of area code CEL, CEK: FM/AM.



**5** If you've tuned in an AM station, adjust the direction of the AM loop antenna for optimum reception.

**6** Repeat steps 2 to 5 to receive another station.

#### Tips

- If you do not remember the precise frequency, press TUNING + or TUNING – after entering the value close to the frequency you want. The receiver automatically tunes in the station you want. If the frequency seems to be higher than the entered value, press TUNING +, and if the frequency seems to be lower than the entered value, press TUNING –.
- If “STEREO” flashes in the display and the FM stereo reception is poor, press FM MODE to change to monaural (MONO). You will not be able to enjoy the stereo effect, but the sound will be less distorted. To return to stereo mode, press FM MODE again.

The tuning scale differs depending on the area code as shown in the following table. For details on area codes, see page 4.

Area code	FM	AM
U, CA	100 kHz	10 kHz*
AU, SP, CEL, CEK, TW	50 kHz	9 kHz
E2/E3, AR, MX	50 kHz	9 kHz*

\* The AM tuning scale can be changed (page 57).

## Automatic tuning

If you don't know the frequency of the station you want, you can let the receiver scan all available stations in your area.

### 1 Press TUNER.

The last received station is tuned in.

### 2 Press FM\*\* or AM\*\* to select the FM or AM band.

### 3 Press TUNING + or TUNING –.

Press TUNING + to scan from low to high; press TUNING – to scan from high to low. The receiver stops scanning whenever a station is received.

#### When the receiver reaches either end of the band

Scanning is repeated in the same direction.

### 4 To continue scanning, press TUNING + or TUNING – again.

\*\* For models of area code CEL, CEK: FM/AM.

## Preset tuning

After you have tuned in stations using Direct Tuning or Automatic Tuning, you can preset them to the receiver. Then you can tune in any of the stations directly by entering its 2-character preset code using the supplied remote. Up to 30 FM or AM stations can be preset. The receiver will also scan all the stations that you have preset.

Before tuning to preset stations, be sure to preset them by performing steps on “Presetting radio stations” (page 34).

continued

## Preset tuning (continued)

### Presetting radio stations

#### 1 Press TUNER.

The last received station is tuned in.

#### 2 Tune in the station that you want to preset using Direct Tuning (page 32) or Automatic Tuning (page 33).

#### 3 Press MEMORY.

“MEMORY” appears in the display for a few seconds.

Do steps 4 to 6 before “MEMORY” goes out.

#### 4 Press SHIFT to select a memory page (A, B or C).

Each time you press SHIFT, the letter “A”, “B”, or “C” appears in the display.

#### 5 Press PRESET TUNING +\* or PRESET TUNING -\* to select a preset number.

If “MEMORY” goes out before you press the preset number, start again from step 3.

#### 6 Press MEMORY again to store the station.

If “MEMORY” goes out before you can store the station, start again from step 3.

#### 7 Repeat steps 2 to 6 to preset another station.

\* For models of area code CEL, CEK: PRESET/PTY SELECT + or PRESET/PTY SELECT -.

### To change a preset number to another station

Do steps 1 to 6 to preset a new station to the number.

## Tuning to preset stations

You can tune the preset stations by either of the following two ways.

### Scanning the preset stations

#### 1 Press TUNER.

The last received station is tuned in.

#### 2 Press PRESET TUNING +\* or PRESET TUNING -\* repeatedly to select the preset station you want.

Each time you press the button, the receiver tunes in one preset station at a time, in the corresponding order and direction as follows:

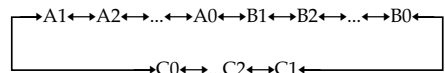

\* For models of area code CEL, CEK: PRESET/PTY SELECT + or PRESET/PTY SELECT -.

### Using the preset codes

Use the supplied remote to perform the following operations. For details on the buttons used in this section, see pages 42–48 for remote RM-PP411 and pages 49–52 for remote RM-U305C.

#### 1 Press TUNER on the remote.

The last received station is tuned in.

#### 2 Press SHIFT to select a memory page (A, B, or C), then press the preset number of the station you want using the numeric buttons.

# Using the Radio Data System (RDS)

## (Models of area code CEL, CEK only)

This receiver also allows you to use RDS (Radio Data System), which enables radio stations to send additional information along with the regular program signal. You can use the following convenient RDS features:

- Displaying RDS information
- Scanning preset stations by program type

Note that RDS is operable only for FM stations.\*

\* Not all FM stations provide RDS service, nor do they provide the same types of services. If you are not familiar with the RDS services in your area, check with your local radio stations for details.

## Receiving RDS broadcasts

Simply select a station on the FM band using direct tuning (page 32), automatic tuning (page 33), or preset tuning (page 33).

When you tune in a station that provides RDS services, the RDS indicator lights up and the program station name normally appears in the display.

### Note

RDS may not work properly if the station you tuned to is not transmitting the RDS signal properly or if the signal strength is weak.

## Displaying RDS information

While receiving an RDS station, press **DISPLAY**.

Each time you press the button, RDS information on the display changes cyclically as follows:

Program Station name → Frequency →  
Program Type indication<sup>a)</sup> →  
Radio Text indication<sup>b)</sup> → Current Time  
indication (in 24-hour system) → Sound field  
currently applied

a) Type of program being broadcast (page 36).

b) Text messages sent by the RDS station.

### Notes

- If there is an emergency announcement by government authorities, “ALARM” flashes in the display.
- When the message consists of 9 characters or more, the message scrolls across the display.
- If a station does not provide a particular RDS service, “NO XXX” (such as “NO PTY”) appears in the display.

## Scanning preset stations by program type

You can tune in preset stations according to a program type that you specify. The receiver scans for stations in its preset memory currently broadcasting the specified program type.

### 1 Press PTY.

### 2 Press PRESET/PTY SELECT + or PRESET/PTY SELECT – to select the program type.

See the table below for the information on each program type.

### 3 Press PTY.

While the receiver is scanning stations, “SEARCH” and the programme type are displayed alternately.

When the receiver finds a station, the receiver stops scanning. When the receiver could not find any preset stations currently broadcasting the specified program type, “NO PTY” appears in the display.

continued

## Preset tuning (continued)

### Description of program types

Program type indication	Description
NEWS	News programs
AFFAIRS	Topical programs that expand on current news
INFO	Programs offering information on a wide spectrum of subjects, including consumer affairs and medical advice
SPORT	Sports programs
EDUCATE	Educational programs, such as “how-to” and advice programs
DRAMA	Radio plays and serials
CULTURE	Programs about national or regional culture, such as language and social concerns
SCIENCE	Programs about the natural sciences and technology
VARIED	Other types of programs such as celebrity interviews, panel games, and comedy
POP M	Popular music programs
ROCK M	Rock music programs
EASY M	Easy Listening
LIGHT M	Instrumental, vocal, and choral music
CLASSICS	Performances of major orchestras, chamber music, opera, etc.
OTHER M	Music that does not fit into any categories above, such as Rhythm & Blues and Reggae
WEATHER	Weather information
FINANCE	Stock market reports and trading, etc.
CHILDREN	Programs for children
SOCIAL	Programs about people and the things that affect them
RELIGION	Programs of religious content
PHONE IN	Programs where members of the public express their views by phone or in a public forum

Program type indication	Description
TRAVEL	Programs about travel. Not for announcements that are located by TP/TA
LEISURE	Programs on recreational activities such as gardening, fishing, cooking, etc.
JAZZ	Jazz programs
COUNTRY	Country music programs
NATION M	Programs featuring the popular music of the country or region
OLDIES	Programs featuring oldies music
FOLK M	Folk music programs
DOCUMENT	Investigative features
NONE	Any programs not defined above

## Naming preset stations and program sources

You can enter a name (index name) of up to 8 characters for preset stations and program sources. These names (for example, "VHS") appear in the receiver's display when a station or program source is selected. Note that no more than one name can be entered for each preset station or program source.

This function is useful for distinguishing components of the same kind. For example, two VCRs can be specified as "VHS" and "8MM", respectively. It is also handy for identifying components connected to jacks meant for another type of component, for example, a second CD player connected to the MD/TAPE jacks.

### 1 To name a preset station

Press **TUNER**, then tune in the preset station you want to create an index name for.

The last station you received is tuned in. If you are not familiar with how to tune in preset stations, see "Tuning to preset stations" on page 34.

### To name a program source

Select the program source (component) to be named.

### 2 Press NAME.

### 3 Create an index name by using the jog dial and < or >:

Turn the jog dial to select a character, then press > to move the cursor to the next position.

### To insert a space

Turn the jog dial until a blank space appears in the display.

### If you've made a mistake

Press < or > repeatedly until the character to be changed flashes, then turn the jog dial to select the right character.

### 4 Press ENTER.

### 5 Repeat steps 2 to 4 to assign index name for another station or program source.

#### Note

(Models of area code **CEL, CEK** only)

You cannot change the name of an RDS station.

## Recording

Before you begin, make sure you've connected all components properly.

### Recording on an audio tape or MiniDisc

You can record on a cassette tape or MiniDisc using the receiver. See the operating instructions of your cassette deck or MD deck if you need help.

#### 1 Select the component to be recorded.

#### 2 Prepare the component for playing.

For example, insert a CD into the CD player.

#### 3 Insert a blank tape or MD into the recording deck and adjust the recording level, if necessary.

#### 4 Start recording on the recording deck, then start playback on the playback component.

#### Notes

- Sound adjustments do not affect the signal output from the MD/TAPE OUT jacks.
- The analog audio signals of the current function is output from the REC OUT jacks.
- When MULTI CH IN is selected, the analog audio signals of the current function is output from the REC OUT jacks.
- You cannot record a digital audio signal using a component connected to the analog MD/TAPE OUT jacks. To record a digital audio signal, connect a digital component to the DIGITAL MD/TAPE OUT jacks.

continued

## Recording (continued)

- Some sources contain copy guards to prevent recording. In this case, you may not be able to record from the sources.
- When MULTI CH IN is selected, no signals are output from DIGITAL OUT jacks (MD/TAPE OPTICAL OUT).

## Recording on a video tape

You can record from a VCR, a TV, a DVD player or an LD player using the receiver. You can also add audio from a variety of audio sources when editing a video tape. See the operating instructions of your VCR or LD player if you need help.

**1 Select the program source to be recorded.**

**2 Prepare the component for playing.**

For example, insert the laser disc you want to record into the LD player.

**3 Insert a blank video tape into the VCR (VIDEO 1) for recording.**

**4 Start recording on the recording VCR, then start playing the video tape or laser disc you want to record.**

### Tip

You can record the sound from any audio source onto a video tape while copying from a video tape or laser disc. Locate the point where you want to start recording from another audio source, select the program source, then start playback. The audio from that source will be recorded onto the audio track of the video tape instead of the audio from the original medium. To resume audio recording from the original medium, select the video source again.

### Notes

- Make sure to make both digital and analog connections to the VIDEO 2 and DVD/LD inputs. Analog recording is not possible if you make only digital connections.
- When MULTI CH IN is selected, the analog audio signals of the current function is output from the REC OUT jacks.

## Using the Sleep Timer

You can set the receiver to turn off automatically at a specified time.

**Press SLEEP on the remote while the power is on.**

Each time you press the button, the display changes cyclically as follows:

2-00-00 → 1-30-00 → 1-00-00 → 0-30-00 → OFF

The display dims after you have specified the time.

### Tips

- You can freely specify the time. After pressing SLEEP, specify the time you want using the jog dial and </> on the receiver. The sleep time changes in 1 minute intervals. You can specify up to 5 hours.
- To check the remaining time before the receiver turns off, press SLEEP. The remaining time appears in the display.

## Adjustments using the SET UP button

The SET UP button allows you to make the following adjustments.

**1 Press SET UP.**

**2 Press <or> to select the parameter you want to adjust.**

**3 Turn the jog dial to select the setting you want.**

The setting is entered automatically.

**4 Repeat steps 2 and 3 until you have set all of the parameters that follow.**

### Initial settings

Parameter	Initial setting
C.MODE.AVX	AV2
PRO LOGIC	II MOVIE
A.PWR - XXX	YES

## CONTROL A1 II control system

### Getting Started

**This section explains the basic functions of the CONTROL A1 II Control System. Certain components have special functions, such as “CD Synchro Dubbing” on cassette decks, that require CONTROL A1 II connections. For detailed information regarding specific operations, be sure to also refer to the Operating Instructions supplied with your component(s).**

The CONTROL A1 II Control System was designed to simplify the operation of audio systems composed of separate Sony components. CONTROL A1 II connections provide a path for the transmission of control signals which enable automatic operation and control features usually associated with integrated systems.

Currently, CONTROL A1 II connections between a Sony CD player, amplifier (receiver), MD deck and cassette deck provide automatic function selection and synchronized recording.

In the future, the CONTROL A1 II connection will work as a multifunction bus allowing you to control various functions for each component.

#### Notes

- The CONTROL A1 II Control System is designed to maintain upward compatibility as the Control System is upgraded to handle new functions. In this case, however, older components will not be compatible with the new functions.
- Do not operate a 2 way remote control unit when the CONTROL A1 II jacks are connected via a PC interface kit to a personal computer running “MD Editor” or similar application. Also, do not operate the connected component in a manner contrary to the functions of the application, as this may cause the application to operate incorrectly.

continued

#### ■ CONTROL A1 II auto power on (A.PWR – XXX)

Lets you turn on the receiver automatically when the component connected via monaural miniplug cord (see page 13) is turned on and the playback is started.

When set to “NO”, you can save the power consumption of the receiver during standby mode.

#### ■ Selecting the command mode of the remote (C.MODE.AVX)

Lets you select the command mode of the remote. Change the command mode when you use 2 Sony receivers in the same room.

#### ■ 2ch decode mode (PRO LOGIC)

Lets you specify the type of decoding for the 2 channel source. This receiver incorporates with Dolby Pro Logic II which has movie mode and music mode, and the receiver can reproduce the 2 channel sound in 5.1 channel through Dolby Pro Logic II.

- When set to “DOLBY PL”, the receiver performs the Pro Logic decoding. The source recorded in 2 channel is decoded into 4 channels.
- When set to “II MOVIE”, the receiver performs the Pro Logic II movie mode decoding. This setting is ideal for the movies encoded in Dolby Surround. Besides, this mode can reproduce the sound in 5.1 channel when watching the videos of old movies or in the dubbed language.
- When set to “II MUSIC”, the receiver performs the Pro Logic II music mode decoding. This setting is ideal for the normal stereo sources, such as CDs.

#### Note

Dolby Pro Logic II does not function for DTS or MPEG format signals.

## CONTROL A1II control system (continued)

### CONTROL A1II and CONTROL A1 compatibility

The CONTROL A1 control system has been updated to the CONTROL A1II which is the standard system in the Sony 300 disc CD changer and other recent Sony components. Components with CONTROL A1 jacks are compatible with components with CONTROL A1II, and can be connected to each other. Basically, the majority of the functions available with the CONTROL A1 control system will be available with the CONTROL A1II control system.

However, when making connections between components with CONTROL A1 jacks and components with CONTROL A1II jacks, the number of functions that can be controlled may be limited depending on the component. For detailed information, refer to the operating instructions supplied with the component(s).

## Connections

Connect monaural mini-plug cords in series to the CONTROL A1II jacks on the back of each component. You can connect up to 10 CONTROL A1II compatible components in any order. However, you can connect only one of each type of component (i.e., 1 CD player, 1 MD deck, 1 tape deck and 1 receiver).

(You may be able to connect more than one CD player or MD deck, depending on the model. Refer to the operating instructions supplied with the respective component for details.)

Example

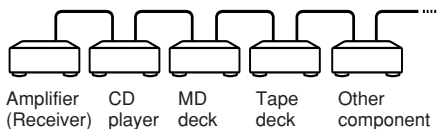

In the CONTROL A1II control system, the control signals flow both ways, so there is no distinction of IN and OUT jacks. If a component has more than one CONTROL A1II jack, you can use either one, or connect different components to each jack.

Jacks and connection examples

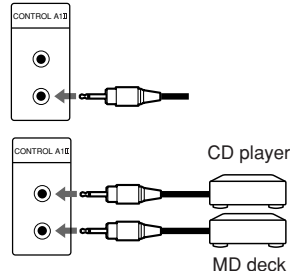

### On CONTROL A1 jacks and connections

It is possible to make connections between CONTROL A1 and CONTROL A1II jacks. For details regarding particular connections or set up options, refer to the operating instructions supplied with the component(s).

### About the connecting cord

Some CONTROL A1 compatible components are supplied with a connecting cord as an accessory. In this case, use the connecting cord for your connection.

When using a commercially available cord, use a monaural mini-plug cord less than 2 meters long, with no resistance (such as the Sony RK-G69HG).

## Basic Functions

The CONTROL A1II functions will operate as long as the component you want to operate is turned on, even if all of the other connected components are not turned on.



### Automatic function selection

When you connect a CONTROL A1 II compatible Sony amplifier (or receiver) to other Sony components using monaural mini-plug cords, the function selector on the amplifier (or receiver) automatically switches to the correct input when you press the play button on one of the connected components.

#### Notes

- You must connect a CONTROL A1 compatible amplifier (receiver) using a monaural mini-plug cord in order to take advantage of the automatic function selection feature.
- This function only works when the components are connected to the amplifier (or receiver) inputs according to the names on the function buttons. Certain receivers allow you to switch the names of the function buttons. In this case, refer to the operating instructions supplied with the receiver.
- When recording, do not play any components other than the recording source. It will cause the automatic function selection to operate.

### Synchronized recording

This function lets you conduct synchronized recording between the selected source and recorder components.

- 1 Set the function selector on the amplifier (or receiver) to the source component.**
- 2 Set the source component to pause mode (make sure both the ► and II indicators light together).**
- 3 Set the recorder component to the REC-PAUSE mode.**
- 4 Press PAUSE on the recorder component.**  
The source component is released from the pause mode, and recording begins shortly thereafter.  
When playback ends from the source component, recording stops.

#### Notes

- Do not set more than one component to the pause mode.
- Certain recorder components may be equipped with a special synchronized recording function that uses the CONTROL A1 II Control System, such as “CD Synchro Dubbing”. In this case, refer to the operating instructions supplied with the recorder component.

## For models of area code U, CA only

You can use the remote RM-PP411 to operate the components in your system.

## Before you use your remote

### Inserting batteries into the remote

Insert R6 (size-AA) batteries with the + and – properly oriented in the battery compartment. When using the remote, point it at the remote sensor  on the receiver.

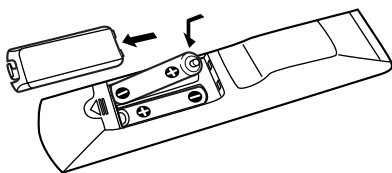

#### Tip

Under normal conditions, the batteries should last for about 6 months. When the remote no longer operates the receiver, replace all batteries with new ones.

#### Notes

- Do not leave the remote in an extremely hot or humid place.
- Do not use a new battery with an old one.
- Do not expose the remote sensor to direct sunlight or lighting apparatuses. Doing so may cause a malfunction.
- If you don't use the remote for an extended period of time, remove the batteries to avoid possible damage from battery leakage and corrosion.

## Remote button description

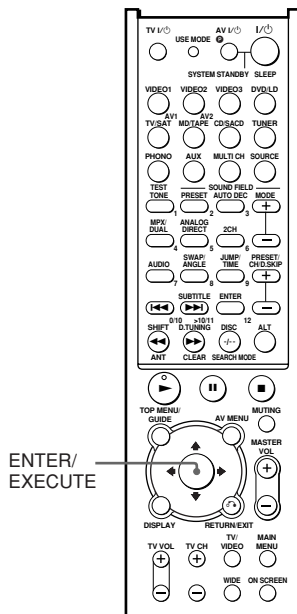

The tables below show the settings of each button.

Remote Button	Operations	Function
I/O	Receiver	Turns the receiver on or off.
SLEEP	Receiver	Activates the sleep function and the duration which the receiver turns off automatically.
VIDEO 1	Receiver	To watch VCR. (VTR mode 3)
VIDEO 2	Receiver	To watch VCR. (VTR mode 1)

Remote Button	Operations	Function
VIDEO 3	Receiver	To watch VCR. (VTR mode 2)
DVD/LD	Receiver	To watch DVD or laser disc.
TV/SAT	Receiver	To watch TV programs or satellite receiver.
MD/TAPE	Receiver	To listen to Minidisc or audio tape.
CD/SACD	Receiver	To listen to compact disc.
TUNER	Receiver	To listen to radio programs.
PHONO	Receiver	To listen to turntable.
AUX	Receiver	To listen to an audio equipment.
MULTI CH	Receiver	Selects MULTI CH IN source.
TEST TONE	Receiver	Press to output test tone.
PRESET	Receiver	Selects preset sound field (e.g. Cinema Studio EX A, B, C).
AUTO DEC	Receiver	Selects AUTO DECODING mode.
MPX/DUAL	Receiver	Select Dual Mono or Bilingual sound of Dolby Digital, DTS or AAC, etc.
ANALOG DIRECT	Receiver	Selects 2CH ANALOG DIRECT.
2CH	Receiver	Selects 2CH mode.
MODE +/-	Receiver	Selects sound field mode.
SHIFT	Receiver	Press repeatedly to select a memory page for presetting radio stations or tuning to preset stations.
D.TUNING	Receiver	Tuner station direct key-in-mode.
MUTING	Receiver	Mutes the sound from the receiver.

Remote Button	Operations	Function
▲/▼	Receiver	Select a menu item.
◀/▶	Receiver	Makes adjustment or change the setting.
MASTER VOL +/-	Receiver	Adjusts the master volume of the receiver.
MAIN MENU	Receiver	Press this button repeatedly to select one of the five cursor modes: EQ, SURR, LEVEL, SET UP and NAME.
ON SCREEN	Receiver	To display the menus of the receiver on the TV screen.
AV I/⏻	TV/VCR/CD player/VCD player/LD player/DVD player/MD deck/DAT deck	Turns the audio and video components on or off.
SYSTEM STANDBY (Press AV I/⏻ and I/⏻ at the same time)	Receiver/TV/ VCR/Satellite tuner/CD player/VCD player/LD player/DVD player/MD deck/DAT deck/Tape deck	Turns off the receiver and other Sony audio/video components.
1-9 and 0/10	Receiver	Use with "SHIFT" button to select tuner preset station numeric input during DIRECT TUNING or MEMORY mode.
	CD player/VCD player/LD player/MD deck/DAT deck	Select track numbers. 0 selects track 10.
	TV/VCR/ Satellite tuner	Select channel numbers.
>10/11	CD player/VCD player/MD deck/Tape deck	Select track numbers over 10.



continued

## Remote Button Description (continued)

Remote Button	Operations	Function
AUDIO	TV/ VCR/ DVD player	Changes the sound to Multiplex, Bilingual or Multi channel TV Sound.
SWAP*/ ANGLE	TV  DVD player	Swaps the small and large picture.  To select viewing angle or changes the angles.
JUMP/ TIME	TV  CD player/ VCD player/ DVD player	Toggles between the previous and the current channels.  Shows the time or displays the playing time of disc, etc.
PRESET/ CH/	Receiver	Scans and selects preset stations.
D.SKIP +/-	TV/VCR/ satellite tuner  CD player/ VCD player/ DVD player/ MD deck	Selects preset channels.  Skips discs (multi-disc changer only).
ENTER	TV/VCR/ satellite tuner/ LD player/ MD deck/ DAT deck/ Tape deck	After selecting a channel, disc or track using the numeric buttons, press to enter the value.
DISC	CD player/ VCD player	Selects a disc directly (multi-disc changer only).
ANT	VCR	Selects output signal from aerial terminal: TV signal or VCR program.
◀◀/▶▶	VCR/ CD player/ VCD player/ LD player/ DVD player/ MD deck/ DAT deck/ Tape deck	Skips tracks.

\* Only for Sony TVs with the picture-in-picture function.

Remote Button	Operations	Function
◀◀/▶▶	CD player/ VCD player/ DVD player/ LD player/ MD deck  VCR/ DAT deck/ Tape deck	Searches tracks (forward or backward).  Fastforwards or rewinds.
▶	VCR/ CD player/ VCD player/ LD player/ DVD player/ MD deck/ DAT deck/ Tape deck	Starts play.
▬▬	VCR/ CD player/ VCD player/ LD player/ DVD player/ MD deck/ DAT deck/ Tape deck	Pauses play or record. (Also starts recording with components in record standby.)
■	VCR/ CD player/ VCD player/ LD player/ DVD player/ MD deck/ DAT deck/ Tape deck	Stops play.
DISPLAY	TV/VCR/ VCD player/ LD player/ DVD player	Selects information displayed on the TV screen.
RETURN/ EXIT	VCD player/ LD player/ DVD player  Satellite tuner	Returns to the previous menu.  Exits the menu.
SUBTITLE	DVD player	Changes the subtitles.

Remote Button	Operations	Function
CLEAR	DVD player	Press if you made a mistake when you press the number button or press to return to the continuous play etc.
SEARCH MODE	DVD player	Select searching mode. Press to select the unit for search (track, index, etc.)
TOP MENU /GUIDE	DVD player	Displays DVD title.
AV MENU	VCR/Satellite/ tuner/ DVD player	Displays menu.
	VCD player/ LD player/ DVD player	Returns to the previous menu or exits the menu.
	VCR/Satellite tuner/ DVD player	Selects a menu item.
ENTER/ EXECUTE	VCR/satellite tuner/ DVD player	Press to enter the selection.
TV I/ 	TV	Turns the TV on or off.
-/-	TV	Selects the channel entry mode, either one or two digit.
TV VOL +/-	TV	Adjust the volume of the TV.
TV CH +/-	TV	Select preset TV channels.
TV/ VIDEO	TV	Selects input signal: TV input or video input.
WIDE	TV	Selects the wide picture mode.
USE MODE	Remote	To set up the remote.
AV1 and AV2	Remote	Select the command mode of the remote.
SOURCE	Remote	Selects 2ND AV output.
ALT	Remote	Change remote key function to activate those buttons with orange printing.

## Notes

- Some functions explained in this section may not work depending on the model of the receiver.
- The above explanation is intended to serve as an example only.  
Therefore, depending on the component the above operation may not be possible or may operate differently than described.
- The TV/SAT, PHONO, SOURCE, MPX/DUAL, ANALOG DIRECT, 12 and ON SCREEN functions are not available for set operation.

## Selecting the mode of the remote

Set the remote mode using the USE MODE button and the remote mode buttons.

### Selecting the command mode

You can switch the command mode (AV1 or AV2) of the remote. If the command mode of the receiver and the remote is different, you cannot use the remote to operate the receiver.

### Press 1 (AV1) (or 2 (AV2)) while pressing down USE MODE.



The indicator lights once (twice for AV2) , then the command mode switches.

### To check the mode of the remote

Press USE MODE. You can check the remote by the indicator.

Mode	Indicator lights
AV1	once
AV2	twice

### To reset the remote to factory settings

Press I/, AV I/, and MASTER VOL – at the same time.

The indicator lights 3 times, then goes off.

## Programming the remote

You can program the remote to control non-Sony components by changing the code. Once the control signals have been memorized, you can use those components as part of your system.

Furthermore, you can also program the remote for Sony components that the remote is unable to control. Note that the remote can only control components that accept infrared wireless control signals.

### 1 Press AV I/⏻ while pressing down USE MODE.

The indicator lights.

### 2 Press the function button (including TV I/⏻) for the component you want to control.

For example, if you are going to control a CD player, press CD/SACD.

### 3 Press the numeric buttons to enter the numeric code (or one of the codes if more than one code exists) corresponding to the component and the maker of the component you want to control.

See the tables on pages 47 and 48 for information on the numeric code(s) corresponding to the component and the maker of the component (the first digit and the last two digits of the numeric code correspond to the category and the maker's code respectively.)

### 4 Press ENTER.

Once the numeric code has been verified, the indicator slowly flashes twice and the remote automatically exits the programming mode.

### 5 Repeat steps 1 to 4 to control other components.

#### To cancel programming

Press USE MODE during any step. The remote automatically exits the programming mode.

#### To activate the function after programming.

Press the programmed button to activate the function you want.

#### If programming is unsuccessful, check the following:

- If the indicator does not light up in step 1, the batteries are weak. Replace both batteries.
- If the indicator flashes 4 times in quick succession while entering the numeric code, an error has occurred. Start again from step 1.

#### Notes

- The indicator turns off while a valid button is pressed.
- In step 2, if several function buttons are pressed, only the last pressed button is valid.
- In step 2, if you press TV I/⏻, only TV VOL +/-, TV CH +/-, TV/VIDEO and WIDE buttons are reprogrammed.
- In step 3, if a function button is pressed, the new function is selected and the programming procedure returns to the beginning of step 3.
- For the numeric codes, only the first three numbers entered are valid.

#### To clear the memory of the remote

To clear all programmed and learned signals, do the following to reset the remote to factory settings.

#### Press I/⏻, AV I/⏻ and MASTER VOL – at the same time.

The indicator flashes 3 times, then goes off.

## The numeric codes corresponding to the component and the maker of the component

Use the numeric codes in the tables below to control non-Sony components and also Sony components that the remote is normally unable to control. Since the remote signal that a component accepts differs depending on the model and year of the component, more than one numeric code may be assigned to a component. If you fail to program your remote using one of the codes, try using other codes.

### Notes

- The numeric codes are based on the latest information available for each brand. There is a chance, however, that your component will not respond to some or all of the codes.
- All of the functions on this remote may not be available when used with your particular component.

### To control a CD player

Maker	Code(s)
SONY	101, 102, 103
DENON	104, 123
JVC	105, 106, 107
KENWOOD	108, 109, 110
MAGNAVOX	111, 116
MARANTZ	116
ONKYO	112, 113, 114
PANASONIC	115
PHILIPS	116
PIONEER	117
TECHNICS	115, 118, 119
YAMAHA	120, 121, 122

### To control a DAT deck

Maker	Code(s)
SONY	203
PIONEER	219

### To control an MD deck

Maker	Code(s)
SONY	301
DENON	302
JVC	303
KENWOOD	304

### To control a tape deck

Maker	Code(s)
SONY	201, 202
DENON	204, 205
KENWOOD	206, 207, 208, 209
NAKAMICHI	210
PANASONIC	216
PHILIPS	211, 212
PIONEER	213, 214
TECHNICS	215, 216
YAMAHA	217, 218

### To control an LD player

Maker	Code(s)
SONY	601, 602, 603
PIONEER	606

### To control a video CD player

Maker	Code(s)
SONY	605

continued

## Programming the remote (continued)

### To control a VCR

Maker	Code(s)
SONY	701, 702, 703, 704, 705, 706
AIWA	710, 750, 757, 758
AKAI	707, 708, 709, 759
BLAUPUNKT	740
EMERSON	711, 712, 713, 714, 715, 716, 750
FISHER	717, 718, 719, 720
GENERAL ELECTRIC	721, 722, 730
GOLDSTAR	723, 753
GRUNDIG	724
HITACHI	722, 725, 729, 741
ITT/NOKIA	717
JVC	726, 727, 728, 736
MAGNAVOX	730, 731, 738
MITSUBISHI/MGA	732, 733, 734, 735
NEC	736
PANASONIC	729, 730, 737, 738, 739, 740
PHILIPS	729, 730, 731
PIONEER	729
RCA/PROSCAN	722, 729, 730, 731, 741, 747
SAMSUNG	742, 743, 744, 745
SANYO	717, 720, 746
SHARP	748, 749
TELEFUNKEN	751, 752
TOSHIBA	747, 755, 756
ZENITH	754

### To control a DVD player

Maker	Code(s)
SONY	401, 402, 403
PANASONIC	406, 408
PHILIPS	407
PIONEER	409
TOSHIBA	404
DENON	405

### To control a TV

Maker	Code(s)
SONY	501
DAEWOO	504, 505, 506, 507, 515, 544
FISHER	508
GOLDSTAR	503, 511, 512, 515, 534, 544
GRUNDIG	517, 534
HITACHI	513, 514, 515, 544
ITT/NOKIA	521, 522
JVC	516
MAGNAVOX	503, 518, 544
MITSUBISHI/MGA	503, 519, 544
NEC	503, 520, 544
PANASONIC	509, 524
PHILIPS	515, 518
PIONEER	509, 525, 526, 540
RCA/PROSCAN	510, 527, 528, 529, 544
SAMSUNG	503, 515, 531, 532, 533, 534, 544
SANYO	508, 545
SHARP	535
TELEFUNKEN	523, 536, 537, 538
THOMSON	530, 537, 539
TOSHIBA	535, 540, 541
ZENITH	542, 543

### To control a satellite tuner or cable box

Maker	Code(s)
SONY	801, 802
JERROLD/G.I.	806, 807, 808, 809, 810, 811, 812, 813, 814
PANASONIC	818
RCA	805, 819
S. ATLANTA	815, 816, 817



## Except for models of area code U, CA

You can use the remote RM-U305C to operate the components in your system.

## Before you use your remote

### Inserting batteries into the remote

Insert R6 (size-AA) batteries with the + and – properly oriented in the battery compartment. When using the remote, point it at the remote sensor  on the receiver.

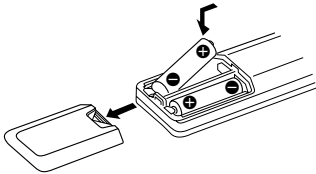

#### Tip

Under normal conditions, the batteries should last for about 6 months. When the remote no longer operates the receiver, replace all batteries with new ones.

#### Notes

- Do not leave the remote in an extremely hot or humid place.
- Do not use a new battery with an old one.
- Do not expose the remote sensor to direct sunlight or lighting apparatuses. Doing so may cause a malfunction.
- If you don't use the remote for an extended period of time, remove the batteries to avoid possible damage from battery leakage and corrosion.

## Remote button description

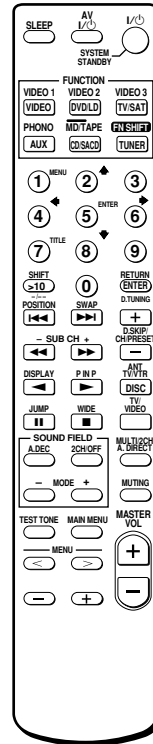

The tables below show the settings of each button.

Remote Button	Operations	Function
SLEEP	Receiver	Activates the sleep function and the duration which the receiver turns off automatically.
I/O	Receiver	Turns the receiver on or off.

continued

## Remote button description (continued)

Remote Button	Operations	Function
VIDEO/ VIDEO 1*	Receiver	To watch VCR. (VTR mode 3)
VIDEO 2*	Receiver	To watch VCR. (VTR mode 1)
VIDEO 3*	Receiver	To watch VCR. (VTR mode 2)
DVD/LD	Receiver	To watch DVD or laser disc.
TV/SAT	Receiver	To watch TV programs or satellite receiver.
PHONO*	Receiver	To listen to turntable.
MD/TAPE*Receiver	Receiver	To listen to Minidisc or audio tape.
AUX	Receiver	To listen to an audio equipment.
CD/SACD	Receiver	To listen to compact disc.
TUNER	Receiver	To listen to radio programs.
SHIFT	Receiver	Press repeatedly to select a memory page for presetting radio stations or tuning to preset stations.
D.TUNING	Receiver	Tuner station direct key-in-mode.
A.DEC	Receiver	Select AUTO DECODING mode.
MODE+/-	Receiver	Selects sound field mode.
2CH/OFF	Receiver	Turns off sound field or select 2CH mode.
MULTI/ 2CH A. DIRECT	Receiver	Selects MULTI CH IN source.
MUTING	Receiver	Mutes the sound from the receiver

\* VIDEO 1, VIDEO 2, VIDEO 3, PHONO and MD/TAPE function is a 2-key operation. To select the above function, press FN SHIFT (function shift) and the function key you want simultaneously. For example, press FN SHIFT and CD/SACD to select MD/TAPE function.

Remote Button	Operations	Function
TEST TONE	Receiver	Press to output test tone.
MAIN MENU	Receiver	Press this button repeatedly to select one of the five cursor modes: EQ, SURR, LEVEL, SET UP and NAME.
MENU </>	Receiver	Selects a menu item.
MENU +/-	Receiver	Makes adjustment or change the setting.
MASTER VOL +/-	Receiver	Adjusts the master volume of the receiver.
AV I/⏻	TV/VCR/ CD player/ VCD player/ LD player/ DVD player/ MD deck/ DAT deck/	Turns the audio and video components on or off.
SYSTEM STANDBY (Press AV I/⏻ and I/⏻ at the same time)	Receiver/TV/ VCR/Satellite tuner/ CD player/ VCD player/ LD player/ DVD player/ MD deck/ DAT deck/ TAPE deck.	Turns off the receiver and other Sony audio/video components
0-9	Receiver	Use with "SHIFT" button to select tuner preset station numeric input during DIRECT TUNING or MEMORY mode.
	CD player/ VCD player/ LD player/ MD deck/ DAT deck	Selects track numbers. 0 selects track 10.
	TV/VCR/ satellite tuner	Selects channel numbers.
>10	CD player/ VCD player/ LD player/ MD deck/ Tape deck	Selects tracks numbers over 10.

Remote Button	Operations	Function
ENTER	TV/VCR/ satellite tuner/ LD player/ MD deck/ DAT deck/ Tape deck	After selecting a channel, disc or track using the numeric buttons, press to enter the value.
D. SKIP/ CH/PRESET +/-	Receiver  TV/VCR/ satellite tuner  CD player/ VCD player/ DVD player/ MD deck	Scans and selects preset stations.  Selects preset channel.  Skips discs (multi-disc changer only).
◀◀/▶▶	VCR/ CD player/ VCD player/ LD player/ DVD player/ MD deck/ DAT deck/ Tape deck	Skip tracks.
◀◀/▶▶	CD player/ VCD player/ DVD player  VCR/ LD player/ MD deck/ DAT deck/ Tape deck	Search tracks (forward or backward)  Fastforwards or rewinds.
◀	Tape deck	Starts play on the reverse side.
▶	VCR/ CD player/ VCD player/ LD player/ DVD player/ MD deck/ DAT deck/ Tape deck	Starts play.

Remote Button	Operations	Function
⏸	VCR/ CD player/ VCD player/ LD player/ DVD player/ MD deck/ DAT deck/ Tape deck	Pauses play or record. (Also start recording with components in record standby.)
■	VCR/ CD player/ VCD player/ LD player/ DVD player/ MD deck/ DAT deck/ Tape deck	Stops play.
DISPLAY	TV/VCR, VCD player/ LD player/ DVD player	Selects information displayed on the TV screen.
ANT TV/VTR	VCR	Selects output signal from the aerial terminal: TV signal or VCR program.
DISC	CD player	Select discs (multi-disc changer only).
TOP MENU	DVD player	Displays DVD title.
DVD MENU	DVD player	Displays DVD menu.
ENTER	DVD player	Enters the selection.
RETURN	DVD player	Returns to previous menu or exits the menu.
⏪/⏩/⏴/⏵	DVD player	Selects a menu item.
-/-	TV	Selects the channel entry mode, either one or two digit

**continued**

## Remote button description (continued)

Remote Button	Operations	Function
POSITION**TV		Changes the position of the small picture.
SWAP** TV		Swaps the small and the large picture.
SUB CH +/_**	TV	Selects the preset channels for the small picture.
P IN P**	TV	Activates the picture-in-picture function.
JUMP	TV	Toggles between the previous and the current channels.
WIDE	TV	Selects the wide picture mode.
TV/VIDEO	TV	Selects input signal: TV input or video input.

\*\* Only for Sony TVs with the picture-in-picture function.

### Notes

- When you press the function buttons (VIDEO 1, VIDEO 2, VIDEO 3, DVD/LD), the input mode of the TV might not switch to the corresponding input mode that you want. In this case, press the TV/VIDEO button to switch the input mode of the TV.
- Some functions explained in this section may not work depending on the model of the receiver.
- The above explanation is intended to serve as an example only. Therefore, depending on the component the above operation may not be possible or may operate differently than described.
- The TV/SAT and PHONO functions are not available for set operation.

## Changing the factory setting of a function button

If the factory settings of the FUNCTION buttons do not match your system components, you can change them. For example, if you have an MD player and a tape deck and you don't have a CD player, you can assign the CD/SACD button to your tape deck.

Note that the settings of the TUNER and FN SHIFT functions (VIDEO 1, VIDEO 2, VIDEO 3, PHONO and MD/TAPE) button cannot be changed.

- 1 Hold down the Function button whose function you want to change (for example, CD/SACD).**
- 2 Press the corresponding button of the component you want to assign to the Function button (for example, 4 – Tape deck).**

The following buttons are assigned to select the functions:

To operate	Press
CD player	1
DAT deck	2
MD deck	3
Tape deck A	4
Tape deck B	5
LD player	6
VCR (command mode VTR 1*)	7
VCR (command mode VTR 2*)	8
VCR (command mode VTR 3*)	9
TV	0
DSS (Digital Satellite Receiver)	>10
DVD	ENTER
VCD player	◀◀

\* Sony VCRs are operated with a VTR 1, 2 or 3 setting. These correspond to Beta, 8mm and VHS respectively.

Now you can use the CD/SACD button to control the tape deck.

### To reset a button to its factory setting

Repeat the above procedure.

### To reset all the function buttons to their factory setting

Press I/⏪, AV I/⏪ and MASTER VOL – at the same time.

### Precautions

#### On safety

Should any solid object or liquid fall into the cabinet, unplug the receiver and have it checked by qualified personnel before operating it any further.

#### On power sources

- Before operating the unit, check that the operating voltage is identical with your local power supply. The operating voltage is indicated on the nameplate at the rear of the receiver.
- The unit is not disconnected from the AC power source (mains) as long as it is connected to the wall outlet, even if the receiver itself has been turned off.
- If you are not going to use the receiver for a long time, be sure to disconnect the receiver from the wall outlet. To disconnect the AC power cord, grasp the plug itself; never pull the cord.
- (Models of area code U, CA only)  
One blade of the plug is wider than the other for the purpose of safety and will fit into the wall outlet only one way. If you are unable to insert the plug fully into the outlet, contact your dealer.
- AC power cord must be changed only at the qualified service shop.

#### On heat buildup

Although the unit heats up during operation, this is not a malfunction. If you continuously use this unit at a large volume, the cabinet temperature of the top, side and bottom rises considerably. To avoid burning yourself, do not touch the cabinet.

#### On placement

- Place the receiver in a location with adequate ventilation to prevent heat buildup and prolong the life of the receiver.
- Do not place the receiver near heat sources, or in a place subject to direct sunlight, excessive dust or mechanical shock.
- Do not place anything on top of the cabinet that might block the ventilation holes and cause malfunctions.

#### On operation

Before connecting other components, be sure to turn off and unplug the receiver.

#### On cleaning

Clean the cabinet, panel and controls with a soft cloth slightly moistened with a mild detergent solution. Do not use any type of abrasive pad, scouring powder or solvent such as alcohol or benzine.

If you have any question or problem concerning your receiver, please consult your nearest Sony dealer.

### Troubleshooting

If you experience any of the following difficulties while using the receiver, use this troubleshooting guide to help you remedy the problem. Also, see "Checking the connections" on page 22 to verify that the connections are correct. Should any problem persist, consult your nearest Sony dealer.

#### **There is no sound or only a very low-level sound no matter which component is selected.**

- Check that the speakers and components are connected securely and correctly.
- Check that both the receiver and all the components are turned on.
- Check that the MASTER VOLUME control is not set at VOL MIN.
- Check that the SPEAKERS A/B button is not set to "SP. OFF" and is set accordingly to your SPEAKERS FRONT system (page 24).
- Press MUTING to cancel the muting function.
- Check that the headphones are not connected.
- The protective device on the receiver has been activated because of a short circuit ("PROTECT" flashes). Turn off the receiver, eliminate the short-circuit problem and turn on the power again.

#### **There is no sound from a specific component.**

- Check that the component is connected correctly to the audio input jacks for that component.
- Check that the cord(s) used for the connection is (are) fully inserted into the jacks on both the receiver and the component.
- Check that you have selected the correct component on the receiver.

continued

## Troubleshooting (continued)

---

### There is no sound from one of the front speakers.

Connect a pair of headphones to the PHONES jack to verify that sound is output from the headphones (page 24).

If only one channel is output from the headphones, the component may not be connected to the receiver correctly. Check that all the cords are fully inserted into the jacks on both the receiver and the component.

If both channels are output from the headphones, the front speaker may not be connected to the receiver correctly. Check the connection of the front speaker which is not outputting any sound.

---

### The left and right sounds are unbalanced or reversed.

- Check that the speakers and components are connected correctly and securely.
  - Adjust balance parameters in the LEVEL menu.
- 

### There is severe hum or noise.

- Check that the speakers and components are connected securely.
  - Check that the connecting cords are away from a transformer or motor, and at least 3 meters away from a TV set or fluorescent light.
  - Move your TV away from the audio components.
  - The plugs and jacks are dirty. Wipe them with a cloth slightly moistened with alcohol.
- 

### There is no sound or only a very low-level sound is heard from the center or/and surround speakers.

- Make sure the sound field function is on (press MODE).
  - Select a sound field containing the word "C.ST.EX" (pages 25–26).
  - Adjust the speaker level (page 22).
  - Make sure the center or/and surround speaker size parameter is set to either "SMALL" or "LARGE" (page 19).
- 

---

### There is no sound from the active sub woofer.

There is no sound output from the SUB WOOFER terminal depending on the sound field (back page).

---

### The surround effect cannot be obtained.

Make sure the sound field function is on (press MODE).

---

### Dolby Digital or DTS multi channel sound is not reproduced.

- Check that the playing DVD, etc. is recorded in Dolby Digital or DTS format.
  - When connecting the DVD player, etc. to the digital input jacks of this receiver, check the audio setting (settings for the audio output) of the connected component.
- 

### Recording cannot be done.

- Check that the components are connected correctly.
  - Select the source component with function buttons.
  - Make sure that INPUT MODE is set to "ANALOG" before recording from a digital component connected to the analog MD/TAPE terminals.
  - Make sure that INPUT MODE is set to "COAX IN" or "OPT IN" (page 23) before recording from a digital component connected to the DIGITAL MD/TAPE OUT terminals.
- 

### To connect an LD player via an RF demodulator.

Connect the LD player to the RF demodulator, then connect the RF demodulator's optical or coaxial digital output to the receiver's jack. When making this connection, be sure to set INPUT MODE manually (page 23). The receiver may not operate correctly if INPUT MODE is set to "AUTO IN".

For details on DOLBY DIGITAL RF hookups, see the operating instructions supplied with your RF demodulator.

---

**The FM reception is poor.**

Use a 75-ohm coaxial cable (not supplied) to connect the receiver to an outdoor FM antenna as shown below. If you connect the receiver to an outdoor antenna, ground it against lightning. To prevent a gas explosion, do not connect the ground wire to a gas pipe.

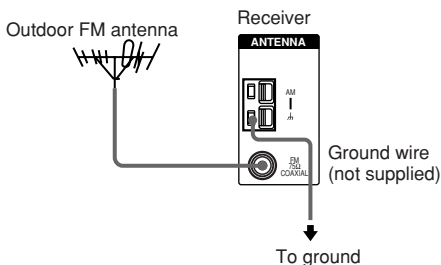

**Radio stations cannot be tuned in.**

- Check that the antennas are connected securely. Adjust the antennas and connect an external antenna if necessary.
- The signal strength of the stations is too weak (when tuning in with automatic tuning). Use direct tuning.
- Make sure you set the tuning interval correctly (when tuning in AM stations with direct tuning).
- No stations have been preset or the preset stations have been cleared (when tuning by scanning preset stations). Preset the stations (page 34).
- Press DISPLAY so that the frequency appears in the display.

**RDS does not work.\***

- Make sure that you're tuned to an FM RDS station.
- Select a stronger FM station.





**The RDS information that you want does not appear.\***

Contact the radio station and find out whether they actually provide the service in question. If so, the service may be temporarily out of order.

**There is no picture or an unclear picture appears on the TV screen or monitor.**

- Select the appropriate function on the receiver.
- Set your TV to the appropriate input mode.
- Move your TV away from the audio components.

**The remote does not function.**

- The TV/SAT, PHONO, SOURCE, MPX/DUAL, ANALOG DIRECT, 12 and ON SCREEN buttons on the remote are not available. (RM-PP411 only)
- The TV/SAT and PHONO buttons on the remote are not available. (RM-U305C only)
- Point the remote at the remote sensor  on the receiver.
- Check that the mode of the remote corresponds to that of the receiver (pages 38 and 45) (RM-PP411 only).
- Check that you select AV1 as the command mode of the receiver (page 38) (RM-U305C only).
- Remove any obstacles in the path between the remote and the receiver.
- Replace both batteries in the remote with new ones, if they are weak.
- Make sure you select the correct function on the remote.
- If the remote is set to operate the TV only, use the remote to select a source or component other than TV before operating the receiver or other component.
- Press MAIN MENU on the remote before you use the /// buttons for receiver operation (RM-PP411 only).

\* Models of area code CEL, CEK only.

**Clearing the receiver's memory**

To clear	See
All memorized settings	page 17
Customized sound fields	page 31

# Specifications

## AUDIO POWER SPECIFICATIONS

### POWER OUTPUT AND TOTAL HARMONIC DISTORTION:

With 8 ohm loads, both channels driven, from 20 – 20,000 Hz; rated 100 watts per channel minimum RMS power, with no more than 0.09 % total harmonic distortion from 250 milliwatts to rated output (Models of area code U only).

### Amplifier section

#### POWER OUTPUT

##### Models of area code U, CA

##### Rated Power Output at Stereo Mode

(8 ohms 20 Hz – 20 kHz, THD 0.09 %)  
100 W + 100 W

##### Reference Power Output

(8 ohms 1 kHz, THD 0.7 %)  
FRONT<sup>1)</sup>: 100 W/ch  
CENTER<sup>1)</sup>: 100 W  
SURR<sup>1)</sup>: 100 W/ch

##### Models of area code CEL, CEK

##### Rated Power Output at Stereo Mode

(8 ohms 1 kHz, THD 0.7 %)  
100 W + 100 W<sup>2)</sup>

##### Reference Power Output<sup>2)</sup>

(8 ohms 1 kHz, THD 0.7 %)  
FRONT<sup>1)</sup>: 100 W/ch  
CENTER<sup>1)</sup>: 100 W  
SURR<sup>1)</sup>: 100 W/ch

##### Models of other area code

##### Rated Power Output at Stereo Mode

(8 ohms 1 kHz, THD 0.7 %)  
100 W + 100 W<sup>2)</sup>

##### Reference Power Output<sup>2)</sup>

(8 ohms 1 kHz, THD 10 %)  
FRONT<sup>1)</sup>: 120 W/ch  
CENTER<sup>1)</sup>: 120 W  
SURR<sup>1)</sup>: 120 W/ch

1) Depending on the sound field settings and the source, there may be no sound output.

2) Measured under the following conditions:

Area code	Power requirements
E2/E3, AU	240 V AC, 50 Hz
SP, CEL, CEK, AR	230 V AC, 50 Hz
TW	110 V AC, 60 Hz
MX	120 V AC, 60 Hz

### Frequency response

MULTI CH IN, CD/SACD, AUX, MD/TAPE, DVD/LD, VIDEO 1, 2, 3	10 Hz – 70 kHz +0.5/-2 dB (with sound field, equalizer, and bass boost bypassed)
--	---

### Inputs (Analog)

MULTI CH IN, CD/SACD, AUX, MD/TAPE, DVD/LD, VIDEO 1, 2, 3	Sensitivity: 250 mV Impedance: 50 kilohms S/N <sup>3)</sup> : 96 dB (A, 250 mV <sup>4)</sup> )
--	---

3) INPUT SHORT (with sound field, equalizer and bass boost bypassed).

4) Weighted network, input level.

### Inputs (Digital)

DVD/LD (Coaxial)	Sensitivity: – Impedance: 75 ohms S/N: 100 dB (A, 20 kHz LPF)
VIDEO 2, CD/SACD, MD/TAPE (Optical)	Sensitivity: – Impedance: – S/N: 100 dB (A, 20 kHz LPF)

### Outputs (Analog)

MD/TAPE (OUT), VIDEO 1 (AUDIO OUT)	Voltage: 250 mV Impedance: 10 kilohms
SUB WOOFER	Voltage: 2 V Impedance: 1 kilohms

### Outputs (Digital)

MD/TAPE (Optical)	Sensitivity: –
-------------------	----------------

### EQ

Gain levels: ±6 dB, 1 dB step



## FM tuner section

<b>Tuning range</b>	87.5 - 108.0 MHz
<b>Antenna terminals</b>	75 ohms, unbalanced
<b>Intermediate frequency</b>	10.7 MHz
<b>Sensitivity</b>	
Mono:	18.3 dBf, 2.2 $\mu$ V/75 ohms
Stereo:	38.3 dBf, 22.5 $\mu$ V/75 ohms
<b>Usable sensitivity</b>	11.2 dBf, 1 $\mu$ V/75 ohms
<b>S/N</b>	
Mono:	76 dB
Stereo:	70 dB
<b>Harmonic distortion at 1 kHz</b>	
Mono:	0.3%
Stereo:	0.5%
<b>Separation</b>	45 dB at 1 kHz
<b>Frequency response</b>	30 Hz - 15 kHz, +0.5/-2 dB
<b>Selectivity</b>	60 dB at 400 kHz

## AM tuner section

<b>Tuning range</b>	
<b>Models of area code U, CA</b>	
With 10-kHz tuning scale:	530 - 1710 kHz <sup>5)</sup>
With 9-kHz tuning scale:	531 - 1710 kHz <sup>5)</sup>
<b>Models of area code E2/E3, AR, MX</b>	
With 10-kHz tuning scale:	530 - 1610 kHz <sup>5)</sup>
With 9-kHz tuning scale:	531 - 1602 kHz <sup>5)</sup>
<b>Models of area code SP, CEL, CEK, TW, AU</b>	
With 9-kHz tuning scale:	531 - 1602 kHz
<b>Antenna</b>	Loop antenna
<b>Intermediate frequency</b>	450 kHz
<b>Usable sensitivity</b>	50 dB/m (at 1,000 kHz or 999 kHz)
<b>S/N</b>	54 dB (at 50 mV/m)
<b>Harmonic distortion</b>	0.5 % (50 mV/m, 400 Hz)
<b>Selectivity</b>	
At 9 kHz:	35 dB
At 10 kHz:	40 dB

5) You can change the AM tuning scale to 9 kHz or 10 kHz. After tuning in any AM station, turn off the receiver. Hold down PRESET TUNING + and press I/⏏. All preset stations will be erased when you change the tuning scale. To reset the scale to 10 kHz (or 9 kHz), repeat the procedure.

## Video section

### Inputs

Video:	1 Vp-p, 75 ohms
Y:	1 Vp-p, 75 ohms
C:	0.286 Vp-p, 75 ohms
Component Video:	Y: 1 Vp-p, 75 ohms
	P <sub>B</sub> B-Y: 0.7 Vp-p, 75 ohms
	P <sub>R</sub> R-Y: 0.7 Vp-p, 75 ohms

### Outputs

Video:	1 Vp-p, 75 ohms
S-video:	Y: 1 Vp-p, 75 ohms
	C: 0.286 Vp-p, 75 ohms
Component Video:	Y: 1 Vp-p, 75 ohms
	P <sub>B</sub> B-Y: 0.7 Vp-p, 75 ohms
	P <sub>R</sub> R-Y: 0.7 Vp-p, 75 ohms

## General

### Power requirements

Area code	Power requirements
U, CA, MX	120 V AC, 60 Hz
CEL, CEK	230 V AC, 50/60 Hz
SP, AR	220 - 230 V AC, 50/60 Hz
E2/E3	120/220/240 V AC, 50/60 Hz
TW	110 V AC, 50/60 Hz
AU	240 V AC, 50 Hz

### Power consumption

Area code	Power consumption
U, MX	210 W
CA	300 VA
CEL, CEK, AU, E2/E3, SP, AR	180 W
TW	450 W

### Power consumption (during standby mode)

0.5 W (when "A.PWR" in the SET UP menu is set to "NO") (page 38).

continued

## Specifications (continued)

### AC outlets

Area code	AC outlets
U, CA	1 switched, 120 W/1A MAX
SP, CEL, CEK, E2/E3, TW, AU, MX	1 switched, 100 W MAX

**Dimensions** 430 × 157.5 × 308.5 mm  
(16 7/8 × 6 2/8 × 12 1/8 inches) including projecting parts and controls

**Mass (Approx.)** 7.5 kg (16 lb 9 oz)

### Supplied accessories

FM wire antenna (1)

AM loop antenna (1)

Remote commander (1)

- RM-PP411 (models of area code U, CA only)
- RM-U305C (except for models of area code U, CA)

R6 (size-AA) batteries (2)

For details on the area code of the component you are using, see page 4.

Design and specifications are subject to change without notice.

## Tables of settings using SURR, LEVEL, EQ, and SET UP buttons

You can make various settings using the LEVEL, SURR, EQ, SET UP buttons, jog dial, and < / > buttons. The tables below show each of the settings that these buttons can make.

Press	Press < or > to select	Turn jog dial to select	Page
SURR	EFFECT	depends on the sound field (15 steps)	29
LEVEL	BAL. L/R XXX	L +8 to R +8 (1 steps)	29
	CTR XXX dB	-10 dB to +10 dB (1 dB steps)	
	SUR.L.XXX dB	-10 dB to +10 dB (1 dB steps)	
	SUR.R.XXX dB	-10 dB to +10 dB (1 dB steps)	
	S.W. XXX dB	-10 dB to +10 dB (1 dB steps)	
	L.F.E. XXX dB	OFF, -20 dB to 0 dB (1 dB steps)	
	COMP. XXX	OFF, 0.1 to 0.9 (0.1 steps), STD, MAX	
EQ	FRONT BASS GAIN	-6 dB to +6 dB (1 dB steps)	31
	FRONT TREBLE GAIN	-6 dB to +6 dB (1 dB steps)	
SET UP	(FRONT)	LARGE, SMALL	18
	(CENTER)	LARGE, SMALL, NO	
	(SURROUND)	LARGE, SMALL, NO	
	(SUB WOOFER) S.W. XXX	YES, NO	
	DIST. XX.X m	between 1.0 meters and 12.0 meters (0.1 meters steps) <sup>1)</sup>	
	DIST. XX.X m	between   DIST. and 1.5 meters (0.1 meters steps) <sup>2)</sup>	
	DIST. XX.X m	between   DIST. and 4.5 meters (0.1 meters steps) <sup>3)</sup>	
	PL. XXX	SIDE, MID, BEHD.	
	HGT. XXX	LOW, HIGH	
	C.MODE.AVX	AV1, AV2	38
	DOLBY PL, II MOVIE, II MUSIC		
A.PWR-XXX	YES, NO		

- 1) For models of area code U, CA: between 3 feet and 40 feet (1 foot steps)
- 2) For models of area code U, CA: between DIST. and 5 feet (1 foot steps)
- 3) For models of area code U, CA: between DIST. and 15 feet (1 foot steps)

## Adjustable parameters for each sound field

The adjusted SURR and EQ parameters are stored in each sound field.

	< SURR >	< EQ >
	EFFECT LEVEL	FRONT BASS GAIN TREBLE GAIN
2CH ST.		● ●
AUTO DEC.		● ●
NORM.SURR.		● ●
C.ST.EX A	●	● ●
C.ST.EX B	●	● ●
C.ST.EX C	●	● ●
HALL	●	● ●
JAZZ	●	● ●
CONCERT	●	● ●
GAME	●	● ●
MULTI CH IN		
PCM96K		

The adjusted LEVEL parameters are applied to all the sound fields.

	< LEVEL >						
	FRONT BAL	CENTER LEVEL	SUR.L. LEVEL	SUR.R. LEVEL	S. WOOFER LEVEL	LFE MIX <sup>1)</sup>	D.RANGE COMP <sup>1)</sup>
2CH ST.	●					●	●
AUTO DEC.	●	●	●	●	●	●	●
NORM.SURR.	●	●	●	●	●	●	●
C.ST.EX A	●	●	●	●	●	●	●
C.ST.EX B	●	●	●	●	●	●	●
C.ST.EX C	●	●	●	●	●	●	●
HALL	●	●	●	●	● <sup>2)</sup>	●	●
JAZZ	●	●	●	●	● <sup>2)</sup>	●	●
CONCERT	●	●	●	●	● <sup>2)</sup>	●	●
GAME	●	●	●	●	●	●	●
MULTI CH IN	●	●	●	●	●		
PCM96K	●						

<sup>1)</sup> These parameters may not operate depending on the source or adjustments. For details, see each item in "Adjusting the level parameters" (page 29).

<sup>2)</sup> When these sound fields are selected, there is no sound output from the sub woofer if the front speaker size is set to "LARGE". However, sound will be output from the sub woofer if the digital input signal contains L.F.E. signals.

## Free Manuals Download Website

<http://myh66.com>

<http://usermanuals.us>

<http://www.somanuals.com>

<http://www.4manuals.cc>

<http://www.manual-lib.com>

<http://www.404manual.com>

<http://www.luxmanual.com>

<http://aubethermostatmanual.com>

Golf course search by state

<http://golfingnear.com>

Email search by domain

<http://emailbydomain.com>

Auto manuals search

<http://auto.somanuals.com>

TV manuals search

<http://tv.somanuals.com>