

# FM Stereo FM/AM Receiver

Operating Instructions

STR-DH100

©2009 Sony Corporation

## WARNING

### To reduce the risk of fire or electric shock, do not expose this apparatus to rain or moisture.

To reduce the risk of fire, do not cover the ventilation opening of the apparatus with newspapers, tablecloths, curtains, etc. Do not place the naked flame sources such as lighted candles on the apparatus.

To reduce the risk of fire or electric shock, do not expose this apparatus to dripping or splashing, and do not place objects filled with liquids, such as vases, on the apparatus.

Do not install the appliance in a confined space, such as a bookcase or built-in cabinet.

As the main plug is used to disconnect the unit from the mains, connect the unit to an easily accessible AC outlet. Should you notice an abnormality in the unit, disconnect the main plug from the AC outlet immediately.

Do not expose batteries or apparatus with battery-installed to excessive heat such as sunshine, fire or the like.

The unit is not disconnected from the mains as long as it is connected to the AC outlet, even if the unit itself has been turned off.

Excessive sound pressure from earphones and headphones can cause hearing loss.

## For customers in the United States

### Owner's Record

The model and serial numbers are located on the rear of the unit. Record these numbers in the space provided below. Refer to them whenever you call upon your Sony dealer regarding this product.

Model No. \_\_\_\_\_ Serial No. \_\_\_\_\_



This symbol is intended to alert the user to the presence of uninsulated "dangerous voltage" within the product's enclosure that may be of sufficient magnitude to constitute a risk of electric shock to persons.



This symbol is intended to alert the user to the presence of important operating and maintenance (servicing) instructions in the literature accompanying the appliance.

### Important Safety Instructions

- 1) Read these instructions.
- 2) Keep these instructions.
- 3) Heed all warnings.
- 4) Follow all instructions.
- 5) Do not use this apparatus near water.
- 6) Clean only with dry cloth.
- 7) Do not block any ventilation openings. Install in accordance with the manufacturer's instructions.
- 8) Do not install near any heat sources such as radiators, heat registers, stoves, or other apparatus (including amplifiers) that produce heat.
- 9) Do not defeat the safety purpose of the polarized or grounding-type plug. A polarized plug has two blades with one wider than the other. A grounding type plug has two blades and a third grounding prong. The wide blade or the third prong are provided for your safety. If the provided plug does not fit into your outlet, consult an electrician for replacement of the obsolete outlet.
- 10) Protect the power cord from being walked on or pinched particularly at plugs, convenience receptacles, and the point where they exit from the apparatus.
- 11) Only use attachments/accessories specified by the manufacturer.

- 12) Use only with the cart, stand, tripod, bracket, or table specified by the manufacturer, or sold with the apparatus. When a cart is used, use caution when moving the cart/apparatus combination to avoid injury from tip-over.



- 13) Unplug this apparatus during lightning storms or when unused for long periods of time.
- 14) Refer all servicing to qualified service personnel. Servicing is required when the apparatus has been damaged in any way, such as power-supply cord or plug is damaged, liquid has been spilled or objects have fallen into the apparatus, the apparatus has been exposed to rain or moisture, does not operate normally, or has been dropped.

**The following FCC statement applies only to the version of this model manufactured for sale in the U.S.A. Other versions may not comply with FCC technical regulations.**

#### **NOTE:**

This equipment has been tested and found to comply with the limits for a Class B digital device, pursuant to Part 15 of the FCC Rules. These limits are designed to provide reasonable protection against harmful interference in a residential installation.

This equipment generates, uses and can radiate radio frequency energy and, if not installed and used in accordance with the instructions, may cause harmful interference to radio communications. However, there is no guarantee that interference will not occur in a particular installation. If this equipment does cause harmful interference to radio or television reception, which can be determined by turning the equipment off and on, the user is encouraged to try to correct the interference by one or more of the following measures:

- Reorient or relocate the receiving antenna.
- Increase the separation between the equipment and receiver.
- Connect the equipment into an outlet on a circuit different from that to which the receiver is connected.
- Consult the dealer or an experienced radio/TV technician for help.

## **CAUTION**

You are cautioned that any changes or modifications not expressly approved in this manual could void your authority to operate this equipment.

To reduce the risk of electric shock, the speaker cord should be connected to the apparatus and the speakers in accordance with the following instructions.

- 1) Disconnect the AC power cord from the MAINS.
- 2) Strip 10 to 15 mm of the wire insulation of the speaker cord.
- 3) Connect the speaker cord to the apparatus and the speakers carefully so as not to touch the core of speaker cord by hand. Also disconnect the AC power cord from the MAINS before disconnecting the speaker cord from the apparatus and the speakers.

## **For customers in Europe**



**Disposal of Old Electrical & Electronic Equipment (Applicable in the European Union and other European countries with separate collection systems)**

This symbol on the product or on its packaging indicates that this product shall not be treated as household waste. Instead it shall be handed over to the applicable collection point for the recycling of electrical and electronic equipment. By ensuring this product is disposed of correctly, you will help prevent potential negative consequences for the environment and human health, which could otherwise be caused by inappropriate waste handling of this product. The recycling of materials will help to conserve natural resources. For more detailed information about recycling of this product, please contact your local Civic Office, your household waste disposal service or the shop where you purchased the product.



## Disposal of waste batteries (applicable in the European Union and other European countries with separate collection systems)

This symbol on the battery or on the packaging indicates that the battery provided with this product shall not be treated as household waste.

On certain batteries this symbol might be used in combination with a chemical symbol. The chemical symbols for mercury (Hg) or lead (Pb) are added if the battery contains more than 0.0005% mercury or 0.004% lead.

By ensuring these batteries are disposed of correctly, you will help prevent potentially negative consequences for the environment and human health which could otherwise be caused by inappropriate waste handling of the battery. The recycling of the materials will help to conserve natural resources. In case of products that for safety, performance or data integrity reasons require a permanent connection with an incorporated battery, this battery should be replaced by qualified service staff only. To ensure that the battery will be treated properly, hand over the product at end-of-life to the applicable collection point for the recycling of electrical and electronic equipment.

For all other batteries, please view the section on how to remove the battery from the product safely. Hand the battery over to the applicable collection point for the recycling of waste batteries.

For more detailed information about recycling of this product or battery, please contact your local Civic Office, your household waste disposal service or the shop where you purchased the product.

### Notice for customers: The following information is only applicable to equipment sold in the countries applying EU Directives.

The manufacturer of this product is Sony Corporation, 1-7-1 Konan Minato-ku Tokyo, 108-0075 Japan. The Authorized Representative for EMC and product safety is Sony Deutschland GmbH, Hedelfinger Strasse 61, 70327 Stuttgart, Germany. For any service or guarantee matters please refer to the addresses given in separate service or guarantee documents.

## About This Manual

- The instructions in this manual are for model STR-DH100. Check your model number by looking at the lower right corner of the front panel. In this manual, models of area code U is used for illustration purposes unless stated otherwise. Any difference in operation is clearly indicated in the text, for example, "Models of area code U only".
- The instructions in this manual describe the controls on the supplied remote. You can also use the controls on the receiver if they have the same or similar names as those on the remote.

### About area codes

The area code of the receiver you purchased is shown on the lower right portion of the rear panel (see the illustration below).

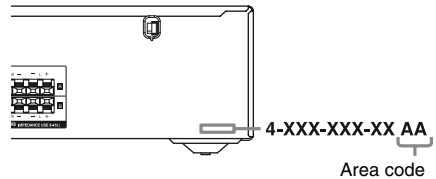

Any differences in operation, according to the area code, are clearly indicated in the text, for example, "Models of area code AA only".

---

# Table of Contents

Description and location of parts ..... 6

---

## Getting Started

1: Installing speakers.....	12
2: Connecting speakers .....	12
3: Connecting the audio/video components .....	13
4: Connecting the antennas (aerials).....	15
5: Preparing the receiver and the remote.....	16
6: Selecting the speaker system .....	17

---

## Playback

Enjoying sound from the component connected to the receiver.....	18
Enjoying sound from the components connected to the DIGITAL MEDIA PORT.....	19

---

## Amplifier Operations

Navigating through menus .....	20
Adjusting the tone .....	21

---

## Tuner Operations

Listening to FM/AM radio.....	21
Presetting radio stations .....	23
Using the Radio Data System (RDS).....	25
(Models of area code CEL, CEK only)	

---

## Other Operations

Changing the display.....	27
Using the Sleep Timer.....	27
Recording using the receiver.....	28

---

## Using the Remote

Changing button assignments .....	28
-----------------------------------	----

---

## Additional Information

Precautions .....	29
Troubleshooting.....	30
Specifications .....	33
Index .....	35

# Description and location of parts

## Front panel

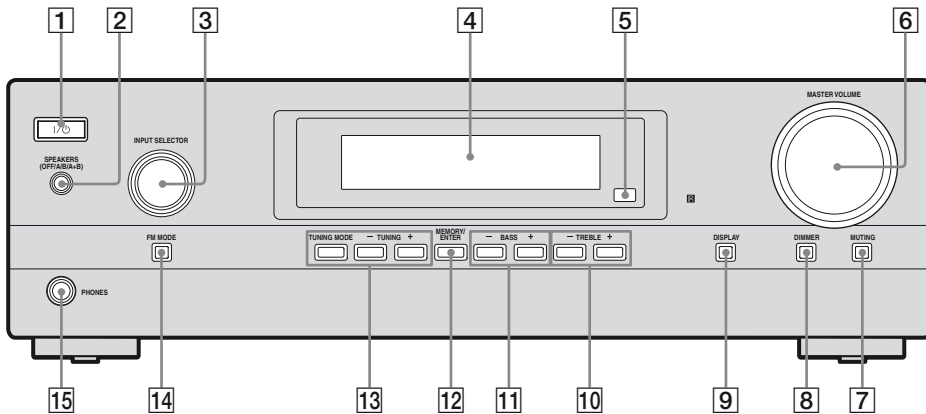

## About the indicators on the display

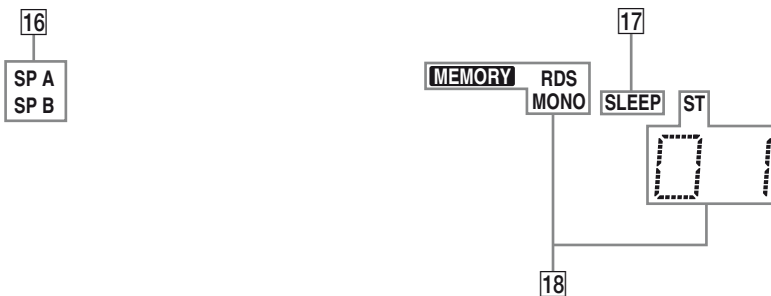

Name	Function
1 I/⏻ (on/standby)	Press to turn the receiver on or off (page 16).
2 <b>SPEAKERS (OFF/A/B/A+B)</b>	Switch to OFF, A, B, A+B of the speakers (page 17).
3 <b>INPUT SELECTOR</b>	Turn to select the input source to play back (page 18, 19, 22, 24, 28).
4 <b>Display</b>	The current status of the selected component or a list of selectable items appears here (page 6).
5 <b>Remote sensor</b>	Receives signals from remote commander.
6 <b>MASTER VOLUME</b>	Turn to adjust the volume level of all speakers at the same time (page 18).
7 <b>MUTING</b>	Press to turn off the sound temporarily. Press <b>MUTING</b> again to restore the sound (page 19).
8 <b>DIMMER</b>	Press repeatedly to adjust the brightness of the display.
9 <b>DISPLAY</b>	Press repeatedly to select information displayed on the display (page 26, 27).
10 <b>TREBLE +/-</b>	Press repeatedly to adjust the treble level of the speakers (page 21).
11 <b>BASS +/-</b>	Press repeatedly to adjust the bass level of the speakers (page 21).
12 <b>MEMORY/ ENTER</b>	Press to store a station or enter the selection when selecting the settings (page 22, 24).
13 <b>TUNING MODE</b> <b>TUNING +/-</b>	Press to operate the tuner (FM/AM) (page 21).
14 <b>FM MODE</b>	Press to select the FM monaural or stereo reception (page 22).
15 <b>PHONES jack</b>	Connects to headphones (page 31).

Name	Function
16 <b>SP A/SP B</b>	Lights up according to the speaker system used (page 17). However, these indicators do not light up if the speaker output is turned off or if headphones are connected.
17 <b>SLEEP</b>	Lights up when the sleep timer is activated (page 27).
18 <b>Tuning indicators</b>	Lights up when using the receiver to tune in radio stations (page 21), etc.
<b>MEMORY</b>	A memory function, such as Preset Memory (page 23), etc., is activated.
<b>RDS</b>	A station that provides RDS service is tuned in. <b>Note</b> "RDS" appears for models of area code CEL, CEK only.
<b>MONO</b>	Monaural broadcast
<b>ST</b>	Stereo broadcast
	A preset station number appears when the preset radio station is selected. <b>Note</b> The preset station number will change according to the preset station you select. For details on presetting radio stations, see page 23.

# Rear panel

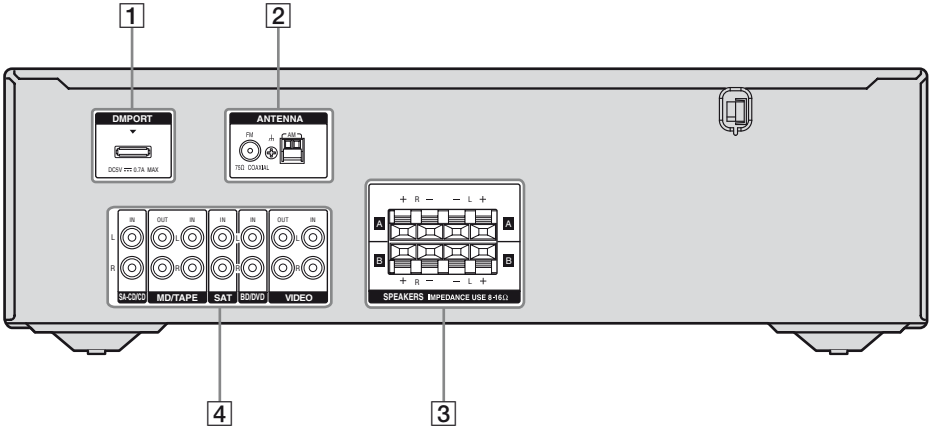

## 1 DMPORT



DMPORT  
jack

Connects to a  
DIGITAL MEDIA  
PORT adapter  
(page 13).

## 4 AUDIO INPUT/OUTPUT section



White (L)  
AUDIO IN/  
OUT jacks

Connects to a Super  
Audio CD player,  
CD player, etc.  
(page 13).

## 2 ANTENNA section



FM  
ANTENNA  
jack

Connects to the FM  
wire antenna  
(aerial) supplied  
with this receiver  
(page 15).



AM  
ANTENNA  
terminals

Connects to the AM  
loop antenna  
(aerial) supplied  
with this receiver  
(page 15).

## 3 SPEAKERS section



Connects to  
speakers (page 12).



## Remote commander

You can use the supplied remote to operate the receiver and to control the Sony audio/video components that the remote is assigned to operate (page 28).

### RM-AAU055

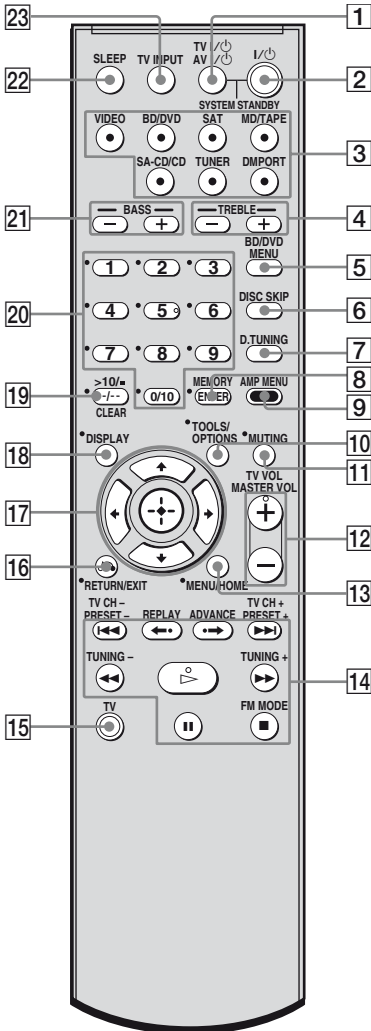











Name	Function
<b>1 TV I/⏻ (on/standby)</b>	Press TV I/⏻ and TV (15) at the same time to turn the TV on or off.
<b>AV I/⏻ (on/standby)</b>	Press to turn on or off the Sony audio/video components that the remote is assigned to operate (page 28). If you press I/⏻ (2) at the same time, it will turn off the receiver and other components (SYSTEM STANDBY). <b>Note</b> The function of the AV I/⏻ switch changes automatically each time you press the input buttons (3).
<b>2 I/⏻ (on/standby)</b>	Press to turn the receiver on or off. To turn off all components, press I/⏻ and AV I/⏻ (1) at the same time (SYSTEM STANDBY).
<b>3 Input buttons</b>	Press one of the buttons to select the component you want to use. When you press any of the input buttons, the receiver turns on. The buttons are factory assigned to control Sony components. You can change the button assignments following the steps in “Changing button assignments” on page 28.
<b>4 TREBLE +/-</b>	Press repeatedly to adjust the treble level of the speakers.
<b>5 BD/DVD MENU</b>	Press to display the menu of the DVD or Blu-ray disc on the TV screen. Then, use ⬆, ⬇, ⬅, ➡ and ⊕ (17) to perform menu operations.
<b>6 DISC SKIP</b>	Press to skip a disc when using a multi-disc changer.
<b>7 D.TUNING</b>	Press to enter direct tuning mode.

continued

9GB

Name	Function
<b>8 MEMORY</b>	Press to store a station during tuner operation.
<b>ENTER</b>	Press to enter the value after selecting a channel, disc or track using the numeric buttons of the TV, VCR, CD player, DVD recorder, DVD player or satellite tuner.
<b>9 AMP MENU</b>	Press to display the menu of the receiver. Then, use <b>↑</b> , <b>↓</b> , <b>←</b> , <b>→</b> and <b>⊕</b> ( <b>17</b> ) to perform menu operations.
<b>10 TOOLS/OPTIONS</b>	Press to display and select items from option menus of the DVD player or Blu-ray disc player. Press TOOLS/OPTIONS and TV ( <b>15</b> ) at the same time to display options applicable to the Sony TV.
<b>11 MUTING</b>	Press to turn off the sound temporarily. Press MUTING again to restore the sound. Press MUTING and TV ( <b>15</b> ) at the same time to activate the TV's muting function.
<b>12 TV VOL +<sup>a</sup>/-</b>	Press TV VOL +/- and TV ( <b>15</b> ) at the same time to adjust the TV volume level.
<b>MASTER VOL +<sup>a</sup>/-</b>	Press to adjust the volume level of all speakers at the same time.
<b>13 MENU/HOME</b>	Press to display the menu used to operate audio/video components. Press MENU/HOME and TV ( <b>15</b> ) at the same time to display the TV's menu. Then, use <b>↑</b> , <b>↓</b> , <b>←</b> , <b>→</b> and <b>⊕</b> ( <b>17</b> ) to perform menu operations.
<b>14</b> <b>⏮/⏭<sup>b</sup></b>	Press to skip a track of the CD player, DVD player, DVD recorder, MD deck, tape deck or Blu-ray disc player.
<b>REPLAY</b> <b>⏮/</b> <b>ADVANCE</b> <b>⏭</b>	Press to replay the previous scene or fast forward the current scene of the VCR, DVD player or Blu-ray disc player.

Name	Function
<b>⏮/⏭<sup>b</sup></b>	Press to – search tracks in the forward/reverse direction of the DVD player. – start fast forward/rewind of the VCR, CD player, DVD recorder, MD deck, tape deck or Blu-ray disc player.
<b>▶<sup>a</sup>/b)</b>	Press to start playback of the VCR, CD player, DVD player, DVD recorder, MD deck or Blu-ray disc player.
<b>⏸<sup>b</sup></b>	Press to pause playback or recording of the VCR, CD player, DVD player, DVD recorder, MD deck, tape deck or Blu-ray disc player. (Also starts recording with components in recording standby.)
<b>■<sup>b</sup></b>	Press to stop playback of the VCR, CD player, DVD player, DVD recorder, MD deck, tape deck or Blu-ray disc player.
<b>FM MODE</b>	Press to select the FM monaural or stereo reception.
<b>TV CH +/-</b>	Press TV CH +/- and TV ( <b>15</b> ) at the same time to select preset TV channels.
<b>PRESET +/-</b>	Press to select – preset stations. – preset channels of the VCR or satellite tuner.
<b>TUNING +/-</b>	Press to scan a station.
<b>15 TV</b>	Press TV and the button with orange printing at the same time to enable TV operation.

Name	Function
<b>16</b> RETURN/ EXIT 	Press to – return to the previous menu. – exit the menu while the menu or on-screen guide of the DVD recorder, DVD player, satellite tuner or Blu-ray disc player is displayed on the TV screen. Press RETURN/EXIT  and TV (15) at the same time to return to the previous menu or exit the TV's menu while the menu is displayed on the TV screen.
<b>17</b>  , 	After pressing BD/DVD MENU (5), AMP MENU (9) or MENU/HOME (13), press  ,  ,  or  to select the settings. Then, press  to enter the selection if you have pressed BD/DVD MENU or MENU/HOME previously. Press  also to enter the selection of the receiver, VCR, satellite tuner, CD player, DVD player, DVD recorder or Blu-ray disc player.
<b>18</b> DISPLAY	Press to select information displayed on the TV screen of the VCR, satellite tuner, CD player, DVD player, DVD recorder, MD deck or Blu-ray disc player. Press DISPLAY and TV (15) at the same time to display TV's information on the TV screen.
<b>19</b> -/--	Press to select the channel entry mode, either one or two digit of the VCR. Press -/-- and TV (15) at the same time to select the channel entry mode, either one or two digits of the TV.
<b>&gt;10/-</b>	Press to select – track numbers over 10 of the VCR, satellite tuner, MD deck or CD player. – channel numbers of the Digital CATV terminal.
<b>CLEAR</b>	Press to clear a mistake when you press the incorrect numeric button.

Name	Function
<b>20</b> Numeric buttons (number 5 <sup>a)</sup> )	Press to – preset/tune to preset stations. – select track numbers of the CD player, DVD player, DVD recorder, MD deck or Blu-ray disc player. Press 0/10 to select track number 10. – select channel numbers of the VCR or satellite tuner. Press the numeric buttons and TV (15) at the same time to select the TV channels.
<b>21</b> BASS +/-	Press repeatedly to adjust the bass level of the speakers.
<b>22</b> SLEEP	Press to activate the Sleep Timer function and the duration which the receiver turns off automatically.
<b>23</b> TV INPUT	Press TV INPUT and TV (15) at the same time to select the input signal (TV input or video input).

<sup>a)</sup>The number 5, MASTER VOL +, TV VOL +, and  buttons have tactile dots. Use the tactile dots as references when operating the receiver.

<sup>b)</sup>This button is also available for DIGITAL MEDIA PORT adapter operation. For details on the function of the button, see the operating instructions supplied with the DIGITAL MEDIA PORT adapter.

## Notes

- Some functions explained in this section may not work depending on the model.
- The above explanation is intended to serve as an example only. Therefore, depending on the component, the above operation may not be possible or may operate differently than described.

## Getting Started

# 1: Installing speakers

This receiver allows you to use a 2.0 channel system.

## Example of the speaker system configuration

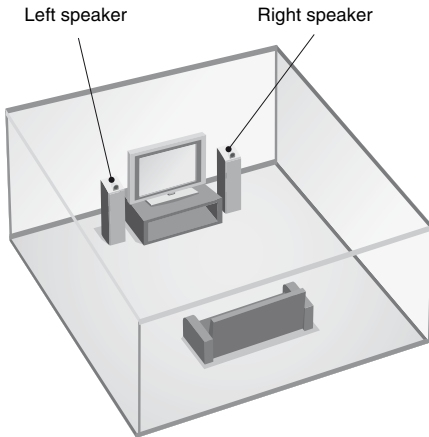

# 2: Connecting speakers

Before connecting cords, make sure to disconnect the AC power cord (mains lead).

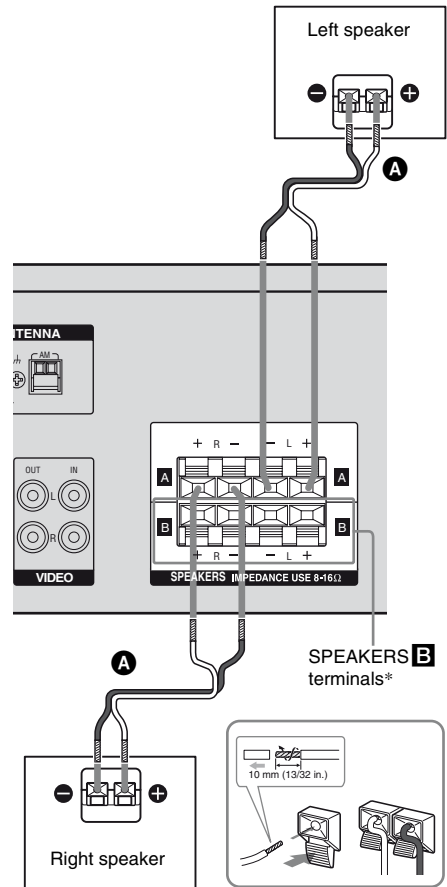

### **A** Speaker cords (not supplied)

\* If you have an additional speaker system, connect them to the **SPEAKERS B** terminals. You can select the speakers you want to use with the **SPEAKERS** (OFF/A/B/A+B) button on the receiver (page 17).

## 3: Connecting the audio/video components

### How to connect your components

This section describes how to connect your components to this receiver. Before you begin, refer to “Component to be connected” below for the pages which describe how to connect the audio/video components.

After connect all your components, proceed to “4: Connecting the antennas (aerials)” (page 15).

Component to be connected	See
Audio components	page 13
<ul style="list-style-type: none"> <li>• Super Audio CD player, CD player</li> <li>• MD deck, Tape deck</li> <li>• DIGITAL MEDIA PORT adapter</li> </ul>	
Video components	page 14
<ul style="list-style-type: none"> <li>• DVD player, Blu-ray disc player</li> <li>• Satellite tuner, Set-top box</li> <li>• DVD recorder, VCR</li> </ul>	

### Connecting audio components

The following illustration shows how to connect a Super Audio CD, CD player, MD deck, tape deck and DIGITAL MEDIA PORT adapter.

You can also view the images on the TV screen by connecting the video output of the DIGITAL MEDIA PORT adapter to the video input of the TV. However, depending on the DIGITAL MEDIA PORT adapter, video output may not be possible.

Before connecting cords, make sure to disconnect the AC power cord (mains lead).

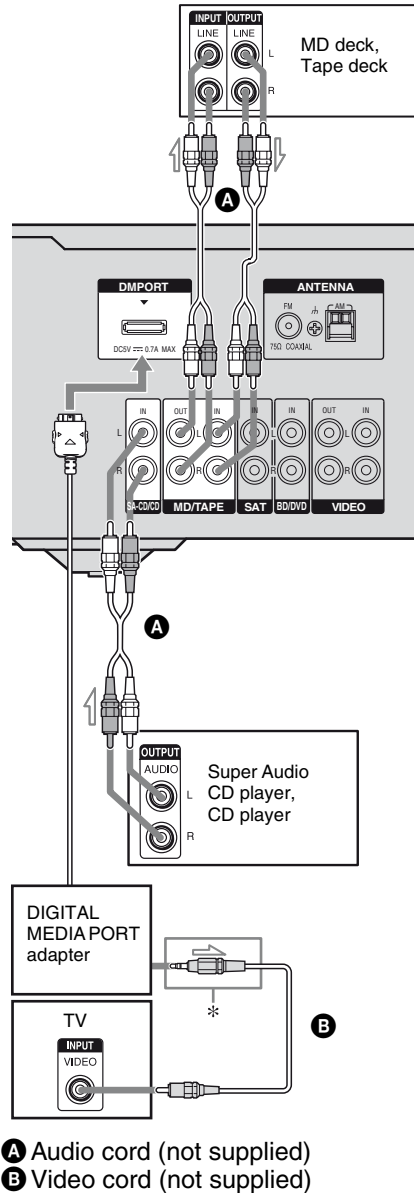

- A** Audio cord (not supplied)
- B** Video cord (not supplied)

\* The type of connector varies depending on the DIGITAL MEDIA PORT adapter.

For details, refer to the operating instructions supplied with the DIGITAL MEDIA PORT adapter.

continued

## Notes on connecting DIGITAL MEDIA PORT adapter

- When connecting the DIGITAL MEDIA PORT adapter, be sure the connector is inserted with the arrow mark facing towards the arrow mark on the DMPORT jack.
- Be sure to make DMPORT connections firmly, insert the connector straight in.
- As the connector of the DIGITAL MEDIA PORT adapter is fragile, be sure to handle with care when placing or moving the receiver.
- To disconnect the DIGITAL MEDIA PORT adapter, squeeze the sides of the connector, since the connector is locked in place.

## Connecting video components

The following illustration shows how to connect video components such as DVD player, Blu-ray disc player, satellite tuner, Set-top box, DVD recorder and VCR. Before connecting the cords, be sure to disconnect the AC power cord (mains lead).

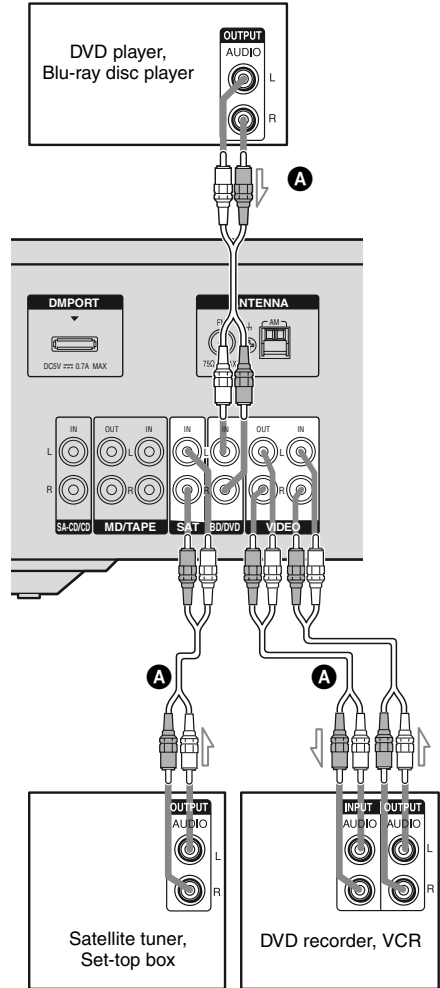

**A** Audio cord (not supplied)

## If you connect a DVD player

- Be sure to change the factory setting of the BD/DVD input button on the remote so that you can use the button to control your DVD player. For details, see “Changing button assignments” (page 28).
- You can also rename the BD/DVD input so that it can be displayed on the receiver’s display. For details, see “Naming inputs” (page 19).

## If you connect a DVD recorder

- Be sure to change the factory setting of the VIDEO input button on the remote so that you can use the button to control your DVD recorder. For details, see “Changing button assignments” (page 28).
- You can also rename the VIDEO input so that it can be displayed on the receiver’s display. For details, see “Naming inputs” (page 19).

## Notes

- You can record the audio signals of the components connected to this receiver. For example, connect a recording component such as a tape deck to the VIDEO AUDIO OUT jacks and press the input buttons (DMPORT, BD/DVD, SAT, SA-CD/CD, MD/TAPE, TUNER) to select the component to be recorded.
- Be sure to connect the video output of the video component to the TV, so that the image is displayed on the TV. However, you cannot do video recording via this receiver. Refer to the operating instructions of each connected component for details.

## Tip

To output the sound of the TV from the speakers connected to the receiver, be sure to turn off the TV’s volume or activate the TV’s muting function.

# 4: Connecting the antennas (aerials)

Connect the supplied AM loop antenna (aerial) and FM wire antenna (aerial). Before connecting the antennas, make sure to disconnect the AC power cord (mains lead).

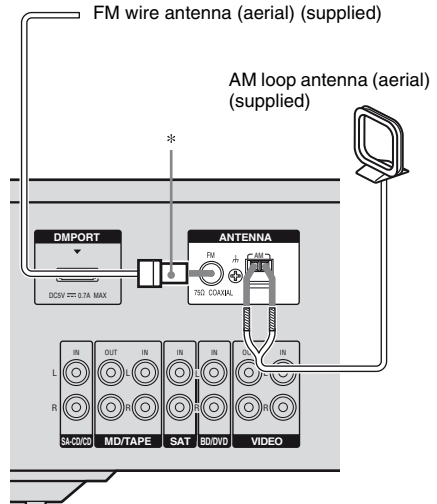

\* The shape of the connector varies depending on the area code of this receiver.

## Notes

- To prevent noise pickup, keep the AM loop antenna (aerial) away from the receiver and other components.
- Be sure to fully extend the FM wire antenna (aerial).
- After connecting the FM wire antenna (aerial), keep it as horizontal as possible.

## 5: Preparing the receiver and the remote

### Connecting the AC power cord (mains lead)

Connect the AC power cord (mains lead) to a wall outlet.

#### Notes

- Before connecting the AC power cord (mains lead), make sure that the metallic wires of the speaker cords are not touching each other between the SPEAKERS terminals.
- Connect the AC power cord (mains lead) firmly.

AC power cord (mains lead)

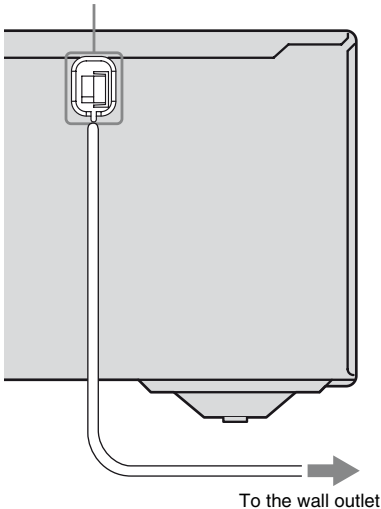

### Performing initial setup operations

Before using the receiver for the first time, initialize the receiver by performing the following procedure. This procedure can also be used to return settings you have made to their factory defaults.

Be sure to use the buttons on the receiver for this operation.

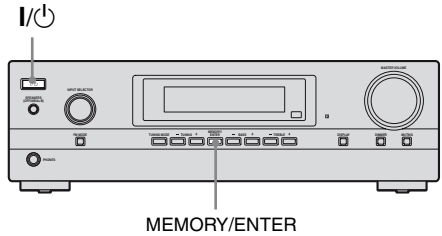

- 1 Press I/⏻ to turn off the receiver.**
- 2 Hold down I/⏻ for 5 seconds.**  
“PUSH” and “ENTER” appears on the display alternately.
- 3 Press MEMORY/ENTER.**

After “CLEARING” appears on the display for a while, “CLEARED” appears.

All the settings you have changed or adjusted are reset to the initial settings.



## Inserting batteries into the remote

Insert two R6 (size-AA) batteries in the RM-AAU055 Remote Commander. Observe the correct polarity when installing batteries.

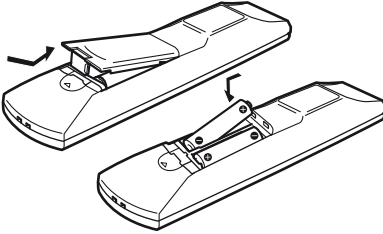

### Notes

- Do not leave the remote in an extremely hot or humid place.
- Do not use a new battery with old ones.
- Do not mix manganese batteries and other kinds of batteries.
- Do not expose the remote sensor to direct sunlight or lighting apparatuses. Doing so may cause a malfunction.
- If you do not intend to use the remote for an extended period of time, remove the batteries to avoid possible damage from battery leakage and corrosion.
- When you replace the batteries, the remote buttons may be reset to their factory settings. If this happens, reassign the buttons again (page 28).
- When the remote no longer operates the receiver, replace all the batteries with new ones.

## 6: Selecting the speaker system

You can select the speakers you want to drive, if you have connected the speakers to SPEAKERS **A** and **B** terminals. Be sure to use the buttons on the receiver for this operation.

SPEAKERS (OFF/A/B/A+B)

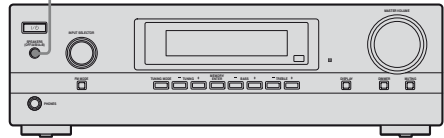

**Press SPEAKERS (OFF/A/B/A+B) repeatedly to select the speaker system you want to drive.**

To select	Light up
The speakers connected to the SPEAKERS <b>A</b> terminals	SP A
The speakers connected to the SPEAKERS <b>B</b> terminals	SP B
The speakers connected to both the SPEAKERS <b>A</b> and <b>B</b> terminals (parallel connection)	SP A SP B

### To turn off the speaker output

Press SPEAKERS (OFF/A/B/A+B) repeatedly until the “SP A” and “SP B” indicators on the display do not light up.

### Note

You cannot switch the speaker system by pressing SPEAKERS (OFF/A/B/A+B) when the headphones are connected.

## Playback

# Enjoying sound from the component connected to the receiver

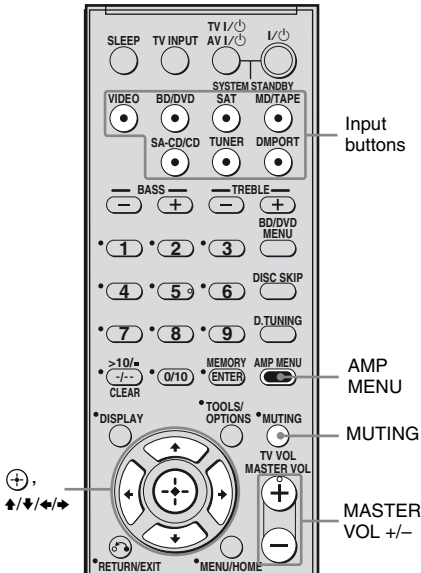

## 1 Press the input button to select a component.

You can also use INPUT SELECTOR on the receiver.

The selected input appears on the display.

Selected input [Display]	Components that can be played back
VIDEO [VIDEO]	VCR, etc., connected to the VIDEO jack
BD/DVD [BD/DVD]	Blu-ray disc player, etc., connected to the BD/DVD jack
SAT [SAT]	Satellite tuner, etc., connected to the SAT jack
MD/TAPE [MD/TAPE]	MD deck, tape deck, etc., connected to MD/TAPE jack
SA-CD/CD [SA-CD/CD]	Super Audio CD, CD player, etc., connected to the SA-CD/CD jack
TUNER [FM or AM band]	Built-in radio tuner
DMPORT [DMPORT]	DIGITAL MEDIA PORT adapter connected to DMPORT jack

## 2 Turn on the component and start playback.

## 3 Press MASTER VOL +/- to adjust the volume.

You can also use MASTER VOLUME on the receiver.

### Tips

- You can adjust the volume differently depending on the speed with which you turn the MASTER VOLUME on the receiver.
  - To turn the volume up or down quickly: turn the knob quickly.
  - To make fine adjustment: turn the knob slowly.
- You can adjust the volume differently depending on the length of time you press and hold the MASTER VOL +/- button on the remote.
  - To turn the volume up or down quickly: press and hold the button.
  - To make a fine adjustment: press the button and release it immediately.

## To avoid damaging your speakers

Before you turn off the receiver, be sure to turn down the volume level.

## To activate the muting function

Press MUTING.

The muting function will be canceled when you do the following.

- Press MUTING again.
- Increase the volume.
- Turn off the receiver.

## Naming inputs

You can enter a name of up to 8 characters for inputs and display it on the receiver's display. This is convenient for labeling the jacks with the names of the connected components.

### 1 Press the input button to select the input you want to create an index name for.

You can also use INPUT SELECTOR on the receiver.

### 2 Press AMP MENU.

"BALANCE" appears on the display.

### 3 Press $\uparrow/\downarrow$ repeatedly to select "NAME IN", then press $\odot$ or $\rightarrow$ .

The cursor flashes and you can select a character.

### 4 Press $\uparrow/\downarrow$ to select a character, then press $\leftarrow/\rightarrow$ to move the cursor to the next position.

#### If you made a mistake

Press  $\leftarrow/\rightarrow$  until the character you want to change flashes, then press  $\uparrow/\downarrow$  to select the correct character.

#### Tips

- You can select the character type as follows by pressing  $\uparrow/\downarrow$ .  
Alphabet (upper case)  $\rightarrow$  Numbers  $\rightarrow$  Symbols
- To enter a blank space, press  $\rightarrow$  without selecting a character.

### 5 Press $\odot$ .

The name you entered is registered.

## Enjoying sound from the components connected to the DIGITAL MEDIA PORT

The DIGITAL MEDIA PORT (DMPORT) allows you to enjoy sound from a portable audio source or computer by connecting a DIGITAL MEDIA PORT adapter.

The DIGITAL MEDIA PORT adapters are available for purchase depending on the area. For details on connecting the DIGITAL MEDIA PORT adapter, see "Connecting audio components" (page 13).

#### Notes

- Do not connect an adapter other than the DIGITAL MEDIA PORT adapter.
- Before connecting cords, make sure to disconnect the AC power cord (mains lead).
- Do not connect or disconnect the DIGITAL MEDIA PORT adapter while the receiver is turned on.
- Depending on the DIGITAL MEDIA PORT adapter, video output may not be possible.
- Depending on the type of DIGITAL MEDIA PORT adapter, you can operate the connected component by using the remote. For details on the remote button operation, see page 9.
- Be sure you have made the video connection from DIGITAL MEDIA PORT adapter to the TV (page 13).

### 1 Press DMPORT.

You can also use the INPUT SELECTOR on the receiver to select "DMPORT".

### 2 Start playback of the connected component.

The sound is played back on the receiver and the image appears on the TV. For details, refer to the operating instructions supplied with the DIGITAL MEDIA PORT adapter.

## Amplifier Operations

### Navigating through menus

By using the amplifier menus, you can make various adjustments to customize the receiver.

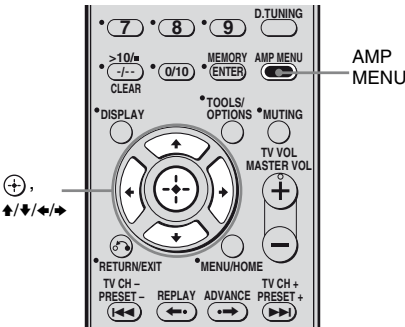

#### 1 Press AMP MENU.

“BALANCE” appears on the display.

#### 2 Press or to enter the parameter.

#### 3 Press / repeatedly to select the setting you want.

The setting is entered automatically.

#### To return to the previous display

Press .

#### To exit the menu

Press AMP MENU.

#### Note

Some parameters and settings may appear dimmed on the display. This means that they are either unavailable or fixed and unchangeable.

## Overview of the setup parameters

### ■ BALANCE (Speaker balance)

Lets you adjust the balance between left and right speakers.

You can adjust from BAL. L+10 to BAL. R+10 in 1 step.

The initial setting is BAL. 0.

### ■ NAME IN (Naming)

Lets you set the name of inputs and preset stations. For details, see “Naming inputs” (page 19) and see “Naming preset stations” (page 24).

### ■ DIMMER (Brightness of the display)

Lets you adjust the brightness in 3 steps: 0% dim, 40% dim, 70% dim

The initial setting is 0% dim.

#### Tip

You can also press DIMMER repeatedly on the receiver to adjust the brightness of the display.

# Adjusting the tone

You can adjust the tonal quality of the speakers.

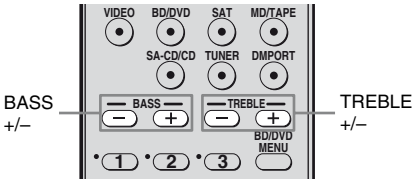

**Press TREBLE + or TREBLE – repeatedly to adjust the treble level.**

**Press BASS + or BASS – repeatedly to adjust the bass level.**

You can adjust from -10 dB to +10 dB in 1 dB step.

The initial setting is 0 dB.

# Tuner Operations

## Listening to FM/AM radio

You can listen to FM and AM broadcasts through the built-in tuner. Before operation, make sure you have connected the FM and AM antennas (aerials) to the receiver (page 15).

### Tip

The tuning scale for direct tuning differs depending on the area code as shown in the following table. For details on area codes, see page 4.

Area code	FM	AM
U, CA	100 kHz	10 kHz*
CEL, CEK	50 kHz	9 kHz

\* The AM tuning scale can be changed (page 23).

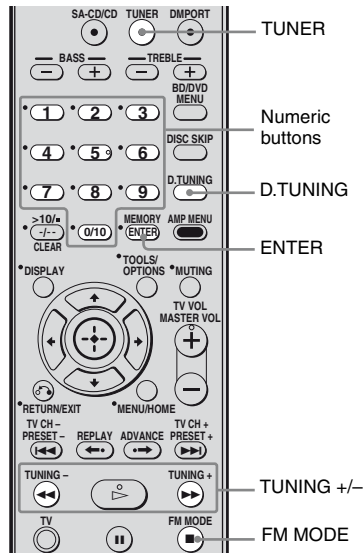

## Tuning into a station automatically (Auto Tuning)

- 1 Press TUNER repeatedly to select the FM or AM band.**
- 2 Press TUNING + or TUNING –.**  
Press TUNING + to scan from low to high; press TUNING – to scan from high to low.  
The receiver stops scanning whenever a station is received.

### Using the controls on the receiver

- 1** Turn INPUT SELECTOR to select the FM or AM band.
- 2** Press TUNING MODE repeatedly to select “AUTO T”.
- 3** Press TUNING + or TUNING –.

### In case of poor FM stereo reception

If the FM stereo reception is poor and “ST” flashes on the display, select monaural audio so that the sound will be less distorted. Press FM MODE repeatedly until the “MONO” indicator lights up on the display. To return to stereo mode, press FM MODE repeatedly until the “MONO” indicator on the display does not light up.

## Tuning into a station directly (Direct tuning)

You can enter the frequency of a station directly by using the numeric buttons.

- 1 Press TUNER repeatedly to select the FM or AM band.**  
You can also use INPUT SELECTOR on the receiver.
- 2 Press D.TUNING.**
- 3 Press the numeric buttons to enter the frequency.**  
Example 1: FM 102.50 MHz  
Select 1 → 0 → 2 → 5 → 0  
Example 2: AM 1,350 kHz  
Select 1 → 3 → 5 → 0
- 4 Press ENTER.**

You can also use MEMORY/ENTER on the receiver.

#### Tip

If you have tuned in an AM station, adjust the direction of the AM loop antenna (aerial) for optimum reception.

### If you cannot tune in a station

Make sure you have entered the right frequency. If not, repeat steps 2 to 4. If you still cannot tune in a station, the frequency is not used in your area.

## Changing the AM tuning scale

(Models of area code U, CA only)

You can change the AM tuning scale to either 9 kHz or 10 kHz using the buttons on the receiver.

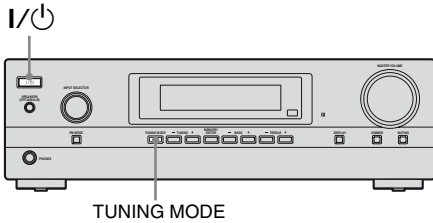

- 1 Press I/⏻ to turn off the receiver.
- 2 While holding down TUNING MODE, press I/⏻.
- 3 Change the current AM tuning scale to 9 kHz (or 10 kHz).

To reset the scale to 10 kHz (or 9 kHz), repeat the procedure above.

### Note

All preset stations will be erased when you change the tuning scale.

## Presetting radio stations

You can preset up to 30 FM stations and 30 AM stations. Then you can easily tune in the stations you often listen to.

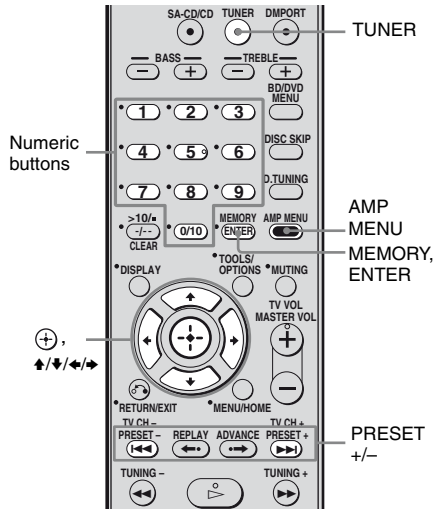

Tuner Operations

- 1 Press TUNER repeatedly to select the FM or AM band.  
You can also use INPUT SELECTOR on the receiver.
- 2 Tune in the station that you want to preset using Auto Tuning (page 22) or Direct Tuning (page 22).  
Switch the FM reception mode, if necessary (page 22).
- 3 Press MEMORY.  
You can also use MEMORY/ENTER on the receiver.  
“MEMORY” lights up for a few seconds. Perform steps 4 and 5 before “MEMORY” goes out.

continued

#### 4 Press the numeric buttons to select a preset number.

You can also press PRESET + or PRESET – repeatedly to select a preset number.

If “MEMORY” goes out before you select the preset number, start again from step 3.

#### 5 Press ENTER.

You can also use MEMORY/ENTER on the receiver.

The station is stored as the selected preset number.

If “MEMORY” goes out before you press ENTER, start again from step 3.

#### 6 Repeat steps 1 to 5 to preset another station.

### Tuning to preset stations

#### 1 Press TUNER repeatedly to select the FM or AM band.

#### 2 Press PRESET + or PRESET – repeatedly to select the preset station you want.

Each time you press the button, you can select a preset station as follows:

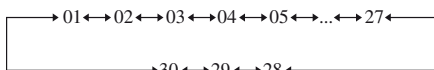

You can also press the numeric buttons to select the preset station you want. Then, press ENTER to enter the selection.

### Using the controls on the receiver

- 1 Turn INPUT SELECTOR to select the FM or AM band.
- 2 Press TUNING MODE repeatedly to select “PRESET T.”.
- 3 Press TUNING + or TUNING – repeatedly to select the preset station you want.

### Naming preset stations

#### 1 Press TUNER repeatedly to select the FM or AM band.

You can also use INPUT SELECTOR on the receiver.

#### 2 Tune in the preset station you want to create an index name for (page 24).

#### 3 Press AMP MENU.

“BALANCE” appears on the display.

#### 4 Press ↑/↓ repeatedly to select “NAME IN”, then press ⊕ or →.

The cursor flashes and you can select a character.

#### 5 Press ↑/↓ to select a character, then press ←/→ to move the cursor to the next position.

#### If you made a mistake

Press ←/→ until the character you want to change flashes, then press ↑/↓ to select the correct character.

#### Tips

- You can select the character type as follows by pressing ↑/↓.  
Alphabet (upper case) → Numbers → Symbols
- To enter a blank space, press → without selecting a character.

#### 6 Press ⊕.

The name you entered is registered.



**Note (Models of area code CEL, CEK only)**

When you name an RDS station and tune in that station, the Program Service name appears instead of the name you entered. (You cannot change the Program Service name. The name you entered will be overwritten by the Program Service name.)

## Using the Radio Data System (RDS)

**(Models of area code CEL, CEK only)**

This receiver also allows you to use RDS (Radio Data System), which enables radio stations to send additional information along with the regular program signal. You can display RDS information.

**Notes**

- RDS is operable only for FM stations.
- Not all FM stations provide RDS service, nor do they provide the same type of services. If you are not familiar with the RDS services in your area, check with your local radio stations for details.

### Receiving RDS broadcasts

**Simply select a station on the FM band using direct tuning (page 22), auto tuning (page 22), or preset tuning (page 24).**

When you tune in a station that provides RDS services, "RDS" lights up and the program service name appears on the display.

**Note**

RDS may not work properly if the station you tuned to is not transmitting the RDS signal properly or if the signal strength is weak.

## Displaying RDS information

**While receiving an RDS station, press DISPLAY repeatedly on the receiver.**

Each time you press the button, RDS information on the display changes cyclically as follows:

Program Service name → Frequency → Program Type indication<sup>a)</sup> → Radio Text indication<sup>b)</sup> → Current Time indication (in 24-hour system mode) → Volume level

<sup>a)</sup>Type of program being broadcast.

<sup>b)</sup>Text messages sent by the RDS station.

### Notes

- If there is an emergency announcement by government authorities, "ALARM" flashes in the display.
- When the message consists of 9 characters or more, the message scrolls across the display.
- If a station does not provide a particular RDS service, "NO XXXX" (such as "NO TEXT") appears on the display.

## Description of program types

Program type indication	Description
NEWS	News programs
AFFAIRS	Topical programs that expand on current news
INFO	Programs offering information on a wide spectrum of subjects, including consumer affairs and medical advice
SPORT	Sports programs
EDUCATE	Educational programs, such as "how-to" and advice programs
DRAMA	Radio plays and serials
CULTURE	Programs about national or regional culture, such as language and social concerns
SCIENCE	Programs about the natural sciences and technology

Program type indication	Description
VARIED	Other types of programs such as celebrity interviews, panel games, and comedy
POP M	Popular music programs
ROCK M	Rock music programs
EASY M	Easy Listening
LIGHT M	Instrumental, vocal, and choral music
CLASSICS	Performances of major orchestras, chamber music, opera, etc.
OTHER M	Music that does not fit into any categories above, such as Rhythm & Blues and Reggae
WEATHER	Weather information
FINANCE	Stock market reports and trading, etc.
CHILDREN	Programs for children
SOCIAL	Programs about people and the things that affect them
RELIGION	Programs of religious content
PHONE IN	Programs where members of the public express their views by phone or in a public forum
TRAVEL	Programs about travel. Not for announcements that are located by TP/TA.
LEISURE	Programs on recreational activities such as gardening, fishing, cooking, etc.
JAZZ	Jazz programs
COUNTRY	Country music programs
NATION M	Programs featuring the popular music of the country or region
OLDIES	Programs featuring oldies music
FOLK M	Folk music programs
DOCUMENT	Investigative features
NONE	Any programs not defined above

### Changing the display

You can check the volume level, etc., by changing the information on the display. Be sure to use the buttons on the receiver for this operation.

#### **Press DISPLAY repeatedly.**

Each time you press the button, the display changes cyclically as follows.

#### **All inputs except the FM and AM band**

Index name of the input<sup>a)</sup> → Selected input  
→ Volume level

#### **FM and AM band**

Program Service name<sup>b)</sup> or preset station name<sup>a)</sup> → Frequency → Program Type indication<sup>b)</sup> → Radio Text indication<sup>b)</sup> → Current Time indication (in 24-hour system mode)<sup>b)</sup> → Volume level

<sup>a)</sup> Index name appears only when you have assigned one to the input or preset station (page 19, 24).

Index name does not appear when only blank spaces have been entered, or it is the same as the input name.

<sup>b)</sup> During RDS reception only (models of area code CEL, CEK only) (page 25).

#### **Note**

Character or marks may not be displayed for some languages.

### Using the Sleep Timer

You can set the receiver to turn off automatically at a specified time.

#### **Press SLEEP repeatedly while the power is on.**

Each time you press the button, the display changes cyclically as follows:

2-00-00 → 1-30-00 → 1-00-00 → 0-30-00  
→ OFF

When Sleep Timer is being used, “SLEEP” lights up on the display.

#### **Tip**

To check the remaining time before the receiver turns off, press SLEEP. The remaining time appears on the display. If you press SLEEP again, the sleep timer will be canceled.

## Recording using the receiver

You can record onto a MiniDisc, audio tape, video tape, etc. using the receiver. You can also add audio from a variety of audio sources when editing a video tape. See the operating instructions supplied with your recording component.

### **1 Press one of the input buttons to select the playback component.**

You can also use INPUT SELECTOR on the receiver.

### **2 Prepare the playback component for playing.**

For example, insert a CD into the CD player.

### **3 Prepare the recording component.**

Insert a blank MD or tape into the recording component.

### **4 Start recording on the recording component, then start playback on the playback component.**

#### **Notes**

- Sound adjustments do not affect the signal output from the MD/TAPE OUT jacks.
- Some sources contain copy guards to prevent recording. In this case, you may not be able to record from the source.

#### **Tip**

You can record the sound from any audio source onto a video tape while copying from a video tape. Locate the point where you want to start recording from another audio source, select the program source, then start playback. The audio from that source will be recorded onto the audio track of the video tape instead of the audio from the original medium. To resume audio recording from the original medium, select the video source again.

## Using the Remote

### Changing button assignments

You can change the factory settings of the input buttons to suit the components in your system. For example, if you connect a DVD recorder to the VIDEO jacks on the receiver, you can set the VIDEO button on this remote to control the DVD recorder.

#### **Note**

You cannot change the settings of TUNER and DMPORT buttons.

### **1 Hold down the input button of which you want to change the assignment.**

Example: Hold down VIDEO.

### **2 Referring to the table below, press the corresponding button for the category you want.**

Example: Press 3.

Now you can use the VIDEO button to control the DVD recorder.

## Categories and the corresponding buttons

Categories	Press
VCR (command mode VTR 3)	1
DVD player/DVD recorder (command mode DVD1) <sup>a)</sup>	2
DVD recorder (command mode DVD3) <sup>a)</sup>	3
CD player	4
Euro Digital Satellite Receiver	5
DVR (Digital CATV terminal)	6
DSS (Digital Satellite Receiver)	7
Blu-ray disc player (command mode BD1) <sup>b)</sup>	8
Blu-ray disc recorder (command mode BD3) <sup>b)</sup>	9
MD deck	0/10
Tape deck	-/--

<sup>a)</sup> Sony DVD recorders are operated with a DVD1 or DVD3 setting. For details, refer to the operating instructions supplied with the DVD recorders.

<sup>b)</sup> For details on the BD1 or BD3 setting, refer to the operating instructions supplied with the Blu-ray disc player or Blu-ray disc recorder.

## To clear all remote button assignments

While holding down MASTER VOL  $\leftarrow$ , press I/⏻ and TV INPUT.

The remote is reset to its factory settings.

## Additional Information

### Precautions

#### On safety

Should any solid object or liquid fall into the cabinet, unplug the receiver and have it checked by qualified personnel before operating it any further.

#### On power sources

- Before operating the receiver, check that the operating voltage is identical with your local power supply.  
The operating voltage is indicated on the nameplate on the back of the receiver.
- The unit is not disconnected from the AC power source (mains) as long as it is connected to the wall outlet, even if the unit itself has been turned off.
- If you are not going to use the receiver for a long time, be sure to disconnect the receiver from the wall outlet. To disconnect the AC power cord (mains lead), grasp the plug itself; never pull the cord.
- (Models of area code U, CA only)  
One blade of the plug is wider than the other for the purpose of safety and will fit into the wall outlet only one way. If you are unable to insert the plug fully into the outlet, contact your dealer.
- The AC power cord (mains lead) must be changed only at a qualified service shop.

#### On heat buildup

Although the receiver heats up during operation, this is not a malfunction. If you continuously use this receiver at a large volume, the cabinet temperature of the top, side and bottom rises considerably. To avoid burning yourself, do not touch the cabinet.

## On placement

- Place the receiver in a location with adequate ventilation to prevent heat buildup and prolong the life of the receiver.
- Do not place the receiver near heat sources, or in a place subject to direct sunlight, excessive dust, or mechanical shock.
- Do not place anything on top of the cabinet that might block the ventilation holes and cause malfunctions.
- Do not place the receiver near equipment such as a television, VCR, or tape deck. If the receiver is being used in combination with a television, VCR, or tape deck, and is placed too close to that equipment, noise may result, and picture quality may suffer. This is especially likely when using an indoor antenna (aerial). Therefore, we recommend using an outdoor antenna (aerial).
- Use caution when placing the receiver on surfaces that have been specially treated (with wax, oil, polish, etc.) as staining or discoloration of the surface may result.

## On operation

Before connecting other components, be sure to turn off and unplug the receiver.

## On cleaning

Clean the cabinet, panel, and controls with a soft cloth slightly moistened with a mild detergent solution. Do not use any type of abrasive pad, scouring powder, or solvent, such as alcohol or benzene.

If you have any questions or problems concerning your receiver, please consult your nearest Sony dealer.

# Troubleshooting

If you experience any of the following difficulties while using the receiver, use this troubleshooting guide to help you remedy the problem.

## Audio

**There is no sound, no matter which component is selected, or only a very low-level sound is heard.**

- Check that the speakers and components are connected correctly and securely.
- Check that both the receiver and all components are turned on.
- Check that MASTER VOLUME is not set to "VOL MIN".
- Check that the SPEAKERS (OFF/A/B/A+B) is not set to "OFF".
- Check that headphones are not connected.
- Press MUTING to cancel the muting function.
- Check that you have selected the correct component with the input buttons.
- The protective device on the receiver has been activated. Turn off the receiver, eliminate the short-circuit problem, and turn on the power again.

**There is no sound from a specific component.**

- Check that the component is connected correctly to the audio input jacks for that component.
- Check that the cord(s) used for the connection is (are) fully inserted into the jacks on both the receiver and the component.

---

**There is no sound from one of the speakers.**

- Connect a pair of headphones to the PHONES jack to verify that sound is output from the headphones. If only one channel is output from the headphones, the component may not be connected to the receiver correctly. Check that all the cords are fully inserted into the jacks on both the receiver and the component. If both channels are output from the headphones, the speaker may not be connected to the receiver correctly. Check the connection of the speaker which is not outputting any sound.
- Make sure you have connected to both the L and R jacks of an analog component, and not only to either the L or R jack. Use an audio cord (not supplied).

---

**The left and right sounds are unbalanced or reversed.**

- Check that the speakers and components are connected correctly and securely.
- Adjust the speaker balance (page 20).

---

**There is severe hum or noise.**

- Check that the speakers and components are connected securely.
- Check that the connecting cords are away from a transformer or motor, and at least 3 meters (10 feet) away from a TV set or fluorescent light.
- Move your audio components away from the TV.
- The plugs and jacks are dirty. Wipe them with a cloth slightly moistened with alcohol.

---

**Recording cannot be carried out.**

- Check that the components are connected correctly.
- Select the source component using the input buttons (page 18).

---

**There is no sound from the component connected to the DIGITAL MEDIA PORT adapter.**

- Adjust the volume of this receiver.
- The DIGITAL MEDIA PORT adapter and/or component is not connected correctly. Turn off the receiver, then reconnect the DIGITAL MEDIA PORT adapter and/or component.
- Check the DIGITAL MEDIA PORT adapter and/or component device to make sure it supports this receiver.

---

**Video**

---

**There is no picture or an unclear picture appears on the TV screen.**

- Depending on the DIGITAL MEDIA PORT adapter, video output may not be possible.

---

**Tuner**

---

**The FM reception is poor.**

- Use a 75-ohm coaxial cable (not supplied) to connect the receiver to an outdoor FM antenna (aerial) as shown below. If you connect the receiver to an outdoor antenna (aerial), ground it against lightning. To prevent a gas explosion, do not connect the ground wire to a gas pipe.

Outdoor FM antenna (aerial)

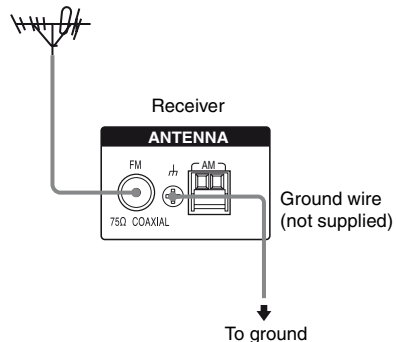

*continued*

---

## Radio stations cannot be tuned in.

- Check that the antennas (aerials) are connected securely. Adjust the antennas (aerials) and connect an external antenna (aerial), if necessary.
- The signal strength of the stations is too weak (when tuning in with auto tuning). Use direct tuning.
- Make sure you set the tuning interval correctly (when tuning in AM stations with direct tuning).
- No stations have been preset or the preset stations have been cleared (when tuning by scanning preset stations). Preset the stations (page 24).
- Press DISPLAY repeatedly on the receiver so that the frequency appears on the display.

---

## RDS does not work.\*

- Make sure that you are tuned to an FM RDS station.
- Select a stronger FM station.

---

## The RDS information that you want does not appear.\*

- Contact the radio station and find out whether they actually provide the service in question. If so, the service may be temporarily out of order.

---

\* Models of area code CEL, CEK only.

## Remote commander

---

### The remote does not function.

- Point the remote at the remote sensor on the receiver.
  - Remove any obstacles in the path between the remote and the receiver.
  - Replace all the batteries in the remote with new ones, if they are weak.
  - Make sure you select the correct input on the remote.
- 

## Error messages

If there is a malfunction, the display shows a message. You can check the condition of the system by the message. Refer to the following table to solve the problem. If any problem persists, consult your nearest Sony dealer.

---

### PROTECT

Irregular current is output to the speakers. The receiver will automatically turn off after a few seconds. Check the speaker connection and turn on the power again.

---

## If the problem persist

Consult your nearest Sony dealer. Note that if service personnel changes some parts during repair, these parts may be retained.

## Reference sections for clearing the receiver's memory

---

To clear	See
All memorized settings	page 16

---



# Specifications

## AUDIO POWER SPECIFICATIONS

### POWER OUTPUT AND TOTAL HARMONIC DISTORTION:

#### (Models of area code U only)

With 8 ohm loads, both channels driven, from 20 – 20,000 Hz; rated 90 watts per channel minimum RMS power, with no more than 0.09% total harmonic distortion from 250 milliwatts to rated output.

### Amplifier section

Models of area code U, CA, CEL, CEK<sup>1)</sup>

Minimum RMS Output Power (8 ohms, 20 Hz – 20 kHz, THD 0.09%)

90 W + 90 W

Stereo Mode Output Power (8 ohms, 1 kHz, THD 1%)

100 W + 100 W

<sup>1)</sup>Measured under the following conditions:

Area code	Power requirements
U, CA	120 V AC, 60 Hz
CEL, CEK	230 V AC, 50 Hz

Frequency response (Analog)

10 Hz – 70 kHz  
+0.5/-2 dB (with BASS = 0 dB, TREBLE = 0 dB)

Inputs (Analog)

Sensitivity: 500 mV/  
50 kohms  
S/N<sup>2)</sup>: 96 dB  
(A, 500 mV<sup>3)</sup>)

Outputs (Analog)

AUDIO OUT Voltage: 500 mV/10 kohms

Tone

Gain levels ±10 dB, 1 dB step

<sup>2)</sup>INPUT SHORT (with BASS = 0 dB, TREBLE = 0 dB).

<sup>3)</sup>Weighted network, input level.

### FM tuner section

Tuning range 87.5 – 108.0 MHz

Antenna (aerial) FM wire antenna (aerial)

Antenna (aerial) terminals

75 ohms, unbalanced

Intermediate frequency

10.7 MHz

### AM tuner section

Tuning range

Area code	Tuning scale	
	10 kHz step	9 kHz step
U, CA	530 – 1,710 kHz	531 – 1,710 kHz
CEL, CEK	–	531 – 1,602 kHz

Antenna (aerial) Loop antenna (aerial)

Intermediate frequency

450 kHz

### General

Power requirements

Area code	Power requirements
U, CA	120 V AC, 60 Hz
CEL, CEK	230 V AC, 50/60 Hz

Power output (DIGITAL MEDIA PORT)

DC OUT: 5 V, 0.7 A MAX

Power consumption

Area code	Power consumption
U, CA, CEL, CEK	200 W

Dimensions (w/h/d) (Approx.)

430 × 132.5 × 279 mm  
(17 × 5 1/4 × 11 inches)  
including projecting parts  
and controls

Mass (Approx.)

6.6 kg (14 lb 9 oz)

## Supplied accessories

Operating Instruction (this manual)

Quick Setup Guide (1)

FM wire antenna (aerial) (1)

AM loop antenna (aerial) (1)

Remote commander (RM-AAU055) (1)

R6 (size-AA) batteries (2)

For details on the area code of the component you are using, see page 4.

Design and specifications are subject to change without notice.

- Standby power consumption: 0.3 W
- Halogenated flame retardants are not used in the certain printed wiring boards.

# Index

## B

- BALANCE 20
- Bass 21
- Blu-ray disc player
  - connecting 14

## C

- CD player
  - connecting 13

## D

- DIGITAL MEDIA PORT
  - connecting 13
  - enjoying 19
  - input 18
- DIMMER 20
- DVD player
  - connecting 14
- DVD recorder
  - connecting 14

## E

- Error messages 32

## I

- Initial setup 16

## M

- Muting 19

## N

- Naming
  - inputs 19
  - preset stations 24

## R

- RDS 25
- Recording 28
- Remote commander 9

## S

- Satellite tuner
  - connecting 14
- Selecting component 18
- Set-top box
  - connecting 14
- Sleep Timer 27
- Speakers
  - connecting 12
- Super Audio CD player
  - connecting 13

## T

- Treble 21
- Tuner
  - connecting 15
- Tuning
  - automatically 22
  - directly 22
  - to preset stations 24

## V

- VCR
  - connecting 14



\* 4 1 2 9 7 4 1 1 4 \* (1)

## Free Manuals Download Website

<http://myh66.com>

<http://usermanuals.us>

<http://www.somanuals.com>

<http://www.4manuals.cc>

<http://www.manual-lib.com>

<http://www.404manual.com>

<http://www.luxmanual.com>

<http://aubethermostatmanual.com>

Golf course search by state

<http://golfingnear.com>

Email search by domain

<http://emailbydomain.com>

Auto manuals search

<http://auto.somanuals.com>

TV manuals search

<http://tv.somanuals.com>