

Multi Channel AV Receiver

Operating Instructions

STR-DN1000

©2009 Sony Corporation

WARNING

To reduce the risk of fire or electric shock, do not expose this apparatus to rain or moisture.

To reduce the risk of fire, do not cover the ventilation opening of the apparatus with newspapers, tablecloths, curtains, etc.

Do not place the naked flame sources such as lighted candles on the apparatus.

To reduce the risk of fire or electric shock, do not expose this apparatus to dripping or splashing, and do not place objects filled with liquids, such as vases, on the apparatus.

Do not install the appliance in a confined space, such as a bookcase or built-in cabinet.

As the main plug is used to disconnect the unit from the mains, connect the unit to an easily accessible AC outlet. Should you notice an abnormality in the unit, disconnect the main plug from the AC outlet immediately.

Do not expose batteries or apparatus with battery-installed to excessive heat such as sunshine, fire or the like.

The unit is not disconnected from the mains as long as it is connected to the AC outlet, even if the unit itself has been turned off.

Excessive sound pressure from earphones and headphones can cause hearing loss.

For customers in the United States and Canada



This symbol is intended to alert the user to the presence of the Hot Surface that may be hot if it is touched during the normal operation.



ENERGY STAR[®] is a U.S. registered mark.

As an ENERGY STAR[®] partner, Sony Corporation has determined that this product meets the ENERGY STAR[®] guidelines for energy efficiency.

For customers in the United States

Owner's Record

The model and serial numbers are located on the rear of the unit. Record these numbers in the space provided below. Refer to them whenever you call upon your Sony dealer regarding this product.

Model No. _____

Serial No. _____



This symbol is intended to alert the user to the presence of uninsulated "dangerous voltage" within the product's enclosure that may be of sufficient magnitude to constitute a risk of electric shock to persons.



This symbol is intended to alert the user to the presence of important operating and maintenance (servicing) instructions in the literature accompanying the appliance.

Important Safety Instructions

- 1) Read these instructions.
- 2) Keep these instructions.
- 3) Heed all warnings.
- 4) Follow all instructions.
- 5) Do not use this apparatus near water.
- 6) Clean only with dry cloth.
- 7) Do not block any ventilation openings. Install in accordance with the manufacturer's instructions.
- 8) Do not install near any heat sources such as radiators, heat registers, stoves, or other apparatus (including amplifiers) that produce heat.
- 9) Do not defeat the safety purpose of the polarized or grounding-type plug. A polarized plug has two blades with one wider than the other. A grounding type plug has two blades and a third grounding prong. The wide blade or the third prong are provided for your safety. If the provided plug does not fit into your outlet, consult an electrician for replacement of the obsolete outlet.
- 10) Protect the power cord from being walked on or pinched particularly at plugs, convenience receptacles, and the point where they exit from the apparatus.
- 11) Only use attachments/accessories specified by the manufacturer.

- 12) Use only with the cart, stand, tripod, bracket, or table specified by the manufacturer, or sold with the apparatus. When a cart is used, use caution when moving the cart/apparatus combination to avoid injury from tip-over.



- 13) Unplug this apparatus during lightning storms or when unused for long periods of time.
- 14) Refer all servicing to qualified service personnel. Servicing is required when the apparatus has been damaged in any way, such as power-supply cord or plug is damaged, liquid has been spilled or objects have fallen into the apparatus, the apparatus has been exposed to rain or moisture, does not operate normally, or has been dropped.

The following FCC statement applies only to the version of this model manufactured for sale in the U.S.A. Other versions may not comply with FCC technical regulations.

NOTE:

This equipment has been tested and found to comply with the limits for a Class B digital device, pursuant to Part 15 of the FCC Rules. These limits are designed to provide reasonable protection against harmful interference in a residential installation.

This equipment generates, uses, and can radiate radio frequency energy and, if not installed and used in accordance with the instructions, may cause harmful interference to radio communications.

However, there is no guarantee that interference will not occur in a particular installation. If this equipment does cause harmful interference to radio or television reception, which can be determined by turning the equipment off and on, the user is encouraged to try to correct the interference by one or more of the following measures:

- Reorient or relocate the receiving antenna.
- Increase the separation between the equipment and receiver.
- Connect the equipment into an outlet on a circuit different from that to which the receiver is connected.
- Consult the dealer or an experienced radio/TV technician for help.

CAUTION

You are cautioned that any changes or modification not expressly approved in this manual could void your authority to operate this equipment.

To reduce the risk of electric shock, the speaker cord should be connected to the apparatus and the speakers in accordance with the following instructions.

- 1) Disconnect the AC power cord from the MAINS.
- 2) Strip 10 to 15 mm of the wire insulation of the speaker cord.
- 3) Connect the speaker cord to the apparatus and the speakers carefully so as not to touch the core of speaker cord by hand. Also disconnect the AC power cord from the MAINS before disconnecting the speaker cord from the apparatus and the speakers.

About This Manual

- The instructions in this manual are for model STR-DN1000. Check your model number by looking at the lower right corner of the front panel. In this manual, models of area code U is used for illustration purposes unless stated otherwise. Any difference in operation is clearly indicated in the text, for example, “Models of area code CA only”.
- The instructions in this manual describe the controls on the supplied remote. You can also use the controls on the receiver if they have the same or similar names as those on the remote.
- “Neural-THX” and “NEURAL-THX” introduced in the Operating Instructions and displayed on the GUI menu screen and on the display mean Neural-THX Surround.

About area codes

The area code of the receiver you purchased is shown on the lower right portion of the rear panel (see the illustration below).

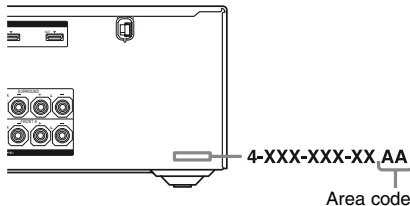

Any differences in operation, according to the area code, are clearly indicated in the text, for example, “Models of area code AA only”.

On copyrights

This receiver incorporates Dolby* Digital and Pro Logic Surround and the DTS** Digital Surround System.

- * Manufactured under license from Dolby Laboratories. Dolby and the double-D symbol are trademarks of Dolby Laboratories.
- ** Manufactured under license under U.S. Patent #'s: 5,451,942; 5,956,674; 5,974,380; 5,978,762; 6,226,616; 6,487,535; 7,212,872; 7,333,929; 7,392,195; 7,272,567 & other U.S. and worldwide patents issued & pending. DTS is a registered trademark and the DTS logos, Symbol, DTS-HD and DTS-HD Master Audio are trademarks of DTS, Inc. © 1996-2008 DTS, Inc. All Rights Reserved.

This receiver incorporates High-Definition Multimedia Interface (HDMI™) technology. HDMI, the HDMI logo and High-Definition Multimedia Interface are trademarks or registered trademarks of HDMI Licensing LLC.

SIRIUS, XM and all related marks and logos are trademarks of Sirius XM Radio Inc. and its subsidiaries. All rights reserved.

The font type (Shin Go R) installed in this receiver is provided by MORISAWA & COMPANY LTD. These names are the trademarks of MORISAWA & COMPANY LTD., and the copyright of the font also belongs to MORISAWA & COMPANY LTD.

This product using Neural-THX® Surround is manufactured under license from Neural Audio Corporation and THX Ltd. Sony Corporation hereby grants the user a non-exclusive, non-transferable, limited right of use to this product under USA and foreign patent, patent pending and other technology or trademarks owned by Neural Audio Corporation and THX Ltd. “Neural Surround”, “Neural Audio”, “Neural” and “NRL” are trademarks and logos owned by Neural Audio Corporation, THX is a trademark of THX Ltd., which may be registered in some jurisdictions. All rights reserved.

iPod is a trademark of Apple Inc., registered in the U.S. and other countries.

All other trademarks and registered trademarks are of their respective holders. In this manual, ™ and ® marks are not specified.

The Bluetooth word mark and logos are owned by the Bluetooth SIG, Inc. and any use of such marks by Sony Corporation is under license.

Other trademarks and trade names are those of their respective owners.

“M-crew Server” is a trademark of Sony Corporation.

“x.v.Color” and “x.v.Color” logo are trademarks of Sony Corporation.

“BRAVIA” is a trademark of Sony Corporation.

“S-AIR” and its logo are trademarks of Sony Corporation.

DLNA and DLNA CERTIFIED are trademarks and/or service marks of the Digital Living Network Alliance.

About the S-AIR function

The receiver is compatible with the S-AIR function, which allows transmission of sound between S-AIR products wirelessly.

The following S-AIR products can be used with the receiver:

- Surround amplifier: You can enjoy surround speaker sound wirelessly.
- S-AIR receiver: You can enjoy receiver sound in another room.

These S-AIR products can be purchased as an option (the S-AIR product lineup differs depending on the area).

Notes or instructions for the surround amplifier or S-AIR receiver in this operating instructions refer only to when the surround amplifier or S-AIR receiver is used.

For details on the S-AIR function, see “S-AIR Operations” (page 97).

Table of Contents

Description and location of parts..... 8

Getting Started

1: Installing speakers	17
2: Connecting speakers.....	19
3: Connecting the TV	21
4a: Connecting the audio components.....	23
4b: Connecting the video components	25
5: Connecting the antennas (aerials).....	35
6: Preparing the receiver and the remote	36
7: Displaying the GUI menu on the TV screen.....	37
8: Selecting the front speaker system	38
9: Calibrating the appropriate speaker settings automatically (Auto Calibration)	40
Guide to on-screen display operation	45

Playback

Enjoying sound/images from the component connected to the receiver	47
Enjoying sound/images from the components connected to the DIGITAL MEDIA PORT	49

Tuner Operations

Listening to FM/AM radio	52
Presetting FM/AM radio stations	54
Listening to Satellite Radio	55
Connecting the SIRIUS Satellite Radio	56
Preparing to listen to the SIRIUS Satellite Radio	57
Selecting a channel of the SIRIUS Satellite Radio	58
Presetting SIRIUS Satellite Radio channels	59
Restricting access to specific channels (Parental Lock)	60

Enjoying Surround Sound

Playing back with 2-channel sound	63
Playing back with multi-channel surround	64
Enjoying a surround effect for music/movie.....	67
Resetting sound fields to the initial settings	70

Amplifier Operations

Using the setting menu	70
Settings for the Auto Calibration (Auto Calibration menu).....	72
Setting for the speaker (Speaker Settings menu)	73
Settings for the surround sound (Surround Settings menu)	77
Settings for the EQ (EQ menu).....	78
Settings for the audio (Audio Settings menu).....	78
Settings for the video (Video Settings menu)	79
Settings for HDMI (HDMI Settings menu)	81
Settings for the S-AIR (S-AIR Settings menu).....	82
Operating without connecting to a TV	82

“BRAVIA” Sync Features

What is “BRAVIA” Sync?.....	93
Preparing for the “BRAVIA” Sync	94
Playing back components with one-touch operation (One-Touch Play).....	96
Enjoying the TV sound from the speakers connected to the receiver (System Audio Control).....	96
Turning off the receiver with the TV (System Power Off)	97

S-AIR Operations

About S-AIR products	97
Setting up an S-AIR product.....	99
Enjoying the system's sound in another room	104
Changing the channel for better sound transmission	105
Stabilizing S-AIR reception	106
Enjoying the S-AIR receiver while the S-AIR main unit is in standby mode	107

Other Operations

Switching between digital and analog audio (INPUT MODE)	108
Enjoying the sound/images from other inputs.....	109
Using the Sleep Timer.....	111
Changing the brightness of the front panel display (DIMMER)	111
Enjoying the surround effect at low volume levels (NIGHT MODE).....	112
Recording using the receiver.....	112
Using a bi-amplifier connection.....	113

Using the Remote

Operating each component using the remote	115
Programming the remote.....	117
Clearing all the contents of the remote's memory	121

Additional Information

Glossary	122
Precautions	125
Troubleshooting	126
Specifications	133
Index.....	135

Description and location of parts

Front panel

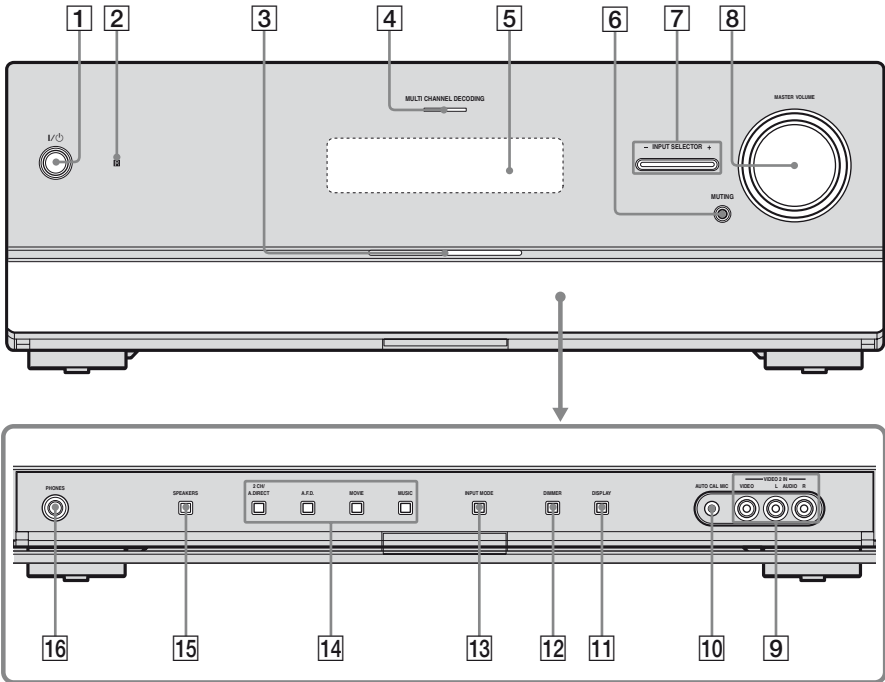

Name	Function
1 I/⏻ (on/standby)	Press to turn the receiver on or off (page 36, 37, 54, 70).
2 Remote sensor	Receives signals from remote commander.
3 White lamp	Lights up when the receiver is on. Lights off when the receiver is off or the "DIMMER" is set to "70% DOWN".
4 MULTI CHANNEL DECODING lamp	Lights up when multi channel audio signals are decoded (page 128).
5 Display	The current status of the selected component or a list of selectable items appears here (page 10).

Name	Function
6 MUTING	Press to turn off the sound temporarily. Press MUTING again to restore the sound (page 48, 126).
7 INPUT SELECTOR +/-	Press repeatedly to select the input source to playback (page 48, 108, 112).
8 MASTER VOLUME	Turn to adjust the volume level of all speakers at the same time (page 48, 126).
9 VIDEO 2 IN jacks	Connects to a portable audio/video component such as a camcorder or video game (page 32, 48).

Name	Function
10 AUTO CAL MIC jack	Connects to the supplied optimizer microphone for the Auto Calibration function (page 41).
11 DISPLAY	Press repeatedly to select information displayed on the display (page 88, 132).
12 DIMMER	Press repeatedly to adjust the brightness of the display (page 111).
13 INPUT MODE	Press to select the input mode when the same components are connected to both digital and analog jacks (page 108).
14 2CH/A.DIRECT A.F.D. MOVIE MUSIC	Press to select a sound field (page 63, 64, 67).
15 SPEAKERS	Press to select the front speaker system (page 38).
16 PHONES jack	Connects to headphones (page 127).

About the indicators on the display

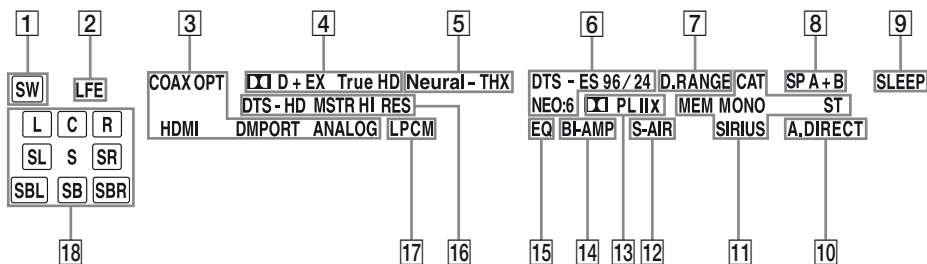

Name	Function
1 SW	Lights up when subwoofer is connected and the audio signal is output from the SUBWOOFER jack. While this indicator lights up, the receiver creates a subwoofer signal based on the LFE signal in the disc being played back or the low frequency components of the front channels.
2 LFE	Lights up when the disc being played back contains an LFE (Low Frequency Effect) channel and the LFE channel signal is actually being reproduced.
3 Input indicators	Light up to indicate the current input.
COAX	Lights up when INPUT MODE is set to "AUTO" and the source signal is a digital signal being input through the COAXIAL jack (page 108).
OPT	Lights up when INPUT MODE is set to "AUTO" and the source signal is a digital signal being input through the OPTICAL jack (page 108).
HDMI	The receiver recognizes a component connected via an HDMI IN jack.
DMPORT	The DIGITAL MEDIA PORT adapter is connected and "DMPORT" is selected.
ANALOG	No digital signal is being input. When INPUT MODE is set to "ANALOG" or when the "Analog Direct" is being selected, it also lights up.

Name	Function
4 Dolby Digital Surround indicators	Lights up one of the respective indicators when the receiver is decoding the corresponding Dolby Digital format signals.
D	Dolby Digital
D EX	Dolby Digital Surround EX
D+	Dolby Digital Plus
TrueHD	Dolby TrueHD
Note	When playing a Dolby Digital format disc, be sure that you have made digital connections and that INPUT MODE is set to "AUTO" (page 108).
5 Neural-THX	Lights up when the receiver applies Neural-THX processing to input signals.
6 DTS(-ES) indicators	Light up when DTS or DTS-ES signals are input.
DTS	Lights up when the receiver is decoding DTS signals.
DTS 96/24	Lights up when the receiver is decoding DTS 96 kHz/24 bit signals.
NEO:6	Lights up when DTS Neo:6 Cinema/Music decoder is activated (page 66).
DTS-ES	Lights up when the receiver is decoding DTS-ES signals.
Note	When playing a DTS format disc, be sure that you have made digital connections and that INPUT MODE is set to "AUTO" (page 108).

Name	Function
7 D.RANGE	Lights up when dynamic range compression is activated.
8 SP A/SP B/ SP A+B	Lights up according to the front speaker system used (page 38). However, these indicators do not light up if the speaker output is turned off or if headphones are connected.
9 SLEEP	Lights up when the Sleep Timer is activated.
10 A.DIRECT	Lights up when “Analog Direct” is selected.
11 Tuning indicators	Lights up when the receiver tunes in radio stations, or satellite radio stations.
CAT	The category mode is selected during the satellite radio operation.
MEM	Lights up when a memory function, such as Preset Memory (page 54), etc., is activated.
MONO	Monaural broadcast
ST	Stereo broadcast
SIRIUS	The SiriusConnect Home tuner is connected and “SR” is selected.
12 S-AIR	Lights up when the S-AIR transmitter (not supplied) is connected.
13 Dolby Pro Logic indicators	Lights up one of the respective indicators when the receiver applies Dolby Pro Logic processing to 2 channel signals in order to output the center and surround channel signals.
ⓧ PL	Dolby Pro Logic
ⓧ PL II	Dolby Pro Logic II
ⓧ PL Iix	Dolby Pro Logic Iix
	Note These indicators do not light up when either the center speaker and surround speaker is not connected.
14 BI-AMP	Lights up when “SB Assign” is set to “BI-AMP” (page 113).
15 EQ	Lights up when the equalizer is activated.

Name	Function
16 DTS-HD indicators	Lights up one of the respective indicators when the receiver is decoding the corresponding DTS-HD format signals.
DTS-HD MSTR	DTS-HD Master Audio
DTS-HD HI RES	DTS-HD High Resolution Audio
17 LPCM	Lights up when Linear PCM (Pulse Code Modulation) signals are input.
18 Playback channel indicators	The letters (L, C, R, etc.) indicate the channels being played back. The boxes around the letters vary to show how the receiver downmixes the source sound (based on the speaker settings).
L	Front Left
R	Front Right
C	Center (monaural)
SL	Surround Left
SR	Surround Right
S	Surround (monaural or the surround components obtained by Pro Logic processing)
SBL	Surround Back Left
SBR	Surround Back Right
SB	Surround Back (the surround back components obtained by 6.1 channel decoding)
	Example: Recording format (Front/ Surround): 3/2.1 Output channel: When “SP Pattern” is set to “3/0.1” (page 73, 85) Sound Field: “A.F.D. Auto”
	<div style="display: flex; justify-content: center; gap: 10px;"> <div style="border: 1px solid black; padding: 2px;">SW</div> </div> <div style="display: flex; justify-content: center; gap: 10px; margin-top: 5px;"> <div style="border: 1px solid black; padding: 2px;">L</div> <div style="border: 1px solid black; padding: 2px;">C</div> <div style="border: 1px solid black; padding: 2px;">R</div> </div> <div style="display: flex; justify-content: center; gap: 20px; margin-top: 5px;"> <div style="border: 1px solid black; padding: 2px;">SL</div> <div style="border: 1px solid black; padding: 2px;">SR</div> </div>

Rear panel

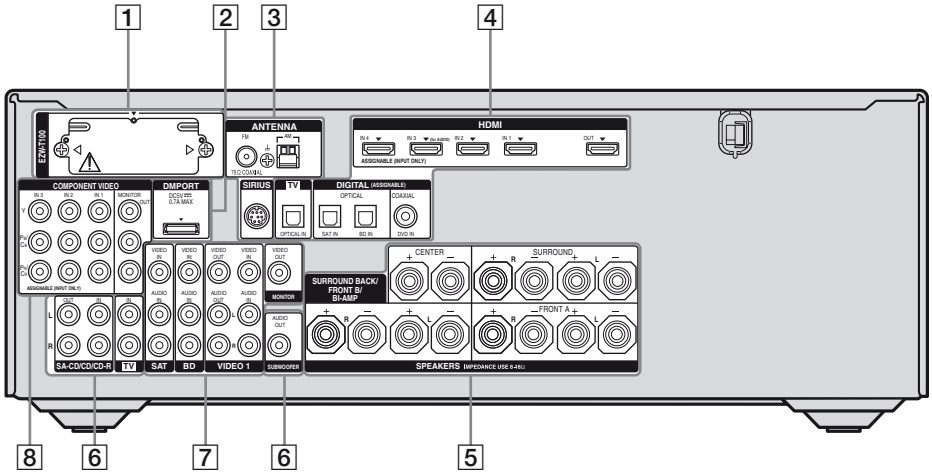

1 S-AIR (EZW-T100)

With slot cover

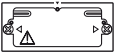

slot

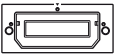

CAUTION
Please do not remove the slot cover until you want to install the wireless transmitter.

Connects to a wireless transmitter (not supplied) (page 99).

2 DMPORT



DMPORT jack
Connects to a Sony DIGITAL MEDIA PORT adapter (page 23).

3 ANTENNA section



FM ANTENNA jack
Connects to the FM wire antenna (aerial) supplied with this receiver (page 35).





AM ANTENNA terminals
Connects to the AM loop antenna (aerial) supplied with this receiver (page 35).



SIRIUS jack
Connects to a SiriusConnect Home tuner (not supplied) (page 56).



4 DIGITAL INPUT/OUTPUT section

	OPTICAL IN jacks	Connects to a BD player, etc. (page 21, 26, 29, 30, 31).
	COAXIAL IN jack	
	HDMI IN/OUT* jacks	Connects to a DVD player, satellite tuner, or a Blu-ray disc player. The image is output to a TV or a projector while the sound can be output from a TV or/and speakers connected to this receiver (page 21, 26).



5 SPEAKERS section

	Connects to speakers (page 19).
---	---------------------------------



6 AUDIO INPUT/OUTPUT section

	White (L) AUDIO IN/OUT jacks	Connects to a Super Audio CD player, etc. (page 21, 23, 26).
	Red (R)	
	Black AUDIO OUT jack	Connects to subwoofer (page 19).

7 VIDEO/AUDIO INPUT/OUTPUT section

	White (L) AUDIO IN/OUT jacks	Connects to a VCR, Blu-ray disc player, etc. (page 30, 31, 32).
	Red (R)	
	Yellow VIDEO IN/OUT* jacks	

8 COMPONENT VIDEO INPUT/OUTPUT section

	Green (Y)	Y, Pb/Cb, Pr/Cr IN/OUT* jacks	Connects to a BD player, TV, satellite tuner, etc. (page 21, 29, 30, 31).
	Blue (Pb/Cb)		
	Red (Pr/Cr)		

* You can watch the selected input image when you connect the MONITOR OUT or HDMI OUT jack to a TV (page 21). You can operate this receiver using a GUI (Graphical User Interface) if you connect HDMI OUT jack or COMPONENT VIDEO MONITOR OUT jacks to a TV (page 37).

Remote commander

You can use the supplied remote to operate the receiver and to control the Sony audio/video components that the remote is assigned to operate.



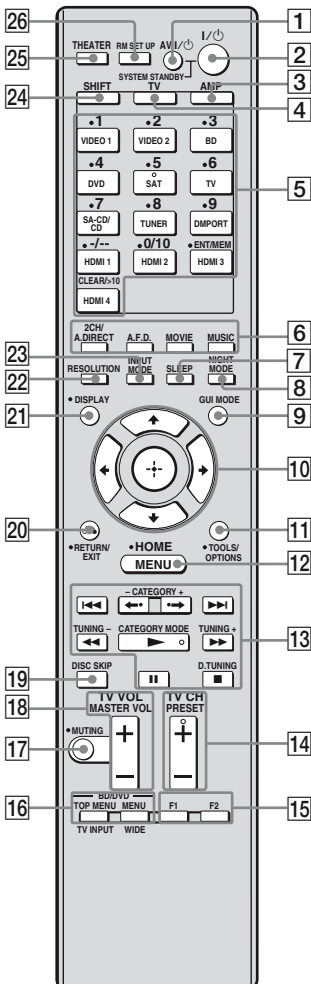

You can also program the remote to control non-Sony audio/video components. For details, see “Programming the remote” (page 117).

RM-AAP040



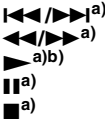

Name	Function
1 AV I/⏻ ^{a)} (on/standby)	Press to turn on or off the audio/video components that the remote is programmed to operate. To turn the TV on or off, press TV (4) and then press AV I/⏻. If you press I/⏻ (2) at the same time, it will turn off the receiver and other components (SYSTEM STANDBY). Note The function of the AV I/⏻ switch changes automatically each time you press the input buttons (5).
2 I/⏻ (on/standby)	Press to turn the receiver on or set it to the standby mode. To turn off all components, press I/⏻ and AV I/⏻ (1) at the same time (SYSTEM STANDBY).
3 AMP	Press to enable the receiver operation (page 82).
4 TV	Press to light up the button. It changes the remote key function to activate the buttons with yellow printing. It also activate the DISPLAY (21), TOOLS/OPTIONS (11), HOME (12), RETURN/EXIT (20), + (10), and ⬆/⬇/⬅ (10) buttons to perform menu operations for Sony TVs only.
5 Input buttons (SAT ^b)	Press one of the buttons to select the component you want to use. When you press any of the input buttons, the receiver turns on. The buttons are factory assigned to control Sony components (page 48). You can program the remote to control non-Sony components following the steps in “Programming the remote” on page 117.

Name	Function
Numeric buttons^{a)} (number 5^{b)})	<p>Press SHIFT (24), then press numeric buttons to</p> <ul style="list-style-type: none"> – preset/tune to preset stations. – select track numbers of the CD player, DVD player, Blu-ray disc player or MD deck, etc. Press 0/10 to select track number 10. – select channel numbers of the VCR or satellite tuner, etc. <p>Press TV (4) and then press the numeric buttons to select the TV channels.</p>
ENT/MEM^{a)}	<p>Press SHIFT (24), then press ENT/MEM to</p> <ul style="list-style-type: none"> – enter the value after selecting a channel, disc or track using the numeric buttons. – store a station during tuner operation. <p>To enter the value of Sony TV, press TV (4) and then press ENT/MEM.</p>
CLEAR^{a)}	<p>Press SHIFT (24), then press CLEAR to</p> <ul style="list-style-type: none"> – clear a mistake when you press the incorrect numeric button. – return to continuous playback, etc. of the satellite tuner or DVD player.
-/--^{a)}	<p>Press SHIFT (24), then press -/-- to select the channel entry mode, either one or two digit of the VCR or satellite tuner.</p> <p>To select the channel entry mode of the TV, press TV (4) and then press -/--.</p>
>10^{a)}	<p>Press SHIFT (24), then press >10 to</p> <ul style="list-style-type: none"> – select track numbers over 10 of the CD player, DVD player, Blu-ray disc player or MD deck, etc. – select channel numbers of the Digital CATV terminal.
6 2CH/ A.DIRECT A.F.D. MOVIE MUSIC	<p>Press to select a sound field (page 63, 64, 67).</p>

Name	Function
7 SLEEP	Press to activate the Sleep Timer function and the duration which the receiver turns off automatically (page 111).
8 NIGHT MODE	Press to activate the NIGHT MODE function (page 112).
9 GUI MODE	Press to display the GUI menu on the TV screen.
10 	<p>Press  to select the menu items.</p> <p>Then press  to enter the selection.</p>
11 TOOLS/ OPTIONS^{a)}	<p>Press to display and select items from the option menus for receiver, DVD player, Blu-ray disc player or satellite tuner.</p> <p>Press TV (4) and then press TOOLS/OPTIONS to display the options of Sony TV.</p>
12 HOME^{a)}, MENU^{a)}	<p>Press to display the menu to operate the audio/video components.</p> <p>To display the menus of Sony TV, press TV (4) and then press HOME.</p>
13 	<p>Press to operate the DVD player, Blu-ray disc player, CD player, MD deck, tape deck, or component connected to the DIGITAL MEDIA PORT adapter, etc.</p>
	Press to replay the previous scene or fast forward the current scene of the DVD player or Blu-ray disc player, etc.
TUNING +/-^{a)}	Press to scan a station.
CATEGORY MODE	Press to select the category mode for satellite tuner (page 58, 92).
CATEGORY +/-	Press to select a category for satellite tuner (page 59, 92).
D.TUNING	Press to enter direct tuning mode (page 53, 91).
14 TV CH +^{b)}/–^{a)}	Press TV (4) and then press TV CH +/- to select preset TV channels.

continued

Name	Function
PRESET +^{b)}/-^{a)}	Press to – select preset stations. – select preset channels of the VCR, satellite tuner, Blu-ray disc player, DVD player, LD player, DVD/VHS COMBO, or DVD/HDD COMBO.
15 F1^{a)}, F2^{a)}	Press BD or DVD (5), then press F1 or F2 to select a component. • DVD/HDD COMBO F1: HDD F2: DVD disc, Blu-ray disc • DVD/VHS COMBO F1: DVD disc, Blu-ray disc F2: VHS
16 BD/DVD TOP MENU^{a)}	Press to display the menu or on-screen guide of the DVD player, Blu-ray disc player, PSX or DVD/VHS COMBO on the TV screen. Then, use ▲/▼/◀/▶ (10) and ⊕ (10) to perform menu operations.
BD/DVD MENU^{a)}	Press to display the menu of the DVD player or Blu-ray disc player on the TV screen. Then, use ▲/▼/◀/▶ (10) and ⊕ (10) to perform menu operations.
TV INPUT^{a)}	Press TV (4) and then press TV INPUT to select the input signal (TV input or video input).
WIDE^{a)}	Press TV (4) and then press WIDE repeatedly to select the wide picture mode.
17 MUTING^{a)}	Press to turn off the sound temporarily. Press the button again to restore the sound. To mute the sound of the TV, press TV (4) and then press MUTING.
18 TV VOL +/-^{a)}	Press TV (4) and then press TV VOL +/- to adjust the TV volume level.
MASTER VOL +/-^{a)}	Press to adjust the volume level of all speakers at the same time.
19 DISC SKIP^{a)}	Press to skip disc when using a multi-disc changer.

Name	Function
20 RETURN/EXIT  ^{a)}	Press to – return to the previous menu. – exit the menu while the menu or on-screen guide of the VCD player, DVD player, etc. is displayed on the TV screen. To return to the previous menu of Sony TV, press TV (4) and then press RETURN/EXIT  .
21 DISPLAY^{a)}	Press to display the current status of or information on components connected to the receiver. Note In the GUI MODE, press the button to display the menu on the TV screen.
22 RESOLUTION	Press repeatedly to change the resolution of signals output from the HDMI OUT or COMPONENT VIDEO MONITOR OUT jack (page 79).
23 INPUT MODE	Press to select the input mode when the same components are connected to both digital and analog jacks (page 108).
24 SHIFT	Press to light up the button. It changes the remote button function to activate the buttons with pink printing.
25 THEATER	Press to turn the Theater mode on and off when connecting the receiver to products featuring “BRAVIA” Sync.
26 RM SET UP	Press to set up the remote.

^{a)} See the table on page 116 for information on the buttons that you can use to control each component.

^{b)} The number 5/SAT, TV CH +/PRESET + and  buttons have tactile dots. Use the tactile dots as references when operating the receiver.

Notes

- Some functions explained in this section may not work depending on the model.
- The above explanation is intended to serve as an example only. Therefore, depending on the component, the above operation may not be possible or may operate differently than described.

1: Installing speakers

This receiver allows you to use a 7.1 channel system (7 speakers and one subwoofer).

Enjoying a 5.1/7.1 channel system

To fully enjoy theater-like multi channel surround sound requires five speakers (two front speakers, a center speaker, and two surround speakers) and a subwoofer (5.1 channel).

Example of a 5.1 channel speaker system configuration

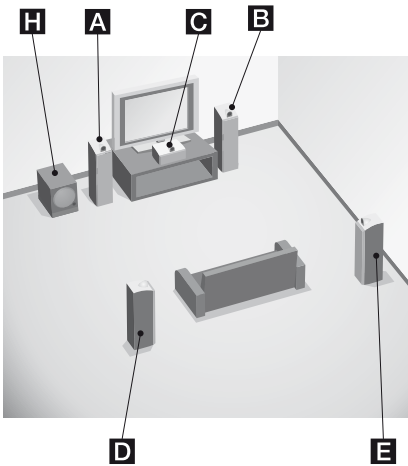

- A** Front speaker (left)
- B** Front speaker (right)
- C** Center speaker
- D** Surround speaker (left)
- E** Surround speaker (right)
- H** Subwoofer

You can enjoy high fidelity reproduction of DVD or Blu-ray disc software recorded sound in the Surround EX format if you connect one additional surround back speaker (6.1 channel system) or two surround back speakers (7.1 channel system).

Example of a 7.1 channel speaker system configuration

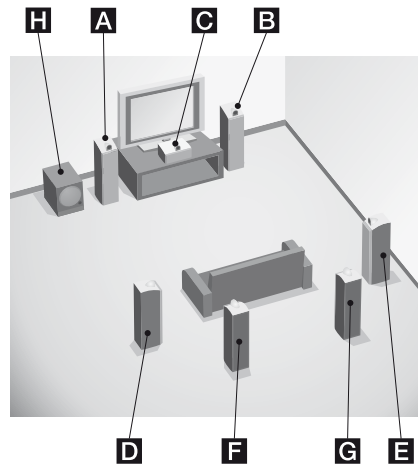

- A** Front speaker (left)
- B** Front speaker (right)
- C** Center speaker
- D** Surround speaker (left)
- E** Surround speaker (right)
- F** Surround back speaker (left)
- G** Surround back speaker (right)
- H** Subwoofer

Tips

- When you connect a 7.1 channel speaker system, the angle **A** should be the same.

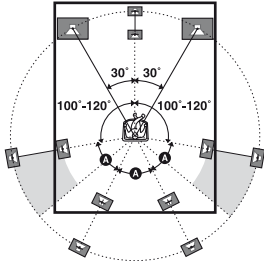

- When you connect a 6.1 channel speaker system, place the surround back speaker behind the listening position.

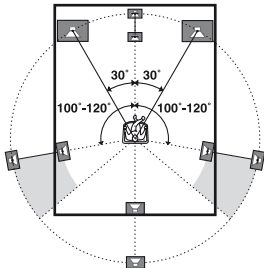

- Since the subwoofer does not emit highly directional signals, you can place it wherever you want.

2: Connecting speakers

Before connecting cords, be sure to disconnect the AC power cord (mains lead).

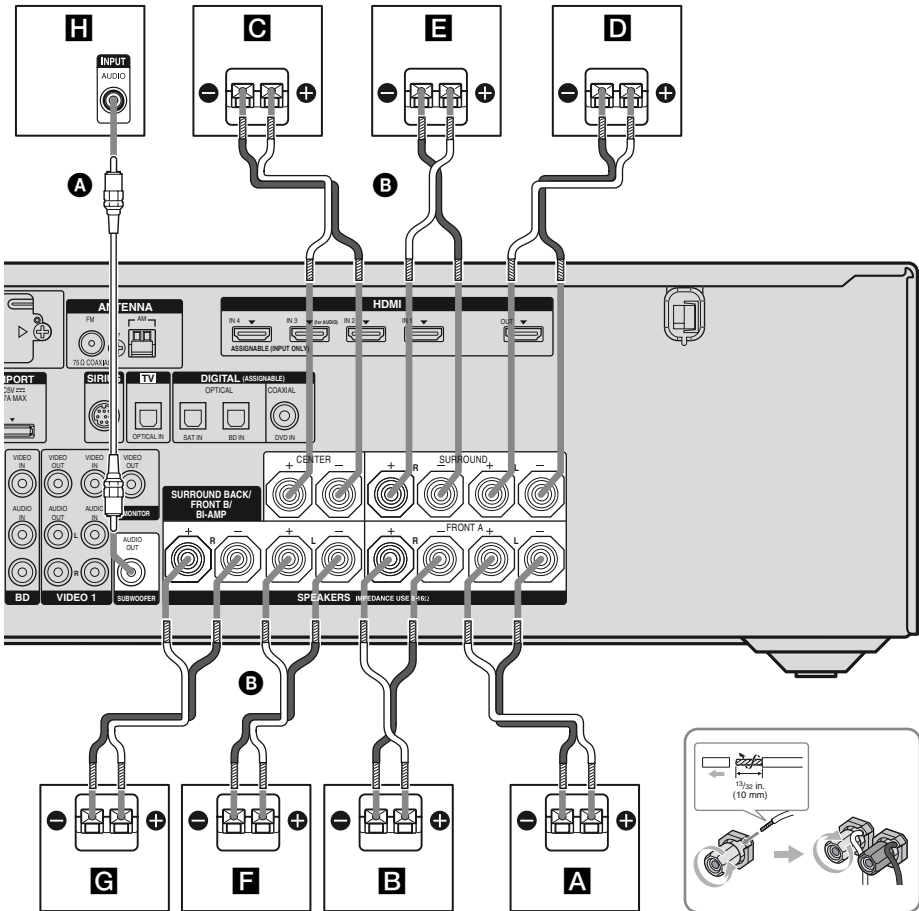

A Monaural audio cord (not supplied)

B Speaker cord (not supplied)

A Front speaker A (left)

B Front speaker A (right)

C Center speaker

D Surround speaker (left)

E Surround speaker (right)

F Surround back speaker (left)^{a)b)c)}

G Surround back speaker (right)^{a)b)c)}

H Subwoofer^{d)}

continued

- a) If you connect only one surround back speaker, connect it to the SPEAKERS SURROUND BACK/FRONT B/BI-AMP L terminals.
- b) If you are not using surround back speaker, and you have an additional front speaker system, connect the additional front speaker system to the SPEAKERS SURROUND BACK/FRONT B/BI-AMP terminals. Set “SB Assign” to “Speaker B” in the Speaker Settings menu (page 73). You can select the front speaker system you want to use with SPEAKERS on the front panel (page 38).
- c) If you are not using surround back speakers, you can connect the front speakers to the SPEAKERS SURROUND BACK/FRONT B/BI-AMP terminals using a bi-amplifier connection (page 113). Set “SB Assign” to “BI-AMP” in the Speaker Settings menu (page 73).
- d) When you connect a subwoofer with an auto standby function, turn off the function when watching movies. If the auto standby function is set to on, it turns to standby mode automatically based on the level of the input signal to a subwoofer, then sound may not be output.

Note

Before connecting the AC power cord (mains lead), make sure that metallic wires of the speaker cords are not touching each other between the SPEAKERS terminals.

3: Connecting the TV

You can watch the selected input image when you connect the HDMI OUT or MONITOR OUT jack to a TV. You can operate this receiver using a GUI (Graphical User Interface) if you connect HDMI OUT jack or COMPONENT VIDEO MONITOR OUT jacks to a TV.

It is not necessary to connect all the cables. Connect audio and video cords according to the jacks of your components. Before connecting cords, be sure to disconnect the AC power cord (mains lead).

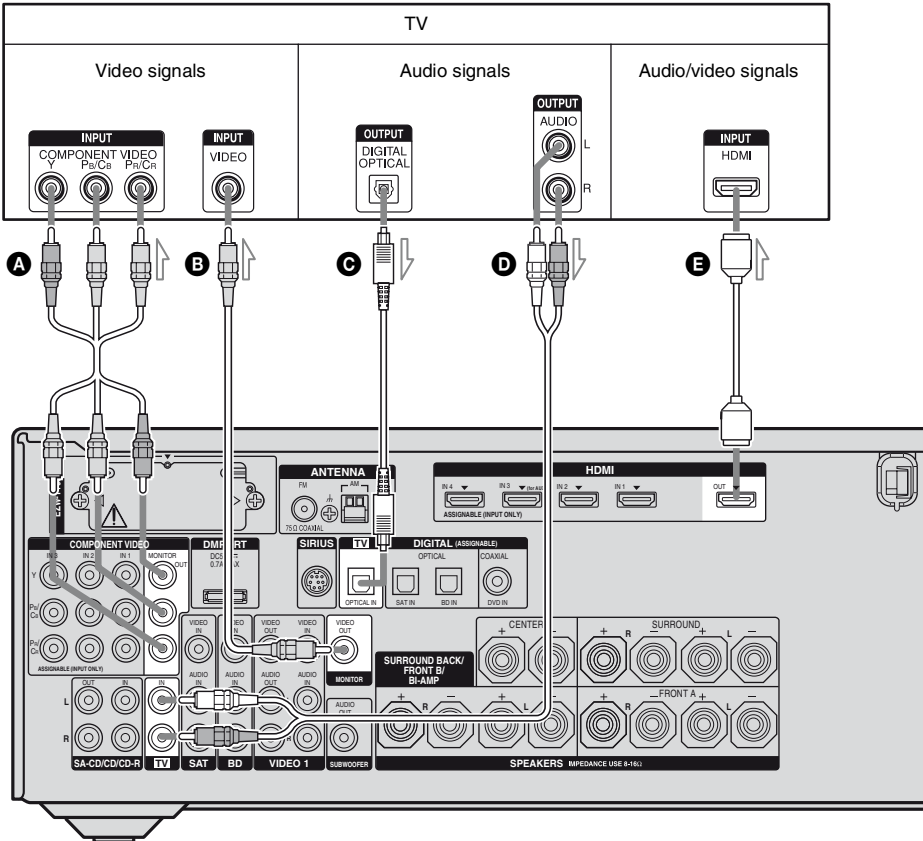

- A** Component video cord (not supplied)
- B** Video cord (not supplied)
- C** Optical digital cord (not supplied)
- D** Audio cord (not supplied)
- E** HDMI cable (not supplied)

Sony recommends that you use an HDMI-authorized cable or Sony HDMI cable.

continued

Notes

- Be sure to turn on the receiver when the video and audio of a playback component are being output to a TV via the receiver. If the power supply of the receiver is not turned on, neither video nor audio is transmitted.
- Connect image display components such as a TV monitor or a projector to the HDMI OUT or MONITOR OUT jack on the receiver. You may not be able to record, even if you connect recording components.
- Depending on the status of the connection between the TV and the antenna (aerial), the image on the TV screen may be distorted. In this case, place the antenna (aerial) farther away from the receiver.
- When connecting optical digital cords, insert the plugs straight in until they click into place.
- Do not bend or tie optical digital cords.

Tips

- The receiver has a video conversion function. For details, see “Function for conversion of video signals” (page 33).
- The sound of the TV is output from the speakers connected to the receiver if you connect the audio output jack of the TV to the TV IN jacks of the receiver. In this configuration, set the sound output jack of the TV to “Fixed” if it can be switched between either “Fixed” or “Variable”.

4a: Connecting the audio components

Connecting audio components

The following illustration shows how to connect a Super Audio CD player, CD player, CD recorder and DIGITAL MEDIA PORT adapter. Before connecting cords, be sure to disconnect the AC power cord (mains lead).

After connecting your audio component, proceed to “4b: Connecting the video components” (page 25) or “5: Connecting the antennas (aerials)” (page 35).

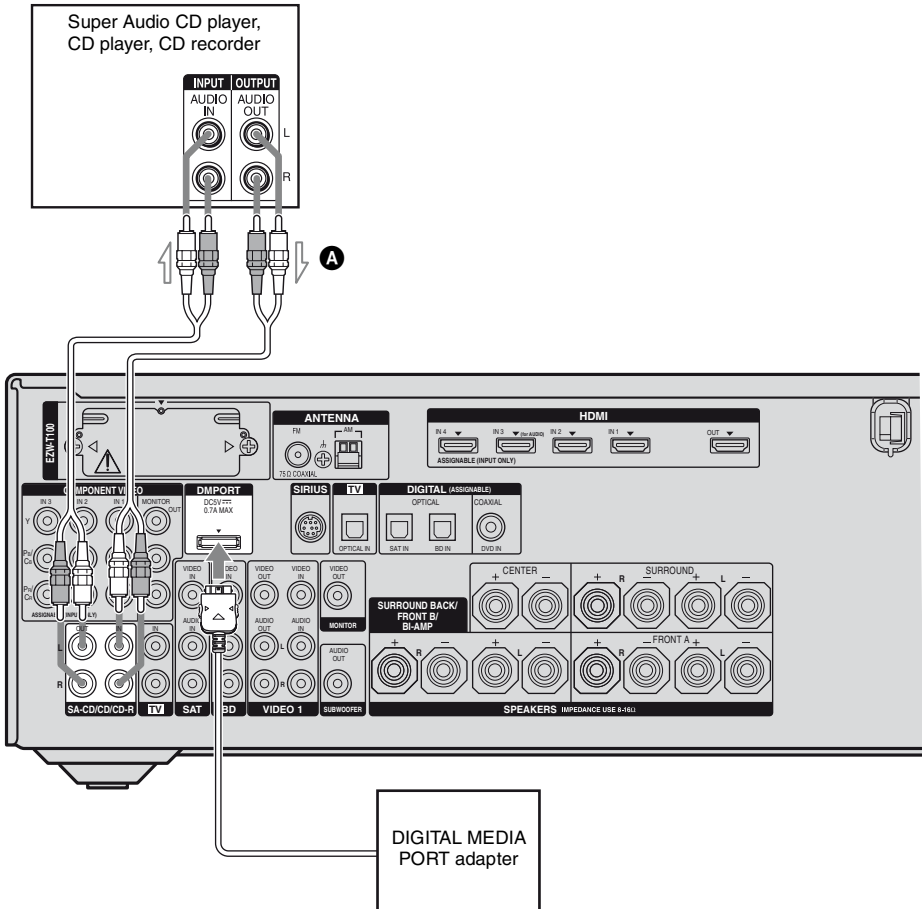

A Audio cord (not supplied)

continued

23 US

Notes on connecting DIGITAL MEDIA PORT adapter

- Do not connect or disconnect the DIGITAL MEDIA PORT adapter while the receiver is turned on.
- Be sure to make DMPORT connections firmly, insert the connector straight in.
- As the connector of the DIGITAL MEDIA PORT adapter is fragile, be sure to handle with care when placing or moving the receiver.
- When connecting the DIGITAL MEDIA PORT adapter, be sure the connector is inserted with the arrow mark facing towards the arrow mark on the DMPORT jack. To detach the DIGITAL MEDIA PORT adapter, press and hold **A** and then pull out the connector.

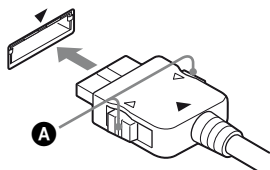

4b: Connecting the video components

How to connect your components

This section describes how to connect your video components to this receiver. Before you begin, see “Component to be connected” below for the pages which describe how to connect each component. Before connecting cords, be sure to disconnect the AC power cord (mains lead).

After connecting all your components, proceed to “5: Connecting the antennas (aerials)” (page 35).

Component to be connected

Component	Page
TV	21
With HDMI jack	26
DVD player	29
Blu-ray disc player	30
Satellite tuner, Set-top box	31
DVD recorder, VCR	32
Camcorder, video game, etc.	32

If you want to connect several digital components, but cannot find an unused input

See “Enjoying the sound/images from other inputs” (page 109).

Video input/output jacks to be connected

The image quality depends on the connecting jack. See the illustration that follows. Select the connection according to the jacks on your components.

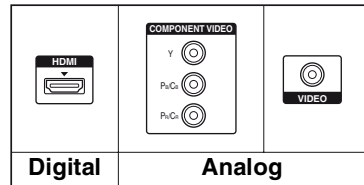

High quality image

Note

Be sure to turn on the receiver when the video and audio of a playback component are being output to a TV via the receiver. If the power supply of the receiver is not turned on, neither video nor audio is transmitted.

Converting video signals

This receiver is equipped with a function for up-converting video signals. For details, see “Function for conversion of video signals” (page 33).

Connecting components with HDMI jacks

HDMI is the abbreviated name for High-Definition Multimedia Interface. It is an interface which transmits video and audio signals in digital format.

Sony recommends that you connect components to the receiver using an HDMI cable.

With HDMI, you can easily enjoy both high quality sound and high quality images.

However, it is necessary to connect the audio output of the TV to the audio input of the receiver using an optical digital cord to listen to the TV multi channel surround sound broadcasting from the receiver.

By connecting Sony “BRAVIA” Sync compatible components using HDMI cables, ““BRAVIA” Sync Features” makes operations simpler (page 93).

Notes

- Be sure to change the factory setting of the HDMI 1–4 input button on the remote so that you can use the button to control your components. For details, see “Programming the remote” (page 117).
- You can also rename the HDMI input so that it can be displayed on the receiver’s display. For details, see “Naming the input (Name Input)” (page 49).

HDMI features

- A digital audio signals transmitted by HDMI can be output from the speakers connected to the receiver. This signal supports Dolby Digital, DTS, and Linear PCM.
- The receiver can receive Multi Linear PCM (up to 8 channels) with a sampling frequency of 192 kHz or less with an HDMI connection.
- Analog video signals input to the VIDEO jack or COMPONENT VIDEO jacks can be up-converted as HDMI signals. Audio signals are not output from an HDMI OUT jack when the image is converted.
- This receiver supports High Bitrate Audio (DTS-HD Master Audio, Dolby TrueHD), Deep Color and x.v.Color transmission, extended by HDMI version 1.3.
- This receiver supports the Control for HDMI function. For details, see ““BRAVIA” Sync Features” (page 93).
- HDMI 3 input has a better sound quality. When you need a higher sound quality, connect your component to the HDMI IN 3 (for AUDIO) jack and select HDMI 3 as input.

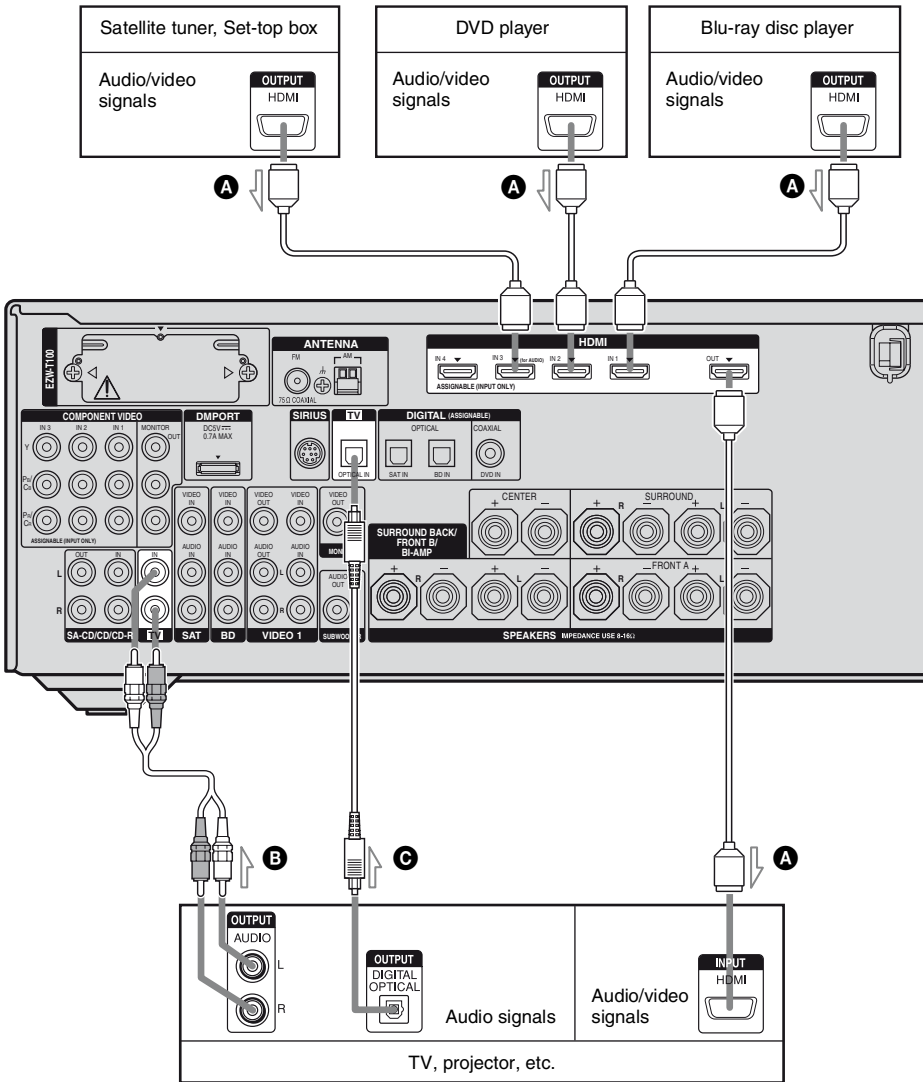

A HDMI cable (not supplied)

Sony recommends that you use an HDMI-authorized cable or Sony HDMI cable.

B Audio cord (not supplied)^{a)}

C Optical digital cord (not supplied)^{a)}

^{a)} Connect at least one of the audio cords (**B** or **C**).

continued

27^{US}

Notes on connecting cables

- We recommend that you use an HDMI cable with the HDMI logo (made by Sony) for the HDMI jack corresponding to high speed (an HDMI version 1.3a, category 2 cable) when you view images or listen to sound during a Deep Color transmission or when you watch a video image of 1080p or higher.
- We do not recommend using an HDMI-DVI conversion cable. When you connect an HDMI-DVI conversion cable to a DVI-D component, the sound and/or the image may not be output. Connect other audio cords or digital connecting cords, then set “Input Assign” in the Input Option menu when the sound is not output correctly.

Notes on HDMI connections

- An audio signal input to the HDMI IN jack is output from the SPEAKERS jacks and HDMI OUT jack. It is not output from any other audio jacks.
- A video signal input to the HDMI IN jack can only be output from the HDMI OUT jack. The video input signals cannot be output from the VIDEO OUT jacks or MONITOR OUT jacks.
- The audio and video signals of HDMI input are not output from the HDMI OUT jack while the receiver menu is displayed.
- When you want to listen to the sound from the TV speaker, set “Audio Out” to “TV+AMP” in the HDMI Settings menu (page 81). If you cannot play back multi channel audio source, set to “AMP”. However, the sound will not output from the TV speaker.
- DSD signals of Super Audio CD are not input and output.
- Be sure to turn on the receiver when the video and audio of a playback component are being output to a TV via the receiver. If the power supply of the receiver is not turned on, neither video nor audio is transmitted.

- Audio signals (sampling frequency, bit length, etc.) transmitted from an HDMI jack may be suppressed by the connected component. Check the setup of the connected component if the image is poor or the sound does not come out of a component connected via the HDMI cable.
- Sound may be interrupted when the sampling frequency, the number of channels or audio format of audio output signals from the playback component is switched.
- When the connected component is not compatible with copyright protection technology (HDCP), the image and/or the sound from the HDMI OUT jack may be distorted or may not be output. In this case, check the specification of the connected component.
- You can enjoy High Bitrate Audio (DTS-HD Master Audio, Dolby TrueHD), multi channel Linear PCM only with an HDMI connection.
- Set the image resolution of the playback component to more than 720p to enjoy High Bitrate Audio (DTS-HD Master Audio, Dolby TrueHD).
- The image resolution of playback component may need certain settings be made before you can enjoy multi channel Linear PCM. Refer to the operating instructions of the playback component.
- Not every HDMI component supports all functions that are defined by the specified HDMI version. For example, components that support HDMI, version 1.3a, may not support Deep Color.
- Refer to the operating instructions of each connected component for details.

Connecting a DVD player

The following illustration shows how to connect a DVD player.

It is not necessary to connect all the cords. Connect audio and video cords according to the jacks of your components.

Notes

- The COMPONENT VIDEO IN 2 jacks have been assigned to the DVD player. If you connect your DVD player to the COMPONENT VIDEO IN 1 or IN 3 jacks, set “Input Assign” in the Input Option menu (page 109).

- To input multi channel digital audio from the DVD player, set the digital audio output setting on the DVD player. Refer to the operating instructions supplied with the DVD player.
- When connecting optical digital cords, insert the plugs straight in until they click into place.
- Do not bend or tie optical digital cords.

Tip

All the digital audio jacks are compatible with 32 kHz, 44.1 kHz, 48 kHz, and 96 kHz sampling frequencies.

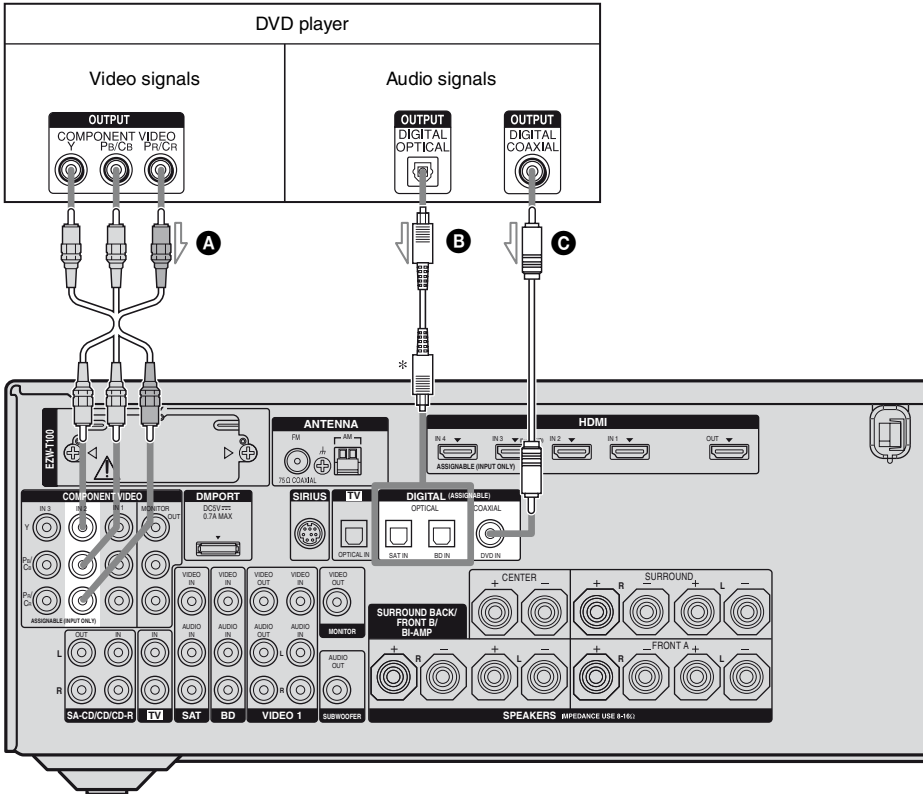

- Ⓐ Component video cord (not supplied)
- Ⓑ Optical digital cord (not supplied)
- Ⓒ Coaxial digital cord (not supplied)

* When you connect a component equipped with an OPTICAL jack, set “Input Assign” in the Input Option menu.

Connecting a Blu-ray disc player

The following illustration shows how to connect a Blu-ray disc player.

It is not necessary to connect all the cords. Connect audio and video cords according to the jacks of your components.

Notes

- The COMPONENT VIDEO IN 1 jacks have been assigned to the Blu-ray disc player. If you connect your Blu-ray disc player to the COMPONENT VIDEO IN 2 or IN 3 jacks, set “Input Assign” in the Input Option menu (page 109).

- To input multi channel digital audio from the Blu-ray disc player, set the digital audio output setting on the Blu-ray disc player. Refer to the operating instructions supplied with the Blu-ray disc player.
- When connecting optical digital cords, insert the plugs straight in until they click into place.
- Do not bend or tie optical digital cords.

Tip

All the digital audio jacks are compatible with 32 kHz, 44.1 kHz, 48 kHz, and 96 kHz sampling frequencies.

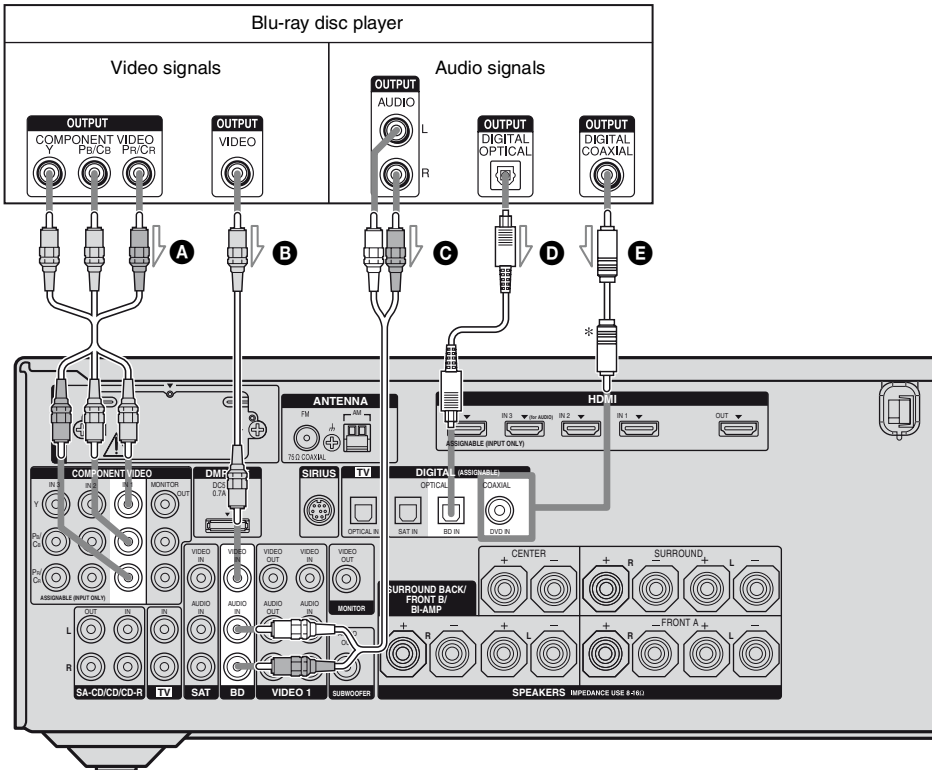

- A** Component video cord (not supplied)
- B** Video cord (not supplied)
- C** Audio cord (not supplied)
- D** Optical digital cord (not supplied)
- E** Coaxial digital cord (not supplied)

* When you connect a component equipped with an COAXIAL jack, set “Input Assign” in the Input Option menu.

Connecting a satellite tuner, set-top box

The following illustration shows how to connect a satellite tuner or set-top box. It is not necessary to connect all the cords. Connect audio and video cords according to the jacks of your components.

Notes

- The COMPONENT VIDEO IN 3 jacks have been assigned to the satellite tuner. If you connect your satellite tuner to the COMPONENT VIDEO IN 1 or IN 2 jacks, set “Input Assign” in the Input Option menu (page 109).
- When connecting optical digital cords, insert the plugs straight in until they click into place.
- Do not bend or tie optical digital cords.

Tip

All the digital audio jacks are compatible with 32 kHz, 44.1 kHz, 48 kHz, and 96 kHz sampling frequencies.

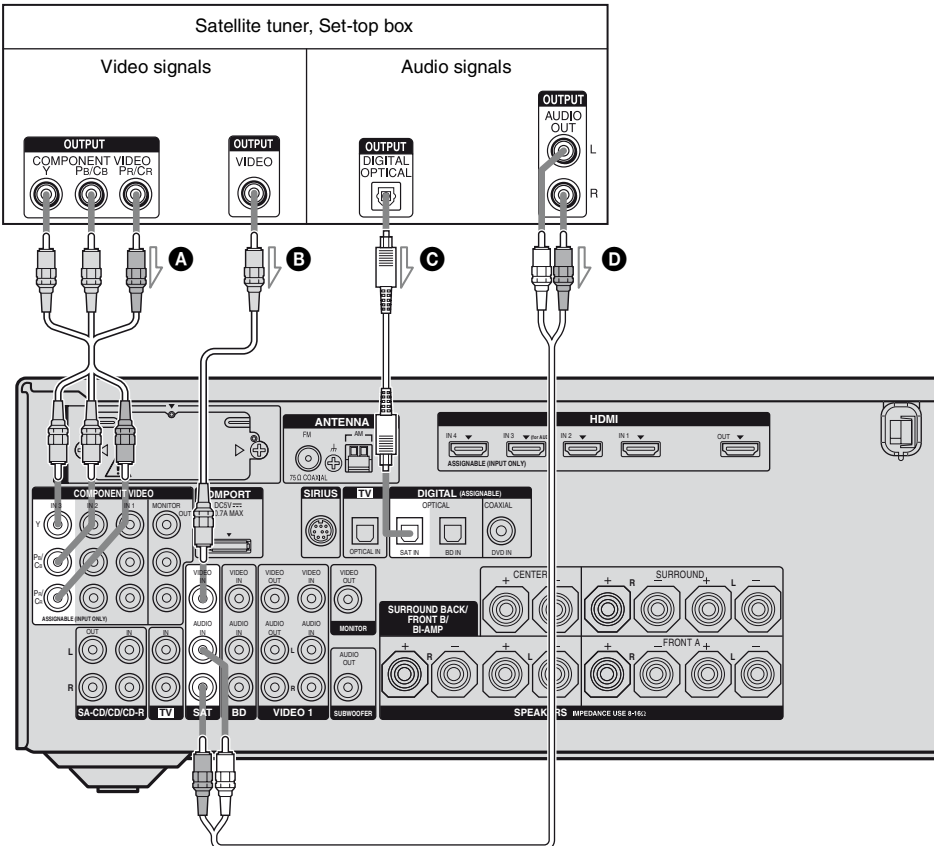

- A** Component video cord (not supplied)
- B** Video cord (not supplied)
- C** Optical digital cord (not supplied)
- D** Audio cord (not supplied)

Connecting components with analog video and audio jack

The following illustration shows how to connect a component which has analog jacks such as a DVD recorder, VCR, etc. It is not necessary to connect all the cords. Connect audio and video cords according to the jacks of your components.

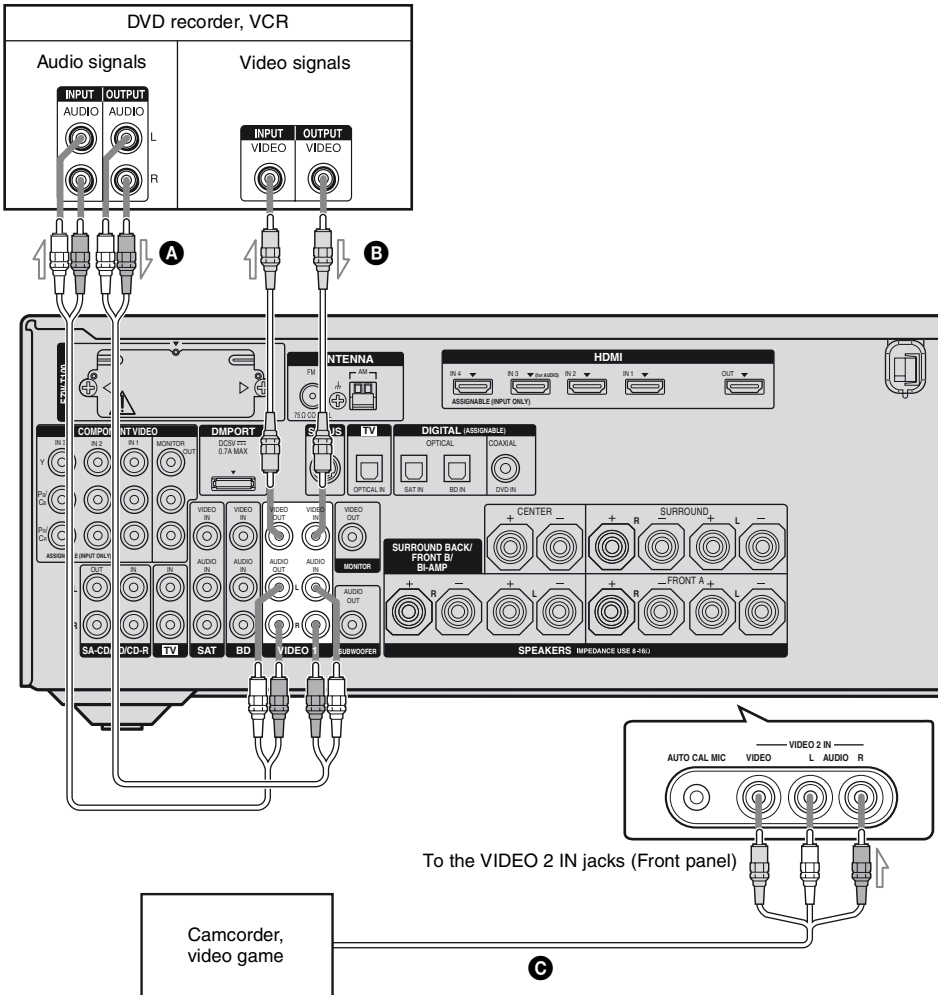

- Ⓐ Audio cord (not supplied)
- Ⓑ Video cord (not supplied)
- Ⓒ Audio/video cord (not supplied)

Notes

- Be sure to change the factory setting of the VIDEO 1 input button on the remote so that you can use the button to control your DVD recorder. For details, see "Programming the remote" (page 117).
- You can also rename the VIDEO 1 input so that it can be displayed on the TV screen and display. For details, see "Naming the input (Name Input)" (page 49).

Function for conversion of video signals

This receiver is equipped with a function for converting video signals.

You can output the video signal after connecting this receiver via MONITOR OUT or HDMI OUT jack as shown in the illustration below.

- Video signals can be output as HDMI video and component video signals.
- Component video signals can be output as HDMI video signals.

As the initial setting, video signals input from the connected component are output to the HDMI OUT or MONITOR OUT jacks as shown in the table below.

We recommend you set the video conversion function to match the resolution of the monitor you are using.

For details on the video converting function, see “Settings for the video (Video Settings menu)” (page 79).

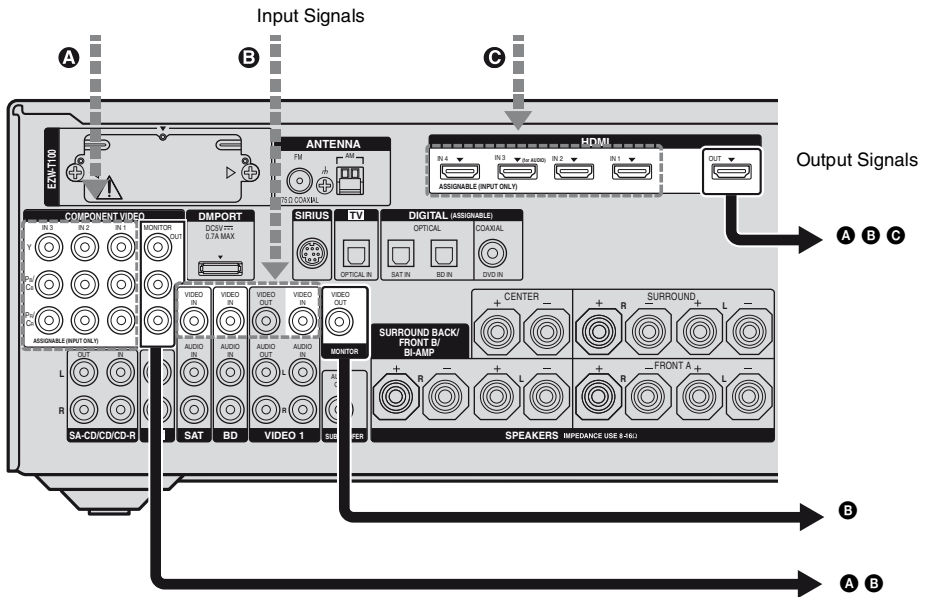

OUTPUT jack \ INPUT jack	HDMI OUT	COMPONENT VIDEO MONITOR OUT	MONITOR VIDEO OUT
COMPONENT VIDEO IN A	○	△/○	X
VIDEO IN B	○	○	△
HDMI IN C	△	X	X

○ : Video signals are up-converted and output through the video converter.

△ : The same type of signal as that of the input signal is output. Video signals are not converted.

X : Video signals are not output.

continued

Notes on converting video signals

- When video signals from a VCR, etc., are converted on this receiver and then output to your TV, depending on the status of the video signal output, the image on the TV screen may appear distorted horizontally or no image may be output.
- HDMI video signals cannot be converted to component video signals and video signals.
- When you play back a VCR with an image improvement circuit, such as TBC, the images may be distorted or may not be output. In this case, set the image improvement circuit function to off.
- The resolution of the signals output to the COMPONENT VIDEO MONITOR OUT jacks and HDMI OUT jack are converted up to 1080i.
- COMPONENT VIDEO MONITOR OUT jacks have restrictions on resolution when the resolution of video signals protected by copyright technology is converted. Resolution of up to 480p can be output to the COMPONENT VIDEO MONITOR OUT jacks. The HDMI OUT jack has no restriction on resolution.
- Video signals for which the resolution has been converted cannot be output from either the COMPONENT VIDEO MONITOR OUT jacks or the HDMI OUT jack. The video signals are output from the HDMI OUT jack when both are connected.

To display Closed Caption

Set “Resolution” to “DIRECT” in the Video Settings menu when receiving a signal that supports Closed Captions.

Use the same type of cords for the input/output signals.

To connect a recording component

When recording, connect the recording component to the VIDEO OUT jacks of the receiver. Connect cords for input and output signals to the same type of jack, as VIDEO OUT jacks do not have an up-conversion function.

Note

Signals output from the HDMI OUT or MONITOR OUT jacks may not be recorded properly.

5: Connecting the antennas (aerials)

Connect the supplied AM loop antenna (aerial) and FM wire antenna (aerial).

Before connecting the antennas (aerials), be sure to disconnect the AC power cord (mains lead).

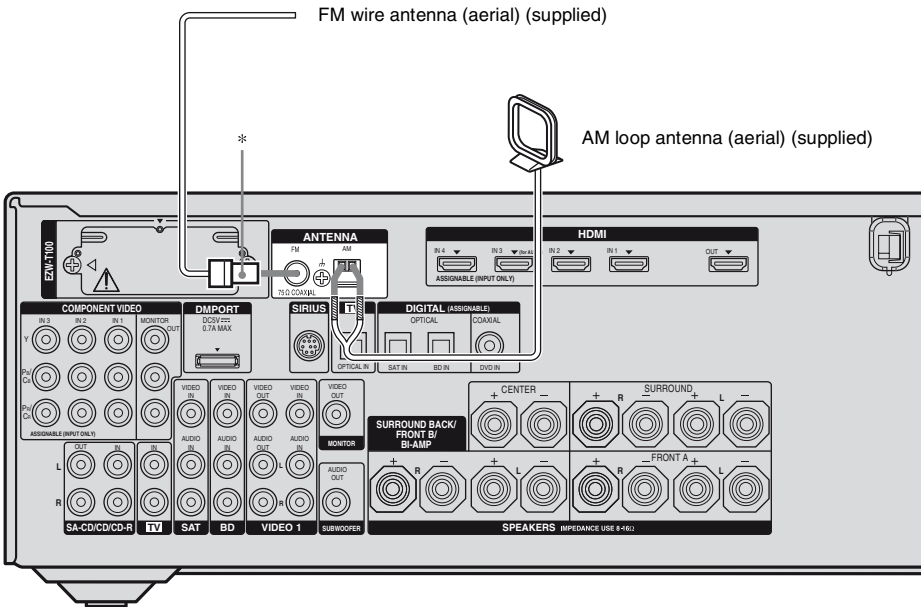

* The shape of the connector varies depending on the area code of this receiver.

Notes

- To prevent noise pickup, keep the AM loop antenna (aerial) away from the receiver and other components.
- Be sure to fully extend the FM wire antenna (aerial).
- After connecting the FM wire antenna (aerial), keep it as horizontal as possible.

6: Preparing the receiver and the remote

Connecting the AC power cord (mains lead)

Connect the AC power cord (mains lead) to a wall outlet.

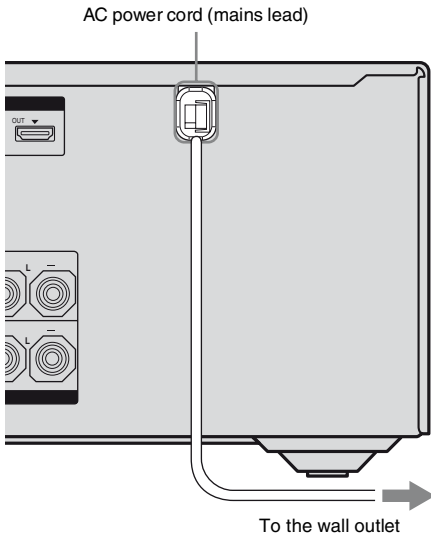

Notes

- Before connecting the AC power cord (mains lead), make sure that metallic wires of the speaker lead) are not touching each other between the SPEAKERS terminals.
- Connect the AC power cord (mains lead) firmly.

Performing initial setup operations

Before using the receiver for the first time, initialize the receiver by performing the following procedure. This procedure can also be used to return settings you have made to their factory defaults.

Be sure to use the buttons on the receiver for this operation.

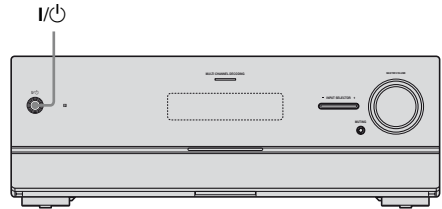

- 1 Press I/⏻ to turn off the receiver.**
- 2 Hold down I/⏻ for 5 seconds.**

After “CLEARING” appears on the display for a while, “CLEARED!” appears.

All the settings you have changed or adjusted are reset to the initial settings.

Inserting batteries into the remote

Insert two R6 (size-AA) batteries in the RM-AAP040 remote commander. Observe the correct polarity when installing batteries.

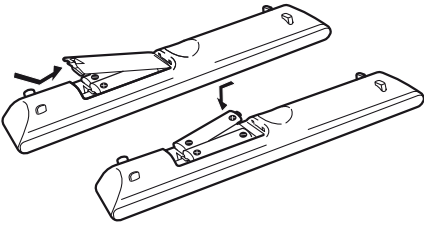

Notes

- Do not leave the remote in an extremely hot or humid place.
- Do not use a new battery with old ones.
- Do not mix manganese batteries and other kinds of batteries.
- Do not expose the remote sensor to direct sunlight or lighting apparatuses. Doing so may cause a malfunction.
- If you do not intend to use the remote for an extended period of time, remove the batteries to avoid possible damage from battery leakage and corrosion.
- When you replace the batteries, the programmed remote codes may be cleared. If this happens, program the remote codes again (page 117).
- When the remote no longer operates the receiver, replace all the batteries with new ones.

7: Displaying the GUI menu on the TV screen

You can select the functions or change the settings of the receiver by using the GUI menu on the TV screen. Follow the procedure below to make the settings so that the GUI menu appears on the TV screen.

Note

GUI menu does not appear on the TV screen when you have connected your TV to the MONITOR VIDEO OUT jack.

Tip

See “Operating without connecting to a TV” (page 82) if you want to operate the receiver without connecting to a TV.

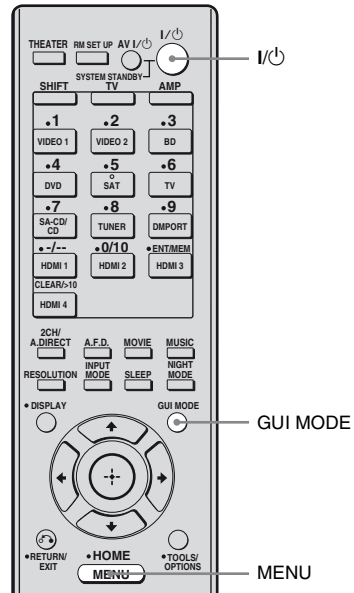

- 1 Connect a TV to this receiver.**
See “3: Connecting the TV” (page 21).
- 2 Turn on the TV.**
- 3 Press I/⏻ to turn on the receiver.**

continued

4 Press GUI MODE.

After “MENU ON” appears on the display for a while, “GUI” appears and the GUI menu appears on the TV screen. Press MENU if the GUI menu does not appear on the TV screen.

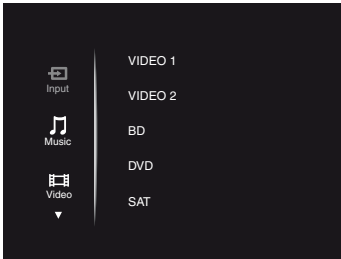

To exit the menu

Press MENU.

8: Selecting the front speaker system

You can select the front speakers you want to drive.

Be sure to use the buttons on the receiver for this operation.

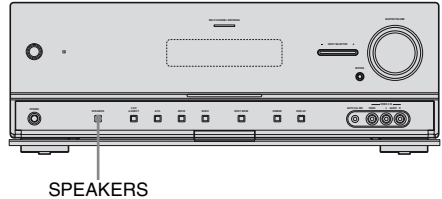

Press SPEAKERS repeatedly to select the front speaker system you want to drive.

To select	Light up
The front speakers connected to the SPEAKERS FRONT A terminals	SP A
The front speakers connected to the SPEAKERS SURROUND BACK/ FRONT B/BI-AMP terminals	SP B*
The front speakers connected to both the SPEAKERS FRONT A and SURROUND BACK/FRONT B/ BI-AMP terminals (parallel connection)	SP A + B*

* To select “SP B” or “SP A + B”, set “SB Assign” to “Speaker B” in the Speaker Settings menu (page 73).

To turn off the speaker output

Press SPEAKERS repeatedly until the “SP A”, “SP B” or “SP A + B” indicators on the display does not light up. “ALL OFF” appears on the display for a while.

Note

You cannot switch the front speaker system by pressing SPEAKERS when the headphones are connected.

To set up front speakers B

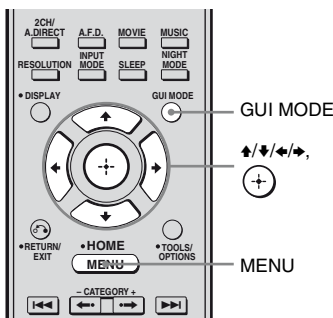

1 Press GUI MODE.

After “MENU ON” appears on the display for a while, “GUI” appears and the GUI menu appears on the TV screen. Press MENU if the GUI menu does not appear on the TV screen.

2 Press ↑/↓ repeatedly to select “Settings” then press (+) or →.

The Settings menu list appears on the TV screen.

3 Press ↑/↓ repeatedly to select “Speaker”, then press (+) or →.

4 Press ↑/↓ repeatedly to select “SP Pattern”, then press (+) or →.

5 Press ↑/↓ repeatedly to select the appropriate speaker pattern so that there are no surround back speakers, then press (+).

6 Press ↑/↓ repeatedly to select “SB Assign”, then press (+) or →.

7 Press ↑/↓ repeatedly to select “Speaker B”, then press (+).

The same signals output from the SPEAKERS FRONT A terminals can be output from the SPEAKERS SURROUND BACK/FRONT B/BI-AMP terminals.

To exit the menu

Press MENU.

Notes

- Set “SB Assign” to “Speaker B” before you perform Auto Calibration.
- If you set “SB Assign” to “Speaker B”, the speaker level and distance settings of the surround back speakers become invalid, and those of the front speakers are used.
- If you set “SP Pattern” to a setting with surround back speakers, you cannot set “SB Assign” to “Speaker B”.

9: Calibrating the appropriate speaker settings automatically (Auto Calibration)

This receiver is equipped with DCAC (Digital Cinema Auto Calibration) function which allows you to perform automatic calibration to measure the following:

- Speaker connections^{a)}
- Polarity of speakers
- Speaker distance^{a)}
- Speaker size^{a)}
- Speaker level
- Frequency characteristics^{a)b)}

^{a)}The measurement result is not utilized when the “Analog Direct” is selected.

- ^{b)}• Signals with a sampling frequency of higher than 96 kHz are always played back at either 44.1 kHz or 48 kHz.
- The measurement result is not utilized when Dolby TrueHD signals with a sampling frequency of higher than 96 kHz are being received.

The DCAC is designed to obtain proper sound balance in your room. However, you can adjust the speaker levels and balance manually according to your preference. For details, see “Test Tone (Test tone)” (page 75).

Before you perform Auto Calibration

Before you perform the Auto Calibration, set up and connect the speakers (page 17–19).

- The AUTO CAL MIC jack is used for the supplied optimizer microphone only. Do not connect other microphones to this jack. Doing so may damage the receiver and the microphone.
- During the measurement, the sound that comes out of the speakers is very loud. The volume of the sound cannot be adjusted. Pay attention to the presence of children or to the effect on your neighborhood.
- Perform the measurement in a quiet environment to avoid the effect of noise and get a more accurate measurement.
- If there are any obstacles in the path between the optimizer microphone and the speakers, the calibration cannot be performed correctly. Remove any obstacles from the measurement area to avoid measurement error.
- When you use a bi-amplifier connection, set “SB Assign” to “BI-AMP” in the Speaker Settings menu (page 73) before you perform Auto Calibration.
- When you use front speakers B connection, set “SB Assign” to “Speaker B” in the Speaker Settings menu (page 73) before you perform Auto Calibration.
- If you want to use surround amplifier, be sure to pair the surround amplifier to S-AIR main unit before you perform Auto Calibration (page 102).
- Select the seating position as position 1, 2 or 3 to save the Auto Calibration result (page 72).

Notes

- The Auto Calibration function does not work in the following cases.
 - Headphones are connected
 - SPEAKERS is set to off.
- If you activate the muting function during Auto Calibration, the muting function will automatically be set to off.

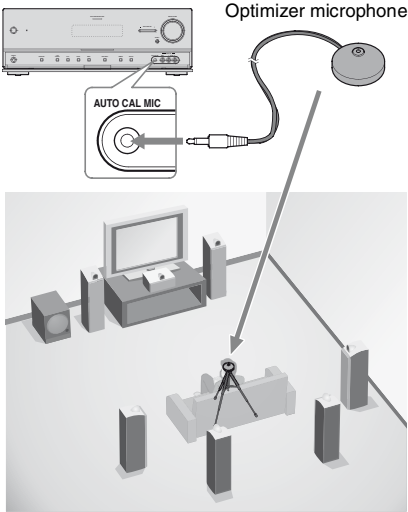

1 Connect the supplied optimizer microphone to the AUTO CAL MIC jack.

2 Set up the optimizer microphone.

Place the optimizer microphone at your listening position. Use a stool or tripod so that the optimizer microphone remains at the same height as your ears.

On setting up the active subwoofer

- When a subwoofer is connected, turn on the subwoofer and turn up the volume beforehand. Turn the MASTER VOLUME to just before the mid-point.
- If you connect a subwoofer with a crossover frequency function, set the value to maximum.
- If you connect a subwoofer with an auto standby function, set it to off (deactivated).

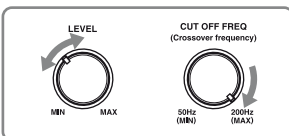

Note

Depending on the characteristics of the subwoofer you are using, the setup distance value may be further away from the actual position.

Performing Auto Calibration

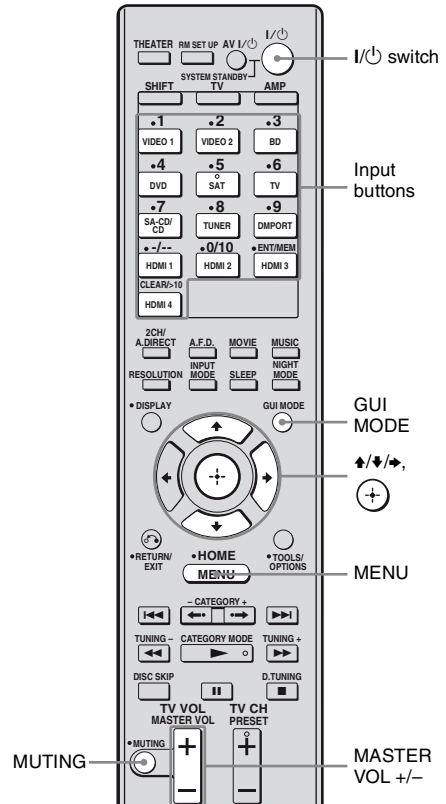

1 Press GUI MODE.

After “MENU ON” appears on the display for a while, “GUI” appears and the GUI menu appears on the TV screen. Press MENU if the GUI menu does not appear on the TV screen.

2 Press \uparrow/\downarrow repeatedly to select “Settings”, then press \odot or \oplus .

The Settings menu list appears on the TV screen.

continued

- 3** Press **▲/▼** repeatedly to select “Auto Cal.”, then press **⊕** or **➔**.
- 4** Press **▲/▼** repeatedly to select “Auto Cal. Start”, then press **⊕** or **➔**.
- 5** Press **⊕** to select “START”.
- 6** The measurement starts in five seconds.

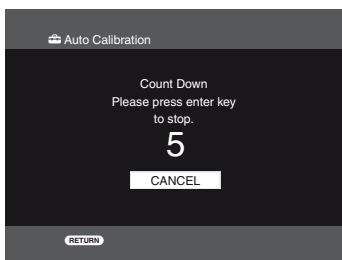

7 Measurement starts.

The measurement process will take approximately 30 seconds with a test tone. Wait until the measurement process completes.

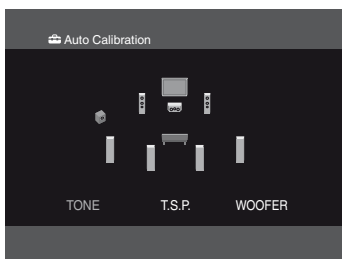

Tip

The measurements may not be performed correctly or Auto Calibration cannot be performed when special speakers, such as dipole speakers are used.

To cancel the measurement

The measurement will be canceled when you do the following:

- Press **I/O**.
- Press the input buttons on the remote or press the **INPUT SELECTOR +/-** repeatedly on the receiver.
- Press **MUTING**.
- Press **SPEAKERS** on the receiver.
- Change the volume level.
- Connect the headphones.

Confirming/saving the measurement results

1 Confirm the measurement result.

When the measurement ends, a beep sounds.

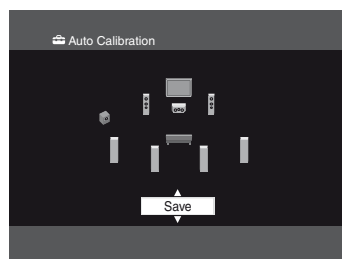

2 Press **▲/▼** repeatedly to select the item you want, then press **⊕**.

Item	Explanation
Retry	Performs the Auto Calibration again.
Save	Saves the measurement results and exits the setting process.
Warning	Displays warning concerning the measurement results. See “Message list after Auto Calibration measurement” (page 44).
Phase*	Displays the phase of each speaker (in phase/out of phase).

Item	Explanation
Distance	Displays the measurement result for speaker distance.
Level	Displays the measurement result for speaker level.
Exit	Exits the setting process without saving the measurement results.

* When the speaker(s) is (are) out of the phase, “OUT” is displayed on the TV screen. The “+” and “-” terminals of the speaker may be connected the other way around.

However, depending on the speakers, “OUT” appears on the TV screen even though the speakers are connected properly. This is because of the speakers’ specifications. In this case, you can continue to use the receiver.

3 Select “Save” in step 2 to save the measurement result.

4 Press \uparrow/\downarrow repeatedly to select the Auto Calibration Type, then press \oplus .

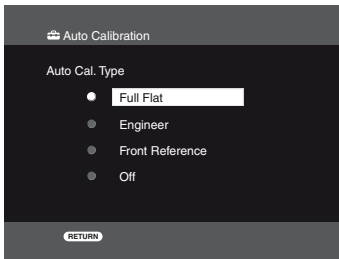

Parameter	Explanation
Full Flat	Makes the measurement of frequency from each speaker flat.
Engineer	Sets the frequency to one that matches that of the Sony listening room standard.
Front Reference	Adjusts the characteristics of all the speakers to match the characteristics of the front speaker.
Off	Sets the Auto Calibration to off.

Tip

The size of a speaker (“Large”/“Small”) is determined by the low frequency characteristics. The measurement results may vary, depending on the position of the optimizer microphone and speakers, and the shape of the room. It is recommended that you follow the measurement results. However, you can change those settings in the Speaker Settings menu. Save the measurement results first, then try to change the settings if you want.

Message list after Auto Calibration measurement

Error and warning code	Explanation
Error Code 31	The SPEAKERS is set to off. Set it to others and perform the Auto Calibration again.
Error Code 32	None of the speakers were detected. Make sure that the optimizer microphone is connected properly and perform the measurement again. If the optimizer microphone is connected properly but the error code appears, the optimizer microphone cable may be damaged or improperly connected.
Error Code 33	<ul style="list-style-type: none">• None of the front speakers are connected or only one front speaker is connected.• The optimizer microphone is not connected.• Either the left or right surround speakers is not connected.• Surround back speakers are connected even though surround speakers are not connected. Connect the surround speaker(s) to the SPEAKERS SURROUND terminals.• The surround back speaker is connected only to the SPEAKERS SURROUND BACK/ FRONT B/BI-AMP R terminals. When you connect only one surround back speaker, connect it to the SPEAKERS SURROUND BACK/Front B/BI-AMP L terminals.
Warning 40	The measurement has completed. However, the noise level is high. You may be able to perform the measurement properly if you try it again, even though the measurement cannot be performed in all environments. Try to perform the measurement in a quiet environment.
Warning 41	The input from the microphone is too big.
Warning 42	<ul style="list-style-type: none">• It may be the distance between the speaker and the microphone are too close. Retry the measurement after setting apart from each other.
Warning 43	The distance and position of a subwoofer cannot be detected. This may be caused by noise. Try to perform the measurement in a quiet environment.
NO WARNING	There is no warning information.

Error Code 31, 32, 33

1 When you press ⊕, “RETRY?” appears.

2 Press ←/→ to select “YES”.

3 Press ⊕.

The measurement starts in five seconds.

When “Warning” appears

If a warning on the measurement result is present, detailed information is displayed.

Press ⊕ to return to step 1 of “Confirming/saving the measurement results” (page 42).

Tip

Depending on the position of the subwoofer, the measurement results for polarity may vary. However, there will be no problems even if you continue to use the receiver with that value.

Guide to on-screen display operation

You can display the menu of the receiver on the TV screen and select the function you want to use on the TV screen by pressing $\uparrow/\downarrow/\leftarrow/\rightarrow$ and \oplus on the remote.

To display the menu of the receiver on the TV screen, make sure that the receiver is in "GUI MODE" following the steps in "7: Displaying the GUI menu on the TV screen" (page 37).

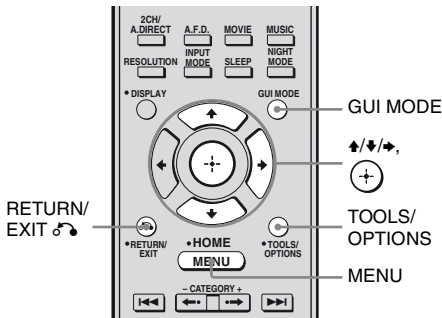

Using the menu

1 Press GUI MODE.

After "MENU ON" appears on the display for a while, "GUI" appears and the GUI menu appears on the TV screen. Press MENU if the GUI menu does not appear on the TV screen.

2 Press \uparrow/\downarrow repeatedly to select a menu you want.

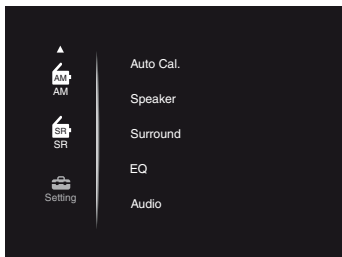

3 Press \oplus or \rightarrow to enter the menu.

The menu item list appears on the TV screen.

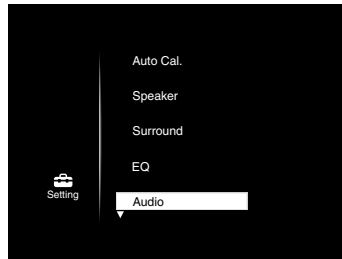

4 Press \uparrow/\downarrow repeatedly to select the menu item you want to adjust.

5 Press \oplus or \rightarrow to enter the menu item.

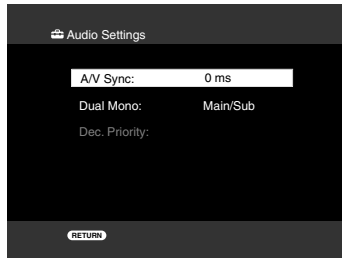

6 Press \uparrow/\downarrow repeatedly to select the parameter you want to adjust.

7 Press \oplus or \rightarrow to enter the parameter.

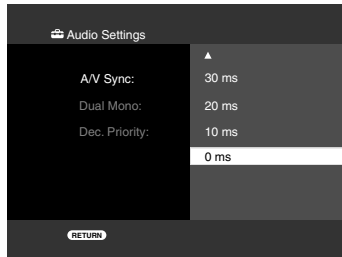

continued

8 Press **▲/▼** repeatedly to select the setting you want.

9 Press **⊕** to enter the setting.

10 Repeat steps 2 to 9 to make other settings.

To return to the previous screen

Press RETURN/EXIT **↵**.





To exit the menu

Press MENU.

To exit “GUI MODE”

Press GUI MODE. “MENU OFF” appears and you can operate the receiver using the menu in the display of the receiver.

Overview of the main menus

Menu icon	Description
 Input	Selects the input source component connected to the receiver (page 47).
 Music	Selects the music from the audio component connected to the DIGITAL MEDIA PORT adapter (page 49).
 Video	Selects the images from the video components connected to the DIGITAL MEDIA PORT adapter (page 49).
 FM/AM/SR	Selects the built-in FM/AM radio or satellite tuner connected (page 52, 55).
 Settings	You can adjust the settings of the speakers, the surround effect, equalizer, audio, video and other inputs connected to the HDMI jacks (page 70).

Using the option menu

When you press TOOLS/OPTIONS, the option menu for the selected main menu are displayed. You can select a related function without reselecting the menu.

1 Press GUI MODE.

After “MENU ON” appears on the display for a while, “GUI” appears and the GUI menu appears on the TV screen. Press MENU if the GUI menu does not appear on the TV screen.

2 Press **▲/▼** repeatedly to select a menu you want.

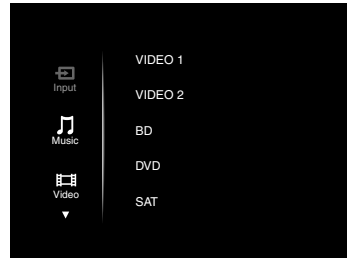

3 Press **⊕** or **→** to enter the menu.

The menu item list appears on the TV screen.

Example: when you select “Input”.

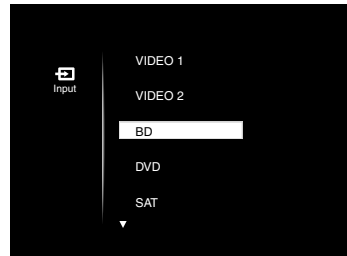

4 Press **TOOLS/OPTIONS** while the menu item list is displayed.

The option menu appears.

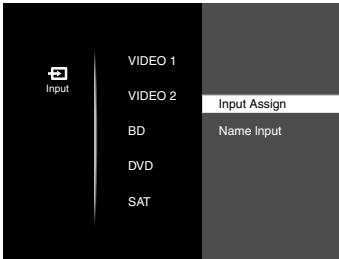

5 Press **↑/↓** repeatedly to select the option menu item you want, then press **+** or **→**.

6 Press **↑/↓** repeatedly to select the parameter you want, then press **+**.

To exit the menu

Press **MENU**.

Playback

Enjoying sound/images from the component connected to the receiver

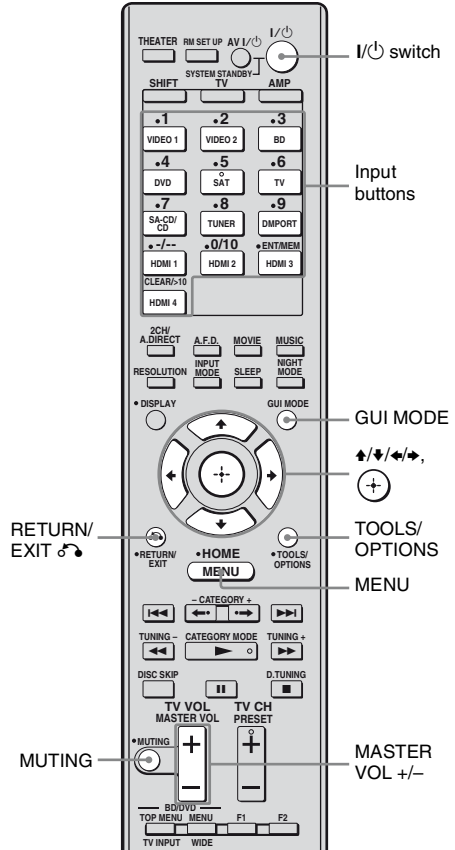

1 Press **GUI MODE**.

After “MENU ON” appears on the display for a while, “GUI” appears and the GUI menu appears on the TV screen. Press **MENU** if the GUI menu does not appear on the TV screen.

continued

2 Press **▲/▼** repeatedly to select “Input”, then press **⊕** or **▶**.

The menu item list appears on the TV screen.

3 Press **▲/▼** repeatedly to select the component you want, then press **⊕**.

Selected input	Components that can be played back
VIDEO 1	VCR, etc., connected to the VIDEO 1 jack
VIDEO 2	Camcorder, video game, etc., connected to the VIDEO 2 IN jack
BD	Blu-ray disc player, etc., connected to the BD jack
DVD	DVD player, etc., connected to DVD jack
SAT	Satellite tuner, set-top box, etc., connected to SAT jack
TV	TV, etc., connected to TV jack
SA-CD/CD/CD-R	Super Audio CD player, CD player, etc., connected to the SA-CD/CD/CD-R jack
HDMI 1, 2, 3, 4	HDMI components connected to the HDMI IN 1, HDMI IN 2, HDMI IN 3 (for AUDIO) or HDMI IN 4 jack

4 Turn on the component and start playback.

5 Press **MASTER VOL +/-** to adjust the volume.

You can also use **MASTER VOLUME** on the receiver.

Tips

- You can press **INPUT SELECTOR +/-** on the receiver repeatedly or press input buttons on the remote to select the component you want.
- You can adjust the volume differently depending on the speed with which you turn the **MASTER VOLUME** on the receiver.
To turn the volume up or down quickly: turn the knob quickly.
To make fine adjustment: turn the knob slowly.
- You can adjust the volume differently depending on the length of time you press and hold the **MASTER VOL +/-** button on the remote.
To turn the volume up or down quickly: press and hold the button.
To make a fine adjustment: press the button and release it immediately.

To activate the muting function

Press **MUTING**.

The muting function will be canceled when you do the following.

- Press **MUTING** again.
- Increase the volume.
- Turn off the receiver.

To avoid damaging your speakers

Before you turn off the receiver, be sure to turn down the volume level.

Naming the input (Name Input)

You can enter a name of up to 8 characters for inputs and display it.

This is convenient for labeling the jacks with the names of the connected components.

- 1 Press **▲/▼** repeatedly on the “Input” screen to select the input you want.
- 2 Press **TOOLS/OPTIONS**.
- 3 Press **▲/▼** repeatedly to select “Name Input”, then press **+**.

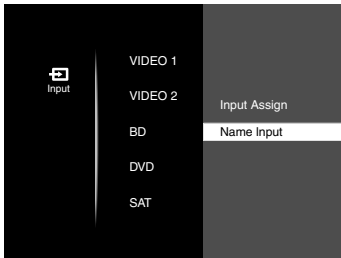

- 4 Press **▲/▼/◀/▶** to select a character, then press **+**.

The name you entered is registered.

To cancel naming input

Press **RETURN/EXIT** **↵**.

Enjoying sound/images from the components connected to the DIGITAL MEDIA PORT

The DIGITAL MEDIA PORT (DMPORT) allows you to enjoy picture and sound from a network system such as a portable audio/video source or computer.

For details on connecting the DIGITAL MEDIA PORT adapter, see “Connecting audio components” (page 23).

Sony offers the following DIGITAL MEDIA PORT adapters as of May 2009:

- TDM-BT1/BT10 Bluetooth™ Wireless Audio Adapter
- TDM-NW10 DIGITAL MEDIA PORT Adapter
- TDM-NC1 Wireless Network Audio Client
- TDM-iP10/iP50 DIGITAL MEDIA PORT Adapter
- TDM-MP10 DIGITAL MEDIA PORT Adapter

The DIGITAL MEDIA PORT adapter is an optional product.

Notes

- Do not connect an adapter other than the DIGITAL MEDIA PORT adapter to the DMPORT jack.
- Before disconnecting the DIGITAL MEDIA PORT adapter, be sure to turn off the receiver.
- Do not connect or disconnect the DIGITAL MEDIA PORT adapter while the receiver is turned on.
- Depending on the type of DIGITAL MEDIA PORT adapter, video output may not be possible.
- The DIGITAL MEDIA PORT adapters are available for purchase depending on the area.

Selecting the operation screen

You can select an operation screen using the GUI menu, depending on the DIGITAL MEDIA PORT adapter you want to use. For some adapter, such as TDM-BT1, the operation screen is fixed and you cannot change it on the GUI screen.

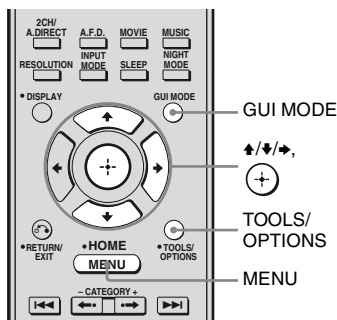

1 Press GUI MODE.

After “MENU ON” appears on the display for a while, “GUI” appears and the GUI menu appears on the TV screen. Press MENU if the GUI menu does not appear on the TV screen.

2 Press \uparrow/\downarrow repeatedly to select “Music” or “Video”, then press \oplus or \rightarrow .

3 Press TOOLS/OPTIONS.

4 Press \uparrow/\downarrow repeatedly to select the mode you want, then press \oplus .

The details of each mode are as follows:

- System GUI
This mode is for the TDM-iP50 and TDM-NC1. The list of tracks will be displayed on the GUI screen of the receiver. You can select a track you want and play it back on each GUI screen.
- iPod
This mode is for the TDM-iP50.

If the option menu does not appear on the screen, refer to the operating instructions of the connected component.

When an adapter other than iPod is connected, a hierarchical menu does not appear.

Operating the component connected to the DIGITAL MEDIA PORT adapter

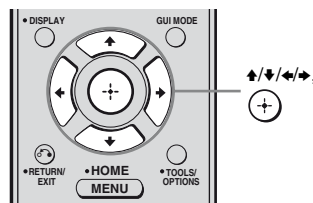

To operate the TDM-iP50 or TDM-NC1 using the GUI menu of the receiver

1 Make sure that “System GUI” is selected in step 4 in “Selecting the operation screen” (page 50).

2 Press $\uparrow/\downarrow/\leftarrow/\rightarrow$ repeatedly to select the content you want from the contents list displayed on the GUI screen, press \oplus to play it back.

Contents list for audio

- iPod
 - Playlists > Playlist > Track
 - Artists > Artist > Album > Track
 - Albums > Album > Track
 - Songs > Track
 - Genres > Genre > Artist > Album > Track
 - Composers > Composer > Track
 - Audiobooks > Audiobook

- Network Client
 - Music Surfin^{a)} > Album^{c)} > Track
 - Playlist^{a)} > Playlist > Track
 - Web Radio^{a)} > Station > Program
 - Music Library^{b)} > Album > Track

a) Displayed only when M-crew Server is connected.

b) Displayed only when a DLNA server other than M-crew Server is connected.

c) Displayed as “Genre”, “Artist” or “Album”, depending on setting of “List Mode”.

Contents list for video

- iPod
 - Movies > Content
 - TV Shows > Episode > Content
 - Music Videos > Artist > Content
 - Video Playlists > Video Playlist > Content
 - Video Podcasts > Episode > Content

To operate the TDM-iP50 using the iPod menu

Make sure that “iPod” is selected in step 4 in “Selecting the operation screen” (page 50).

For details on operating the iPod, refer to the operating instructions supplied with the iPod.

Playing the selected track

During playback of the selected track, the displayed screen changes depending on the DIGITAL MEDIA PORT adapter connected.

Example of a “System GUI” screen

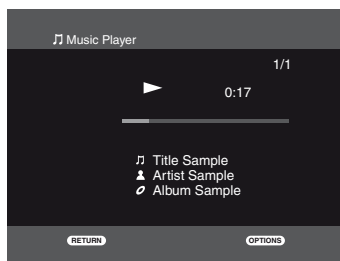

You can operate the components connected to the DIGITAL MEDIA PORT adapter using the following buttons on the remote of the receiver.

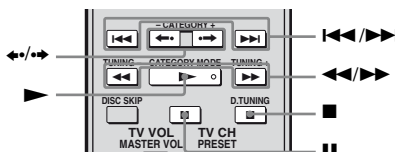

To	Do the following
Play	Press ▶ .
Pause	Press ⏸ . To resume play, press the button again.
Stop	Press ■ .
Find the beginning of a track during playback, or find the beginning of the previous track	Press ◀◀ .
Find the beginning of the next track	Press ▶▶ .
Skip to the previous album	Press ◀ .
Skip to the next album	Press ▶ .
Go backward/forward	Press ◀◀/▶▶ .*

* Fast-backward/forward while pressing and holding the **◀◀/▶▶** button.

continued

Option parameters in the play modes

■ Repeat Mode (TDM-iP50 only)

- OFF
- One
- All

■ Shuffle (TDM-iP50 only)

- OFF
- Songs
- Albums

■ List Mode (TDM-NC1 only)

- All Tracks
- Disc List
- Artist List
- Genre List

■ Audiobook Speed (TDM-iP50 only)

- Low
- Normal
- High

DIGITAL MEDIA PORT message list

Message appears	Explanation
No Adapter	The adapter is not connected.
No Device	There is no device connected to the adapter.
No Audio	No audio file was found.
Loading	The data is being read.
No Server*	There is no server connected.
No Track*	No track was found.
No Item	No item was found.
Connecting*	Connecting to the server.
Configuring*	The network is setting up.
Warning*	Check the display of the DIGITAL MEDIA PORT adapter.
Searching*	Searching the server.

* TDM-NC1 only.

Tuner Operations

Listening to FM/AM radio

You can listen to FM and AM broadcasts through the built-in tuner. Before operation, make sure you have connected the FM and AM antennas (aerials) to the receiver (page 35).

Tip

The tuning scale for direct tuning differs depending on the area code as shown in the following table. For details on area codes, see page 4.

Area code	FM	AM
U, CA	100 kHz	10 kHz*

* The AM tuning scale can be changed (page 54).

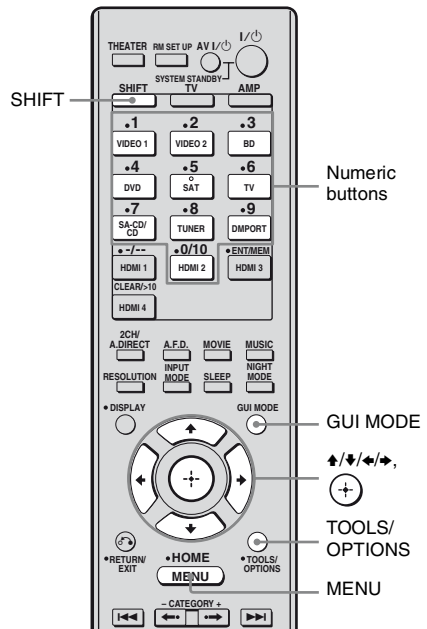

Tuning into a station automatically (Auto Tuning)

1 Press GUI MODE.

After “MENU ON” appears on the display for a while, “GUI” appears and the GUI menu appears on the TV screen. Press MENU if the GUI menu does not appear on the TV screen.

2 Press \uparrow/\downarrow repeatedly to select “FM” or “AM”, then press \oplus or \rightarrow .

The FM or AM menu list appears on the TV screen.

3 Press \uparrow/\downarrow repeatedly to select “Auto Tuning”, then press \oplus or \rightarrow .

4 Press \uparrow/\downarrow .

Press \uparrow to scan from low to high, press \downarrow to scan from high to low.

The receiver stops scanning whenever a station is received.

In case of poor FM stereo reception

- 1 Tune in the station you want to listen to using Auto Tuning, Direct Tuning (page 53), or select the preset station you want (page 54).
- 2 Press TOOLS/OPTIONS.
- 3 Press \uparrow/\downarrow repeatedly to select “FM Mode”, then press \oplus or \rightarrow .
- 4 Press \uparrow/\downarrow repeatedly to select “MONO”, then press \oplus .

Tuning into a station directly (Direct Tuning)

You can enter the frequency of a station directly by using the numeric buttons.

1 Press GUI MODE.

After “MENU ON” appears on the display for a while, “GUI” appears and the GUI menu appears on the TV screen. Press MENU if the GUI menu does not appear on the TV screen.

2 Press \uparrow/\downarrow repeatedly to select “FM” or “AM”, then press \oplus or \rightarrow .

3 Press \uparrow/\downarrow repeatedly to select “Direct Tuning”, then press \oplus or \rightarrow .

4 Press SHIFT, then press numeric buttons to enter the frequency.

Example 1: FM 102.50 MHz

Select 1 \rightarrow 0 \rightarrow 2 \rightarrow 5

Example 2: AM 1,350 kHz

Select 1 \rightarrow 3 \rightarrow 5

Tip

If you have tuned in an AM station, adjust the direction of the AM loop antenna (aerial) for optimum reception.

5 Press \oplus .

If you cannot tune in a station

“---.--- MHz” appears and then the screen returns to the current frequency.

Make sure you have entered the right frequency. If not, repeat step 4. If you still cannot tune in a station, the frequency is not used in your area.

Changing the AM tuning scale

You can change the AM tuning scale to either 9 kHz or 10 kHz on the receiver.

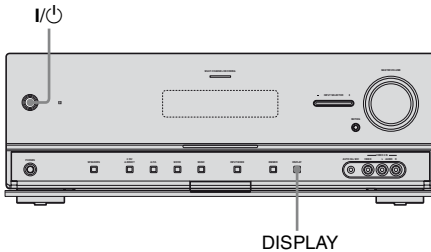

- 1 Press I/O to turn off the receiver.**
- 2 While holding down DISPLAY, press I/O on the receiver.**
- 3 Change the current AM tuning scale to 9 kHz (or 10 kHz).**

To reset the scale to 10 kHz (or 9 kHz), repeat the procedure above.

Note

All preset stations will be erased when you change the tuning scale.

Presetting FM/AM radio stations

You can preset up to 30 FM and 30 AM stations. Then you can easily tune in the stations you often listen to.

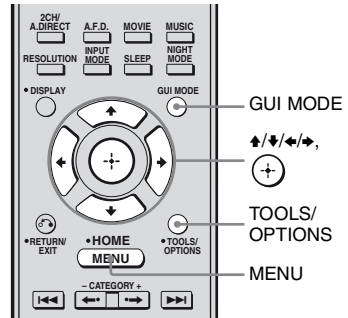

- 1 Press GUI MODE.**

After "MENU ON" appears on the display for a while, "GUI" appears and the GUI menu appears on the TV screen. Press MENU if the GUI menu does not appear on the TV screen.
- 2 Press \uparrow/\downarrow repeatedly to select "FM" or "AM", then press \oplus or \rightarrow .**
- 3 Tune in the station that you want to preset using Automatic Tuning (page 53) or Direct Tuning (page 53).**

In case of poor FM stereo reception, switch the FM reception mode (page 53).
- 4 Press TOOLS/OPTIONS.**

The option menu appears.
- 5 Press \uparrow/\downarrow repeatedly to select "Memory", then press \oplus or \rightarrow .**
- 6 Press \uparrow/\downarrow repeatedly to select a preset number.**

7 Press **(+)**.

The station is stored as the selected preset number.

8 Repeat steps 3 to 7 to preset another station.

You can store station as follows:

- AM band: AM 1 to AM 30
- FM band: FM 1 to FM 30

Tuning to preset stations**1** Repeat steps 1 and 2 of “Presetting FM/AM radio stations”.**2** Press **▲/▼** repeatedly to select the preset station you want.

Preset numbers from 1 to 30 are available.

Naming preset stations (Name Input)**1** On “FM” or “AM” screen, press **▲/▼** repeatedly to select the preset number on which you have stored the station and which you want to name.**2** Press **TOOLS/OPTIONS**.

The option menu appears.

3 Press **▲/▼** repeatedly to select “Name Input”, then press **(+)**.**4** Press **▲/▼/◀/▶** to select a character, then press **(+)**.

The name you entered is registered.

Listening to Satellite Radio

To listen to Satellite Radio, you’ll need to connect a SIRIUS Satellite Radio tuner (sold separately) to your Sirius-Ready receiver. SIRIUS Satellite Radio is available to residents of the US (except Alaska and Hawaii) and Canada.

Satellite Radio delivers a variety of commercial-free music from categories ranging from Pop, Rock, Country, R&B, Dance, Jazz, Classical and many more plus coverage of all the top professional and college sports including play by play games from select leagues and teams. Additional programming includes expert sports talk, uncensored entertainment, comedy, family programming, local traffic and weather and news from your most trusted sources.

Once you’ve purchased a SIRIUS tuner you’ll need to activate it and subscribe to begin enjoying the service. Easy to follow installation and setup instructions are provided with the SIRIUS tuner. There are a variety of programming packages available, including the option of adding “The Best of XM” programming to the SIRIUS service. The “Best of XM” service is not available to SIRIUS Canada subscribers at this time. Please check with SIRIUS Canada for any updates using the numbers and web address below.

Family friendly packages are also available to restrict channels featuring content that may be inappropriate for children.

To subscribe to SIRIUS, U.S. and Canadian customers can call 1-888-539-SIRI (1-888-539-7474) or visit sirius.com (US) or siriuscanada.ca (Canada).

SIRIUS and all related marks and logos are trademarks of Sirius XM Radio Inc. and its subsidiaries. All other marks and logos are the property of their respective owners. All rights reserved. SIRIUS subscription sold separately. Taxes and a one-time activation fee may apply. SIRIUS tuner required (sold separately) to receive the SIRIUS service. All programming and fees subject to change. It is prohibited to copy, decompile, disassemble, reverse engineer, hack, manipulate or otherwise make available any technology or software incorporated in receivers compatible with the SIRIUS Satellite Radio System. **Service not available in Alaska or Hawaii.**

Connecting the SIRIUS Satellite Radio

Connect the SiriusConnect Home tuner. When you use the SiriusConnect Home tuner with this receiver, be sure to connect the AC power adaptor supplied with the tuner to a wall outlet.

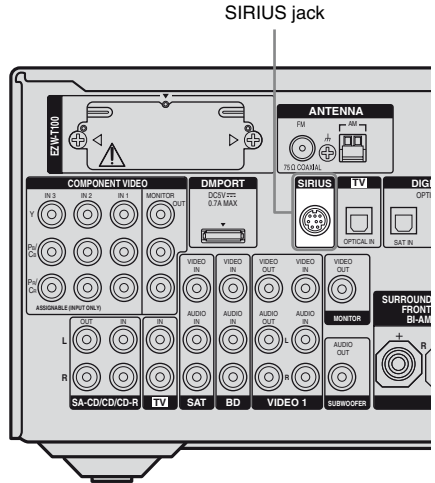

Note

Keep the SiriusConnect Home tuner, antenna, and AC power adaptor away from the speaker cords and the power cord to avoid picking up noise.

Preparing to listen to the SIRIUS Satellite Radio

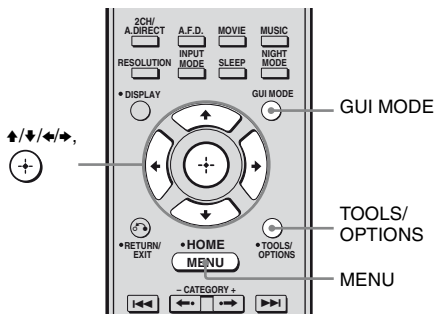

Checking receiving conditions (Antenna Aiming)

- 1 Press GUI MODE.**
After "MENU ON" appears on the display for a while, "GUI" appears and the GUI menu appears on the TV screen. Press MENU if the GUI menu does not appear on the TV screen.
- 2 Press \uparrow/\downarrow repeatedly to select "SR", then press \oplus or \rightarrow .**
- 3 Press TOOLS/OPTIONS, then press \uparrow/\downarrow repeatedly to select "Antenna", then press \oplus or \rightarrow .**
- 4 While checking the quality of the reception, adjust the direction of the antenna to obtain the best reception.**

Checking the SIRIUS Radio ID

- 1 Press GUI MODE.**
After "MENU ON" appears on the display for a while, "GUI" appears and the GUI menu appears on the TV screen. Press MENU if the GUI menu does not appear on the TV screen.
- 2 Press \uparrow/\downarrow repeatedly to select "SR", then press \oplus or \rightarrow .**
- 3 Press TOOLS/OPTIONS, then press \uparrow/\downarrow repeatedly to select "Sirius ID", then press \oplus or \rightarrow .**
- 4 Check the SIRIUS ID on the TV screen and write it in the space provided here.**

ID: _____

You can also check the SIRIUS ID using the display on the receiver.

To exit the menu

Press MENU.

Selecting a channel of the SIRIUS Satellite Radio

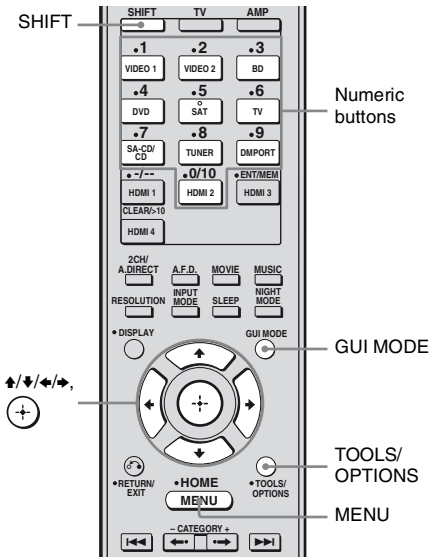

3 Press **▲/▼** repeatedly to select the category, then press **⊕** or **▶**.

- All: You can select a channel from all the categories.
- (category name): You can select a channel from one category.

Note

When the “Preset Mode” screen is displayed, press TOOLS/OPTIONS, then press **▲/▼** repeatedly to select “Category Mode”.

4 Press **▲/▼** repeatedly to select the channel, then press **⊕**.

The selected channel is being received. The channel information is displayed on the TV screen.

Note

When you select a channel in the “Category Mode,” the channel you selected may not be the one in the category you want. This is because one channel may belong to more than one category.

Selecting a channel by category (Category Mode)

You can select a channel from one category or all the categories.

1 Press **GUI MODE**.

After “MENU ON” appears on the display for a while, “GUI” appears and the GUI menu appears on the TV screen. Press MENU if the GUI menu does not appear on the TV screen.

2 Press **▲/▼** repeatedly to select “SR”, then press **⊕** or **▶**.

Selecting a channel by inputting the channel number directly (Direct Tuning)

- 1 Press GUI MODE.**

After “MENU ON” appears on the display for a while, “GUI” appears and the GUI menu appears on the TV screen. Press MENU if the GUI menu does not appear on the TV screen.
- 2 Press \uparrow/\downarrow repeatedly to select “SR”, then press \oplus or \rightarrow .**
- 3 Press TOOLS/OPTIONS.**
- 4 Press \uparrow/\downarrow repeatedly to select “Direct Tuning”, then press \oplus .**
- 5 Press SHIFT, then press numeric buttons to enter the channel number.**
- 6 Press \oplus .**

The selected channel is tune in.

Presetting SIRIUS Satellite Radio channels

You can select the channels you want directly by presetting them using the preset numbers. You can preset up to 30 SIRIUS Satellite Radio channels.

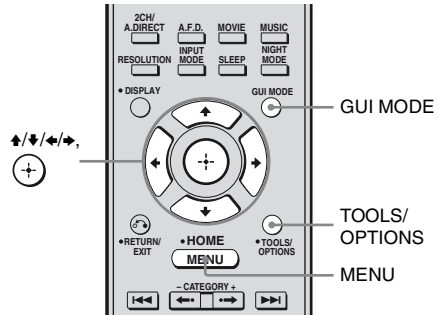

Presetting channels using the preset numbers

- 1 Press GUI MODE.**

After “MENU ON” appears on the display for a while, “GUI” appears and the GUI menu appears on the TV screen. Press MENU if the GUI menu does not appear on the TV screen.
- 2 Press \uparrow/\downarrow repeatedly to select “SR”, then press \oplus or \rightarrow .**
- 3 Select a channel you want to preset using Category Tuning (page 58) or Direct Tuning (page 59).**
- 4 Press TOOLS/OPTIONS.**
- 5 Press \uparrow/\downarrow repeatedly to select “Memory”, then press \oplus or \rightarrow .**

continued

- 6** Press **▲/▼** repeatedly to select the preset channel you want, then press **+**.

Preset channels from 1 to 30 are available, and a default channel is preset for all the preset channels when you purchase the receiver.

The selected channel is registered as the preset channel you selected in step 3.

- 7** Repeat steps 3 to 6 to preset another channel.

Selecting the channel by using the preset numbers

- 1** Repeat steps 1 and 2 of “Presetting channels using the preset numbers” (page 59).

- 2** Press **▲/▼** repeatedly to select the preset number from the preset list, then press **+**.

You can select stored preset channels from 1 to 30.

Notes

- The channel information you have preset may be changed if SIRIUS Satellite Radio Inc. change their channel programming.
- When the “Category Mode” screen is displayed, press TOOLS/OPTIONS, then press **▲/▼** repeatedly to select “Preset Mode”.

Restricting access to specific channels (Parental Lock)

You can restrict access to certain channels using your own lock code. The lock code is set to “0000” as the default.

Change the lock code before you use this function for the first time. See “To change the lock code (Lock Code)” (page 61).

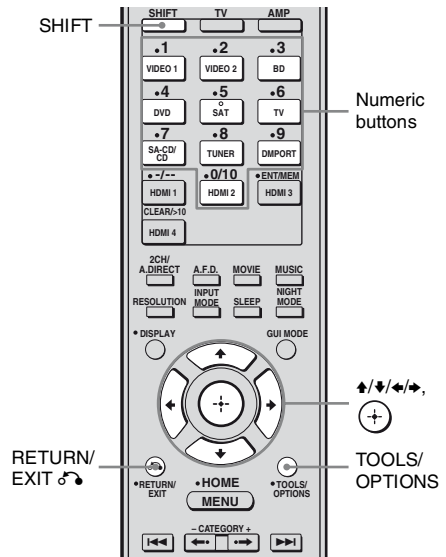

- 1** Select a channel you want to lock using **Category Mode** (page 58) or **Direct Tuning** (page 59).
- 2** Press **TOOLS/OPTIONS**.
The option menu appears.
- 3** Press **▲/▼** repeatedly to select “Parental Lock”, then press **+** or **➡**.

4 Press **▲/▼** repeatedly to select “ON”, then press **⊕**.

“Enter your 4-digit lock code.” appears.

5 Press **SHIFT**, then press the numeric buttons to enter your 4-digit lock code.

“The channel has been locked.” appears and the Parental Lock is set.

To delete the numbers you have entered, go back to step 2 by pressing **RETURN/EXIT** **↵**, and then repeat the procedure above from step 2.

To change the lock code (Lock Code)

1 Select a channel you want to change the lock code using Category Mode (page 58) or Direct Tuning (page 59).

2 Press **TOOLS/OPTIONS**. The option menu appears.

3 Press **▲/▼** repeatedly to select “Lock Code”, then press **⊕**. “Enter your 4-digit lock code.” appears.

4 Press **SHIFT**, then press the numeric buttons to enter your 4-digit lock code. “Enter a new lock code.” appears.

5 Enter a new 4-digit lock code using the numeric buttons. “To confirm, enter your new lock code again.” appears.

6 Reenter the new lock code with the numeric buttons. “The lock code has been changed.” appears.

To listen to the locked channels

1 Select a locked channel you want to listen to using Direct Tuning (page 59). “Enter your 4-digit lock code.” appears.

2 Press **SHIFT**, then press the numeric buttons to enter your 4-digit lock code. The channel is tuned in.

To cancel the Parental Lock

1 Select a channel you want to unlock using Direct Tuning (page 59).

2 Press **TOOLS/OPTIONS**. The option menu appears.

3 Press **▲/▼** repeatedly to select “Parental Lock”, then press **⊕** or **▶**.

4 Press **▲/▼** repeatedly to select “OFF”, then press **⊕**. “Enter your 4-digit lock code.” appears.

5 Press **SHIFT**, then press the numeric buttons to enter your 4-digit lock code. “The channel has been unlocked.” appears and the channel is unlocked.

Notes

- When you select a channel using Category Mode, locked channels are skipped.
- When the receiver is reset to the factory settings, the lock code returns to the default (0000), but the Parental Lock settings are not removed.
- You cannot preset locked channels. If you set the Parental Lock for a preset channel, the preset information for that channel returns to the default.
- You cannot set the Parental Lock for channel 0 and channel 184.

SIRIUS Satellite Radio message list

Message appears on TV screen [Display]	Explanation	Remedies
Antenna [ANTENNA]	The antenna is not connected properly.	Check the connection between the SiriusConnect Home tuner and the antenna.
Acquiring [ACQUIRING]	The receiving condition is not good.	Try moving the antenna to another location. For details about the antenna location, refer to the operating instructions supplied with the SiriusConnect Home tuner.
UNSUB CH [CALL 888, 539-SIRI]*	You have not subscribed for the selected channel.	—
SR Tuner [SR TUNER]	The SiriusConnect Home tuner is not connected properly.	Check all the connections, and then turn the system on again. Also make sure if the AC adaptor supplied with the SiriusConnect Home tuner is connected to a wall socket.
Invalid [INVALID]	You have entered an invalid channel number.	The channel to be tuned-in is void due to the change by the broadcast service, or the receiving condition is not good.
Locked CH [LOCKED CH]	The selected channel is locked.	—
SUB UPDT [SUB UPDT]	The subscription information has been updated.	—
Updating [UPDATING]	Channel information is being updated.	—
FW UPDT [FW UPDT]	The SiriusConnect Home tuner firmware is being updated.	—
----	There is no text information in the channel.	This is not an error. The text information may not be displayed depending on the system condition, for example, right after the system has received a channel.

* “CALL 888” and “539-SIRI” appears on the display alternately.

Playing back with 2-channel sound

You can switch the output sound to 2-channel sound regardless of the recording formats of the software you are using, the playback component connected, or the sound field settings of the receiver.

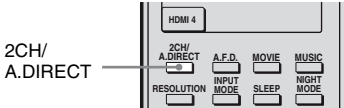

Press 2CH/A.DIRECT repeatedly to select the 2-channel sound mode of the sound output you want.

Types of 2CH mode

2CH mode (appears on TV screen)	Effect
2 CHANNEL STEREO [2ch stereo]	The receiver outputs the sound from the front left/right speakers only. There is no sound from the subwoofer. Standard 2 channel stereo sources completely bypass the sound field processing and multi channel surround formats are downmixed to 2 channel (except LFE signals).
ANALOG DIRECT [Analog Direct]	You can switch the audio of the selected input to 2 channel analog input. This function enables you to enjoy high quality analog sources. When using this function, only the volume and front speaker level can be adjusted.

Notes

- When headphones are connected, "HP (Direct)" appears on the TV screen.
- You cannot select "Analog Direct" when you select DVD, DMPORT and HDMI 1-4 as input.

Playing back with multi-channel surround

The Auto Format Direct (A.F.D.) mode allows you to listen to higher fidelity sound and select the decoding mode for listening to a 2 channel stereo sound as multi channel sound.

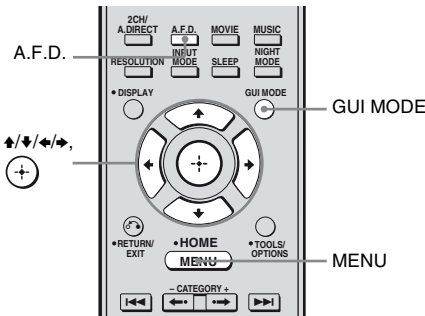

Press A.F.D. repeatedly to select the A.F.D. mode you want.

Types of A.F.D. mode

A.F.D. mode [appears on TV screen]	Multi channel audio after decoding	Effect
A.F.D. AUTO [A.F.D. Auto]	(Detecting automatically)	Presets the sound as it was recorded/encoded without adding any surround effects.
ENHANCED SURROUND MODE [Enhanced Sur]	–	You can select the surround sound effect you want. For details, see “Setting a multi channel surround sound effect” (page 65).
MULTI STEREO [Multi Stereo]	(Multi Stereo)	Outputs 2 channel left/right signals from all speakers. However, sound may not be output from certain speakers depending on the speaker settings.

Notes

- This function does not work in the following cases.
 - DTS-HD signals with a sampling frequency of more than 48 kHz are being received.
 - Dolby TrueHD signals with a sampling frequency of more than 48 kHz are being received.
 - “Analog Direct” is being used.
- The beginning of the sound stream may be dropped out when Neural-THX[®] processing is turned on or off.

Tips

- You can identify the encoding format of DVD software, etc., by looking at the logo on the package.
- When a multi channel signal is input, only Dolby Pro Logic IIx decoding is effective.
- Neural-THX is effective when 2 channel or 5.1 channel signals are input.

If you connect a subwoofer

This receiver will generate a low frequency signal for output to the subwoofer when there is no LFE signal, which is a low-pass sound effect output to a subwoofer from a 2 channel signal. However, the low frequency signal is not generated for “Neo:6 Cinema” or “Neo:6 Music” when all speakers are set to “Large”. In order to take full advantage of the Dolby Digital bass redirection circuitry, we recommend setting the subwoofer’s cut off frequency as high as possible.

Setting a multi channel surround sound effect

- 1 Start playing a sound source you want to listen to (CD, DVD, etc.).**
- 2 Press GUI MODE.**
After “MENU ON” appears on the display for a while, “GUI” appears and the GUI menu appears on the TV screen. Press MENU if the GUI menu does not appear on the TV screen.
- 3 Press \uparrow/\downarrow repeatedly to select “Settings” then press \odot or \rightarrow .**
The Settings menu list appears on the TV screen.
- 4 Press \uparrow/\downarrow repeatedly to select “Surround”, then press \odot or \rightarrow .**
- 5 Press \uparrow/\downarrow repeatedly to select “E.Sur Mode”, then press \odot .**
The menu for surround sound effect appears.
- 6 Press \uparrow/\downarrow repeatedly to select the A.F.D. mode you want, then press \odot .**

Types of enhanced surround mode

Enhanced surround mode [appears on TV screen]	Multi channel audio after decoding	Effect
PRO LOGIC II* [Pro Logic II]	5-channel signals	Performs Dolby Pro Logic II mode decoding. A source recorded in 2 channel format is decoded into 5.1 channels. This setting is ideal for movies encoded in Dolby Surround. In addition, this mode can reproduce sound in 5.1 channel system for watching videos of overdubbed or old movies.
PRO LOGIC IIX* [Pro Logic IIX]	7-channel signals	Performs Dolby Pro Logic IIX mode decoding. A source recorded in 2 channel or 5.1 channel format is decoded into 7.1 channels. This setting is ideal for movies encoded in Dolby Surround. In addition, this mode can reproduce sound in 7.1 channel system for watching videos of overdubbed or old movies.
NEO:6 CINEMA [Neo:6 Cinema]	7-channel signals	Performs DTS Neo:6 Cinema mode decoding. A source recorded in 2 channel format is decoded into 7 channels.
NEO:6 MUSIC [Neo:6 Music]	7-channel signals	Performs DTS Neo:6 Music mode decoding. A source recorded in 2 channel format is decoded into 7 channels. This setting is ideal for normal stereo sources such as CDs.
NEURAL-THX® [Neural-THX]	7-channel signals	Next generation of Neural-THX® Surround. In addition to stereo enhancement processing and pure discrete 5.1 surround sound, now capable of full 360° 7.1 surround sound playback from Neural-THX® Surround encoded content.

* You can select “Pro Logic II” when there is no surround back speaker on the “SP Pattern” menu, or you can select “Pro Logic IIX” when there is a surround back speaker. You cannot select both settings at the same time.

Enjoying a surround effect for music/movie

You can take advantage of surround sound simply by selecting one of the receiver's preprogrammed sound fields. They bring the exciting and powerful sound of movie theaters and concert halls into your home.

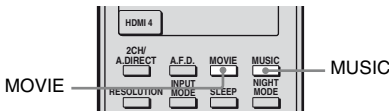

Press MUSIC or MOVIE repeatedly to select the surround effect you want for music or movie.

Types of music/movie mode

Sound field for	Sound field [appears on TV screen]	Effect
Movie	CINEMA STUDIO EX A [Cinema St EX A] D C S	Reproduces the sound characteristics of the Sony Pictures Entertainment "Cary Grant Theater" cinema production studio. This is a standard mode, great for watching almost any type of movie.
	CINEMA STUDIO EX B [Cinema St EX B] D C S	Reproduces the sound characteristics of the Sony Pictures Entertainment "Kim Novak Theater" cinema production studio. This mode is ideal for watching science-fiction or action movies with lots of sound effects.
	CINEMA STUDIO EX C [Cinema St EX C] D C S	Reproduces the sound characteristics of the Sony Pictures Entertainment scoring stage. This mode is ideal for watching musicals or films where orchestra music is featured in the soundtrack.
	VIRTUAL MULTI DIMENSION D C S [V.M. Dimension]	Creates many virtual speakers from a single pair of actual surround speakers.
Music	HALL [Hall]	Reproduces the acoustics of a classical concert hall.
	JAZZ CLUB [Jazz Club]	Reproduces the acoustics of a jazz club.
	LIVE CONCERT [Live Concert]	Reproduces the acoustics of a 300-seat live house.
	STADIUM [Stadium]	Reproduces the feeling of a large open-air stadium.
	SPORTS [Sports]	Reproduces the feeling of sports broadcasting.
	PORTABLE AUDIO ENHANCER [Portable Audio]	Reproduces a clear enhanced sound image from your portable audio device. This mode is ideal for MP3 and other compressed music.
Headphone ^{a)}	HEADPHONE (2CH) [HP (2CH)]	This mode is selected automatically if you use headphones when 2ch Stereo mode (page 63)/A.F.D. mode (page 64) is selected. Standard 2 channel stereo sources completely bypass the sound field processing and multi channel surround formats are downmixed to 2 channels (except LFE signals).
	HEADPHONE (DIRECT) [HP (Direct)]	Outputs the analog signals without processing by the equalizer, sound field, etc.

^{a)}You can only select this sound field if the headphones are connected to the receiver.

continued

Notes

- The sound fields for music and movies do not work in the following cases.
 - PCM signals with a sampling frequency of more than 48 kHz are being received.
 - DTS 96/24 signals are being received.
 - DTS-HD signals with a sampling frequency of more than 48 kHz are being received.
 - Dolby TrueHD signals with a sampling frequency of more than 48 kHz are being received.
 - Signals with a sampling frequency of more than 48 kHz are being received.
 - The multi channel PCM signals are received via an HDMI IN jack with a sampling frequency more than 48 kHz.
- When one of the sound fields for music is selected, no sound is output from the subwoofer if all the speakers are set to “Large” on the Speaker Settings menu. However, the sound will be output from the subwoofer if
 - the digital input signal contains LFE signals.
 - the front and surround speakers are set to “Small”.
 - the sound field for movie is selected.
 - “Portable Audio” is selected.
- The effects provided by the virtual speakers may cause increased noise in the playback signal.
- When listening with sound fields that employ the virtual speakers, you will not be able to hear any sound coming directly from the surround speakers.

Tips

- You can identify the encoding format of DVD software, etc., by looking at the logo on the package.
- Sound fields with **DCS** marks use DCS technology. See “Glossary” (page 122).

To turn off the sound field for movie/music

Press 2CH/A.DIRECT or A.F.D.

Digital audio formats supported by the receiver

Digital audio formats that this receiver can decode depend on digital audio input jacks for the components connected.

This receiver supports the following audio formats.

Audio format	Maximum number of channels	Connection of the playback component and the receiver	
		COAXIAL/OPTICAL	HDMI
Dolby Digital	5.1ch	○	○
Dolby Digital EX	6.1ch	○	○
Dolby Digital Plus ^{a)}	7.1ch	×	○
Dolby TrueHD ^{a)}	7.1ch	×	○
DTS	5.1ch	○	○
DTS-ES	6.1ch	○	○
DTS 96/24	5.1ch	○	○
DTS-HD High Resolution Audio ^{a)}	7.1ch	×	○
DTS-HD Master Audio ^{a)b)}	7.1ch	×	○
Multi channel Linear PCM ^{a)}	7.1ch	×	○

^{a)} Audio signals are output in another format if the playback component does not correspond to the format. For details, refer to the operating instructions of the playback component.

^{b)} Signals with a sampling frequency of more than 96 kHz are played back at 96 kHz.

Resetting sound fields to the initial settings

Be sure to use the buttons on the receiver for this operation.

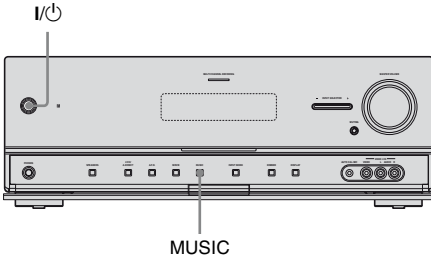

- 1 Press I/O to turn off the receiver.**
- 2 While holding down MUSIC, press I/O.**

“S.F. CLEAR” appears on the display and all sound fields are reset to their initial setting.

Amplifier Operations

Using the setting menu

You can adjust various settings for speakers, surround effects, etc. using the setting menu. To display the menu of the receiver on the TV screen, make sure that the receiver is in “GUI MODE” by following the steps in “7: Displaying the GUI menu on the TV screen” (page 37).

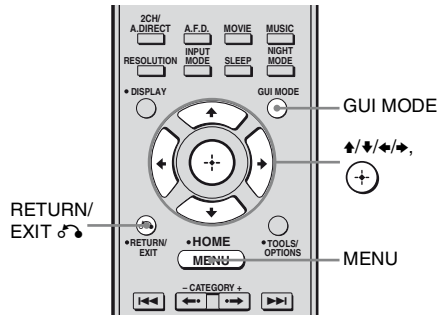

1 Press GUI MODE.

After “MENU ON” appears on the display for a while, “GUI” appears and the GUI menu appears on the TV screen. Press MENU if the GUI menu does not appear on the TV screen.

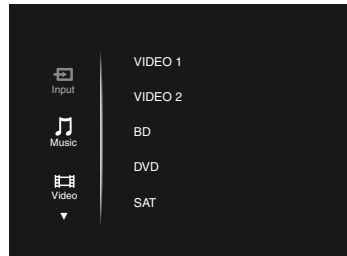

- 2** Press **▲/▼** repeatedly to select “Settings”, then press **⊕** or **▶**, to enter the menu mode.

The setting menu list appears on the TV screen.

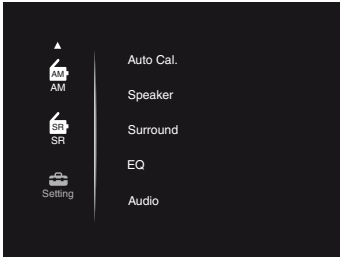

- 3** Press **▲/▼** repeatedly to select the menu item you want, then press **⊕** or **▶**.

Example: When you select “Auto Cal.”.

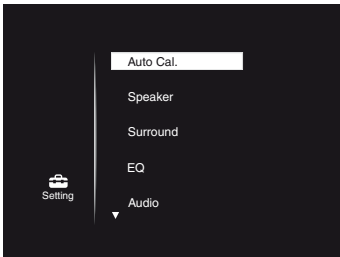

- 4** Press **▲/▼** repeatedly to select the parameter you want, then press **⊕** or **▶**.

To return to the previous screen

Press RETURN/EXIT **↶**.

To exit the menu

Press MENU.

Setting menu list

Menu	Description
Auto Cal.	Sets the speaker level or distance and makes the measurement automatically (page 72).
Speaker	Sets the speaker position and impedance manually (page 73).
Surround	Adjusts the sound field (surround effect) you choose (page 77).
EQ	Adjusts the equalizer (bass/ treble sound) (page 78).
Audio	Sets various sound items (page 78).
Video	Adjusts the resolution of analog video signals (page 79).
HDMI	Makes settings for sound/ images from components connected to the HDMI jacks (page 81).
S-AIR	Makes settings for S-AIR operations (page 82).

Settings for the Auto Calibration

(Auto Calibration menu)

You can make settings for the Auto Calibration function to suit your preference.

Auto Calibration menu parameter

■ Auto Cal. Start (Auto Calibration start)

Lets you perform Auto Calibration. For details, see “Performing Auto Calibration” (page 41).

■ Auto Cal. Type (Calibration type)

Lets you select the Auto Calibration type for each seating position. For details, see step 4 of “Confirming/saving the measurement results” (page 42).

Note

You can select this parameter only when you have performed the Auto Calibration and saved the measurement result.

■ Position (Position)

You can select the seating position you want and register the measurement results of the Auto Calibration for that seating position. You can register 3 patterns as Position 1, 2, and 3, depending on the listening position, listening environment, and measurement conditions.

To register more than one set of settings for the listening environment

You can select the seating position you want and register the measurement results of the Auto Calibration for that seating position.

- 1 Press \uparrow/\downarrow repeatedly to select “Position”, then press \oplus or \rightarrow .
- 2 Press \uparrow/\downarrow repeatedly to select the position (Position 1, 2, 3) for which you want to register the measurement result, then press \oplus .
- 3 Press \uparrow/\downarrow repeatedly to select “Auto Cal. Start”, then press \oplus or \rightarrow .
The measurement results is registered as the position you selected in step 2.
- 4 Press \oplus to select “START”.
- 5 Repeat step 1 to 3 to register another seating position.

To select the registered seating position

- 1 Press \uparrow/\downarrow repeatedly to select “Position”, then press \oplus .
- 2 Press \uparrow/\downarrow repeatedly to select the position (Position 1, 2, 3) you want, then press \oplus .
The registered seating position is selected.

■ Name Input (Naming position)

You can rename the position name.

To name the position name

- 1 Select the “Position” for which you want to name.
- 2 Press \uparrow/\downarrow repeatedly to select “Name Input”, then press \oplus .
- 3 Press $\uparrow/\downarrow/\leftarrow/\rightarrow$ to select a character, then press \oplus .
The name you entered is registered.

Setting for the speaker (Speaker Settings menu)

You can adjust each speaker manually.
You can also adjust the speaker levels after the Auto Calibration is completed.

Note

The speaker settings are only for the current seating position.

Speaker Settings menu parameter

■ SP Pattern (Speaker pattern)

Select “SP Pattern” according to the speaker system which you are using. You do not need to select the speaker pattern after Auto Calibration.

To select the speaker pattern

- 1 Press **▲/▼** repeatedly to select “SP Pattern”, then press **⊕** or **▶**.
The “SP Pattern” screen appears.
- 2 Press **▲/▼** repeatedly to select the speaker pattern you want, then press **⊕**.
- 3 Press **RETURN/EXIT** **↵**.

■ SB Assign (Surround back speaker assign)

You can make settings for the surround back speaker(s). Before you change “SB Assign” to “BI-AMP” or “Speaker B”, be sure you have set “SP Pattern” to a setting without surround back speakers.

- **Speaker B**
If you connect an additional front speaker system to the SPEAKERS SURROUND BACK/FRONT B/BI-AMP terminals, select “Speaker B” (page 38).
- **BI-AMP**
If you connect front speakers in a bi-amplifier configuration, select “BI-AMP” (page 113).
- **OFF**
If you have not connected surround back speakers, select “OFF”.

Note

Set “SB Assign” to “OFF”, then connect the surround back speakers to this receiver when you want to change the connection from a bi-amplifier connection or front speakers B connection to a surround back speakers connection. Re-set up the speakers after you connect the surround back speakers. See “9: Calibrating the appropriate speaker settings automatically (Auto Calibration)” (page 40).

■ Manual Setup (Manual setup)

You can adjust each speaker manually on the “Manual Setup” screen. You can also adjust the speaker levels after the Auto Calibration is completed.

To adjust the speaker level

You can adjust each speaker’s level (front left/right, center, surround left/right, surround back left/right, subwoofer).

- 1 Press **▲/▼/◀/▶** repeatedly to select the speaker on the screen for which you want to adjust the level, then press **⊕**.
- 2 Press **◀/▶** repeatedly to select “Lvl:”.
- 3 Press **▲/▼** repeatedly to set the level of the selected speaker, then press **⊕**.

continued

Note

When one of the sound fields for music is selected, no sound is output from the subwoofer if all the speakers are set to "Large". However, the sound will be output from the subwoofer if

- the digital input signal contains LFE signals.
- the front and surround speakers are set to "Small".
- the sound field for movie is selected.
- "Portable Audio" is selected.

To adjust the distance from the seating position to each speaker

You can adjust the distance from the listening position to each speaker (front left/right, center, surround left/right, surround back left/right, subwoofer).

- 1 Press **▲/▼/◀/▶** repeatedly to select the speaker on the screen for which you want to adjust the distance from the seating position, then press **⊕**.
- 2 Press **◀/▶** repeatedly to select "Dist:".
- 3 Press **▲/▼** repeatedly to set the distance of the selected speaker, then press **⊕**.
You can adjust the distance from 3 feet 3 inches to 32 feet 9 inches (1.00 meter to 10.00 meters) in 1 inch (0.01 meter) steps.

To adjust the size of each speaker

You can adjust each speaker's (front left/right, center, surround left/right, surround back left/right) size.

- 1 Press **▲/▼/◀/▶** repeatedly to select the speaker on the screen for which you want to adjust the size, then press **⊕**.
- 2 Press **◀/▶** repeatedly to select "Size:".

- 3 Press **▲/▼** repeatedly to set the size of the selected speaker, then press **⊕**.

- **Large**
If you connect large speakers that will effectively reproduce bass frequencies, select "Large". Normally, select "Large".
- **Small**
If the sound is distorted, or you feel a lack of surround effects when using multi channel surround sound, select "Small" to activate the bass redirection circuitry and output the bass frequencies of each channel from the subwoofer or other "Large" speakers.

Tips

- The "Large" and "Small" settings for each speaker determine whether the internal sound processor will cut the bass signal from that channel. When the bass is cut from a channel, the bass redirection circuitry sends the corresponding bass frequencies to the subwoofer or other "Large" speakers. However, since bass sound has a certain amount of directionality, it is best not to cut it, if possible. Therefore, even when using small speakers, you can set them to "Large" if you want to output the bass frequencies from that speaker. On the other hand, if you are using a large speaker, but prefer not to have bass frequencies output from that speaker, set it to "Small".
If the overall sound level is lower than you prefer, set all speakers to "Large". If there is not enough bass, you can use the equalizer to boost the bass levels.
- The surround back speakers will be set to the same setting as that of the surround speakers.
- When the front speakers are set to "Small", the center, surround, and surround back speakers are also automatically set to "Small".
- If you do not use the subwoofer, the front speakers are automatically set to "Large".

■ Crossover Freq (Speaker crossover frequency)

Lets you set the bass crossover frequency of speakers that the speaker size has been set to “Small” in the Speaker Settings menu.

Measured speaker crossover frequency is set for each speaker after the Auto Calibration.

1 Press **←/→** repeatedly to select the speaker on the screen you want to adjust.

2 Press **↑/↓** repeatedly to adjust the value, then press **⊕**.

■ Test Tone (Test tone)

You can select the test tone type on the “Test Tone” screen.

Tips

- To adjust the level of all speakers at the same time, press MASTER VOL +/- . You can also use MASTER VOLUME on the receiver.
- The adjusted value is shown on the TV screen during adjustment.

To output test tone from each speaker

You can output test tone from the speakers in sequence.

1 Press **←/→** repeatedly to select “Test Tone”, then press **⊕**.

The “Test Tone” screen appears.

2 Press **↑/↓** repeatedly to adjust the parameter, then press **⊕**.

- OFF
- AUTO
The test tone is output from each speaker in sequence.

- FL, CNT, FR, SR, SBR, SBL, SB, SL, SW

You can select which speakers will output the test tone.

3 Press **↑/↓** repeatedly to adjust the speaker level, then press **⊕**.

To output test tone from adjacent speakers

You can output test tone from adjacent speakers so that you can adjust the balance between the speakers.

1 Press **←/→** repeatedly to select “Phase Noise”, then press **⊕**.

The “Phase Noise” screen appears.

2 Press **↑/↓** repeatedly to adjust the parameter, then press **⊕**.

- OFF
- FL/SR, SL/FL, SB/SL, SBL/SL, SR/SB, SBR/SBL, SR/SBR, SR/SL, FR/SR, FR/SL, CNT/FR, FL/CNT, FL/FR

Lets you output the test tone sequentially from adjacent speakers.

Some items may not be displayed, depending on the setting of the speaker pattern.

3 Press **↑/↓** repeatedly to adjust the speaker level, then press **⊕**.

To output the source sound from adjacent speakers

You can output the source sound from adjacent speakers so that you can adjust the balance between the speakers.

1 Press **←/→** repeatedly to select “Phase Audio”, then press **⊕**.

The “Phase Audio” screen appears.

2 Press **↑/↓** repeatedly to adjust the parameter, then press **⊕**.

- OFF
- FL/SR, SL/FL, SB/SL, SBL/SL, SR/SB, SBR/SBL, SR/SBR, SR/SL, FR/SR, FR/SL, CNT/FR, FL/CNT, FL/FR

Lets you output front 2 channel source sound (instead of the test tone) sequentially from adjacent speakers.

Some items may not be displayed, depending on the setting of the speaker pattern.

3 Press **↑/↓** repeatedly to adjust the speaker level, then press **⊕**.

When a test tone is not output from the speakers

- The speaker cords may not be connected securely. Check to see if they are connected securely and cannot be disconnected by pulling on them slightly.
- The speaker cords may have the short-circuit problem.

When a test tone is output from a different speaker than the speaker displayed on the TV screen

The speaker pattern to the connected speaker is not set up correctly. Make sure the speaker connection and the speaker pattern match.

■ D.Range Comp (Dynamic range compression)

Lets you compress the dynamic range of the soundtrack. This may be useful when you want to watch movies at low volumes late at night. Dynamic range compression is possible with Dolby Digital sources only.

- MAX
The dynamic range is compressed dramatically.
- STD
The dynamic range is compressed as intended by the recording engineer.
- AUTO
The dynamic range is applied automatically with Dolby TrueHD source or other source is set to “OFF”.
- OFF
The dynamic range is not compressed.

Tips

- Dynamic range compressor lets you compress the dynamic range of the soundtrack based on the dynamic range information included in the Dolby Digital signal.
- “STD” is the standard setting, but it only enacts light compression. Therefore, we recommend using the “MAX” setting. This greatly compresses the dynamic range and lets you view movies late at night at low volumes. Unlike analog limiters, the levels are predetermined and provide a very natural compression.

■ Distance Unit (Distance unit)

Lets you select the unit of measure for setting distances.

- FEET
The distance is displayed in feet.
- METER
The distance is displayed in meters.

Settings for the surround sound

(Surround Settings menu)

You can adjust the sound effect on the “S.F. Select” screen.

Note

The setup items you can adjust on each menu vary depending on the sound field.

Surround Settings menu parameters

■ S.F. Select (Sound field select)

You can select the surround sound field and adjust the effect level on the “S.F. Select” screen.

For details on the sound field, see “Enjoying Surround Sound” (page 63).

To select the surround sound field

- 1 Press \uparrow/\downarrow repeatedly to select “S.F. Select”, then press \oplus .
- 2 Press \uparrow/\downarrow repeatedly to select surround sound you want, then press \oplus .

To adjust the effect level

- 1 Press \uparrow/\downarrow repeatedly to select “S.F. Select”, then press \oplus or \blacktriangleright .
- 2 Press \uparrow/\downarrow repeatedly to select surround sound you want, then press \oplus .

Note

Effect Level adjustment is valid only when “Cinema Studio EX **DCS**” is selected.

- 3 Press \uparrow/\downarrow repeatedly to select “Effect Level”, then press \oplus or \blacktriangleright .

- 4 Press \uparrow/\downarrow repeatedly to select effect level you want, then press \oplus .
 - 50%
 - 80%
 - 100%
 - 150%

■ E.Sur Mode (Enhanced surround mode)

You can select the decoding mode for the sound field.

For details on the decoding modes available, see “Setting a multi channel surround sound effect” (page 65).

- Pro Logic II
Performs Dolby Pro Logic II decoding. A source recorded in 2 channel format is decoded into 5.1 channels.
- Pro Logic IIX
Performs Dolby Pro Logic IIX decoding. A source recorded in 2 channel or 5.1 channel format is decoded into 7.1 channels.
- Neo:6 Cinema
Performs DTS Neo:6 Cinema mode decoding. A source recorded in 2 channel format is decoded into 7 channels.
- Neo:6 Music
Performs DTS Neo:6 Music mode decoding. A source recorded in 2 channel format is decoded into 7 channels. This setting is ideal for normal stereo sources such as CDs.
- Neural-THX
Next generation of Neural-THX[®] Surround. In addition to stereo enhancement processing and pure discrete 5.1 surround sound, now capable of full 360° 7.1 surround sound playback from Neural-THX[®] surround encoded content.

Note

You can select “Pro Logic II” when there is no surround back speaker on the “SP Pattern” menu, or you can select “Pro Logic IIX” when there is a surround back speaker. You cannot select both settings at the same time.

Settings for the EQ (EQ menu)

You can use the following parameters to adjust the tonal quality (bass/treble level) of front speakers.

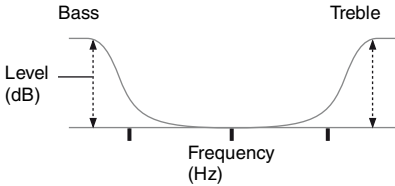

Notes

- This function does not work in the following cases.
 - Sound Field is set to “Analog Direct”.
 - PCM signals with a sampling frequency of more than 96 kHz are being received.
 - Dolby TrueHD signals with a sampling frequency of more than 96 kHz are being received.
- If the equalizer is adjusted while the receiver is receiving signals with a sampling frequency of more than 96 kHz, the signals will always be played back at 96 kHz.

To adjust the equalizer on the EQ screen

- 1 Press **◀/▶** repeatedly to select “Bass” or “Treble”.
- 2 Press **▲/▼** repeatedly to adjust the gain, then press **⊕**.

Settings for the audio (Audio Settings menu)

You can make settings for the audio to suit your preference.

Audio Settings menu parameters

■ A/V Sync (Synchronizes audio with video output)

Lets you delay the output of audio to minimize the time gap between audio output and visual display. You can adjust the delay from 0 ms to 300 ms in 10 ms steps.

Notes

- This parameter is useful when you use a large LCD or plasma monitor or a projector.
- This parameter is not valid when “Analog Direct” is being used.

■ Dual Mono (Digital broadcast language selection)

Lets you select the language you want to listen to during digital broadcast. This feature only functions for Dolby Digital sources.

- Main/Sub
 - Sound of the main language will be output through the front left speaker and sound of the sub language will be output through the front right speaker simultaneously.
- Main
 - Sound of the main language will be output.
- Sub
 - Sound of the sub language will be output.

■ Dec. Priority (Digital audio input decoding priority)

Lets you specify the input mode for the digital signal input to the HDMI IN jack.

- PCM

When signals from the HDMI IN jack are selected, only PCM signals are output from the connected player. To prevent interruption when playback starts, set to “PCM”. When signals in any other format are received, set this item to “AUTO”.

- AUTO

Automatically switches the input mode between DTS, Dolby Digital, or PCM.

Note

Even when “Dec. Priority” is set to “PCM”, the sound may be interrupted at the very beginning of the first track depending on the CD being played back.

Settings for the video (Video Settings menu)

You can make settings for video.

Video Settings menu parameters

■ Resolution (Converting video signals)

Lets you convert the resolution of analog video input signals.

- DIRECT

Lets you output analog video input signals without conversion.

- AUTO
- 480/576i
- 480/576p
- 720p
- 1080i

For details, see “In the video input/output conversion table classified by the menu settings” (page 80).

Tip

You can also press RESOLUTION repeatedly to convert analog video input signals. Each time you press the button, the resolution of the output signals will be changed.

In the video input/output conversion table classified by the menu settings

“Resolution” menu setting	Output from	HDMI OUT jack	COMPONENT VIDEO MONITOR OUT jacks	MONITOR VIDEO OUT jack
	Input signals			
DIRECT	Component video	X	△	X
	Video	X	X	△
AUTO (initial setting)	Component video	○ ^{a)}	○ ^{b)}	X
	Video	○ ^{a)}	○ ^{b)}	△
480/576i	Component video	○ ^{c)}	○	X
	Video	○ ^{c)}	○	△
480/576p	Component video	○	○	X
	Video	○	○	△
720p, 1080i	Component video	○	○ ^{d)}	X
	Video	○	○ ^{d)}	△

○ : Video signals are up-converted and output through the video converter.

△ : The same type of signal as that of the input signal is output. Video signals are not converted.

X : Video signals are not output.

^{a)}The resolution is set automatically, depending on the connected TV.

^{b)}When the TV is connected to jacks other than the HDMI jacks, 480/576i signals are output when “Resolution” is set to “AUTO”.

^{c)}480/576p signals are output even if 480/576i is set.

^{d)}Video signals without copyright protection are output based on the settings menu. Video signals with copyright protection are output as 480p.

Notes

- Video signals are not output from the COMPONENT VIDEO MONITOR OUT or MONITOR VIDEO OUT jacks when the TV, etc., is connected to the HDMI OUT jack.
- If you select a resolution that the connected TV does not support in the “Resolution” menu, the images from the TV cannot be output correctly.
- Converted HDMI image output signals do not support “x.v.Color”.
- Converted HDMI image output signals do not support Deep Color.
- When HDMI OUT jack is connected, there is no up-converted video signal output from COMPONENT VIDEO MONITOR OUT jacks. The COMPONENT VIDEO MONITOR OUT jacks have the component signal direct output only.
- This receiver do not support 1080p input signals. You cannot up-convert the video signals to 1080p using this receiver.

■ Comp.Dec. (Component video decoder)

If the image is distorted when you connect to video game, set “Comp. Dec.” to “ON”. This setting is only applicable for component video input signals.

- ON
- OFF

Settings for HDMI

(HDMI Settings menu)

You can make the required settings for components connected to the HDMI jack.

HDMI Settings menu parameters

■ Ctrl for HDMI (Control for HDMI)

Lets you turn the Control for HDMI function on or off. For details, see “Preparing for the “BRAVIA” Sync” (page 94).

- OFF
- ON

Note

When you set “Ctrl for HDMI” to “ON”, “Audio Out” may be changed automatically.

■ Audio Out (Setting HDMI audio input)

Lets you set the audio output for HDMI from the playback component connected to the receiver via an HDMI connection.

- AMP

The HDMI audio signals from the playback component is only output to the speakers connected to the receiver. Multi channel sound can be played back as it is.

Note

Audio signals are not output from the TV speakers when “Audio Out” is set to “AMP”.

- TV+AMP

The sound is output from TV’s speaker and the speakers connected to the receiver.

Notes

- The sound quality of the playback component depends on the TV’s sound quality, such as the number of channels, and the sampling frequency, etc. When the TV has stereo speakers, the sound output from the receiver is also stereo as that of the TV, even if you play back multi channel source.
- When you connect the receiver to an image display component (projector, etc.), sound may not be output from the receiver. In this case, select “AMP”.
- When you select the input that you have assigned the HDMI input, sound does not output from the TV.

■ SW Level (Subwoofer level for HDMI)

Lets you set the level of the subwoofer to 0 dB or +10 dB when PCM signals are input via an HDMI connection. You can set the level for each HDMI input independently.

- AUTO

The subwoofer level is automatically set to 0 dB or +10 dB depending on the sampling frequency.

- +10 dB
- 0 dB

Settings for the S-AIR (S-AIR Settings menu)

You can make the required settings when you have connect the S-AIR sub unit to the EZW-T100 slot.

S-AIR Settings menu parameters

■ S-AIR ID (S-AIR ID)

Lets you set the ID to match the S-AIR main unit with S-AIR sub unit. For details, see “Establishing sound transmission between the S-AIR main unit and S-AIR sub unit (ID setting)” (page 100).

■ Pairing (Pairing)

Lets you pair your S-AIR main unit with the specific S-AIR sub unit. For details, see “Pairing the S-AIR main unit with a specific S-AIR sub unit (Pairing operation)” (page 102).

■ S-AIR Mode (S-AIR mode)

You can enjoy the system’s sound in another room by using the S-AIR receiver. For details, see “Enjoying the system’s sound in another room” (page 104).

■ RF Change (RF change)

You can improve the transmission by changing the channel. For details, see “Changing the channel for better sound transmission” (page 105).

■ S-AIR Stby (S-AIR standby)

You can enjoy the S-AIR receiver while the S-AIR main unit is in standby mode. For details, see “Enjoying the S-AIR receiver while the S-AIR main unit is in standby mode” (page 107).

Operating without connecting to a TV

You can operate this receiver using the display even if you do not use a GUI when a TV is not connected.

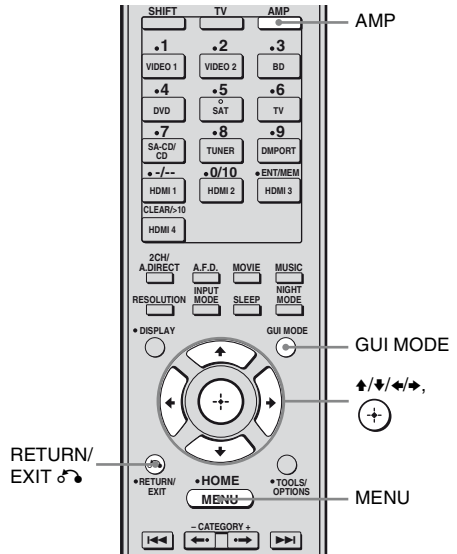

Using the menu in the display

Press GUI MODE repeatedly to select “MENU OFF”.

When “GUI” is displayed in the display, the menu is set to display on the TV screen using a GUI.

- 1 Press AMP.**
- 2 Press MENU.**
- 3 Press ↑/↓ repeatedly to select the menu you want.**
- 4 Press ⊕ or → to enter the menu.**

- 5** Press \uparrow/\downarrow repeatedly to select the parameter you want to adjust.
- 6** Press \oplus or \rightarrow to enter the parameter.
- 7** Press \uparrow/\downarrow repeatedly to select the setting you want.
- 8** Press \oplus to enter the setting.

To return to the previous display

Press \leftarrow or RETURN/EXIT \rightarrow .

To exit the menu

Press MENU.

Note

Some parameters and settings may appear dimmed on the display. This means that they are either unavailable or fixed and unchangeable.

Overview of the menus

The following options are available in each menu. For details on navigating through menus, see page 82.

Menu [Display]	Parameters [Display]	Settings	Initial setting
Auto Calibration settings [<AUTO CAL>]	Auto Calibration start [A.CAL START]		
	Calibration type [CAL TYPE]	FULL FLAT, ENGINEER, FRONT REF, OFF	FULL FLAT
	Position [POSITION]	POS. 1, POS. 2, POS. 3	POS. 1
	Naming position [NAME IN]	For details, see “To name the position name” (page 72).	
Level settings [<LEVEL>]	Test tone [TEST TONE]	OFF, FIX ■■■■ ^{a)} , AUTO ■■■■ ^{a)}	OFF
	Phase noise ^{b)} [P. NOISE]	OFF, FL/SR, SL/FL, SB/SL, SBL/SL, SBR/SBL, SR/SB, SR/SBR, SR/SL, FR/SR, FR/SL, FL/FR, CNT/FR, FL/CNT	OFF
	Phase audio ^{b)} [P. AUDIO]	OFF, FL/SR, SL/FL, SB/SL, SBL/SL, SBR/SBL, SR/SB, SR/SBR, SR/SL, FR/SR, FR/SL, FL/FR, CNT/FR, FL/CNT	OFF
	Front left speaker level ^{b)} [FL LEVEL]	FL -10.0 dB to FL +10.0 dB (0.5 dB per step)	FL 0.0 dB
	Front right speaker level ^{b)} [FR LEVEL]	FR -10.0 dB to FR +10.0 dB (0.5 dB per step)	FR 0.0 dB
	Center speaker level ^{b)} [CNT LEVEL]	CNT -20.0 dB to CNT +10.0 dB (0.5 dB per step)	CNT 0.0 dB
	Surround left speaker level ^{b)} [SL LEVEL]	SL -20.0 dB to SL +10.0 dB (0.5 dB per step)	SL 0.0 dB
	Surround right speaker level ^{b)} [SR LEVEL]	SR -20.0 dB to SR +10.0 dB (0.5 dB per step)	SR 0.0 dB
	Surround back speaker level ^{b)} [SB LEVEL]	SB -20.0 dB to SB +10.0 dB (0.5 dB per step)	SB 0.0 dB
	Surround back left speaker level ^{b)} [SBL LEVEL]	SBL -20.0 dB to SBL +10.0 dB (0.5 dB per step)	SBL 0.0 dB
	Surround back right speaker level ^{b)} [SBR LEVEL]	SBR -20.0 dB to SBR +10.0 dB (0.5 dB per step)	SBR 0.0 dB
	Subwoofer level ^{b)} [SW LEVEL]	SW -20.0 dB to SW +10.0 dB (0.5 dB per step)	SW 0.0 dB
	Dynamic range compression [D. RANGE]	COMP. MAX, COMP. STD, COMP. AUTO, COMP. OFF	COMP. AUTO

Menu [Display]	Parameters [Display]	Settings	Initial setting
Speaker settings [<SPEAKER>]	Speaker pattern [SP PATTERN]	3/4.1, 3/4, 3/3.1, 3/3, 2/4.1, 2/4, 3/2.1, 3/2, 2/3.1, 2/3, 2/2.1, 2/2, 3/0.1, 3/0, 2/0.1, 2/0	3/4.1
	Front speakers [FRT SP]	LARGE, SMALL	LARGE
	Center speaker [CNT SP]	LARGE, SMALL	LARGE
	Surround speakers [SUR SP]	LARGE, SMALL	LARGE
	Surround back speaker assign ^{c)} [SB ASSIGN]	SPK B, BI-AMP, OFF	OFF
	Front left speaker distance ^{b)} [FL DIST.]	FL 3'3" to FL 32'9" (FL 1.00 m to FL 10.00 m) (1 inch (0.01 m) step)	FL 9'10" (3.00 m)
	Front right speaker distance ^{b)} [FR DIST.]	FR 3'3" to FR 32'9" (FR 1.00 m to FR 10.00 m) (1 inch (0.01 m) step)	FR 9'10" (3.00 m)
	Center speaker distance ^{b)} [CNT DIST.]	CNT 3'3" to CNT 32'9" (CNT 1.00 m to CNT 10.00 m) (1 inch (0.01 m) step)	CNT 9'10" (3.00 m)
	Surround left speaker distance ^{b)} [SL DIST.]	SL 3'3" to SL 32'9" (SL 1.00 m to SL 10.00 m) (1 inch (0.01 m) step)	SL 9'10" (3.00 m)
	Surround right speaker distance ^{b)} [SR DIST.]	SR 3'3" to SR 32'9" (SR 1.00 m to SR 10.00 m) (1 inch (0.01 m) step)	SR 9'10" (3.00 m)
	Surround back speaker distance ^{b)} [SB DIST.]	SB 3'3" to SB 32'9" (SB 1.00 m to SB 10.00 m) (1 inch (0.01 m) step)	SB 9'10" (3.00 m)
	Surround back left speaker distance ^{b)} [SBL DIST.]	SBL 3'3" to SBL 32'9" (SBL 1.00 m to SBL 10.00 m) (1 inch (0.01 m) step)	SBL 9'10" (3.00 m)
	Surround back right speaker distance ^{b)} [SBR DIST.]	SBR 3'3" to SBR 32'9" (SBR 1.00 m to SBR 10.00 m) (1 inch (0.01 m) step)	SBR 9'10" (3.00 m)
	Subwoofer distance ^{b)} [SW DIST.]	SW 3'3" to SW 32'9" (SW 1.00 m to SW 10.00 m) (1 inch (0.01 m) step)	SW 9'10" (3.00 m)
	Distance unit [DIST. UNIT]	FEET, METER	FEET
	Front speaker crossover frequency ^{d)} [FRT CROSS]	CROSS 40 Hz to CROSS 200 Hz (10 Hz step)	CROSS 120 Hz
	Center speaker crossover frequency ^{d)} [CNT CROSS]	CROSS 40 Hz to CROSS 200 Hz (10 Hz step)	CROSS 120 Hz
	Surround speaker crossover frequency ^{d)} [SUR CROSS]	CROSS 40 Hz to CROSS 200 Hz (10 Hz step)	CROSS 120 Hz

continued

Menu [Display]	Parameters [Display]	Settings	Initial setting
Surround settings [<SURROUND>]	Sound field selection [S.F. SELECT]	For details, see “Enjoying Surround Sound” (page 63).	A.F.D. AUTO
	Enhanced surround mode [E.SUR MODE]	PLII ^{b)} , PLIIx ^{b)} , NEO6 CIN, NEO6 MUS, NEURAL-THX	PLIIX
	Effect level ^{e)} [EFFECT]	EFCT. 50%, EFCT. 80%, EFCT. 100%, EFCT. 150%	EFCT. 100%
EQ settings [<EQ>]	Front speakers bass level [BASS]	BASS -10 dB to BASS +10 dB (1 dB per step)	BASS 0 dB
	Front speakers treble level [TREBLE]	TREBLE -10 dB to TREBLE +10 dB (1 dB per step)	TREBLE 0 dB
Tuner settings [<TUNER>]	FM station receiving mode [FM MODE]	STEREO, MONO	STEREO
	Naming preset stations [NAME IN]	For details, see “Naming preset stations (Name Input)” (page 55).	
	Parental lock ^{f)} [PARENTAL]	OFF, ON	OFF
	Lock code edit ^{f)} [CODE EDIT]	For details, see “Restricting access to specific channels (Parental Lock)” (page 60).	
	SIRIUS antenna aiming mode ^{f)} [SR ANT AIM]	For details, see “Checking receiving conditions (Antenna Aiming)” (page 57).	
	SIRIUS radio ID ^{f)} [SIRIUS ID]	For details, see “Checking the SIRIUS Radio ID” (page 57).	
Audio settings [<AUDIO>]	Synchronizes audio with video output [A/V SYNC]	0 ms to 300 ms (10 ms per step)	0 ms
	Digital broadcast language selection [DUAL MONO]	MAIN/SUB, MAIN, SUB	MAIN
	Digital audio input decoding priority [DEC. PRIO.]	DEC. AUTO, DEC. PCM	DEC. AUTO
	Digital audio input assignment [A. ASSIGN]		
	VIDEO 1 ? →	BD OPT, SAT OPT, DVD COAX, ANALOG	
	VIDEO 2 ? →		
	BD ? →		
DVD ? →			
SAT ? →			
SA-CD/CD ? →			

Menu [Display]	Parameters [Display]	Settings	Initial setting
Video settings [<VIDEO>]	Resolution [RESOLUTION]	DIRECT, AUTO, 480/576i, 480/576p, 720p, 1080i	AUTO
	Video input assignment [V. ASSIGN]		
	VIDEO 1 ? →	COMPONENT1, COMPONENT2, COMPONENT3, COMPOSITE,	
	VIDEO 2 ? →	HDMI1, HDMI2, HDMI3, HDMI4,	
	BD ? →	NONE	
	DVD ? →		
	SAT ? →		
	SA-CD/CD ? →		
	Switching component signals [COMP. DEC.]	DEC. ON, DEC. OFF	DEC. OFF
HDMI settings [<HDMI>]	Control for HDMI [CTRL:HDMI]	CTRL ON, CTRL OFF	CTRL OFF
	Setting HDMI audio input [AUDIO OUT]	AMP, TV+AMP	AMP
	Subwoofer level for HDMI ^{g)} [SW LEVEL]	SW AUTO, SW +10 dB, SW 0 dB	SW AUTO
System settings [<SYSTEM>]	Naming inputs [NAME IN]	For details, see “Naming the input (Name Input)” (page 49).	
	Brightness of the display [DIMMER]	0% DOWN, 40% DOWN, 70% DOWN	0% DOWN
S-AIR settings [<S-AIR>]	S-AIR ID ^{h)} [S-AIR ID]	ID: A, ID: B, ID: C	ID: A
	Pairing ^{h)} [PAIRING]	START, CONDITION	START
	S-AIR mode ^{h)} [S-AIR MODE]	PARTY, SEPARATE	PARTY
	RF Change ^{h)} [RF CHANGE]	RF AUTO, RF ON, RF OFF	RF AUTO
	S-AIR Standby ^{h)} [S-AIR STBY]	STBY ON, STBY OFF	STBY OFF

a) ■■■ represent a speaker channel (FL, FR, CNT, SL, SR, SB, SBL, SBR, SW).

b) Depends on the speaker pattern setting, some parameters or settings may not be available.

c) You can only select this parameter if “SP PATTERN” is not set to a setting with surround back speakers (page 73).

d) You can only select this parameter if your speaker is set to “SMALL”.

e) You can only select this parameter if you select Cinema Studio A/B/C as sound field.

f) This parameter is only available if the SiriusConnect Home tuner is connected to the SIRIUS jack on the receiver.

g) This parameter is only available when HDMI input signals are detected.

h) This parameter is only available if the S-AIR transmitter (not supplied) is inserted to the EZW-T100 slot on the receiver.

Changing the display

You can check the sound field, etc., by changing the information on the display.

Press DISPLAY repeatedly.

Each time you press DISPLAY, the display will change cyclically as follows.

All inputs except the FM and AM band

Input name you selected* → Original input name → Sound field currently applied → Volume level → Stream information

FM and AM band

Preset station name* → Frequency → Sound field currently applied → Volume level

SIRIUS Satellite Radio

Channel name → Channel number → Category name → Artist name/Feature → Song/program title → Composer name → Signal strength → Sound field type → Volume level

* Index name appears only when you have assigned one to the input or preset station (page 49, 55).
Index name does not appear when only blank spaces have been entered or it is the same as the input name.

Note

Character or marks may not be displayed for some languages.

Tip

You cannot switch the display while "GUT" is shown on the display. Press GUI MODE repeatedly to select "MENU OFF".

Performing Auto Calibration

For details on the Auto Calibration, see "9: Calibrating the appropriate speaker settings automatically (Auto Calibration)" (page 40).

See "Before you perform Auto Calibration" (page 40) before performing the Auto Calibration.

To operate on the receiver

- 1 Press GUI MODE repeatedly to select "MENU OFF".
- 2 Press AMP.
Receiver operation is enabled.
- 3 Press MENU.
- 4 Press \uparrow/\downarrow repeatedly to select "<AUTO CAL>", then press \oplus .
- 5 Press \uparrow/\downarrow repeatedly to select "A.CAL START", then press \oplus to start the measurement.
Measurement starts in 5 seconds. A count down is displayed.

Note

While the time is counting down, stand away from the measurement area to avoid measurement error.

6 Measurement starts.

The measurement process will take approximately 30 seconds. Wait until the measurement process completes.

To cancel Auto Calibration

The measurement will be canceled when you do the following:

- Press I/⏏, input buttons or MUTING.
- Press SPEAKERS on the receiver.
- Change the volume level.
- Connect the headphones.

Tips

- Operations other than turning the receiver on or off are deactivated during Auto Calibration.
- The measurements may not be performed correctly or Auto Calibration cannot be performed when special speakers, such as dipole speakers are used.

To confirm/save Auto Calibration when GUI function is turned off

1 Confirm the measurement result.

When the measurement ends, a beep sounds and the measurement result appears on the display.

Measurement result	Display	Explanation
When the measurement process completes properly	COMPLETE	Proceed to step 2.
When the measurement process fails	E - ■■■■:■■■	See “Message list after Auto Calibration measurement” (page 44).

2 Press ▲/▼ repeatedly to select the item, then press ⊕.

Item	Explanation
RETRY	Performs the Auto Calibration again.
SAVE EXIT	Saves the measurement results and exits the setting process.
WARN CHECK	Displays a warning concerning the measurement results. See “Message list after Auto Calibration measurement” (page 44).
PHASE INFO.	Displays the phase of each speaker (in phase/out of phase). See “When you select “PHASE INFO.”” (page 90).
DIST. INFO.	Displays the measurement result for speaker distance.
LEVEL INFO.	Displays the measurement result for speaker level.

Item	Explanation
EXIT	Exits the setting process without saving the measurement results.

3 Select “SAVE EXIT” in step 2. The measurement results are saved.

4 Press ▲/▼ repeatedly to select the Auto Calibration Type, then press ⊕.

Auto Calibration Type	Explanation
FULL FLAT	Makes the measurement of frequency from each speaker flat.
ENGINEER	Sets the frequency characteristics to a set that matches that of the Sony listening room standard.
FRONT REF	Adjusts the characteristics of all the speakers to match the characteristics of the front speaker.
OFF	Set the Auto Calibration to off.

Tip

The size of a speaker (LARGE/SMALL) is determined by the low frequency characteristics. The measurement results may vary, depending on the position of the optimizer microphone and speakers, and the shape of the room. It is recommended that you follow the measurement results. However, you can change those settings in the Speaker settings menu. Save the measurement results first, then try to change the settings if you want.

When you select “PHASE INFO.”

You can check the phase of each speaker (in phase/out of phase).

Press \uparrow/\downarrow repeatedly to select a speaker, then press \oplus to return to step 2 in “To confirm/save Auto Calibration when GUI function is turned off” (page 89).

Display	Explanation
■■■■* : IN	The speaker is in phase.
■■■■* : OUT	The speaker is out of phase. The “+” and “-” terminals of the speaker may be connected the other way around. However, depending on the speakers, “■■■■:OUT” appears on the display even though the speakers are connected properly. This is because of the speakers’ specifications. In this case, you can continue to use the receiver.
■■■■* ---	No speakers are connected.

* ■■■■ represent a speaker channel.

FL	Front left
FR	Front right
CNT	Center
SL	Surround left
SR	Surround right
SB	Surround back
SBL	Surround back left
SBR	Surround back right
SW	Subwoofer

Tip

Depending on the position of the subwoofer, the measurement results for polarity may vary. However, there will be no problems even if you continue to use the receiver with that value.

Selecting a sound field type

For details on each sound field type, see “Enjoying Surround Sound” (page 63).

Press 2CH/A.DIRECT, A.F.D., MOVIE, or MUSIC repeatedly.

The selected sound field type appears on the display.

To select Enhanced Surround Mode

- 1 Press AMP.
- 2 Press MENU.
- 3 Press \uparrow/\downarrow repeatedly to select “<SURROUND>”, then press \oplus or \blacktriangleright .
- 4 Press \uparrow/\downarrow repeatedly to select “<E.SUR MODE>”, then press \oplus or \blacktriangleright .
- 5 Press \uparrow/\downarrow repeatedly to select the Enhanced Surround Mode you want, then press \oplus .

Note

The selected Enhanced Surround Mode can only be applied if you have selected “E.SURROUND” by pressing A.F.D. repeatedly.

Listening to the sound without any adjustment (ANALOG DIRECT)

Press 2CH/A.DIRECT repeatedly to select “A.DIRECT”.

Listening to the FM/AM radio

For details on the tuner function, see “Tuner Operations” (page 52).

Tuning radio stations

- 1 Press TUNER repeatedly to select the FM or AM band.
You can also use INPUT SELECTOR +/- on the receiver.
- 2 Press TUNING + or TUNING -.
Press TUNING + to scan from low to high frequencies, press TUNING - to scan from high to low frequencies. The receiver stops scanning whenever a station is received.

Selecting a frequency directly (Direct Tuning)

- 1 After selecting the FM or AM band, press D.TUNING.
- 2 Press SHIFT, then press numeric buttons to enter the frequency.
- 3 Press \oplus .

Presetting radio stations

1 Tune in the station that you want to preset.

For details on the operation, see “Tuning radio stations” (page 91).

2 Press SHIFT, then press ENT/MEM.

“MEM” lights up for a few seconds. Perform steps 3 and 4 before “MEM” disappears.

3 Press PRESET + or PRESET - to select a preset number.

30 FM and 30 AM preset numbers are available. If “MEM” disappears before you select the preset number, start again from step 2.

4 Press ENT/MEM or \rightarrow .

If SHIFT indicator is light off before you press ENT/MEM, press SHIFT. The station is stored as the selected preset number. If “MEM” disappears before you press ENT/MEM, start again from step 2.

5 Repeat steps 1 to 4 to preset another station.

Selecting a preset station

- 1 Press TUNER repeatedly to select the FM or AM band.
- 2 Press PRESET + or PRESET - repeatedly to select the preset station you want.
You can also press SHIFT, then press numeric buttons to select the preset station you want. Then, press \oplus to enter the selection.

Listening to satellite tuner

For details on SIRIUS Radio service, see “Listening to Satellite Radio” (page 55) in “Tuner Operations”.

Aiming the SIRIUS Antenna

You can use “SR ANT AIM” in the Tuner settings menu to help you aim the antenna for optimal signal reception.

- 1 Press TUNER repeatedly to select “SIRIUS”.
You can also use INPUT SELECTOR +/- on the receiver.
- 2 Press AMP.
- 3 Press MENU.
- 4 Press \uparrow/\downarrow repeatedly to select “<TUNER>”.
- 5 Press \oplus or \rightarrow to enter the menu.
- 6 Press \uparrow/\downarrow repeatedly to select “SR ANT AIM”.
- 7 Press \oplus or \rightarrow to enter the parameter.
- 8 While checking the parameter, aim your antenna to where the best reception will be received.
For details on the parameter, see “SIRIUS Signal Strength” below.

SIRIUS Signal strength

Signal strength	Signal type	
	Satellite	Terrestrial
EXC (excellent)	S:3	T:3
GOOD	S:2	T:2
WEAK	S:1	T:1
NONE	S:0	T:0

Checking the SIRIUS Radio ID

- 1 Press TUNER repeatedly to select “SIRIUS”.
You can also use INPUT SELECTOR +/- on the receiver.
- 2 Press TUNING + or TUNING – to select channel 0.
- 3 Check the SIRIUS ID on the display and write it in the space provided here.
SIRIUS ID: _____

Selecting channels from a category (CATEGORY TUNING)

- 1 Press TUNER repeatedly to select “SIRIUS”.
You can also use INPUT SELECTOR +/- on the receiver.
- 2 Press CATEGORY MODE repeatedly to select “ONE CAT”.
 - ALL CAT: You can select a channel from all the categories. The initial setting is “ALL CAT”.
 - ONE CAT: You can select a channel from one category. “CAT” lights up on the display when you set to “ONE CAT” mode.
- 3 Press CATEGORY + or CATEGORY – to select the category you want.
The category is selected and the channel with the lowest number in the specified category is selected.
- 4 Press TUNING + or TUNING – to select the channel.

Selecting a channel number directly (Direct tuning)

- 1 After selecting satellite tuner, press D.TUNING.
- 2 Press SHIFT, then press numeric buttons to enter the channel number.
- 3 Press \oplus .

Presetting satellite tuner channels

1 Select a channel you want to preset.

For details on this operation, see “Selecting channels from a category (CATEGORY TUNING)” (page 92).

2 Press SHIFT, then press ENT/MEM.

“MEM” lights up on the display.

3 Press PRESET + or PRESET – to select a preset number.

You can also select the number by pressing SHIFT, then numeric buttons. Preset numbers from 1 to 30 are available. Channel 1 is preset for the preset numbers when you purchase the receiver.

4 Press ENT/MEM.

If SHIFT indicator is light off before you press ENT/MEM, press SHIFT. “MEM” lights off.

5 Repeat steps 1 to 4 to preset another channel.

Selecting a preset channel

1 Press TUNER repeatedly to select “SIRIUS”.

2 Press PRESET + or PRESET – repeatedly to select the preset channel you want.

You can also press SHIFT, then numeric buttons to select the preset channel you want. Then, press ENT/MEM to enter the selection.

“BRAVIA” Sync Features

What is “BRAVIA” Sync?

“BRAVIA” Sync is compatible with Sony TV, Blu-ray Disc/DVD player, AV amplifier, etc., that is equipped with the Control for HDMI function.

By connecting Sony components that are compatible with the “BRAVIA” Sync with an HDMI cable (not supplied), operation is simplified as follows:

- One-Touch Play: When you play back a component such as a DVD/Blu-ray disc player, the receiver and the TV are turned on automatically and switched to the appropriate HDMI input. In case the receiver or/and the TV is in standby mode, they will be turned on automatically.
- System Audio Control: While watching TV, you can select to output the sound from the TV speaker or the speakers connected to the receiver.
- System Power Off: When you turn off the TV, the receiver and connected components are also turned off simultaneously.

Control for HDMI is a mutual control function standard used by HDMI CEC (Consumer Electronics Control) for HDMI (High-Definition Multimedia Interface).

The Control for HDMI function will not operate correctly in the following cases:

- When you connect the receiver to a component which does not correspond with Sony Control for HDMI function.
- When you connect the receiver and components using other than HDMI connection.

We recommend that you connect the receiver to products featuring “BRAVIA” Sync.

Note

Depending on the connected component, the Control for HDMI function may not work. Refer to the operating instructions of the component.

Preparing for the “BRAVIA” Sync

To use the “BRAVIA” Sync, turn the Control for HDMI function on for both the receiver and the connected component. The receiver is compatible with the “Control for HDMI-Easy Setting” function.

When your TV is compatible with the “Control for HDMI-Easy Setting” function

When you connect a Sony TV with the “Control for HDMI-Easy Setting” function, the Control for HDMI function of the receiver can be turned on simultaneously by turning the Control for HDMI function of the TV on.

- 1** Make sure that the receiver, TV, and playback components are connected using an HDMI cable (not supplied). (The respective components must be compatible with the Control for HDMI function).
- 2** Turn on the receiver, TV and playback components.
- 3** Turn the Control for HDMI function of the TV on.
The Control for HDMI function of the receiver and all the connected components are simultaneously turned on. During setup, “SCANNING” appears in the display, and once setting is completed, “COMPLETE” will appear. Wait until the setup is complete.

For details on setup of the TV, refer to the operating instructions of your TV.

When your TV is not compatible with the “Control for HDMI-Easy Setting” function

Turn the Control for HDMI function of the receiver and the connected component on individually.

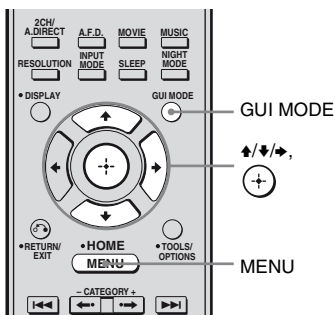

- 1 Perform the steps given in “When your TV is compatible with the “Control for HDMI-Easy Setting” function” (page 94).
- 2 Press GUI MODE.
After “MENU ON” appears on the display for a while, “GUI” appears and the GUI menu appears on the TV screen.
Press MENU if the GUI menu does not appear on the TV screen.
- 3 Press \uparrow/\downarrow repeatedly to select “Settings”, then press \oplus or \rightarrow .
The Settings menu list appears on the TV screen.
- 4 Press \uparrow/\downarrow repeatedly to select “HDMI”, then press \oplus or \rightarrow .
- 5 Press \uparrow/\downarrow repeatedly to select “Ctrl for HDMI”, then press \oplus or \rightarrow .
- 6 Press \uparrow/\downarrow repeatedly to select “ON”, then press \oplus .
The Control for HDMI function is set to on.
- 7 Set the Control for HDMI function of the connected component to on.

- 8 Select the HDMI input (HDMI 1/2/3/4) of the receiver and TV to match the HDMI output of the connected component, so that the image from the connected component is displayed.
For details on setting the TV and connected components, refer to the operating instructions of the respective components.

Notes

- When you unplug the HDMI cable or change the connection, perform the steps given in “When your TV is compatible with the “Control for HDMI-Easy Setting” function” (page 94) or “When your TV is not compatible with the “Control for HDMI-Easy Setting” function” (page 95).
- You cannot perform One-Touch Play and System Audio Control during Control for HDMI-Easy Setting operation.
- Before you do the Control for HDMI-Easy Setting from the TV, be sure to turn on the TV, connected components and receiver.
- If the playback components cannot function after you have made the settings for Control for HDMI-Easy Setting, check the Control for HDMI setting on your TV.
- If the connected components do not support Control for HDMI-Easy Setting, you need to set the Control for HDMI function for the connected components to on before you perform the Control for HDMI-Easy Setting from the TV.

Playing back components with one-touch operation (One-Touch Play)

You can enjoy sound and image from the components connected to the receiver via HDMI connections by a simple operation.

Play back a connected component.

The receiver and the TV are turned on automatically and switched to the appropriate HDMI input. In case the receiver or/and the TV is in standby mode, they will be turned on automatically.

Watching a DVD/Blu-ray disc by simple operation

You can also select a connected component, such as a DVD/Blu-ray disc player using the TV menu. In this case, the receiver and the TV switch to the appropriate HDMI input.

Note

Depending on the TV, the start of the content may not be output.

Enjoying the TV sound from the speakers connected to the receiver (System Audio Control)

You can enjoy the TV sound from the speakers connected to the receiver by a simple operation.

You can operate System Audio Control function using the TV menu. For details, refer to the operating instructions of the TV. When System Audio Control function is turned on, the receiver will turn on and switch to the appropriate input automatically. TV sound is output from the speakers connected to the receiver, and the volume of the TV is minimized simultaneously. You can also use the System Audio Control function as follows.

- If you turn on the receiver while the TV is turned on, the System Audio Control function will automatically be set to on and the TV sound will output from the speakers connected to the receiver. However, if you turn off the receiver, the sound will output from the TV speakers.
- You can adjust the receiver's volume when you adjust the TV volume.

Notes

- If System Audio Control does not function according to your TV setting, refer to the operating instructions of the TV.
- When "Ctrl for HDMI" is set to "ON", the "Audio Out" settings in the HDMI Settings menu will set automatically depending on the System Audio Control settings.
- When you connect a TV that does not have System Audio Control function, the System Audio Control function does not work.
- If the TV is turned on before turning on the receiver, the TV sound will not be output for a moment.
- When you switch to an input other than HDMI or TV, the System Audio Control function will automatically be set to off.

Turning off the receiver with the TV

(System Power Off)

When you turn the TV off by using the POWER button on the TV's remote, the receiver and the connected components turn off automatically.

You can also use the receiver's remote to turn off the TV.

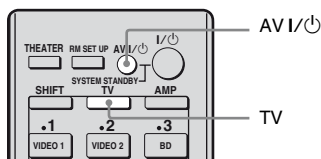

Press TV, then press AV I/⏻.

The TV, receiver and the components connected via HDMI are turned off.

Notes

- Set the TV Standby Synchro to "ON" before using the System Power Off function. For details, refer to the operating instructions of the TV.
- Depending on the status, the connected components may not be turned off. For details, refer to the operating instructions of the connected components.

S-AIR Operations

About S-AIR products

This receiver is compatible with the S-AIR function (page 125), which allows wireless sound transmission between S-AIR products. When you purchase the S-AIR product, you need to establish sound transmission (page 99).

There are two types of S-AIR product.

- S-AIR main unit (this receiver):
 - The S-AIR main unit is for transmitting sound.
 - You can use up to 3 S-AIR main units. (The number of usable S-AIR main unit depends on the use environment.)
- S-AIR sub unit (not supplied): The S-AIR sub unit is for receiving sound.
 - Surround amplifier: You can enjoy surround and surround back speakers sound wirelessly. For details, refer to the operating instructions supplied with the surround amplifier.
 - S-AIR receiver: You can enjoy system sound in another room.

These S-AIR products can be purchased as an option (the S-AIR product lineup differs depending on the area).

Notes or instructions for the surround amplifier or S-AIR receiver in this operating instructions is refer only when the surround amplifier or S-AIR receiver is used.

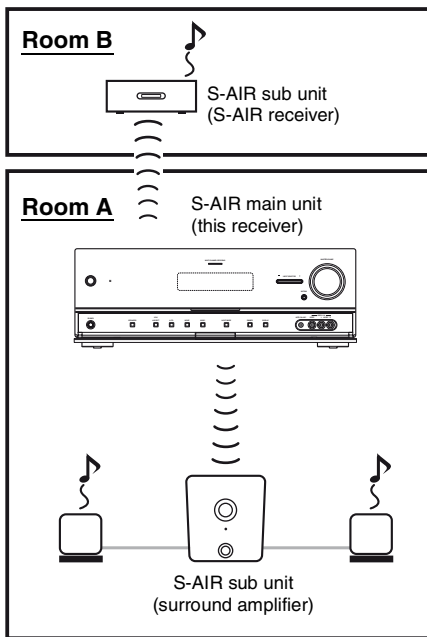

To use S-AIR products (S-AIR main unit and sub unit)

Before using S-AIR products, have the following ready.

Confirm the wireless adapters are inserted correctly

Insert the wireless adapters firmly to the depth into the slots of the S-AIR main unit and sub unit respectively.

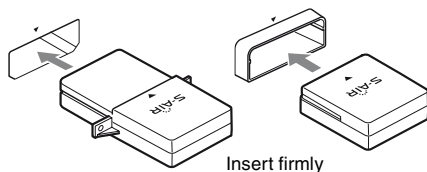

Confirm that the S-AIR IDs of the S-AIR main unit and sub unit are the same

The default setting of the S-AIR IDs of the S-AIR main unit and sub unit is "A".

Depending on the S-AIR product, you can set the S-AIR ID by the switch or the setup menu. For details, refer to the operating instructions of each S-AIR product.

About environments where S-AIR products (S-AIR main unit and sub unit) are used

S-AIR products use a radio frequency of 2.4 GHz. Certain electronic equipment or other factors may cause lost connection or instability in S-AIR reception.

- Electronic equipment influence
 - The following may cause interference or cross talk.
 - Cellular phones, cordless phones
 - Wireless LAN, personal computers
 - Game machines using radio signals
 - Microwave ovens



- Other factors
 - The following may cause poor reception.
 - Materials or structures, such as walls and floors
 - The location where an S-AIR product is placed
- When using S-AIR products, place them as far as possible from the above electronic equipment, or place where S-AIR reception is stable.

Setting up an S-AIR product

Before using an S-AIR product, be sure to perform the following settings to establish the sound transmission.

Inserting the wireless transmitter/transceiver

To make use of the S-AIR function, you need to insert the wireless transmitter (not supplied) into the S-AIR main unit and the wireless transceiver (not supplied) into the S-AIR sub unit.

Notes

- Before inserting the wireless transmitter/transceiver, be sure to disconnect the AC power cord (mains lead).
- Do not touch the terminals of the wireless transmitter/transceiver.

To insert the wireless transmitter into the S-AIR main unit

- 1 Remove the screws and detach the slot cover.

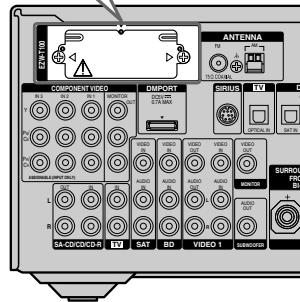
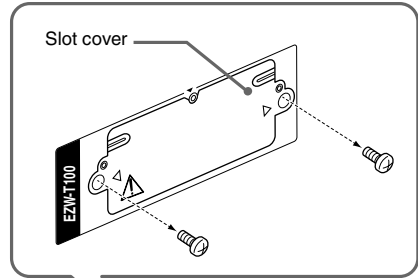

Notes

- Remove the screws from the slot cover bearing the caution mark. Do not remove other screws.
- The slot cover is no longer necessary. However, keep it after detaching.

- 2 Insert the wireless transmitter.

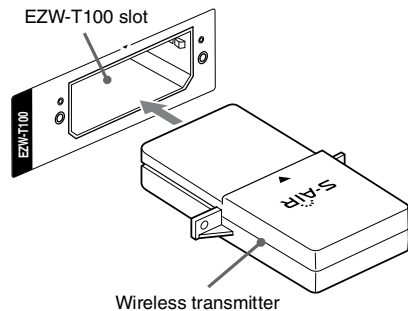

Notes

- Insert the wireless transmitter with the S-AIR logo facing up.
- Insert the wireless transmitter so that the ▼ marks are aligned.
- Do not insert other than the wireless transmitter into the EZW-T100 slot.

- 3** Use the screws that you removed from step 1 to fasten the wireless transmitter.

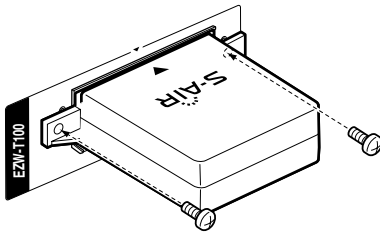

Note

Do not use other screws to fasten the wireless transmitter.

To insert the wireless transceiver into the S-AIR sub unit

For details on installing the wireless transceiver into surround amplifier and S-AIR receiver, refer to the operating instructions supplied with the surround amplifier and S-AIR receiver.

Establishing sound transmission between the S-AIR main unit and S-AIR sub unit (ID setting)

When you match the ID of the S-AIR main unit and the S-AIR sub unit, you can establish sound transmission. You can use multiple S-AIR main unit by setting a different ID for each unit.

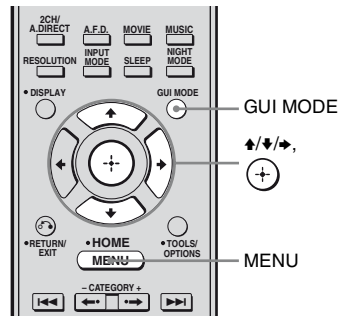

To set the ID of the S-AIR main unit

- 1** Press GUI MODE.
After "MENU ON" appears on the display for a while, "GUI" appears and the GUI menu appears on the TV screen. Press MENU if the GUI menu does not appear on the TV screen.
- 2** Press ▲/▼ repeatedly to select "Settings", then press ⊕ or ➤.
The Settings menu list appears on the TV screen.
- 3** Press ▲/▼ repeatedly to select "S-AIR", then press ⊕ or ➤.

Note

When the S-AIR transmitter (not supplied) is not inserted into the S-AIR main unit, "S-AIR" cannot be selected.

- 4** Press ▲/▼ repeatedly to select "S-AIR ID", then press ⊕ or ➤.
The S-AIR ID menu appears.

- 5 Press $\blacktriangle/\blacktriangledown$ repeatedly to select the ID (A, B or C) you want, then press \oplus .
The ID of the S-AIR main unit is set. "Set S-AIR ID of the sub unit to the same as that of the main unit" appears.
- 6 Press \oplus to set the ID of the S-AIR sub unit.
- 7 Press GUI MODE.
The GUI menu turns off.
- 8 Set the S-AIR sub unit to the same ID. Sound transmission is established as follows (example):

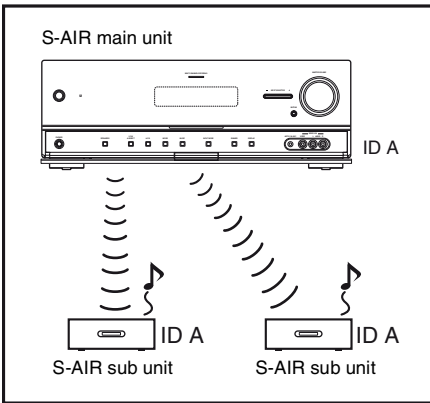

Tip

To confirm the current ID, performs steps 1 to 3 above. When you pair the S-AIR main unit with the S-AIR sub unit (page 102), "(Pairing)" appears beside the ID on the TV screen in the GUI menu.

To exit the menu

Press MENU.

To set the ID of the S-AIR sub unit

Be sure to match the ID on S-AIR sub unit you want to the S-AIR main unit.

For details on setting the ID of the surround amplifier and S-AIR receiver, refer to the operating instructions supplied with the surround amplifier and S-AIR receiver.

To use multiple S-AIR main units

You can use multiple S-AIR main units by setting a different ID for each component.

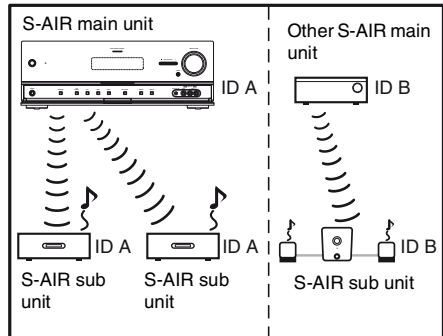

Notes

- Sources with copyright protection may not be playable on S-AIR sub unit.
- When sound transmission is established
 - sound can only be output from the S-AIR receiver if you connect the components to this receiver via the analog jacks. The sound cannot be output if the components are connected to the COAXIAL, OPTICAL or HDMI jacks on this receiver.
 - the headphones function on the surround amplifier is not available.

Pairing the S-AIR main unit with a specific S-AIR sub unit (Pairing operation)

To establish sound transmission, you need to set the same ID for your S-AIR main unit and S-AIR sub unit.

However, if your neighbors have S-AIR products and their IDs are the same as yours, your neighbors could receive the sound of your S-AIR main unit or vice versa.

To prevent this, you can pair the S-AIR main unit with a specific S-AIR sub unit by performing the pairing operation.

■ Before pairing

Sound transmission is established by the ID (example).

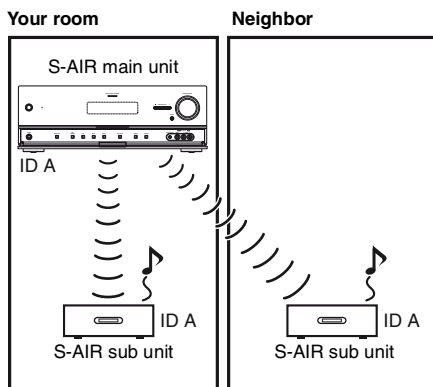

■ After pairing

Sound transmission is established between the paired S-AIR main unit and S-AIR sub unit(s) only.

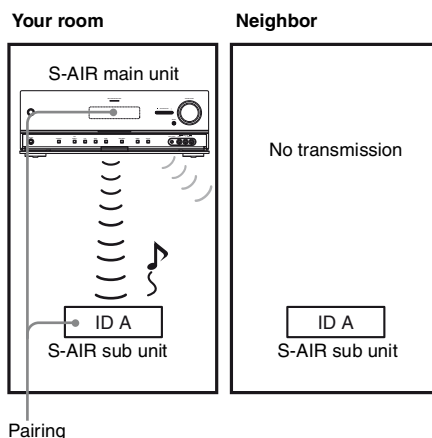

To perform pairing

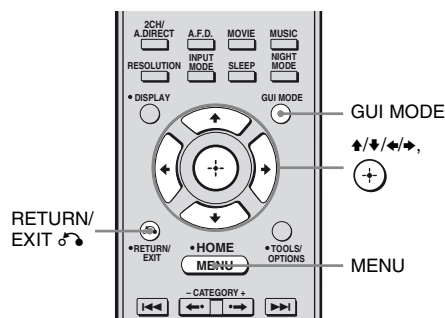

1 Place the S-AIR sub unit that you want to pair near the S-AIR main unit.

2 Match the IDs of the S-AIR main unit and the S-AIR sub unit.

- To set the ID of the S-AIR main unit, see “To set the ID of the S-AIR main unit” (page 100).
- To set the ID of the S-AIR sub unit, refer to the operating instructions supplied with the S-AIR sub unit.

3 Press GUI MODE.

After “MENU ON” appears on the display for a while, “GUI” appears and the GUI menu appears on the TV screen. Press MENU if the GUI menu does not appear on the TV screen.

4 Press \uparrow/\downarrow repeatedly to select “Settings”, then press \oplus or \rightarrow .

The Settings menu list appears on the TV screen.

5 Press \uparrow/\downarrow repeatedly to select “S-AIR”, then press \oplus .

The S-AIR menu appears.

Note

When the S-AIR transmitter (not supplied) is not inserted into the S-AIR main unit, “S-AIR” cannot be selected.

6 Press \uparrow/\downarrow repeatedly to select “Pairing”, then press \oplus .

“Put the S-AIR sub unit near the S-AIR main unit. Turn on power and start pairing.” appears on the TV screen. The S-AIR main unit is ready to start pairing.

7 Press \leftarrow/\rightarrow repeatedly to select “Yes”, then press \oplus .

The S-AIR main unit starts pairing. “Pairing. Do the pairing operation with the S-AIR sub unit.” appears.

8 Start pairing of the S-AIR sub unit.

Refer to the operating instructions of the S-AIR sub unit.

Notes

- Perform pairing within 5 minutes in step 6. If you do not, pairing is recognized as failed, and the screen changes accordingly. In this case, see “If pairing fails” (page 103).
- When sound transmission is established, “Pairing complete. To perform pairing to another S-AIR sub unit, select “Continue”.” appears.

9 Press \leftarrow/\rightarrow repeatedly to select “Finish” or “Continue”, then press \oplus .

- “Finish”: Finishes pairing.
- “Continue”: Continues to perform pairing to another S-AIR sub unit.

Tip

You can confirm the pairing completion or the current ID by checking the “S-AIR Settings” screen. “(PAIRING)” appears beside the current S-AIR ID.

10 Press GUI MODE.

The GUI menu turns off.

Note

After you have performed pairing, if you select the “S-AIR ID” menu, the ID setting (“A”, “B” or “C”) that you last used is displayed.

If pairing fails

“Pairing failed. Retry?” appears.

To perform pairing again, select “Yes”.

To finish pairing, select “No”.

To quit pairing during setting

Press RETURN/EXIT \hookrightarrow .

To cancel pairing

Perform the ID setting of the main unit according to the procedure of “To set the ID of the S-AIR main unit” (page 100). If you reset the ID (even the same ID again), pairing is canceled.

Enjoying the system's sound in another room

(For the S-AIR receiver only (not supplied))

You can enjoy the system's sound in another room by using the S-AIR receiver. The S-AIR receiver can be placed in another room for enjoying the system's sound there.

For details of the S-AIR receiver, refer to the operating instructions supplied with the S-AIR receiver.

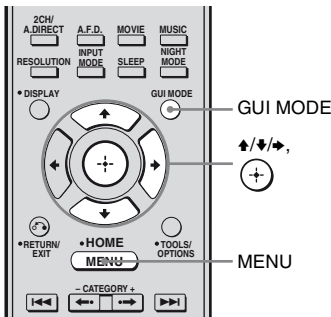

1 Set the ID of the S-AIR receiver to match the ID of the S-AIR main unit.

- To set the ID of the S-AIR main unit, see “To set the ID of the S-AIR main unit” (page 100).
- To set the ID of the S-AIR receiver, refer to the operating instructions supplied with the S-AIR receiver.

Notes

- When you are using another S-AIR sub unit, such as a surround amplifier, do not change the ID of the S-AIR main unit. Set the ID of the S-AIR receiver to match the ID of the S-AIR main unit.
- When you pair the S-AIR main unit and another S-AIR sub unit, such as a surround amplifier, you also need to pair the S-AIR main unit and the S-AIR receiver. For details, see “Pairing the S-AIR main unit with a specific S-AIR sub unit (Pairing operation)” (page 102).

2 Press GUI MODE.

After “MENU ON” appears on the display for a while, “GUI” appears and the GUI menu appears on the TV screen. Press MENU if the GUI menu does not appear on the TV screen.

3 Press ↑/↓ repeatedly to select “Settings”, then press ⊕ or →.

The Settings menu list appears on the TV screen.

4 Press ↑/↓ repeatedly to select “S-AIR”, then press ⊕ or →.

Note

When the S-AIR transmitter (not supplied) is not inserted into the S-AIR main unit, “S-AIR” cannot be selected.

5 Press ↑/↓ repeatedly to select “S-AIR Mode”, then press ⊕.

6 Press ↑/↓ repeatedly to select the setting you want.

- Party: The S-AIR receiver outputs sound according to the input selected on the S-AIR main unit. However, if DVD is selected on S-AIR main unit, S-AIR receiver remains as the last selected input.
- Separate: You can select the input you want for the S-AIR receiver while the input of the S-AIR main unit remain unchanged.

7 Press GUI MODE.

The GUI menu turns off.

8 Select the desired function on the S-AIR receiver.

■ When “Party” is set

The S-AIR receiver’s function changes sequentially as you press INPUT SELECTOR +/- on the receiver or S-AIR CH of the S-AIR receiver.

■ When “Separate” is set

The S-AIR receiver’s function changes by pressing S-AIR CH of the S-AIR receiver.

Note

When TUNER (FM/AM band) is selected on the S-AIR main unit, you can only select the same band for the tuner on the S-AIR receiver. However, you can select input other than TUNER on the S-AIR receiver.

9 Adjust the volume on the S-AIR receiver.

Note

The sound of the S-AIR receiver may be cut off by operation of the S-AIR main unit.

To control the system from the S-AIR receiver

You can control the system from the S-AIR receiver by using the following buttons.

Press	Operation
▶, II, ■, ◀◀/▶▶	Share the same operations on the remote
S-AIR CH	Change the function of the S-AIR main unit

For details, refer to the operating instructions of the S-AIR receiver.

Changing the channel for better sound transmission

If you use multiple wireless systems which sharing the 2.4 GHz band, such as wireless LAN or Bluetooth, the transmission of S-AIR products or other wireless systems may be unstable. In this case, transmission may be improved by changing the “RF Change” setting.

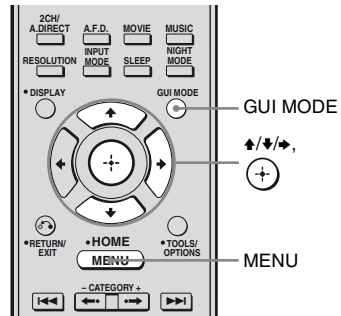

1 Press GUI MODE.

After “MENU ON” appears on the display for a while, “GUI” appears and the GUI menu appears on the TV screen. Press MENU if the GUI menu does not appear on the TV screen.

2 Press ▲/▼ repeatedly to select “Settings”, then press ⊕ or ➔.

The Settings menu list appears on the TV screen.

3 Press ▲/▼ repeatedly to select “S-AIR”, then press ⊕.

The S-AIR menu appears.

Note

When the S-AIR transmitter (not supplied) is not inserted into the S-AIR main unit, “S-AIR” cannot be selected.

4 Press **▲/▼** repeatedly to select “RF Change”, then press **⊕** or **➔**.

5 Press **▲/▼** repeatedly to select the setting you want.

- AUTO: Normally select this. The system changes “RF Change” to “ON” or “OFF” automatically.
- ON: The system transmits sound by searching for a better channel for transmitting.
- OFF: The system transmits sound by fixing the channel for transmitting.

6 Press **GUI MODE**.

The GUI menu turns off.

7 When you set “RF Change” to “OFF”, select the ID so that sound transmission is most stable.

Notes

- When the wireless transmitter is not inserted in the S-AIR main unit, you cannot set “RF Change”.
- In most cases, you will not need to change this setting.
 - If “RF Change” is set to “OFF”, transmission between the S-AIR main unit and S-AIR sub unit can be performed using one of the following channels.
 - S-AIR ID A: equivalent channel for IEEE 802.11b/g channel 1
 - S-AIR ID B: equivalent channel for IEEE 802.11b/g channel 6
 - S-AIR ID C: equivalent channel for IEEE 802.11b/g channel 11
- The transmission may be improved by changing the transmission channel (frequency) of the other wireless system(s). For details, refer to the operating instructions of the other wireless system(s).

Stabilizing S-AIR reception

Read the following when S-AIR reception is poor or unstable.

When S-AIR reception is poor

Check the following.

- Keep cords that are connected to the S-AIR product (AC power cord (mains lead), speaker cords, or other cords) away from the wireless adapter and slot.

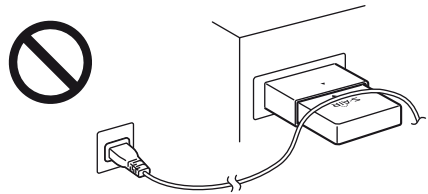
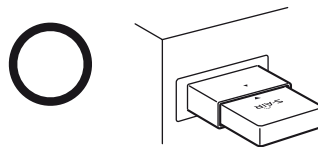

- Keep as much space as possible around S-AIR products.
 - Avoid placing S-AIR products on top of or directly below other electronic equipment.
 - Avoid placing S-AIR products in a closed rack, metal rack or under a table.

- Adjust the location (height, orientation, and place in the room) of S-AIR products until reception is the most stable.

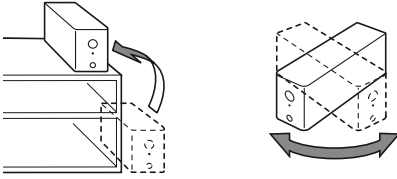

– Place so that the wireless adapters of the S-AIR main unit and sub unit are closer.



– Place so that S-AIR products are separated from other wireless devices.

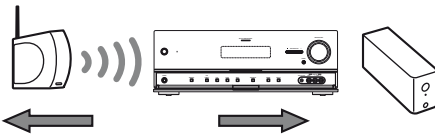

– Place so that S-AIR products are separated from metal doors or tables.

If you still cannot improve S-AIR reception, change the “RF Change” setting (page 105).

Enjoying the S-AIR receiver while the S-AIR main unit is in standby mode

(For the S-AIR receiver only (not supplied))

You can enjoy the S-AIR receiver while the S-AIR main unit is in standby mode by setting “S-AIR Stby” to “ON”.

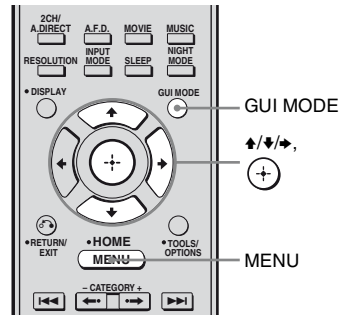

1 Press GUI MODE.

After “MENU ON” appears on the display for a while, “GUI” appears and the GUI menu appears on the TV screen. Press MENU if the GUI menu does not appear on the TV screen.

2 Press \uparrow/\downarrow repeatedly to select “Settings”, then press \oplus or \rightarrow .

The Settings menu list appears on the TV screen.

3 Press \uparrow/\downarrow repeatedly to select “S-AIR”, then press \oplus .

The S-AIR menu appears.

Note

When the S-AIR transmitter (not supplied) is not inserted into the S-AIR main unit, “S-AIR” cannot be selected.

4 Press \uparrow/\downarrow repeatedly to select “S-AIR Stby”, then press \oplus .

continued

5 Press \uparrow/\downarrow repeatedly to select the setting you want.

- ON: You can enjoy the S-AIR receiver while the S-AIR main unit is in standby mode or turned on.
- OFF: You cannot enjoy the S-AIR receiver while the S-AIR main unit is in standby mode.

To exit the menu

Press MENU.

Notes

- When you set “S-AIR Stby” to “ON”, the power consumption increases during the standby mode.
- When the wireless transmitter is not inserted in the S-AIR main unit, you cannot set “S-AIR Stby”.
- When the wireless transmitter is removed from the S-AIR main unit, “S-AIR Stby” is set to “OFF” automatically.
- If you have selected TUNER (FM/AM band) on the S-AIR main unit before you turn it off and “S-AIR Stby” is set to “ON”, you can only select the same band for the tuner on the S-AIR receiver. However, you can select input other than TUNER on the S-AIR receiver.
- The sound of the S-AIR receiver may be cut off by operation of the S-AIR main unit.

Other Operations

Switching between digital and analog audio (INPUT MODE)

When you connect components to both digital and analog audio input jacks on the receiver, you can fix the audio input mode to either of them, or switch from one to the other, depending on the type of material you intend to watch.

1 Press the input button.

You can also use the INPUT SELECTOR \pm on the receiver.

2 Press INPUT MODE repeatedly to select the audio input mode.

The selected audio input mode appears on the display.

Audio input modes

■ AUTO

Gives priority to digital audio signals when there are both digital and analog connections. If there are no digital audio signals, analog audio signals are selected.

■ ANALOG

Specifies the analog audio signals input to the AUDIO IN (L/R) jacks.

Notes

- Some audio input modes may not be set up depending on the input.
- When either HDMI input (HDMI 1/2/3/4), SIRIUS or DMPOR input is selected, “-----” appears on the display, and you cannot select other modes. Select an input mode other than the HDMI input (HDMI 1/2/3/4), SIRIUS and DMPOR input, then set the audio input mode.
- When “Analog Direct” is being used, audio input is automatically set to “ANALOG”. You cannot select other modes.

Enjoying the sound/ images from other inputs

You can reassign video and/or audio signals to another input.

For example, connect the OPTICAL OUT jack of the DVD player to the OPTICAL BD IN jack of this receiver when you want to input the digital optical audio signals from the DVD player.

Connect the component video jack of the DVD player to the COMPONENT VIDEO IN 1 jack of this receiver when you want to input the video signals from the DVD player.

Assign video and/or audio signals to the DVD input jack using “Input Assign” in the Input Option menu.

1 Press GUI MODE.

After “MENU ON” appears on the display for a while, “GUI” appears and the GUI menu appears on the TV screen. Press MENU if the GUI menu does not appear on the TV screen.

2 Press \uparrow/\downarrow repeatedly to select “Input”, then press \oplus or \rightarrow .

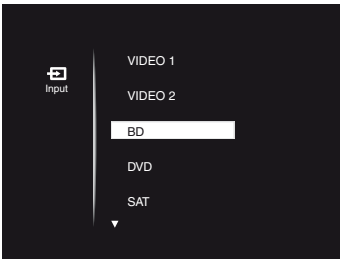

3 Press \uparrow/\downarrow repeatedly to select the input name you want to assign.

4 Press TOOLS/OPTIONS.

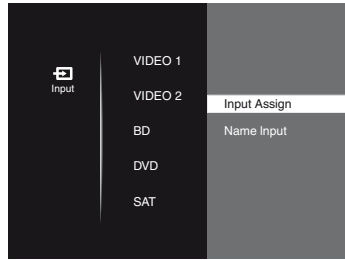

5 Press \uparrow/\downarrow repeatedly to select “Input Assign”, then press \oplus or \rightarrow .

6 Select the audio and/or video signals you want to assign to the input which you selected in step 3 using $\uparrow/\downarrow/\leftarrow/\rightarrow$.

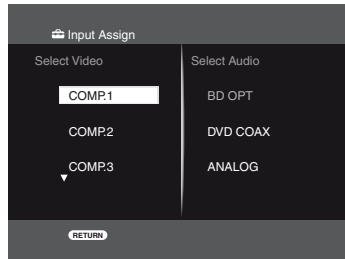

7 Press RETURN/EXIT \rightarrow to enter the setting.

Input name		VIDEO1	VIDEO2	BD	DVD	SAT	SA-CD/ CD/ CD-R	HDMI1	HDMI2	HDMI3	HDMI4
Assignable video input jacks	COMP.1	○	○	○*	○	○	○				
	COMP.2	○	○	○	○*	○	○				
	COMP.3	○	○	○	○	○*	○				
	CVBS	○*	○*	○	–	○	–	–	–	–	–
	HDMI1	○	○	○	○	○	○	○*	–	–	–
	HDMI2	○	○	○	○	○	○	–	○*	–	–
	HDMI3	○	○	○	○	○	○	–	–	○*	–
	HDMI4	○	○	○	○	○	○	–	–	–	○*
	NONE	○	○	○	○	○	○*	–	–	–	–
Assignable audio input jacks	BD OPT	○	○	○*	○	–	○	–	–	–	–
	SAT OPT	○	○	–	○	○*	○	–	–	–	–
	DVD COAX	○	○	○	○*	○	○	–	–	–	–
	ANALOG	○*	○*	○	–	○	○*	–	–	–	–

* Initial setting

Notes

- You cannot assign optical signals from an input source to the optical input jacks on the receiver, and you cannot assign coaxial signals from the input source to the coaxial input jacks on the receiver.
- When you assign the digital audio input, the INPUT MODE setting may change automatically.
- You cannot reassign more than one HDMI input to the same input.
- You cannot reassign more than one digital audio input to the same input.
- You cannot reassign more than one component video input to the same input.

Using the Sleep Timer

You can set the receiver to turn off automatically at a specified time.

Press SLEEP repeatedly while the power is on.

Each time you press the button, the display changes cyclically as follows:

0:30:00 → 1:00:00 → 1:30:00 → 2:00:00
→ OFF

When Sleep Timer is activated, “SLEEP” lights up in the display.

Tip

To check the remaining time before the receiver turns off, press SLEEP. The remaining time appears on the display. If you press SLEEP again, the Sleep Timer will be canceled.

Changing the brightness of the front panel display (DIMMER)

You can change the brightness of the front panel display.

- 1 Press AMP.**
- 2 Press MENU.**
- 3 Press ▲/▼ repeatedly to select “SYSTEM”, then press ⊕ or ➔.**
- 4 Press ▲/▼ repeatedly to select “DIMMER”, then press ⊕ or ➔.**
- 5 Press ▲/▼ repeatedly to select the setting you want, then press ⊕.**

The front panel display will change the brightness according to the setting you have selected.

Tip

You can also press DIMMER repeatedly on the receiver to change the brightness of the front panel display.

Enjoying the surround effect at low volume levels

(NIGHT MODE)

This function allows you to retain a theater like environment at low volume levels. This function can be used with other sound fields. When watching a movie late at night, you will be able to hear the dialog clearly even at a low volume level.



Press NIGHT MODE.

The NIGHT MODE function is activated. The NIGHT MODE is set to on and off as you press NIGHT MODE.

Note

This function does not work in the following cases.

- PCM signals with a sampling frequency of more than 96 kHz are being received.
- Dolby TrueHD signals with a sampling frequency of more than 96 kHz are being received.

Tip

While this function is on, the Bass, Treble, and Effect Levels increase, and “D.Range Comp” is automatically set to “MAX”.

Recording using the receiver

You can record from a video/audio component using the receiver. Refer to the operating instructions supplied with your recording component.

Recording onto a CD-R

You can record onto a CD-R using the receiver. Refer to the operating instructions supplied with your CD recorder.

1 Press one of the input buttons to select the playback component.

You can also use INPUT SELECTOR +/- on the receiver.

2 Prepare the playback component for playing.

For example, tune to the radio station you want to record (page 52).

3 Prepare the recording component.

Insert a blank CD-R into the CD recorder and adjust the recording level.

4 Start recording on the recording component, then start playback on the playback component.

Note

Sound adjustments do not affect the signal output from the SA-CD/CD/CD-R OUT jacks.

Recording onto a recording media

- 1 Press the input button of the playback component.**
You can also use INPUT SELECTOR +/- on the receiver.
- 2 Prepare the playback component for playing.**
For example, insert the video tape you want to copy into the VCR.
- 3 Prepare the recording component.**
Insert a blank video tape, etc. into the recording component (connected to VIDEO 1 OUT jack) for recording.
- 4 Start recording on the recording component, then start playback on the playback component.**

Notes

- Some sources contain copy guards to prevent recording. In this case, you may not be able to record from the source.
- Only analog input signals are output from the analog output jack (for recording).
- HDMI sound cannot be recorded.

Using a bi-amplifier connection

If you are not using surround back speakers, you can connect the front speakers to the SPEAKERS SURROUND BACK/BI-AMP/FRONT B terminals using a bi-amplifier connection.

To connect speakers

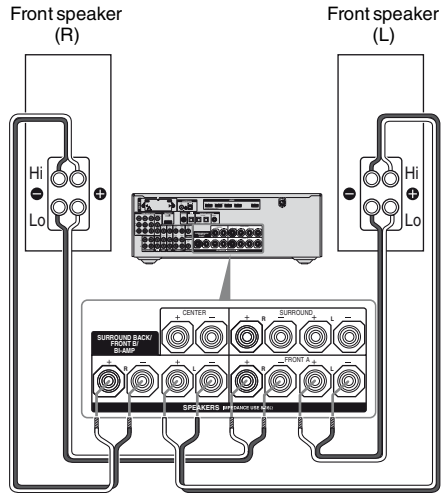

Connect the jacks on the Lo (or Hi) side of the front speakers to the SPEAKERS FRONT A terminals, and connect the jacks on the Hi (or Lo) side of the front speakers to the SPEAKERS SURROUND BACK/FRONT B/BI-AMP terminals.

Make sure that metal fittings of Hi/Lo attached to the speakers have been removed from the speakers. Not doing so may cause a malfunction of the receiver.

To set up speakers

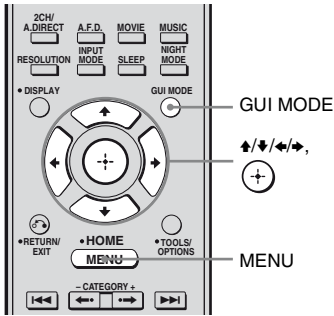

1 Press GUI MODE.

After “MENU ON” appears on the display for a while, “GUI” appears and the GUI menu appears on the TV screen. Press MENU if the GUI menu does not appear on the TV screen.

2 Press \uparrow/\downarrow repeatedly to select “Settings” then press \oplus or \rightarrow .

The Settings menu list appears on the TV screen.

3 Press \uparrow/\downarrow repeatedly to select “Speaker”, then press \oplus or \rightarrow .

4 Press \uparrow/\downarrow repeatedly to select “SP Pattern”, then press \oplus or \rightarrow .

5 Press \uparrow/\downarrow repeatedly to select the appropriate speaker pattern so that there are no surround back speakers, then press \oplus or \rightarrow .

6 Press \uparrow/\downarrow repeatedly to select “SB Assign”, then press \oplus or \rightarrow .

7 Press \uparrow/\downarrow repeatedly to select “BI-AMP”, then press \oplus or \rightarrow .

The same signals output from the SPEAKERS FRONT A terminals can be output from the SPEAKERS SURROUND BACK/FRONT B/BI-AMP terminals.

To exit the menu

Press MENU.

Notes

- Set “SB Assign” to “BI-AMP” before you perform Auto Calibration.
- If you set “SB Assign” to “BI-AMP”, the speaker level and distance settings of the surround back speakers become invalid, and those of the front speakers are used.
- If you set “SP Pattern” to a setting with surround back speakers, you cannot set “SB Assign” to “BI-AMP”.

Operating each component using the remote

You can control Sony or non-Sony components you are using with the remote supplied with the receiver.

The remote is initially set to control Sony components.

When you change the settings of the remote according to the components you are using, you can control non-Sony and other Sony components that the remote is initially unable to control (page 117).

Operating the components connected to the receiver

- 1 Press the input button that matches the connected component that you want to operate.**
- 2 Press the appropriated buttons to use the function listed in the table below.**

Note

You may not be able to operate some functions for the components you are using.

Table of buttons used to control each component

Component	TV	VCR	DVD player, DVD/VHS combo	Blu-ray Disc Player	HDD Recorder	PSX	Video CD player, LD player	Digital CATV terminal	DSS	Tape deck A/B	DAT deck	CD player, MD deck	DIGITAL MEDIA PORT device
Button													
AV I/O	●	●	●	●	●	●	●	●	●		●	●	
Numeric buttons	●	●	●	●	●	●	●	●	●	●	●	●	●
TV INPUT, WIDE	●												
-/., >10, CLEAR	●	●	●	●	●	●	●	●	●	●		●	
ENT/MEM	●	●	●	●	●	●	●*1	●	●	●	●	●	
TOOLS/OPTIONS	●		●	●	●	●		●	●				
DISPLAY	●	●	●	●	●	●	●	●	●			●	
RETURN/EXIT ↵	●		●	●	●	●	●	●	●				●
⏪/⏩/⏴/⏵, ⊕, MENU, HOME	●	●	●	●	●	●		●	●				●
⏮/⏭	●	●	●	●	●	●	●	●		●*2	●	●	●
⏪/⏩	●		●	●	●	●		●					●
⏮/TUNING -, ⏭/TUNING +	●	●	●	●	●	●	●	●		●	●	●	●
DISC SKIP			●	●			●*3					●	
▶, II, ■	●	●	●	●	●	●	●	●		●	●	●	●
MUTING, MASTER VOL +/-, TV VOL +/-	●												
PRESET +/-, TV CH +/-	●	●	●	●	●		●*1	●	●				
BD/DVD TOP MENU, BD/DVD MENU			●	●		●							
F1, F2			●	●									

*1 LD player only.

*2 Deck B only.

*3 Video CD only.

Programming the remote

You can customize the remote to match the components connected to your receiver. You can even program the remote to control non-Sony components and also Sony components that the remote is normally unable to control. The procedure below uses as an example a case in which a VCR made by a company other than Sony is connected to the VIDEO 1 IN jacks on the receiver.

Before you begin, note that:

- You cannot change the settings of TUNER and DMPORT.
- The remote can control only components that accept infrared wireless control signals.

Be sure to turn on the receiver and point the remote towards the receiver when performing the following procedure.

1 Press and hold RM SET UP, then press AV I/⏻.

The RM SET UP indicator slowly flashes.

2 Press the input button (including TV) for the component you want to control.

For example, if you are going to control a VCR connected to VIDEO 1 IN, press VIDEO 1.

The RM SET UP and SHIFT indicator light up.

If you press the button for a component of which you cannot program the remote, such as DMPORT, etc., the RM SET UP indicator keeps flashing.

3 Press numeric buttons to enter the numeric code (or one of the codes if more than one code exists) corresponding to the component and the maker of the component you want to control.

See the tables on page 118–121 for information on the numeric code(s).

Note

For a TV remote code value, only numbers in the 500's are valid.

4 Press ENT/MEM.

Once the numeric code has been verified, the RM SET UP indicator slowly flashes twice and the remote automatically exits the programming mode.

5 Repeat steps 1 to 4 to control other components.

Notes

- The indicator turns off while a valid button is pressed.
- In step 2, if you press TUNER, you can only program the button to control a tuner (page 118).
- In step 2, if you want to change to other input, press SHIFT and then press the new input button you want.
- For the numeric codes, only the last three numbers entered are valid.

To cancel programming

Press RM SET UP during any step. The RM SET UP indicator flashes 5 times in quick succession. The remote automatically exits the programming mode.

To activate the input after programming

Press the programmed button to activate the input you want.

If programming is unsuccessful, check the following:

- If the indicator does not light up in step 1, the batteries are weak. Replace both batteries.
- If the indicator flashes 5 times in quick succession while entering the numeric code, an error has occurred. Start again from step 1.

The numeric codes corresponding to the component and the maker of the component

Use the numeric codes in the tables below to control non-Sony components and also Sony components that the remote is normally unable to control. Since the remote signal that a component accepts differs depending on the model and year of the component, more than one numeric code may be assigned to a component. If you fail to program your remote using one of the codes, try using other codes.

Notes

- The numeric codes are based on the latest information available for each brand. There is a chance, however, that your component will not respond to some or all of the codes.
- All of the input buttons on this remote may not be available when used with your particular component.

To control a tuner

Maker	Code(s)
SONY	002, 005

To control a CD player

Maker	Code(s)
SONY	101, 102, 103
DENON	104, 123
JVC	105, 106, 107
KENWOOD	108, 109, 110
MAGNAVOX	111, 116
MARANTZ	116
ONKYO	112, 113, 114
PANASONIC	115
PHILIPS	116
PIONEER	117
TECHNICS	115, 118, 119
YAMAHA	120, 121, 122

To control a DAT deck

Maker	Code(s)
SONY	203
PIONEER	219

To control a tape deck

Maker	Code(s)
SONY	201, 202
DENON	204, 205
KENWOOD	206, 207, 208, 209
NAKAMICHI	210
PANASONIC	216
PHILIPS	211, 212
PIONEER	213, 214
TECHNICS	215, 216
YAMAHA	217, 218

To control an MD deck

Maker	Code(s)
SONY	301
DENON	302
JVC	303
KENWOOD	304

To control an HDD recorder

Maker	Code(s)
SONY	307, 308, 309

To control a Blu-ray disc player/recorder

Maker	Code(s)
SONY	310, 311, 312

To control a PSX

Maker	Code(s)
SONY	313, 314, 315

To control a DVD player

Maker	Code(s)
SONY	401, 402, 403
BROKSONIC	424
DENON	405
HITACHI	416
JVC	415, 423
MITSUBISHI	419
ORITRON	417
PANASONIC	406, 408, 425
PHILIPS	407
PIONEER	409, 410
RCA	414
SAMSUNG	416, 422
TOSHIBA	404, 421
ZENITH	418, 420

To control a DVD recorder

Maker	Code(s)
SONY	401, 402, 403

To control a DVD/VHS COMBO

Maker	Code(s)
SONY	411

To control a DVD/HDD COMBO

Maker	Code(s)
SONY	401, 402, 403

To control a TV

Maker	Code(s)
SONY	501, 502
AIWA	501, 536, 539
AKAI	503
AOC	503
CENTURION	566
CORONADO	517
CURTIS-MATHES	503, 551, 566, 567
DAYTRON	517, 566
DAEWOO	504, 505, 506, 507, 515, 544
FISHER	508, 545
FUNAI	548
FUJITSU	528
GOLDSTAR/LG	503, 512, 515, 517, 534, 544, 556, 568
GRUNDIG	511, 533, 534
HITACHI	503, 513, 514, 515, 517, 519, 544, 557, 571
ITT/NOKIA	521, 522
J.C.PENNY	503, 510, 566
JVC	516, 552
KMC	517
MAGNAVOX	503, 515, 517, 518, 544, 566
MARANTZ	527
MITSUBISHI/MGA	503, 519, 527, 544, 566, 568
NEC	503, 517, 520, 540, 544, 554, 566
NORDMENDE	530, 558
NOKIA	521, 522, 573, 575
PANASONIC	509, 524, 553, 559, 572

continued

Maker	Code(s)
PHILIPS	515, 518, 557, 570, 571
PHILCO	503, 504, 514, 517, 518
PIONEER	509, 525, 526, 540, 551, 555
PORTLAND	503
QUASAR	509, 535
RADIO SHACK	503, 510, 527, 565, 567
RCA/PROSCAN	503, 510, 523, 529, 544
SAMSUNG	503, 515, 517, 531, 532, 534, 544, 556, 557, 562, 563, 566, 569
SAMPO	566
SABA	530, 537, 547, 549, 558
SANYO	508, 545, 546, 560, 567
SCOTT	503, 566
SEARS	503, 508, 510, 517, 518, 551
SHARP	517, 535, 550, 561, 565
SYLVANIA	503, 518, 566
THOMSON	530, 537, 547, 549
TOSHIBA	535, 539, 540, 541, 551
TELEFUNKEN	530, 537, 538, 547, 549, 558
TEKNIKA	517, 518, 567
WARDS	503, 517, 566
YORK	566
ZENITH	542, 543, 567
GE	503, 509, 510, 544
LOEWE	515, 534, 556

To control an LD player

Maker	Code(s)
SONY	601, 602, 603
PIONEER	606

To control a video CD player

Maker	Code(s)
SONY	605

To control a VCR

Maker	Code(s)
SONY	701, 702, 703, 704, 705, 706
AIWA*	710, 750, 757, 758
AKAI	707, 708, 709, 759
BLAUPUNKT	740
EMERSON	711, 712, 713, 714, 715, 716, 750
FISHER	717, 718, 719, 720
GENERAL ELECTRIC (GE)	721, 722, 730
GOLDSTAR/LG	723, 753
GRUNDIG	724
HITACHI	722, 725, 729, 741
ITT/NOKIA	717
JVC	726, 727, 728, 736
MAGNAVOX	730, 731, 738
MITSUBISHI/MGA	732, 733, 734, 735
NEC	736
PANASONIC	729, 730, 737, 738, 739, 740
PHILIPS	729, 730, 731
PIONEER	729
RCA/PROSCAN	722, 729, 730, 731, 741, 747
SAMSUNG	742, 743, 744, 745
SANYO	717, 720, 746
SHARP	748, 749
TELEFUNKEN	751, 752
TOSHIBA	747, 756
ZENITH	754

* If an AIWA VCR does not work even though you enter the code for AIWA, enter the code for Sony instead.

To control a satellite tuner

Maker	Code(s)
SONY	801, 802, 803, 804, 824, 825, 865
AMSTRAD	845, 846
BskyB	862
GENERAL ELECTRIC (GE)	866
GRUNDIG	859, 860
HUMAX	846, 847
THOMSON	857, 861, 864, 876
PACE	848, 849, 850, 852, 862, 863, 864
PANASONIC	818, 855
PHILIPS	856, 857, 858, 859, 860, 864, 874
NOKIA	851, 853, 854, 864
RCA/PROSCAN	866, 871
BITA/HITACHI	868
HUGHES	867
JVC/EchoStar/Dish Network	873
MITSUBISHI	872
SAMSUNG	875
TOSHIBA	869, 870

To control a cable box

Maker	Code(s)
SONY	821, 822, 823
HAMLIN/REGAL	836, 837, 838, 839, 840
JERROLD/G.I./ MOTOROLA	806, 807, 808, 809, 810, 811, 812, 813, 814, 819
JERROLD	830, 831
OAK	841, 842, 843
PANASONIC	816, 826, 832, 833, 834, 835
PHILIPS	830, 831
PIONEER	828, 829
RCA	805
SCIENTIFIC ATLANTA	815, 816, 817, 844
TOCOM/PHILIPS	830, 831
ZENITH	826, 827

Clearing all the contents of the remote's memory

- 1 While holding down MASTER VOL – , press and hold I/⏻, then press AV I/⏻.**

The RM SET UP indicator flashes 3 times.

- 2 Release all buttons.**

All the contents of the remote's memory (i.e., all the programmed data) are cleared.

Glossary

■ Cinema Studio EX

A surround sound mode that can be regarded as the compilation of Digital Cinema Sound technology, delivers the sound of a dubbing theater using three technologies: “Virtual Multi Dimensions”, “Screen Depth Matching”, and “Cinema Studio Reverberation”.

“Virtual Multi Dimensions”, the virtual speaker technology, creates a virtual multi-surround environment with actual speakers up to 7.1 channel, and brings the surround sound experience of a theater with the latest facilities into your home.

“Screen Depth Matching” reproduces treble attenuation, fullness, and depth of sound usually created in a theater using sound emission from behind the screen. This is then added to the front and center channels.

“Cinema Studio Reverberation” reproduces the sound characteristics of state-of-the-art dubbing theaters and recording studios, including Sony Pictures Entertainment’s dubbing studios. There are three modes, A/B/C, available according to the studio type.

■ Component video

A format for transmitting video signal information consisting of three separate signals: luminance Y, chrominance Pb, and chrominance Pr. High quality pictures, such as DVD video or HDTV pictures, are transmitted more faithfully. The three jacks are color-coded green, blue and red.

■ Composite video

A standard format for transmitting video signal information. The luminance signal Y and chrominance signal C are combined and transmitted together.

■ Crossover frequency

The frequency at which two speaker’s frequencies intersect.

■ Deep Color

Video signals for which the color depth of signals passing through an HDMI jack have been raised.

The number of colors that could be expressed by 1 pixel was 24 bits (16,777,216 colors) with the current HDMI jack. However, the number of colors which can be expressed by 1 pixel will be 36, etc., bits when the receiver corresponds to Deep Color.

Since the gradation of the depth of a color can be expressed more finely with more bits, continuous color changes can be more smoothly expressed.

■ Digital Cinema Sound (DCS)

Unique sound reproduction technology for home theater developed by Sony, in cooperation with Sony Pictures Entertainment, for enjoying the exciting and powerful sound of movie theaters at home. With this “Digital Cinema Sound” developed by integrating a DSP (Digital Signal Processor) and measured data, the ideal sound field intended by filmmakers can be experienced at home.

■ Dolby Digital

Digital audio encoding/decoding technology developed by Dolby Laboratories, Inc. It consists of front (left/right), center, surround (left/right) and subwoofer channels. It is a designated audio standard for DVD video and also known as 5.1 channel surround. Since surround information is recorded and reproduced in stereo, more realistic sound with fuller presence is delivered than with Dolby surround.

■ **Dolby Digital Plus**

Dolby Digital Plus provides the flexibility and efficiency to deliver more channels of compelling surround sound for high-definition video media. Its superior coding efficiencies enable up to 7.1 channel of high-quality multi channel audio without negatively impacting bit budgets allocated for video performance or additional feature sets.

■ **Dolby Digital Surround EX**

Acoustic technology developed by Dolby Laboratories, Inc. Surround back information is matrixed into regular left and right surround channels so that the sound can be reproduced in 6.1 channel. Active scenes, especially, are recreated with a more dynamic and realistic sound field.

■ **Dolby Pro Logic II**

This technology converts 2 channel stereo recorded audio into 5.1 channel for playback. There is a MOVIE mode for movies and MUSIC mode for stereo sources such as music. Old movies encoded in the traditional stereo format can be enhanced with 5.1 channel surround sound.

■ **Dolby Pro Logic IIx**

Technology for 7.1 channel (or 6.1 channel) playback. Along with audio encoded in Dolby Digital Surround EX, 5.1 channel Dolby Digital encoded audio can be reproduced in 7.1 channel (or 6.1 channel). Furthermore, existing stereo recorded content can also be reproduced in 7.1 channel (or 6.1 channel).

■ **Dolby Surround (Dolby Pro Logic)**

Audio processing technology developed by Dolby Laboratories, Inc. Center and mono surround information is matrixed into two stereo channels. When reproduced, audio is decoded and output in 4 channels surround sound. This is the most common audio processing method for DVD video.

■ **Dolby TrueHD**

Dolby TrueHD is Dolby's lossless audio technology developed for high-definition optical discs. Dolby TrueHD audio is bit-for-bit identical to the original studio masters and provides supreme-quality audio up to 8 channels at 96 kHz/24 bit and up to 6 channels at 192 kHz/24 bit. Together with high-definition video, it offers an unprecedented home theater experience.

■ **DTS 96/24**

A high sound quality digital signal format. It records audio at a sampling frequency and bit rate of 96 kHz/24bit which is the highest possible for DVD video. The number of playback channels varies depending on the software.

■ **DTS Digital Surround**

Digital audio encoding/decoding technology for theaters developed by DTS, Inc. It compresses audio less than Dolby Digital, delivering a higher quality sound reproduction.

■ **DTS-ES**

Format for 6.1 channel playback with surround back information. There are two modes, "Discrete 6.1" which records all channels independently, and "Matrix 6.1" which matrixes surround back channel into surround left and surround right channels. It is ideal for playback of motion picture soundtracks.

■ DTS-HD

Audio format which extends the conventional DTS Digital Surround format.

This format consists of a core and an extension, and the core part has DTS Digital Surround compatibility. There are two kinds of DTS-HD, DTS-HD High Resolution Audio and DTS-HD Master Audio. DTS-HD High Resolution Audio has a maximum transmission rate of 6 Mbps, with lossy compression (Lossy), and DTS-HD High Resolution Audio corresponds to a maximum sampling frequency of 96 kHz, and a maximum of 7.1 channel. DTS-HD Master Audio has the maximum transmission rate of 24.5 Mbps, and uses lossless compression (Lossless), and DTS-HD Master Audio corresponds to a maximum sampling frequency of 192 kHz, and a maximum of 7.1 channel.

■ DTS Neo:6

This technology converts 2 channel stereo recorded audio for 6.1 or 7.1 channel playback. There are two modes to select according to the playback source or your preference, CINEMA for movies, and MUSIC for stereo sources such as music.

■ HDMI (High-Definition Multimedia Interface)

HDMI (High-Definition Multimedia Interface) is an interface that supports both video and audio on a single digital connection, allowing you to enjoy high quality digital picture and sound. The HDMI specification supports HDCP (High-bandwidth Digital Contents Protection), a copy protection technology that incorporates coding technology for digital video signals.

■ High Bitrate Audio

It refers to the audio formats of the compression method (DTS-HD Master Audio, Dolby TrueHD, etc.) which is a high bitrate format recorded mainly on Blu-ray disc etc.

■ Interlace

A scanning method which completes a picture by displaying half of the lines on a tube surface of a TV or monitor each 1/60 second. First, all the odd-numbered lines are drawn, leaving spaces between each line, then all the even-numbered lines are drawn to fill the spaces. “i” of “480i” stands for “Interlace.”

■ LFE (Low Frequency Effects)

Sound effects of low frequencies which are output from a subwoofer in Dolby Digital or DTS, etc. By adding a deep bass with a frequency between 20 to 120 Hz, audio becomes more powerful.

■ Neural-THX

Neural Surround™, THX® Technologies has been chosen as the official surround sound broadcast format for XM Satellite Radio’s “XM HD Surround” and other leading FM/HD radio stations in the USA and worldwide. Neural Surround, THX Technologies delivers the rich envelopment and discrete image detail of surround sound in a format 100% compatible with stereo.

■ PCM (Pulse Code Modulation)

A method of converting analog audio to digital audio for easy enjoyment of digital sound.

■ Progressive

A scanning method that draws all scanning lines sequentially, as opposed to interlaced scanning where all the odd and then all the even lines are drawn. “p” of “480p” stands for “Progressive.”

■ S-AIR (Sony Audio Interactive Radio frequency)

Recent times have seen the rapid spread of DVD media, Digital Broadcasting, and other high quality media.

To ensure that the subtle nuances of these high quality media are transmitted with no deterioration, Sony has developed a technology called “S-AIR” for the radio transmission of digital audio signals with no compression, and has incorporated this technology into the EZW-RT10/EZW-T100. This technology transfers digital audio signals with no compression using the 2.4 GHz band range of ISM band (Industrial, Scientific, and Medical band), such as wireless LANs and Bluetooth applications.

■ Sampling frequency

To convert analog audio to digital, analog data should be quantified. This process is called sampling, and the number of times per second the analog data is quantified is called the sampling frequency. A standard music CD stores data quantified at 44,100 times per second, which is expressed as a sampling frequency of 44.1 kHz. Generally speaking, a higher sampling frequency means better sound quality.

■ TSP (Time Stretched Pulse)

A TSP signal is a highly precise measuring signal that utilizes impulse energy, measuring a wide band, from low to high, in a short period.

The amount of energy used to measure signals is important to ensure measurement accuracy in a normal indoor environment. Using TSP signals make it possible to measure signals effectively.

■ x.v.Color

“x.v.Color” enables the more faithful reproduction of various colors such as the brilliant colors of flowers and the turquoise blue of the southern ocean.

Precautions

On safety

Should any solid object or liquid fall into the cabinet, unplug the receiver and have it checked by qualified personnel before operating it any further.

On power sources

- Before operating the receiver, check that the operating voltage is identical with your local power supply.

The operating voltage is indicated on the nameplate on the back of the receiver.

- If you are not going to use the receiver for a long time, be sure to disconnect the receiver from the wall outlet. To disconnect the AC power cord (mains lead), grasp the plug itself; never pull the cord.
- One blade of the plug is wider than the other for the purpose of safety and will fit into the wall outlet only one way. If you are unable to insert the plug fully into the outlet, contact your dealer.
- The AC power cord (mains lead) must be changed only at a qualified service shop.

On heat buildup

Although the receiver heats up during operation, this is not a malfunction. If you continuously use this receiver at a large volume, the cabinet temperature of the top, side and bottom rises considerably. To avoid burning yourself, do not touch the cabinet.

On placement

- Place the receiver in a location with adequate ventilation to prevent heat buildup and prolong the life of the receiver.
- Do not place the receiver near heat sources, or in a place subject to direct sunlight, excessive dust, or mechanical shock.
- Do not place anything on top of the cabinet that might block the ventilation holes and cause malfunctions.
- Do not place the receiver near equipment such as a TV, VCR, or tape deck. (If the receiver is being used in combination with a TV, VCR, or tape deck, and is placed too close to that equipment, noise may result, and picture quality may suffer. This is especially likely when using an indoor antenna (aerial). Therefore, we recommend using an outdoor antenna (aerial).)
- Use caution when placing the receiver on surfaces that have been specially treated (with wax, oil, polish, etc.) as staining or discoloration of the surface may result.

On operation

Before connecting other components, be sure to turn off and unplug the receiver.

On cleaning

Clean the cabinet, panel, and controls with a soft cloth slightly moistened with a mild detergent solution. Do not use any type of abrasive pad, scouring powder, or solvent, such as alcohol or benzine.

If you have any questions or problems concerning your receiver, please consult your nearest Sony dealer.

Troubleshooting

If you experience any of the following difficulties while using the receiver, use this troubleshooting guide to help you remedy the problem. Should any problem persist, consult your nearest Sony dealer.

Audio

There is no sound, no matter which component is selected, or only a very low-level sound is heard.

- Check that the speakers and components are connected securely.
- Check that all speaker cords are connected correctly.
- Check that both the receiver and all components are turned on.
- Check that MASTER VOLUME control is not set to "VOL MIN".
- Check that the SPEAKERS is not set to off (page 38).
- Check that headphones are not connected.
- Press MUTING to cancel the muting function.
- Check that you have selected the correct component with the input buttons (page 47).
- When only a very low-level sound is heard, check to see if NIGHT MODE function is activated (page 112).
- The protective device on the receiver has been activated. Turn off the receiver, eliminate the short-circuit problem, and turn on the power again.

There is no sound from a specific component.

- Check that the component is connected correctly to the audio input jacks for that component.
- Check that the cord(s) used for the connection is (are) fully inserted into the jacks on both the receiver and the component.

There is no sound from one of the front speakers.

- Connect a pair of headphones to the PHONES jack to verify that sound is output from the headphones. If only one channel is output from the headphones, the component may not be connected to the receiver correctly. Check that all the cords are fully inserted into the jacks on both the receiver and the component. If both channels are output from the headphones, the front speaker may not be connected to the receiver correctly. Check the connection of the front speaker which is not outputting any sound.
- Make sure you have connected to both the L and R jacks of an analog component, and not only to either the L or R jack. Use an audio cord (not supplied). However, there will be no sound from the center speaker when a sound field (Pro Logic, etc.) is selected. When the center speaker is not connected, sound is output only from the front left/right speakers.

There is no sound from analog 2 channel sources.

- Check to make sure the selected digital audio input jack is not assigned to other inputs in “Input Assign” in the Input Option menu (page 109).
- Check that the INPUT MODE is not set to “AUTO” (page 108) and the “Input Assign” function is not used to reassign the audio input of another source to the selected input (page 109).

There is no sound from digital sources (from COAXIAL or OPTICAL input jack).

- Check that the INPUT MODE is set to “AUTO” (page 108).
- Check that the “Analog Direct” is not being used.

The left and right sounds are unbalanced or reversed.

- Check that the speakers and components are connected correctly and securely.
- Adjust the balance parameters using the Speaker Settings menu in GUI menu.

There is severe hum or noise.

- Check that the speakers and components are connected securely.
- Check that the connecting cords are away from a transformer or motor, and at least 10 feet (3 meters) away from a TV set or fluorescent light.
- Move your audio components away from the TV.
- The plugs and jacks are dirty. Wipe them with a cloth slightly moistened with alcohol.

There is no sound, or only a very low-level sound is heard from the center/surround/surround back speakers.

- Select a Cinema Studio EX mode (page 67).
- Adjust the speaker level (page 73).
- Make sure the center/surround speaker (s) is (are) set to either “Small” or “Large”.
- Check the “SP Pattern” setting (page 73).

There is no sound from the surround back speakers.

- Some discs have no Dolby Digital Surround EX flag even though the packages have Dolby Digital Surround EX logos.
- Check the “SP Pattern” setting (page 73).

There is no sound from the subwoofer.

- Check that the subwoofer is connected correctly and securely.
- Make sure you have turned on your subwoofer.
- Depending on the selected sound field, no sound output from the subwoofer.
- When all speakers are set to “Large” and “Neo:6 Cinema” or “Neo:6 Music” is selected, there is no sound from the subwoofer.
- Check the “SP Pattern” setting (page 73).

The surround effect cannot be obtained.

- Make sure the sound field function is on (press MOVIE or MUSIC).
- Sound fields do not function for signals with a sampling frequency of more than 48 kHz.

Dolby Digital or DTS multi channel sound is not reproduced.

- Check that the DVD, etc. you are playing is recorded in Dolby Digital or DTS format.
- When connecting the DVD player, etc., to the digital input jacks of this receiver, make sure the setting for the digital audio output of the connected component is available.

Recording cannot be carried out.

- Check that the components are connected correctly.
- Select the source component using the input buttons (page 47).

The MULTI CHANNEL DECODING lamp does not light up in blue.

- Check that the playback component is connected to a digital jack and the input is selected properly on this receiver.
- Check whether the input source of the software being played back corresponds to the multi channel format.
- Check whether the setup on the playback component is set to multi channel sound.
- Check to make sure the selected digital audio input jack is not assigned to other inputs in “Input Assign” in the Input Option menu (page 109).

There is no sound from the component connected to the DIGITAL MEDIA PORT adapter.

- Adjust the volume of this receiver.
 - The DIGITAL MEDIA PORT adapter and/or component is not connected correctly. Turn off the receiver, then reconnect the DIGITAL MEDIA PORT adapter and/or component.
 - Check the DIGITAL MEDIA PORT adapter and/or component device to make sure it supports this receiver.
-

Video

There is no picture or an unclear picture appears on the TV screen.

- Select the appropriate input on the receiver (page 47).
- Set your TV to the appropriate input mode.
- Move your audio components away from the TV.
- Assign the component video input correctly.
- The input signal should be same as the input function when you are up-converting an input signal with this receiver (page 33).
- Depending on the DIGITAL MEDIA PORT adapter, video output may not be possible.

The image of the COMPONENT VIDEO OUT is corrupted.

- Video input signals other than 480p component are not received when signals are output from the VIDEO jack. Input 480i component video signals.
- When component input signals other than 480p are output, use the COMPONENT VIDEO OUT jack and set “Resolution” to “DIRECT”.

Recording cannot be carried out.

- Check that the components are connected correctly.
- Select the source component using the input buttons (page 47).

The GUI menu does not appear on the TV screen.

- Press GUI MODE repeatedly to select “MENU ON”. If the GUI menu still does not appear on the TV screen, press MENU.
 - Check the TV is connected correctly.
-

HDMI

The source sound input from the HDMI jack on the receiver is not output from the speakers connected to the receiver or TV speaker.

- Check the setting of “Audio Out” in the HDMI Settings menu (page 81).
- Check that the component is connected correctly to the HDMI jack for that component.
- You cannot listen to the Super Audio CD by connecting HDMI.
- Depending on the playback component, you may need to set up the component. Refer to the operating instructions supplied with each component.
- Be sure to use a connecting cable for the HDMI jack corresponding to high speed (an HDMI version 1.3a, category 2 cable) when you view images or listen to sound during a Deep Color transmission.

The source image input to the HDMI jack on the receiver is not output from the TV.

- Make sure that cables are correctly and securely connected to components.
- Depending on the playback component, you may need to set up the component. Refer to the operating instructions supplied with each component.
- Be sure to use a connecting cable for the HDMI jack corresponding to high speed (an HDMI version 1.3a, category 2 cable) when you view images or listen to sound during a Deep Color transmission.

The Control for HDMI function does not work.

- Check the HDMI connection (page 26).
- Make sure “Ctrl for HDMI” is set to “ON” in HDMI Settings menu.
- Make sure the connected component is compatible with the Control for HDMI function.
- Check the Control for HDMI settings on the connected component. Refer to the operating instructions of the connected component.
- If you change the HDMI connection, connect/disconnect the AC power cord, or there is a power failure, repeat the procedures of “Preparing for the “BRAVIA” Sync” (page 94).

No sound is output from the receiver and TV speaker while using the System Audio Control function.

- Make sure the TV is compatible with the System Audio Control function.
- If the TV does not have System Audio Control function, set the “Audio Out” settings in HDMI Settings menu to
 - “TV+AMP” if you want to listen to the sound from the TV speaker and receiver.
 - “AMP” if you want to listen to the sound from the receiver.
- If you cannot listen to the sound of a component connected to the receiver while TV input is selected on the receiver
 - Select the appropriate input when you want to watch a program on a component connected via HDMI connection to the receiver.
 - Change the TV channel when you want to watch a TV broadcast.
 - Select the component or input you want to watch when you watch a program on the component connected to the TV. Refer to the operating instructions of the TV on this operation.

The TV’s remote cannot be used to control the connected component when using the Control for HDMI function.

- Depending on the connected component and TV, you may need to set up the component and TV. Refer to the operating instructions supplied with each component and TV.
- Change the input of the receiver to the HDMI input connected to the component.

S-AIR function

S-AIR connection is not established (sound transmission is not established), e.g., the indicator of the S-AIR sub unit turns off, flashes, or turns red.

- If you use another S-AIR main unit, place it more than 26 1/4 feet (8 m) away from this S-AIR main unit.
- Confirm the S-AIR IDs of the S-AIR main unit and S-AIR sub unit are the same (page 100).
- Another S-AIR sub unit is paired to the S-AIR main unit. Pair the desired S-AIR sub unit with the S-AIR main unit (page 102).
- The S-AIR main unit is pairing with another S-AIR sub unit. Cancel pairing.
- Place the S-AIR main unit and S-AIR sub unit separately from other wireless devices.
- Avoid using any other wireless devices.
- The S-AIR sub unit is turned off. Make sure the AC power cord (mains lead) is connected and turn on the S-AIR sub unit.

No sound is heard from the S-AIR receiver.

- Check that the components are connected to analog jack of this receiver.

No sound is heard from the S-AIR product.

- If you use another S-AIR main unit, place it more than 26 1/4 feet (8 m) away from this S-AIR main unit.
- Confirm the ID of the S-AIR main unit and S-AIR sub unit are the same (page 100).
- Confirm the pairing setting (page 102).
- Place the S-AIR main unit and S-AIR sub unit closer to each other.
- If you are using any equipment that generates electromagnetic energy such as a microwave oven near an S-AIR products, turn off the equipment and try using the S-AIR product again after waiting for a short time.
- Place the S-AIR main unit and S-AIR sub unit separately from other wireless devices.
- Avoid using any other wireless devices.
- Change the “RF Change” setting (page 105).
- Change the ID settings of the S-AIR main unit and S-AIR sub unit.
- Turn off the system and S-AIR sub unit, then turn them on again.
- Check that headphones are not connected to the S-AIR sub unit.

There is noise or the sound skips.

- If you use another S-AIR main unit, place it more than 26 1/4 feet (8 m) away from this S-AIR main unit.
 - Sources with copyright protection may not be playable on S-AIR sub unit.
 - Place the S-AIR main unit and S-AIR sub unit closer to each other.
 - If you are using any equipment that generates electromagnetic energy such as a microwave oven near an S-AIR products, turn off the equipment and try using the S-AIR product again after waiting for a short time.
 - Place the S-AIR main unit and S-AIR sub unit separately from other wireless devices.
 - Avoid using any other wireless devices.
 - Change the “RF Change” setting (page 105).
 - Change the ID settings of the S-AIR main unit and S-AIR sub unit.
-

Tuner

The FM reception is poor.

- Use a 75-ohm coaxial cable (not supplied) to connect the receiver to an outdoor FM antennas (aerial) as shown below. If you connect the receiver to an outdoor antenna (aerial), ground it against lightning. To prevent a gas explosion, do not connect the ground (earth) wire to a gas pipe.

Outdoor FM antenna (aerial)

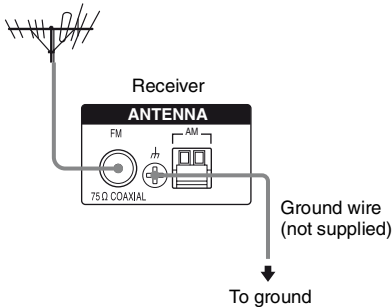

Radio stations cannot be tuned in.

- Check that the antennas (aerials) are connected securely. Adjust the antennas (aerials) and connect an external antenna (aerial), if necessary.
- Keep the satellite radio antenna, away from the speaker cords and the power cord to avoid picking up noise.
- The signal strength of the stations is too weak (when tuning in with automatic tuning). Use direct tuning.
- Make sure you set the tuning interval correctly (when tuning in AM stations with direct tuning).
- No stations have been preset or the preset stations have been cleared (when tuning by scanning preset stations). Preset the stations (page 54).
- Press DISPLAY repeatedly so that the frequency appears on the display.

The receiver cannot receive satellite channels at all.

- The receiving condition is not good. Move the antenna to the place where the condition is good.
- Check that you subscribed to the satellite radio service you want (page 55).

Remote commander

The remote does not function.

- Point the remote at the remote sensor on the receiver.
- Remove any obstacles in the path between the remote and the receiver.
- Replace all the batteries in the remote with new ones, if they are weak.
- Make sure you select the correct input on the remote.
- When you operate a programmed non-Sony component, the remote may not function properly depending on the model and the maker of the component.

Error messages

If there is a malfunction, the display shows a message. You can check the condition of the system by the message. See the following table to solve the problem. If any problem persists, consult your nearest Sony dealer.

PROTECTOR

Irregular current is output to the speakers, or upper panel of the receiver is covered with something. The receiver will automatically turn off after a few seconds. Check the speaker connection and turn on the power again.

For other messages, see “Message list after Auto Calibration measurement” (page 44), “DIGITAL MEDIA PORT message list” (page 52) and “SIRIUS Satellite Radio message list” (page 62).

Reference sections for clearing the receiver's memory

If you are unable to remedy the problem using the troubleshooting guide, clearing the receiver's memory may remedy the problem (page 36). However, note that all memorized settings will be reset to their initial settings and you will have to readjust all settings on the receiver.

If the problem persist, consult your nearest Sony dealer. Note that if service personnel changes some parts during repair, these parts may be retained.

In the event of a problem with S-AIR function, have a Sony dealer check the entire system together (S-AIR main unit and S-AIR sub unit).

To clear	See
All memorized settings	page 36
Customized sound fields	page 70

Specifications

AUDIO POWER SPECIFICATIONS

POWER OUTPUT AND TOTAL HARMONIC DISTORTION: (Models of area code U only)

With 8 ohm loads, both channels driven, from 20 – 20,000 Hz; rated 100 watts per channel minimum RMS power, with no more than 0.09% total harmonic distortion from 250 milliwatts to rated output.

Amplifier section

Models of area code U, CA¹⁾

Minimum RMS Output Power
(8 ohms, 20 Hz – 20 kHz, THD 0.09%)
100 W + 100 W

Stereo Mode Output Power
(8 ohms, 1 kHz, THD 1%)
110 W + 110 W

Surround Mode Output Power²⁾
(8 ohms, 1 kHz, THD 10%)
150 W per channel

¹⁾Measured under the following conditions:

Area code	Power requirements
U, CA	120 V AC, 60 Hz

²⁾Reference power output for front, center, surround and surround back speakers. Depending on the sound field settings and the source, there may be no sound output.

Frequency response

Analog 10 Hz – 70 kHz,
+0.5/-2 dB (with sound field and equalizer bypassed)

Input

Analog Sensitivity: 500 mV/
50 kohms
S/N³: 96 dB
(A, 500 mV⁴)

Digital (Coaxial) Impedance: 75 ohms
S/N: 100 dB
(A, 20 kHz LPF)

Digital (Optical) S/N: 100 dB
(A, 20 kHz LPF)

Output (Analog)

AUDIO OUT Voltage: 500 mV/10 kohms
SUBWOOFER Voltage: 2 V/1 kohm

Equalizer

Gain levels ± 10 dB, 1 dB step

³INPUT SHORT (with sound field and equalizer bypassed).

⁴Weighted network, input level.

FM tuner section

Tuning range 87.5 MHz – 108.0 MHz

Antenna (aerial) FM wire antenna (aerial)
Antenna (aerial) terminals

75 ohms, unbalanced

Intermediate frequency

10.7 MHz

AM tuner section

Tuning range

Models of area code U, CA

With 10-kHz tuning scale:
530 kHz – 1,710 kHz

With 9-kHz tuning scale:
531 kHz – 1,710 kHz

Antenna (aerial) Loop antenna (aerial)

Intermediate frequency

450 kHz

Video section

Inputs/Outputs

Video: 1 V_{p-p}, 75 ohms

COMPONENT VIDEO:

Y: 1 V_{p-p}, 75 ohms

P_B/C_B: 0.7 V_{p-p}, 75 ohms

P_R/C_R: 0.7 V_{p-p}, 75 ohms

80 MHz HD Pass Through

General

Power requirements

Area code	Power requirements
U, CA	120 V AC, 60 Hz

Power output (DIGITAL MEDIA PORT)

DC OUT: 5V, 0.7 A MAX

Power consumption

Area code	Power consumption
U, CA	250 W

Power consumption (during standby mode)

0.9 W (When “Ctrl for HDMI” and “S-AIR Stby” is set to “OFF”)

Dimensions (width/height/depth) (Approx.)

17 × 6 1/4 × 12 7/8 inches
(430 × 157.5 × 324.5 mm)
including projecting parts
and controls

Mass (Approx.)

18 lb 16 oz (8.6 kg)

Supplied accessories

Operating instructions (this manual)

Quick Setup Guide (1)

GUI Menu List (1)

FM wire antenna (aerial) (1)

AM loop antenna (aerial) (1)

RM-AAP040 Remote commander (1)

R6 (size-AA) batteries (2)

Optimizer microphone (ECM-AC2) (1)

For details on the area code of the component you are using, see page 4.

Design and specifications are subject to change without notice.

Halogenated flame retardants are not used in the certain printed wiring boards.

Index

Numerics

- 2-channel 63
- 5.1 channel 17
- 7.1 channel 17

A

- A/V Sync 78, 86
- AM 52, 91
- Antenna Aiming 57, 86, 92
- Audio settings 78, 86
- Auto Calibration settings 72, 84
- Auto Tuning 53

B

- BI-AMP 73
- Bi-amplifier connection 113
- Blu-ray disc player 27, 30, 48
- BRAVIA Sync
preparing 94

C

- Calibration Type 72, 84
- Category Mode 58, 92
- CD player 23, 48
- Changing the display 88
- Cinema Studio EX (mode)
67
- Clear
 - memory 36
 - remote 121
 - sound field 70
- Connection
 - antennas 35
 - audio components 23
 - speakers 19
 - TV 21
 - video components 25
- Control for HDMI 81
- Crossover frequency 75, 85

D

- DCAC (Digital Cinema Auto
Calibration) 40
- DCS 67
- Decode Priority 79, 86
- DIGITAL MEDIA PORT
23, 49
- DIMMER 111
- Direct Tuning 53, 59, 91, 92
- Display 10
- Distance Unit 76, 85
- Dolby Digital EX 69
- DTS Neo 6 (Cinema, Music)
66
- Dual Mono 78, 86
- DVD player 27, 29, 48
- DVD recorder 32
- Dynamic range compression
76, 84

E

- Effect level 77
- EQ settings 78, 86

F

- FM 52, 91
- FM Mode 53, 86

G

- GUI (Graphical User
Interface) 37

H

- HDMI settings 81, 87

I

- Input Assign 109
- INPUT MODE 108
- iPod 50

L

- Level settings 84
- LFE (Low Frequency Effect)
10
- Lock Code 61

M

- Menu 70, 84
- Message
 - Auto Calibration 44
- DIGITAL MEDIA
PORT 52
- Error 133
- SIRIUS 62
- Movie 67
- Music 67
- Muting 48

N

- Name Input 49, 55
- Neural-THX 66
- NIGHT MODE 112

O

- Option menu 46

P

- Parental Lock 60, 86
- Party Mode 104
- Phase Audio 75, 84
- Phase Noise 75, 84
- Position 72, 84
- Preset channels 59, 93
- Preset Mode 58
- Preset stations 54, 91
- PRO LOGIC II 66
- PRO LOGIC IIx 66
- PROTECTOR 133

R

Radio ID 57
Recording 112
Remote 14, 115
Resolution 79, 87

S

S-AIR 97
S-AIR settings 82, 87
Satellite tuner 27, 31, 48
Settings menu 70
SIRIUS Satellite Radio 55,
92
Sleep Timer 111
Sound Field 77, 90
Speaker settings 73, 85
Subwoofer Level 81, 87
Super Audio CD player 23,
48
Surround settings 77, 86
System settings 87

T

Test Tone 75, 84
Tuner 52
Tuner settings 86
Tuning 53, 54
TV 21, 27, 48

U

Up converting 33

V

VCR 32, 48
Video settings 79, 87



* 4 1 3 6 7 3 5 1 1 * (1)

Free Manuals Download Website

<http://myh66.com>

<http://usermanuals.us>

<http://www.somanuals.com>

<http://www.4manuals.cc>

<http://www.manual-lib.com>

<http://www.404manual.com>

<http://www.luxmanual.com>

<http://aubethermostatmanual.com>

Golf course search by state

<http://golfingnear.com>

Email search by domain

<http://emailbydomain.com>

Auto manuals search

<http://auto.somanuals.com>

TV manuals search

<http://tv.somanuals.com>